STRATEGIES FOR IMPROVING THE ENERGY EFFICIENCY OF THE MOSCOW METRO SYSTEM



(Moscow Metro, 2011)

By:

Kevin Kell

Kliment Minchev

Jacob Manning

Date: October 11, 2013



WPI



This Page Left Intentionally Blank

STRATEGIES FOR IMPROVING THE ENERGY EFFICIENCY OF THE MOSCOW METRO SYSTEM

An Interactive Qualifying Project submitted to the faculty of
WORCESTER POLYTECHNIC INSTITUTE
in partial fulfillment of the requirements for the degree of Bachelor of Science

Sponsoring Agency: EY (CIS) B.V., Moscow branch

Submitted by:

Kevin Kell

Kliment Minchev

Jacob Manning

Date: October 11, 2013

With Additional Authorship by Students From the Moscow Finance University under the
Government of the Russian Federation:

Boris Klushin

Dimitry Dubrovin

Daria Pudova

Andrey Popkov

Anastasia Beloipetskaya

Evgenia Meylman

Report submitted to:

Mr. Alexander Annaev, Manager, Clean Technology & Sustainability Services, EY

Mr. Ivan Sokolov, Project Leader, Clean Technology & Sustainability Services, EY

Prof. James Chiarelli, Worcester Polytechnic Institute

Prof. Svetlana Nikitina, Worcester Polytechnic Institute

TABLE OF CONTENTS

Abstract	vi
Statement of Limitations	vii
Acknowledgements	viii
Authorship	ix
List of Figures	x
List of Abbreviations and Acronyms	xii
List of Technical Terms	xiii
Chapter 1: Introduction	1
Chapter 2: Background	3
Introduction	3
Chapter 2.1 Preliminary Case Studies	3
<u>Introduction</u>	3
<u>Weight Reduction</u>	4
<u>Tunnel Wall Wind Turbines</u>	5
<u>Turnstile Energy Generation</u>	7
<u>Optimized Maintenance</u>	8
<u>Platform Screen Doors</u>	9
<u>Start Control Systems</u>	11
<u>LED Lighting</u>	12
<u>Optimization of Acceleration</u>	13
<u>Motor Upgrade</u>	14
<u>Ventilation Overhaul</u>	15
Chapter 2.2: Benchmarking Matrix	16
Chapter 2.3: Final Three Choices	24
Chapter 2.3.1: <u>Ultracapacitors</u>	24
Chapter 2.3.2: <u>Kinetic Energy Harvesting</u>	31
Chapter 2.3.3: <u>Train Automation</u>	41
Chapter 3: Methodology	47
Introduction	47
Chapter 3.1: Case Studies	47
Chapter 3.2: Interviews	48
Chapter 3.3: Benchmarking Matrix	49
Chapter 3.4: Developing Pilot Projects	50
Chapter 3.5: Benchmarking Costs	51
Chapter 3.6: Financial Modeling	51
Chapter 3.7: Energy and Economic Analysis	53
Chapter 4: Findings	54
Chapter 4.1: Ultracapacitors	54

Chapter 4.1.1: Proposed Ultracapacitor Plan	54
Chapter 4.1.2: Analysis of Ultracapacitors	55
Chapter 4.2: Kinetic Energy Harvesting	60
Chapter 4.2.1 Proposed Energy Harvesting Plan	60
Chapter 4.2.2 Analysis of Energy Harvesting	63
Chapter 4.3: Train Automation	75
Chapter 4.3.1: Proposed Plan for Train Automation	75
Chapter 4.3.2: Analysis of Train Automation.....	77
Chapter 5: Conclusions and recommendations	87
Works Cited	90
Appendices	95
Appendix A: Map of the Moscow Metro	95
Appendix B: Moscow Metro Transportation Authority Questionnaire.....	96
Appendix C: Abridged Patents	97
Pavegen Patent	97
Waydip Patent	98
Innowattech Patent	99
Appendix D: Terms of Reference	100

ABSTRACT

The Moscow Metro is moving towards a more sustainable energy future. To achieve its goals, the Metro needs to take advantage of clean technology. The objective of this study is to identify the best available technologies and/or practices to reduce energy consumption and increase energy efficiency in the Metro system, and to provide recommendations on how such technologies should be implemented. An emphasis was made on finding energy efficiency options available beyond the measures currently in place. After extensive research, it was determined that ultracapacitors, train automation, and kinetic energy harvesting are three technologies that can augment the Moscow Metro's energy paradigm. The proposed measures will help the Moscow Department of Transport shape its energy future.

STATEMENT OF LIMITATIONS

Due to the nature of the project, our team encountered several barriers to their research and development of the proposal. Since the project is limited to only 8 weeks in duration, the time constraint put a limit on how much research could be done before moving forward. The small amount of time resulted in incomplete background research. However, enough research was done in order to produce a worthwhile recommendation. Access to information was also limited due to the student status of our team. Originally, the team was going to have several meetings with decision-making officials of the Metro to better understand their needs and ideas. In addition, the meetings would provide our team with sensitive data that could not be obtained through the public domain. For several reasons, the Moscow Metro Authorities were not able to meet with us and our team had to choose the best technologies for them.

In addition to the difficulty obtaining data from the Metro, our team also had difficulty obtaining project reports, technical details, and financial data from various manufacturers due to the confidential nature of their products. We were told several times that because we were students and our project was theoretical, they were not interested in helping us because it was not a legitimate business proposal.

Because of the gaps in data, our team had to make several justified assumptions based on similar projects in other metros to compensate for them. Even with the limited time, data, and options, our team was still able to produce a comprehensive paper and worthwhile proposal. Moreover, the circumstances of this project set up more IQP projects in the future, giving the opportunity for additional development of the project.

ACKNOWLEDGEMENTS

Our Team would like to express gratitude towards the following people, organizations, and institutions for their help and support they gave us throughout the duration of the project.

Worcester Polytechnic Institute:

- IGSD for their administrative oversight of the project and international travel education
- Our advisor Prof. Svetlana Nikitina for her guidance throughout the project,
- Jim Chiarelli for preparing us for a social science project.
- Alevtina Yefimova: for her professional translation services.

EY (Ernst & Young)

- Clean Technology and Sustainability Services, for sponsoring the project, providing the logistics and support, and workspace environment.
- Our Project Manager Ivan Sokolov, for his professional guidance, experience, and expertise in consulting, his assistance in facilitating communication between the Team and the Moscow Metro, and for his diligence and hard work.
- And to Alexander Annaev, Joseph Prakash, and the rest of the Assurance division for their advice and guidance.

The Finance University under the Government of the Russian Federation

- To Alexander Didenko for his leadership and help in developing the financial models
- To the students and faculty of both the Moscow and St. Petersburg campuses for their hospitality, friendship, translation, and guidance, in addition to their financial expertise.

AUTHORSHIP

Students from both Worcester Polytechnic Institute and the Finance University under the Government of the Russian Federation contributed to the research, analysis, and writing of this report. The WPI students were responsible for the majority of the research and writing, while the Financial University assisted in analysis by developing financial models for the implementation of the new energy efficiency technologies in the Moscow City Metro.

The WPI students Kevin Kell, Kliment Minchev, Jacob Manning contributed equally to the research, writing, and editing of the Introduction, Background, and the Methodology.

The Finance University Students Boris Klushin, Andrey Popkov, Dimitry Dubrovin, Anastasia Beloipetskaya, Daria Pudova and Evgenia Meylman formed two person teams to assist the WPI students. They developed financial models and helped their counterparts with analysis of the impact the proposed technologies would have on the Metro system.

LIST OF FIGURES

Figure 1: Train components that can be replaced with lightweight substitutions (innotrans.de)	4
Figure 2: A concept drawing of a T-Box tunnel wind turbine (Nguyen, 2011)	6
Figure 3: Concept Drawing of a Green Pass turnstile (Zhao).....	7
Figure 4: A model of a Platform Screen Door, Platform Edge Door, and Platform Safety Gate (Westinghouse, 2011)	9
Figure 5: A chart of various commercially available light bulbs (The Home Depot, 2013).....	13
Figure 6:.....	25
Figure 8: Advantages and disadvantages of ultracapacitor technologies (Devaux & Tackoen, 2011)	28
Figure 9: sitras ses unit (Siemens, 2012) Figure 10: ultracapacitor bank in sitras Ses unit (Siemens, 2012)	29
Figure 11: A diagram demonstrating kinetic and potential energy (U-Oregon, 2013).....	33
Figure 12: A diagram of a magnet moving in and out of a metal coil producing electric currents (General Electric Company, 2013)	34
Figure 14: Stress Strain Curve (Stress-Strain Curve).....	39
Figure 16: The Four Degrees of Automation (Siemens, 2012)	42
Figure 19: Financial assumptions	52
Figure 20: Parameters used in financial model	57
Figure 22: Self financing payback schedule.....	58
Figure 19: Sensitivity table for linterest rate and basic inflation.....	58
Figure 23: Loan financing payback schedule	59
Figure 24: A possible configuration of Pavegen tiles by ticket gates. (Kemball-Cook, 2013)	62
Figure 26: Present Value for Pavegen Arbatsko-Pokrovskaya Line Model.....	66
Figure 27: General Parameters for Calculations of Pavegen-Entire Metro model.....	67
Figure 28: Present Value for Pavegen-Entire Metro model.	67
Figure 29: Sensitivity analysis of increased cost of electricity vs decreased cost of Pavegen tiles	68
Figure 30: General Parameters for Calculations for Waydip.....	69
Figure 31: Present Value for Waydip- Arbatsko-Pokrovskaya Line model.	69
Figure 32: General Parameters for Calculations for Waydip-Entire Metro model.....	70
Figure 33: Present Value for Waydip- Entire Metro model.....	70
Figure 34: Sensitivity analysis of increased cost of electricity vs decreased cost of Waydip tiles.....	71
Figure 35: General Parameters for Calculation for Innowattech	72
Figure 36: Present Value for Innowattech Arbatsko-Pokrovskaya Line Model – Self-Financed.....	73
Figure 37: Present Value for Innowattech Arbatsko-Pokrovskaya Line Model – Loan-Financed.....	73
Figure 38: Sensitivity analysis of energy inflation vs basic inflation for Innowattech tiles	74
Figure : Table of Measurable Parameters of the Arbatsko-Pokrovskaya Line.....	77
Figure 41: Benchmarked Average Train Automation Budget (in Billions of RUB) for Each Measurable Parameter from Paris Metro System Upgrade.....	78
Figure 42: Table of Copenhagen S-Train Network Key Indicators	79
Figure 43: Benchmarked Average Train Automation Budget (in Billions of RUB) for Each Measurable Parameter from Copenhagen S-Train Rail System Upgrade	79
Figure 45: Benchmarked Average Train Automation Budget (in Billions of RUB) for Each Measurable Parameter from the Lima Line 1 Upgrade.....	80
Figure 47: Benchmarked Average Train Automation Budget (in Billions of RUB) for Each Measurable Parameter from New York Canarsie Line Upgrade	80
Figure 48: Table of Hong Kong East Rail Key Indicators	81

Figure 49: Benchmarked Average Train Automation Budget (in Billions of RUB) for Each Measurable Parameter from the Lima Line 1 Upgrade.....	81
Figure 48: Self financing scenario.....	84
Figure 49: loan scenario	84
Figure 50: npv comparison	85
Figure 51: breakeven point for self financing.....	86
Figure 50: sUMMARY OF OUR rECOMMENDATION TO THE MOSCOW METRO	87

LIST OF ABBREVIATIONS AND ACRONYMS

- EBRD
 - European Bank for Reconstruction and Development
- EY
 - Ernst & Young
- IGSD
 - Interactive Global Studies Division
- IQP
 - Interactive Qualifying Project
- IRR
 - Internal Rate of Return
- kWh
 - Kilowatt-hour
- LED
 - Light Emitting Diode
- mWh
 - Megawatt-hour
- NPV
 - Net Present Value
- PV
 - Present Value
- WPI
 - Worcester Polytechnic Institute

LIST OF TECHNICAL TERMS

- Acceleration optimization
 - The best way to for a train accelerate, coast, and decelerate
- Acceleration Profile
 - The amount of acceleration as time passes
- Bernoulli's Principle
 - Scientific relationship between fluid speed and pressure
- LED
 - A light made from a material that glows when electricity passes through it
- IRR- Initial rate of return
 - Rate of growth a project is expected to generate
- Net Present Value
 - Sum of Present Value
- Non-Traction
 - Parts of the Metro system that do not directly involve the operation of the trains
- Off-Peak
 - Time when fewer people are using the Metro
- Optimize/Optimization
 - To make best use of
- Peak
 - The time when the most people are using the Metro
- Present Value
 - Discounted net cash flows
- Retrofit
 - To upgrade an piece of equipment or add new equipment to an existing line
- Traction
 - Parts of the metro that directly involve the trains and their movement

CHAPTER 1: INTRODUCTION

Sustainable development requires wasting less energy and bringing smarter energy practices to everyday life. In a geographic region rich in natural resources, Russia has a low immediate need to adhere to worldwide energy conservation tendencies. However, considering the increasing social disparity and economic gaps in Russia, Moscow and its large-scale institutions could save substantial amounts of energy by adopting energy efficient practices. The Metro transports about 7 million people per day, which demonstrates the city's reliance on underground public transportation. Such a heavily used metro system consumes enormous quantities of electricity, so the slightest degree of inefficiency results in significant energy and financial losses over time. The constant increase of passengers means the metro system requires major investments in state-of-the-art infrastructure in order to sustain its growth ("O Metropolitene," 2012).

The rapid-transit system was first launched in 1935 and now spans over 313 km (195 mi) of track length. It is operated by the Moscow Metro Authority (Moskovskiy Metropolitene), while Metrowagonmash, a Russian railway manufacturer, builds all metro rolling stock. The metro authorities have set an ambitious goal to improve the quality of their system by replacing all old trains by 2020 and are seeking recommendations on the implementation of innovative technology with an emphasis on energy efficiency ("O Metropolitene," 2012).

In an attempt to lower power consumption and harvest-wasted energy, we uncovered the energy savings potential of the Moscow subway system through recent developments in railway technology. Our joint project team investigated a wide range of energy-efficient equipment to determine and recommend the best ones.

The Moscow branch of the global leader in financial and consulting services, EY (Ernst & Young) and its Climate Change and Sustainability Services Division (CCASS), are actively researching energy efficient technology as part of their Assurance Services line.

Our project is an attempt to help the Moscow Metro Authority improve energy efficiency, quality, reliability, and security of its underground rapid-transportation. Our final recommendation of a technological intervention is based on the cost-benefit analysis of its implementation and energy savings potential.

CHAPTER 2: BACKGROUND

INTRODUCTION

This section contains the preliminary research and investigation into energy efficiency technologies and practices that could be implemented in the Metro. The first subsection covers all of the initial ideas that our team considered but did not select to recommend to the Metro Authorities. It briefly describes the technology and how it has impacted other public transportation systems around the world. The next subsection compares all considered technologies against a set of parameters, satisfying the emphasis on benchmarking requested by the EY and the Metro. Lastly, the final subsection has fully developed case studies about the three best ideas our team felt would best benefit the Metro.

CHAPTER 2.1 PRELIMINARY CASE STUDIES

INTRODUCTION

Our project team investigated twelve different technologies and practices that would reduce power consumption and increase energy efficiency in the Moscow Metro system. From the list, our team needed to determine which ideas would be the best recommendations

The preliminary case studies are retained in the report to serve as a comparative basis for the chosen technologies. They are the evidence for the benchmarking matrix and show the amount of background research that was put into choosing the best available technologies for the Metro. In addition, it still allows the Moscow Metro Transit authorities to choose alternative technologies or practices than the ones the IQP team has proposed.

WEIGHT REDUCTION

The weight of any motor-powered vehicle is essential to its performance, as it is directly related to the motor's energy consumption. Weight reduction is a widely used method to lower electrical power input for traction, while maintaining all functional capabilities. The railway industry invests constant effort into making rolling stock lighter. Rolling stock can be made lighter by using better building materials and switching out old, heavy components for new ones that weigh less. According to the Evaluation of Energy Efficiency Technologies for Rolling Stock and Train Operation of Railways final report, the goal of is to decrease as much as possible the mass per seat ratio. As the purpose of the train is to transport people, railway researchers have established mass per seat as the most relevant measurement of energy efficiency. Thus, the lower the mass per seat is, the less energy it would require to achieve its target velocity ("Evaluation of Energy Efficiency," 2003).

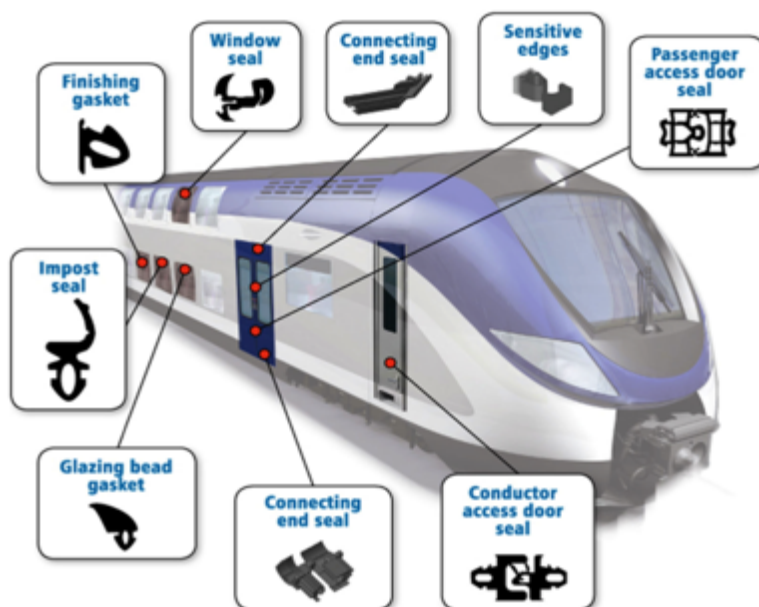

FIGURE 1: TRAIN COMPONENTS THAT CAN BE REPLACED WITH LIGHTWEIGHT SUBSTITUTIONS (INNOTRANS.DE)

Weight savings techniques were adopted in the Copenhagen metro, where aluminum car bodies, single-axle running gears, and sandwich floors contributed to a 34% weight reduction. The mass per seat ratio dropped to 357 kg. In the case of Copenhagen, through weight reduction and other energy efficiency methods, the total energy consumption dropped to about 60% (“Evaluation of Energy Efficiency,” 2003). If such techniques were employed in the Moscow Metro, the energy expenses would be reduced substantially. According to Aluminum Applications in the Rail Industry paper published by JSG Consulting, replacing the stainless steel frames with aluminum ones will reduce the axle weight without compromising the operational strength and safety (Skillingberg and Green, 2007). Currently, the set standard for weight reduction is that 10% less weight results in 6-8% less fuel consumption and carbon dioxide emission (Skillingberg and Green, 2007).

TUNNEL WALL WIND TURBINES

As the underground train speeds along the tunnel, it generates low pressure according to Bernoulli’s Principle. The train’s high speed creates low pressure that pulls air towards the train. This results in air movement, which could generate energy through wind turbines. Each wind turbine would generate a relatively small amount of electricity. Using multiple units placed in strategic locations along the track, the generated electricity could be utilized for local power, be stored in batteries, or used to power lights.

There are two different methods of using wind turbines in the tunnel. The first is to install them along the walls of the tunnel. This is unfavorable because it would require significant construction and alteration of the tunnel walls, which could lead to extended operational shutdown. Another approach, which is much more feasible, is to place turbines in between the tracks. As the rolling stock accelerates through the tunnel, it would create the same type of

whirlpools underneath as it would along the walls. Installing track based wind turbines and their wiring infrastructure could potentially shutdown the line if the project could not be completed when the Metro is closed for the night.

Despite the fact that no rapid-transit system around the world has officially adopted this energy generating technique, the Kalindi College at Delhi University students estimated that such a device, if placed at an appropriate location, could have the capacity of generating up to 0.2 to 0.5 kWh of energy per day (“DU College Harnesses Wind,”2013). With a tunnel network of about 300 km (186 mi), the Moscow metro could effectively generate several kilowatt-hours of whirlwind electricity each day.

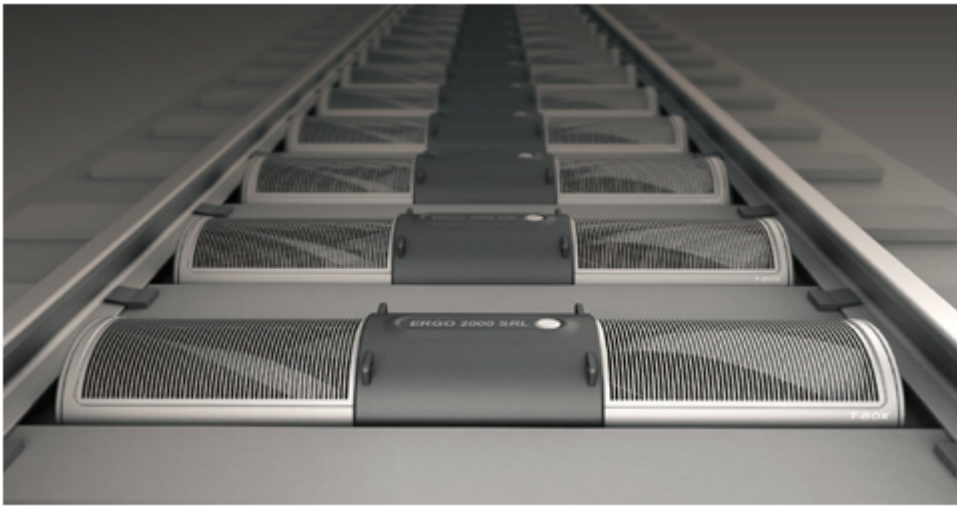

FIGURE 2: A CONCEPT DRAWING OF A T-BOX TUNNEL WIND TURBINE (NGUYEN, 2011)

Concepts of such technology already exist, most prominent of which are the Wind Tunnel and the T-Box. The Wind Tunnel is a wind harnessing technology based on the first approach, a series of turbines are attached to the inside circumference of the tunnel walls (“Wind Tunnel Uses Whooshing,” 2010). The T-Box, on the other hand, is a series of wind turbines installed

between the rails of the train (“T-box Concept to Capture,” 2011). Over time, the contribution to energy savings could potentially increase, as the technology is further developed.

TURNSTILE ENERGY GENERATION

Turnstile energy generation is a low-tech method of generating energy in small increments. It works on the principle of turning mechanical energy into electricity by spinning a dynamo. In the Moscow Metro stations, the energy producing turnstiles would be installed at the ticket gates. When passengers walk through the turnstiles, the single rotation of the gate would generate a small amount of electricity. Over the course of the day, with thousands of people passing through the gates, enough electricity can be generated to power small machines and lights. The electricity produced could be stored in batteries underneath the gate. Currently, there are no metro systems that use turnstile generation; however, there are companies that have proposed the idea and are testing its feasibility.

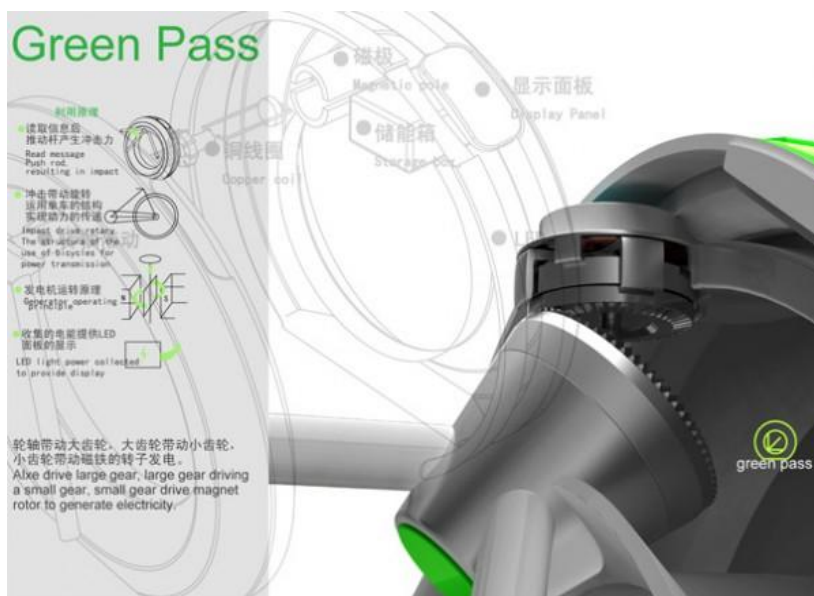

FIGURE 3: CONCEPT DRAWING OF A GREEN PASS TURNSTILE (ZHAO)

One example of a turnstile energy generator is a device called the Green Pass Turnstile developed by the VIVA Design Team at Guangdong University of Technology in China. While

still in a concept stage, the turnstile would power itself by the movement of a passenger going through it. (Selleck, 2010) It works by acting as a dynamo, spinning a magnet through a coil with each revolution. Currently there is no specific information as to the technical capabilities of these turnstiles but they are still a good idea as an alternative means of energy generation.

Turnstile energy generation has several advantages and disadvantages to both the concept and theoretical use in the Metro. While it does produce energy, the amount it can generate is negligible compared to the total energy consumption of the Metro system. In addition the Metro has card swipe method of paying to get to the platform and most likely needs more energy than a single turnstile could produce in one revolution. Lastly, having to push through a physical barrier could lead to several problems from the passengers. It would take longer to go through, creating more of a backlog in passenger flow. Overall the technology is not developed enough to be a worthwhile technology to implement.

OPTIMIZED MAINTENANCE

Keeping the Metro running at peak performance requires constant maintenance of the trains. As parts wear out, the trains have to go in for repairs before they can be put back into service.. Depending on the maintenance schedule, the trains' performance may degrade and become less energy efficient before the next servicing. If the train maintenance can be timed so that there is no drop in performance, then energy can be saved.

Changing a few simple practices can optimize maintenance. By always having an abundance of spare parts, train won't have to sit idly while waiting for the part to come in. Keeping the entire fleet operational allows for a more versatile rotation of trains in service.

Reducing the time a train is in operation by substituting it with other trains will in turn reduce the amount of wear on the parts.

The main goal is to ensure parts are used to the minimum limit of their accepted efficiency, rather than be used while their efficiency suffers greatly until the part breaks. In the Moscow Metro, the maintenance schedule can be analyzed along with the performance of the trains to determine the best times to perform servicing.

While there are many advantages to improving the overall performance of the Metro system, optimizing maintenance would not save a significant amount of energy. In addition, a large-scale study would have to be done to fully understand how each part of the train uses electricity and its reduction in efficiency over time. Such a study would be out of the scope of the project in terms of time needed to complete the study and the skill level needed to properly assess the situation.

PLATFORM SCREEN DOORS

Platform screen doors are large barriers that block off the tunnel from the rest of the station. When the train stops at the station, its doors line up with the doors of the screen to allow access inside. Wall height could be as low as 1.2 meters or as high as the ceiling.

(Westinghouse)



FIGURE 4: A MODEL OF A PLATFORM SCREEN DOOR, PLATFORM EDGE DOOR, AND PLATFORM SAFETY GATE (WESTINGHOUSE, 2011)

There are several variations of platform screens, but the type with the highest energy saving potential is the floor to ceiling platform screen door. They improve energy efficiency by adding greater control of the atmosphere in the station. By providing a barrier between the platform and the tunnel, the platform screen doors would ease the duty load on ventilation systems. In addition to climate control, platform screens provide valuable benefits such as preventing accumulation of litter on the track, unauthorized access to the tunnels, suicide attempts, and terrorism. All of these advantages help to improve the efficiency of automatic train operation (Westinghouse Platform Screen Doors). Considering the decorative nature of many Moscow Metro stations, platform screen doors may not fit in aesthetically. It would be important to ensure the theme of the stations is not disrupted by such measures.

Many Metro systems around the world have some type of platform screen doors installed in the station. Saint Petersburg was one of the first metro systems to have the screen door technology (St. Petersburg Metro). Some stations were constructed specifically for this purpose, as they have solid walls instead of a continuous platform. Installing or retrofitting any platform screen doors would be easy to accomplish and can save energy used on ventilation and climate control.

While platform screen doors improve the safety of the passengers while they wait for the next train to arrive, they do not have as great of an impact of the energy efficiency of the station. Since the stations themselves are not ventilated, the screen doors would not provide any climate control benefits. In many cases, the doors would clash with the artistic quality of the station.

START CONTROL SYSTEMS

Start control systems are a combination of computers and sensors that control when electric utilities are active. Instead of having a utility on and running all the time, a program can be made to turn off or turn down the electricity use.

Adding sensors to lights and escalators can reduce the amount of energy they use. If there are no people at the station, then the lights can be dimmed to save energy. For safety and security reasons, the lights would never be fully turned off. Light dimming will be tested first on a small scale to determine what the lowest light level should be. Computers can determine the peak and off-peak hours of the station and adjust the amount of light produced according to need.

In addition to lighting, start controls could also be used on escalators to reduce their energy consumption. Escalators can have sensors so that they will only operate when passengers are standing on them. They would either detect the pressure of a passenger standing on it, or detect when a passenger walks on using a motion sensor. Operation will stop when a passenger is no longer detected or when they pass through a detector at the other side of the escalator. There are other possible methods that could be used instead of stopping the operation of the escalator completely. Other metro systems reduce the operational speed as a way to prevent accidental stoppages while a passenger is still on it. (Hurst, 2007)

Start controls not only save money by reducing the amount of electricity consumed, but also by extending the life of the system. With light reduction, high efficiency lights will last longer and will have to be replaced less often. In regard to escalators, less operation will lead to less wear and tear. This will prevent operational stoppages due to a broken component.

Other Metro systems like Singapore, New York City, and London, as well as many commercial buildings, use smart control measures on their electric utilities. The Metros have reported that they reduced their energy consumption by about 25 percent. (Searle, 2010)

LED LIGHTING

Incandescent and fluorescent lighting are the two type of lighting that the Moscow Metro uses. Incandescent bulbs work when electricity flows through the thin tungsten filament, heating the metal. The rising and falling of the excited electrons release photons of visible light. This process of producing light is cheap and effective, but because so much energy is lost due to heat, it is highly inefficient (Harris, 2002). Fluorescent lights take advantage of a different process to produce light. Electricity is run passed through the Mercury gas that occupies the bulb to produce ultra-violet light. The ultra-violet light is absorbed and re-emitted as white light by the phosphorous coating on the interior of the bulb. This process is more energy efficient than incandescent bulbs using only 20-30 watts of power (Harris, 2001).

LED lighting can save a significant amount of energy when compared to the aforementioned lighting systems. LEDs, or light emitting diodes are a new type of luminary based on solid-state lighting. Simply put, they produce light when photons are released as electrons move across junctions in a semiconductor. They don't produce as much heat so a significantly smaller amount of energy is wasted. (Harris and Fenlon, 2002)

LED lights would be the best type of energy efficient lighting in the Moscow Metro system. The chart below compares different types of light bulbs LEDs have the most advantages, such as longest life time, low operational cost, excellent color and light quality, and low wattage, with the only down side being the initial cost of the product. As shown, LED lights are three

times brighter, use on average thirty times less watts, and a lifespan that is forty five times longer (The Home Depot, 2013).







						
Features	Incandescent	CFL	HID	LED	Halogen	Fluorescent
Rated Avg. Life	755-1000	10,000	20,000	45,000	3,000	3,000
Life Span	Low	Long	Very Long	Very Long	Medium	Medium
Watts	3 - 500	3 - 120	35 - 1500	2.5 - 16	5 - 500	5 - 500
Cost to Operate	High	Low	Lowest	Low	Medium	Medium
Price to Product	Low	Medium	High	High	Medium	Medium
Lumens per Watt (LPW)	15LPW	60LPW	Up to 120LPW	45LPW	25LPW	25LPW
Color Temperature (in Kelvin)	2700K	2700K - 6500K	1700K - 6500K	2700K - 6500K	3000K	4000K

FIGURE 5: A CHART OF VARIOUS COMMERCIALY AVAILABLE LIGHT BULBS (THE HOME DEPOT, 2013)

Retrofitting most of the existing lights is easily done and only need a small amount of additional hardware. LED lights are programmable and dimmable so additional savings are possible. Many other Metros such as New York City, Singapore, London, and Hong Kong use LEDs or Light Emitting Diodes. Switching to LED lights can save the Metro up to 60% on it energy consumption. (Metropolitan Transportation Authority.)

OPTIMIZATION OF ACCELERATION

Optimization of acceleration is a good way to save energy. With a human driver, the acceleration profile of the train is not optimal. The driver will either accelerate too fast or too slow. This causes the motor to waste energy because it is not working within its optimal range. Additionally, a human driver could accelerate much longer than necessary to get to the next stop, using more energy than was needed.

As an alternative to fully automating a train to eliminate human error, trains can be outfitted with a computer control system that controls how fast the train accelerates. The driver will tell the train when to accelerate, but the computer system deals with figuring out how much power to actually give the motor so that energy is saved. The computer system can also be programmed to fully drive the train so that it can get the perfect balance of acceleration, gliding, and braking between each station.

Optimization can be achieved through strategic slope placement inside of the metro tunnels. A strategically placed downhill slope can help when the motor is under heavy stress due to acceleration. The hill strategy has been employed in London with some success while computerized acceleration optimization is employed in many metro systems around the world

MOTOR UPGRADE

In cases where it is too difficult or expensive to buy entirely new trains for a line, it is possible to retrofit the cars with more energy efficient motors. This can be a more cost effective way to save energy especially when dealing with older trains. In the Moscow Metro, if a line has older trains and is not going to be upgraded for a while, it would make sense to upgrade the motors so that they can have a much longer lifespan and operate at a much higher efficiency.

The Singapore Metro has decided to upgrade some of its older trains that have been running since 1987 to Toshiba Permanent Magnet Synchronous Motors by 2015. They expect the new motors to be 30% more efficient and quieter than their previous models. Many of Moscow's older trains were built around a similar time period (Moscow Metro, 2011)

VENTILATION OVERHAUL

Even though the Metro's ventilation system is predominantly natural, an overhaul of the HVAC system that provides climate control to the electrical equipment would be useful in order to make it more energy efficient. Power supplies, substations and control systems that manage the energy flow of the metro need to be kept cool in the summer and warm in the winter. The constant upkeep of the temperature in these areas requires a large commitment of energy. As the Moscow Metro expands, more ventilation infrastructure is needed to keep pace with the demand. A major renovation of some of the older ventilation equipment would be beneficial to achieve greater results in terms of conservation efforts.

CHAPTER 2.2: BENCHMARKING MATRIX

To effectively determine which technologies to recommend to the Moscow Metro, our team used a benchmarking matrix to compare all of the technologies against each other under predetermined parameters. In order to fill the cells with accurate information, data from case studies produced by other metro systems or leading manufacturers of the technology were used. The information came from various sources such as annual reports, articles, metro websites, press releases, and manufacturers. Our team focused primarily on the cost of the project/technology and the energy savings potential.

After completing the benchmarking matrix, the three technologies that were determined to be the best were train automation, ultracapacitors to augment regenerative braking, and kinetic energy harvesting. They proved to be the most worthwhile techniques with respect to cost of implementation and energy savings potential. The other ten methods our project teams considered were not chosen because they failed to adequately improve energy efficiency or did not meet the criteria to do so effectively.

LED lighting, ventilation overhaul, and start control systems were the three technologies that the Moscow Metro was already taking into consideration. Since it was requested by the Moscow Metro that we to find alternatives for these technologies, they were not be chosen. Although the Moscow Metro is also considering regenerative braking, during our research we discovered ultracapacitors, a new type of technology that would supplement the use of regenerative braking. All of the new models of trains that the Moscow Metro is buying to replace its old fleet will have regenerative braking capability thus ultracapacitors as part of regenerative

braking was deemed acceptable because it was a new twist on regenerative braking that had not yet been considered by the Moscow Metro.

Weight reduction and motor upgrade were also not considered because of the planned replacement of the fleet. The Metro is already buying new trains that have energy efficient motors and are lightweight. There are not many more components that could be replaced with lighter material. The motors in the train are also highly energy efficient so that any change of motor would only result in a negligible change in energy savings. In addition to any energy savings benefits, contractual obligations to the train manufacturers may prevent radical changes to the overall design of the train. Developing a plan based on modification of the train structure and engine is out of the scope of this project in terms of contract negotiation and executive decision-making.

Optimization of acceleration was discounted because it is so similar to train automation. Train automation accomplishes all that optimization of acceleration does and more. It was eliminated as an option to recommend to the Moscow Metro, but its spirit lived on through the train acceleration technology.

Tunnel wall wind turbines and turnstile energy generation were not chosen either because the technology is not mature enough. The majority of these methods of use are still in the conceptual phase or small scale testing. There are not enough case studies where they have been used effectively in any public transportation setting.

Lastly, platform screen doors and optimization of maintenance were rejected primarily because they could not save a significant amount of energy. The only energy management feature of platform screens is that the floor to ceiling length styles improve ventilation by blocking off the station from being exposed to the outside elements by the tunnels.

Unfortunately, the Moscow Metro is naturally ventilated and there is little temperature control for the station. The only unnatural ventilation that the Metro uses is for the electrical equipment that powers the trains. Similarly, optimized maintenance has the ability to solve many problems faced by metro systems such as longer train life and high repair costs, however it has only a small effect on energy consumption. Changing the ventilation of the Moscow Metro would only have a small impact because most of the energy consumed by the Metro is done through train traction.

Parameter	Automated Trains	Regenerative Braking	Piezoelectricity
Project scenario - Project description (Including technology, operating principle)	Easier to Maintain than normal trains, saves energy by optimizing routes and reducing number of trains necessary	Introduce a supercapacitor system to store energy generated from regenerative braking.	As the everyday passenger walks along the metro station walkways, each of his or her steps contributes energy through the piezoelectric crystal effect technology. As a result, the electricity generated is added to the grid.
Baseline scenario - Current scenario in Moscow Metro (existing practice or technology)	New lines may be automated, but older lines only give the driver information on how to drive but are not automated	Some lines use regenerative braking but if the energy that is generated is not used, it is just burned off in the resistor. The Moscow Metro has no known plans to use ultracapacitors	No such technology is in use as of this moment
Energy saving potential (%)	~15%	~11-26% depending on the frequency of trains	(8 J per step-Pavegen 2-3 J per step Waydip) 4.7 kwh one day of heavy traffic (Paris Marathon)
Quantity of energy saved (in MWh) / Cost savings possible (in Million Rubles)	Requires Moscow Metro energy audit data	Requires Moscow Metro energy audit data	Requires Moscow Metro energy audit data
Other benefits - like increase in frequency, comfort, safety, automation etc.,	Trains always on time. Reduced headway Less drivers	Less heat generated by braking resistors, line voltage can be improved	Creates incentive for passenger participation in energy conservation
Investment/ Capex required (in Million Rubles)	6.5 Billion Rubles (not including rolling stock) per line	~68 Million Rubles (for pilot project including staffing of new facilities) ~2.7 Billion Rubles (for outfitting metro system of 669 cars)	~102,000 rubles per tile
Financial viability (Low/ Medium / High)	Financial benefits must be analyzed	Financial benefits must be analyzed	Financial benefits must be analyzed
Maturity of technology (like past experience / case study etc.,)	Paris (renovation of Line 1)	Portland, Cologne, Madrid	London Olympics, Paris Marathon
Barriers - Technological / Infrastructural (like technical and operational issues, additional infra required etc.,)	Control center must be built along with communication infrastructure. Assuming the rolling stock is capable of being automated they must be programmed and outfitted to run automatically.	Rolling stock capable of harvesting energy from the brakes,Ultracapacitors spread out every 1.5 - 2 km by tracks or ultracapacitors installed on the trains	Construction is needed for installation and energy transfer
Barriers - Financial (like low IRR, Higher pay back period, Huge capex required, Funding issue etc.,)	Very High initial cost but imediate savings from less employees and less energy used	High initial cost (from manufacturer), yet an immediate rate of return (through energy savings)	Price for a significant amount of energy generation may be prohibitive
Barriers - Institutional /Policy/regulatory (other departments apart from Moscow metro, No clarity on the EE policy etc.,)	Drivers would not like their jobs being eliminated (Union)	Trains already have some sort of regenerative braking system	Possible safety concerns
Gestation period	1-2 years planning ~4 years construction	3-4 years	1 year
Conclusion (Yes/ Wait / No)	Yes	Yes	Yes

Parameter	Weight Reduction	Tunnel Wall Turbines/Windmills	Ventilation Overhaul
Project scenario - Project description (Including technology, operating principle)	Efforts are made to reduce the weight of the train. For example, the body of the train is made light aluminum which makes it more energy efficient due to using less electric power for motion.	As the train speeds up across the tunnels, the low pressure creates wind that could be utilized in terms of a rotating wind collector.	Upgrade existing ventilation equipment to more energy efficient technology
Baseline scenario - Current scenario in Moscow Metro (existing practice or technology)	Unknown	No such technology is in use as of this moment	Only ventilate line sections, traction substations, stepdown substations, and the trains themselves.
Energy saving potential (%)	"a 10% reduction of vehicle mass = fuel saving of 6-8%" - aluminum.org 10-25% from New York Subway depending on weight eliminated	Unknown	~30% of utility costs
Quantity of energy saved (in MWh) / Cost savings possible (in Million Rubles)	Requires Moscow Metro energy audit data	Requires Moscow Metro energy audit data	Requires Moscow Metro energy audit data
Other benefits - like increase in frequency, comfort, safety, automation etc.,	Weight reducing changes can also improve train safety and maintenance	None	Can make environment of the metro more comfortable
Investment/ Capex required (in Million Rubles)	678 Million Rubles to retrofit ~5000 old cars	Unknown	~701 Million Rubles
Financial viability (Low/ Medium / High)	Financial benefits will not be analyzed	Financial benefits will not be analyzed	Financial benefits will not be analyzed
Maturity of technology (like past experience / case study etc.,)	Copenhagen, New York (only study)	One windmill project tested in Delhi Metro. No report on the project has been found.	New York
Barriers - Technological / Infrastructural (like technical and operational issues, additional infra required etc.,)	Limit to weight that can be eliminated	Physical addition of the windmills, windmill maintenance may be difficult, batteries to store generated electricity until it can be used, way to carry energy to where it will be used.	New infrastructure and equipment will have to be installed. Retrofitting may be available.
Barriers - Financial (like low IRR, Higher pay back period, Huge capex required, Funding issue etc.,)	Weight Reduction of current trains may end up being more expensive than buying newer, lighter trains	High cost since no products are in production	Large initial investment
Barriers - Institutional /Policy/regulatory (other departments apart from Moscow metro, No clarity on the EE policy etc.,)	Contractual obligation to Metrowagonmash	Safety regulations for train tunnel	None
Gestation period	2-3 years	Not in production 3-4 years	2-3 years
Conclusion (Yes/ Wait / No)	No	No	Already Considered

Parameter	Turnstile energy generation	Optimization of acceleration	Permanent-Magnet Synchronous Motor
Project scenario - Project description (Including technology, operating principle)	As metro users pass through turnstiles into and out of the metro stations, the turning motion generates electricity	It is possible to optimize the acceleration of the train over the course of its route so that it does not waste energy	A more efficient electric motor. It is possible to upgrade a train to have this motor without buying an entirely new train.
Baseline scenario - Current scenario in Moscow Metro (existing practice or technology)	There are open barriers at the metro stations, which close if the passenger has not scanned his or her ticket. No turnstiles present.	Only used on newer train lines	Unknown
Energy saving potential (%)	Low- Less than 10 watts per revolution	10%	30%
Quantity of energy saved (in MWh) / Cost savings possible (in Million Rubles)	Requires Moscow Metro energy audit data	Requires Moscow Metro energy audit data	Requires Moscow Metro energy audit data
Other benefits - like increase in frequency, comfort, safety, automation etc.,	None	Faster service	Not necessary to buy new trains
Investment/ Capex required (in Million Rubles)	Unknown	Medium	2.6 Billion ruble for 66 cars
Financial viability (Low/ Medium / High)	Financial benefits will not be analyzed	Financial benefits will not be analyzed	Financial benefits will not be analyzed
Maturity of technology (like past experience / case study etc.,)	Non Metro Application	Dubai	Singapore, Japan
Barriers - Technological / Infrastructural (like technical and operational issues, additional infra required etc.,)	Still in the conceptual stage	Additional computers, software, control measures, and signalling installation	Train servicing and conversion
Barriers - Financial (like low IRR, Higher pay back period, Huge capex required, Funding issue etc.,)	No available price Low IRR	Low IRR	The Metro is already buying new trains
Barriers - Institutional /Policy/regulatory (other departments apart from Moscow metro, No clarity on the EE policy etc.,)	Impedes passenger traffic	None	Contract obligations to manufacturer
Gestation period	2-3 years	2-3 years	2-3 years
Conclusion (Yes/ Wait / No)	No	No	No

Parameter	Platform Screen Doors	Start Control Systems	Optimized Maintenance
Project scenario - Project description (Including technology, operating principle)	Walls block the train tunnel off from the rest of the station. The doors of the wall line up with the doors of the trains. The screen prevents passengers from accessing the track and improves the climate of the station.	Control measures that reduced electricity consumption by only using energy when needed. Lights will be dimmed or turned off when not in use. Escalators will only run if passengers are standing on them.	If trains are kept in perfect condition, then they will run more efficiently. The schedule of maintenance may affect how well the trains work.
Baseline scenario - Current scenario in Moscow Metro (existing practice or technology)	None in the Moscow metro, though technology is widespread in the St. Petersburg metro.	Escalators are sometimes shut off	Maintenance performed by Manufacturer
Energy saving potential (%)	Facilitates train automation. Has negligible inherent energy savings	Up to 40%	Depends on current maintenance schedule
Quantity of energy saved (in MWh) / Cost savings possible (in Million Rubles)	Requires Moscow Metro energy audit data	Requires Moscow Metro energy audit data	Requires Moscow Metro energy audit data
Other benefits - like increase in frequency, comfort, safety, automation etc.,	Increased passenger safety	Decreased operational downtime EcoMod Retrofit	More reliable service
Investment/ Capex required (in Million Rubles)	Cost effective if it costs less than 2.6 Million Ruble per station	Dependant on size of escalator.	One time investment in third party consulting service. Small increase in cost due to better maintenance practices
Financial viability (Low/ Medium / High)	Financial benefits will not be analyzed	Financial benefits will not be analyzed	Financial benefits will not be analyzed
Maturity of technology (like past experience / case study etc.,)	Seoul, London, Singapore, St. Petersburg	Common in commercial and industrial sites	Common in commercial and industrial sites
Barriers - Technological / Infrastructural (like technical and operational issues, additional infra required etc.,)	Service for a station will be temporarily shut down	Switches, dimmers, conversion kits, sensors, smart metering must be installed	Possibly more frequent maintenance of trains
Barriers - Financial (like low IRR, Higher pay back period, Huge capex required, Funding issue etc.,)	Low IRR	Large Investment	More costs. Savings are monetary, has very little energy savings.
Barriers - Institutional /Policy/regulatory (other departments apart from Moscow metro, No clarity on the EE policy etc.,)	Changes aesthetics of the station	Contract Negotiation	Pre-existent maintenance procedure
Gestation period	1-2 years	1-2 years	1-2 years with training
Conclusion (Yes/ Wait / No)	No	Already Considered	No

Parameter	LED Lighting
Project scenario - Project description (Including technology, operating principle)	Highly energy efficient method of solid state lighting
Baseline scenario - Current scenario in Moscow Metro (existing practice or technology)	Basically all Fluorescent lights
Energy saving potential (%)	Up to 60%
Quantity of energy saved (in MWh) / Cost savings possible (in Million Rubles)	Requires Moscow Metro energy audit data
Other benefits - like increase in frequency, comfort, safety, automation etc.,	Ability to be controlled for greater energy savings Better light quality
Investment/ Capex required (in Million Rubles)	480 Million Ruble for 250,000 Lights
Financial viability (Low/ Medium / High)	Financial benefits will not be analyzed
Maturity of technology (like past experience / case study etc.,)	Singapore, Hong Kong, New York, Paris
Barriers - Technological / Infrastructural (like technical and operational issues, additional infra required etc.,)	Thousands of light bulbs need to be replaced, some fixtures need retrofitting
Barriers - Financial (like low IRR, Higher pay back period, Huge capex required, Funding issue etc.,)	Funding
Barriers - Institutional /Policy/regulatory (other departments apart from Moscow metro, No clarity on the EE policy etc.,)	Contract Negotiation
Gestation period	4 Years
Conclusion (Yes/ Wait / No)	Already Considered

(Systra, 2013) (Siemens, 2012) (Briginshaw, 2013) (Westinghouse, 2011) (Reliability Works, 2013)

CHAPTER 2.3: FINAL THREE CHOICES

CHAPTER 2.3.1: ULTRACAPACITORS

In modern metro systems, many electric trains use regenerative braking to recuperate some of the energy lost during braking. In metro systems that use direct current to power the trains, regenerative braking can be implemented by simply running the train's motor in reverse, thus allowing it to act as a dynamo. The motor converts the train's latent kinetic energy into usable electric energy. This operation both slows the train down and generates electricity that can be fed back into the power supply to be used by other trains.



FIGURE 6: A SINGLE ULTRACAPACITOR
(MAXWELL, 2011)

Regenerative braking is helpful in reclaiming energy, but this reclaimed energy cannot always be used. If there are no accelerating trains nearby (consuming energy), then the regenerated energy must be dissipated in resistors in order to

maintain a steady voltage in the power supply (Barrero & Van Mierlo, 2008). In a study conducted by the Portland TriMet metro system, it was found that only 70% of the energy produced through regenerative braking was actually being used; the other 30% was being dissipated in braking resistors (US Department of Transportation, 2012).

Recovering the wasted 30% is where ultracapacitors become useful. When regenerated energy is produced in an excessive amount, ultracapacitors can store the surplus instead of dissipating the energy in resistors. The energy stored in the ultracapacitors can be used for two purposes. The first method is to directly power the acceleration of a nearby train. Alternatively, the energy can be used to stabilize the voltage of the overall power supply when it dips or rises

(Siemens, 2011). This stabilization can greatly reduce the number of voltage related service reductions (Siemens , 2004).

There is a physical difference in the construction of ultracapacitors compared to conventional capacitors. Conventional capacitors are simply two metal plates held parallel to one another allowing energy to be stored in an electric field between them. Ultracapacitors have taken the same principle employed by conventional capacitors, and optimized the construction for superior performance. A material called activated carbon is surrounded by electrolytes to form a “dual-layer” capacitor, which is capable of storing more energy than a conventional capacitor (Garthwaite, 2011).

Ultracapacitors are similar to batteries because they can both store energy for later use.

The chart below shows the advantages and disadvantages of each.

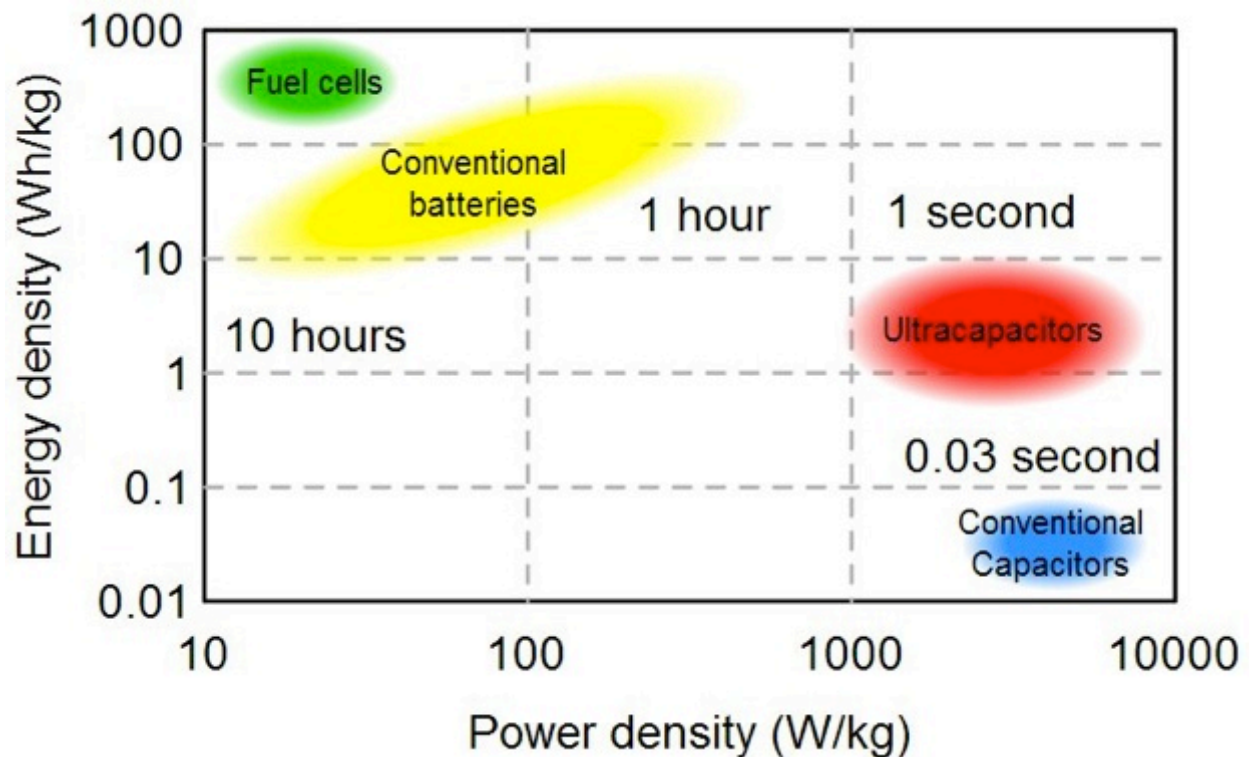

FIGURE 7: ENERGY DENSITY VS. POWER DENSITY FOR FUEL CELLS, BATTERIES, ULTRACAPACITORS, AND CONVENTIONAL CAPACITORS (GARTHWAITE, 2011)

Figure 8 displays four energy-storing technologies: energy cells, batteries, ultracapacitors, and conventional capacitors. It illustrates the different technologies' relative energy and power density. Energy density is how much energy a device is capable of holding while power density shows how fast the device can discharge. The high power density of ultracapacitors is ideal for the sudden bursts of consumption and generation that occurs in a metro system (Barrero & Van Mierlo, 2008). An ultracapacitor can fully charge and discharge in a matter of seconds, while batteries take several minutes or hours for the same process. (Garthwaite, 2011). The primary drawback of capacitors is their low energy density. Fortunately, advances in ultracapacitor

technology have resulted in the development of devices with a much more practical size and storage capacity.

Alone, each ultracapacitor is between 2 and 3 volts and hundreds or thousands of Farads. In practice, many individual ultracapacitors must be wired in parallel until they reach a reasonable voltage to be used in the metro's power supply. Most metro systems have a voltage between 600 and 750 volts, so hundreds of individual ultracapacitors are used for one unit (Schneuwly). Additionally, there must be a control system that makes sure that each capacitor in the array is charged evenly. The system will not function if any one capacitor gets out of sync with the others (Schneuwly).

There are two categories of capacitor energy storage systems, those installed on the trains themselves and those installed by the trackside. The advantages and disadvantages of each, according to a report by Ticket to Kyoto are shown in the table below.

Solution type	Advantages	Disadvantages	Products
On train system	<ul style="list-style-type: none"> -Can allow train to drive for over a kilometer without a power supply -No transmission loss of recovered braking energy 	<ul style="list-style-type: none"> -Requires retrofitting of old trains -Maintenance requires train to be out of commission 	<ul style="list-style-type: none"> -Bombardier MITRAC -Siemens SITRAS MES & HES -Alstom STEEM -CAF ACR - American Maglev Technology ESS
Wayside system	<ul style="list-style-type: none"> -Can service multiple trains at the same time -Maintenance can be done without interrupting service 	<ul style="list-style-type: none"> -Must do research to find best spots to install -Will not allow trains to travel without power supply 	<ul style="list-style-type: none"> -Bombardier EnerGstor -Siemens SITRAS SES -Adetel NeoGreen Power

FIGURE 8: ADVANTAGES AND DISADVANTAGES OF ULTRACAPACITOR TECHNOLOGIES (DEVAUX & TACKOEN, 2011)

The products mentioned above are in various stages of development, but they have all been tested in pilot projects. Almost all of them have both energy saving and voltage stabilizing modes.

The Sitras SES system made by Siemens is one of the most proven wayside capacitor energy storage systems on the market today. It has been installed with success in several metro systems. The SES systems were installed in Cologne in 2001, Madrid in 2002, Beijing in 2007

and Portland beginning in 2013 (Siemens, 2011). Installation is relatively simple and does not require any trains to be retrofitted. Sitras SES is “ready-to-connect” in new or existing electrical substations (Siemens, 2012). In addition to streamlined installation, Sitras SES has the capability for significant energy savings. According to Siemens, Sitras SES can save up to 500,000 kWh per year. The combination of its ease of installation and energy saving potential make Sitras SES a very attractive option for any metro system looking to reduce energy consumption.



FIGURE 9: SITRAS SES UNIT (SIEMENS, 2012)

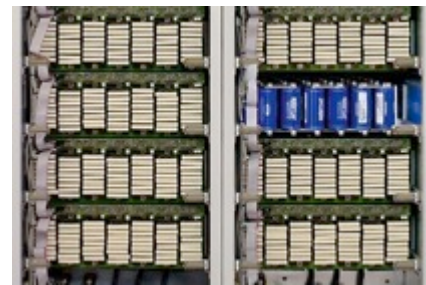

FIGURE 10: ULTRACAPACITOR BANK IN SITRAS SES UNIT (SIEMENS, 2012)

The prototype installation in Cologne was implemented on the Bensberg line between 2001 and 2003 and recorded some impressive results. Measurements from the trial show that the system is capable of saving 35 kWh of energy per hour. Based on these results, Cologne decided to purchase four more Sitras SES units that are still running today (Siemens, 2011). The pilot project in Madrid had similarly positive results and was focused on stabilizing voltage. Before the installation in Madrid, the voltage of the power supply would sometimes drop as low as 470V, which would cause service issues. After the installation, the voltage never dropped below 490V (Siemens, 2004).

An alternative product is Bombardier’s MITRAC Energy Saver. The MITRAC Energy Saver is installed on the trains themselves. In 2003, a prototype was installed on a light rail

vehicle in Mannheim, Germany. In a Bombardier report, authors claim that the positive results prompted “the German operator Rhein-Neckar-Verkehr GmbH (RNV),” to order “49 MITRAC Energy Savers for nineteen light rail vehicles.” (Bombardier, 2009). According to the product fact sheet, an MITRAC Energy Saver is capable of saving up to 30% of a metro or light rail system’s energy use (Bombardier, 2009)

These pilot projects are just a few examples of successful use of ultracapacitor energy storage systems. They demonstrate that ultracapacitors are a well-established technology that has the potential to save significant amounts of energy. This technology is appealing to the Moscow Metro system because it is used independently of the train running on the tracks (Devaux & Tackoen, 2011). The versatility of wayside application gives the Metro several options on how they want to use the technology. Even the onboard capacitor systems have a degree of flexibility. They can be installed on any train given it is capable of regenerative braking. Since the Moscow Metro will fully replace its entire rolling stock fleet by 2020, it will be advantageous to equip this technology to maximize the energy saving potential regardless of the train model running on the track (Moscow Metro, 2011).

CHAPTER 2.3.2: KINETIC ENERGY HARVESTING

INTRODUCTION

Every day, hundreds of thousands of people in Moscow use public transportation, traveling underground in the city's extensive metro system. As the passengers move about the station and disembark the trains, they exert substantial kinetic forces on the environment around them. With a minimal headway of only 90 seconds during peak hours, (Key Performance Indicators, 2013) trains are constantly entering and leaving the station. Similarly to the people walking around in the station, much of the train's immense amount of kinetic energy is wasted as it comes to a stop in the station. The metro is in a constant flux of motion as the people of Moscow travel around the city.

Clean technology and green energy entrepreneurs have been working diligently to try to recover the lost energy of all of this motion. They are trying to figure out how to turn the force that a human body exerts as it impacts the ground into useable energy. Trains have a similar problem of trying to harness the energy that the ground would normally absorb. However, trains face more of a challenge because of the worries that energy harvesting would be counterproductive to saving electrical energy overall. There has to be some way to efficiently recover kinetic energy and turn it into usable electricity.

The solution comes from energy harvesting by converting kinetic energy into new forms of energy. This can be accomplished through several different conversion paths. The most common way to generate electricity is to convert kinetic energy to mechanical energy, and then mechanical energy to electrical energy. This is how major power plants produce the electricity that is used in everyday practices. The other method, which is a much newer and less developed

process, is turning kinetic energy into electrical energy by taking advantage of the piezoelectric effect.

Both of these methods are the basis for new and emerging technologies that have started to come out of the conceptual stage and are beginning field-testing. These new technologies present fantastic opportunities for the Moscow Metro to not only take advantage of the combined energy of its hundreds of thousands of daily passengers, but also to become the first metro to use this new technology. With its successful implementation, the Moscow Metro has the opportunity to become one of the most technologically advanced, innovative, and energy efficient mass transit systems.

HOW KINETIC ENERGY RECOVERY CAN GENERATE ELECTRICITY

MECHANICAL ENERGY

Mechanical energy is the sum of kinetic energy, the energy of motion, and potential energy, the energy inherently stored in a system based on its position in free space (Mechanical Energy). In the case of the Moscow Metro, it is the energy generated by passengers as they walk that is imparted on the ground by their feet. When a person lifts his or her leg up to take the next step, the weight of their body becomes a potential energy reservoir due to gravitational pull of the earth. Then as the momentum or the human gait make the leg swings outward, the body is in motion and produces kinetic energy. As the person completes the step, energy of the step is then transferred into the ground as liner mechanical stress. The energy is absorbed and the process repeats itself. Instead of letting this energy just dissipate into the ground; it is possible to recover some of the energy.

Kinetic energy versus Potential energy

kinetic energy = energy of motion/momentum

potential energy = stored energy/energy from gravity

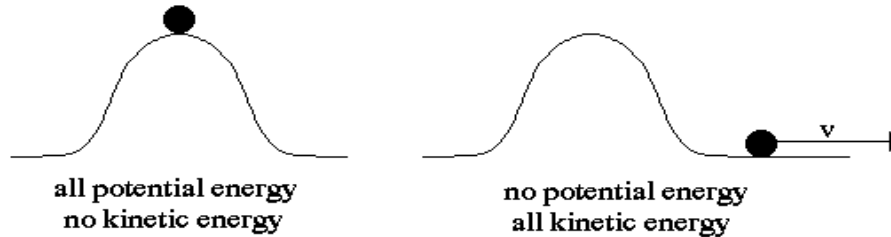

FIGURE 11: A DIAGRAM DEMONSTRATING KINETIC AND POTENTIAL ENERGY (U-OREGON, 2013)

Since mechanical energy increases with increased speed and greater potential energy, the metro trains can produce an enormous amount of energy. The train itself has a tare weight of 46 tons and operates at a speed of 90 km/hr. Fully loaded, it can handle up to 30 more tons. (Metrowagonmash, 2011) At maximum speed and capacity, a metro train could impart upwards 450 kiloNewtons on the track, just while stationary. These new trains have the potential to generate enough energy to offset the amount of energy consumed by the Moscow Metro.

ELECTROMAGNETIC INDUCTION

Electromagnetic induction, as the name suggests, is a relationship between magnetism and electricity. It works on the basis of three principles that link the two phenomena together.

The three principles are:

1. Every electric current has a magnetic field surrounding it.
2. Alternating currents have fluctuating magnetic fields.
3. Fluctuating magnetic fields cause currents to flow in conductors placed within them, which is also known as Faraday's Law.

(Gerbis, 2009)

Electromagnetic induction occurs when a circuit with an alternating current flowing through it generates current in another circuit simply by being placed nearby. The “push” and “pull” of the magnetic field pushes and pull electrons through a conductor, which in this case is a wire coil.

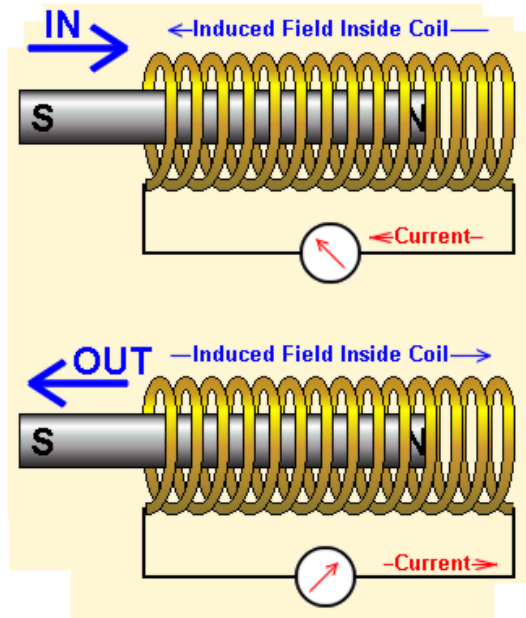

FIGURE 12: A DIAGRAM OF A MAGNET MOVING IN AND OUT OF A METAL COIL PRODUCING ELECTRIC CURRENTS (GENERAL ELECTRIC COMPANY, 2013)

This process is the way all conventional power plants generate electricity. Using some sort of fuel source, water is boiled and turned into steam. The steam is then forced over the blades of a turbine and spun at over 3000 revolutions per minute. “The spinning turbine is connected to a metal rod/shaft in a generator that turns a large magnet surrounded by coils of copper wire. The spinning magnet creates a powerful magnetic field around the coils. The magnetic field lines up the electrons in the copper coils and causes them to move. The movement of these electrons through a wire is electricity.” (General Electric, 2013)

PIEZOELECTRICITY

Piezoelectricity is a new form of energy harvesting technology. It produces energy through converting mechanical energy to electricity through the piezoelectric effect.

“Piezoelectricity refers to the ability of a material to produce a charge separation along its surface upon application of mechanical strain. A type of dipole is created in the material and this results in a potential difference across its ends. The piezoelectric effect is the linear electromechanical interaction between the mechanical and the electrical state in crystalline materials with no inversion symmetry” (Danesh, 2012)

HYBRIDIZATION

Because electromagnetic induction and piezoelectricity both require linear stress to generate electricity, a hybrid of the two can be used to take advantage of the properties of both technologies. When force is applied, the surface can elastically deform as well as uniformly compress. The deformation of the surface creates the piezoelectric effect in the crystal and physical downward movement of the system pushes the magnet through a coil. Combining both of these physical effects can maximize the energy potential of a kinetic energy harvesting system.

VENDORS

There are several different companies in the world that produce kinetic energy harvesting flooring. They are all in varying stages ranging from end stage concept to small-scale production. Currently, there are several companies that have products available for commercial application.

PAVEGEN

Pavegen is a London-based company started in 2009 by Laurence Kemball-Cook. He produces tiles that incorporate both piezoelectricity and magnetic induction to produce energy.

They are designed to capture the kinetic energy of human footfall and convert it into a small amount of electricity. (Kemball-Cook, 2013)

INNOWATTECH

Innowattech is a privately owned technology company that specializes in the development of custom piezoelectric generators. They have research facilities at Technion - Israel Institute of Technology in Haifa Israel. They have done work with Israeli National Railways and Israeli National Roads Company using piezoelectric tiles to harvest energy from transportation. The President and co-Founder of the company is Prof. Haim Abramovich, an Associate professor of Aerospace engineering at Technion. (Innowattech-About, 2013)

WAYDIP

Waydip is a company similar to Pavegen, but is based in Portugal. They are also different because Waydip exclusively uses electromagnetic induction to produce electricity. They have developed both human footfall and vehicular-based kinetic energy recovery system. (Waydip, 2013)

ENERGY FLOORS

Originating from a sustainable dance club, Energy floors produce electricity through electromagnetic induction. It has already shown great potential in providing a significant portion of the club's energy need. (Energy Floors, 2013)

APPLICATIONS

KINETIC ENERGY RECOVERY USING FOOTFALL ENERGY HARVESTING

One way to recover kinetic energy in the metro station is to harvest energy from the steps of the passengers themselves. Depending on the vendor, the floor mats, slabs or tiles could be piezoelectric, electromagnetic, or even both. When installed at strategic places around the station, they can passively harvest energy and each of them produces a small amount of electricity. The idea is that hundreds of thousands of small things add up over time to become one bigger thing. In terms of electricity, only a few watts are produced for each step, but over the course of the day, and thousands of steps over hundreds of tiles, the total amount of energy produced can be substantial.

The key to ensure a tile is operating at its maximum potential is to place it within areas of the steady and consistent traffic. Based on general observation of the station, we have determined some of the optimal places to install a tile in the Moscow Metro. The absolute best place to install a tile would be at the ticket gate where a passenger has to walk through in order to get to the train platform. There are several other places around the station that have a high volume of traffic as well. Tiles could be installed at the top and bottom of stairs and escalators, near doorways, and on the platform when passengers get on and off the trains. With these areas there is more of a chance that people will step on a tile as they move around the station

KINETIC ENERGY RECOVERY USING RAILWAY ENERGY HARVESTING

Taking advantage of the energy reservoir of a moving train, piezoelectric and induction based energy harvesting can be applied to generate electricity as a train passes over a track. There are two different strategies for rail-based application that have various advantages and disadvantages associated with them. The first method is to place tiles underneath the rail at repeated intervals along the entire length of the tunnel. The second method is to install a section of rail that can depress as the train runs over it. Both methods take advantage of the vibrations and force the train imparts on the track.

RAIL KINETIC ENERGY RECOVERY

The rail application of kinetic energy harvesting uses the same concept as footfall energy generation but increases it multifold. This kind of kinetic energy recovery already has been investigated through several pilot projects and experiments. The Israeli company Innowattech has developed piezoelectric pads that can replace the pre-existing plastic pads underneath the rails in the metro tunnels. In 2010, in conjunction with Israel National Rail Company, Innowattech developed several real life pilot projects to test the viability and capacity of their product. The company assures that their process does not steal additional energy from the train because their pads have a higher Young's Modulus than the rails around them. (Innowattech Technical Information, 2013)

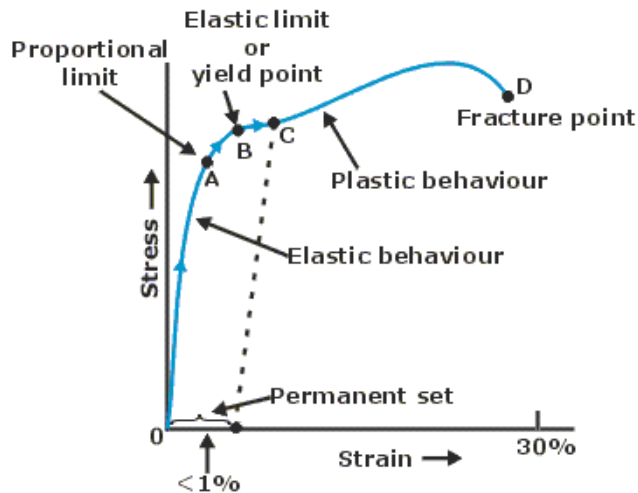

A typical stress-strain curve for a ductile metal

FIGURE 13: STRESS STRAIN CURVE (STRESS-STRAIN CURVE)

The Young's Modulus (also known as the Modulus of Elasticity) is a measure of the stiffness of an elastic material. It is quantified as the ratio of stress- to- strain ($E=\sigma/e$) in the elastic region. (Levey 2012) In the graph to the left, the Young's Modulus would be the line from the origin to the point "A". With a higher elastic modulus, the piezoelectric plates will deform less than the rails around them. This means that the tile will not steal additional energy from the trains as they pass over them.

Innowattech tested its IPEG technology in a pilot project with Israeli North Railways. According to Innowattech, its technology has a production potential of 120 KWh per hour for 1 kilometer of track. The energy output was determined using a basis of "two generators are inserted in every sleeper, [with] an average railway movement of 300 loaded wagons per hour." (Edery-Azulay, 2009) Obviously this figure would be different for the Moscow Metro system because of the variance of each line in terms of distance and passenger load. However, it does

provide a good basis to make informed assumptions as to what the energy output of the system could be.

Since the installation of this technology requires many pieces over a long distance, the time required to complete the job would be longer than can be allotted for the nightly downtime of the metro system. Instead of trying to retrofit the piezoelectric pads under the current rails, it would be better to install them on the rail in the new stations that will be built in the future. This way, the metro can avoid a service shutdown and ensure the job is done correctly. In addition, using Innowattech technology on new line allows the metro to test the system before committing to a full-scale implementation.

In addition to generating electricity, the Innowattech pads can collect valuable information and statistics about the health and operation of the metro trains. It has the ability to collect information related to the speed of the train, its weight for each car, the distance between two trains, and different anomalies in the wheel profile. (Events, 2010) The Innowattech IPEG provides an excellent electricity generator and control system for Moscow to test.

CHAPTER 2.3.3: TRAIN AUTOMATION

INTRODUCTION

Train automation is one of the most useful ways to optimize train acceleration, traction and braking with respect to energy efficiency. Train automation technology enables energy savings through establishing a harmonic cycle of operation. Almost always, the driver and his or her driving habits directly affect non-automated rapid-transit train performance. Sometimes, this includes extreme cases of non-consistent motion and inefficient braking or even stopping in the tunnel halfway between two stations to wait. Train automation avoids this ineffectiveness by introducing uniform motion, which includes efficient acceleration, coasting motion, and braking, represented by the trapezoidal velocity-time graph. Along with the economic and safety benefits, an automated metro system offers a sustainable solution to energy efficiency by improving the performance of each train along a subway line

As the most popular mean of transportation in Moscow, the Metro offers a constant inflow of trains as frequently as every 90 seconds at peak hours. Since there is a driver operating each train, in the presence of the human factor, there is significant room for operational misjudgment, inefficient use of traction power, or even safety errors. According to one of the market leaders, automation could realistically achieve a shorter time interval in between trains, known as headway, and reduce energy consumption by up to 30%, depending on the degree of automation (Siemens, 2012). There are four levels of automation listed in the table below, each of which is associated with specific technology.

Level	Degree of Automation	Nomenclature	Description
Level 1	Partly Automated	SCO – Supervision and Control Train Operation	Monitoring systems, information, etc. is provided to the driver who manually operates it
Level 2	Semi-Automated	STO – Semi-automated Train Operation	Driver starts the train manually, but precision stopping and some movement is automatic
Level 3	Driverless Mode	DTO – Driverless Train Operation	Driving is controlled and monitored automatically; driver could intervene in a case of emergency. Departure, movement, and stopping are all automated
Level 4	Unattended Mode	UTO – Unattended Train Operation	There is no personnel on board; operation could include coupling of trains, remote repair options, etc.

FIGURE 14: THE FOUR DEGREES OF AUTOMATION (SIEMENS, 2012)

COMMUNICATIONS-BASED TRAIN CONTROL (CBTC)

Communications-Based Train Control, known as CBTC, is an advanced infrastructure and positioning system of sensors, signals, and controls associated with train automation. It is further defined as a “continuous, automatic train control supervision system with high-capacity data communication”(Communications-Based Train Control, 2004). If Level 2 (the Semi-Automated level) requires train software and track sensors and signals, the Level 3 and 4 (the

driverless and unattended) require a fully operational Communications Based Train Control (CBTC) system. Along with the wayside equipment and the advanced controls, sensors, and signals, the CBTC system for urban rapid transit also features an Operations Control Center, which monitors all of the trains along a line (Siemens, 2012).

At any moment during the metro train daily operational cycle, the CBTC system constantly recalculates optimum velocity and headway, updates, and transmits the data to the control system. All of these efforts result in substantial savings with respect to energy usage due to improved acceleration, traction, and braking. Track sensors warn in case of obstacles along the tracks, so that there are no unnecessary shutdowns (Siemens, 2012). Each train features derailment detectors, wheel slip control and distributed brake control systems to ensure maximum safety, as well as efficiency with respect to power usage.

CBTC TRAIN AUTOMATION PROJECTS AROUND THE WORLD

Automating train lines has long been part of the conceptual evolution of underground transportation. It started out as early as the 1990s with the purpose of decreasing energy consumption. Contracts around Europe, the Americas, and Asia have been awarded to technology suppliers to implement CBTC signaling in urban subway systems.

In 1999, the New York City Transit (NYCT) signed a contract with Kawasaki Rail Car, Siemens Transportation Systems, and other contractors for the production and equipment of CBTC ready rapid-transit urban trains and their required infrastructure on the Canarsie (L) Line of the New York City Subway (Canarsie CBTC, 2009). Siemens implemented their CBTC technology, along with the Optical Speed Measurement System (OSMS), a sensor device that precisely and accurately determines measurements of traction-related data. After executing

dynamic testing of the automated trains on a test track, they were placed on the Canarsie line for non-CBTC passenger transportation and, over time, the NYCT would gradually increase the level of automation (Canarsie CBTC, 2009). In 2010, the NYCT extended the project further by signing a contract with Thales to retrofit older trains and install automation infrastructure on the Flushing (Number 7) line of the NYC subway (Flushing Line CBTC, 2010).

Another case of train automation that included retrofitting an existent line was the 2004 contract for the Line 1 of the Paris Metropolitaine system. Paris metro Line 1 was launched in 1900 and today more than 725,000 passengers use it daily (Paris Awards CBTC Contracts, 2004). After setting up the brand new, fully automated, driverless Line 14, the Paris metro authorities (Regie Autonome des Transports Parisiens, RATP) decided to pursue the automation of Line 1 in order to achieve better results in energy efficiency, operational quality and safety. The first driverless train on Line 1 was launched in 2009 and after the two-year transition period, all of the trains along the Paris Line 1 are now completely automated. After gathering enough data and running software simulations, the authorities extended automation projects even further when they signed Project Hurricane, an idea to implement a modern global train control system throughout the subway system (Paris Awards CBTC Contracts, 2004). They also awarded Siemens a €95 million contract to install sensors and signaling on five other lines of the Paris Metropolitaine (Siemens, 2008).

Another significant metro contract is the \$22 million Peruvian Lima Metro Line 1 automation contract, which was awarded to Bombardier (Cityflo, 2013). Copenhagen S-Train commuter rail network awarded Siemens a €252 million contract to install CBTC infrastructure on the 170km network (Siemens clinches Copenhagen S-Train CBTC contract, 2011).

MARKET LEADERS

There are three main competitors carrying out automation projects: Siemens AG, Bombardier, Inc., and Thales Group. The departments within these technological giants are Siemens Infrastructure and Cities Division, the Siemens Mobility and Logistics Systems Division, Bombardier Transportation, and Thales Communications. There are two competing products within the Communications-Based Train Control (CBTC) and they belong to the top two automation contractors respectively. The newest developments in train automation are related to the Siemens Trainguard MT and the Bombardier Cityflo 650 CBTC systems (Trainguard MT CBTC, 2013 and CITYFLO 650, 2013).

The Trainguard MT is an automation system used by the subways in Barcelona, São Paulo, and Paris Line 14, as well as more than 20 other systems worldwide (Siemens, How does?, 2012). In December 2012, the Hong Kong metro signed an €80 million contract with Siemens to automate the East Rail line. The 16-station line is to be upgraded through controls and signaling, as well as an operations control center for advanced train positioning, supervision, and electronic control interlocking (operations contradicting with safety measures). An outstanding CBTC system, the Trainguard MT is used to monitor performance and analyze key indicators related to train operation. Continuous two-way data communication is achieved through the wireless local area network (WLAN). The Trainguard MT achieves maximum train punctuality, so that no train would have to wait at a station or in the middle of a tunnel, but instead would have an efficient velocity profile (Siemens automates metro for Hongkong, 2012).

Similarly, Bombardier's Cityflo 650 is the newest generation of the Cityflo CBTC system. The 650 is already put to use in Madrid, Taiwan, Dubai, and London for driverless and unattended metro train automation (Levels 3 and 4). The Delhi Metro in India awarded Bombardier its most recent contract in September 2013, a \$61 million CBTC upgrade for the brand new Line 7 (Bombardier, 2013). It is very similar to the Siemens Trainguard MT CBTC system, as it includes radio-controlled train protection, continuous supervision through a control room, and wayside sensors and signaling. As part of the Cityflo 650 CBTC, the Dubai and London metros are also known to employ the Knorr-Bremse EP2002, an automated per-axle system placed along the entire body of the train that maximizes braking performance (EP 2002, 2009). This system eliminates energy losses that would otherwise result from a non-synchronous braking on each carriage, known as unbalanced dissipation.

CHAPTER 3: METHODOLOGY

INTRODUCTION

The goal of this project was to identify technologies and practices to reduce energy consumption and increase energy efficiency in the Moscow City Metro. From a broad set of ideas, we used a selection matrix to choose the three most promising technologies to recommend to the Moscow Metro. Based on these results, we conducted further research on the topics and developed a proposal to maximize general energy savings. Our colleagues at Financial University in Moscow provided an economic analysis of these proposals to determine how cost effective the program would be. From this research and analysis, we provided a recommendation to the Moscow Metro on what technologies should be implemented and how they should be implemented.

CHAPTER 3.1: CASE STUDIES

Case studies were the foundation of the project, demonstrating real life application or serious potentials for the various technologies and practices for use in the metro. They are one of the best sources of information on how different energy saving strategies work in reality. In order to improve the Moscow City Metro, it was important to look at how other metro systems have dealt with the same problem. Moscow City Metro was not the only metro system trying to become more energy efficient and therefore building on the successes and failures of others was essential for the success of this project.

To begin, we took a systematic approach at examining different metro systems around the world. We first focused on the metro systems facing challenges similar to Moscow's. The Moscow Metro has one of largest daily volumes of passengers in the world. In addition, it has an extreme climate that experiences significant temperature and light fluctuations. Based on this, we

researched high volume, cold climates metros such as New York City and London. However, it was eventually decided to not limit the scope of the project to those parameters and focus on effective use of technology instead. Therefore, case studies were refocused on finding a city that used a particular technology well instead of finding a technology that a particular city used well. This approach yielded more results by broadening the scope of our search.

The use of case studies allowed us to obtain more accurate data on the cost and energy savings of any particular system. This was a key strategy in our research because many companies keep data such as price and performance of their products private and only disclose such information to potential buyers. In such a situation, our only option was to find an example of the technologies use and relate the cost and energy savings for that project to a theoretical project in the Moscow Metro. By using strategies such as this, we found enough data to satisfy our financial models.

For each metro system that was studied, both successful and failed projects were taken into consideration. Although we gave priority to proven technologies with the highest energy saving potential, we also gave attention to up and coming technologies that the Moscow Metro might be interested in exploring. These younger technologies may be unproven, but they would put the Moscow Metro in the spotlight as an innovator. If the Moscow Metro is to be the leader in metro efficiency, it needs to be the first to implement next-generation technology.

CHAPTER 3.2: INTERVIEWS

To have access to primary information and data, the IQP team conducted several interviews and directed information requests to various companies. Some personal meetings

were held but a vast majority of them were conducted informally using e-mail, phone calls, and other electronic means of communication.

Our primary and most important information source was the Moscow Metro Transport Authority. In order to determine the full magnitude of energy savings potential, the most recent energy audit was requested in addition to technical data not available in the public domain. Since this is a government organization, much of the communication was facilitated through established contacts with EY and primarily orchestrated by Ivan Sokolov, the project leader.

In addition to information requests to the Metro, other requests were sent to various companies to ask them for technical data about their products and information about any pilot projects they have worked on. Email correspondence with employees in companies such as Waydip, Pavegen, and Siemens were instrumental in our research. While often times there was information that they could not disclose to us as students, it provided us with concrete, trustworthy, and up to date data that simply could not be found online.

CHAPTER 3.3: BENCHMARKING MATRIX

The Moscow Metro requested for the project to have a heavy emphasis on benchmarking to determine the best technologies and practices to use. With help from Joseph Prakash, a railway engineer at EY, we developed a set of parameters through which all of the technologies and practices would be compared. The matrix takes into consideration the deficiencies of the Moscow Metro, the current applications of each technology or practice, the inherent barriers, and their prospective energy savings potential. For each technology, we filled in each parameter with the best quantitative data that could be found. When required, parameters were filled in with qualitative data. For example, one parameter is institutional or policy barriers. This parameter is filled with qualitative data.

The matrix was integral in the decision for the final choices because it allowed both the IQP team and the Moscow Metro to make an informed assessment of the best possible technologies and practices. The ideal proposal was the one that had the most energy savings at a reasonable cost. However, the Moscow Metro is a large priority for the municipal government and represents a significant portion of the budget. Therefore, while the cost of a renovation was still a factor, it was much less important in our considerations compared to energy savings. Another pertinent qualification was that the project must not have already been pursued by the Moscow Metro. It did not make sense to analyze the possible benefits of a technology that is already installed.

CHAPTER 3.4: DEVELOPING PILOT PROJECTS

After finalizing the decision on which technologies we would recommend to the Moscow Metro, the next step was to develop a plan on how to apply the chosen technologies in the Moscow Metro. Once again our team looked at other metro systems to see how they had used the technology successfully. Combining what we saw in other metro systems with information from vendors, we developed a course of action for each technology.

CHAPTER 3.5: BENCHMARKING COSTS

Since the cost of Communications-Based Train Control technology is not publicly disclosed, our team used a benchmarking extrapolation approach in order to estimate how much the Train Automation contract would be worth. The study included five recent CBTC upgrade projects contracted around the world by both Siemens and Bombardier: Paris, Copenhagen, Lima, New York, and Hong Kong. For the purpose of our project, we chose to upgrade to Level 3 automation the Arbatsko-Pokrovskaya Line. We used a simple proportional function to estimate a relative budget according to each parameter. Dividing the known upgrade budget by each parameter and then multiplying each result by the according value for the Arbatsko-Pokrovskaya Line yielded a wide variety of results according to the various rail line upgrades.

Moscow Line Upgrade	Number of Stations	Length of Tracks [km]	Trains	Carriages	Average Annual Ridership [millions]
Arbatsko-Pokrovskaya	22	45.1	250	43	301

FIGURE 15: TABLE OF MEASURABLE PARAMETERS OF THE ARBATSKO-POKROVSKAYA LINE (O METROPOLITENE, 2013)

CHAPTER 3.6: FINANCIAL MODELING

Once a general idea of how to apply each technology to the Moscow Metro was determined, the project transitioned from an engineering perspective to the financial perspective. With help from students from the Finance University, we began to address the financial concerns and parameters that would affect the implementation of the project. To serve as a standard basis for all the models, the students decided to use the Arbatsko-Pokrovskaya line. This line is ideal because it has newer rolling stock already in use, which would facilitate the implementation of

our plans. As a team we described the conditions and the parameters that the model would be based off of and the Russian students used that information to develop financial models. These financial models determined the financial viability of the project and served as a justification to the advantages and disadvantages of different financial scenarios.

Financial Assumptions		Source
Cost of Subsidized Electricity	0.9 RUB/kWh	(Moscow Metro, 2012)
Energy Consumption per Carriage	62 kWh per hour	(Moscow Metro, 2011)
Interest rate	10.00%	(European Bank for Reconstruction and Development, 2012)
Basic inflation	6.40%	(International Monetary Fund, 2012)
Equipment inflation	6.40%	(International Monetary Fund, 2012)
Energy inflation	6.65%	(Moscow Metro, 2012)
Discounting rate	11.16%	(Macro Axis, 2013)
Loan maturity	20 years	Arbitrary
NPV duration	40 years	Arbitrary

FIGURE 16: FINANCIAL ASSUMPTIONS

The financial assumptions listed above were applied to the financial analysis of each of the three technologies. This makes comparison between them much easier because all assumptions are standardized.

With six Russian students assigned to our project, each IQP team member was given two students to develop a financial model for their chosen technology. The students built models that described the pilot projects under different scenarios. These scenarios included paying for the project without taking loans, financing the project by taking loans out from the European Bank for Reconstruction and Development, or increasing the scale of the project to the entirety of the metro system.

CHAPTER 3.7: ENERGY AND ECONOMIC ANALYSIS

When the models were completed, the results of the different financing methods as well as the energy saving potential were analyzed to see which options were most preferable. As the model was being built, the amount of energy each technology would produce or save was calculated. In addition, using the data generated by the financial models, the finance students calculated the net present value and the internal rate of return for each technology. The NPV and IRR were used as justification for financial viability. If there was a high-energy savings with a positive NPV, then that part of the project was determined to be worthwhile. On the other hand, if the technology had a negative NPV and could only offset energy demands by a mediocre amount, then the method was deemed financially unviable. Using the technology would have to be justified by other measures instead of pure financial profitability. In other words, the IQP team had to determine if the additional benefits of the technology were worth the cost and losing some amount money.

With financially viable technologies, IRR would be the determining factor on which method is the 'best.' The method with the highest IRR indicates that it is financial viable because of two reasons. The first is that the technology itself can be bought and operated at a reasonable. The second is that it has a high savings potential. The more energy the method saves or produces, the more it offsets the cost of using the technology. In sum, the method with the lowest operating costs and the highest energy savings is the best choice on a strictly financial basis.

CHAPTER 4: FINDINGS

CHAPTER 4.1: ULTRACAPACITORS

CHAPTER 4.1.1: PROPOSED ULTRACAPACITOR PLAN

Ultracapacitors have been installed in many metro systems around the world. Their popularity is driven by their ability to take full advantage of regenerative braking systems which themselves are gaining widespread use. In proposing a plan for implementation in the Moscow Metro, we matched the various ultracapacitor system options to the needs of the Moscow Metro. We recommend that the Moscow Metro first install one Siemens Sitras SES wayside ultracapacitor unit on the Arbatsko-Popkrovskaya line. Then, based on the results of this pilot project, make a decision on whether or not to buy more.

The adoption of wayside ultracapacitors instead of onboard ultracapacitor systems meshes with the Moscow Metro's future plans. While onboard ultracapacitors are usually cheaper than wayside ultracapacitors, their other features would not be as useful to the Moscow Metro (BASE Energy inc., 2007). For instance, the ability to travel from station to station without a power supply may be a useful feature of onboard ultracapacitors if used in above ground train systems that are concerned with their external appearance. However, implementing such a system in the Moscow Metro would yield few benefits since the trains travel through tunnels that are hidden from the public eye.

An advantage of the wayside systems as opposed to the onboard systems with regards to the Moscow Metro is their ability to service multiple trains. Whereas onboard systems can only store the energy generated by that individual train, wayside systems can store energy generated by any train in the area. Given the Moscow Metro's 90 second headway, there are a large number of trains on the track at any given time (Moscow Metro, 2007). So many trains mean that

it will be easier to install fewer units that can service multiple trains instead of one unit on each train.

The most important factor in our decision was the Moscow Metro's plan to replace all of their trains by the year 2020 (Moscow Metro, 2011). A wayside ultracapacitor system is independent of the rolling stock on the tracks. Trains can be switched on and off of the track at will and the wayside ultracapacitor system will still function. Onboard ultracapacitor systems on the other hand must be installed on any new trains added to the track.

As discussed in the background section, there are several manufactures of wayside ultracapacitor systems. The industry leaders are Bombardier with its EnerGstor, and Siemens with its Sitrans SES (Devaux & Tackoen, 2011). While the EnerGstor system has undergone some pilot testing, we recommended the Sitrans SES to be installed in the Moscow Metro since it has been tried and tested in many metro systems since its first use in Cologne in 2001 (Siemens , 2004).

We picked the Arbatsko-Pokrovskaya line to install the first Sitrans SES unit because it is already using regenerative braking (Moscow Metro, 2011). This is ideal because the only retrofitting that will be required will be the actual installation of the Sitrans units. As a result Sitrans SES system will begin collecting energy without delay.

CHAPTER 4.1.2: ANALYSIS OF ULTRACAPACITORS

To determine what kind of an impact one Sitrans SES unit could have on the Moscow Metro, we looked at data from its previous use in Cologne as well as data provided by Siemens. We used tests done in Cologne to estimate the minimum electricity saved per year per Sitrans unit. The Cologne test saved on average 35kWh per hour, or 240,000kWH per year if operating 19

hours per day (the hours of the Moscow Metro) (Siemens , 2004). We set this as our minimum estimate because the Moscow Metro has a higher frequency of trains compared to the Cologne metro. More trains in service directly correlates to more energy being used, and thus more energy that can be recovered. We set our high estimate at 500,000kWh per year per unit. This is the maximum potential savings that Siemens claims in their product fact sheet. In our financial calculations we used the optimistic estimate of 500,000kWh per year per unit.

To analyze financial efficiency of the ultra-capacitor technology it's enough to calculate efficiency of single capacitor bank because every unit works separately, controlling only its sector of railway. This means that our financial analysis of the purchase of one unit should also apply to the purchase of many units. If it is financially viable to purchase one unit, then it will be financially viable to purchase more than one unit. The purchase of multiple units is limited by the amount of energy produced through regenerative braking. Once there are enough units to store all regenerated energy, it no longer makes sense to buy more. It is convenient that our model is independent of the number of units purchased because without analysis by Siemens engineers, it is hard to tell how many units are needed.

To build our financial model we have used MS Office Excel and several available finance formulas such as “=IRR(values, guess)” and “NPV(rate,value1,[value2]”. To build sensitivity tables we have used “data tables” of MS Excel.

All our assumptions and data were gathered from varied sources. For example, the price of energy is taken directly from Moscow Metro Annual Report 2012, while the price of one unit is based on Cologne's claim that one unit paid for itself in 4 years. In the table below, you can see a complete list of the data we inputted into the financial model and its source.

Installation		Source
Amount of units	1	Arbitrary
Cost of one unit, rubles	1800000	(Siemens , 2004)
In total:	1800000	

Economy		
Amount of saving energy (kWh per year)	500,000	(Siemens, 2012)
Cost of kWh of energy (rubles)	0.9	(Moscow Metro, 2012)
Amount of capacitor banks	1	Arbitrary
In total per year:	450000	

Maintenance		
Amount of capacitor banks	1	Arbitrary
Cost of replacement of a unit	1350000	(Siemens , 2004)
Cost of maintenance of a unit per year, rubles	50000	(MacCurdy, 2010)
Lifespan (years)	10	(MacCurdy, 2010)
In total for lifecycle:	1850000	

FIGURE 17: PARAMETERS USED IN FINANCIAL MODEL

For our model we have developed two financing scenarios: the loan and self-financing. In the self-financing scenario, the Moscow Metro would absorb all costs of installation of ultra-capacitor units. In the loan scenario, the Metro would take out a loan from the European Bank for Reconstruction and Development (EBRD) for twenty years. As an interest rate we have chosen an average amount of such rates of EBRD for transport systems development (it varies from 5% to 15%). To analyze of viability of the technology we have built tables and then graphs based on them, which represent cumulative benefits (which we will get after implementation) and break-even point (BEP).

To find the BEP of the self-financing scenario, we plotted a line of the installation costs and the cumulative benefits. The BEP is located on the crossing of installation costs line and the cumulative benefit line. The end of the system's 10 year lifespan can be seen on the graph when the green line dips as money is paid out to replace it. Since the green line does not dip down past the initial investment line upon replacement, the system saves enough money to pay for its own replacement.

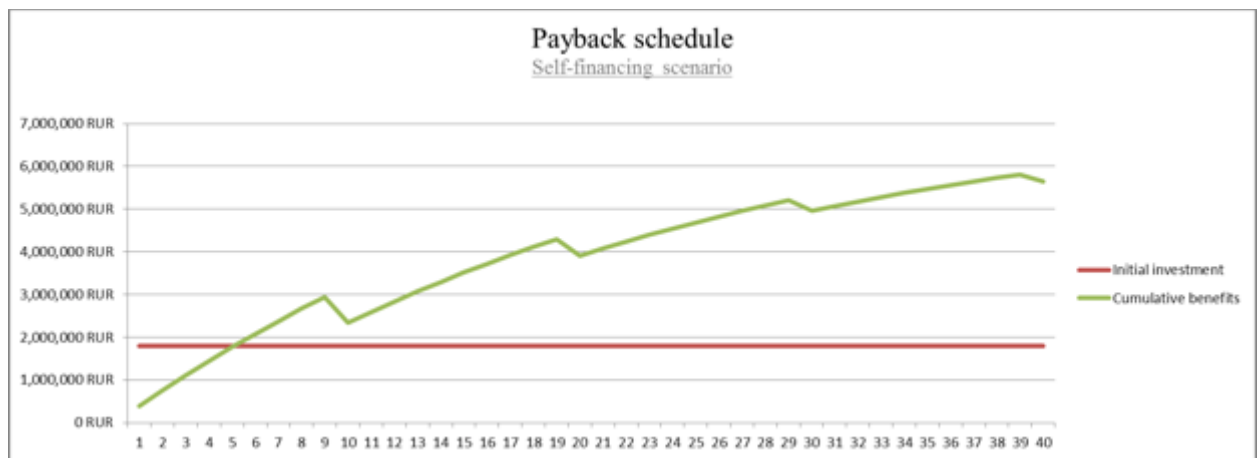

FIGURE 19: SELF FINANCING PAYBACK SCHEDULE

To analyze of viability in loan scenario we have built a graph showing comparison of all costs (including loan payments), economy benefits and cumulative benefits. If the technology is viable, the cumulative benefits line will never go below zero. As you can see in the graph, on this basis the technology is viable.

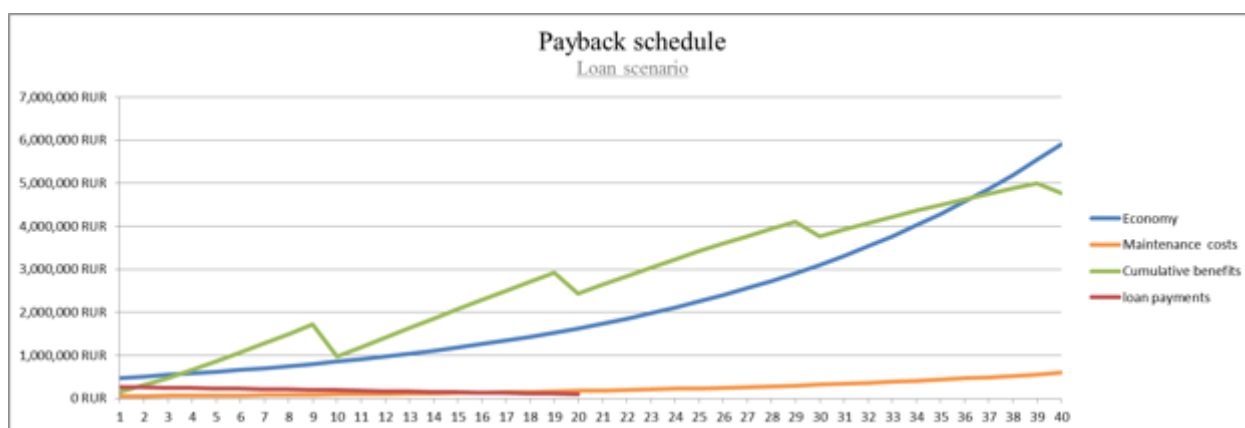

FIGURE 20: LOAN FINANCING PAYBACK SCHEDULE

Our financial model shows that the technology is viable in both scenarios. In the self-financing scenario it pays-off in 6 years and covers all costs. In the loan scenario we successfully close the credit with surplus benefits. For the self-financing scenario IRR is 27.3% and NPV (for 40 years) is 3856109.6 RUR. For the loan scenarios IRR is 17.7% and NPV (for 40 years) is 2965060.3 RUR. This financial analysis shows that the Siemens Sitras SES is capable of both saving large amounts of energy, and being financially viable.

CHAPTER 4.2: KINETIC ENERGY HARVESTING

CHAPTER 4.2.1 PROPOSED ENERGY HARVESTING PLAN

In addition to recommending technologies that are already well established and proven, a next-generation technology was included in order to push the limit and test new methods of sustainable energy generation. The Moscow Metro has ideal conditions to facilitate the use of energy harvesting. Being one of the busiest metro systems in the world, with thousands of passengers and rapid train service, there are enough moving bodies to collect small amounts of energy from. Over time, the small increments of generated energy can add up to a significant amount of electricity.

Like ultracapacitors and train automation, kinetic energy harvesting would be piloted on the Arbatsko-Pokrovskaya. There are two different methods of energy harvesting that could be used on this line. The first is footfall energy recovery and the second is railway energy recovery.

The goal for railway based energy harvesting is to take advantage of the Moscow Metro's extremely short headways and nearly all day peak hours. These fully loaded trains arrive and depart stations at a quick frequency. The combination of speed and weight makes the train a large, energy dense reservoir.

The plan would be to use Innowattech IPEGs in the parts of the tunnel that are directly before the train arrives in the station. In the interest of time and minimal disruption to the operation of the metro, only 100 meters of track would be retrofitted. In addition, only converting this section of the track has additional benefits. With concerns about the pads being parasitic and taking away more energy from the train than they produce, the train is already

slowing down and therefore any energy stolen from the train would be beneficial to slow the train down.

Unfortunately due to limited available information on the technical details of Innowattech pads, a focus could not be placed on railway based energy harvesting. A financial model was still made, however, it is limited in scope due to much of the information being confidential and private. Still, the model was made versatile enough to where it could be modified if and when new information became available. With railway-based energy harvesting not a viable technology to study, the main focus is put on footfall based. With a much larger amount of available data, a more accurate model could be made.

Footfall energy harvesting proved to be a more applicable choice than railway. Its use and installation would have a smaller disruptive impact on the metro. While there are several available manufacturers, only two proved to have a developed enough product that could be used. The two manufacturers, Pavegen and Waydip, also provided enough technical data and information to build accurate financial models.

The proposed application of kinetic energy harvesting based on footfall energy would be to install Pavegen or Waydip tiles at the ticket gates of the entrances of each station on the Arbatsko-Pokrovskaya line. Pavegen produces more energy due to its hybrid electromagnetic induction and piezoelectric method of generating electricity. However, it is also more expensive because of this. The other vendor, Waydip, is much cheaper than Pavegen tiles, because it solely uses electromagnetic induction but its energy production suffers.

Installing footfall Units at the ticket gates would be the optimal location to harvest footfall energy. It guarantees a step from every person as they enter the station. The ideal

situation would be that in order for a passenger to pass through the gate, they would have to both scan their ticket and step on the tile. Once both actions were completed, then two Plexiglas doors would retract and the passenger could pass through. Another added benefit of placing the tiles by the ticket gates is that passengers will have to start moving from a standstill. Passengers will have to accelerate through the gate and impact more force on a tile than they if they were walking normally around the station. Other added benefits to keeping the Units only at the gates are that it minimizes the risk of a fall if they were on stairs, and installing them at the gates instead of on the edge of the platform is less intrusive to the operation of the metro system.



FIGURE 21: A POSSIBLE CONFIGURATION OF PAVEGEN TILES BY TICKET GATES. (KEMBALL-COOK, 2013)

The energy generated over the course of the days and from thousands of steps would go to powering the gate and lights around the station. According to Waydip, 2.5 square meters of tiles, or about 10 modules would be enough to power the entrance gates and two LED lights.

(Duarte, Francisco. 2013)

Installing footfall energy harvesting Units is also easily scalable as any amount can be installed on new lines or retrofitted onto old ones. Using energy-harvesting technology in the Moscow Metro opens up new possibilities for energy efficiency and energy conservation.

CHAPTER 4.2.2 ANALYSIS OF ENERGY HARVESTING

Five different financial models were made for the three different manufacturers. The model for the Innowattech IPEGs was purposely made to be generic so that when more data becomes available, the information can be entered and replace the assumed data. In addition two models were made for Innowattech methods, one for a loan financed scenario and the other a self-financed scenario. Two models were made for the Pavegen and Waydip Units, one for just the Arbatsko-Pokrovskaya line and the other for the entire Moscow Metro

The financial models were built MS Office Excel, using such functions as “=IRR(values, guess)” and “NPV(rate,value1,[value2],...)”. The first function returns the IRR for a series of cash flows represented by the numbers in values. The internal rate of return (IRR) is the interest rate received for an investment consisting of payments (the overall expenses on technology implementation) and income (money saved from less energy expenses) that occur at regular periods. The NPV function calculates the net present value of an investment by using a discount rate and a series of future payments and income. NPV to the IRR function, because IRR is the rate for which NPV equals zero: “NPV(IRR(...), ...) = 0”.

In addition to the NPV and IRR, the effectiveness of the project was analyzed with sensitivity analysis, which provides a range of possible outcomes for a particular piece of information. It highlights the margin of safety that might exist before the project becomes financially unviable. A sensitivity analysis provides insight in how the optimal solution varies

when the coefficients of the model change. It is usually prepared by using Excel functions “What-if” analysis and Data Table.

Since footfall is dependent on passenger traffic, the daily and yearly number of passenger statistics was taken to calculate the potential amount of energy the technology could produce. It was assumed that 2 steps could be harnessed per person, one as they enter and one as they exit the station. The amount of energy produced, in joules, was then converted to kWh. The energy produced was then multiplied by the cost of electricity the Moscow Metro has to pay. The final figure was considered to be income because it offset the amount of money the Metro would normally have to pay. Income increased each year due to the inflation of energy costs. The next calculated parameter was the overall cost of the technology itself. Maintenance and installation of the tiles were assumed to be a part of the quoted cost of the tiles. Pavegen tiles cost about 97,500 RUB (Pavegen Pricing Schedule) and Waydip tiles cost about 210,000 RUB per square meter, which each tile assumed to be 0.25 square meters (Duarte, Francisco. 2013). The cost per tile was then multiplied by the number of ticket gates to determine initial total cost. Since the tiles have a limited lifespan, they had to be replaced every few years. In addition it was assumed that the cost of the tiles would reduce by 50% every year until they had an average cost of 2,500 rubles. (Morales, Alex. 2013). While the price of tiles decrease, total passenger ridership of the Moscow Metro was set to increase by 1.72% per year in accordance with data in the 2011 Annual Report. From these calculated parameters, the models were made to determine their financial viability.

The second part of the financial modeling was about the installation of piezoelectric converters directly on the railroad. The proposed Innowattech system would consist of 8 IPEG pads, data transmitter, Railway Station Software, and an RFID Tag-reader. Unfortunately,

Innowattech did not disclose information on the costs of the technology. Therefore the constructed a model is based solely on assumptions. Thus, the supposed that the price of the technology is 175,56 RUR and annual power output is 10,000,000 kWh. The model was intentionally made to be flexible, allowing the old assumptions to be replaced with accurate data

Lastly, sensitivity analysis was made to further analyze the financial models. A sensitivity analysis gives the optimal combination of coefficients of the model. Positive values indicate combinations of parameters in which the project could be financially viable. Values that are 0 or negative indicate that the current financial scenario at the indicated prices will lead to a financial unviable project.

1) Pavegen- Arbatsko-Pokrovskaya Line

Parameters	Value	Comments
Price per tile (RUB)	97,496.99	
Quantity, units	332	188 stations overall in the Metro, and 22 station on the Arbat line
Total cost of equipment, mln RUR	32.36	
Passengers/year 2011	279,528,723	Yearly traffic
Passengers/ day 2011	1,084,785	Daily traffic
Power output J/step]	8	Electricity generated by tiles per step
Electricity/day (KWh)	4.82	Electricity generated by tiles a day
Electricity/year (KWh)	1,242.3	Electricity generated by tiles a year
Lifespan	1,684,555.7	Steps made on 1 tile per year
Replacement rate (years)	2.96	Lifespan of a tile 5,000,000 steps
Cost reduction on equipment	50.00%	

FIGURE 22: GENERAL PARAMETERS FOR PAVEGEN CALCULATIONS

Using the calculated parameters and assumptions a financial model was made using the aforementioned methodology. As Figure 26 below shows, there is a large initial cost and then as time goes on, the cost of tile and energy saved offset each other. However due to the overwhelming start up cost, the NPV of the first model -40.60 million RUB. There is no IRR because NPV is negative. Using Pavegen tiles in the Arbatsko-Pokrovskaya line is financially unviable.

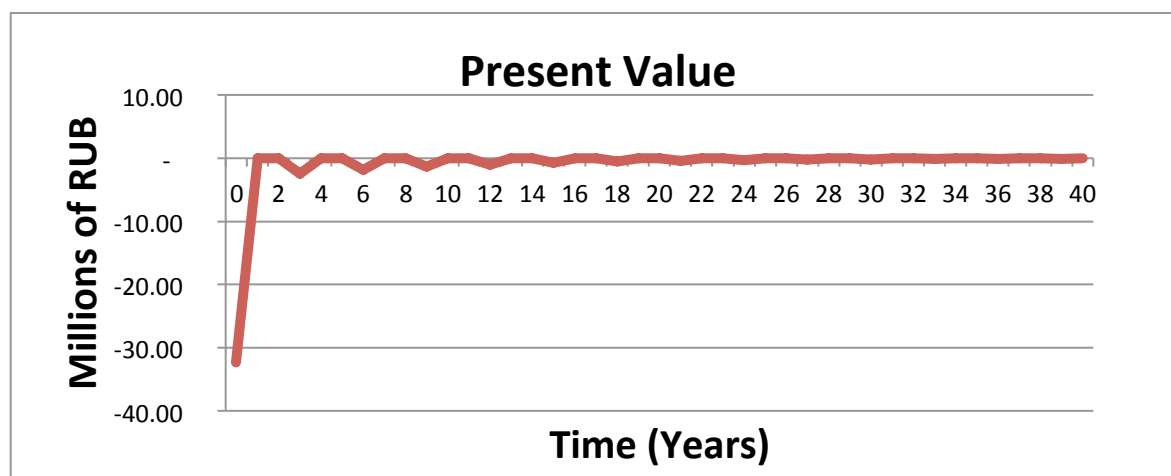

FIGURE 23: PRESENT VALUE FOR PAVEGEN ARBATSKO-POKROVSKAYA LINE MODEL

2) Pavegen- Entire Metro

Parameters	Value	Comments
Quantity, units	2,836	
Total cost of equipment (mln RUB)	276.50	Price of a tile multiplied by its quantity
Electricity/day (kWh)	41.19	Electricity generated by tiles a day
Electricity/year (kWh)	10,616.44	Electricity generated by tiles a year

FIGURE 24: GENERAL PARAMETERS FOR CALCULATIONS OF PAVEGEN-ENTIRE METRO MODEL

Since the amount of footsteps harnessed is moneymaking factor, another model was made to calculate what the result of harvesting every single passengers footsteps. This model simulated putting Pavegen tiles at every ticket gate in the metro. All other parameter and assumptions are the same as the first Pavegen model. As seen in Figure 28 a similar PV scheme happened again where there was a overbearing upstart cost and then the rest of the model has offsetting cost that are negligible in comparison. This model results in just a scaled up version of the previous Pavegen model, with an NPV= -297.91 Million RUB. Once again there is no IRR and applying Pavegen tiles to the entire metro is financially unviable.

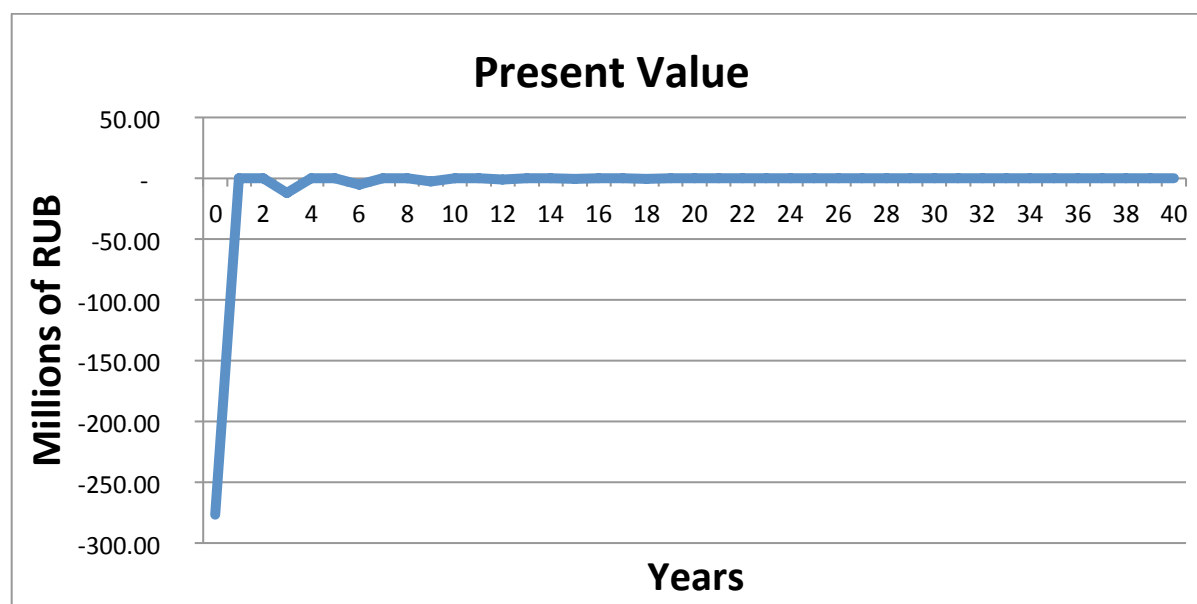

FIGURE 25: PRESENT VALUE FOR PAVEGEN-ENTIRE METRO MODEL.

Sensitivity Analysis for Pavegen Tiles

From the tables, in order for Pavegen technology to be profitable, even with the desired price of 2300 rubles, the price of electricity would have to increase by more than 3800% to 35.5 RUB/kWh. The subsidized cost of electricity is currently so cheap that Pavegen would be unable to pay for itself.

Cost of Electricity (in RUB/kWh)	Cost of Pavegen Tile (in RUB)					
	5203.7	4423.1	3759.6	3195.7	2716.3	2308.9
35.5	-0.59	-0.50	-0.40	-0.28	-0.14	0.02
39.5	-0.53	-0.44	-0.33	-0.19	-0.04	0.15
41.5	-0.51	-0.41	-0.29	-0.15	0.02	0.21
47.5	-0.42	-0.31	-0.17	-0.01	0.17	0.40
49.5	-0.40	-0.28	-0.13	0.03	0.23	0.46
55.5	-0.31	-0.18	-0.02	0.17	0.39	0.64
57.5	-0.29	-0.15	0.02	0.21	0.44	0.71
65.5	-0.18	-0.02	0.17	0.39	0.65	0.95
67.5	-0.15	0.02	0.21	0.44	0.70	1.02
77.5	-0.01	0.18	0.40	0.66	0.97	1.33
79.5	0.02	0.21	0.44	0.70	1.02	1.39

FIGURE 26: SENSITIVITY ANALYSIS OF INCREASED COST OF ELECTRICITY VS DECREASED COST OF PAVEGEN TILES

3) Waydip- Arbatsko-Pokrovskaya Line

Parameters	Value	Comments
Price per tile (RUB)	209,569.44	20% discount for quantity >250 m ²
Number of turnstiles	332	22 station on the Arbat line
Square meters	83	1 turnstile is 0,25 square meters
Total cost of equipment (mln RUB)	19.13	With 10% consideration of installment
Power output [J/step]	3	Electricity generated by tiles per step
Electricity/day (kWh)	3.6159	Electricity generated by tiles a day
Electricity/year (kWh)	931.76	Electricity generated by tiles a year

FIGURE 27: GENERAL PARAMETERS FOR CALCULATIONS FOR WAYDIP

Since Pavegen tiles are currently too expensive, models were made for the cheaper product Waydip to see if the reduced cost could be profitable. However, Waydip tiles produce less than half the energy while only being about a third cheaper than Pavegen. This proved to be relatively unimportant for the outcome. While the NPV of the model was -20.60 Million RUB, about half as much as the Pavegen-Arbat Line, it still follows the same trend. The first two installations cost more than the next 35 years of energy savings can repay. Like before, there is no IRR and the Waydip- Arbatsko-Pokrovskaya Line method is financially unviable.

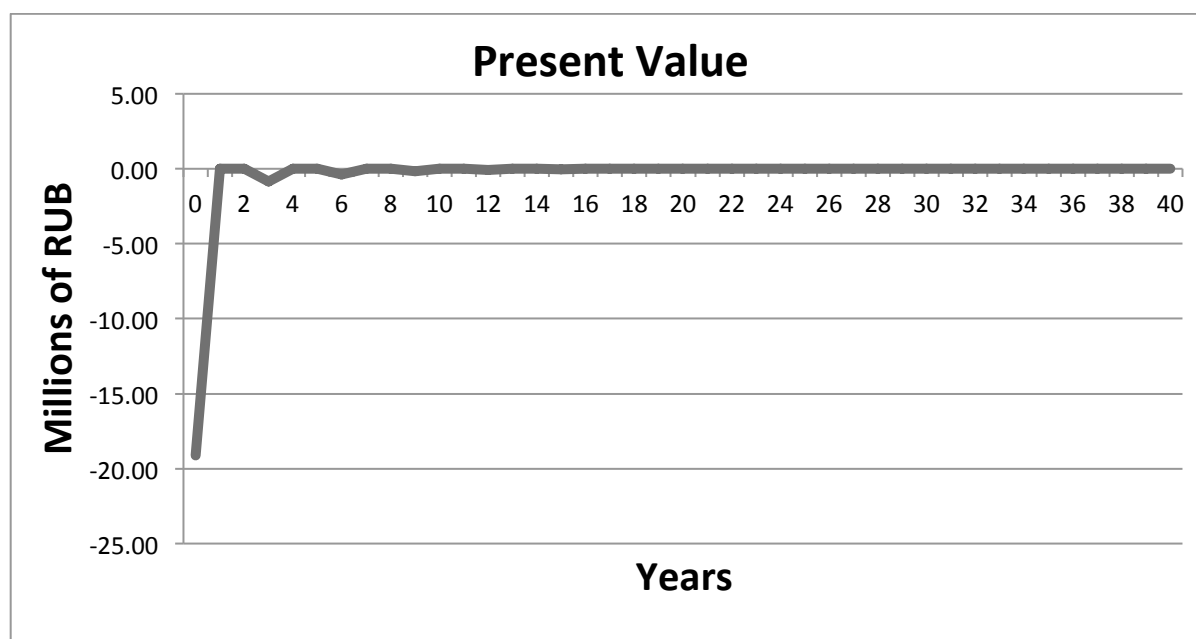

FIGURE 28: PRESENT VALUE FOR WAYDIP- ARBATSKO-POKROVSKAYA LINE MODEL.

4) Waydip- Entire Metro

Parameter	Value	Comments
Number of turnstiles	2836	http://mosmetro.ru/upload/600/2011.pdf
Square meters	709	Taken that 1 turnstile is 0,25 square meters
Total cost of equipment, mln RUR	163.4	With 10% consideration of installment
Electricity/day (kWh)	30.900	Electricity generated by tiles a day
Electricity/year (kWh)	7962.333	Electricity generated by tiles a year

FIGURE 29: GENERAL PARAMETERS FOR CALCULATIONS FOR WAYDIP-ENTIRE METRO MODEL

With similar results to Pavegen, an increase in scale to incorporate Waydip throughout the entire Metro system results in a financially unviable plan. While the cost of the equipment is significantly cheaper, the amount of energy produced is still not able to overcome the overall cost. For this model the NPV is -176.07 million RUB.

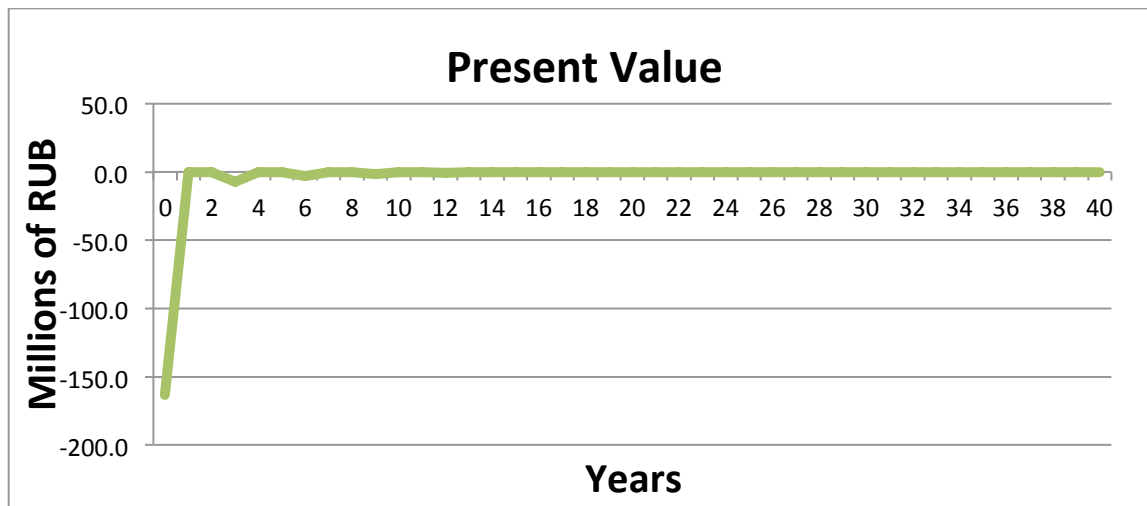

FIGURE 30: PRESENT VALUE FOR WAYDIP- ENTIRE METRO MODEL.

Sensitivity Analysis for Waydip tiles

The second sensitivity analysis has the same parameters, comparing the cost of electricity to the cost of a Waydip tile. From the table, it is calculated that in order to experience a profitable model, the cost of electricity would have to increase to 37.5 RUR and the cost per square foot of the tiles would have to decrease to 6,589.12 RUB, or about 1,650 RUB per tile.

Cost of electricity (in RUB)	Cost of Waydip Tile (in RUB)				
	12622.6	10729.2	9119.8	7751.9	6589.1
37.5	-0.50	-0.40	-0.27	-0.13	0.03
41.5	-0.44	-0.32	-0.19	-0.03	0.15
43.5	-0.40	-0.29	-0.15	0.02	0.21
49.5	-0.31	-0.18	-0.02	0.17	0.39
51.5	-0.28	-0.14	0.03	0.22	0.45
57.5	-0.19	-0.03	0.15	0.37	0.63
59.5	-0.16	0.01	0.20	0.42	0.69
69.5	0.00	0.19	0.41	0.67	0.98
71.5	0.03	0.22	0.45	0.72	1.04

FIGURE 31: SENSITIVITY ANALYSIS OF INCREASED COST OF ELECTRICITY VS DECREASED COST OF WAYDIP TILES

5) Innowattech- Arbatsko-Pokrovskaya Line Model

Parameters	Value	Comments
Price per unit (RUB)	30,000	Assumed
Quantity, units	5852	Multiplied number of stations, pads and piezo-elements
Number of stations	22	
Qty of units per station	266	We assumed that there are 133 pads per station and we need 2 piezo-elements per 1 pad
Total cost of equipment (mln RUB)	175.56	
Maintenance rate	5	Assumed
Power output annually, (kWh)	10,000,000	Assumed
Replacement rate	30	
Loan maturity	20	We will repay the loan in 20 years

FIGURE 32: GENERAL PARAMETERS FOR CALCULATION FOR INNOWATTECH

Self-Financed Model

Even though there was not enough data to create a real life model, a model was still made to simulate possible scenarios if Innowattech IPEGs were used. Assumptions were made based on the average length of each station to determine how many pads were needed. The total costs of the pads were based on the cost of other kinetic energy recovery technologies. The only parameter that was considered was the figure that 1km of track can yield 120 kWh of energy. In the self-financed scenario, seen below in Figure 36 , the large initial investment is overcome in the first few years, however due to the frequent replacement rate the project still ends oscillation between positive and negative present value. Overall the NPV is -92.29, making the project financially unviable like the footfall based kinetic energy harvesting.

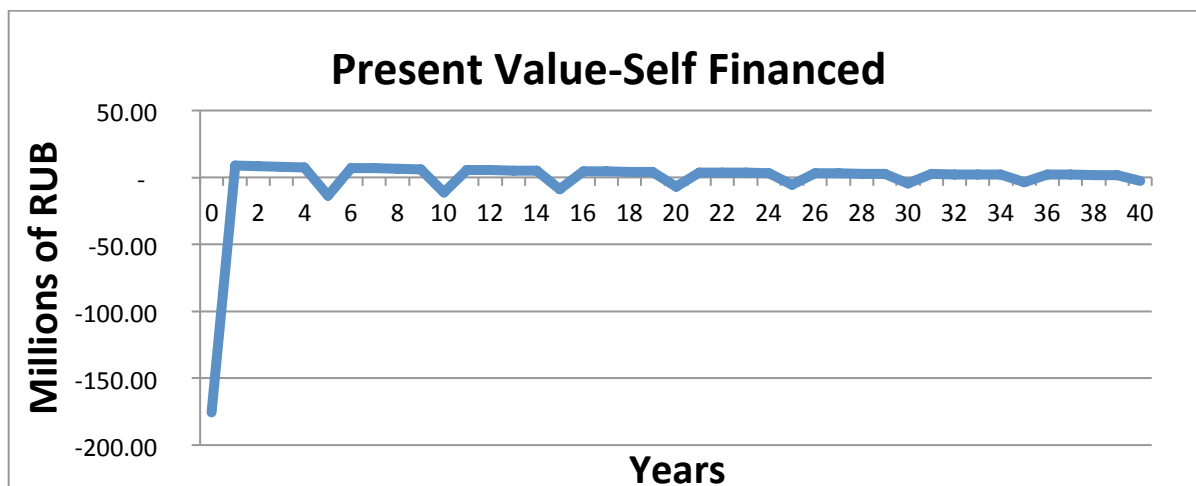

FIGURE 33: PRESENT VALUE FOR INNOWATTECH ARBATSKO-POKROVSKAYA LINE MODEL – SELF-FINANCED

Loan Financed Model

Another model was made using Innowattech IPEGs, this time the project would be financed through a loan from the EBRD. As seen in the graph below, this situation is worse because interest payments combined with IPEG replacement completely negates any gains due to saved energy. For this model the NPV is -254.79 million RUB and financially unviable.

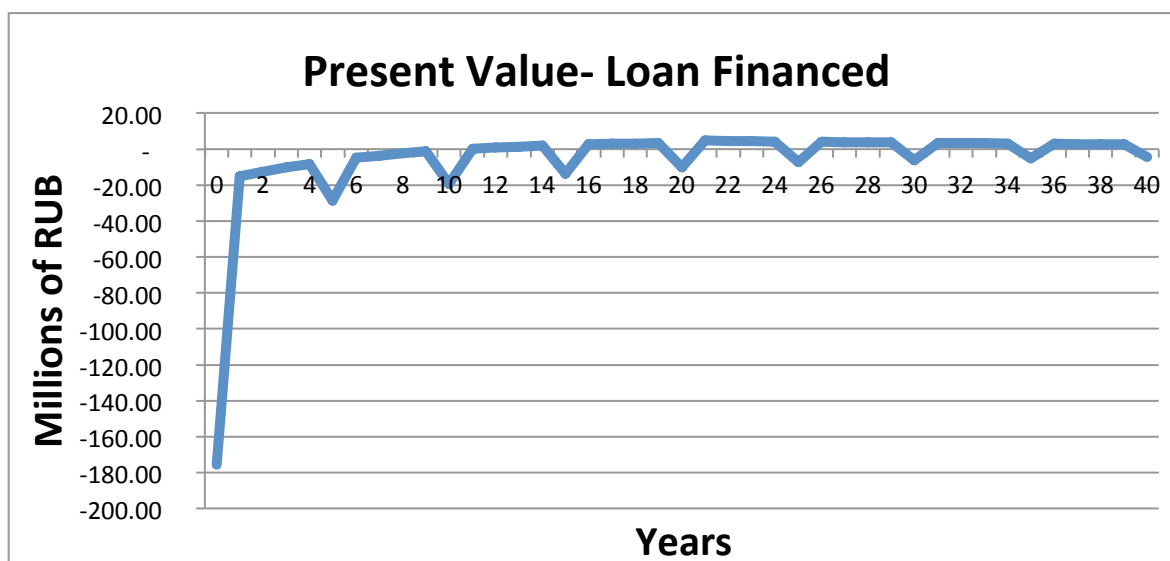

FIGURE 34: PRESENT VALUE FOR INNOWATTECH ARBATSKO-POKROVSKAYA LINE MODEL – LOAN-FINANCED

The sensitivity analysis below shows that energy inflation is more subject to change than basic inflation. This indicates further that the models would more likely be economically unviable because the cost of energy is subsidized for the Moscow Metro. Unless the subsidy is removed, or the rise in energy inflation outpaces the rate of basic inflation, then a loan-financed project will be unviable.

Energy Inflation	Basic Inflation						
	0.10	0.11	0.12	0.13	0.14	0.15	0.16
0.06	0.19	0.52	0.93	1.45	2.11	2.96	4.05
0.07	0.11	0.43	0.84	1.36	2.03	2.88	3.97
0.08	0.00	0.33	0.74	1.26	1.93	2.78	3.87
0.09	-0.13	0.20	0.61	1.13	1.80	2.65	3.74
0.10	-0.29	0.04	0.45	0.97	1.63	2.48	3.57
0.11	-0.50	-0.17	0.24	0.76	1.43	2.28	3.37
0.12	-0.76	-0.44	-0.02	0.50	1.16	2.01	3.10
0.13	-1.10	-0.78	-0.37	0.16	0.82	1.67	2.76
0.14	-1.54	-1.22	-0.80	-0.28	0.38	1.23	2.32
0.15	-2.11	-1.78	-1.37	-0.85	-0.19	0.66	1.75
0.16	-2.85	-2.53	-2.12	-1.59	-0.93	-0.08	1.01

FIGURE 35: SENSITIVITY ANALYSIS OF ENERGY INFLATION VS BASIC INFLATION FOR INNOWATTECH TILES

CHAPTER 4.3: TRAIN AUTOMATION

CHAPTER 4.3.1: PROPOSED PLAN FOR TRAIN AUTOMATION

From retrofitting century-old lines to installing Communications-Based Train Control (CBTC) signals and wayside equipment, train automation has been a vital part of optimizing urban subway systems. Given the large scale of usage of the Moscow metro system, we recommend that the authorities consider a train automation contract due to its ability to safely save operational time through headway, optimize energy consumption, and save money.

The Arbatsko-Pokrovskaya Line would be suitable to employ train automation and CBTC signaling, as the trains, tracks, and tunnels are relatively modern compared to the rest of the Moscow lines. The line uses 43 Metrowagonmash 81-740 (Rusich) trains, which have precision stopping and high digital capabilities (O Metropolitene, 2012).

The main reason behind train automation is the savings on time, energy, maintenance, and salaries. CBTC technology allows fully developed operation in headway of less than 90 seconds without any emergency stops. As the passengers in the Moscow metro increase every year, the metro authorities need to recognize that train headway has to decrease. Given a high frequency of trains, only the precision and accuracy of a software dispatch program could coordinate when each train is allowed to leave a station without causing safety concerns.

The savings on energy are due to the optimized operation. Siemens reports up to 30% of savings on energy from its advanced Trainguard MT CBTC system (Trainguard MT CBTC, 2013). Similarly, the Glasgow metro in Scotland reports high savings due to a reduced need of maintenance on the trains and tracks (Communications-Based Train Control, 2013). Automation levels 3 and 4 also reduce the need for a driver of the train, but due to common business rules, worker layoff is not recommended. However, provided that there is a driver and sometimes a

navigator in each train along the Arbatsko-Pokrovskaya line, automation could reduce the need for a helper and even a skillful train operator. Automated train drivers usually take care of door closing and intervene in case of emergency.

As described previously, there are two main competitors on the CBTC market, Siemens and Bombardier, both of which carry out full automation projects. We would recommend Siemens and their Trainguard MT system for two main reasons: the fact that Siemens has had more implementation contracts and because Siemens has already landed on the Russian market (Siemens, 2012).

CHAPTER 4.3.2: ANALYSIS OF TRAIN AUTOMATION

BENCHMARKING THE BUDGET

Since the cost of the Siemens Trainguard MT is not publicly available, we had to determine a relative budget through benchmarking extrapolation. We conducted a study to estimate what the cost would be based on five other contracts signed across the world. As described earlier, we used a simple proportional approach to calculate a budget according to each measurable parameter of the Arbatsko-Pokrovskaya line. We divided the known upgrade budget by each parameter and then multiplied the result by the according value for Moscow. As a result, we took an average of all rail upgrades to find a budget, which would be used further in our financial models.

The first step was to analyze the measurable parameters of the Arbatsko-Pokrovskaya line. Then, we analyzed each contract and calculated the budget according to Moscow (O Metropolitene, 2012).

Moscow Line Upgrade	Number of Stations	Length of Tracks [km]	Trains	Carriages	Average Annual Ridership [millions]
Arbatsko-Pokrovskaya	22	45.1	250	43	301

FIGURE 36: TABLE OF MEASURABLE PARAMETERS OF THE ARBATSKO-POKROVSKAYA LINE

Paris

Siemens signed a contract to upgrade Paris lines 3, 5, 9, 10, and 12 with CBTC technology for an announced fee of €95 million (4.157 billion RUB). Our project team gathered all of the measurable information with respect to those lines, including number of stations, trains, and carriages, length of tracks and average riders per year (Paris Awards CBTC Contracts, 2004).

Line	Number of stations	Length [km]	Trains	Carriages	Average Annual Ridership [million]
Line 3	25	11.66	48	5	87.6
Line 5	22	14.6	55	5	92.78
Line 9	33	19.6	73	5	119.89
Line 10	23	11.7	29	5	40.41
Line 12	29	15.27	45	5	72.1
Total	132	72.83	250	1250	412.78

FIGURE 37: TABLE OF PARIS LINES TO BE UPGRADED, KEY INDICATORS

Following the procedure, we divided the 4.157 billion RUB Paris upgrade budget by each of the total parameters and then multiplied by the Arbatsko-Pokrovskaya values to get a series of benchmarked budgets for the Moscow line.

Metro System	Per km	Per Train	Per Station	Per Carriage	Per riders	Average Budget
Paris	2.58	0.715	0.69	1	2,52	1.5

FIGURE 38: BENCHMARKED AVERAGE TRAIN AUTOMATION BUDGET (IN BILLIONS OF RUB) FOR EACH MEASURABLE PARAMETER FROM PARIS METRO SYSTEM UPGRADE

COPENHAGEN

Siemens signed a contract to upgrade the Copenhagen S-Train Commuter Rail network with its CBTC technology for a disclosed fee of €252 million (11.03 billion RUB). The measurable data with respect to the S-Train network are listed in the table below (Siemens clinches Copenhagen S-Train CBTC contract, 2011).

Line	Number of stations	Length [km]	Trains	Carriages
S-Train Network	85	170	135	1080

FIGURE 39: TABLE OF COPENHAGEN S-TRAIN NETWORK KEY INDICATORS

Our team performed the same benchmarking technique we used for Paris for the upgrades in Copenhagen. Calculations again involved dividing the 11.03 billion RUB budget by each Copenhagen parameter value and then multiplying by the Arbatsko-Pokrovskaya values from Figure X-1.

Metro System	Per km	Per Train	Per Station	Per Carriage	Average Budget
Copenhagen	2.92	3.52	2.86	3.03	3.1

FIGURE 40: BENCHMARKED AVERAGE TRAIN AUTOMATION BUDGET (IN BILLIONS OF RUB) FOR EACH MEASURABLE PARAMETER FROM COPENHAGEN S-TRAIN RAIL SYSTEM UPGRADE

LIMA

Bombardier were awarded a €16.15 million (0.706 billion RUB) contract to upgrade the Lima Metro Line 1 with their CITYFLO CBTC technology (Cityflo 650, 2013).

Line	Number of stations	Length [km]
Line 1	16	21.48

FIGURE 41: TABLE OF LIMA LINE 1 KEY INDICATORS

After performing the same benchmarking technique as in the previous cases, we calculated the following results with respect to the Arbatsko-Pokrovskaya Line.

Metro System	Per km	Per Station	Average Budget
Lima	1.48	0.973	1.2

FIGURE 42: BENCHMARKED AVERAGE TRAIN AUTOMATION BUDGET (IN BILLIONS OF RUB) FOR EACH MEASURABLE PARAMETER FROM THE LIMA LINE 1 UPGRADE

NEW YORK

Siemens signed a contract to upgrade the Canarsie (L) Line of the New York Subway with its CBTC technology for a disclosed fee of €239.32 million (10.47 billion RUB). The measurable data with respect to the Canarsie Line are listed in the table below (Canarsie CBTC goes live, 2009).

Line	Number of stations	Trains	Carriages
Canarsie (L)	24	272	1088

FIGURE 43: TABLE OF COPENHAGEN S-TRAIN NETWORK KEY INDICATORS

After performing the same benchmarking technique as in the previous cases, we calculated the following results with respect to the Arbatsko-Pokrovskaya Line.

Metro System	Per Train	Per Station	Per Carriage	Average Budget
New York	1.7	9.6	2.89	4.7

FIGURE 44: BENCHMARKED AVERAGE TRAIN AUTOMATION BUDGET (IN BILLIONS OF RUB) FOR EACH MEASURABLE PARAMETER FROM NEW YORK CANARSIE LINE UPGRADE

HONG KONG

Siemens also signed an €80 million (3.5 billion RUB) contract to upgrade the Hong Kong East Rail Line with their Trainguard MT CBTC technology (Siemens automates metro for Hongkong, 2012).

Line	Number of stations	Length [km]
East Rail	16	53

FIGURE 45: TABLE OF HONG KONG EAST RAIL KEY INDICATORS

After performing the same benchmarking technique as in the previous four cases, we calculated the following results with respect to the Arbatsko-Pokrovskaya Line.

Metro System	Per km	Per Station	Average Budget
Hong Kong	2.98	4.82	3.9

FIGURE 46: BENCHMARKED AVERAGE TRAIN AUTOMATION BUDGET (IN BILLIONS OF RUB) FOR EACH MEASURABLE PARAMETER FROM THE LIMA LINE 1 UPGRADE

Arbatsko-Pokrovskaya Results

As a result from all of the benchmarking calculations from the five cities, our team established an average budget of 2.62 billion RUB for automating the Arbatsko-Pokrovskaya line in Moscow.

AMOUNT OF SAVINGS

The total amount of savings is comprised of savings on energy, personnel, and maintenance. In order to calculate the savings on energy, we took into account the significant factors that relate to powering the trains on the Arbatsko-Pokrovskaya line. These included the cost of energy (per kWh), the energy savings potential (30%), energy usage, number of trains, daily hours and annual days of operation. The model yields annual savings on energy of 37 million RUB.

Similarly, we approached the calculation of Personnel (HR) savings by establishing the amount of people who serve the line. In order to calculate the savings, we estimated the costs without automation and then subtracted the costs with automation. Our model yielded annual HR savings of 145 million RUB.

Finally, we calculated the savings on maintenance through benchmarking according to a project carried out in the Glasgow Metro in Scotland. We compared both the Glasgow line to the Arbatsko-Pokrovskaya line, how much it cost, and the purchasing power parities (PPP) in national currency for Russia and the UK. As a result, we save as much as 141 million RUB per year.

Savings	
Energy (mRUB)	37
Human Resources (mRUB)	145
Maintenance (mRUB)	141
In total per year (mRUB):	323

FIGURE 47: SAVINGS TABLE

In conclusion, most of the train automation savings are from the reduction in personnel (HR Savings) and the reduction in need of maintenance, 145 million RUB and 141 million RUB respectively. Even though train automation has a high energy savings potential, its financial savings potential is relatively low due to the inexpensive cost of energy (0.9 RUB per kWh). About 11.5% of the total financial savings is the savings on electricity. The total savings per year according to the model is 323 million RUB.

SELF-FINANCED VS LOAN-FINANCED, IRR/NPV COMPARISON

As a result of all savings, we have calculated the Net Present Value (NPV) and the Internal Rate of Return (IRR) according to each scenario. In order to calculate Present Value, we must calculate Inflows and Outflows. Inflow is our savings, whereas outflow is our investment. The model itself features a one-time investment (2.62 billion RUB), so the Inflows-Outflows has a negative value only in year 0, as we have no benefits yet. Net Present Value is the sum of all Present Values, a future amount of money discounted to reflect current value. Our calculated self-financed NPV is about 2.8 billion RUB, while the IRR is 18.5%.

Self-financing (mRUB)	
NPV Self-financing (million RUB)	2,825
IRR	18.5%

FIGURE 48: SELF FINANCING SCENARIO

Since train automation requires a large investment, we decided to consider a loan from the European Bank for Reconstruction and Development (EBRD). We simulated taking a 20-year loan at a 10% interest rate. The loan repayment schedule is 5% yearly during the term of 20 years. Inflows would be the same as the inflows of the Self-financing scenario, yet the outflows would be the initial investment, the repayments, and the interest. The sum of all the Present Values, the NPV, is 370 million RUB, while the IRR is 11.9%.

Loan Scenario (mRUB)	
NPV Loan (million RUB)	370
IRR	11.9%

FIGURE 49: LOAN SCENARIO

Comparing the Self-financing and the Loan scenarios, we can clearly see the difference in values for the NPV and the IRR. By definition, we would always seek a higher rate of return (IRR), so we would recommend the Self-financing scenario (IRR 18.5%, compared to 11.9%).

The NPV Comparison graph is made so that we could visualize the advantage of Self-financing over the Loan scenario. Before the two lines merge, the blue line is always higher, which signifies the higher value of Self-financing over Loan.

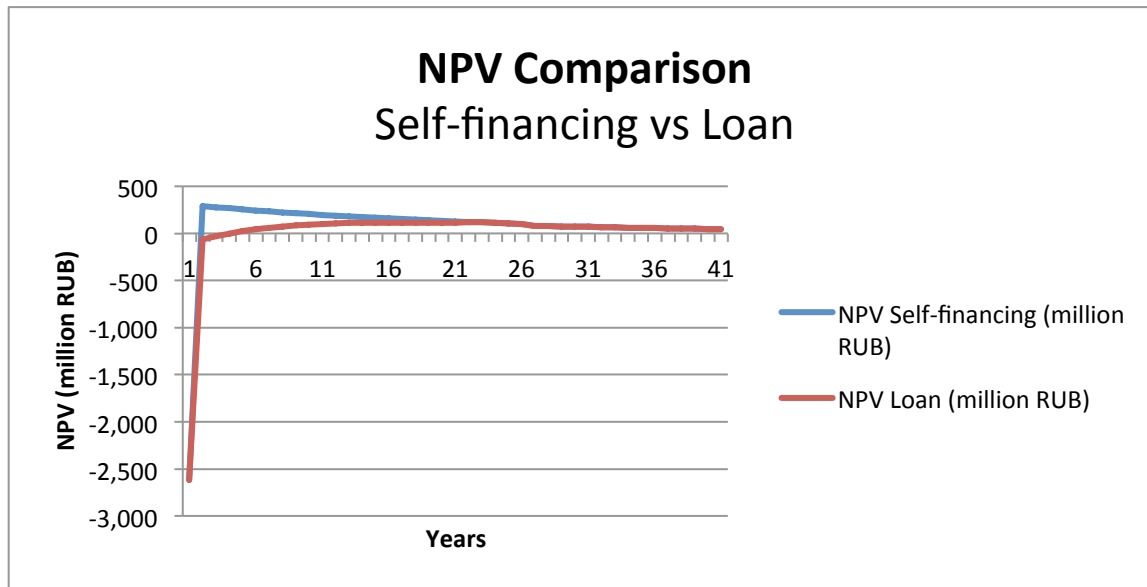

FIGURE 50: NPV COMPARISON

As a result, we recommend the Self-financing scenario.

Breakeven point

The breakeven point is the moment of time when the accumulated savings would equal the amount of initial investment (2.62 billion RUB). It is represented on the graph by the intersection of the Cumulative Savings curve and the Initial Investment line. According to the graph, it would take approximately 10 years for train automation to break even on its own.

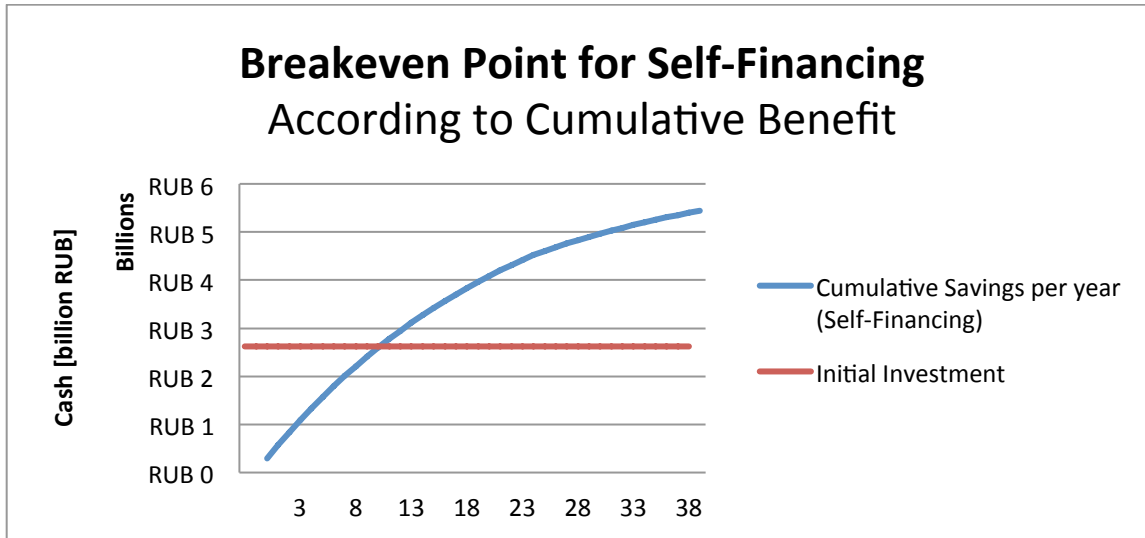

FIGURE 51: BREAKEVEN POINT FOR SELF FINANCING

CHAPTER 5: CONCLUSIONS AND RECOMMENDATIONS

	Energy Savings Potential	NPV (mlns of RUB)	IRR	Conclusion
Train Automation	40.3 million kWh per year	Self: 2,825	18.5%	Financially viable
		Loan: 370	11.9%	
Ultracapacitors	500,000 kWh per year per unit	Self: 8.85	27.7%	Financially viable
		Loan: 0.16	17.3%	
Kinetic Energy Harvesting				Financially unviable
Innowattech	10,000,000 kWh per year	Self: -92.29	N/A	
		Loan: -254.79		
Pavegen	Arbat: 1,242.3 kWh per year Entire: 10,600 kWh per year	Arbat: -40.6		
		Entire: -297.91		
Waydip	Arbat: 931.76 kWh per year Entire: 7,962.3 kWh per year	Arbat: -20.6		
		Entire: -176.1		

FIGURE 52: SUMMARY OF OUR RECOMMENDATION TO THE MOSCOW METRO

As a result of our research and financial modeling, we conclude that CBTC train automation and ultracapacitors for the regenerative brake are financially viable technologies and we recommend their implementation for energy-savings purposes. Kinetic energy harvesting however, is not financially justifiable, as it has a low energy-generating potential.

For all three different kinetic energy harvesting manufacturers, in each situation, and every type of financing, all of the financial models resulted in the kinetic energy harvesting part of project being deemed economically unviable. There are several possible explanations as to why this technology currently does not make financial sense. Currently, Pavegen, Waydip, and Innowattech tiles are just too expensive and only produce a small amount of energy. Due to the cheap subsidized cost of energy, the amount of electricity the technologies could generate in their lifetimes cannot pay for the product itself. On the other hand, train automation and Communications-Based Train Control (CBTC) technology is an expensive, yet highly energy-efficient technology. With energy savings up to 30%, train automation has already been put to use in more than 50 metro systems around the world. Automation requires a large initial investment for the contract and we benchmarked a 2.62 billion RUB cost for the contract for the Arbatsko-Pokrovskaya line. Even though there is a large energy savings potential, due to the cheap cost of energy, it is the savings on maintenance and salaries that contribute the most towards cost-effectiveness. The Siemens Sitras SES is also a proven and well-tested technology. It is easy to install, capable of saving significant amounts of electricity, and economically viable. Sitras SES meshes well with the Moscow Metro's future plans. It will not hinder the future plans to replace all of the Moscow Metro's rolling stock. In fact, its performance will be enhanced as older trains are replaced with newer ones capable of regenerative braking.

The large automation budget defines the need to avoid taking a loan, since the 10% interest would be an additional burden. Both the Self-financing and the Loan-financed scenarios proved to be financially viable, but due to the higher rate of return (18.5% versus 11.9%), we would recommend to the Metro authority to seek investors, rather than a loan. Achieving a fast breakeven point of about 10 years, train automation also saves about 323 million RUB each year

according to our model. Merely a tenth of the total savings however is the savings on energy. Similarly, all of the kinetic energy harvesting graphs consistently showed that each method had to overcome an enormous initial cost and then after five or so years, the incomes and expenditures became almost a net neutral. This trend is both a good and bad indicator. It demonstrates that the technology is not mature enough to be used *right now*. In a few years, the technology will become more cost-effective because the cost of the equipment will decrease and the amount of energy it can produce will increase. As can be seen in the summary chart, both the loan and self-financing scenarios for the ultracapacitors can produce a positive NPV demonstrating their financial viability. Compared to the other two technologies, ultracapacitors are the most lucrative option. We strongly advise the Moscow Metro to install at least one unit in a pilot project to test its potential. Based on the results of that trial and analysis by Siemens engineers, a full line installation can be made on a full line.

For the time being, the Moscow Metro should still invest in footfall-based kinetic energy recovery. Instead of installing tiles for an entire line, the Metro could put some in their new stations and some in the busiest station. This way, the Metro can see if energy harvesting concept works and then when the technology becomes cheaper, they can expand the project. Investing in the technology will help it develop faster and the Metro can act as the proof of concept. Kinetic energy harvesting has hidden potential. The Metro can unlock it. We also recommend implementing train automation along with the Siemens Trainguard MT CBTC and the Siemens Sitras SES ultracapacitor technology on the Arbatsko-Pokrovskaya line due to their high financial savings and positive energy conservation efforts.

WORKS CITED

- A Velocity-Time Graph [Image]. (n.d.). Retrieved from <http://revisionworld.co.uk/sites/default/files/imce/travelgraph2.gif>
- Barrero, T. R., & Van Mierlo, J. (2008). Improving energy efficiency in public transport: stationary supercapacitor based energy storage systems for a metro network. IEEE.
- BASE Energy inc. (2007). Energy Efficiency Assessment of Bay Area Rapid Transport (BART) Train Cars. San Francisco. Retrieved from <http://www.bart.gov/docs/BARTenergyreport.pdf>
- Bombardier. (2009). MITRAC Energy Saver. Retrieved from [bombardier.com: http://www.bombardier.com/content/dam/Websites/bombardiercom/supporting-documents/BT/Bombardier-Transport-ECO4-MITRAC_Energy_Saver-EN.pdf](http://www.bombardier.com/content/dam/Websites/bombardiercom/supporting-documents/BT/Bombardier-Transport-ECO4-MITRAC_Energy_Saver-EN.pdf)
- Bombardier to supply automatic driverless train control system to Delhi Metro Rail in India. (2013, September 16). International Railway Journal.
- Canarsie CBTC goes live. (2009, April). Railway Gazette International, 165(4), 17.
- Cityflo Signaling for Mass Transit [Image]. (n.d.). Retrieved from <http://www.raillynews.com/wp-content/uploads/CITYFLO.jpg>
- CITYFLO 650. (2013). Retrieved October 10, 2013, from <http://www.bombardier.com/en/transportation/products-services/rail-control-solutions/mass-transit-solutions/cityflo-650.html>
- Communications-Based Train Control (CBTC) Performance and Functional Requirements. (2004). In IEEE-Standards Association. IEEE.
- Danesh, W., Muktedir, N., Bhowmick, S., & Alam, S. (2011). A proposal for large-scale electricity generation from high-pressure applications using piezoelectric materials. International Journal of Science and Advanced Technology.
- Delhi Metro Rail Corp. (2013, May). Railway Age, 214(5), 8.
- Devaux, F.-O., & Tackoen, X. (2011, March). Overview of braking energy recovery technologies. Retrieved from [tickettokyoto.eu: http://www.tickettokyoto.eu/sites/default/files/download/file/T2K_WP2B_deliverable1_20110520.pdf](http://www.tickettokyoto.eu/sites/default/files/download/file/T2K_WP2B_deliverable1_20110520.pdf)
- Ecofriend. (2010, September 6). Wind Tunnel uses whooshing of subway trains to generate clean electricity. Retrieved from [ecofriend.com: http://www.ecofriend.com/wind-tunnel-uses-whooshing-of-subway-trains-to-generate-clean-electricity.html](http://www.ecofriend.com/wind-tunnel-uses-whooshing-of-subway-trains-to-generate-clean-electricity.html)
- Ederly-Azulay, D. L. (2009). Innovattech: Harvesting Energy and Data. Tel Aviv: Innovattech.
- Energy Floors. (2013, October 11th). Sustainable Dance Floor. Retrieved from [sustainabledanceclub.com: http://www.sustainabledanceclub.com/products/sustainable_dance_floor](http://www.sustainabledanceclub.com/products/sustainable_dance_floor)

- European Bank for Reconstruction and Development. (2012, December 18). Strategy for the Russian Federation. Retrieved from ebrd.com: <http://www.ebrd.com/downloads/country/strategy/russia.pdf>
- Flushing Line CBTC contracts. (2010, August). Railway Gazette International, 166(8), 18.
- Garthwaite, J. (2011). How ultracapacitors work (and why they fall short). Retrieved from [gigaom.com](http://gigaom.com/2011/07/12/how-ultracapacitors-work-and-why-they-fall-short/): <http://gigaom.com/2011/07/12/how-ultracapacitors-work-and-why-they-fall-short/>
- General Electric Company. (2013). How Electricity is Produced. Retrieved from [ge-flexibility.com](http://www.ge-flexibility.com/power-generation-basics/how-electricity-is-produced/index.html): <http://www.ge-flexibility.com/power-generation-basics/how-electricity-is-produced/index.html>
- Gerbis, N. (2009, December 9th). How Induction Cooktops Work. Retrieved from [howstuffworks.com](http://home.howstuffworks.com/induction-cooktops.htm): <http://home.howstuffworks.com/induction-cooktops.htm>
- Green, S. a. (2007). Aluminum Applications in the Rail Industry. Retrieved from [aluminum.org](http://www.aluminum.org/Content/NavigationMenu/TheIndustry/TransportationMarket/Rail/Skillinggrn nocover-1007.pdf): <http://www.aluminum.org/Content/NavigationMenu/TheIndustry/TransportationMarket/Rail/Skillinggrn nocover-1007.pdf>
- Harris, T. (2002, February 19). How Light Bulbs Work. Retrieved from [howstuffworks.com](http://home.howstuffworks.com/light-bulb.htm): <http://home.howstuffworks.com/light-bulb.htm>
- Harris, T. (2013, October 14). How Fluorescent Lights Work. Retrieved from [howstuffworks.com](http://home.howstuffworks.com/fluorescent-lamp.htm): <http://home.howstuffworks.com/fluorescent-lamp.htm>
- Harris, T., & Fenlon, W. (2002, January 31). How Light Emitting Diodes Work. Retrieved from [howstuffworks.com](http://electronics.howstuffworks.com/led.htm): <http://electronics.howstuffworks.com/led.htm>
- Hurst, J. (2007). New Technologies Provide Options for Making Escalators More Energy Efficient. Retrieved from [powerefficiency.com](http://www.powerefficiency.com/pdf/ElevatorWorldJan07.pdf): <http://www.powerefficiency.com/pdf/ElevatorWorldJan07.pdf>
- Innowattech. (2010, December 1st). Events. Retrieved from [innowattech.co.il](http://www.innowattech.co.il/events.aspx): <http://www.innowattech.co.il/events.aspx>
- Innowattech. (2013). About Innowattech. Retrieved from [innowattech.co.il](http://www.innowattech.co.il/about.aspx): <http://www.innowattech.co.il/about.aspx>
- Innowattech. (2013). Technical Information. Retrieved from [innowattech.co.il](http://www.innowattech.co.il/techInfo.aspx): <http://www.innowattech.co.il/techInfo.aspx>
- International Monetary Fund. (2012). Report for Selected Countries and Subjects. Retrieved from [imf.org](http://www.imf.org/external/pubs/ft/weo/2012/01/weodata/weorept.aspx?sy=2010&ey=2017&scsm=1&ssd=1&sort=country&ds=.&br=1&pr1.x=64&pr1.y=6&c=922&s=PCPI%2CPCPICH%2CPCPIE%2CPCPIEPC H&grp=0&a=): <http://www.imf.org/external/pubs/ft/weo/2012/01/weodata/weorept.aspx?sy=2010&ey=2017&scsm=1&ssd=1&sort=country&ds=.&br=1&pr1.x=64&pr1.y=6&c=922&s=PCPI%2CPCPICH%2CPCPIE%2CPCPIEPC H&grp=0&a=>
- Joshi, M. (2013). DU college harnesses wind energy churned out by Metro trains. Retrieved from [hindustantimes.com](http://www.hindustantimes.com/India-news/NewDelhi/DU-college-harnesses-wind-energy-churned-out-by-Metro-trains/Article1-1016873.aspx): <http://www.hindustantimes.com/India-news/NewDelhi/DU-college-harnesses-wind-energy-churned-out-by-Metro-trains/Article1-1016873.aspx>
- Kemball-Cook, L. (2013). About Us. Retrieved from [pavegen.com](http://www.pavegen.com/about): <http://www.pavegen.com/about>

- Levey, F. (2012). Mechanical behavior and testing methods for metals. Retrieved from britannica.com: <http://global.britannica.com/EBchecked/topic/371844/mechanical-energy>
- MacCurdy, D. (2010, October). Sitras Static Energy Storage (SES) System Demonstration Program. Retrieved from energy.ca.gov: <http://www.energy.ca.gov/2012publications/CEC-500-2012-068/CEC-500-2012-068.pdf>
- Macro Axis. (2013). AMS Public Return on Equity. Retrieved from macroaxis.com: http://www.macroaxis.com/invest/ratio/0077.HK--Return_On_Equity
- Metropolitan Transportation Authority. (2013). New York City Transit and the Environment. Retrieved from mta.info: http://web.mta.info/nyct/facts/ffenvironment.htm#sust_dev
- Metrowagonmash. (2011). Cars, Light Rail Model 81-740.4/741.4. Retrieved from metrowagonmash.ru: <http://www.metrowagonmash.ru/eng/production/metro/81-740-4/>
- Moscow Metro. (2007). Key Performance Indicators. Retrieved from mosmetro.ru: http://engl.mosmetro.ru/pages/page_0.php?id_page=99
- Moscow Metro. (2007). Moscow Metropolitan. Retrieved from mosmetro.ru: http://engl.mosmetro.ru/pages/page_0.php?id_page=2
- Moscow Metro. (2011). Annual Report. Moscow.
- Moscow Metro. (2012). O Metropolitene. Retrieved from mosmetro.ru: <http://mosmetro.ru/about/>
- Moscow Metro. (2012). Service Supply. Retrieved from mosmetro.ru: http://mosmetro.ru/about/structure/power_supply/
- Paris Awards CBTC Contracts. (2004, March). International Railway Journal, 44(3), 9.
- PI Ceramic. (2013). Piezo Materials Tutorial: The Piezoelectric Effect. Retrieved from piceramic.com: http://www.piceramic.com/piezo_effect.php
- Ridden, P. (2011, March 30). T-box concept to capture wind energy from trains. Retrieved from gizmag.com: <http://www.gizmag.com/tbox-concept-would-capture-wind-energy-from-speeding-trains/18272/>
- Schneuwly, A. (n.d.). Maxwell Technologies White Paper: Rail Power. Retrieved from maxwell.com: http://www.maxwell.com/products/ultracapacitors/docs/200904_whitepaper_railpower.pdf
- Searle, A. (2013, June 10). London Underground goes greener by signing up to 10:10 campaign. Retrieved from theguardian.com: <http://www.theguardian.com/environment/2010/jun/10/london-underground-signs-up-to-1010>
- Selleck, E. (2010). Green Pass Turnstile Harnesses Energy from Movement. Retrieved from slashgear.com: <http://www.slashgear.com/green-pass-turnstile-harnesses-energy-from-movement-08101384/>
- Siemens . (2004). Static Energy Storage Systems Based on Double Layer Capacitor Technology. Retrieved from uic.org: www.uic.org/download.php/environnement/Powerpoint-godbersen.pdf
- Siemens. (2011). Increasing energy efficiency. Erlangen.

- Siemens. (2012, April). Driverless Metro Paris. Retrieved from siemens.com: <http://www.siemens.com/press/pool/de/feature/2012/infrastructure-cities/mobility-logistics/2012-04-metro-paris/factsheet-driverless-metro-paris-en.pdf>
- Siemens. Siemens automates metro for Hongkong. (2012, December 21). Retrieved October 10, 2013, from Siemens Infrastructure & Cities Sector / Mobility and Logistics Division website: <http://www.siemens.com/press/en/pressrelease/?press=/en/pressrelease/2012/infrastructure-cities/mobility-logistics/icmol201212018.htm>
- Siemens. (2012). Sitras SES Stationary energy storage system for DC traction power supply. Retrieved from siemens.com: http://w3.siemens.com/smartgrid/global/en/products-systems-solutions/rail-electrification/dc-traction-power-supply/Documents/SES_PI_131_76.pdf
- Siemens clinches Copenhagen S-Train CBTC contract. (2011, September). International Railway Journal, 51(9), 14.
- St. Petersburg Metro. (2013). Information. Retrieved from metro.spb.ru: <http://www.metro.spb.ru>
- Stress-Strain Curve. (n.d.). Retrieved from <http://images.tutorvista.com/cms/images/38/stress-strain-curve.gif>
- Taipei metro opens Neihu Line. (2009, August). International Railway Journal, 49(8), 11.
- The Home Depot. (2013). Light Bulb Comparison. Retrieved from <http://ext.homedepot.com/shopping-tools/light-bulbs/bulbcomparison.html>
- The Home Depot. (2013). Lighting Basics. Retrieved from homedepot.com: <http://ext.homedepot.com/shopping-tools/light-bulbs/bulbcomparison.html>
- Trainguard MT CBTC. (n.d.). In Siemens Mobility. Retrieved October 10, 2013, from https://w3.siemens.dk/home/dk/dk/mobility/Signalsystemer/togkontrol/Documents/Trainguard_MT_CBTC_eng.pdf
- U-Oregon. (2013). Kinetic vs. Potential Energy. Retrieved from http://abyss.uoregon.edu/~js/images/KE_PE.gif
- US Department of Transportation. (2012). TriMet Pioneers Use of Double-Layer Capacitors for On-Board Energy Storage in Light-Rail Vehicles. Retrieved from http://static.squarespace.com/static/509bfe38e4b083e0792ed5ad/t/51487622e4b0d224b4438f84/1363703330218/TIGGER_OR-88-0001_TriMet_Portland.pdf
- Waydip. (2013). Waydip Project. Retrieved from waydip.com: http://www.waydip.com/waydip_project.php?id=10&idioma=en
- Westinghouse. (2011). Platform Screen Systems. Retrieved from platformscreeendoors.com: http://www.platformscreeendoors.com/media/documents/WPSD_Platform_Systems_2011.pdf
- www.uic.org/download.php/environnement/energy_EVENT.pdf. (2003, March). Evaluation of Energy Efficiency Technologies for Rolling Stock and Train Operation of Railways. Retrieved from uic.org: www.uic.org/download.php/environnement/energy_EVENT.pdf

APPENDICES

APPENDIX A: MAP OF THE MOSCOW METRO



APPENDIX B: MOSCOW METRO TRANSPORTATION AUTHORITY QUESTIONNAIRE

Questions for the Moscow Metro Transportation Authority

Rolling Stock

- Are you still planning on replacing your entire metro fleet with Metrowagonmash 81-740.4/741.4 (Rusich) and 81-760/761 by the year 2020?
 - If not, what is the new plan?
- How many trains do you plan to replace each year?

Regenerative Braking

- What are your past and future initiatives for regenerative braking?
- What regenerative braking systems do you use?
- How do you plan on using the regenerative braking capabilities of the new trains mentioned above?

Train Automation

- Which signaling methods are used on each line
- What are your past and future initiatives on automation of metro lines

Planned improvements

- What, if any, are the planned energy efficiency improvements to lighting, ventilation, and/or rolling stock?

Monthly and/or Annual Electrical Consumption (if actual numbers are not available give estimates)

Type of Consumption	Monetary Value [in Millions of RUB]	Energy [KWh]
Train Acceleration		
Train Movement		
Electric Utilities		
Total		

APPENDIX C: ABRIDGED PATENTS

PAVEGEN PATENT



US 20130068047A1

(19) **United States**(12) **Patent Application Publication** (10) **Pub. No.: US 2013/0068047 A1****Kemball-Cook et al.**(43) **Pub. Date: Mar. 21, 2013**(54) **ENERGY HARVESTING****Publication Classification**(76) Inventors: **Laurence Kemball-Cook, Kent (GB);**
Philip Tucker, Kent (GB)(51) **Int. Cl.**
F03G 7/08 (2006.01)
H02K 7/18 (2006.01)(21) Appl. No.: **13/642,093**(52) **U.S. Cl.**
CPC ... **F03G 7/08** (2013.01); **H02K 7/18** (2013.01)
USPC **74/25**(22) PCT Filed: **May 4, 2011**(86) PCT No.: **PCT/GB2011/000686**
§ 371 (c)(1),
(2), (4) Date: **Dec. 5, 2012**(57) **ABSTRACT**

The present application describes techniques for the harvesting of kinetic energy from the movement of people and/or vehicles. A motion converter is discussed which converts linear progression caused by traffic-related impulse forces, to be converted to rotational motion for driving the rotor of an electricity generator. An assembly for harvesting energy including the motion converter and a floor unit are also described.

(30) **Foreign Application Priority Data**

May 5, 2010 (GB) 1007497.9

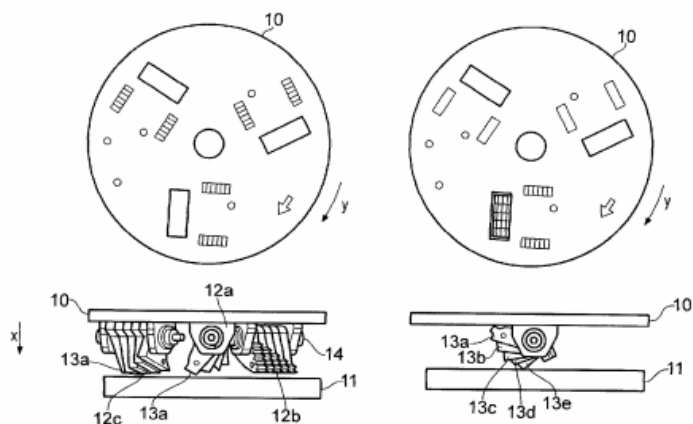

Retrieved from

<https://www.google.com/patents/US20130068047?dq=pavegen&ei=2MxTUpOcM8W_0QXnwICQDw&cl=en>

(12) INTERNATIONAL APPLICATION PUBLISHED UNDER THE PATENT COOPERATION TREATY (PCT)

(19) World Intellectual Property Organization
International Bureau(43) International Publication Date
24 November 2011 (24.11.2011)(10) International Publication Number
WO 2011/145057 A2(51) International Patent Classification:
F03G 7/08 (2006.01)(21) International Application Number:
PCT/IB2011/052164(22) International Filing Date:
17 May 2011 (17.05.2011)

(25) Filing Language: English

(26) Publication Language: English

(30) Priority Data:
105126 17 May 2010 (17.05.2010) PT(71) Applicant (for all designated States except US): WAY-
DIP - ENERGIA E AMBIENTE, LDA. [PT/PT];
Parkurbis, Parque da Ciência e Tecnologia da Covilhã,
P-6200-865 Covilhã (PT).

(72) Inventors; and

(75) Inventors/Applicants (for US only): ANASTÁCIO
DUARTE, Francisco João [PT/PT]; Quinta do Brejo,
Painel 90, C96, Peraboa, P-6200-591 Covilhã (PT). DIAS
AZEVEDO CASIMIRO, Filipe Emanuel [PT/PT]; Rua
Alfredo Bento Calado, N° 45, P-2080-701 Raposa (PT).(74) Agent: VIEIRA PEREIRA FERREIRA, Maria Sil-
vina; Clarke, Modet & Co., Rua Castilho, 50-9°,
P-1269-163 Lisboa (PT).(81) Designated States (unless otherwise indicated, for every
kind of national protection available): AE, AG, AL, AM,
AO, AT, AU, AZ, BA, BB, BG, BH, BR, BW, BY, BZ,
CA, CH, CL, CN, CO, CR, CU, CZ, DE, DK, DM, DO,
DZ, EC, EE, EG, ES, FI, GB, GD, GE, GH, GM, GT,
HN, HR, HU, ID, IL, IN, IS, JP, KE, KG, KM, KN, KP,
KR, KZ, LA, LC, LK, LR, LS, LT, LU, LY, MA, MD,
ME, MG, MK, MN, MW, MX, MY, MZ, NA, NG, NI,
NO, NZ, OM, PE, PG, PH, PL, PT, RO, RS, RU, SC, SD,
SE, SG, SK, SL, SM, ST, SV, SY, TH, TJ, TM, TN, TR,
TT, TZ, UA, UG, US, UZ, VC, VN, ZA, ZM, ZW.(84) Designated States (unless otherwise indicated, for every
kind of regional protection available): ARIPO (BW, GH,
GM, KE, LR, LS, MW, MZ, NA, SD, SL, SZ, TZ, UG,
ZM, ZW), Eurasian (AM, AZ, BY, KG, KZ, MD, RU, TJ,
TM), European (AL, AT, BE, BG, CH, CY, CZ, DE, DK,
EE, ES, FI, FR, GB, GR, HR, HU, IE, IS, IT, LT, LU,
LV, MC, MK, MT, NL, NO, PL, PT, RO, RS, SE, SI, SK,
SM, TR), OAPI (BF, BJ, CF, CG, CI, CM, GA, GN, GQ,
GW, ML, MR, NE, SN, TD, TG).

Published:

— without international search report and to be republished
upon receipt of that report (Rule 48.2(g))(54) Title: PAVEMENT MODULE FOR GENERATING ELECTRIC ENERGY FROM THE MOVEMENT OF PEOPLE AND
VEHICLES

Fig. 1

(57) Abstract: The present invention comprises a pavement module (1) for generating electric energy, with the movement of people and/or vehicles that move over it, causing a small substantially vertical displacement of the topmost surface (10) that actuates a mechanical gear system (2, 3, 4, 5), which is connected to the shaft of a generator (6), activating it to run at a speed that allows it to efficiently generate electric energy. The movement of people and/or vehicles on the pavement surface (10) actuates an arm (2) in an assembly (12, 13, 15) that actuates the gear system, converting the linear motion of the pavement surface into a rotational movement of the gear system (3). The pavement (1) also comprises on its base (9) resilient support elements (11, 14) of the surface (10), and means (7, 8) for ensuring a vertical motion of the surface (10) maintaining it substantially horizontal.

WO 2011/145057 A2

INNOWATTECH PATENT

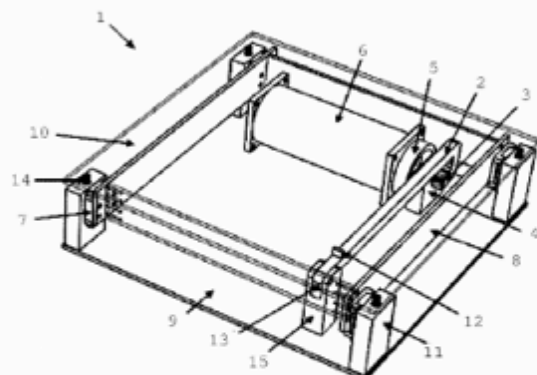

US007812508B2

(12) **United States Patent**
Abramovich et al. (10) **Patent No.:** **US 7,812,508 B2**
(45) **Date of Patent:** **Oct. 12, 2010**

(54) **POWER HARVESTING FROM RAILWAY; APPARATUS, SYSTEM AND METHOD**
(75) **Inventors:** **Haim Abramovich**, Nesher (IL); **Eugeny Harash**, Haifa (IL); **Charles Milgrom**, Moshav Aminadav (IL); **Uri Amit**, Raanana (IL); **Lucy Edery Azulay**, Haifa (IL)
(73) **Assignee:** **Innowattech Ltd.**, Haifa (IL)
(21) **Appl. No.:** **12/195,670**
(22) **Filed:** **Aug. 21, 2008**
(65) **Prior Publication Data**
US 2009/0195122 A1 Aug. 6, 2009
Related U.S. Application Data
(60) Provisional application No. 61/026,600, filed on Feb. 6, 2008.
(51) **Int. Cl.**
H02N 2/18 (2006.01)
(52) **U.S. Cl.** **310/339**
(58) **Field of Classification Search** **310/339**
See application file for complete search history.
(56) **References Cited**
U.S. PATENT DOCUMENTS
4,330,593 A * 5/1982 Shouat et al. 428-407
4,412,148 A * 10/1983 Klicker et al. 310-358
4,728,845 A * 3/1988 Haun et al. 310-358
5,065,058 A * 11/1991 Oakley 310-357

5,334,903 A * 8/1994 Smith 310/358
5,796,207 A * 8/1998 Safari et al. 310/358
5,818,149 A * 10/1998 Safari et al. 310/358
5,825,386 A * 10/1998 Ohashi 347-71
6,004,500 A * 12/1999 Safari et al. 264-610
6,262,517 B1 * 7/2001 Schmidt et al. 310/334
6,277,299 B1 * 8/2001 Seyid-Bolserforosh 252-62-9 R
7,112,267 B2 * 9/2006 Whatmore et al. 204-547
7,160,500 B2 * 1/2007 Park et al. 264-645
7,521,841 B2 * 4/2009 Clingman et al. 310/339
2008/0074002 A1 * 3/2008 Priya et al. 310/339
2009/0195124 A1 * 8/2009 Abramovich et al. 310/339

FOREIGN PATENT DOCUMENTS
JP 19073073 A * 3/1998
JP 2005353015 A * 12/2005
JP 2006197704 A * 7/2006
JP 2008019329 A * 1/2008
JP 2008099489 A * 4/2008

* cited by examiner
Primary Examiner—J. SanMartin
(74) *Attorney, Agent, or Firm*—William H. Dippert; Eckert Seamans Cherin & Mellott, LLC

(57) **ABSTRACT**
The present invention relates to an apparatus system and method for power harvesting from a railroads using piezo-electric generator. The invention is to provide a system and a method for power harvesting comprising a plurality of piezo-electric devices embedded in a railroad sleeper or attached to railroad rails and configured to produce electrical power when a train traverses their locations. The system includes a power conditioning unit and electrical conductors connecting said piezoelectric to said power conditioning unit. Harvested energy may be used locally in proximity to the energy generation location, stored for later use or transferred to be used in remote location.

25 Claims, 6 Drawing Sheets

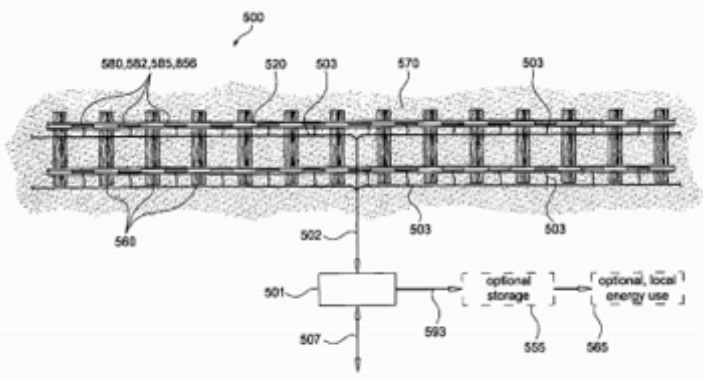

APPENDIX D: TERMS OF REFERENCE

Terms of Reference

Improving Energy Efficiency in Moscow City Metro

A. OBJECTIVES/PURPOSE OF ASSIGNMENT

BACKGROUND

Moscow Metro is the world's fourth most heavily used rapid transit system and one of the longest by passenger route length. Moscow City Metro is currently undergoing a large-scale modernization that includes replacement of obsolete rolling-stock with more technically modern one, construction of new interchange hubs, as well as improvement of resource efficiency of the subway facilities. Combined these initiatives will allow Moscow City Metro to become a modern and convenient transport system adequately meeting rising traffic demands of the rapidly growing economic heart of Russia.

To address these issues Moscow City Metro is currently drafting an energy efficiency program for the period until 2016 (hereafter referred to as "Program") that, among other aspects, implies:

1. Implementation of energy efficiency measures, namely:

- Introduction of regenerative braking for subway trains;
- Installment of energy efficient lighting system and start-control equipment;
- Installment of reduced-current start systems for tunnel ventilation with energy-saving options;
- Introduction of management information system for tunnel ventilation with power inverter.

2. Implementation of measures to reduce natural gas consumption

OBJECTIVE OF THE STUDY

The objective of this study is to identify the best available technologies and/or practices to reduce energy consumption and increase energy efficiency in Moscow City Metro facilities, and provide recommendations on how such technologies should be implemented. A special emphasis should be made to identify other energy efficiency options available than the measures set out in the Program (mentioned above).

B. SCOPE OF WORK

Stage I. Desk research (to be completed before the trip to Moscow)

The project team is expected to:

- Create a selection matrix for subway systems bench-marking;
- Collect data and select 5-6 (subject to discussion) subway systems which will be used in peer-review;

- Analyze short-listed subway systems with respect to energy efficient technologies and/or solutions used, including comprehensive statistic data (economic value, energy saving potential, environmental feasibility) for each of the analyzed solutions;
- Prepare an inception report/presentation of preliminary findings that would include the list of energy efficiency options available for application in Moscow Metro.

Stage II. Discussion of summary of findings (Ernst & Young office, Moscow)

The project team will:

- Prepare a presentation explaining why specific technologies and/or solutions were selected in terms of benefits and outcomes for Moscow Metro;
- Discuss the list of options with EY employees and identify options for the on-site research in Moscow Metro.

Stage III. On-site research (Department for Transport, Moscow)

The project team is expected to:

- Discuss project vision and expectations with representatives of Department for Transport;
- Prepare information request forms to obtain data required for in-depth analysis;
- Cooperate when necessary with employees of both Department for Transport and Moscow City Metro which would be involved in the project;
- Make use the data obtained to analyze potential (in terms of economic value, energy saving potential, environmental feasibility) of selected energy efficient technologies and/or solutions with respect to Moscow subway system future development;
- Prepare a report outlining major recommendations for Department of Transport on improving energy efficiency in Moscow subway containing methodology for technologies selection, estimations, and policy considerations.

Stage IV. Presentation of the project (Ernst & Young office / Financial University, Moscow)

The project team will:

- Present final results of the project

C. DELIVERABLES/ SPECIFIC OUTPUTS EXPECTED FROM PROJECT TEAM

Key deliverables relevant to the project:

- *Inception report/presentation* of best available technologies and/or practices in energy efficiency for selected subway systems;
- *Final report* documenting the findings of the study (containing methodology for technologies selection, estimations, main body, and policy considerations); it is preferable that the main body

of the report is relatively short (e.g., 20-30 pages – subject to discussion with EY Project Manager) with detailed information included in annexes. The final structure of the report should be decided jointly between the Project team and the EY Project Manager;

- *Power Point presentation of the results*; the presentation will be made at the EY office / Financial university in Moscow at a mutually convenient time to be agreed upon with the EY Project Manager and/or representative of Financial university.

SCHEDULE

Total duration of the assignment from commencement date (kick-off meeting at the EY office in Moscow): 10 weeks

- Submission of draft report: 6 weeks from the date of commencement
- Submission of final report: 4 weeks from the date of submission of the draft report

D. TIMELINE

To be decided jointly between the Project team and the EY Project Manager

E. SPECIAL TERMS & CONDITIONS

The Project team should demonstrate full-time commitment to the project (8 man hours per work day/ 40 man hours per week). Participation of students from Financial University is highly encouraged to make data collection and communication on a regular basis with employees of Department for Transport and Moscow Metro possible. The Project team is expected to rely on its own knowledge resources with limited assistance from EY.

F. ROLES ON THE PROJECT

Ivan Sokolov – EY Project Manager, Project team coordinator

Kliment Minchev - Mechanical Engineer with a Thermal-Fluids concentration and a minor in Finance (role to be specified)

Jacob Manning - Chemical Engineer with a Materials Science concentration (role to be specified)

Kevin Kell – Computer Engineer with Computer Science major (role to be specified)

XXX – Financial university representative (role to be specified)

XXX – Financial university representative (role to be specified)

XXX – Financial university representative (role to be specified)

G. Useful links

- <http://engl.mosmetro.ru/>
- <http://www.ase.org/efficiencynews/energy-efficient-subway-systems-world>
- http://www.delhimetrorail.com/press_reldetails.aspx?id=sis2IRmxNHhTwlld
- <http://web.mta.info/sustainability/pdf/2012Report.pdf>

<http://www.tfl.gov.uk/corporate/about-tfl/8127.aspx>

http://www.smrt.com.sg/Portals/0/PDFs/About%20SMRT/Investor%20Relations/Annual%20Report/2012_AR.PDF

H. LIMITATIONS ON SCOPE:

- Ernst & Young (hereafter referred to as “EY”) will assist in preparation of the Report and the Worcester Polytechnic Institute (hereafter referred to as “University”) will be the eventual owner of the Report.
- No legal or technical services have been budgeted by EY in this scope of work. In case of any requirement to seek legal or technical inputs, which will have to be sourced separately by the University.
- The views expressed in the report would reflect information furnished to University by Department for Transport. EY believes all of the information provided to University by Department for Transport would be reliable. EY will not verify the accuracy of any information provided by Department for Transport.
- EY will not verify the accuracy of any such information referenced from open sources/public domain for the said engagement provided by University.
- Wherever such open or secondary sources are used, University will be referencing such sources and the attempt will be to use sources that are of international repute and considered reliable in the industry. While conducting the assignment EY will not:
 - Act on behalf of management in reporting to the Board of Directors, or Audit Committee;
 - Determine which, if any, recommendations should be implemented;
 - Authorize, execute or consummate transactions or otherwise exercise authority on behalf of the Department for Transport;
 - Perform routine activities in connection with the Department for Transport’s operating or production processes;
 - Act in any capacity equivalent to a member of management or an employee.

Specific additional terms and conditions

Notwithstanding anything to the contrary in the Agreement or this SOW, EY does not assume any responsibility for any third-party products, programs or services, their performance or compliance with your specifications or otherwise.

Specific obligations and responsibilities

University has to make all administrative arrangements for working space (if required)at Department for Transport, conveyance, travelling, boarding and lodging required to perform the engagement; However EY will provide any reasonable assistance.