

# SUSTAINABLE ENERGY FOR EI YUNQUE NATIONAL FOREST

May 4<sup>th</sup>, 2010



**Submitted to:**

Professor Robert Kinicki  
Professor John Delorey

**In Cooperation With:**

Pedro Rios, Ecosystem Management and Forest Planning Team Leader

Kevin Arruda  
Steven Baldwin  
Alexander Quinn

# SUSTAINABLE ENERGY FOR EI YUNQUE NATIONAL FOREST

Interactive Qualifying Project completed in partial fulfillment  
of the Bachelor of Science degree at  
Worcester Polytechnic Institute, Worcester, MA

Submitted to:

Professor Robert Kinicki  
Professor John Delorey

In cooperation with:

Pedro Rios, Ecosystem Management Team Leader, USFS

Kevin Arruda \_\_\_\_\_

Steven Baldwin \_\_\_\_\_

Alexander Quinn \_\_\_\_\_

May 4<sup>th</sup>, 2010

\_\_\_\_\_  
Advisor Signature

\_\_\_\_\_  
Co-advisor Signature

## **ABSTRACT**

Puerto Rico's El Yunque National Forest faces problems with excessive energy use and high electricity prices, which reduce resources available for important land management projects. This project outlines and investigates alternative energy production and energy conservation techniques as both environmentally responsible and sustainable solutions to these problems. The project team investigated possible solutions by performing site analysis, estimating energy production, evaluating environmental impacts, and performing cost analysis. These investigations culminated in recommendations to the United States Forest Service that solar power, hydropower, and multiple conservation techniques be implemented in El Yunque National Forest to reduce annual electricity expenditures.

## ACKNOWLEDGMENTS

We would like to acknowledge our liaison for his kindness, and the guidance he offered throughout the project.

Pedro Rios, Ecosystem Management Team Leader

We would also like to acknowledge our project advisors for their support and insight throughout the project.

Professor John Delorey  
Professor Robert Kinicki

We are grateful to the following people for taking the time to help us with our project:

Bruce Drapeau, *Natural Resources Specialist/Fire Management*

Manuel Ortiz, *Property Management Team Leader*

Edgardo Martínez, *Forest Engineer*

Jaime Valentín, *Supervisory Forestry Technician*

Delia Gomez Jimenez, *Administrative Support Assistant*

Elba García, *Purchasing Agent*

Jose Ortega, *Recreation Manager*

Carolyn Krupp, *Special Uses/Lands Program Manager*

Orlando Carrasquillo, *Biology Technical Supervisor*

Carmelo Ortiz, *Federal Law Enforcement Officer*

Luz M. Cruz, *Secretary to Forest Supervisor*

## AUTHORSHIP

Kevin Arruda, Steven Baldwin, and Alexander Quinn contributed equally to the completion of this project proposal. Concentration was given to certain sections as follows:

\_\_\_\_\_Solar Power and Hydropower- Steven Baldwin

\_\_\_\_\_Wind Power and Conservation- Kevin Arruda

\_\_\_\_\_Alternative Fuels, Geothermal Power, and Air Conditioning- Alexander Quinn

All other sections were researched, written, and edited by all members of the group.

# TABLE OF CONTENTS

ABSTRACT .....	iii
AUTHORSHIP .....	v
TABLE OF CONTENTS.....	vi
LIST OF TABLES .....	viii
LIST OF EQUATIONS .....	ix
LIST OF FIGURES.....	x
EXECUTIVE SUMMARY .....	xi
CHAPTER 1: INTRODUCTION .....	1
CHAPTER 2: LITERATURE REVIEW .....	4
2.1 El Yunque National Forest .....	4
2.2 Traditional Power Methods .....	5
2.3 Conservation Techniques .....	6
2.3.1 Recycling, Reducing, Reusing .....	6
2.3.2 Appliances and Lighting .....	7
2.3.3 Water Pumps.....	9
2.3.4 Air Conditioning.....	10
2.3.5 Roof Coatings and Passive Solar Cooling .....	13
2.4 Solar Power .....	15
2.4.1 Photovoltaic (Solar) Electricity Generation .....	16
2.4.2 Solar Hot Water Systems .....	18
2.5 Hydropower .....	20
2.6 Geothermal Power .....	24
2.6.1 Geothermal Electric Plants .....	25
2.6.2 Direct Use Geothermal .....	26
2.7 Wind Power .....	29
2.8 Transportation and Alternative Fuels.....	33
2.8.1 Biodiesel Fuel .....	33
2.8.2 Hybrid Vehicles.....	34
2.9 Summary.....	35
CHAPTER 3: METHODOLOGY .....	36
3.1 Choosing Feasible Options.....	36
3.2 Evaluating Current Energy Usage .....	37
3.3 Site Analysis.....	37
3.3.1 Conservation Site Analysis.....	38
3.3.2 Solar Power Site Analysis.....	38
3.3.3 Estimate the Production of Solar Energy .....	39
3.3.4 Hydropower Site Analysis.....	39
3.3.5 Estimate the Production of Hydro-Electric Power .....	40
3.3.6 Geothermal Energy Site Analysis .....	40
3.4 Environmental Impacts.....	41

3.5 Cost Analysis .....	41
3.6 Conclusion .....	41
<b>CHAPTER 4: RESULTS AND ANALYSIS .....</b>	<b>42</b>
4.1 Current Energy Usage .....	42
4.2 Conservation Methods .....	44
4.2.1 Recycling, Reducing, Reusing .....	44
4.2.2 Appliances and Lighting .....	48
4.2.3 Water Feature Pump .....	54
4.2.3 Air Conditioning.....	56
4.2.4 Roof Coatings / Passive Solar Cooling.....	63
4.3 Solar Power .....	63
4.4 Hydropower .....	68
4.5 Geothermal Power .....	72
4.6 Summary.....	72
<b>CHAPTER 5: CONCLUSIONS AND RECOMMENDATIONS .....</b>	<b>73</b>
5.1 Conservation Methods .....	73
5.1.1 Recycling, Reducing, Reusing .....	73
5.1.2 Appliances and Lighting .....	74
5.1.3 Water Feature Pump .....	75
5.1.4 Air Conditioning.....	75
5.1.5 Roof Coatings / Passive Solar Cooling.....	76
5.2 Photovoltaic Electricity Generation.....	76
5.3 Hydropower .....	77
<b>REFERENCES.....</b>	<b>78</b>
<b>APPENDIX A: El Portal and Catalina Energy Audit Performed by Property Management Team Leader Manuel Ortiz.....</b>	<b>86</b>
<b>APPENDIX B: Solar Survey .....</b>	<b>109</b>
<b>APPENDIX C: Photovoltaic Equipment .....</b>	<b>110</b>
<b>APPENDIX D: Hydropower Equipment.....</b>	<b>111</b>
<b>APPENDIX E: Condenser Unit Product Data .....</b>	<b>112</b>
<b>APPENDIX F: Cost Analysis Tables and Graphs - Solar Power .....</b>	<b>114</b>
<b>APPENDIX G: Cost Analysis Tables and Graphs - Hydropower .....</b>	<b>119</b>
<b>APPENDIX H: Cost Analysis Tables and Graphs – Air Conditioning .....</b>	<b>124</b>
<b>APPENDIX I: Savings Analysis Graphs – Conservation Techniques .....</b>	<b>126</b>

## LIST OF TABLES

Table 2.1: Thermal Properties of Common Roofing Materials .....	14
Table 4.1: Comparison of the Annual Costs of Waste Management Strategies ....	47
Table 4.2: Energy Cost Associated with Various Refrigeration Temperature Settings .....	53
Table 4.3: Energy Cost Associated with Water Heater Options .....	54
Table 4.4: Energy Cost Associated with Various Water Feature Pumping Systems.....	56
Table 4.5(a): 2009 Summer Monthly Use Averages for El Portal and Catalina .....	57
Table 4.5(b): 2009 Winter Monthly Use Averages for El Portal and Catalina .....	57
Table 4.6: Energy Star Qualification Criteria .....	58
Table 4.7: Yearly Savings by Efficiency and Price/kWh.....	59
Table 4.8: Projected HVAC Expenditure Over 25-year Period at Varying Efficiency .....	60
Table 4.9: Payback Period for 48.88 kW Photovoltaic System at El Portal under Several Inflationary Models .....	67
Table 4.10: Payback Period for 48.88 kW Photovoltaic System the Catalina Service Center under Several Inflationary Models.....	68
Table 4.11: Payback Period for 396 W Hydro-Electric System at the Baño Grande Dam under Several Inflationary Models .....	71
Table 4.12: Payback Period for 283 W Hydro-Electric System at the Baño Grande Dam under Several Inflationary Models .....	71



## LIST OF EQUATIONS

Equation 2.1: Performance Coefficient .....	30
Equation 3.1: Annual Electricity Production of Photovoltaic Systems.....	39
Equation 3.2: Electricity Production of Micro Hydro-Electric Systems.....	40
Equation 4.1: Required Pump Power for Water Using Specified Units .....	55

## LIST OF FIGURES

<b>Figure 2.1: Centrifugal Pump Cross Section .....</b>	<b>9</b>
<b>Figure 2.2: Energy Efficiency Ratio vs. Unit Operation Time .....</b>	<b>11</b>
<b>Figure 2.3: Effects of Adding Insulating Materials on the R-Value of a Concrete Wall .....</b>	<b>13</b>
<b>Figure 2.4: Roof Top Sprinkler, Integrated Conductive and Evaporative Cooling.....</b>	<b>15</b>
<b>Figure 2.5: Grid Connected Photovoltaic System .....</b>	<b>17</b>
<b>Figure 2.6: 59 kW Photovoltaic System at Wayne National Forest Headquarters .....</b>	<b>17</b>
<b>Figure 2.7: 15 kW Photovoltaic System on Mona Island, Puerto Rico.....</b>	<b>18</b>
<b>Figure 2.8: Active, Closed Loop Solar Hot Water System .....</b>	<b>19</b>
<b>Figure 2.9: Large Comfort Station Solar Hot Water System at Buckhorn Campground.....</b>	<b>20</b>
<b>Figure 2.10: Typical Construction of a Run of the River Hydroelectric Power System.....</b>	<b>22</b>
<b>Figure 2.11: Normal Range of Operation by Turbine Type .....</b>	<b>24</b>
<b>Figure 2.12(a): Vertical Closed Loop Ground Source System .....</b>	<b>27</b>
<b>Figure 2.12(b): Horizontal Closed Loop Ground Source System.....</b>	<b>27</b>
<b>Figure 2.13: Two Well Open Loop Ground Source System .....</b>	<b>28</b>
<b>Figure 2.14: Schematic of Curry Village Ground Source Heat Recovery System.....</b>	<b>29</b>
<b>Figure 2.15: Vertical and Horizontal Axis Wind Turbines .....</b>	<b>30</b>
<b>Figure 3.1: Example of Puerto Rico Wind Map .....</b>	<b>36</b>
<b>Figure 4.1(a): Monthly Electricity Usage September 2006-January 2010 .....</b>	<b>42</b>
<b>Figure 4.1(b): Monthly Electricity Expenditure September 2006-January 2010.....</b>	<b>43</b>
<b>Figure 4.1(c): Cost per kWh (PREPA) 2006-January 2010 .....</b>	<b>43</b>
<b>Figure 4.2(a): Waste Receptacle in El Portal Filled with Recyclable Material .....</b>	<b>45</b>
<b>Figure 4.2(b): Refreshment Stand in El Portal Sells Drinks without the Option of Recycling Their Containers .....</b>	<b>45</b>
<b>Figure 4.3: Recycling and Waste Facility at Yuquiyu Delights Restaurant.....</b>	<b>48</b>
<b>Figure 4.4: Possible Lighting Reduction Plan at Palo Colorado Recreation Area Shop .....</b>	<b>51</b>
<b>Figure 4.5: Thermometer Inside of a Drink Refrigerator in El Portal Gift Shop .....</b>	<b>52</b>
<b>Figure 4.6: Proposed Solar Power Sites at El Portal.....</b>	<b>64</b>
<b>Figure 4.7: Proposed Solar Power Site at the Catalina Service Center .....</b>	<b>65</b>
<b>Figure 4.8: Baño Grande Dam at the Palo Colorado Recreation Area.....</b>	<b>69</b>

## EXECUTIVE SUMMARY

El Yunque National Forest is a global model of tropical land management operated by the United States Forest Service. El Yunque is a popular destination for both tourists and residents of Puerto Rico, offering an educational visitor center, hiking trails, and breathtaking views to over 1.2 million visitors every year (U.S. Forest Service, 2009). As a center for ecological research, the Forest is as much a center for science and education as it is for recreation.

The Forest faces a serious issue; electricity in Puerto Rico is expensive, inconsistently priced, and generated by non-sustainable means. About 98% of Puerto Rico's electricity is produced by burning fossil fuels, which is damaging to the environment and contributes to fluctuations in cost (Energy Information Administration, 2010). Excessive energy use throughout the Forest coupled with inconsistencies in cost has created a concern to address sustainability.

The goal of this project was to research and recommend actions to reduce the amount of funding expended on operational costs in El Yunque by utilizing conservation techniques and natural renewable resources present in the Forest. Reducing the Forest's energy consumption helps to establish a green and sustainable infrastructure, and add to the environmentally conscious image of El Yunque National Forest. Money conserved through implementing the proposed strategies can be used to fund important projects concerning land and resource management.

The tropical rainforest setting presents a unique challenge in terms of utilizing traditional alternative energy solutions. The Forest's location necessitates the consideration of possibly damaging weather patterns such as hurricanes and flooding. Case studies were reviewed to determine the effects similar weather patterns have had on of alternative energy sources elsewhere. When possible, studies concerning National Reserves and Parks as well as places with a climate similar to El Yunque's were considered.

To determine the energy needs of El Yunque, an analysis was performed on the past energy consumption throughout the Forest. Trends and patterns in electricity use were found by examining El Yunque's utility bills and records. Trends included regular seasonal fluctuations in energy use, and also showed the results of previous energy conservation efforts. Knowledge of the total amount of energy consumption facilitated the assessment of the impact of each potential solution.

The project team worked to determine the viability of introducing certain conservation techniques and alternative energy production methods to El Yunque by conducting an analysis of each option. These options included various conservation techniques, wind power, solar power, hydropower, geothermal energy, and alternative fuels, each of which was researched to identify possible advantages and disadvantages of its implementation. Environmental impacts, responsible land management, social impacts, and sustainability played a dominating role in the selection process. These factors are very important to the Forest Service, whose first priority is the conservation of El Yunque's wildlife, resources, and natural beauty.

Site analysis was performed for each conservation technique and alternative energy source. For conservation methods, this included walkthroughs of the Forest's buildings that aimed to identify unnecessary uses of energy. Many problems in the current situation were identified, including wasted electricity in lighting, inefficient air conditioning, wasteful refrigeration practices, and unnecessary waste management expenditures. Observations were made throughout the forest to find where alternative energy sources could be most beneficial. Performing these analyses led to the conclusion that not all of the initially considered solutions would be usable in El Yunque. It was decided to further investigate the most promising solutions; conservation, solar power, and hydropower.

The team further investigated these solutions by identifying, and evaluating possible sites to implement the viable alternative energy technologies and conservation methods. Sites that would produce maximum output with minimal construction were located for both photovoltaic and hydroelectric power generation. To study the possible use of conservation methods, the team observed the current conditions and researched case studies concerning the implementation of various conservation techniques.

The project concluded with recommendations made to the United States Forest Service in El Yunque National Forest. The team recommended that various conservation techniques, solar power, and hydropower be used to reduce the Forest's dependence on expensive grid-supplied electricity. These recommendations included a cost analysis for each solution. The Forest Service was provided with evaluated payback periods and a range of potential monetary and electrical savings from each solution, which depend on the inflationary behavior of future fossil fuel prices. Implementation of the recommended solutions should greatly reduce the energy expenses

observed by El Yunque National Forest, while making it a greener and more sustainable tourist attraction in Puerto Rico.

## CHAPTER 1: INTRODUCTION

The global community's dependence on coal, oil, and natural gas as primary energy sources has created concerns surrounding the issues of financial instability of energy costs and the environmental consequences of burning fossil fuels. This has created a growing demand and appreciation for alternative energy. In the United States, 85% of all energy consumed is provided by fossil fuels. This accounts for about two thirds of the electricity produced, and nearly all of the transportation fuels used in one year (Department of Energy, 2010). Data collected by the United States Energy Information Administration (EIA) on the average cost of fuel throughout the world shows extreme inconsistencies over the past five years, and a general upward trend in the price per barrel of crude oil over the past ten years. Burning these carbon-based fuels results in environmental issues that include the contamination of soil, air and water (Energy Information Administration, 2010). As these issues concerning sustainability continue to grow, it is becoming clear that changes must be made in the way we live and generate energy.

Sustainable and renewable energy sources exist and are being implemented around the globe to address the aforementioned issues. Such renewable sources of energy include wind power, solar power, geothermal power, hydroelectric power, and biodiesel fuel, all of which have been more commonly classified as alternative energy. These alternative sources convert renewable resources into useful forms of energy. After an initial investment and the costs of maintenance, energy that is produced by alternative methods is not affected by the fluctuating costs of non-renewable fuels. As result, energy produced by alternative sources is generated at a more financially stable rate than energy produced by conventional means. Furthermore, these alternative energy sources yield far fewer harmful byproducts than conventional methods of generating energy. Harmful byproducts include green house gasses, and according to the U.S. Department of Energy (DOE) the "rising level of [greenhouse] gases contributes to global climate change, which contributes to major environmental and human health issues" (National Renewable Energy Laboratory, 2009). For these reasons, alternative energy sources are a sustainable solution for areas dependent on nonrenewable, carbon-based fuel sources.

Puerto Rico has limited traditional fuel resources, which has caused a reliance on foreign oil as its primary energy resource; accounting for over 98% of Puerto Rico's energy production

(Energy Information Administration, 2010). Due to this dependence and the fluctuating price of oil, almost all of the energy produced on the island is not only non-sustainable but also expensive and inconsistently priced.

El Yunque National Forest is faced with the problem of supplying power to its 28,000 acre infrastructure that includes office buildings, vehicles, recreation areas, communication outposts, and research centers. El Yunque Forest currently depends on the Puerto Rico's electrical grid and its own backup diesel electric generators to produce electricity. The Forest's dependence on high priced energy reduces the funds available for natural resource management and creates concerns for its sustainability. The El Yunque Forest staff is exploring techniques to reduce the cost of operating the Forest's facilities and create a more sustainable system in which the land and resources of the reserve are managed responsibly.

El Yunque National Forest is the only tropical rainforest operated by the United States Forest Service. The rainforest setting is subject to conditions that make many energy solutions difficult to implement. Conditions include about 200 inches of rain every year and regular flooding and hurricane seasons, all of which must be considered when integrating alternative energy sources. Windmills and solar panels may be damaged by floods and hurricanes, and consistent rain can reduce the amount of solar radiation to be collected. Because of these difficulties the information, ideas, and technologies that prove applicable in El Yunque will be of great value to tropical rainforests and reserves worldwide with similar problems.

El Yunque is a worldwide model of tropical land management. The Reserve offers tours, hiking trails, and environmental education to its 1.2 million visitors per year (U.S. Forest Service, 2009). El Yunque is also part of the United Nations Man and Biosphere Program, a collection of reserves around the world,

“which innovate and demonstrate approaches to conservation and sustainable development. They ... share their experience and ideas nationally, regionally and internationally within the World Network of Biosphere Reserves”  
(United Nations Educational, Scientific and Cultural Organization, 2010).

The Forest Service would like El Yunque to be an example of responsible land management and conservation not only to visitors, but also to other parks around the world. Thus it is important that the Forest has a responsible and sustainable energy program. Not only is sustainability vital to the survival of the rainforest, but the responsible use of resources and land

also affects the worldwide image of the Forest, Puerto Rico, and the United States Forest Service.

This project researched and outlined recent developments in alternative energy and conservation solutions. Solutions that appeared to be feasible and potentially beneficial were further investigated as a means to increase sustainability with regards to energy in El Yunque National Forest. This investigation included site research and analysis, and concluded with an estimate of energy production and cost analysis to determine the feasibility and of integrating alternative energy and conservation technologies into the existing infrastructure in the El Yunque National Forest. Using this information, the most effective solutions were determined and presented to the sponsor in a set of recommendations.



## CHAPTER 2: LITERATURE REVIEW

This chapter is a compilation of current research literature and relevant topics in the field of alternative energy sources. It summarizes the processes and requirements of the energy sources and conservation methods investigated in this project. It also reviews pertinent case studies in which the outlined alternative energies and conservation techniques have been implemented. Case studies dealing with national parks and tropical climates were reviewed for their relevance to the project.

### 2.1 El Yunque National Forest

El Yunque National Forest is a 28,000 acre section of the Luquillo Mountain Range in northeastern Puerto Rico, operated by the United States Forest Service. The Forest's main facilities include recreation sites, hiking trails, administrative offices, and a visitor center. The two main buildings in El Yunque are El Portal (the visitor center) and the Catalina Service Center, which is the ranger station and administrative building. These two buildings are at the entrance to the Forest on U.S. Highway 191. Visitors can choose to visit El Portal for a fee of \$4.00 per person, or drive further up the road to the recreation sites and trails.

El Portal is a large open air building with educational exhibits, a gift shop, a cafeteria, and a theater. Below the first floor (closed to the public) is office space used by El Portal administrative staff. The Catalina Service Center is a two story building that houses the administrative offices for Ecosystems Management, Property Management, Forest Planning and Administration, and Law Enforcement divisions of the Forest staff.

Recreation sites, parking areas, and food stands are spread along the visitor portion of Highway 191 past El Portal. Hiking trails branch off into the Forest from these recreation sites and lead to different attractions and destinations. Visitors drive their own cars to whichever recreation site or trail they choose, and can park along the road to hike or enjoy the view. This type of tourism in El Yunque is free.

Some refreshment stands operated by the Forest are located near recreation sites along the road. Other restaurants on the road are privately owned and operated on land leased from the Forest, as are the communication sites atop "El Yunque Peak". There are also research centers in the Forest inhabited by students and researchers which are sponsored by the University of Puerto Rico.

The Forest experiences high electricity prices along with excessive energy use, which drives up the price of powering the Forest's infrastructure. Other expenditures include park maintenance and waste removal fees. The Forest Service is financially responsible for electricity use in El Portal, the Catalina Service Center, at recreation sites, and at water pumps that deliver water to the buildings. A reduction of expenses in any of these areas is desired so that funds can be allotted for other projects.

## **2.2 Traditional Power Methods**

Traditionally, electrical energy is generated in facilities that use fossil fuel as an initial source of energy. Heat energy released by burning coal or oil is transferred to a water boiler to make steam that is forced through a turbine, transferring the heat energy into mechanical work. The steam turbine is connected to an electrical generator that converts the mechanical work into electrical energy, which is then wired into an electrical grid for distribution. This method of generating electricity is convenient because fossil fuels are readily available and power plants are able to produce a large amount of energy. The concern with this method is that the convenience comes at an environmental cost (Beer, 2008).

The combustion of fossil fuel releases many harmful vapors into the atmosphere; including the oxides of nitrogen and sulfur, carbon dioxide (CO<sub>2</sub>), methane (CH<sub>4</sub>), and nitrous oxide (N<sub>2</sub>O), which are collectively referred to as green house gasses. When these fuels burn, the resultant gases are released directly into the atmosphere where they continually collect along with other greenhouse gases. Sulfur and carbon oxides contribute to acid rain and contaminate air and rainwater, while other gases contribute to global warming (Environmental Protection Agency, 2010).

Global warming is attributed in part to the presence of greenhouse gases in the upper atmosphere that allow light and solar radiation to pass through them into the earth's atmosphere, but not back out. The radiation reflected off the surface of the earth becomes trapped by greenhouse gasses on its way out of the atmosphere. It is likely that the increased concentration of greenhouse gases in the atmosphere contributes to global temperature and weather changes. However the EPA (Environmental Protection Agency) states, "these features of the climate also vary naturally, so determining what fraction of climate changes are due to natural variability versus human activities is challenging" (Environmental Protection Agency, 2010).

Puerto Rico currently produces electricity using six petroleum-fired power plants, one coal fired power plant, one natural gas powered plant, and six hydro-electric plants. The fossil fuel plants accounted for 99.4% of the overall electrical production on the island in 2007. The Puerto Rico Electrical Power Authority (PREPA) plans to begin producing 20% of its electricity using alternative energy sources by 2015 (Energy Information Administration, 2010). It is evident that Puerto Rico has issues and concerns with sustainability that its agencies are working to rectify.

## **2.3 Conservation Techniques**

Conserving energy by analyzing and streamlining existing infrastructure is one of the most cost effective and easiest methods to lower energy costs. Reducing, reusing, recycling, implementing passive energy systems, using efficient appliances and lighting, using green roofing, and following efficient building codes are all effective ways to conserve energy, and reduce overall cost. Many of these methods are easy to implement and see immediate results.

### **2.3.1 Recycling, Reducing, Reusing**

The amount of solid waste that the average American generates in a day has nearly doubled in the last 50 years. One way to address this issue is to discard or use fewer items. There are many economic and environmental advantages that come from reducing the amount of waste generated and reusing the materials that need not be thrown away. Not only is less money spent purchasing materials, but money is also saved by reducing the amount of solid waste to be disposed. The U.S. Environmental Protection Agency (EPA) website states that “source reduction also conserves resources and reduces pollution, including greenhouse gases that contribute to global warming” (Environmental Protection Agency, 2009). Even though every facility will generate some amount of waste, it can be kept to a minimum by discarding only materials that cannot be reused or recycled.

Recycling is the act of taking material that would have otherwise been incinerated or thrown into a landfill, and reprocessing it into another useful form. Using recycled material can save money by reducing the energy costs of processing virgin materials. Businesses can also produce extra income by selling recyclables back to a recycling center. Recycling this way can both reduce waste removal costs and create an additional source of income. Recycling includes not only glass and plastics but organic materials as well. Organic waste such as food scraps and

yard trimmings can be composted and later re-used, again cutting down on volume of wasted materials and reducing costs (Environmental Protection Agency, 2009).

Yosemite National Park uses a park-wide recycling system that collects glass, plastic, paper, and aluminum. Recycling containers are readily available for guest use, and employees use compostable packing peanuts, re-use shipping containers, and environmentally friendly water based cleaning products. Sustainability is always considered when purchasing products to be used throughout the Park, from environmentally friendly paper products to carpeting made from recycled plastics. Yosemite is also in the process of moving toward an entirely paperless office, installing waterless bathroom facilities, and encouraging employees to carpool. Yosemite has partnered with a local waste management company to construct a composting facility, where organic waste is separated from the rest and composted (National Park Service, 2010).

### **2.3.2 Appliances and Lighting**

Appliances and lighting systems that are out of date can consume far more energy than those that use more modern technology. The U.S. government has implemented a rating system called Energy Star to help consumers purchase more environmentally friendly appliances. The Energy Star tag appears on appliances that meet efficiency requirements established by the Department of Energy (DOE) and the EPA. Rebates may be offered as an incentive to consumers who replace existing appliances with Energy Star appliances. There are currently many modern lighting options available to suit any need, including compact fluorescent lamps (CFL's), straight tube fluorescent, tungsten halogen, and light emitting diode. Although the initial purchase of most of these options is significantly more expensive than standard incandescent lighting, the more efficient options require less energy to produce more light and offer significantly longer bulb life (Department of Energy, 2010).

Traditional electric hot water heaters have a storage tank with an electric heating element inside that keeps water at a temperature set by the user. When hot water is turned on in a sink or shower, the heated water flows from the tank to the fixture that is being used. As the hot water leaves the tank, the tank is refilled with cold water. Once the cold water brings the temperature of the tank water below a set temperature, the heating element turns on to heat it back to the set temperature. With a traditional water heater, water in the tank is kept hot 24 hours a day; which means that electricity is used to maintain the set water temperature even when it is not being used.

A tankless electric water heater, also known as an on demand electric water heater, only heats the water as it flows through the unit. This means that when hot water is turned on, cold water flows into the heater and through an electrical heating element to the fixture where it is being used. Because electricity is consumed only when a fixture requiring hot water is turned on, tankless water heaters use less electricity than traditional heaters.

Yosemite National Park has planned a lighting retrofit that is expected to yield a 30% reduction in the cost of lighting throughout the Park. The plan mainly consists of replacing existing incandescent lighting with CFL, installing motion sensors on lighting systems, and placing programmable thermostats on heating and cooling devices. As a part of the master plan, Park managers “select new equipment based in part on energy efficiency, using ‘Energy Star’ products for heating ... and appliances. [Additionally] an energy-saving variable drive pump motor is also used for the sewer lift station” (National Park Service, 2010). These considerations made by the National Park Service and Yosemite’s management have created both a more sustainable business model and an environmentally friendly image that visitors and employees constantly observe (National Park Service, 2010).

A study performed by the Pacific Northwest Laboratory for the DOE considered the effects of occupancy sensors on the amount of wasted light energy within the Hanford contractor facilities. Researchers found that a setting between two and three minutes was optimal to reduce the time that lighting was used in un-occupied areas. A reduction of up to 36% of total wasted lighting throughout the building was achieved. Areas such as copying rooms, mailrooms, individual offices, conference rooms, and kitchen areas recorded the highest energy savings. The total payback period for implementing motion sensors throughout the Hanford facility was under two years (Dittmer, Keller & Richman, 1994).

Employees of the Pacific Gas and Electric Company performed an assessment of the effects of retrofitting existing lighting fixtures with efficient bi-level LED luminaries from BetaLED and motion sensors in a supermarket parking lot. Each motion sensor was programmed to leave the bi-level luminaries on a low power setting until motion was detected. When a motion sensor on an individual pole was triggered, the light on that pole would switch to the high power setting until no motion was detected again for five minutes. The study reported an energy savings of 70% and a payback period of 4.7 years (Johnson, Cook, Shackelford, and Pang, 2010).

In an article by *Home Energy Magazine*, an investigation was performed evaluating the effects of refrigerator thermostat settings on energy consumption. The article compared refrigerator testing performed by the DOE, with refrigerator testing performed by *Consumer Reports*. Both experiments were identical, except that *Consumer Reports* used temperature settings that were five degrees (Fahrenheit) lower than the temperatures used in the DOE testing. As a result the refrigerators tested by the DOE consumed an average of 18% less energy than those in the *Consumer Reports* test (Meier, 1994). This study shows that increasing refrigeration temperatures is a potential energy saving technique, provided that health risks are not created.

### 2.3.3 Water Pumps

According to a North Dakota State University report, the most common type of pump used to move fluids through a piping system is the centrifugal pump. Figure 2.1 is a cross section of a typical centrifugal pump. Fluid that moves through the inlet (called the suction line) is then forced through the discharge line of the pump by an impeller. An impeller is a rotary device with backward swept blades designed to intake a fluid at one point of its rotation, accelerate it, and finally release it into a discharge line. In most cases an electric motor drives the impeller. The energy required to operate a pump is dependent on the head of the system, the desired flow rate, the densities of the fluid being moved, and the efficiencies of the pump and the electric motor (Scherer, 1993).

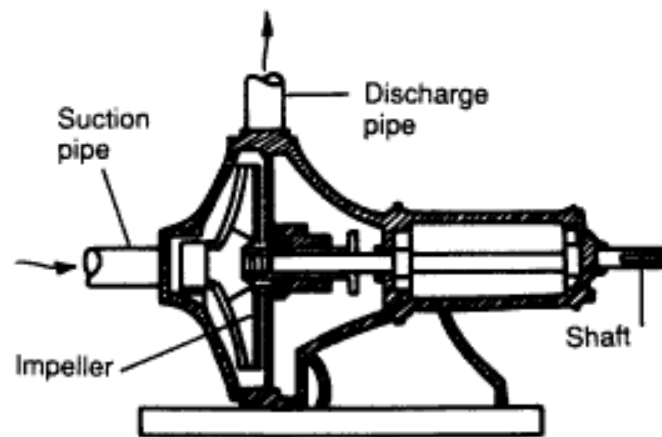

Figure 2.1: Centrifugal Pump Cross Section (Scherer, 1993)

The head of a pump system is a number that quantifies the overall resistance to the desired flow of the system. Two main factors that contribute to the head are the vertical distance between the lowest point of the water in a system and the surface of the water reservoir, and the

resistance to flow within the piping system. Factors that determine the head of a system include the length of the system, its valves, and the diameter of the pipe. The total head of a system can be calculated by adding the distance between highest and lowest point of water in a system to the sum of the contributions of each determining factor of the system, in feet of head (Money Saver Pumps, 2009).

A centrifugal pump needs to be primed before it starts, meaning that there must be fluid throughout the discharge pipe, the impeller, and the suction pipe. Unless the pump is located at the low point of the fluid system it is operating, fluid will drain to the low point through the suction pipe. The air voids in the pipe created by this draining will not allow the pump to start and run effectively. For this reason most centrifugal pumps need to have a manual or automatic priming function built into their design to be effective (Scherer, 1993).

### **2.3.4 Air Conditioning**

Cooling interior building space comes at a high energy cost, especially in hot climates. One solution is to replace outdated air conditioning units with new and efficient Energy Star units. Air conditioners come with a seasonal energy efficiency ratio (SEER), and an energy efficiency ratio (EER) rating. A unit's SEER rating refers to the number of British thermal units (BTU's) of heat energy that the air conditioner removes in a typical cooling season, divided by the total energy expended in that same time period, in watt-hours. An EER refers to the number of BTU's of heat energy that the air conditioner is able to remove per watt-hour of energy expended (AHRI, 2008). As of 2006 it has been illegal to manufacture and install air conditioning units with a SEER rating of below 13. New air conditioning units require 20-40% less electric energy than their predecessors to produce the same amount of cool air (Department of Energy, 2009). Though these units can save a lot of money in electricity bills, they are often expensive to purchase and install.

It is important that air conditioning units are appropriately sized for the spaces they are intended to cool. Modern air conditioning systems are designed to effectively handle a specific cooling load, and if a system is not matched properly to the cooling needs of a building, the efficiency of that system will be greatly reduced. An oversized system will waste electricity by cooling the desired space too quickly, creating a problem called short cycling. When an air conditioning unit short cycles, it is running for short periods of time (under 10 minutes), turning on and shutting off many times each day. Many people think it desirable to cool a space as

quickly as possible, but an oversized system can be very energy inefficient compared to one that has been properly sized (Environmental Protection Agency, 2000).

It takes a unit about 10 minutes of operation to reach its maximum efficiency. Short cycling prevents a unit from reaching this efficiency level, and as result the unit uses excessive amounts of energy (Environmental Protection Agency, 2000). A condenser draws higher amperage when it begins operation, because the compressor fan inside a condenser requires more electric energy to begin rotating than it does during continuous operation. The “locked rotor amps” (LRA) is the amount of electric current a compressor fan draws under starting conditions. This amount is much larger than a unit’s maximum “rated load amps” (RLA) that is drawn during regular operation (AHRI, 2008). A unit draws this higher LRA every time it is turned on, so short periods of operation will draw the full LRA more often. Thus, a short cycling condenser uses much more electricity than it would in regular operation. Figure 2.2 below shows that efficiency can improve by 17% just by increasing a unit’s operating time from 5 minutes to 9 minutes (Environmental Protection Agency, 2000).

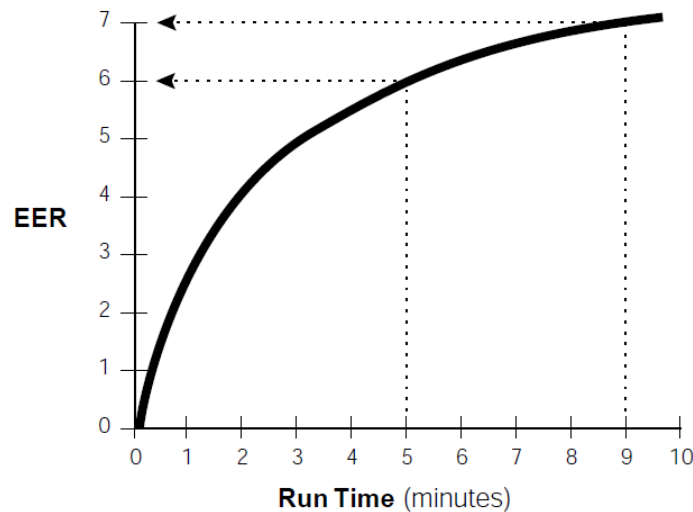

**Figure 2.2: Energy Efficiency Ratio vs. Unit Operation Time (Environmental Protection Agency, 2000)**

A second consequence of short cycling is the loss of dehumidification. If a condenser does not run long enough to reach its desired operating temperature, moisture will not condense on the evaporator coils. If moisture is not allowed to condense it cannot be drawn from the air, and the space to be air conditioned will remain humid. This causes discomfort or the necessity of separate dehumidifying units, which will further increase electricity use. In addition to poor



performance, short cycling can also result in high maintenance costs by shortening the life of a conditioning unit by starting and stopping it more often than necessary. By eliminating short cycling, properly sized air conditioning systems cool and dehumidify a space more efficiently than oversized systems, and also run quieter and have a longer life with lower maintenance expenses (Environmental Protection Agency, 2000).

Inverter air conditioning units are a solution to the short cycling problem. An inverter unit is capable of cooling at variable power (i.e. it doesn't always run at maximum capacity). Inverter systems are ductless split-systems, meaning that the condenser sends coolant straight to an evaporator that is mounted in the room to be cooled. The condenser is electronically controlled to cool a space just enough to keep it at a desired temperature. Controlled in this manner, the inverter unit will deliver just enough cooling power for extended periods of time, and avoid the high energy use that results from the excessive start ups of an oversized, non-inverting system (Florida Solar Energy Center, 2002).

Other factors in the effectiveness of air conditioning systems include duct systems, insulation, and unit pairing. Efficiency ratios for a condenser unit often vary by the evaporator with which they are paired. A matched pair of condenser and evaporator units will be more effective in terms of energy use and cooling than a random pair. Product data for condenser units often list different efficiency ratios depending on the paired evaporator model.

Creating a usage plan is another effective approach to ensuring that both new and old air conditioning units are consuming the least amount of energy possible. Different thermostat settings can make a significant difference in cooling efficiency. The "automatic" setting on air conditioner thermostats only runs the unit's fan during a cooling cycle (which typically makes up about half of a unit's operating time). The "on" setting runs the fan continuously, meaning that warm air is moved into the building for the other half of the operating time, making cooling less efficient. Raising the temperature on the thermostat will effectively save energy. For each degree Fahrenheit above 78, cooling costs will be reduced by as much as 10%. Air conditioning costs can also be lowered by using ceiling fans, which can make a room feel 4°F cooler. Ceiling fans are very inexpensive to operate in comparison to air conditioning units (Progress Energy, 2010).

Ensuring that doors and windows are sealed and that a building is properly insulated will help to keep cool air in and hot air out. The degree to which a wall, window, door, floor, ceiling, or roof is insulated is quantified by an R-value. An object's R-value is a measure of its resistance

to heat flow. Buildings that have insulation with high R-values lose less wanted heat energy from inside and gain less unwanted heat energy from the outside. Figure 2.3 shows a number of options that can be used to improve the R-value of a concrete wall (McMichael, 2010).

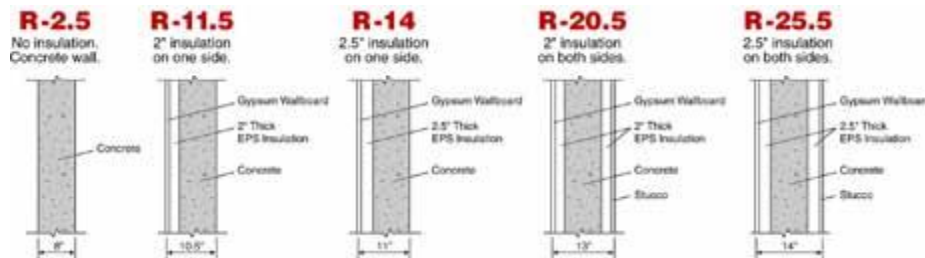

**Figure 2.3: Effects of Adding Insulating Materials to the R-Value of a Concrete Wall (McMichael, 2010)**

### 2.3.5 Roof Coatings and Passive Solar Cooling

There are other measures that can be taken to prevent the transmission of unwanted heat energy. Awnings and landscaping can be used to block direct sunlight from striking windows, preventing solar temperature gain. Passive cooling systems reduce cooling costs in buildings as well. Passive energy collection systems use the design of a building to absorb wanted heat energy or reflect un-wanted heat energy (Department of Energy, 2010). Roofing material also influences the interior temperature of the building by controlling the roof surface temperature, and the ambient temperature of the air in the attic.

A study performed by the Florida Solar Energy Center concluded that white roofing materials greatly reduced the attic air temperature within test buildings, and therefore lowered the overall cooling costs (Parker & Sherwin, 1998). A bright white ceramic elastomeric coating painted or sprayed on an existing roof surface can yield a solar reflectance of 80%. This means that the roof is only absorbing 20% of the light energy to which it is exposed. A typical black asphalt roof has a solar reflectance of only 5%, meaning that the black asphalt roof system absorbs 95% of the light energy that it is exposed to in the form of heat. Table 2.1 lists the solar reflectance and expected roof surface temperature over the ambient air temperature for common roofing materials.

Material	Solar Reflectance (%)	Temperature of Roof over Air Temperature (°F)
Bright white coating (ceramic, elastomeric) on smooth surface	80%	15°
White membrane	70%-80%	15°-25°
White metal	60%-70%	25°-36°
Bright white coating (ceramic, elastomeric) on rough surface	60%	36°
Bright aluminum coating	55%	51°
Premium white shingle	35%	60°
Generic white shingle	25%	70°
Light brown/gray shingle	20%	75°
Dark red tile	18%-33%	62°-77°
Dark shingle	8%-19%	76°-87°
Black shingle or materials	5%	90°

**Table 2.1: Thermal Properties of Common Roofing Materials (Home Energy Magazine, 1997)**

Another advantage of white roofing is that it typically lasts longer than darker roofing. White roofing lasts longer because it absorbs less solar energy, and therefore expands and contracts less over the course of each day. Smaller oscillations in size increases the number of heat cycles a roof can experience before material failure (Home Energy Magazine, 1997).

In extreme cases where solar reflectance does not adequately lower the roof temperature, semi-passive cooling can be used. Evaporative cooling is a semi-passive method that works well to cool interior spaces in the most severe climates. An effective evaporative cooling method works by pumping a small amount of water over the surface of a roof. As the water runs down the hot roof, it begins to evaporate. The evaporation of water requires a great amount of heat energy that would have otherwise been absorbed by the roof system. For almost every climate and condition there are passive cooling and heating systems that reduce energy costs (Western Solar Utilization Network, 2010). A diagram of a passive solar cooling system is shown in Figure 2.4.

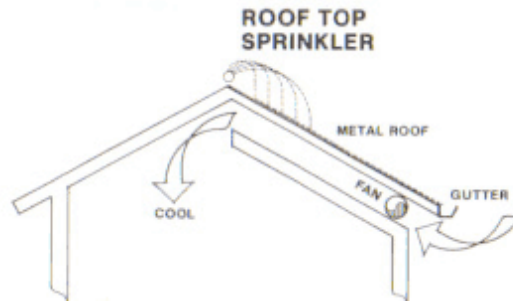

**Figure 2.4: Roof Top Sprinkler, Integrated Conductive and Evaporative Cooling (Western Solar Utilization Network, 2010)**

A lodge in the Sukau rainforest, located in Sabah Malaysia, has successfully used passive cooling to cut energy costs and improve public image. Passive solar techniques in the Sukau rainforest lodge have eliminated the need for air conditioners in guest rooms (Sukau Rainforest Lodge, 2008). As a result, the lodge advertises itself as a desirable destination for tourists concerned with ecotourism.

Green roofing can decrease temperatures in and around buildings in urban settings (Miller, 2009). In urban areas, thermal energy from the sun is absorbed in rooftops, streets, and sidewalks, rather than being absorbed and consumed by vegetation. This causes a substantial increase in temperature at street level and within buildings in these areas, which produces higher cooling costs. A green roof is a kind of rooftop garden of plants and trees that reduce this “Urban Heat Island Effect” by absorbing the sun’s energy. However, the facilities in El Yunque National Forest are already surrounded by an entire rainforest with vegetation that is consuming the sun’s thermal energy. Therefore, the conservation benefits of adding a green roof on buildings in El Yunque would be negligible compared to the effects of adding a green roof in an urban area (Environmental Protection Agency, 2009).

## **2.4 Solar Power**

Solar power can be used to generate energy in the form of electricity or heat without producing harmful byproducts or greenhouse gases. There are a variety of methods for harnessing the sun’s energy that depend on the solar radiation available. According to 30 years of solar radiation data collected by the National Renewable Energy Laboratory (NREL), the city of San Juan receives an average 5.5 kWh/m<sup>2</sup>/day (a measure of energy per unit area per day) for flat plate collectors, such as solar panels, at fixed latitude tilt (National Renewable Energy

Laboratory, 1990). These data show potential for sustainable solar energy applications in El Yunque National Forest even though El Yunque receives 50 to 250 inches of rain annually depending on the specific location (U.S. Forest Service, 2008). This study considers photovoltaic (solar) electricity generation and solar hot water systems applied to El Yunque's energy needs.

#### **2.4.1 Photovoltaic (Solar) Electricity Generation**

Photovoltaic cells utilize the photoelectric effect, the process by which electrons are emitted from semiconductor materials when exposed to sunlight, to convert sunlight into electrical current. Solar cells are constructed from thin layers of semiconductor material (such as silicon) that is polarized by a special treatment of foreign elements, creating a positively charged side and a negatively charged side. When exposed to sunlight, electrons are knocked loose from the atoms of the semiconductor material. The polarity of the semiconductor material causes the electrons to flow from the negative side to the positive side of the solar cell, creating a direct (DC) electric current (Corkish, 2004; Knier, 2010).

There are three common types of photovoltaic cells: monocrystalline, polycrystalline, and amorphous thin film. Monocrystalline cells have the highest efficiency, are the most expensive, and are frequently used in micro applications with very limited space because they can produce the most electricity per unit area. Polycrystalline cells have a slightly lower efficiency and lower cost than monocrystalline cells, and are generally used in small to medium sized applications. Amorphous thin film cells have the lowest efficiency, operate best in very hot climates, and require the largest amount of space (Gemmell, 2009).

Photovoltaic systems are constructed using arrays of solar cells, which can be either connected to an electrical grid or configured as standalone systems. Standalone photovoltaic systems are used primarily in areas without nearby access to an electrical grid. In addition to the solar cells, a standalone system in Puerto Rico requires an inverter to convert the direct current (DC) to alternating current (AC) as well as a battery to store the electricity generated. Standalone photovoltaic modules are also used in conjunction with diesel generators in hybrid photovoltaic systems to insure energy requirements are met regardless of the availability of sunlight. Grid connected photovoltaic systems require an inverter to convert the direct current (DC) to alternating current (AC), but are connected to the local electrical grid rather than a battery. With this system unused electricity is sold back to the power company, while additional electricity can be purchased from the power company at times of high demand if it is needed (International

Energy Agency, 2010). Although photovoltaic systems require a large initial investment, they call for essentially no reinvestment and little maintenance aside from standard cleaning. A typical construction of an electric grid connected photovoltaic system is shown in Figure. 2.5.

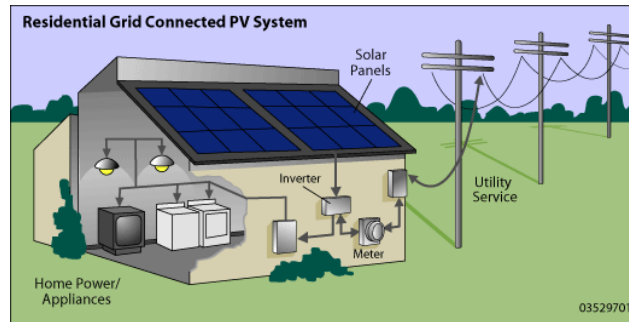

**Figure 2.5: Grid Connected Photovoltaic System (Department of Energy, 2009)**

Wayne National Forest in southeastern Ohio has been using photovoltaic solar power to provide electricity to its headquarters building since 2007. The original system consisted of 20 photovoltaic panels and cost \$33,000. In 2008, the system was expanded to 50 panels for an additional \$35,000. The 50-panel system satisfied about 7% of the building's electricity demand during peak production months. In 2009, Wayne National Forest was granted \$7.2 million under the American Recovery and Reinvestment Act. \$398,000 of this fund was used to expand the headquarters' photovoltaic system to 302 panels for a total capacity of 59 kW, as shown in Figure 2.6.



**Figure 2.6: 59 kW Photovoltaic System at Wayne National Forest Headquarters (Sound, 2010)**

According to Wayne National Forest Engineer Steve Marchi, the system is expected to reduce electricity costs by \$5,000 to \$7,000 annually at a rate of \$0.09 per kWh (Madsen, 2009).

Considering that Puerto Rico has higher electricity prices and receives more solar radiation than Ohio, a similar photovoltaic system in El Yunque could save a significant amount of money annually and bring more sustainability to the region.

On Mona Island, Puerto Rico, there is a small settlement consisting of a museum, several barracks, a rangers' office, and a communications building. Until 1997 energy had been supplied to these facilities by means of a diesel generator grid. Seven standalone photovoltaic systems with a combined capacity of 23.5 kW were integrated into these facilities in 1997 to fully replace the diesel generator grid and provide a cleaner, more sustainable source of electricity. An aerial image of the 15 kW photovoltaic system used on Mona Island to power the museum is shown in Figure 2.7 (Bing, 1998).



**Figure 2.7: 15 kW Photovoltaic System on Mona Island, Puerto Rico (Bing, 1998)**

In 1998, Mona Island was struck by Hurricane Georges, which was a Category four hurricane, meaning that it had persistent wind speeds between 131 mph and 155 mph (National Weather Service, 2009). Only two of the seven photovoltaic systems on Mona Island sustained damage due to the hurricane, and one had sustained damage due to poor placement and improper installation (Deering & Thornton, 1999). This case provides evidence that not only can photovoltaic systems provide a sustainable source of energy in a tropical environment, but they can also withstand severe tropical weather conditions.

#### **2.4.2 Solar Hot Water Systems**

A solar hot water system consists of tank or storage unit and a solar collector (usually a flat plate solar collector). A flat plate solar collector is a box containing a system of small pipes that carry a fluid covered by a translucent cover. The sun heats the fluid, which is then circulated

through an insulated tank; heating the water inside. Solar hot water systems normally require a pump to circulate fluid throughout the system, though they can also circulate the fluid using gravity. These systems require minor maintenance throughout their lifetime that consists mainly of replacement of the electronic components (such as the pump), and plumbing repairs related to leaky or broken pipes. A typical construction of an active, pump operated solar hot water system is shown in Figure 2.8 (National Renewable Energy Laboratory, 2009; Department of Energy, 2009).

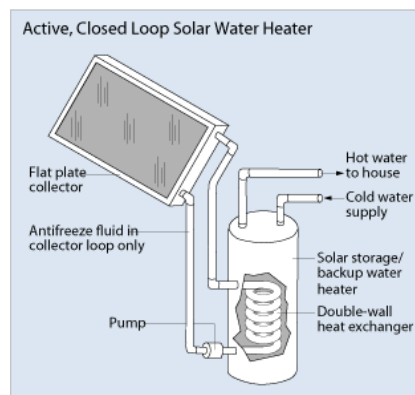

**Figure 2.8: Active, Closed Loop Solar Hot Water System (Department of Energy, 2009)**

In 1998, the National Park Service installed three solar hot water heating systems at Buckhorn Campground in Oklahoma's Chickasaw National Recreation Area. The three systems supply all of the hot water to three comfort stations, which provide Chickasaw visitors and employees with hot showers. Two of the systems produce 9,394 kWh per year, and are capable of providing 660 gallons of water per day at 95°F. These small systems cost \$18,000 and have a projected payback period of nine years. The third system produces 18,194 kWh per year and is capable of providing 1500 gallons of water per day at 105°F. This larger system cost \$24,000 and has a projected payback period of eight years. Each of the systems has a savings to investment ratio of at least 2:1 (Department of Energy, 1999). The large comfort station solar hot water system at Buckhorn Campground is shown in Figure 2.9.





**Figure 2.9: Large Comfort Station Solar Hot Water System at Buckhorn Campground  
(National Renewable Energy Laboratory, 1998)**

The National Park Service has had success with solar hot water systems at Buckhorn Campground. This case gives promise that similar success with solar hot water systems could be achieved in El Yunque in providing hot water to the U.S. Forest Service's facilities.

Barbados has taken advantage of solar hot water systems more than any other Caribbean nation. Between 1974 and 1992, a total of 23,388 solar hot water systems were installed in Barbados. In 1992, aggregate energy savings for solar hot water systems in Barbados was approximately 75 million kWh for a total monetary savings of approximately \$9.75 million USD (United States dollars) at \$0.13 USD per kWh, a savings of approximately \$416 USD per system. In terms of foreign oil use, the 23,000 solar hot water systems in place in Barbados saved approximately 188,000 barrels of oil in 1992 (Headley, 1997). Foreign oil and electricity prices have increased rapidly over the past 20 years in Puerto Rico and the rest of the Caribbean region. Therefore, solar hot water systems could save significantly more money per system annually in El Yunque today than was saved in Barbados in 1992, while bringing more sustainability to the region.

## **2.5 Hydropower**

Hydropower systems can produce mechanical or electrical energy (Gulliver & Arndt, 2004). This energy generation comes from a renewable source that will remain sustainable as long as the river providing the power does not dry up. Hydropower generation emits no harmful byproducts and greenhouse gases, making it a favorable alternative to burning fossil fuels.

Because hydroelectric power systems exist in many different sizes, the United States Department of Energy classifies hydroelectric power systems by their electrical capabilities. Under this classification scheme, large hydroelectric power systems have a capability of over 30 MW of power, while small hydroelectric power systems have a capability of 100kW to 30MW. Hydroelectric power systems having a capability less than 100 kW are known as micro hydroelectric power systems (Department of Energy, 2005).

There are three major types of hydroelectric power generation, the most common type being an impoundment hydroelectric power plant. An impoundment plant dams a river to create a reservoir of water, which is released through the dam to rotate turbines. The turbines are connected to a generator that produces electricity (Department of Energy, 2005). However, impoundment hydroelectric power plants usually have severe ecological and environmental effects. These types of power plants can prevent migratory fish from travelling upstream, while fish and other organisms travelling downstream can be pulled into the dam's intake and forced through the turbine, causing them physical injury or death. Impoundment hydroelectric water plants also severely alter the flow of water in a river. Water in the reservoir may become stagnant or inert, causing undesirable growth of algae and preventing important nutrients from flowing downstream. This leads to chemical imbalances in the water and malnourishment of aquatic plants and animals in areas downstream from the dam (Brookshier, 2004; Cada, Sale & Dauble, 2004).

The ecological and environmental consequences of impoundment hydroelectric power plants can be reduced at the expense of electrical output by adding passages for fish to travel through both upstream and downstream, and providing a means for a sufficient amount of water to flow to areas downstream to maintain the health of aquatic animals and plant life. However, these methods are not completely effective and require a significant amount of monitoring and maintenance that makes them less sustainable techniques (Cada, Sale & Dauble, 2004). In a National Forest Reserve such as El Yunque, impoundment hydroelectric power plants may not be an appropriate means of electricity generation due to the ecological and environmental consequences associated with them.

The second type of hydroelectric generation is by use of a diversion hydroelectric power plant. Diversion hydroelectric power plants can be constructed using one of two techniques. The first type of diversion hydroelectric power plant is constructed by channeling off a section of a

river and damming it, rather than damming the entire width of the river. The water in the channel is guided through one or more turbines connected to generators, which are turned to produce electricity (Department of Energy, 2005). Because this type of diversion hydroelectric power plant alters the flow of the river to a certain extent, it has similar environmental and ecological consequences as impoundment hydroelectric power plants but to a lesser degree. The second type of diversion hydroelectric power is a run of the river hydroelectric system, which is used mostly in micro hydroelectric systems. Run of the river of hydroelectric power systems simply divert water from a location upstream through a pipeline or penstock and a turbine, which is connected to a generator, back into the river at a location downstream. A typical construction of a run of the river hydroelectric power system is shown below in Figure 2.10 (Department of Energy, 2009).

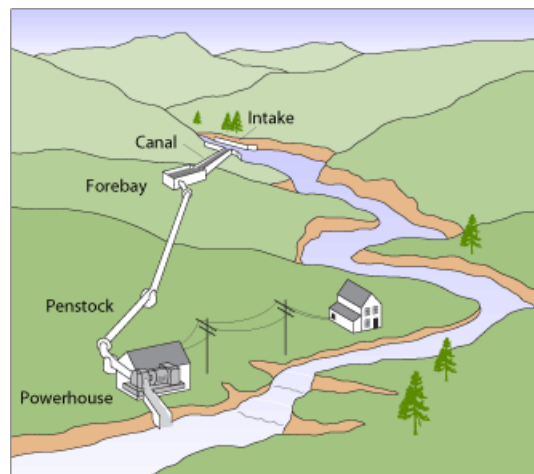

**Figure 2.10: Typical Construction of a Run of the River Hydroelectric Power System (Department of Energy, 2009)**

Because run of the river hydroelectric power systems do not require a dam to be constructed on the river, they do not prohibit the movement of fish and other organisms within the river, nor do they severely alter the flow of the river unless too much water is diverted out of it. Therefore if constructed correctly, the environmental and ecological impacts are negligible compared to those of impounded hydroelectric power plants (Egré & Milewski, 2002). In a National Forest Reserve such as El Yunque, run of the river hydroelectric systems may be the most appropriate means of electricity generation as the negative environmental effects associated with them are limited.

The power production of a run of the river hydroelectric power system is primarily a function of the natural head (change in elevation) times flow rate at a given location. Therefore, significant power can be produced from locations with one of the following; a high head (which is considered a minimum of ten feet) and high flow rate, high head and low flow rate, or low head and high flow rate. Locations with less than 10 feet of head require a very large flow rate and usually involve a unique design (Appalachian State University, 2007).

Because El Yunque National Forest has a mountainous topography, this study considers high natural head run of the river hydropower systems. High head run of the river systems usually use impulse turbines, which are suspended in the air while water is guided through a nozzle to the turbines using the pressure created by the head. The nozzle can be adjusted to allow control over the flow through the turbine if the flow in the river fluctuates. There are three common types of impulse turbines: the Pelton wheel turbine, the Turgo turbine, and the cross-flow turbine (Department of Energy, 2005). These turbines are usually classified by their effective range in head.

- The Pelton wheel turbine is designed for applications with high head and a low flow rate. The Pelton wheel turbine has spoon shaped blades oriented around a wheel that catch water from a nozzle. A Pelton wheel turbine operates best at locations with a head ranging between 150 – 5000 feet (St. Onge Environmental Engineering, 2010).
- The Turgo turbine is designed for applications with slightly lower head than Pelton wheel. Turgo turbines use blades shaped similar to that of a jet engine turbine oriented around a wheel. A Turgo turbine operates best at locations with a head ranging between 50 – 750 feet (St. Onge Environmental Engineering, 2010).
- A cross-flow or Banki – Michell turbine is designed for applications with low head and varying flow rates. A cross-flow turbine is very similar to a traditional water wheel, but uses slightly curved blades that catch water from a rectangular shaped nozzle. Cross-flow turbines operate best at locations with a head ranging between 9 – 750 feet (St. Onge Environmental Engineering, 2010).

Figure 2.11 can be used as a guide in turbine selection based on the available head and flow rate.

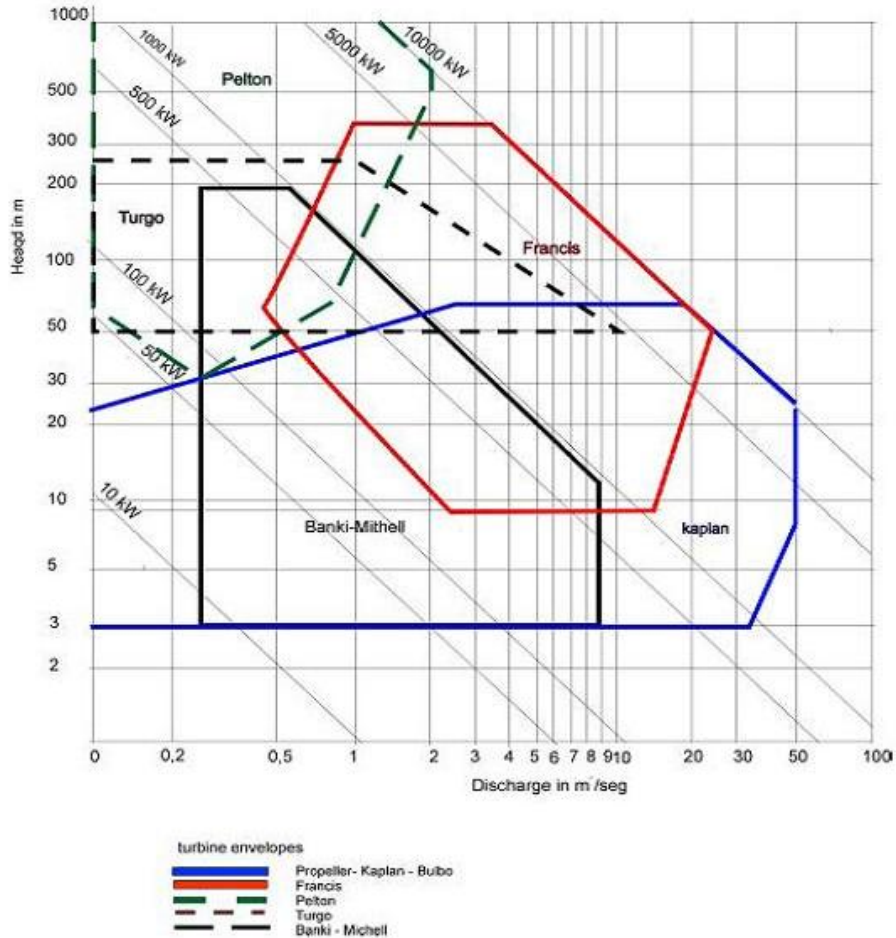

**Figure 2.11: Normal Range of Operation by Turbine Type (St. Onge Environmental Engineering, 2010)**

The third type of hydroelectric generation is pumped storage scheme power generation. These systems provide more electricity than is available during peak electricity usage. In a pumped storage hydroelectric system, water is pumped, during periods of low electricity demand, by an electric pump to a reservoir of high elevation. During periods of high electrical demand, water is released from the reservoir through a turbine connected to a generator and back into the low reservoir (Department of Energy, 2005). However, pumped storage hydroelectric systems use more energy to pump the water to the upper reservoir than they generate. Therefore, these systems are not a sustainable source of electricity (Egré & Milewski, 2002).

## 2.6 Geothermal Power

Geothermal energy is the heat energy contained within the earth, and can be used in many applications, including electricity generation. Water in the earth's crust is evaporated by this

heat, creating steam used to turn turbines. Harvesting this steam is effective in areas where the earth's crust is thin enough to allow ground water to be heated by the earth's core. Such areas exist all around the world, but are most commonly found on or near tectonic plate lines.

### **2.6.1 Geothermal Electric Plants**

There are three basic types of geothermal power plants that are used to produce electricity. The first is the dry steam plant, which channels steam from the ground directly through a turbine to generate electricity. Second is the flash geothermal plant. Flash geothermal plants pump heated ground water into a low pressure chamber, which causes the water to rapidly vaporize or "flash", creating water vapor (steam) that is used to turn turbines. Last is the binary geothermal plant, which uses a closed loop of heated ground water coupled with a heat exchanger. The water's heat is exchanged with another liquid that has a much lower boiling temperature. With this method, water below boiling temperature can be used to vaporize the other "binary liquid" which then turns a turbine (Department of Energy, 2008). All three types of geothermal power plants require a deep well to reach heated ground water, which is often very expensive.

Geothermal energy is hailed as an ideal source because it relies only on the constant heat of the earth. Geothermal systems move energy rather than producing it, making them more efficient than many other energy production processes. Power plants that use geothermal power are also less harmful to the environment than traditional sources of electricity generation such as burning coal or oil. Burning coal emits over 35 times as much carbon dioxide and almost 30 times as much sulfur dioxide as a flash geothermal plant (per mega watt hour of electricity produced) (Wilcox, 2006).

Though geothermal plants are not as harmful as many traditional power generation methods, there are still environmental issues associated with them, the main concern being the release of gasses during drilling and steam extraction. Gases contained in the earth's crust include carbon dioxide, hydrogen sulfide, methane, hydrogen, sulfur dioxide, and ammonia, though carbon dioxide and hydrogen sulfide are the only two found in enough abundance to be considered a threat to the environment. There is also concern for water pollution in the process of harvesting geothermal energy. Minerals can dissolve in the high temperatures of the steam and water used to generate power, and eventually poison both surface and ground water. Precautions

must be taken to prevent harmful minerals in ground water from being dissolved and released into the atmosphere or back into the ground (Wilcox, 2006).

### **2.6.2 Direct Use Geothermal**

Another technique for harnessing the earth's heat is direct use (i.e. the use of geothermal energy without converting it to electricity). The applications of direct use include but are not limited to bathing, swimming, agriculture, aquaculture, and space heating and cooling (Lund, 2004). The most common direct use of geothermal energy is space heating, in which a heat pump uses the earth's energy to provide heat for a building.

The ground temperature just a short distance below the earth's surface is nearly constant year round. In the summer months the outside air is hotter than the ground, while in the winter the ground is warmer than the air. Geothermal heat pumps (GHP's, also called ground source heat pumps, or GSHP's) use this relative warmth or coolness of the ground to heat or air condition buildings. This type of system is known as a ground source system.

A GHP circulates water or a refrigerant mixture through an underground assembly of piping, where the fluid either collects or dissipates heat depending on the season. The fluid is then pumped through a heat exchanger to heat or cool air for the house. Ground source systems in heating mode are very similar to electric furnaces, while systems in cooling mode are similar to traditional air conditioning. The main difference in both comparisons is that ground source systems use the ground's temperature rather than electric energy to evaporate or compress a refrigerant.

In a heating example, the closed loop fluid absorbs heat from the earth as it passes through underground piping. Once the fluid returns to the heat pump, the heat it has absorbed is used in a heat exchanger to evaporate a refrigerant. The evaporated refrigerant is then mechanically condensed, causing it to become hot. The heated refrigerant then flows to another heat exchanger through which cool air from inside the building is passed. The cool air is heated and then circulated through the building's ventilation system (Rafferty, Kevin 1997). The air, refrigerant, and water are all in continuous cycles, and repeat until the building temperature is satisfactory. Some ground source systems operate without the refrigerant step, where the building's air is passed over the pipes of heated fluid from the ground. GHP's are generally more productive when used for heating, but can be used for cooling as well (Lund, John 2007).

Ground source systems vary in size and configuration for different applications. System sizes are measured by the ton, which is a unit of the system's heating or cooling capacity. One ton of heating or cooling capacity is the equivalent of 12,000 BTU/h or about 3.5 kW. The average residential GHP is a 2 to 6 ton system, where commercial buildings require much more heating capacity. There are two basic configurations for ground source air conditioning units, the uses of which are influenced by the amount of available space, resources, and zoning regulations (Lund, John W. 1989).

The first and most commonly used configuration is called a closed loop. A length of tubing is buried underground in a closed loop that begins and ends at a heat pump. Liquid runs through the piping, either collecting or dissipating heat, and is then returned to a heat exchanger that heats or cools the building. These systems can be set up vertically or horizontally, depending on the amount of space available for construction. Horizontal systems are placed in an excavated trench, generally four to six feet deep, while vertical systems use bored holes about 150 feet deep (Lund, John W. 1989). Depths and lengths of tubing depend on the ground temperature as well as the size of the heating or cooling load that the system is designed for. Some horizontal closed loop systems use an assembly of piping under a body of water instead of underground, which works based on the same properties but saves money because no excavation is needed. Below are diagrams of closed loop systems, Figure 2.12(a) is a vertical configuration and Figure 2.12(b) is the horizontal variation.

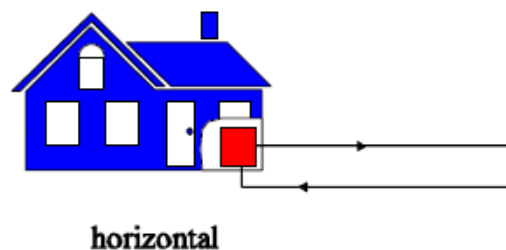
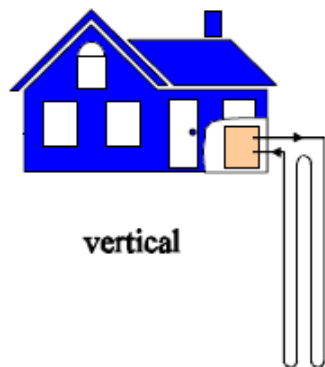

Figure 2.12(a): Vertical Closed Loop

Figure 2.12(b): Horizontal Closed Loop

(Lund, J. Sanner, B. Rybach, L. Curtis, R. Hellstrom, G. 2004)



The second type of ground source system is referred to as open loop. Open loop systems pump ground water from wells through a heat exchanger, and later return the water to the ground through a separate well. Lakes and ponds can also be used as a water supply for an open loop system. The effectiveness of these systems depends on the temperature and purity of the ground water, with possible problems including the damage of heat pumps due to minerals in ground water and inconsistent flow in the aquifer (ground stream). Open loop systems are less common than closed loops, but are known to be less expensive to install because they require less construction (Lund, J. Sanner, B. Rybach, L. Curtis, R. Hellstrom, G. 2004). Figure 2.13 shows an example of an open loop system using two separate wells.

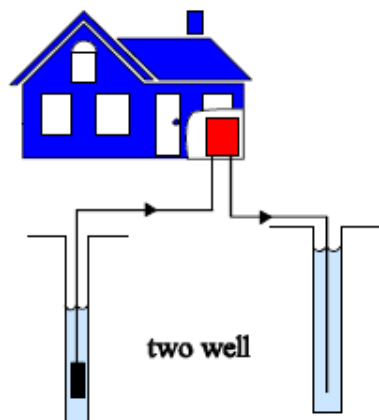
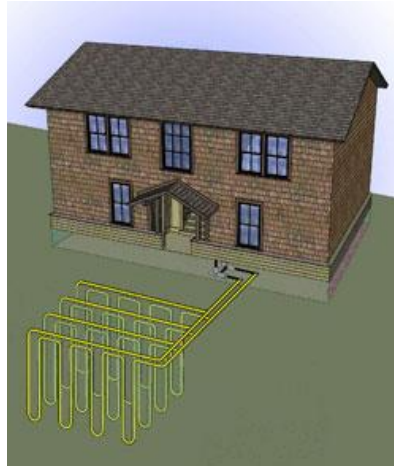

**Figure 2.13: Two Well Open Loop System**  
(Lund, J. Sanner, B. Rybach, L. Curtis, R. Hellstrom, G. 2004)

The use of geothermal heat pumps increases by 10% each year around the world, with 80,000 pumps installed annually in the United States (Lund, J. Sanner, B. Rybach, L. Curtis, R. Hellstrom, G. 2004). Growing popularity can be attributed to lowered energy bills, low maintenance, and low noise levels associated with GHP's. DOE and EPA Energy Star stamps can be found on certain heat pumps, and rebates are available for residential and commercial GSHP uses. Though these systems are expensive to install, payback periods can be as short as three years depending on the efficiency of the system and the size of the heating or cooling load. Ground source systems can be adapted to many situations and can often be used in retrofitting air conditioning systems easily.

Yosemite National Park utilizes a GSHP system to control the temperature of its employee housing in Curry Village. The system pumps a mixture of glycol and water through

pipes buried in the ground. In the winter the cold refrigerant is forced (by electric pumps) from within the building through the loops pipes in the ground. As the mixture travels it collects heat from the earth, and then returns to the building heated. Once inside, air is passed over the pipes containing the hot mixture. The air is heated by the pipes, and is then dispersed into the building to heat it. This pipe assembly can be seen in Figure 2.14 (National Park Service, 2010).



**Figure 2.14: Schematic of Curry Village Ground Source Heat Recovery System  
(National Park Service 2010)**

When applied to El Yunque National Forest, a ground source system could be used to replace (or in conjunction with) the current air conditioning systems in place. El Yunque Forest is located in a hot and humid area, and as result a large percent of the facilities' electricity use is devoted to temperature and humidity control. A ground source cooling system will be investigated to potentially lower the cost of air conditioning buildings in El Yunque National Forest.

## **2.7 Wind Power**

Wind has been used for hundreds of years as a natural source of energy to accomplish many tasks. Wind energy has traditionally propelled ships, processed grains, and pumped water (Hills, 1994). Modern versions of the windmill transform the kinetic energy of the wind into electric energy, and are commonly referred to as wind turbines.

Horizontal axis and vertical axis wind turbines are the two major classes of wind turbines. In a horizontal axis wind turbine, the plane of the spinning blades is perpendicular to the earth's surface, whereas in a vertical axis wind turbine the plane of the spinning blades is

aligned parallel with the earth's surface. The two main advantages of a vertical axis wind turbine are that it works equally well in any wind direction without having to design a swivel mechanism, and its blades make far less noise. However, it has been proven that over a variety of wind speeds horizontal axis wind turbines have advantages in achieving higher performance coefficients than vertical axis machines. The performance coefficient  $C_p$  is described in Equation 2.1 (Hills, 1994).

**Equation 2.1: Performance Coefficient:**

$$C_p = P_w/P_o$$

$C_p$  = performance coefficient

$P_w$  = total power absorbed from the wind column

$P_o$  = total available power

Horizontal axis wind turbines also exhibit more desirable start-up behavior and offer more latitude for the implementation of control options. These benefits come at the cost of noise and complexity (Heier, 2003). Figure 2.15 shows both types of turbine configurations.

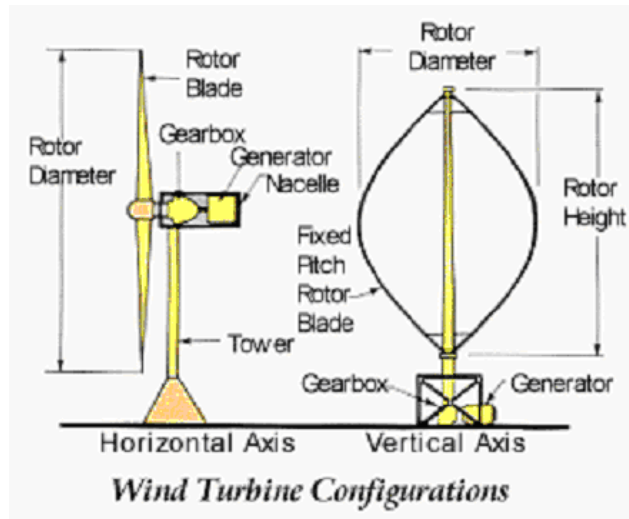

**Figure 2.15: Vertical and Horizontal Axis Wind Turbines (Twenty First Century Energy 2010)**

Wind turbines of both varieties can be developed and optimized to output high torque or high rotational speed. Machines constructed with many blades produce high levels of torque, and those constructed with fewer blades achieve higher rotational speeds and more overall power

extraction. For this reason wind turbines with fewer blades are better suited for making electricity. The development of aerodynamically lifting blades for both classes of wind turbines has made it possible to extract nearly 45% of the overall available kinetic wind energy (Heier, 2003).

There are several advantages of using wind to generate electricity over conventional power generation techniques, including that wind energy installation yields minimal site damage, and also that the power generated by wind turbines does not cause direct environmental harm. Lisa Daniels describes another advantage derived from wind energy for landowners, “[wind turbines] take less than 2% of the land out of production, so it's not replacing what's there. It is an additional source of revenue” (Gordon, 2004). Other benefits include monetary clean energy incentives and tax breaks offered by some governments (DeCarolis, Keith, Jacobson, & Masters, 2001).

Because high ground or flat terrain are ideal conditions for the placement of wind turbines, many turbines are visible from great distances. Some consider this view undesirable, and believe that property with views obstructed by wind turbines is undesirable (Nadaï & Van der Horst, 2010; Pinder, Price, & Smith, 1989). There are also environmental aspects to consider. Sites are particularly damaging to birds, both physically and to their habitats. High blade tip speeds generate loud turbulence, which can physically harm animals or force them from their homes. There are also uncertainties with wind turbine technology such as blade or tower failure that make the safety of the public residing near a wind turbine a concern (Berkhuizen & Slob, 1989).

When planning a wind project, it is important to consider the number of wind turbines that are placed on a specific site so that the desired amount of electricity can be generated. Individual wind turbines are capable of producing electricity on a small scale, so depending on site requirements it may be necessary to construct a wind farm (a single site that employs multiple wind turbines that work together to produce electricity). Recently there has been a shift in individual ownership of small wind turbines to a commercial ownership of wind farms. This trend correlates directly to the economic benefits and the efficient nature of larger scale projects (Nadaï & Van der Horst, 2010).

The two main categories for site choices are land-based sites and offshore sites. Offshore wind farms are desirable because issues with noise, visual obstruction, and safety are avoided.

Additionally, offshore wind patterns are more consistently sustained so turbines can be constructed on a larger scale. However the forces of waves and currents and the logistical issue of transporting electricity from the offshore site back onto land is problematic (Byrne & Houlsby, 2003). Altitude is important when considering sites on land. As a rule of thumb, wind speeds increase in a given area with height above the surface of the earth. Landscape can interrupt the linearity of the wind flowing over the land and generate turbulence. Due to the irregularity of turbulent flows, wind turbines are relatively ineffective at extracting energy from them (Simmons, 1975). Weather patterns are also important to site selection, because flow consistency is proportional to the overall efficiency of a wind turbine.

Weather patterns that typically include a sufficiently strong and relatively steady wind are perfect for a wind turbine site (Cheremisinoff, 1978). Other site data needed to determine the energy yield of a site include the number of hours per year that relevant wind speed occurs (Heier, 2003). Wind gusts are useful on start up, as wind turbines generally can continue to operate at a wind speed that is lower than the speed required to start them spinning. Occasional slow wind speed is acceptable because there is some energy stored in the spinning blades of a wind turbine. As a result, the rotational inertia of the system is sufficient to keep the blades spinning when there is a short period with low wind speeds.

Depending on whether electricity will be fed into a grid or stored on site, the electricity generated by a wind turbine may pass through a rectifier or an inverter. A rectifier takes one or three phase AC into DC, and an inverter converts DC into one or three phase AC. This is necessary because the electrical current needs to be compatible with the energy storage system (Heier, 2003). This process is similar to the grid integration and standalone power section outlined in section 2.4

There are currently several wind projects underway to reduce Puerto Rico's dependence on fossil fuels as a primary energy resource. Wind data has been collected for sites along the northern and eastern coasts and throughout the high ground in the interior of the island. A 50 megawatt wind project is currently under construction and is slated to be completed by August 2012, and there are two additional wind projects in the development stages. As stated by the EIA, "the use of renewable energy is growing and the Puerto Rico Power Authority plans on generating more than 20 percent of electricity demand from renewable sources by 2015" (Energy Information Administration, 2010). Despite the social concerns that revolve around wind energy,

there is currently a movement in Puerto Rico toward employing more wind energy to address the issue of sustainability.

The Boston Harbor Islands National Recreation Area (operated by the National Park Service) is planning to use wind for electricity generation. A wind turbine was constructed on a windy area on the mainland in Hull, which is responsible for generating all of the electricity used by the street lights in the town, and has been so successful that a second larger turbine is currently being constructed at a second site. The Park Service is planning to place their own wind turbines throughout the islands to help power their infrastructure (National Park Service, 2008). Wind energy is one component of the plan that the Park Service has developed to implement alternative energy throughout the Boston Harbor Islands to address the issue of sustainability and create an energy conscious public image.

## **2.8 Transportation and Alternative Fuels**

Increases in oil prices cause many organizations to investigate alternative fuels or means of transportation. This is also true for the National Park Service, which has investigated and implemented many instances of alternative transportation means in its parks. Alternative transportation solutions have been shown to emit fewer harmful pollutants, and in some cases be less expensive than traditional gasoline.

### **2.8.1 Biodiesel Fuel**

Biodiesel fuel is a renewable fuel produced from various biomass materials including animal fat and vegetable oils. It is used as a replacement for conventional petroleum diesel because it combusts in a similar fashion and has like properties. Bio and petroleum diesel are often combined to produce what is called a biodiesel blend. These fuels are classified by the percentage of biodiesel present in the mixture; a diesel blend with 20% biodiesel and 80% petroleum diesel is classified as B20, and pure biodiesel is listed as B100. B20 is the most commonly used biodiesel blend in vehicles today, partially because using it requires little or no modification to traditional diesel engines.

Though it can be used in a number of applications, biodiesel fuel is most widely used for transportation. Most biodiesel blends provide a similar performance to that of traditional diesel fuel. In a test of both on and off road biodiesel applications, it was determined that biodiesel shows “similar fuel consumption, horsepower, torque, and haulage rates as conventional diesel fuel” (National Biodiesel Board, 2010). As the price of petroleum rises, so does the demand for

biodiesel. The national production of biodiesel in the United States grew from 2 million gallons in 2000 to 491 million in 2007 (National Biodiesel Board, 2010). Yet the prices of biodiesel blends rise with the petroleum prices as well. In October 2009, the price of B20 was listed at \$2.88 per gallon, and B100 at \$3.19 per gallon, both higher than regular gasoline and petroleum diesel. When compared to reports from July 2009, both prices had increased considerably. B20 prices increased by \$0.19, and B100 increased by \$0.11. Gasoline and diesel prices rose by \$0.20 and \$0.26, respectively (Department of Energy, 2009). However, each fuel type does not produce the same amount of energy per gallon, so one must look at the amount of energy produce per unit price. On an “energy equivalent basis” in units of dollars per million BTU, gasoline, diesel, B20, and B100 cost \$22.90, \$21.69, \$22.77, and \$27.21 respectively (Department of Energy, 2009).

Biodiesel is used as a green substitute for fossil fuels because it is less damaging to the environment, releasing considerably fewer harmful emissions than gasoline and traditional diesel fuels. Emissions of hydrocarbons, nitrogen oxides, and carbon monoxides are known to adversely affect the environment. According to the National Biodiesel Board, B100 emits about 48% less carbon monoxide than traditional diesel fuel, and 67% fewer hydrocarbon pollutants. B20 fuel reduces carbon monoxide and hydrocarbon emissions by 20% and 12%, respectively. However, both B100 and B20 blends have shown an increase in nitrogen oxide emissions, by 10% and 2% respectively (National Biodiesel Board, 2010).

In its efforts to protect wildlife by reducing emissions, the United States National Park Service (NPS) has been using pure B100 fuel to power vehicles in Yellowstone National Park for over 10 years. Use of biodiesel in Yellowstone began as a test, but has since become popular in the National Park Service. According to NPS Environmental Leadership Program Coordinator Shawn Norton, biodiesel fuel is now used in “more than 1,000 different biodiesel applications” in “at least 50...national parks.” In 2005, the NPS used over 80,000 gallons of biodiesel fuel in various applications, and is still ambitious to use biodiesel in more of its parks (Kotrba, Ron 2006).

### **2.8.2 Hybrid Vehicles**

Electric and hybrid electric vehicles have been a popular solution for rising oil prices. Hybrid vehicles use electric motors in conjunction with gasoline or diesel engines, which can significantly lower emissions and increase gas mileage. Both mileage and emissions vary by model. Hybrid vehicles are generally driven by either a series or parallel configuration. In a

series configuration the electric motor is the only driving force, and the gas engine is used to recharge the electric battery. Parallel configurations allow for the vehicle to be powered by one or both of the motors at the same time (Hybrid Cars, 2010).

Yosemite National Park employs the use of hybrid vehicles to reduce emissions as well as noise levels. The Park gives tours on a fleet of hybrid buses that combine diesel and electric power. According to Park Superintendent Mike Tollefson, the buses “produce about 90% fewer emissions and use 60% less fuel than the diesel buses they replaced” (Leavitt, Wendy 2007). These new buses allow the Park to give its visitors tours while at the same time lowering costs, emissions, and noise pollution.

## **2.9 Summary**

There is a constant demand for energy throughout the world, and El Yunque National Forest is no exception. There is a need to produce and conserve energy in a more cost effective manner, as well as to exhibit an environmentally friendly image. This section has introduced and explained a variety of potential approaches to achieve these goals including practicing different conservation techniques and harnessing solar, wind, biomass, hydro, and geothermal energies. Each of these approaches was investigated, to evaluate their advantages and drawbacks. These findings were be used to develop recommendations addressing cost, sustainability, and responsible land management in El Yunque National Reserve.



## CHAPTER 3: METHODOLOGY

The goal of this project was to evaluate the possibilities and potential advantages of using alternative energy sources and energy conservation methods in El Yunque National Forest. Since the team did not have the benefit of first seeing the Forest, it examined the feasibility of many alternative energy sources including solar power, wind power, geothermal power, hydropower, and biodiesel fuel. Once on site, the most feasible alternative energy sources were chosen and further investigated. All other alternative energy sources were deemed unfeasible, and no further investigation followed. Site analysis was performed to determine which methods offered the greatest potential benefits for El Yunque National Forest.

### 3.1 Choosing Feasible Options

At the project site, previously inaccessible information was made available for analysis by the team. Based on this information, some of the possibilities included in the literature review section were ruled out. After initially selecting several possible sites for wind power it became clear that wind speed and consistency are not sufficient to support the operation of a wind turbine. Wind data made available by the National Weather Service also indicated wind speeds consistently lower than those required by a wind turbine. Figure 3.1 is an example of a wind map that describes velocity and direction.

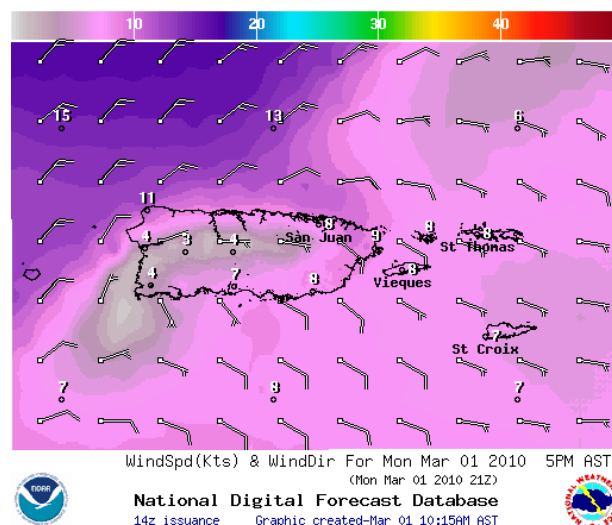

Figure 3.1: Example of Puerto Rico wind map (National Weather Service, 2010)

To ensure that the observed conditions were typical, the team consulted Property Management Team Leader Manuel Ortiz who had previously examined the possibility of wind power. Ortiz stated that in his study he came to the conclusion that wind power was not a feasible alternative energy source to be used in the area around the Catalina Service Center and El Portal (Ortiz, 2010). Sr. Ortiz also mentioned that typical wind currents throughout the rest of the Forest were similar to those observed at El Portal and the Catalina Service Center. For this reason it was concluded that wind power would not be a feasible alternative source of energy in El Yunque.

Hot water usage at El Yunque's facilities is limited to a few sinks at El Portal and the Catalina Service Center and some occasionally used showers at the Catalina Service Center. After conversing with Ecosystem Management Team Leader Pedro Rios, the team decided not to perform any further investigation on solar hot water systems due to the low and inconsistent usage of hot water in El Yunque's facilities.

After having discussed the possibility of using alternative fuels with Pedro Rios, the team determined that there was no need to perform any further investigation. There are no diesel vehicles in El Yunque's fleet, so biodiesel is not an option to fuel them. The staff of El Yunque National Forest is issued gas cards to purchase fuel for the Forest's vehicle fleet, and as result the sponsor is not currently concerned with transportation expenses. After discussion with the sponsor and El Yunque staff, it was determined that the use of alternative fuels for transportation would not be investigated further in this project.

### **3.2 Evaluating Current Energy Usage**

The current electricity usage in El Yunque National Forest was reviewed in order to determine the monthly consumption and cost, and where improvements in efficiency could be made. Electricity bills dating back to September 2006 were reviewed to observe trends in usage and total cost. An energy audit had already been performed by Manuel Ortiz which analyzed the current electricity usage of lighting and appliances at El Portal and the Catalina Service Center, and is included in Appendix A. This audit was used to supplement the findings of the team as well as to identify areas where improvements could be made.

### **3.3 Site Analysis**

Site analysis was performed to assess the feasibility of each proposed solution. The social issues presented by each solution, including visual intrusion and noise pollution, were also

considered. Site analysis included data collection in the forms of research, interview, and fieldwork. Using this data, the potential amount of energy to be produced or conserved using each method was estimated. Cost analyses were then performed by evaluating the total cost of implementing each method. Comparison of the energy production and total costs of each method with those of El Yunque's current system helped the team to determine the best solutions for the sponsor.

### **3.3.1 Conservation Site Analysis**

Conservation analysis assessed the energy savings and overall reduction in cost attainable by implementing various conservation techniques. Facilities that were considered in conservation analysis include the Catalina Service Center, El Portal, the Yuquiyu Delight's roadside restaurant, and the Palo Colorado Recreation Area. The analysis focused on discovering wasteful energy habits throughout the Forest's infrastructure by inspecting the facilities in question, making use of Ortiz's energy audit, and interviewing Forest staff. Inspections of the facilities were performed on walkthroughs, during which various measurements were made and data were documented. Next, the current recycling plans in El Yunque were studied, as well as the level to which they are implemented throughout the Forest. Current recycling habits were studied by observing the employees and visitors and documenting the recycling facilities available for the use of each. This study determined whether or not the Forest Service had a recycling plan in place that was usable for both its visitors and its employees. The success of this recycling plan was evaluated by observation of participation, photographic evidence, and interview of custodial and accounting staff members. From the information gathered, an estimate was made of the amount of energy wasted and the amount of materials being thrown away by both visitors and staff. Finally, a proposal outlining conservation techniques including recycling and reusing was made to the Forest Service.

### **3.3.2 Solar Power Site Analysis**

In order to determine the feasibility of solar power in El Yunque the team first estimated the amount of solar radiation that the Forest receives annually. This was done with solar radiation data for San Juan, Puerto Rico published by the National Renewable Energy Laboratory in the "Solar Radiation Data Manual for Flat Plate and Concentrating Collectors" in conjunction with 3Tier's FirstLook; a program which ranks every coordinate on the globe in terms of solar radiation resources from 0%-100% based on satellite imagery. Potential sites were

then selected based on observed cloud cover, shading, and proximity to the electrical grid or facility to be powered. Each potential site was rated numerically based on a site survey. This survey included orientation, available area, shading, cost of construction, environmental impact, and visual intrusion, and is found in Appendix B. These observations allowed the team to propose sites best suited for solar energy collection. Since hurricanes are common to the Caribbean region, the possible extent of damage to solar units due to hurricanes was also examined by reviewing case studies and weather patterns (National Weather Service, 2010). This allowed the team to assess damage to a solar power system that may result from a hurricane.

### **3.3.3 Estimate the Production of Solar Energy**

After estimating the available solar radiation and evaluating each potential site, the potential electrical production of a photovoltaic solar system for each proposed location was calculated using Equation 3.1 (Dunlop, Huld, Ossenbrink & Suri, 2007; National Renewable Energy Laboratory, 2010).

#### **Equation 3.1: Annual Electricity Production of Photovoltaic Systems:**

$$\mathbf{E = P \cdot DF \cdot SR}$$

**E = Annual Electricity Production**

**P = Peak Unit Power**

**DF = Derate Factor = 0.77**

**SR = Annual Solar Radiation**

This equation was used in conjunction with collected data to estimate the electric power that can be produced by harnessing solar power in El Yunque. This type of analysis was used to evaluate potential energy collection at each possible solar site. This information, paired with weather observations, helped to determine the most favorable solar power sites.

### **3.3.4 Hydropower Site Analysis**

To determine which specific site on a river is most feasible for micro hydropower systems, the team considered the head (difference in elevation between the starting point and the end point of the system), the flow rate (volume that flows past a point per unit time) of the stream in question, and the site's proximity to the infrastructure it will power. Personal

observation, GIS database technology, and other topographical resources were used to evaluate which sites along rivers and streams in El Yunque have the highest head, highest flow rate, and most favorable location.

### 3.3.5 Estimate the Production of Hydro-Electric Power

The electrical production of a micro hydropower system depends on the efficiency of the turbine and generator, the head, and the flow rate at the given site. To calculate the electrical production of micro hydropower systems, Equation 3.2 (Bureekul, Chaisomphob & Rojanamon, 2009) was used. This equation estimated the amount of electricity that can be produced by a micro hydro-electric system at each proposed site.

#### Equation 3.2: Electricity Production of Micro Hydro-Electric Systems:

$$P = g \times \eta_t \times \eta_g \times Q_d \times (H_d - (0.001 L_h + 0.005 L_p))$$

**P = Power Output (kW)**

**g = Acceleration due to Gravity = 9.81 m/s<sup>2</sup>**

**$\eta_t$  = Turbine Efficiency**

**$\eta_g$  = Generator Efficiency**

**$Q_d$  = Flow Rate or Discharge (m<sup>3</sup>/s)**

**$H_d$  = Gross Head (m)**

**$L_h$  = Length of Head Race (m)**

**$L_p$  = Length of Penstock (m)**

### 3.3.6 Geothermal Energy Site Analysis

Ground source cooling was considered for air conditioning in the Forest's facilities. The team investigated the costs and potential production of a ground source cooling system. Possible configurations were considered to decide which type of system would be best suited to meet the needs of each facility. The team observed the space available, as well as the possible environmental impacts of installing a ground source cooling system. Variables including soil composition, density, and thermal conductivity that are necessary for estimating the production of a ground source system could not be obtained.

To estimate the potential benefits of ground source cooling, the air conditioning systems currently in place in El Portal and the Catalina Service Center were investigated. The team

researched the efficiency of the air conditioning units, how much energy they use in an average day, and how much cooling power they delivered. Building plans were examined as well to determine the square footage of air conditioned spaces in the buildings. Staff engineers were interviewed about the air conditioning system and its efficiency, and Ortiz's energy audit was utilized to determine how much electricity was used for air conditioning each month. This information was gathered to determine the energy use and efficiency of the air conditioning system in the Forest's buildings.

### **3.4 Environmental Impacts**

The team considered the environmental impacts associated with each potential solution by investigating pertinent case studies and analyzing the potential harmful environmental effects that may be presented to the Forest. Certain sites were omitted due to potential adverse effects on the surrounding environment, such as invasive construction, pollution, erosion, and noise that could affect flora and fauna of the Forest.

### **3.5 Cost Analysis**

Manufacturers were contacted to collect costs of components, installation, and maintenance for proposed energy solutions. Case studies concerning similar existing alternative energy systems were reviewed to assess maintenance and component replacement costs. Next, potential savings for each method were estimated using the methods and equations presented above. After considering rebates and incentives, savings were weighed against the cost of implementation to produce a cost analysis that provides the sponsor with an estimated payback period for the proposed solutions.

### **3.6 Conclusion**

Data and information were collected in order to determine the feasibility of proposed alternative energy solutions. After considering this information, the team decided that certain proposed solutions would not be investigated further. Cost analysis was performed for the solutions that were determined to be the most feasible. Once all of the necessary information was collected and evaluated, a proposal was made to the sponsor. This proposal recommended the most beneficial energy sources and conservation techniques, and provided a complete cost analysis, including installation and maintenance costs as well as payback periods for each solution.

## CHAPTER 4: RESULTS AND ANALYSIS

To mitigate El Yunque National Forest's high electricity usage and expenditure, this project evaluated the effect of implementing various conservation techniques, solar power, hydropower, and geothermal power into the Forest's existing infrastructure. The team evaluated El Yunque's current energy usage situation, performed site analysis, and determined the costs, energy production, and environmental impacts associated with each conservation technique and alternative energy option. Lastly, cost analysis was performed for each conservation technique and alternative energy to determine the effectiveness of each option in reducing El Yunque National Forest's electrical usage and expenditure.

### 4.1 Current Energy Usage

The Puerto Rico Electrical Power Authority (PREPA) is the primary source of electricity for El Yunque National Forest. A review of the Forest's electricity bills from September 2006 to January 2010, provided to the team by Administrative Support Assistant, Delia Gomez, was used to plot electricity usage, expenditure, and cost per kWh in Figures 4.1(a), 4.1(b), and 4.1(c), respectively.

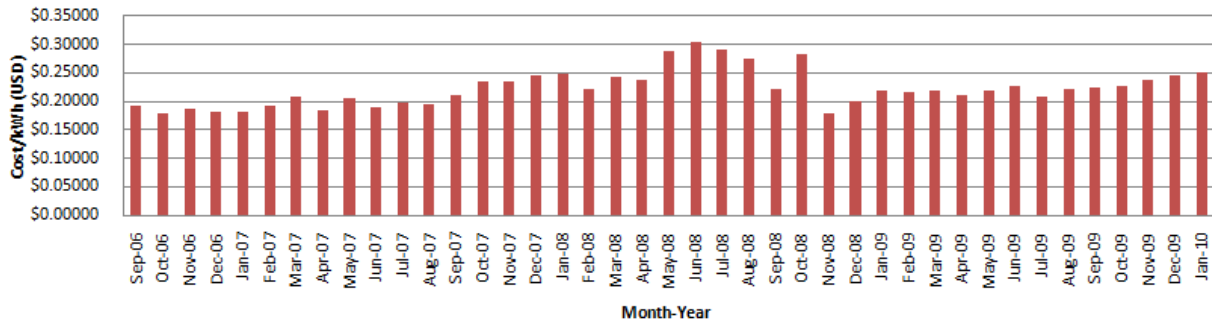
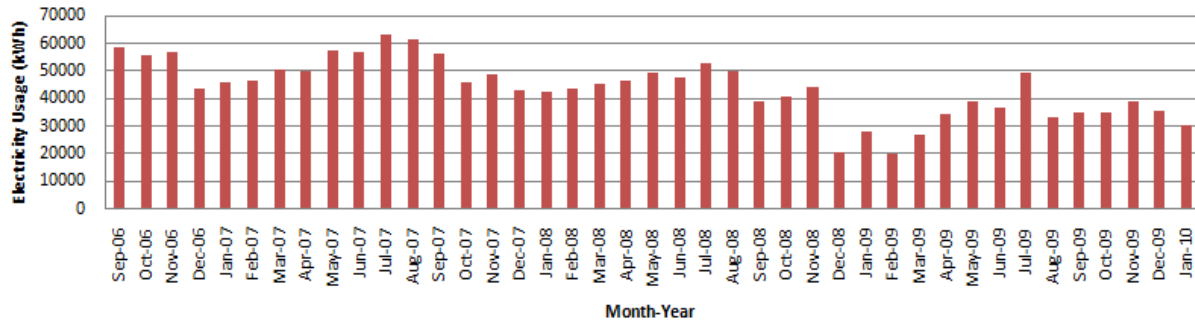
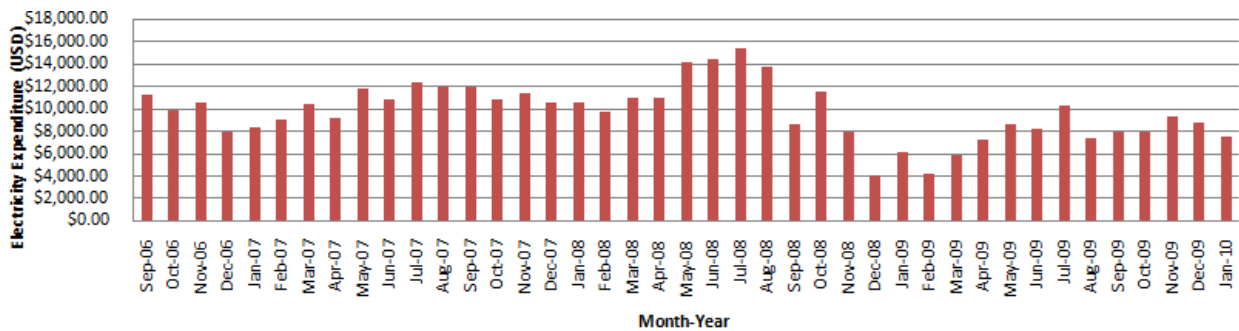

Figure 4.1(a): Monthly Electricity Usage September 2006 – January 2010



**Figure 4.1(b): Monthly Electricity Expenditure September 2006 – January 2010**



**Figure 4.1(c): Cost per kWh (PREPA) September 2006 – January 2010**

The monetary electricity expenditure is a product of usage and price per kilowatt-hour, which fluctuates often, as seen in Figure 4.1 (a). The cost of electricity per kWh from PREPA is influenced by oil prices, which is evident as it exceeded \$0.30 per kWh during the summer of 2008 when world crude oil prices spiked to approximately \$100.00 per barrel. The effects of the fluctuating cost of oil on electricity prices from PREPA can be observed in Figure 4.1(c). According to the U.S. Energy Information Administration, world crude oil prices are projected to increase from \$79.80 per barrel in 2010 to \$130.00 per barrel by 2030; an average annual increase of 2.443% (Department of Energy, 2009). If this trend is applied to the current cost per kWh from PREPA, electricity will cost approximately \$0.45 per kWh by 2035. By integrating alternative energies and conservation methods throughout their facilities El Yunque National Forest will minimize the effects of rising oil prices.

Beginning in December 2008, El Yunque’s electricity consumption was significantly reduced as a result of the conservation efforts of Property Management Team Leader Manuel Ortiz as seen in Figure 4.1(a) and 4.1(b). The main contributing factors in Ortiz’s conservation efforts included shutting off the water feature pump at El Portal at night and the installation of



programmable thermostats and more efficient light bulbs. The amount of electricity consumed throughout the Forest also varies with the seasons. These oscillations can be seen on Figure 4.1(b). There is particularly high usage during the summer months from April to September. This trend in usage can be attributed to increased HVAC (heating, ventilating, and air conditioning) demands because of the higher air temperatures and increase in humidity.

## **4.2 Conservation Methods**

The section discusses results from this study and includes recommendations concerning conservation methods that can potentially reduce energy consumption throughout El Yunque. Projected energy savings are calculated wherever possible. Many of the calculations that are made use data concerning the energy consumption of various devices taken from Sr. Ortiz's energy audit. These calculations were made assuming that the data made available by Ortiz is accurate. In cases where adequate information was not available or time did not allow, recommendations are made based on various researched case studies.

### **4.2.1 Recycling, Reducing, Reusing**

There is currently an extensive recycling program that has been implemented for the Forest Service employees to use. There are shredded paper, newspaper, and sheet paper receptacles labeled and placed in the office areas. Recycling containers for plastic and aluminum are also located in areas around the office spaces of El Portal and the Catalina Service Center where employees would likely be consuming bottled and canned beverages. There is still a large amount of recyclable office material that is being thrown away by employees, as shown by the amount of paper waste that can be seen in employee waste receptacles on a daily basis. One way to encourage employees to recycle more office waste is to provide each work station with both a small recycling container and a small waste container. Having the small recycling container will likely ensure that a lower percentage of recyclables are thrown away. Furthermore a recycling plan should be drafted that updates employees on the Forests recycling policy and reminders should be posted.

On the other hand there are no recycling containers placed for visitor use. Observation of the waste receptacles made it clear that this is an issue. Figures 4.2(a) and 4.2(b) illustrate the current state of the system in place for visitors. The problem is that recyclables are being thrown away, and this is costing the park money in the long run as they pay to have all of the waste removed, instead of having the recycling removed for free. This is a particularly serious issue in

the areas throughout the park where vendors are selling drinks and food that come in recyclable containers.



**Figure 4.2(a)**



**Figure 4.2(b)**

**Figure 4.2(a): Waste Receptacle in El Portal Filled with Recyclable Material**  
**Figure 4.2(b): Refreshment Stand in El Portal Sells Drinks without the Option of Recycling Their Containers**

The current contract that the Forest has with A & A Waste Management provided by Purchasing Agent Elba García, is for the weekly pickup of four, eight cubic yard dumpsters at a monthly cost of \$738 (\$8,856 annually)(García, 2010). Extra and special pickups are not included in this monthly figure and are typically required two or three times a year during particularly high traffic times of the season. According to Supervisory Forestry Technician Jaime Valentín, these extra pickups amount to approximately an additional \$1,500 annually (Valentín, 2010). At this time there are no composting facilities or estimates on the amount of compostable materials that are discarded as solid waste.

The store and snack bar at El Portal, and the small store at the Palo Colorado Recreation Area all sell bottled and canned beverages. Testing showed that on average 15, 16 ounce water bottles, 18, 20 ounce Gatorade bottles, or 25, 12 ounce soda cans occupy about 5 U.S. liquid gallons of volume. During this test the beverage containers were intentionally randomly tossed into the 5 gallon bucket in an effort to replicate the way they might occupy a recycling container. Extrapolating this data suggests that a cubic yard of volume is occupied by 600, 16 ounce water bottles, 720, 20 ounce Gatorade bottles, or 1,000, 12 ounce soda cans. The team was unable to

obtain information on the number of bottled drinks that are sold annually throughout the Forest. Once this information is made available, the analysis outlined below should be performed.

The recyclable materials collected near the offices are removed at no cost. At this time the Forest Service is not being paid for the recyclables it collects, but also does not have to pay to have them removed. There are recycling facilities in Puerto Rico that pay for recyclables, although they often work with clients that have a very large amount of recyclable material.

It is assumed that under the current waste management plan all of the bottles sold are deposited in the waste receptacles made available to visitors throughout the park. This assumption provides a reasonable approximation because while not every bottle that is purchased at the park is thrown away at the park, some visitors bring bottles into the park and dispose of them there. Due to sales throughout the park, the number of cubic yards of cans and bottles that are being removed as of solid waste can be calculated knowing that a cubic yard of volume is occupied by 600, 16 ounce water bottles, 720, 20 ounce Gatorade bottles, or 1000, 12 ounce soda cans. Knowing the total volume of bottles and cans being thrown away each year the number of eight yard dumpsters would no longer be needed each month if all of this material was recycled could be calculated. Then the savings that could be obtained by implementing recycling for visitors could be calculated knowing that each eight yard dumpster costs \$184.50 each month.

There are currently plans to institute a carry in carry out policy for any solid waste a visitor might bring into El Yunque. Under this type of waste management plan there would be no waste receptacles offered for visitors to use. Visitors would be expected to leave with any waste that they generated at their stay in the Forest. If this policy is implemented and successful the Forest Service will only need to throw away employee generated waste. Office waste containers are about 5 gallons on average, and the average employee generates about a third of a container each day. According to Purchasing Agent Elba García there are typically 33 office employees at El Portal and the Catalina Service Center combined (García, 2010). This data suggests that about 55 gallons of office waste are generated each day at both facilities combined. About another 20 gallons per day is generated by the employees in extraneous waste such as lunch containers. Office employees work an average of 22 days per month. This means that over the course of a month employees generate about 1650 gallons of waste or 8.2 cubic yards. These calculations suggest that the Forest Service could save \$8,142 annually because only one, eight yard

dumpster will be required to handle employee generated waste with plenty of extra space each week.

It is recommended that all of the current waste receptacles that are located throughout the facilities be re-labeled as recycling containers. Benefits of re-labeling the waste containers include promoting recycling, reduced waste removal costs, an increase in the collection of recyclables, and making use of containers that are already in place that would be unnecessary with a carry in carry out policy. Furthermore the installation of composting containers located everywhere food is served throughout the park would reduce the amount of solid waste generated by the facilities.

Table 4.1 shows a comparison between the annual costs of the current waste management strategy, and implementing the carry in carry out policy for visitors. The best option in terms of cost is to implement a carry in carry out policy for Visitors.

<b>Waste Management Strategy</b>	<b>Cost/Year</b>
<b>Current</b>	\$10,356
<b>Carry in Carry Out</b>	\$2,214

**Table 4.1: Comparison of the Annual Costs of Waste Management Strategies.**

The management of the Yuquiyu Delights roadside restaurant was interviewed in regards to the waste they currently generate at the restaurant. They claimed that the waste they currently generate is negligible because most of it is recycled. Management also said that the restaurant generates a very small amount of compostable material and they currently do not compost any of it. Figure 4.3 shows the recycling and waste facility that the Yuquiyu Delights restaurant has made available to their customers.



**Figure 4.3: Recycling and Waste Facility at Yuquiyu Delights Restaurant**

There are currently some disposable materials being purchased and thrown away. Purchasing and reusing plates, cups, and silverware can reduce the amount of waste generated by a facility. It is recommended that employees be encouraged to re-use whatever materials they can. Some actions that can be used to further lower operating costs and reduce waste are to save packing materials and use them to ship items in the future, convert to a paperless office, and eliminate the use of paper towels used to dry hands in the bathrooms. The benefits of operating in a paperless office are that fewer office supplies must be purchased, the amount of office related waste is reduced, and energy used to power printers and copy machines is saved.

#### **4.2.2 Appliances and Lighting**

The energy audit conducted by Property Management Team Leader Manuel Ortiz in 2009 (see Appendix A) gives details on some of the energy saving techniques that the Forest Service has already implemented. As described in the audit, out of date and inefficient fluorescent lighting units were replaced with modern units that consume less energy. The team recommends that a check be performed to ensure that every fixture has been updated, and that both low wattage bulbs and fixtures with electronic ballasts have been installed as prescribed by Ortiz. Other recommendations to minimize lighting costs include removing unnecessary lighting, strategically installing motion sensors, and drafting an official code of use for employees.

After observation of the current lighting in El Portal and the Catalina Service Center, it was determined that some light fixtures could have lights removed, while still providing sufficient light. It is recommended that some bulbs be removed from these fixtures, though only after building and fire codes are consulted. If deemed safe, it would be advantageous to remove bulbs from fixtures. Light bulbs that aren't needed waste electricity, and if removed could be saved as replacements for those that remain in use. For example, removing one bulb from each of the large 4' lighting fixtures used in both the Catalina Service Center and El Portal would reduce the cost of running those fixtures by 25%. As a general rule, if the staff can remove any light without causing prolonged discomfort, safety risks, or building code violations, it should do so.

It is recommended that the safety of reducing outdoor lighting be assessed. All unnecessary outdoor lighting should remain off whenever possible. Lighting elements in El Yunque that use the most electricity include outdoor lighting, parking lot lamps, walkway lighting, ceiling lights outside the theater, and outdoor stairwell lighting. Parking lights are used every day and consume 20,805 kWh of energy per year. Other outdoor lighting at El Portal is used 360 days a year, consuming about 5,256 kWh (Ortiz, 2010). 1,242 kWh of energy is used operating the outdoor lighting 261 days out of the year at the Catalina Service Center (Ortiz, 2010). At current energy rates, the combined cost of this lighting about \$6,826 each year. One option for reducing outdoor lighting costs without shutting the fixtures off is implementing motion sensors and installing efficient LED luminaries.

Motion sensors have been considered for use both within office spaces and in parking lots but have yet to be implemented. The effect that motion sensors will have on outdoor lighting is not predictable because there are many unknowns associated with the variables that trigger the sensors. The previously cited case study from Pacific Gas and Electric Company reported a 70% decrease in power consumption with a payback period less than five years (Johnson, Cook, Shackelford, and Pang, 2010). If that same reduction could be realized in El Yunque, about 14560 kWh of energy per year could be saved annually on lighting in the parking lots at the Catalina Service Center and El Portal.

Current light use practices typically suggest that it is not necessary to place motion sensors in all interior spaces. It is recommended that a light use policy be drafted which ensures that employees know that lights should only be on when rooms are occupied, perhaps by placing reminders next to switches. Areas that could benefit from occupancy sensors include bathrooms,

kitchen areas, and copying areas. Because no data has been collected that quantifies the amount of time lights in these areas are on when the areas are unoccupied, it is impossible to estimate the savings that can be generated. However based on research and observation these are the areas with the highest daily traffic, and as a result have the most potential to benefit from the installation of occupancy sensing. Research indicates that a setting of about 2.5 minutes reduces energy consumption the most in kitchen and copying areas (Dittmer, Keller & Richman, 1994). Bathrooms require a time setting of around 10 minutes.

The cost of the motion sensors and installation varies widely between the types of sensors being used and the number of sensors being installed. The number of sensors to install depends on the outcomes of the outdoor lighting safety analysis. Once this number is determined a contractor that provides both indoor and outdoor occupancy sensing installation should be contacted for a price quote.

The current electrical costs of lighting are unknown. Time did not permit the team to perform an updated energy analysis to account for the changes that were made as recommended by Ortiz. The Forest Service should keep an up to date spread sheet that reflects all of the changes that are made. By keeping track of the electrical consumption it will be clear when changes are made whether or not those changes were beneficial. This documentation will facilitate further reductions in the Forest Service's electrical consumption.

In the Palo Colorado Recreation Area shop, removing three of the seven fluorescent bulbs in the lighting fixtures can reduce lighting costs. This alone would save about 112 kWh per year of electrical energy. Figure 4.4 shows the current lighting arrangement at the Palo Colorado shop. Red "X"s indicate the lights that could potentially be removed.

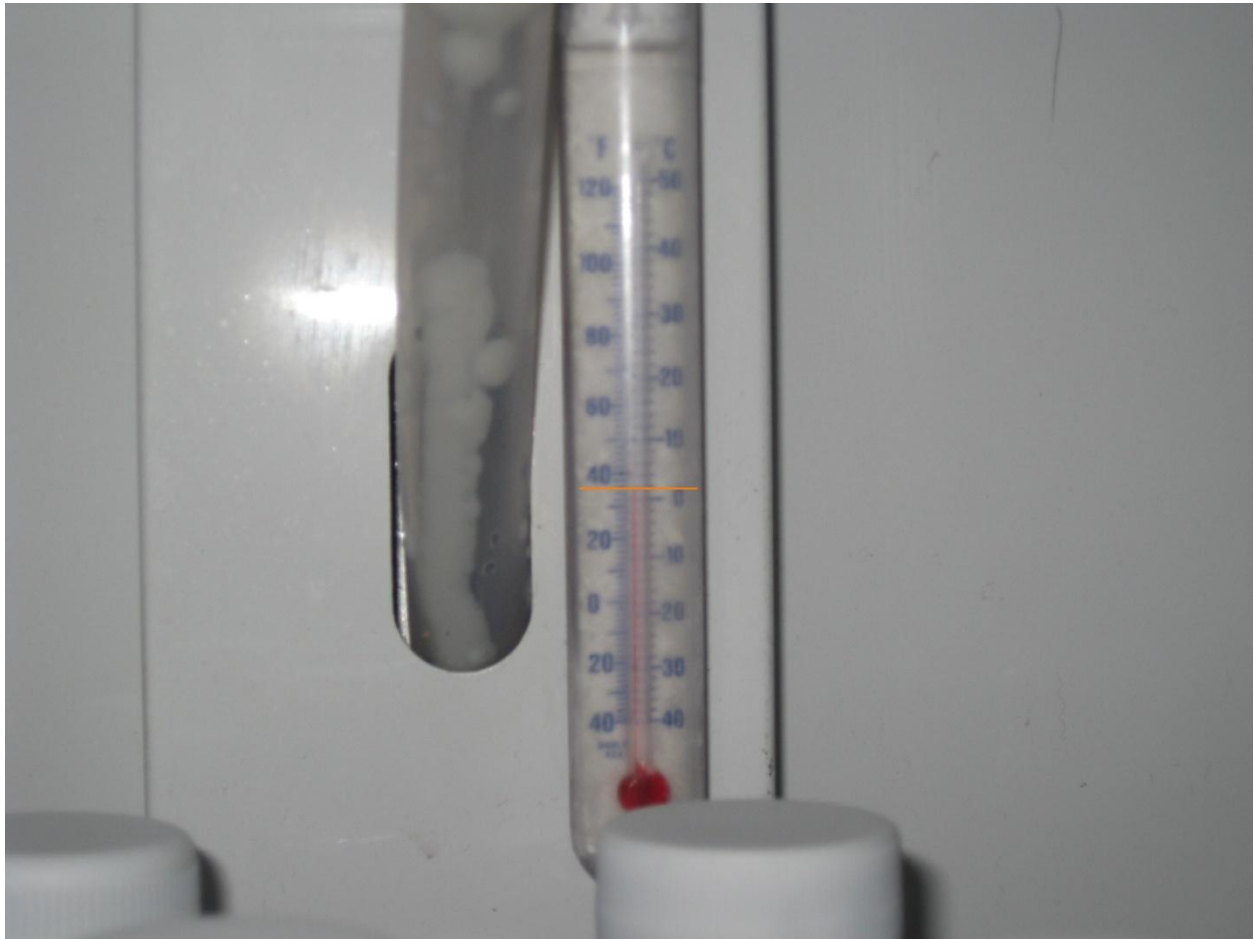

**Figure 4.4: Possible Lighting Reduction Plan at Palo Colorado Recreation Area Shop**

Appliances play a seemingly small role in the overall energy consumption of the Forest's facilities, and as a result the first steps to reduce energy usage largely neglected their impact. At a glance most of the appliances at El Yunque seem out of date. It is recommended that energy Star appliances be purchased, or at least used to replace any appliance that fails.

Refrigerators that contain food need to run at cool temperatures constantly to prevent health issues, but beverage refrigerators can operate effectively at slightly higher temperatures. All of the beverage refrigerators throughout the food service facilities run 24 hours per day, 365 days a year, and are set to very low temperatures. There are currently six major beverage refrigerators used throughout El Yunque. Two are located in the El Portal gift shop, one at the Yuquiuyu Delights food stand in El Portal, one in the Yuquiuyu Delights roadside restaurant, and two in the Palo Colorado Recreation Area. Combined, these units consume approximately 13,630 kWh per year. Figure 4.5 shows an example of a thermometer in a refrigerator in the El Portal gift shop that indicates the thermostat is set at about 35°F.





**Figure 4.5: Thermometer Inside of a Drink Refrigerator in El Portal Gift Shop**

All six refrigerators have similar low temperature settings. The team recommends that the temperature of beverage coolers be raised to save electricity. Raising the temperature of the refrigeration units by 5° F in the article by *Home Energy Magazine* yielded an energy savings of 18% (Meier, 1994). The team estimates that increasing settings by 10° F in all of the drink dedicated refrigerators throughout El Yunque would decrease their energy consumption by 32%. This estimate was made under the assumption that an additional 5°F increase would reduce energy consumption by another 18%. Throughout the Forest a 10°F increase in all of the beverage refrigerators would save about 4,360 kWh per year. Most of the refrigerators have built in adjustable thermostats to set their temperature, those that do not can be used in conjunction with a plug-in thermostat. Each unit should be set to the highest reasonable temperature.

Examples of 5°F and 10°F were used to show the effects of elevating the temperature settings, but the higher the temperature setting, the greater the energy savings will be.

Table 4.2 shows the relationship between the temperature settings of the beverage refrigerators located throughout El Yunque and the annual energy consumption in kWh. Current settings, a 5° F increase in current settings, and a 10° F increase in current settings are considered. The cost of operating all of the units for the three situations over a 25-year period assuming that energy costs remain at a constant \$0.25 per kWh, increase at an annual rate of 2.443 percent, and increase at an annual rate of 3 percent are included in Appendix I.

<b>Temperature Setting</b>	<b>kWh/year</b>
Current Settings	13,630.0
5° F Increase	11,176.6
10°F Increase	9,268.4

**Table 4.2: Energy Cost Associated with Various Refrigeration Temperature Settings**

An electric hot water heater located on the first level of the Catalina Service Center supplies hot water to the kitchen and the showers. Ortiz’s audit recommends that the water heater be set to run for an hour each morning, turned on manually 15 minutes before shower use, and then turned off manually after shower use. However under the current conditions the water heater is on continuously 365 days a year. The team suggests that the administration consider discontinuing the usage of the water heater. Removing the water heater from service would save 21,600 kWh per year (\$5,400 per year at current energy rates).

If hot water is a necessity it is recommended that the implementation of a solar hot water heater is investigated. Another option is installing an on demand electric water heater that only runs when the hot water in the showers or the kitchen is turned on. The PowerStar AE 125 Electric Tankless Water Heater, available through The Home Depot, costs \$649. It is capable of elevating the temperature of 4 gallons of water 45° F each minute. The flow rate of each shower was measured to be 1.4 GPM, by filling a 7-gallon bucket in 5 minutes. By a similar means the flow rate of the kitchen sink was measured to be 1.5 GPM. Based on the flow rates of the showers and the kitchen sink, this water heater could supply an ample amount of hot water to run two showers, or a shower and the kitchen sink at the same time. Assuming that hot water is used

for about an hour each day of operation at the Catalina Service Center, the PowerStar AE 125 would consume about 7,500 kWh of electricity to operate each year, according to the manufacturer specifications. This is about a 65% reduction in the energy consumed by the current hot water heater (Home Depot, 2010). Allowing about \$350 for installation and removal of the existing water heater, the payback period for switching to the PowerStar water heater would be under a half of a year.

Table 4.3 shows the relationship between electric water heater options and the annual energy consumption in kWh. The two water heater options presented include the current water heater, and the PowerStar AE 125 tankless water heater. The cost of operation of each water heater for a 25-year period assuming that energy costs remain at a constant \$0.25 per KWH, increase at an annual rate of 2.443 percent, and increase at an annual rate of 3 percent are included in Appendix I.

<b>Water Heater</b>	<b>kWh/year</b>
Current Water Heater	21,600
PowerStar AE 125	7,500

**Table 4.3: Energy Cost Associated with Water Heater Options**

#### **4.2.3 Water Feature Pump**

Currently there is a 20 HP water pump that re-circulates the water that flows through two waterfalls and a small stream in El Portal. Manuel Ortiz calculated in his energy audit that when running 24 hours as recommended by the installer, the water pump alone was responsible for using about 20% of the total energy consumed by both El Portal and the Catalina Service Center. Ortiz’s recommendation to limit the operation of the pump to normal working hours has already reduced the power the pump is consuming by about 66%. Currently the 20 HP pump runs for 8 hours a day, 360 days a year, and consumes about 43,000 kWh a year. In order to calculate the actual power needed to operate the water feature under current flow conditions, the project team calculated the current flow rate of the water feature in El Portal.

The flow rate was calculated by first measuring the total linear footage of the waterfall in El Portal. A total measurement of 19’ was recorded. Then making the assumption that the flow

rate remained approximately constant over the entire width of the waterfall, a 2' section was re-directed so that all of the water came off in a single stream. The team then filled a 5-gallon bucket several times with only the flow from that stream, recording an average time of about 10 seconds. Based on this data, it calculated that about 30 gallons per minute flows for every 2 linear feet of waterfall. Extrapolating this data suggests a total flow rate of 285 gallons per minute. The horse power required to pump water is described by Equation 4.1 (Scherer, 1993).

**Equation 4.1: Required Pump Power for Water Using Specified Units:**

$$P_o = (H \cdot Q) / 3960 \cdot \eta_{\text{pump}} \cdot \eta_{\text{motor}}$$

**P<sub>o</sub>** = power required by pump (HP)

**H**= total pump head (ft)

**Q**= desired flow rate (GPM)

**η<sub>pump</sub>** = pump efficiency

**η<sub>motor</sub>** = motor efficiency

One way to reduce the power needed to pump the water into the holding reservoir on top of the waterfall feature is to reduce the total head of the system. Both gravitational and frictional head would be reduced if the pump were moved closer to the reservoir. Currently, when the water flows over the waterfall it falls 12' then flows down a small stream to a second collection point, moving down another 12.5'. This second drop in elevation doubles the pump head due to vertical elevation, causing a higher power demand. Another look at Equation 4.1 shows that reducing the flow rate of the fluid to a minimum will also reduce the power required to operate the pump.

The pipeline that comes in and out of the existing pump is 4 inches in diameter. At this diameter, every 10 linear feet of pipe adds 0.33' of head, each 90° elbow in the piping adds 10' of head, each 45° elbow adds 5' of head, each check valve adds 34' of head, and each gate valve adds 3' of head. Piping diagrams that were available on blue prints indicate that the pipe diameter changes from 4" to 2" at one point in the piping system, and also that the system is constructed with elbows, reducers, and valves. The total "as built" piping diagram was not available and therefore the total head of the current system could not be calculated. The team was able to

observe that the piping system that the pump currently uses to move water is far from ideal. Under properly designed conditions the total head would be approximately 100 feet. This figure for head considers the usage of 125' of 4" piping, 2-45° elbows, 2-90° elbows and a gate valve. The power required to pump 285 GPM using the ideal piping system with a 90% efficient electric motor powering an 85% efficient pump, would be about 9.5 HP. A 9.5 HP pump running for 8 hours a day, 360 days a year would consume approximately 20,400 kWh of energy a year. This calculation indicates that the current system requires over twice the amount of energy to operate per year than an effectively designed system (Money Saver Pumps, 2009).

Table 4.4 shows the relationship between piping and flow rate situations and the annual energy consumption in kWh for the water feature pump at El Portal. The three pumping situations include the current pump and piping system, the improved piping system outlined above used with a matched efficient programmable pump and motor, and the improved piping system used with a matched efficient programmable pump and motor with a 1/3 reduced flow rate. The cost of operation of the pump for all three situations over a 25-year period assuming that energy costs remain at a constant \$0.25 per KWH, increase at an annual rate of 2.443 percent, and increase at an annual rate of 3 percent are included in Appendix I.

<b>Pumping System</b>	<b>kWh/year</b>
Current Pumping System	43,000
Improved Piping System and Matched Efficient Pump/Motor	20,400
Improved Piping System, Matched Efficient Pump/Motor, 1/3 Reduced Flow	13,600

**Table 4.4: Energy Cost Associated With Various Water Feature Pumping Systems**

### **4.2.3 Air Conditioning**

Ortiz's energy audit for electricity use in Catalina and El Portal revealed that HVAC systems account for 48.7% of the daily electricity usage during summer months. Though HVAC systems run year round, it is expected that the amount of energy used for air conditioning is influenced by seasons. The examined electric bills have shown that only 81% of the average summer month kilowatt-hours are consumed in an average winter month. It is expected that this is the result of increased air conditioning use. Summer months are hot and humid, and demand more air conditioning than cooler, drier winter months. Daily HVAC use for summer was

provided by the energy audit, while information for winter months was not available to the team. Trends in the provided electricity bills were studied to determine which months had the highest electricity usage. For the purpose of this evaluation, it was determined that summer months will be April through September. The remaining months October through March will be considered winter months.

Due to actions taken by El Yunque staff, the total monthly energy use has decreased significantly over the last three years. Because of this reduction, average monthly electricity use was taken from PREPA bills for fiscal year 2009 only. The average use for summer months was calculated assuming that 48.7% of the total summer consumption is used for air conditioning, as specified in the Ortiz audit. The HVAC use for winter months was determined to be 81% of the summer use, or 39.4% of the total summer consumption. Using this value, available electric bills, and figures given in the energy audit, the team calculated seasonal energy usage for El Portal and the Catalina Service Center. Tables 4.5(a) and 4.5(b) show the total electricity consumption of El Portal and the Catalina Service Center for the average summer and winter months, as well as the electricity consumption devoted to HVAC for both summer and winter months.

Facility	Average Monthly Electricity Consumption	Average HVAC Electricity Consumption	Percent of Total Used for HVAC
El Portal	24,634.03 kWh	11,996.77 kWh	48.7%
Catalina	13,264.48 kWh	6,459.80 kWh	48.7%

**Table 4.5(a): 2009 Summer Monthly Use Averages for El Portal and Catalina**

Facility	Average Monthly Electricity Consumption	Average HVAC Electricity Consumption	Percent of Total Used for HVAC
El Portal	19,992.26 kWh	9,736.23 kWh	48.7%
Catalina	10,765.07 kWh	5,242.59 kWh	48.7%

**Table 4.5(b): 2009 Winter Monthly Use Averages for El Portal and Catalina**

Knowledge of the average monthly consumption of electricity allowed the team to perform a cost analysis for the implementation of Energy Star air conditioning units. EPA Energy Star ratings are given to appliances that are exceptionally efficient in terms of energy use.

Requirements for HVAC units depend on size and cooling capacity. The basic specifications for Energy Star qualification of commercial air conditioning units are shown in Table 4.6 (Department of Energy, 2010).

<b>Key Efficiency Criteria</b>		
<b>Equipment</b>	<b>Specification</b>	
<b>Central Air Conditioners</b>	<b>Size Category</b>	<b>Specification</b>
	<65,000 Btu/h	>=13 SEER
	>=65,000 Btu/h - <135,000 Btu/h	>=11.0 EER; >=11.4 IPLV
	>=135,000 Btu/h - <=250,000 Btu/h	>=10.8 EER; >=11.2 IPLV

**Table 4.6: Energy Star Qualification Criteria (Department of Energy, 2010)**

EER and SEER ratings are explained in the literature review of this paper. If the Forest’s air conditioning units were to be replaced with more energy efficient models, money would be saved on electric bills. An example might be replacing a SEER 10 unit, with one of SEER 13. The new unit would use 76.9% (10 divided by 13) as much electrical energy to handle the same cooling load as the old unit. This replacement would save 23.1% of the energy formerly used, and result in monetary savings that depend on the price of electricity.

The team inspected the SEER and EER ratings for the air conditioning units in place. The air conditioning units in use at Catalina are listed in provider product data as having SEER’s ranging from 10 to 11.5 (see Appendix E for HVAC product data). The average SEER per ton of cooling capacity was 11. Ratings for El Portal’s units are given in terms of EER, with an average EER of 11. The team did not have the tools to calculate the actual efficiency of the units, so cost analysis is performed using energy efficiency ratings available. However, a unit’s efficiency will decrease over time, and the models in place are as many as twelve years old. This means that the actual efficiency is most likely lower than the listed values. In addition, the ratios listed are nominal values, meaning that the given ratio is only correct if the unit is sized properly, operating under ideal conditions, and well maintained.

The team calculated savings for using Energy Star units. The first analysis displays the yearly savings that could be realized by implementing energy efficient compressor units. This analysis shows a savings compared to what would be spent if no changes were made. Table 4.7

shows the money saved with varying efficiencies. SEER corresponds to Catalina compressor units, while EER corresponds to El Portal units. Analysis shows the projected savings each year based on a 2.443% annual inflation rate, which was calculated based on projected oil prices from the EIA. Each increment in price per kWh represents one fiscal year, starting with \$0.25 for 2010. The column “SEER and EER 11” represents the current system, with Catalina units of SEER 11 and El Portal units of EER 11, and shows no savings.

<b>EFFICIENCY</b>	<b>NO CHANGE</b>	<b>SEER 13 AND EER 12</b>	<b>SEER 14 AND EER 13</b>	<b>SEER 15 AND EER 14</b>	<b>SEER 16 AND EER 15</b>
<b>\$/KWH</b>					
<b>0.25</b>	\$0.00	\$5,202.60	\$8,447.10	\$11,237.67	\$13,663.41
<b>0.2561075</b>	\$0.00	\$5,329.70	\$8,653.46	\$11,512.21	\$13,997.21
<b>0.262364206</b>	\$0.00	\$5,459.90	\$8,864.87	\$11,793.45	\$14,339.16
<b>0.268773764</b>	\$0.00	\$5,593.29	\$9,081.44	\$12,081.56	\$14,689.46
<b>0.275339907</b>	\$0.00	\$5,729.93	\$9,303.29	\$12,376.72	\$15,048.33
<b>0.282066461</b>	\$0.00	\$5,869.92	\$9,530.57	\$12,679.08	\$15,415.96
<b>0.288957344</b>	\$0.00	\$6,013.32	\$9,763.41	\$12,988.83	\$15,792.57
<b>0.296016572</b>	\$0.00	\$6,160.22	\$10,001.93	\$13,306.15	\$16,178.38
<b>0.303248257</b>	\$0.00	\$6,310.72	\$10,246.27	\$13,631.22	\$16,573.62
<b>0.310656612</b>	\$0.00	\$6,464.89	\$10,496.59	\$13,964.23	\$16,978.51
<b>0.318245953</b>	\$0.00	\$6,622.83	\$10,753.02	\$14,305.37	\$17,393.30
<b>0.326020702</b>	\$0.00	\$6,784.62	\$11,015.72	\$14,654.85	\$17,818.22
<b>0.333985388</b>	\$0.00	\$6,950.37	\$11,284.83	\$15,012.87	\$18,253.52
<b>0.342144651</b>	\$0.00	\$7,120.17	\$11,560.52	\$15,379.63	\$18,699.45
<b>0.350503244</b>	\$0.00	\$7,294.11	\$11,842.94	\$15,755.36	\$19,156.28
<b>0.359066039</b>	\$0.00	\$7,472.31	\$12,132.27	\$16,140.26	\$19,624.27
<b>0.367838022</b>	\$0.00	\$7,654.86	\$12,428.66	\$16,534.57	\$20,103.69
<b>0.376824305</b>	\$0.00	\$7,841.86	\$12,732.29	\$16,938.51	\$20,594.82
<b>0.386030123</b>	\$0.00	\$8,033.44	\$13,043.34	\$17,352.32	\$21,097.95
<b>0.395460838</b>	\$0.00	\$8,229.70	\$13,361.99	\$17,776.23	\$21,613.37
<b>0.405121947</b>	\$0.00	\$8,430.75	\$13,688.42	\$18,210.51	\$22,141.39
<b>0.415019076</b>	\$0.00	\$8,636.71	\$14,022.83	\$18,655.39	\$22,682.30
<b>0.425157992</b>	\$0.00	\$8,847.71	\$14,365.41	\$19,111.14	\$23,236.43
<b>0.435544602</b>	\$0.00	\$9,063.86	\$14,716.36	\$19,578.03	\$23,804.10
<b>0.446184956</b>	\$0.00	\$9,285.29	\$15,075.88	\$20,056.32	\$24,385.63

**Table 4.7: Yearly Savings by Efficiency and Price/kWh**

A long term analysis was performed for a 25-year period. This includes the annual EIA projected inflation rate. If no changes are made, the Forest will spend \$1,640,558.72 in



electricity for HVAC units over the next 25-years. Should they choose to implement units with the highest efficiency presented (SEER 16 and EER 15), this cost would drop to \$1,177,277.38, saving over \$460,000.00 during the 25-year period. This data is presented in Table 4.8. This analysis represents only savings due to reduced electricity usage, it does not include installation and maintenance costs. Estimated payback periods that include initial purchase of new air conditioning units can be found in Appendix H.

<b>\$/KWH</b>	<b>NO CHANGE</b>	<b>SEER 13 AND EER 12</b>	<b>SEER 14 AND EER 13</b>	<b>SEER 15 AND EER 14</b>	<b>SEER 16 AND EER 15</b>
<b>\$0.25</b>	\$48,384.48	\$43,181.88	\$39,937.38	\$37,146.81	\$34,721.07
<b>\$0.26</b>	\$97,950.99	\$87,418.69	\$80,850.43	\$75,201.12	\$70,290.38
<b>\$0.26</b>	\$148,728.42	\$132,736.21	\$122,762.99	\$114,185.09	\$106,728.64
<b>\$0.27</b>	\$200,746.33	\$179,160.84	\$165,699.47	\$154,121.44	\$144,057.09
<b>\$0.28</b>	\$254,035.04	\$226,719.62	\$209,684.88	\$195,033.44	\$182,297.48
<b>\$0.28</b>	\$308,625.60	\$275,440.26	\$254,744.87	\$236,944.92	\$221,472.07
<b>\$0.29</b>	\$364,549.80	\$325,351.14	\$300,905.66	\$279,880.29	\$261,603.71
<b>\$0.30</b>	\$421,840.23	\$376,481.35	\$348,194.17	\$323,864.58	\$302,715.75
<b>\$0.30</b>	\$480,530.27	\$428,860.67	\$396,637.93	\$368,923.40	\$344,832.17
<b>\$0.31</b>	\$540,654.11	\$482,519.62	\$446,265.18	\$415,083.01	\$387,977.49
<b>\$0.32</b>	\$602,246.77	\$537,489.45	\$497,104.81	\$462,370.29	\$432,176.85
<b>\$0.33</b>	\$665,344.13	\$593,802.20	\$549,186.47	\$510,812.81	\$477,456.00
<b>\$0.33</b>	\$729,982.97	\$651,490.67	\$602,540.47	\$560,438.78	\$523,841.32
<b>\$0.34</b>	\$796,200.94	\$710,588.46	\$657,197.91	\$611,277.11	\$571,359.83
<b>\$0.35</b>	\$864,036.60	\$771,130.02	\$713,190.64	\$663,357.42	\$620,039.22
<b>\$0.36</b>	\$933,529.50	\$833,150.61	\$770,551.27	\$716,710.05	\$669,907.85
<b>\$0.37</b>	\$1,004,720.10	\$896,686.35	\$829,313.21	\$771,366.08	\$720,994.77
<b>\$0.38</b>	\$1,077,649.90	\$961,774.28	\$889,510.72	\$827,357.37	\$773,329.74
<b>\$0.39</b>	\$1,152,361.36	\$1,028,452.31	\$951,178.84	\$884,716.52	\$826,943.26
<b>\$0.40</b>	\$1,228,898.03	\$1,096,759.28	\$1,014,353.52	\$943,476.95	\$881,866.55
<b>\$0.41</b>	\$1,307,304.49	\$1,166,734.99	\$1,079,071.56	\$1,003,672.90	\$938,131.62
<b>\$0.42</b>	\$1,387,626.42	\$1,238,420.20	\$1,145,370.66	\$1,065,339.44	\$995,771.25
<b>\$0.43</b>	\$1,469,910.61	\$1,311,856.69	\$1,213,289.44	\$1,128,512.50	\$1,054,819.01
<b>\$0.44</b>	\$1,554,205.01	\$1,387,087.23	\$1,282,867.48	\$1,193,228.87	\$1,115,309.31
<b>\$0.45</b>	\$1,640,558.72	\$1,464,155.65	\$1,354,145.32	\$1,259,526.26	\$1,177,277.38

**Table 4.8: Projected HVAC Expenditure over 25-Year Period at Varying Efficiency**

This analysis provides a rough estimate of the amount to be saved by installing Energy Star units. However, it is based on potentially outdated values and limited data. The team

recommends that a more thorough and lengthy analysis be performed on the HVAC systems in El Yunque. This will include measuring the power consumed by each HVAC component as well as how much cooling power it outputs, to reveal the actual efficiency of each unit and yield a more accurate cost analysis. The team suspects that the actual efficiency of each unit is much lower than the listed value, due to wear over time. If they indeed are lower than listed, new units would save even more electricity than the team has estimated.

Problems associated with oversized air conditioning systems have been outlined in the literature review section of this paper. Indications that the Catalina Service Center system is oversized include short running times of condenser units and the need for dehumidifiers in office spaces. The team observed one unit in particular that operated for 5 minute periods, shutting off for 8 minutes in between, which is extrapolated to about 46 cycles in a normal day. This unit has an LRA of 345, and an RLA of 67.9, so 345 amps are drawn 46 times every day, as opposed to the 67.9 that should be drawn in normal operation. This indicates excessive energy consumption for this particular unit. Because the unit is not on long enough to reach efficiency, it fails to dehumidify while at the same time using much more electricity than it would if it were running at longer intervals.

The team recommends that both El Portal and the Catalina Service Center be properly and professionally sized for air conditioning systems. This sizing should include a thorough analysis done using “Manual J” from the American Society of Heating, Refrigerating and Air-Conditioning Engineers (ASHRAE), which is the accepted standard for cooling load calculation. A proper sizing includes evaluation of wall insulation and thickness; building sizes; duct work; number, size, and material of windows; number of occupants; and other variables listed in Manual J. No units should be purchased before this is performed, because the necessary cooling power will not be known until a proper sizing is completed.

Once the buildings are sized, the Forest should invest in Energy Star HVAC components sized to handle the cooling load calculated with Manual J. The team cannot recommend specific units because the buildings have not yet been sized. It is recommended however, that the Forest purchase the most energy efficient units available. These units will use less energy than the current air conditioning system and lower electricity bills significantly. As the price per kilowatt-hour rises, using less electricity becomes more and more important, and the highest efficiency units will save much more money over time.

Should the Forest choose not to contract a sizing of the aforementioned buildings, the team would recommend that inverting condenser units be purchased. These units run at varying powers, and as result mitigate some of the problems of short cycling without contracting a professional to size the buildings. Inverter units should be ductless so that no energy is lost by faulty duct systems. These systems are generally more expensive than normal units, but eliminating short cycle will be cost effective over time.

Programmable thermostats were installed in both El Portal and the Catalina Service Center. The temperature settings are 73°F, and 72°F in El Portal and the Catalina Service Center respectively. It is recommended that the temperature settings be raised to between 78°F and 80°F. Currently the temperature settings within the buildings when they are unoccupied are 80°F. It is recommended that outside of normal operating hours the thermostats be raised to a higher setting or set to off, and the units be programmed to turn on an hour before employees arrive in the morning. Because actual efficiencies of the systems were impossible for the team to calculate accurately, no projection of the savings from these changes was made. Research indicates that the savings will be substantial (Progress Energy, 2010).

To ensure that there is a minimum amount of cold air within the building lost through leaks, all doors and windows should be sealed. Particular attention should be given to sealing doors that provide outside access. Problems observed by the team include open doors leading to an outside stair well in the Catalina Service Center, and a ventilation grate between the kitchen area and the first floor hallway, allowing conditioned air to escape.

Another way to reduce cooling costs would be to improve the conductive properties of the walls and ceilings of buildings by adding insulation. By adding 2.5” of insulation to the exterior or the interior of the concrete walls that currently exist, the R-value of that wall is increased by about 560% (McMichael, 2010). Contractors can insulate existing concrete buildings by either adding a layer of foam insulation to the outside of the building and covering it with traditional siding, or by building traditional walls inside of the building up against existing exterior concrete walls and insulating them. No studies were found regarding the effects of insulation on the cooling costs of a building in a rainforest. Consequently no viable method was available for the team to estimate the savings that could be obtained by insulating buildings within El Yunque.

#### **4.2.4 Roof Coatings / Passive Solar Cooling**

Reflective roof coatings and passive solar roof cooling are both conservation strategies that serve to prevent ambient attic air from dramatically heating a building during the day. Currently, the attic temperature at the Catalina Service Center is not being significantly affected by the temperature of the roof. The air conditioning ducts that run through the attic are insulated properly with reflective fiberglass insulation. The suspended ceiling tiles are made out of a light material that is designed to keep the attic heat from conducting into the cooled interior building space. The team observed these conditions during the winter season, and it is expected that they may change during the summer. It is recommended that the Forest Service periodically check the temperature of the ambient air in the attic over the course of a year. It is recommended that reflective coatings or passive solar cooling be used only if it is found that ambient attic air temperature is as much as 40°F higher than the outside ambient air temperature in the summer.

#### **4.3 Solar Power**

To determine the feasibility of solar power in El Yunque, the team needed to first determine the amount of solar radiation that the Forest receives annually. However, there is no existing solar radiation data available specific to El Yunque. According to the National Renewable Energy Laboratory, San Juan, Puerto Rico receives a daily average of 5.5 kWh/m<sup>2</sup>/day of solar radiation at latitude tilt at coordinates 18.43N 66.00W (National Renewable Energy Laboratory, 1990). According to 3Tier's FirstLook, these coordinates rank in the 57<sup>th</sup> percentile in global solar radiation resources (3Tier, 2010). 3Tier ranks the coordinates of El Portal and the Catalina Service Center, 18.339492N 65.761997W, in the 45<sup>th</sup> percentile in global solar radiation resources (3Tier, 2010). With the known average daily solar radiation value for San Juan and the global percentile rankings in solar resources for both the National Renewable Energy Laboratory's data collection site in San Juan and El Portal and the Catalina Service Center in El Yunque, a reasonable estimate is that El Yunque receives an average of 4.34 kWh/m<sup>2</sup>/day of solar radiation at latitude tilt using interpolation. Thus, the team estimates that El Yunque receives an average of 1584.1 kWh/ m<sup>2</sup>/year of solar radiation.

After examining El Yunque's existing infrastructure, the team identified and investigated six potential sites for solar power. El Portal, the Catalina Service Center, the Palo Colorado Recreation Area, Yuquiyu Delights Restaurant, El Yunque Peak, and El Verde Research Center. Of these six potential sites only El Portal and the Catalina Service Center were deemed feasible

sites for solar power. The roof spaces available at Palo Colorado Recreation Area, Yuquiuyu Delights Restaurant, and El Verde Research Center experience extensive shading from surrounding trees and do not face ideal directions. Solar collection at El Yunque Peak would be hindered by cloud cover, as it is immersed by clouds for a majority of the year.

Only the available roof space was considered at each of the sites. The team recommends that a separate study be conducted to consider using photovoltaic panels that stand alone without the support of a roof system. These systems could be placed in any clearing unobstructed by shading (e.g. parking lots).

Of the two potential sites, the three south facing roofs at El Portal were found to be better for solar power using the numerical site survey. These three roofs, labeled A, B, and C, are shown in Figure 4.6.

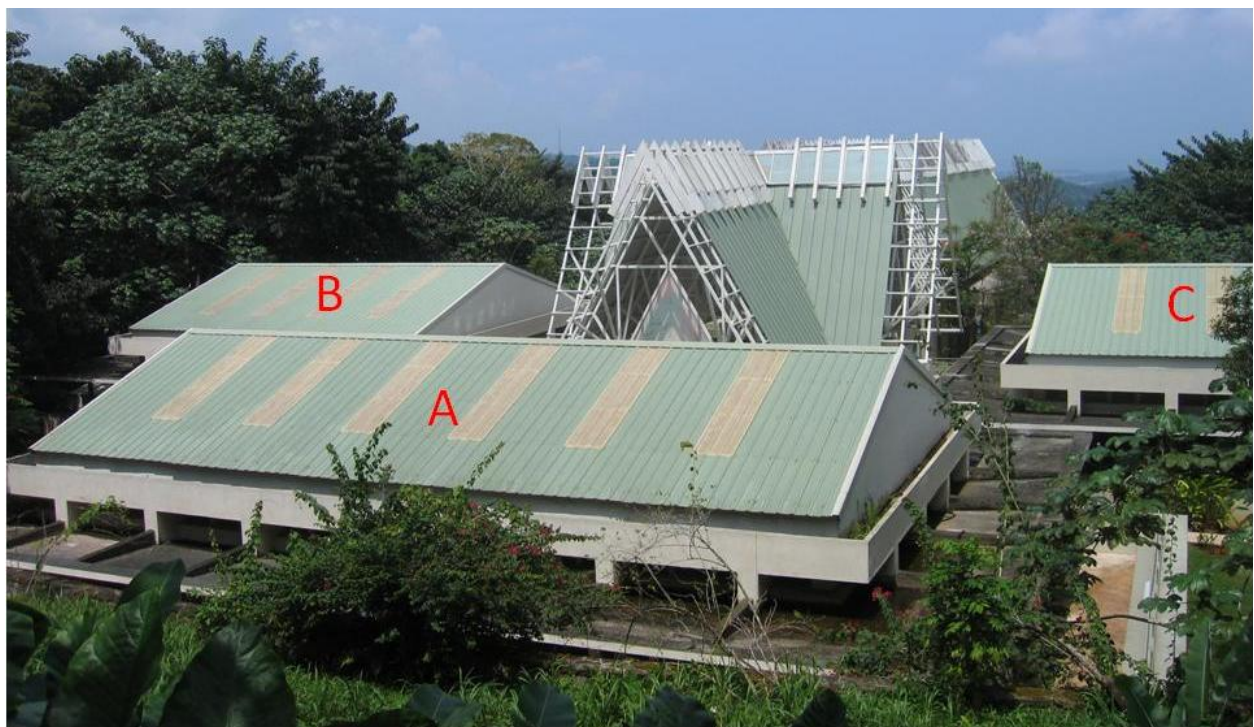

**Figure 4.6: Proposed Solar Power Sites at El Portal**

Each of these roofs at El Portal face south, experience no shading throughout the day, have close proximity to the electrical grid, are very accessible, are not visible from nature and hiking trails, and are in good condition. However, susceptibility to hurricane damage may require further investigation as El Portal did suffer extensive damage from Hurricane George in 1998

according to Property Management Team Leader Manuel Ortiz (Ortiz, 2010). Roof A has an area of 1837 sq ft, and roofs B and C both have areas of 1077 sq ft. The south facing roof at the Catalina Service Center was found to be the second choice for solar power by the numerical site survey, and is shown in Figure 4.7.



**Figure 4.7: Proposed Solar Power Site at the Catalina Service Center**

This roof at the Catalina Service Center faces south, experiences some shading throughout the day, has close proximity to the electrical grid, is very accessible, is not visible from nature and hiking trails, and is in good condition. The team recommends that trees X, Y, and Z in Figure 4.7 be removed in order to eliminate shading and ensure the highest possible production. The south facing roof at the Catalina Service Center has an area of 3223 sq ft excluding the overhang above the entryway.

For this study, the team considered 12,220W grid tied photovoltaic systems from Online Solar, Inc. Each 12,220W system consists of (52) 235W Sharp NU-U235F1 monocrystalline solar panels which occupy a total area of 912.1 sq ft, (1) 11,400W Fronius IG Plus inverter, (1) MidNite solar combiner with 600V DC fuses, (1) 60A/240V AC disconnect, NEMA 3R Outdoor

electrical box, (1) Delta 600V DC lightning arrestor, (4) 30' #10USE MC output cable. The major components of the system come with a warranty. The 235W Sharp NU-U235F1 solar panels come with a 25-year manufacturer's warranty, and the 11,400W Fronius IG Plus inverter comes with a 10 year manufacturer's warranty. This 12,220W system prices at \$44,660.00. The inverter has about half the warranty lifetime of the solar panels. A new 11,400W Fronius IG Plus inverter costs \$7000.00 from Online Solar, Inc. Mounting brackets and hardware for this system cost \$3140.00 (Online Solar Inc, 2010). A grid tied system is recommended over a battery storage system because it eliminates the need for several additional components such as batteries and charge controllers, and thus requires a lower initial investment. However, grid tied systems require a two way utility meter so that unused electricity can be sold back to the electric company. PREPA has only installed one way utility meters at all of El Yunque's facilities, so a two way utility meter would have to be installed at each site where a grid tied system is implemented. According to José Sanguinetti, an employee at All Solar of Puerto Rico Inc, PREPA will replace a one way meter with a two way meter at no cost except for labor which is approximately \$500.00 (Sanguinetti, 2010). The cost of labor for installing any photovoltaic system is generally \$1.75 per Watt (Affordable Solar, 2010). Therefore, one 12,220W photovoltaic system will cost \$21,385.00 for installation. Fortunately photovoltaic systems require no maintenance once installed except for cleaning, which can be done by El Yunque's staff for no additional charge. Including all of the necessary expenses, one 12,220W photovoltaic system will have a lifetime cost of approximately \$76,685.00 and an initial cost of \$69,685.00 while each additional system on the same utility meter will have a lifetime cost approximately \$76,185.00 and an initial cost of \$69,185.00.

The three south facing roofs at El Portal have the capability of supporting four 12,220W photovoltaic systems, two on roof A and one on both roof B and roof C, for a total capacity of 48,880W. Using Equation 3.1, the team found that at latitude tilt this system will produce 59,621.7 kWh annually and 1,490,543 kWh during its 25-year warranty lifetime. The payback period for this system under a 0% inflationary model, a 2.443% inflationary model (derived from the Energy Information Administration's projected crude oil prices), and a standard 3% inflationary model for future electricity prices is shown in Table 4.9, and plotted in Appendix F.

<b>Lifetime Cost for Photovoltaic System</b>	<b>Annual Electricity Production (kWh)</b>	<b>Average Annual Inflation in Electricity Cost</b>	<b>Cost per kWh from PREPA in 2010</b>	<b>Projected Cost per kWh from PREPA in 2035</b>	<b>Payback Period (Years)</b>	<b>Approximate Monetary Savings During 25-Year System Lifetime</b>
<b>\$305,240.00</b>	59,621.70	0%	\$0.25	\$0.25	20.5	\$67,395.74
<b>\$305,240.00</b>	59,621.70	2.44%	\$0.25	\$0.45	16.8	\$200,153.98
<b>\$305,240.00</b>	59,621.70	3.00%	\$0.25	\$0.51	16.2	\$238,200.83

**Table 4.9: Payback Period for 48.88kW Photovoltaic System at El Portal under Several Inflationary Models**

This analysis shows that solar power is a feasible option for electricity generation at El Portal under all of the inflationary models for future electricity costs. If electricity costs experience 2.443% annual inflation and reach \$0.45 per kWh by 2035 (as the team predicted based on oil price projections), the system will have a payback period of 16.8 years, and will save \$200,153.98 during its 25-year lifetime. The lifetime cost of \$305,240.00 is very large, and may not be within the Forest Service’s budget. Since the proposed 48,880W photovoltaic system is simply composed of four 12,220W systems, the payback period for one 12,220W system will be about the same for each respective economic condition and has a lifetime cost of \$76,685.00. However, the lifetime monetary electricity savings will be four times less.

The south-facing roof at the Catalina Service Center has the capability of supporting three 12,220W photovoltaic systems, for a total capacity of 36,660W. Using Equation 3.1, the team found that at latitude tilt this system will produce 44,716.3 kWh annually and 1,117,907 kWh during its 25-year warranty lifetime. The payback period for this system under a 0% inflationary model, a 2.443% inflationary model, and a standard 3% inflationary model for future electricity prices is shown in Table 4.10, and plotted in Appendix F.



<b>Lifetime Cost for Photovoltaic System</b>	<b>Annual Electricity Production (kWh)</b>	<b>Average Annual Inflation in Electricity Cost</b>	<b>Cost per kWh from PREPA in 2010</b>	<b>Projected Cost per kWh from PREPA in 2035</b>	<b>Payback Period (Years)</b>	<b>Approximate Monetary Savings During 25-Year System Lifetime</b>
<b>\$229,055.00</b>	44,716.30	0%	\$0.25	\$0.25	20.5	\$50,421.88
<b>\$229,055.00</b>	44,716.30	2.44%	\$0.25	\$0.45	16.8	\$149,990.70
<b>\$229,055.00</b>	44,716.30	3.00%	\$0.25	\$0.51	16.2	\$178,525.85

**Table 4.10: Payback Period for 36.66kW Photovoltaic System at the Catalina Service Center under Several Inflationary Models**

This analysis shows that solar power is a feasible option for electricity generation at the Catalina Service Center under all of the inflationary models for future electricity costs. If electricity costs experience 2.443% annual inflation and reach \$0.45 per kWh by 2035, the system will have a payback period of 16.8 years, and will save \$149,990.70 during its 25-year lifetime. The lifetime cost of \$229,055.00 is very large, and may not be within the Forest Service’s budget. Since the proposed 36,660W photovoltaic system is simply composed of three 12,220W systems, the payback period for one 12,220W system will be about the same for each respective economic condition and has a lifetime cost of \$76,685.00. However, the lifetime monetary electricity savings will be three times less.

#### **4.4 Hydropower**

After examining El Yunque’s hydropower resources within close proximity to the electrical grid along PR-191, the team determined that the Baño Grande Dam at the Palo Colorado Recreation Area was the only feasible site for hydropower, shown in Figure 4.8.



**Figure 4.8: Baño Grande Dam at the Palo Colorado Recreation Area**

The Baño Grande Dam creates approximately 14 feet of head and an approximate flow rate of 300 gallons per minute. Based on these characteristics, the team recommends a grid tied four nozzle “Steam Engine” Turgo turbine generator from Energy Systems & Design, Ltd. This turbine generator is capable of a maximum of one 1 kW, operating at 6-200 feet head, and 10-400 gallons per minute of flow. The “Steam Engine” turbine generator can be purchased directly from Energy Systems & Design, Ltd. for \$2,795.00 (Energy Systems & Design, 2010). Since the proposed turbine generator creates direct current, a DC to AC inverter will be required and need to be replaced once during the 25-year lifetime of the system. A Fronius 2,000W IG inverter costs \$1,710.00 from Online Solar, Inc (Online Solar Inc, 2010). There is a drain located on the dam denoted as “A” in Figure 4.8. If the turbine generator were placed near this drain, minimal piping would be needed to configure it to the reservoir having negligible cost. A lightning arrestor will be needed to protect the turbine generator from an electrical surge from the grid. A

Delta 600V DC lightning arrestor costs \$40.00 from Online Solar, Inc (Online Solar Inc, 2010). 400 feet of eight-gage outdoor electrical wire will be required to connect the turbine generator to the breaker box and utility meter at the Palo Colorado Recreation Area, and can be purchased from the Northern Arizona Wind & Sun for \$640.00 (Northern Arizona Wind & Sun, 2010). A grid tied system is recommended over a battery storage system because it eliminates the need for several additional components such as batteries and charge controllers and thus requires a lower initial investment. However, grid tied systems require a two way utility meter, so that unused electricity can be sold back to the electric company. PREPA has installed one way utility meters at all of El Yunque's facilities, so a two way utility meter would have to be installed at each site where a grid tied system is implemented. According to José Sanguinetti, an employee at All Solar of Puerto Rico Inc, PREPA will replace a one way meter with a two way meter at no cost except for labor which is approximately \$500.00 (Sanguinetti, 2010). Installation of a turbine generator system of this magnitude should take one day and does not require a professional, according to Pam Cunningham of Energy Systems & Design (Cunningham, 2010). However, if professionally installed, the team estimates that it will cost \$1,280.00. Replacement of parts within the turbine generator and other unforeseen costs will be an estimated \$1,325.00 throughout the lifetime of the system. El Yunque's staff, without additional cost, can perform general maintenance such as intake and turbine cleaning. The team estimates that the system will have a lifetime cost of \$10,000.00 and an initial cost of \$6,965.00.

Optimistically, the system would have a net head of 14 feet and experience no head loss due to the diameter, material, and bends in the piping system. Under these conditions, the team determined the system would have a capacity of 396W using Equation 3.2, and an annual output of 3,469 kWh if operational for 365 days per year. The payback period for this system under a 0% inflationary model, a 2.443% inflationary model (derived from the Energy Information Administration's projected crude oil prices), and a standard 3% inflationary model for future electricity prices is shown in Table 4.11, and plotted in Appendix G.

<b>Lifetime Cost for Hydro-Electric System</b>	<b>Annual Electricity Production (kWh)</b>	<b>Average Annual Inflation in Electricity Cost</b>	<b>Cost per kWh from PREPA in 2010</b>	<b>Projected Cost per kWh from PREPA in 2035</b>	<b>Payback Period (Years)</b>	<b>Approximate Monetary Savings During 25-Year System Lifetime</b>
<b>\$10,000.00</b>	3,469	0%	\$0.25	\$0.25	11.5	\$11,681.25
<b>\$10,000.00</b>	3,469	2.44%	\$0.25	\$0.45	10.3	\$19,405.60
<b>\$10,000.00</b>	3,469	3.00%	\$0.25	\$0.51	10	\$21,619.30

**Table 4.11: Payback Period for 396W Hydro-Electric System at the Baño Grande Dam under Several Inflationary Models**

This analysis shows that hydropower is a feasible option for electricity generation at the Baño Grande Dam under all of the inflationary models for future electricity costs. If electricity costs experience 2.443% annual inflation and reach \$0.45 per kWh by 2035 (as the team predicted based on oil price projections), the system will have a payback period of 10.3 years, and will save \$19,405.60 during its 25-year lifetime.

Pessimistically, the system would have a net head of 10 feet and experience four feet of head loss due to the diameter, material, and bends in the piping system. Under these conditions, the team determined the system would have a capacity of 283W using Equation 3.2, and an annual output of 2,479 kWh if operational for 365 days per year. The payback period for this system under a 0% inflationary model, a 2.443% inflationary model, and a standard 3% inflationary model for future electricity prices is shown in Table 4.12, and plotted in Appendix F.

<b>Lifetime Cost for Hydro-Electric System</b>	<b>Annual Electricity Production (kWh)</b>	<b>Average Annual Inflation in Electricity Cost</b>	<b>Cost per kWh from PREPA in 2010</b>	<b>Projected Cost per kWh from PREPA in 2035</b>	<b>Payback Period (Years)</b>	<b>Approximate Monetary Savings During 25-Year System Lifetime</b>
<b>\$10,000.00</b>	2,479	0%	\$0.25	\$0.25	16.1	\$5,493.75
<b>\$10,000.00</b>	2,479	2.44%	\$0.25	\$0.45	13.8	\$11,013.69
<b>\$10,000.00</b>	2,479	3.00%	\$0.25	\$0.51	13.4	\$12,595.63

**Table 4.12: Payback Period for 283W Hydro-Electric System at the Baño Grande Dam under Several Inflationary Models**

This analysis shows that hydropower is a feasible option for electricity generation at the Baño Grande Dam under all of the inflationary models for future electricity costs. If electricity costs experience 2.443% annual inflation and reach \$0.45 per kWh by 2035, the system will have a payback period of 13.8 years, and will save \$11,013.69 during its 25-year lifetime.

#### **4.5 Geothermal Power**

The team did not have sufficient resources to evaluate the potential of a ground source cooling system. Research shows that geothermal systems are more effective in climates that experience large changes in temperatures between seasons. This is because geothermal heat pumps are most cost effective in heating mode. In Puerto Rico, temperatures are relatively high year round, and space heating is generally not necessary. It could be expected that El Yunque would not experience the same level of energy savings seen in other applications of geothermal heat pumps.

Though the return on a ground source system may not be as great in Puerto Rico as they are in other climates, a ground source heat pump should still be investigated simply because of the high electricity use for air conditioning in El Yunque. The team recommends again that a professional be contracted to estimate the cost and production of a ground source system. There were previously concerns that invasive construction would eliminate geothermal power as a solution. This does not appear to be a problem, as there has already been considerable construction in and around the Catalina and El Portal areas.

#### **4.6 Summary**

This investigation found many conservation techniques and energy sources to be feasible use in El Yunque National Forest. Conservation techniques will reduce unnecessary energy use and expenses in the Forest, while alternative energy sources can produce electrical energy for use in the Forest, further reducing energy related expenses. The next chapter summarizes the findings of the team and the effectiveness of each conservation technique and alternative energy option.

## **CHAPTER 5: CONCLUSIONS AND RECOMMENDATIONS**

After examining the results of investigations and cost analysis, this project produced conclusions and recommendations that were based on the information discovered. Considering the issues of financing, sustainability, responsible land management, and environmental concerns, the team has made the following recommendations to the United States Forest Service and El Yunque National Forest.

### **5.1 Conservation Methods**

This project has outlined and investigated several possible conservation techniques. This section summarizes the most plausible and effective techniques for implementation in El Yunque National Forest including recycling, reducing, reusing, appliances and lighting, water feature pump, air conditioning, and roof coatings and passive solar cooling.

#### **5.1.1 Recycling, Reducing, Reusing**

Actions must be taken to improve the current recycling system within the Forest for both employees and visitors. To minimize the amount of recyclable office waste being disposed of in the Catalina Service Center and El Portal, each workstation should be equipped with a small recycling container to accompany the existing trash container. Furthermore a formal recycling policy should be drafted and distributed to employees, and reminders should be posted to ensure that the policy is observed.

To address visitor generated waste and recyclables, the team recommends that a carry in carry out policy be implemented. After the implementation of the carry in carry out policy each of the receptacles previously used to contain visitor waste should be re-labeled as a visitor recycling container. To further reduce the amount of solid waste being generated compost containers should also be placed in each location where food is served in the Forest. Following these recommendations would reduce the total amount of waste generated per week to an amount that could easily be contained by one eight yard dumpster. Altering the current contract with A & A Waste Management such that only one eight yard dumpster is picked up each week would save the Forest Service \$8,142 annually.

Further measures should be made to reduce the amount of materials purchased and to reuse materials in the office setting. Converting to a paperless office will further reduce the amount of waste generated, and the cost of purchasing office supplies. It is also recommended

that packing materials be saved when packages arrive and reused to send items out of the office. A policy should be drafted that discourages employees from using items designed to be disposable whenever possible, including paper plates and napkins used for meals.

### **5.1.2 Appliances and Lighting**

The first recommended step concerning the energy consumption of lighting is completion of a new spreadsheet that reflects the previous changes made as result of conservation efforts. This document should provide the current expected energy consumption due to lighting. As further changes are made to the lighting system this document should be updated, and compared with energy bills to determine whether or not the changes that are made are effective.

To reduce the energy that indoor lights consume, all unnecessary fixtures should be identified. After the safety of removing light bulbs from each fixture is assessed, light bulbs should be removed in a fashion that provides the minimum amount of light necessary without causing employee discomfort or breaking building codes. The team recommends working toward a goal of reducing indoor lighting costs by 25% by reducing the number of fixtures used and or the number of bulbs used per fixture. Motion sensors should be used in kitchen areas, copying areas, and bathrooms. Time settings on the motion sensors in the kitchens and copying areas should be set to around 2.5 minutes, and about 10 minutes in bathrooms. Finally a light use policy should be drafted that informs employees that lights should be turned off when leaving a room and reminders should be placed next to light switches.

Outdoor lighting is a large consumer of electricity and the team recommends that the safety of discontinuing its use be assessed. If it is deemed safe, the use of outdoor lighting should be discontinued. If it is determined that outdoor lighting is necessary the parking lot lights should be retrofitted with bi-level LED luminaries and motion sensors. In order to determine whether or not motion sensors should be implemented on all other outdoor lighting, a price quote should be requested from a vender of outdoor motion sensors. Any fixture that would provide a reasonable payback period as determined by management should also be equipped with a motion sensor.

In order to reduce the electricity consumed by drink dedicated refrigerators, the temperatures should be elevated by at least 10°F. A 10°F increase in temperature settings in the drink refrigeration units at El Portal, the Yuquiyu Delights roadside restaurant, and the Palo Colorado Recreation Area will reduce electrical consumption by about 4,360 kWh per year. As a general rule the highest reasonable temperature setting for each unit should be set to ensure

maximum savings. Furthermore, drink refrigerators should be set on timers so that they are off at night, but turn on in time to cool beverages by the time visitors and employees arrive.

Finally, the need for hot water at the Catalina Service Center should be assessed. The team recommends that the water heater be entirely removed; this would generate a savings of about 21,600 kWh per year. If it is determined that hot water is required, an investigation of using a solar hot water heater should be conducted. Another option that should be considered is installing a tankless water heater. The PowerStar AE 125 tankless water heater that is recommended would reduce energy consumption for water heating by 14,100 kWh per year, and have a payback period of less than a half of a year.

### **5.1.3 Water Feature Pump**

The actual power that is required to pump water through the existing pipe system of the El Portal water feature needs to be determined. A professional should be contracted to calculate the head of the existing piping system. Once the actual head of the system is known, Equation 4.1 can be used to calculate the necessary power required by the pump. For this calculation the motor efficiency should be 0.9, and the pump efficiency should be 0.85 (these are achieved by efficient modern motors and pumps). Once the required power is known, it should be determined whether it will be cost effective to redesign and install a piping system that reduces the head of the current system. Assuming the proposed piping system with about 100 ft of head, powered by a matched efficient motor and pump, the team calculated an energy savings of about 22,600 kWh per year. If the piping system is not replaced, a cost benefit analysis of a less powerful and more efficient pump should be performed.

If it is determined that a smaller pump is adequate and the piping system is not changed, the Forest should consider purchasing a pump available through Money Saver Pumps. Money Saver Pumps provides pumps equipped with a digital timer and flow control unit. This type of pump can be programmed to operate only during hours when visitors are in El Portal. It can also be adjusted to pump only enough water to produce the minimum flow rate required by the water feature.

### **5.1.4 Air Conditioning**

The first step toward reducing the energy consumption of the air conditioning system is to reduce the cooling needs. All doors and windows should be sealed and remain closed while the air conditioning is on. Doors that provide outside access require particular attention with this



issue. Temperature settings should be turned up to 78°F or higher, and units should be programmed to turn off at the end of the workday and turn on about an hour before the workday starts. Finally, a quote from a contractor for the insulating the exterior walls of the building should be obtained. It is important to consider insulating the building before purchasing new units because insulation will affect the sizing of the new system.

The team recommends that the two main buildings be sized by an HVAC professional. Specific instructions for this sizing are found in section 4.2.3 of this paper. This would eliminate the need for dehumidifiers and lessen the amount of power consumed by HVAC components. It is also recommended that the current HVAC equipment be replaced with Energy Star units. The current components are outdated and severely inefficient compared to the modern technology.

Cost analysis has shown that Energy Star units are a solid investment for El Yunque. As the price of electricity rises, Energy Star units will increase in value in terms of saving money. Actions should be taken as soon as possible to improve the air conditioning system and lower the expenditures that are due to inefficient equipment.

#### **5.1.5 Roof Coatings / Passive Solar Cooling**

To determine if roof coatings and or passive solar cooling will benefit the Catalina Service Center, data on the temperature of the attic must be collected. If the attic temperature remains relatively low over the course of a year, then roof coatings and passive solar cooling should not be implemented. Conversely, if it is recorded that the attic temperature becomes extremely high, more than 40° F above the temperature of the ambient outdoor air, implementing these conservation techniques should be considered.

#### **5.2 Photovoltaic Electricity Generation**

The team recommends that El Yunque National Forest install photovoltaic systems on both El Portal and the Catalina Service Center. As shown by the cost analysis in the previous chapter, these systems would have a payback period of 20.5 years or less and save a considerable amount of money in electricity expenditure during their 25-years lifetime under all of the annual inflation models for future electricity costs, including no inflation. Solar power is a very sustainable means of electricity production as it provides energy as long as there is sunlight, and it complies with the concept of responsible land management since it does not emit any harmful byproducts or have any negative effects on the environment. Therefore, the image of the Forest in terms of sustainability and environmental awareness would consequentially be heightened. For

the purpose of this study the team considered prepackaged 12.22 kW photovoltaic systems with 235W Sharp solar panels from Online Solar, Inc. However, the team recommends that if it decides to move forward with this project, the Forest consult with local solar power equipment retailers and installers such as All Solar of Puerto Rico, Inc. who were very reasonable and helpful in providing information for this study.

### **5.3 Hydropower**

The team recommends that El Yunque National Forest install a “Steam Engine” hydroelectric turbine generator system at the Baño Grande Dam at the Palo Colorado Recreation Area. The cost analysis presented indicates that this system would have a payback period of 16.1 years or less and save a substantial amount of money in electricity expenditure during its 25-years lifetime under all of the annual inflation models for future electricity costs, including no inflation. Hydropower is a sustainable means of electricity production at the Baño Grande Dam that would provide power as long as there is water in the pool. This choice fits well with the concept of responsible land management. It would not emit any harmful byproducts, nor would it cause any more negative effects on the ecology of the river than have already been created by the existing dam. This study considered other components such as the inverter, lightning arrestor, and wiring from several Internet distributors. However, the team recommends that the Forest Service consult with local hydropower equipment retailers and installers if it decides to move forward with this project.

## REFERENCES

- 3 TIER. (2010). *3 TIER FirstLook-wind, solar, hydro*. Retrieved February 21, 2010, from <http://www.3tier.com/firstlook/>
- Affordable Solar Group LLC. (2010). *Grid tied systems*. Retrieved April 12, 2010, from <http://www.affordable-solar.com/grid.tie.htm>
- Air-Conditioning, Heating, and Refrigeration Institute. (2008). *2008 Standard for Performance Rating of Unitary Air-Conditioning and Air-Source Heat Pump Equipment* (Publication. 2008: AHRI). Retrieved April 19, 2010, from <http://ari.org/ARI/util/showdoc.aspx?doc=1028>
- Appalachian State University. (2007). *Fact Sheet: Micro Hydro*. Retrieved March 24, 2010, from [http://www.wind.appstate.edu/reports/microhydro\\_factsheet.pdf](http://www.wind.appstate.edu/reports/microhydro_factsheet.pdf)
- Beer, J. (2008). *Fossil Fuel Power Plant*. Retrieved February 10, 2010, from [http://www.eoearth.org/article/Fossil\\_fuel\\_power\\_plant](http://www.eoearth.org/article/Fossil_fuel_power_plant)
- Berkhuizen, J. C., & Slob, A. F. L. (1989). The Impact of Environmental Aspects on Wind Energy in the Netherlands. In D. T. Swift-Hook (Ed.), *Wind Energy and the Environment* (First ed., pp. 6-7-13). London, United Kingdom: Peter Peregrinus Ltd.
- Bing, J. (1998, Nov/Dec). P.V. in Paradise. *Solar Today Magazine*, Retrieved February 12, 2010 from <http://www.newenergyoptions.com/magazine.php?d=1>
- Brookshier, P. (2004). Hydropower Technology. In Cutler J. Cleveland (Ed.), *Encyclopedia of Energy* (pp. 333-341). New York: Elsevier.
- Byrne, B. W., & Houlsby, G. T. (2003). Foundations for Offshore Wind Turbines. *Philosophical Transactions: Mathematical, Physical and Engineering Sciences*, 361(1813, Mathematics, Physics and Engineering), 2909-2930. Retrieved February 15, 2010, from <http://www.jstor.org/stable/3559281>
- Cada, G., Sale, M., & Dauble, D. (2004). Hydropower, Environmental Impact of. In Cutler J. Cleveland (Ed.), *Encyclopedia of energy* (pp. 291-300). New York: Elsevier.
- Cheremisnoff, N. P. (1978). *Fundamentals of Wind Energy* (first ed.). Ann Arbor Michigan: Ann Arbor Science.
- Corkish, R. (2004). Solar cells. In Cutler J. Cleveland (Ed.), *Encyclopedia of energy* (pp. 545-557). New York: Elsevier. Cunningham, P. (2010). Baldwin S. (Ed.), *Personal Communication*

- DeCarolis, J. F., Keith, D. W., Jacobson, M. Z., & Masters, G. M. (2001). The Real Cost of Wind Energy. *Science*, 294(5544), 1000-1003. Retrieved February 15, 2010 from <http://www.jstor.org/stable/3084930>
- Deering, A., & Thornton, J. P. (1999). Applications of Solar Technology for Catastrophe Response, Claims Management, and Loss Prevention. *National Renewable Energy Laboratory*, Retrieved February 11, 2010, from <http://www.nrel.gov/docs/fy99osti/25866.pdf>
- Department of Energy. (1999). *Showering With the Sun at Chickasaw National Recreation Area*. Retrieved February 23, 2010, from <http://www1.eere.energy.gov/femp/pdfs/25376.pdf>
- Department of Energy. (2005). *Types of Hydropower Plants*. Retrieved February 10, 2010, from [http://www1.eere.energy.gov/windandhydro/hydro\\_plant\\_types.html](http://www1.eere.energy.gov/windandhydro/hydro_plant_types.html)
- Department of Energy. (2005). *Types of Hydropower Turbines*. Retrieved March 30, 2010, from [http://www1.eere.energy.gov/windandhydro/hydro\\_turbine\\_types.html](http://www1.eere.energy.gov/windandhydro/hydro_turbine_types.html)
- Department of Energy. (2008). *Hydrothermal Power Systems*. Retrieved March 29, 2010, from <http://www1.eere.energy.gov/geothermal/powerplants.html#drysteam>
- Department of Energy. (2009). *Active, Closed Loop Solar Hot Water Heater*. U.S. Department of Energy. Retrieved April 23, 2010, from [http://www.energysavers.gov/your\\_home/water\\_heating/index.cfm/mytopic=12850](http://www.energysavers.gov/your_home/water_heating/index.cfm/mytopic=12850)
- Department of Energy. (2009). *Clean Cities Alternative Fuel Price Report* (Publication United States Department of Energy. (Fuel Price Report))
- Department of Energy. (2009). *Energy Savers, Central Air Conditioners*. Retrieved March 25, 2010, from [http://www.energysavers.gov/your\\_home/space\\_heating\\_cooling/index.cfm/mytopic=12440?print](http://www.energysavers.gov/your_home/space_heating_cooling/index.cfm/mytopic=12440?print)
- Department of Energy. (2009). *International Energy Outlook 2009*. Retrieved March 23, 2010, from [http://www.eia.doe.gov/oiaf/ieo/liquid\\_fuels.html](http://www.eia.doe.gov/oiaf/ieo/liquid_fuels.html)
- Department of Energy. (2009). *Microhydropower Systems*. Retrieved February 9, 2010, from [http://www.energysavers.gov/your\\_home/electricity/index.cfm/mytopic=11050](http://www.energysavers.gov/your_home/electricity/index.cfm/mytopic=11050)
- Department of Energy. (2009). *Residential Grid Connected PV System* U.S. Dept. of Energy. Retrieved February 17, 2010, from [http://www.energysavers.gov/your\\_home/electricity/index.cfm/mytopic=10720](http://www.energysavers.gov/your_home/electricity/index.cfm/mytopic=10720)
- Department of Energy. (2009). *Solar Hot Water Heaters*. Retrieved February 9, 2010, from [http://www.energysavers.gov/your\\_home/water\\_heating/index.cfm/mytopic=12850](http://www.energysavers.gov/your_home/water_heating/index.cfm/mytopic=12850)

- Department of Energy. (2010). *Benefits of Geothermal Heat Pump Systems*. Retrieved March 24, 2010, from [http://www.energysavers.gov/your\\_home/space\\_heating\\_cooling/index.cfm/mytopic=12660](http://www.energysavers.gov/your_home/space_heating_cooling/index.cfm/mytopic=12660)
- Department of Energy. (2010). *Energy Savers*. Retrieved February 10, 2010, from <http://www.energysavers.gov/>
- Department of Energy. (2010). *Purchasing and Procurement*. Retrieved April 16, 2010, from [http://www.energystar.gov/index.cfm?c=bulk\\_purchasing.bus\\_purchasing#comhvac](http://www.energystar.gov/index.cfm?c=bulk_purchasing.bus_purchasing#comhvac)
- Department of Energy. (2010). *U.S. Department of Energy*. Retrieved February 9, 2010, from <http://www.energy.gov/energysources/fossilfuels.htm>
- Egré, D., & Milewski, J. C. (2002). The Diversity of Hydropower Projects. *Energy Policy*, 30(14), 1225-1230.
- Energy Information Administration. (2010). *Puerto Rico-Independent Statistics and Analysis*. Retrieved February 10, 2010, from [http://tonto.eia.doe.gov/state/territory\\_profile\\_pr.html](http://tonto.eia.doe.gov/state/territory_profile_pr.html)
- Energy Information Administration. (2010). *U.S Energy Information Administration, Independent Statistics and Analysis*. Retrieved February 9, 2010, from <http://tonto.eia.doe.gov/dnav/pet/hist/LeafHandler.ashx?n=PET&s=WTOTWORLD&f=W>
- Energy Systems & Design, Ltd. (2010). *The Steam Engine*. Retrieved April 27, 2010, from <http://www.microhydropower.com/Stream%20Engine.htm>
- Environmental Protection Agency. (2000). *Right-Sized Air Conditioners* No. 430-F-97-028). December, 2000: EPA. Retrieved April 12, 2010 from [http://www.energystar.gov/ia/new\\_homes/features/RightSizedAC1-17-01.pdf](http://www.energystar.gov/ia/new_homes/features/RightSizedAC1-17-01.pdf). (Right-Sized Air Conditioners)
- Environmental Protection Agency. (2009). *Reduce, Reuse, Recycle*. Retrieved February 10, 2010, from <http://www.epa.gov/>
- Environmental Protection Agency. (2009). *What is Urban Heat Island Affect?* Retrieved February 9, 2010, from <http://www.epa.gov/hiri/about/index.htm>
- Environmental Protection Agency. (2010). *Climate Change*. Retrieved February 10, 2010, from <http://www.epa.gov/climatechange/>
- Florida Solar Energy Center. (2002). *Right-Size Heating and Cooling Equipment*. Florida Solar Energy Center. Retrieved April 20, 2010, from [http://www.toolbase.org/PDF/DesignGuides/doe\\_hvac sizing.pdf](http://www.toolbase.org/PDF/DesignGuides/doe_hvac sizing.pdf) (Right-Size Heating and Cooling Equipment)

- Garcia, E. (2010). Arruda K. (Ed.), *Personal Communication*
- Gemmell, A. (2009). *Which Solar Panel Type Best Suits Your Needs - Monocrystalline, Polycrystalline, or Amorphous Thin Film?* Retrieved March 23, 2010, from <http://www.solarchoice.net.au/blog/which-solar-panel-type-best-suits-your-needs-monocrystalline-polycrystalline-or-amorphous-thin-film.html>
- Gomez, D. (2010). Arruda K., Baldwin S. and Quinn A. (Eds.), *Personal Communication*
- Gordon, K. (2004). Harvesting the Wind. *Rangelands*, 26(2), 23. Retrieved February 7, 2010, from <http://www.jstor.org/stable/4002017>
- Gulliver, J. S., & Arndt, R. E. A. (2004). Hydropower, History and Technology of. In Cutler J. Cleveland (Ed.), *Encyclopedia of Energy* (pp. 301-314). New York: Elsevier.
- Headley, O. (1997). Renewable Energy Technologies in the Caribbean. *Solar Energy*, 59(1-3), 1-9.
- Heier, S. (2003). *Grid Integration of Wind Energy Conversion Systems* [Siegfried Heier: Windkraftanlagen. 3. Auflage /Grid Integration of Wind Energy Conversion Systems] (Rachel Waddington Trans.). (Second ed.). Wiesbaden: B.G Teubner Verlag.
- Hills, R. L. (1994). *Power from Wind, a History of Windmill Technology* (first ed.). Great Britain: Cambridge University Press.
- Home Depot. (2010). *PowerStar AE 125 Electric Tankless Water Heater* Retrieved April 27, 2010, from [http://www.homedepot.com/PowerStar/h\\_d1/N-5yc1vZ1xh7Z16m/R-100094582/h\\_d2/ProductDisplay?langId=-1&storeId=10051&catalogId=10053](http://www.homedepot.com/PowerStar/h_d1/N-5yc1vZ1xh7Z16m/R-100094582/h_d2/ProductDisplay?langId=-1&storeId=10051&catalogId=10053)
- Home Energy Magazine. (2010). *Cool Roofs for Hot Climates*. Retrieved March 24, 2010, from <http://www.solar-estimate.org/index.php?verifycookie=1&page=white-roof&subpage=>
- Hybrid Cars. (2010). *Hybrid Terms*. Retrieved February 18, 2010, from <http://www.hybridcars.com/types-systems/hybrid-terms.html>
- International Energy Agency. (2010). *Basics of PV*. Retrieved February 9, 2010, from <http://www.iea-pvps.org/pv/index.htm>
- Johnson, M., Cook, T., Shackelford, J., & Pang, T. (2009). *Application Assessment of Bi-level LED Parking Lot Lighting* (Electronic No. 0815) Pacific Gas and Electric Company.
- Knier, G. (2010). *How Do Photovoltaics Work?* Retrieved February 9, 2010, from <http://science.nasa.gov/headlines/y2002/solarcells.htm>

- Kotrba, R. (2006, October 2006). National Park Power. *Biodiesel Magazine*, Retrieved February 3, 2010, from [http://www.biodieselmagazine.com/article.jsp?article\\_id=1184&q=National Park power&category\\_id=11](http://www.biodieselmagazine.com/article.jsp?article_id=1184&q=National Park power&category_id=11)
- Leavitt, W. (2007, October 2007). Green Ride in a Great Park. *Fleet Owner*, 102 Retrieved February 11, 2010, from [http://find.galegroup.com/gps/infomark.do?&contentSet=IAC- Documents&type=retrieve&tabID=T003&prodId=IPS&docId=A169840973&source=gale &srcprod=ITOF&userGroupName=mclin\\_c\\_worpoly&version=1.0](http://find.galegroup.com/gps/infomark.do?&contentSet=IAC- Documents&type=retrieve&tabID=T003&prodId=IPS&docId=A169840973&source=gale &srcprod=ITOF&userGroupName=mclin_c_worpoly&version=1.0)
- Lund, J. Sanner, B. Rybach, L. Curtis, R. Hellstrom, G. (2004). Geothermal (Ground Source) Heat Pumps, A world Overview. *GHC Bulletin*.
- Lund, J. W. (1989). Geothermal Heat Pumps, Trends and Comparisons. *Geo-Heat Center Quarterly Bulletin*, 12(1).
- Lund, J. W. (2004). Geothermal Direct Use. In Cutler J. Cleveland (Ed.), *Encyclopedia of Energy* (pp. 859-873). New York: Elsevier. Madsen, A. (2009). *Wayne National Forest - Now Greener Than Ever*. Retrieved February 23, 2010, from <http://www.fs.fed.us/r9/ssrs/story?id=4672>
- McMichael, C. (2010). *R-Value*. Retrieved March 25, 2010, from [http://www.concretehomesmagazine.com/index.php?option=com\\_magazine&func=show\\_article&id=78](http://www.concretehomesmagazine.com/index.php?option=com_magazine&func=show_article&id=78)
- Meier, A. (1994, Do Refrigerator Thermostat "Setups" Save Energy? *Home Energy Magazine*, May/June
- Miller, C. (2009). Extensive Green Roofs. *National Institute of Building Sciences*, Retrieved February 2, 2010, from <http://www.wbdg.org/resources/greenroofs.php>
- Money Saver Pumps. (2009). *How to Choose*. Retrieved April 12, 2010, from <http://www.moneysaverpumps.com/TDH.htm>
- Nadaï, A., & Van der Horst, D. (2010). Wind Power Planning, Landscapes and Publics. *Land Use Policy*, 27(2), 181-184.
- National Biodiesel Board. (2010). *Biodiesel Fact Sheet - Emissions*. Retrieved February 5, 2010, from [http://www.biodiesel.org/pdf\\_files/fuelfactsheets/emissions.pdf](http://www.biodiesel.org/pdf_files/fuelfactsheets/emissions.pdf)
- National Biodiesel Board. (2010). *Biodiesel Fact Sheet - Production*. Retrieved February 5, 2010, from [http://www.biodiesel.org/pdf\\_files/fuelfactsheets/Production.PDF](http://www.biodiesel.org/pdf_files/fuelfactsheets/Production.PDF)
- National Biodiesel Board. (2010). *Biodiesel Fact Sheets - Performance*. Retrieved February 5, 2010, from [http://www.biodiesel.org/pdf\\_files/fuelfactsheets/Performance.PDF](http://www.biodiesel.org/pdf_files/fuelfactsheets/Performance.PDF)

- National Park Service. (2008). *Boston Harbor Islands - Renewable Energy on the Islands*. Retrieved February 21, 2010, from <http://www.nps.gov/boha/parkmgmt/renewable-energy-installations.htm>
- National Park Service. (2010). *Yosemite National Park - Park Planning*. Retrieved February 19, 2010, from <http://www.nps.gov/yose/parkmgmt/planning.htm>
- National Renewable Energy Laboratory. (1990). *Solar Radiation for Flat Plate Collectors: San Juan, PR*. Retrieved February, 9, 2010, from <http://rredc.nrel.gov/solar/pubs/redbook/PDFs/PR.PDF>
- National Renewable Energy Laboratory. (1998). *Large Comfort Station Solar Hot Water System at Buckhorn Campground* Retrieved February 28, 2010, from <http://www.nrel.gov/data/pix/Jpegs/06719.jpg>
- National Renewable Energy Laboratory. (2009). *Green House Gas Program Overview (Plan for Federal Energy Program No. DOE/GO-102009-2946)*
- National Renewable Energy Laboratory. (2009). *Solar Hot Water*. Retrieved February 9, 2010, from [http://www.nrel.gov/learning/re\\_solar\\_hot\\_water.html](http://www.nrel.gov/learning/re_solar_hot_water.html)
- National Renewable Energy Laboratory. (2010). *Overall DC to AC Derate Factor*. Retrieved April 12, 2010, from <http://rredc.nrel.gov/solar/calculators/PVWATTS/version1/derate.cgi>
- National Weather Service. (2009). *The Saffir-Simpson Hurricane Wind Scale*. Retrieved February 9, 2010, from <http://www.nhc.noaa.gov/aboutshs.shtml>
- National Weather Service. (2010). *Graphical Forecasts – Puerto Rico*. Retrieved March 2, 2010, from <http://www.nws.noaa.gov/forecasts/graphical/sectors/puertorico.php>
- National Weather Service. (2010). *Hurricane History*. Retrieved April 20, 2010, from <http://www.nhc.noaa.gov/HAW2/english/history.shtml>
- Northern Arizona Wind & Sun. (2010). *Two Conductor #8 AWG Outdoor Wiring Cable*. Retrieved April 28, 2010, from <http://store.solar-electric.com/8-2-tc.html>
- Online Solar, I. (2010). *12.22 kW Online Solar Grid Tie System*. Retrieved April 12, 2010, from [http://www.mrsolar.com/page/MSOS/PROD/ce/OLS-GTS-52/SESSION\\_ID/1ac2a83408bbbed52fd9992e660111fd1](http://www.mrsolar.com/page/MSOS/PROD/ce/OLS-GTS-52/SESSION_ID/1ac2a83408bbbed52fd9992e660111fd1)
- Ortiz, M. (2010). Arruda K., Baldwin S. and Quinn A.(Eds.), *Personal Communication*
- Parker, D., & Sherwin, J. (1998). *Comparative Summer Attic Thermal Performance of Six Roof Constructions* No. FSEC-PF-337-98). Toronto, Canada:



- Pinder, J. N., Price, M. A., & Smith, M. G. (1989). Propagation of Noise from Wind Turbine Generators. In D. T. Swift-Hook (Ed.), *Wind Energy and the Environment* (First ed., pp. 59-63). London, United Kingdom: Peter Peregrinus Ltd.
- Progress Energy. (2010). *Air Conditioning*. Retrieved March 29, 2010, from <http://progress-energy.com/custservice/flares/billtoolkit/ac.asp>
- Rafferty, K., Lienau, P., & Lund, J. W. (1997). *Geothermal Heat Pumps (GHP)* (Quarterly Bulletin No. 0276-1084). April 1997: Oregon Institute of Technology. (Geothermal Heat Pump)
- Richman, E. E., Dittmer, A. L., & Keller, J. M. (1994). *Field Analysis of Occupancy Sensor Operation: Parameters Affecting Lighting Energy Savings* No. PNL-10135). Richland, Washington: Pacific Northwest Laboratory. Retrieved March 24, 2010, from <http://www.osti.gov/bridge/purl.cover.jsp;jsessionid=A695C8954B838C49D35003C8E550F311?purl=/10185252-JO3neY/webviewable/>
- Rojanamon, P., Chaisomphob, T., & Bureekul, T. (2009). Application of Geographical Information System to Site Selection of Small Run-of-River Hydropower Project by Considering Engineering/Economic/Environmental Criteria and Social Impact. *Renewable and Sustainable Energy Reviews*, 13(9), 2336-2348.
- Sanguinetti, J. (2010). Baldwin S. (Ed.), *Personal Communication*
- Scherer, T. F. (1993). *Irrigation Water Pumps*. Retrieved April 21, 2010, from <http://www.ag.ndsu.edu/pubs/ageng/irrigate/ae1057w.htm>
- Simmons, D. M. (1975). *Wind Power* (First ed.). Park Ridge, New Jersey: Noyes Data Corporation.
- Sound, C. (2010). *Wayne National Forest Headquarters*. Retrieved February 8, 2010, from [http://www.waymarking.com/waymarks/WM82D1\\_Wayne\\_National\\_Forest\\_Headquarters](http://www.waymarking.com/waymarks/WM82D1_Wayne_National_Forest_Headquarters)
- St. Onge Environmental Engineering. (2010). *Turbine Selection*. Retrieved March 29, 2010, from <http://www.hydro-turbines.com/id73.html>
- Sukau Rainforest Lodge*. (2008). Retrieved February 10, 2010, from [http://www.sukau.com/components.php?comp\\_id=19](http://www.sukau.com/components.php?comp_id=19)
- Šúri, M., Huld, T. A., Dunlop, E. D., & Ossenbrink, H. A. (2007). Potential of Solar Electricity Generation in the European Union Member States and Candidate Countries. *Solar Energy*, 81(10), 1295-1305.
- Swift-Hook, D. T., & Lindley, D. (1989). The Technical and Economic Status of Wind Energy. In D. T. Swift-hook (Ed.), *Wind Energy and the Environment* (First ed., pp. 1-4-5). London, United Kingdom: Peter Peregrinus Ltd.

- Twenty First Century Energy. (2010). *Our Wind Turbine Technology*. Retrieved March 1, 2010, from [www.tfcenergy.com](http://www.tfcenergy.com)
- U.S. Forest Service. (2008). *El Yunque National Forest: Frequently Asked Questions*. Retrieved February, 9, 2010, from <http://www.fs.fed.us/r8/caribbean/faq/index.shtml#01>
- U.S. Forest Service. (2009). *El Yunque National Forest: Recreational Activities*. Retrieved February, 9, 2010, from <http://www.fs.fed.us/r8/caribbean/faq/index.shtml#01>
- United Nations Educational Scientific and Cultural Organization. (2010). *Biosphere Reserves: Reconciling the Conservation of Biodiversity with Economic Development*. Retrieved January 31, 2010, from [http://portal.unesco.org/science/en/ev.php-URL\\_ID=4801&URL\\_DO=DO\\_TOPIC&URL\\_SECTION=201.html](http://portal.unesco.org/science/en/ev.php-URL_ID=4801&URL_DO=DO_TOPIC&URL_SECTION=201.html)
- Valentin, J. (2010). Arruda K. (Ed.), *Personal Communication*
- Western Solar Utilization Network. (2010). *Passive Solar Heating and Cooling Manual*. Retrieved February 10, 2010, from <http://www.azsolarcenter.org/tech-science/solar-for-consumers/passive-solar-energy/passive-solar-design-manual-consumer/passive-solar-design-manual-intro.html>
- Wilcox, G. (2006). *The Future of Geothermal Energy* (Energy No. INL/EXT-06-11746). Idaho Falls, Idaho: Idaho National Library. (Geothermal Energy)

## **APPENDIX A: El Portal and Catalina Energy Audit Performed by Property Management Team Leader Manuel Ortiz**

This audit is the work of Property Management Team Leader Manuel Ortiz of the United States Forest Service. The audit is a work-in-progress, but was still useful to the project team in providing figures for the current electricity usage in El Yunque. The version below is seen in its original format:

### **Catalina & El Portal**

### **Energy Use Analysis & Savings Plan**

#### **General**

This document consists of two distinct parts. Part I is an analysis of energy use patterns at the El Portal/Catalina complex. Part II presents an action plan with immediate, short term and long term actions to reduce energy consumption and related cost at both facilities. It also address following requirements of Executive Order 13423 and implementation of EMS system components related to energy use.

#### **PART I – Energy Use Analysis**

##### **Energy Audit**

An energy use audit was conducted at both facilities. Wattage for all major equipment and for over 90% of all the fixtures and electrical components was determined by direct reading from labels, by computation using other values listed in labels, and by reliable published wattage estimates for electrical equipment. Kilowatt-hours (KWH) is the standard energy unit utilized internationally to estimate energy consumption (use). Average daily KWH was estimated for each component analyzed by estimating the daily hours of use of each component and multiplied by the Kilowatts demand of each component.

The total daily use as determined by the audit was estimated to be 2,022 KWH. This value is highly fluctuating due to the high influence of HVAC equipment which starts and stops depending on thermostat settings and seasonal temperatures. This value represents summer conditions under practices and habits of recent past before the Forest becoming more energy conscious. The El Portal Rainforest Center was found to contribute with 65% of the use, of which 28% (18% of total) is attributed to the administrative space. The Catalina Service Center contributes 35% of the total consumption.

Table 1 below presents a breakdown by category of equipment. A complete list of all the components evaluated is presented in appendix B. A graphic representation of use by category is shown in chart 1 below:

**Table 1 – Summary of Energy Use by Category**

<b>Category</b>	<b>KWH/Day</b>	<b>%</b>
Lighting	362.74	17.9%
HVAC	985.38	48.7%
Appliances	118.20	5.8%
Mechanical	439.44	21.7%
Office	50.57	2.5%
El Portal AV	65.75	3.3%

**Chart 1 – Energy Use by Category**

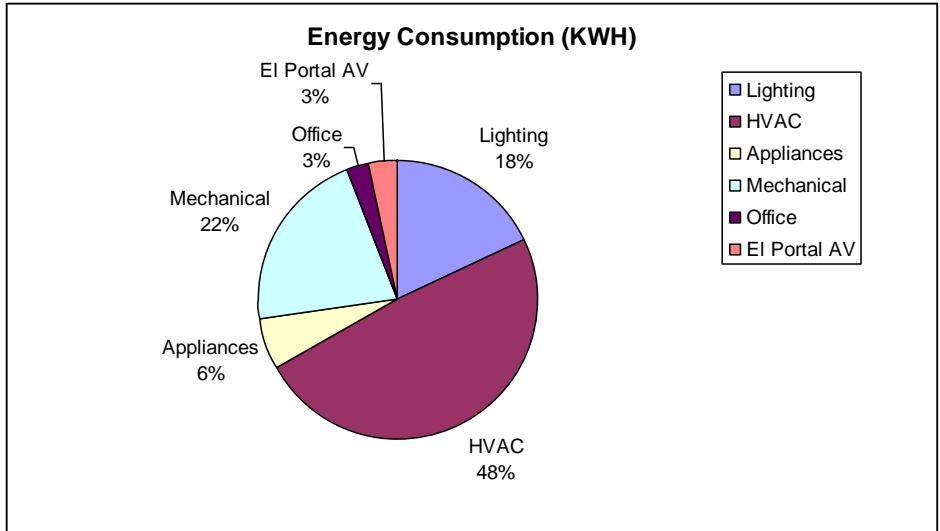
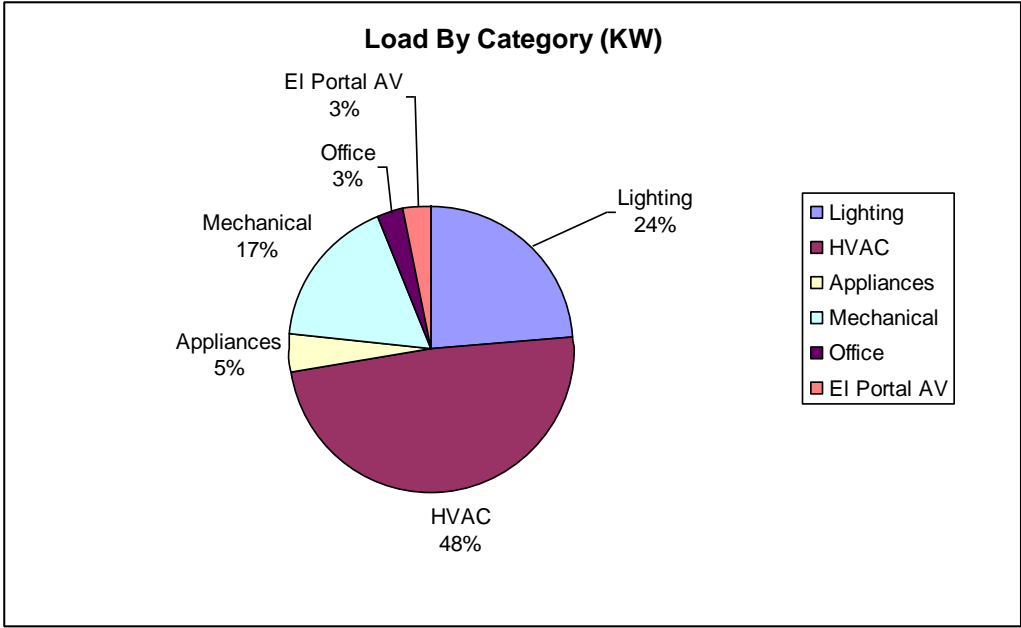

Table 2 below shows the breakdown of energy loads in kilowatts by category. Chart 2 presents a graphical representation.

**Table 2 – Summary of Energy Load by Category**

Category	Load (KW)	%
Lighting	59.69	23.9%
HVAC	120.83	48.3%
Appliances	11.34	4.5%
Mechanical	43.31	17.3%
Office	7.67	3.1%
EI Portal AV	7.31	2.9%

**Chart 2 – Load by category**



**High Consumption Components**

The six (6) major offenders are listed below with the daily estimated consumption and the percent of total use shown:

Component	Use (KWH)	% of Total
El Portal recirculation pool pump	397	19.6
El Portal A/C Compressor	233	11.5
Recessed fluorescent Lights T12	216	10.7
Catalina A/C Compressor	208	10.3
El Portal Store A/C Compressor	122	6.0
Computer room A/C Compressor	106	5.2

**Actual Energy Use Analysis**

Available utility bills from 2005 to 2008 were analyzed to understand the actual consumption as metered and billed by the Puerto Rico Energy and Power Authority (PREPA) and to serve as a check tool for the energy audit. Only partial year 2005 data is at hand while full year data was available from September 2006 to August 2008. Graph 1 illustrates the daily monthly averages as shown in the analyzed monthly utility bills. Graph 2 illustrates the seasonal daily averages as estimated by averaging the daily average in the utility bill over the three months per season.

Chart 3 shows that energy consumption at the Catalina/El Portal Complex has peak and valleys with an absolute low of 1,102 KWH in January 2008 and absolute high of 2,142 KWH in July 2005. Graph also shows a consistent decrease from earlier years to the next for the same month. Only exceptions are a minor increase of 49 KWH (3.4%) in February 2005 to February 2007 and 88 KWH (4.7%) in June from 2005 to 2007. A decrease is shown for all months from Sep06-Aug07 to Sep07-Aug08, from a slight decrease of 49 KWH (3.4%) in February to a substantial decrease of 370 KWH (28.1%) in July.

**Chart 3 – Average Monthly Daily Use**

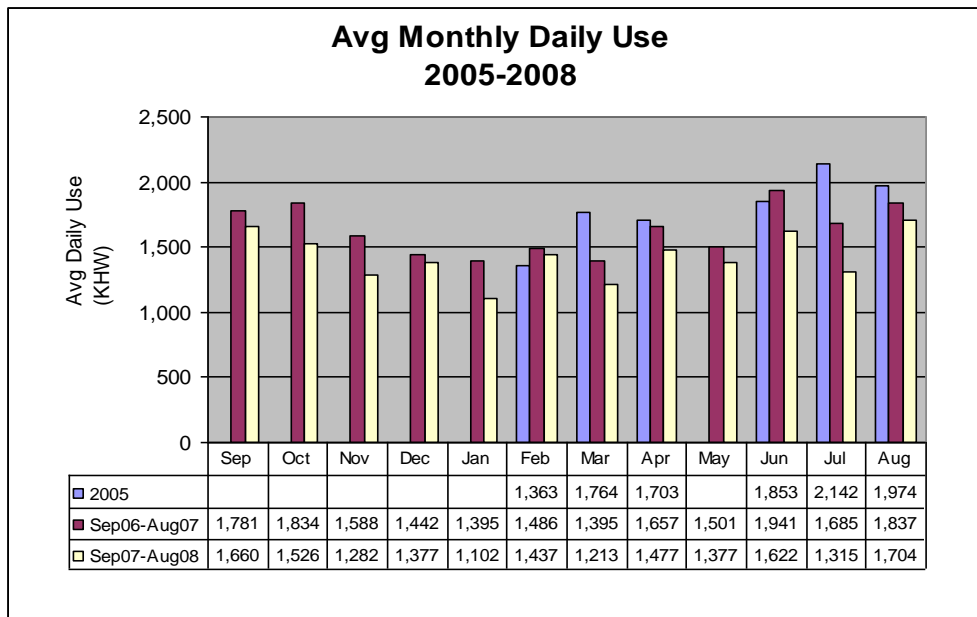

The seasonal variation shown in Chart 4 presents a consistent low in the winter and a peak in the summer for all 3 years analyzed, although values do not differ significantly from each other. This graph also illustrates a consistent downward trend over the analysis period.

**Chart 4 – Average Seasonal Daily Use**

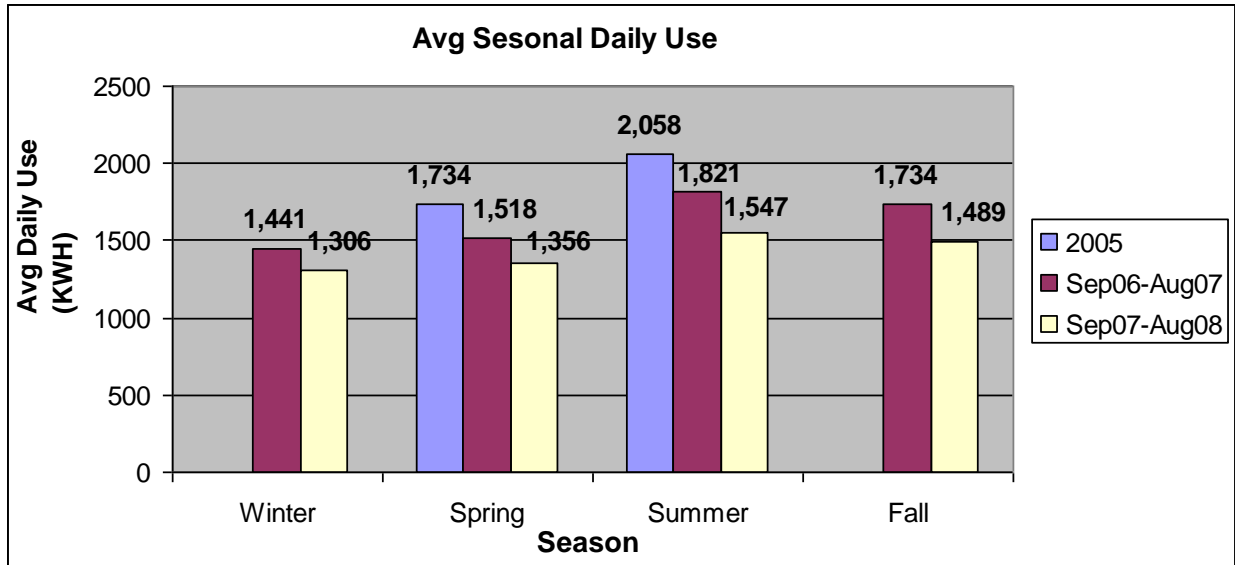

## Part II – Energy Savings Plan

### General

This plan has two primary goals; 1) reducing energy consumption at the Catalina/El Portal Complex, and 2) reducing associated utility cost. Unfortunately in Puerto Rico these two goals are not necessarily achievable simultaneously, the second as a consequence of the first one, like it would be logical to expect, and like it is the case on most developed countries. The reason is the way utility customers are billed in Puerto Rico with the use of a fuel cost adjustment where all costs associated with the purchase of crude oil is passed directly to the customers. Currently the fuel purchase adjustment cost in PR is \$0.17 which is 63% of the average rate of \$0.27.

Achieving goal number one has the following two main benefits:

- Complying with Executive Order 13423
- Contribute to reducing the carbon emissions by reducing use of fossil fuels, in this particular case petroleum.

This plan has a goal of reducing energy consumption at the El Portal and Catalina complex by over 40% when comparing to the FY03 base year for the EO 13423 and over 20% from the FY08 level. It also has a



goal to reduce the yearly utility cost by over 20% from the FY08 level if the KWH rates remain steady or decrease.

This plan is a dynamic document that will be revised as a minimum yearly to incorporate monitoring results, new technologies, decreasing cost of renewable energy, errors in the data, and employee suggestions.

## **Executive Order 13423**

The executive order 13423 of January 24, 2007 establishes the following policy:

*Policy.* It is the policy of the United States that Federal agencies conduct their environmental, transportation, and energy-related activities under the law in support of their respective missions in an environmentally, economically and fiscally sound, integrated, continuously improving, efficient, and sustainable manner.

The first goal under *Goals for Agencies* in the executive order states as follow:

(a) Improve energy efficiency and reduce greenhouse gas emissions of the agency, through reduction of energy intensity by (i) 3 percent annually through the end of fiscal year 2015, or (ii) 30 percent by the end of fiscal year 2015, relative to the baseline of the agency's energy use in fiscal year 2003.

The table in Appendix D shows good progress toward meeting the 30% reduction by 2015 with a FY 2008 reduction of 19% vs the FY 2003 base year. The actions identified in this plan are very achievable toward meeting or exceeding the EO goal of 30% reduction. Actions are a combination of mechanical modifications and employee's commitment to follow some simple rules and sacrificing some comfort for the satisfaction of contributing toward decreasing dependence on fossil fuels. Unfortunately for the reasons described above the utility cost went up 51% for the same period. Achieving a parallel reduction in utility cost vs the base year appears unattainable at this time unless crude oil prices decrease to values near 2003 or the price of renewable sources like solar power drop significantly from current prices. **See discussion on solar power below.** Reductions vs the current year are achievable if the price of crude oil stabilize at current level or decrease.

## Discussion of High Consumption Elements and Alternatives

### El Portal Recirculation Pool Pump

The pump servicing the recirculation pool is a 20 HP centrifugal pump that was installed in 2002 as a replacement of the original equipment that consisted of two alternating submersible pumps of ? HP each. The replacement was recommended by a consultant and alleged expert in the recirculation pool business who also recommended that the equipment need to run 24-7 to prevent pump failure. His recommendation was accepted without concern to the size of the pump or attention to the recommendation of 24-7 operation. The energy audit reveals that this equipment is consuming near 20% of the total KWH for the two facilities. At glance this pump appears grossly oversized and the recommendation of running 24-7 highly suspect. This plan recommends an immediate action of manually turning pump on and off, and short term actions for right sizing and replacing the pump.

### HVAC Systems

Heating, ventilating and air conditioning (HVAC) systems on the Forest are mostly split-system Central AC units, with the exception of window units at the Catalina modules and at the utility room at El Portal currently used by the Ventures crew. These systems account for 48% of the complex total KWH consumption. Most units are the same capacity and brand that was installed when the facilities were constructed (remodeled in the case of Catalina). The Catalina and El Portal condensing units have been replaced but priority have been given to obtaining the lowest price and fastest installation for budget reasons and for restoring employee comfort levels as soon as possible. Both objectives are achieved by replacing the condensing unit with the same brand/capacity in order to match the evaporator unit and all conduits and other fixtures, but ignore efficiency, long term cost, and environmental impacts. This plan calls for a comprehensive approach to replacing AC units. See management direction on page 8.

This plan also calls for an immediate action off manually adjusting the thermostat of all units without timers at night and weekends, a short term action to install timers at all units, and a long term action to replace all units with energy efficient units. It also calls for investigating setting thermostat at higher temperatures without sacrificing reasonable comfort and employee's productivity levels.

## **Recessed Fluorescent Lights**

Lighting accounts for 18% of the total KWH consumption. Rectangular (2 ft x 4 ft) recessed fluorescent fixtures with 4-40 watts lamps each for a total rating of 160 Watts per fixture are installed in most offices, both at El Portal admin area and Catalina. Each office has a pair for a total lighting load of 320 Watts in each office. These fixtures account for 11% of the total KWH when operated during regular office hours. The lamps in use are the traditional 1-1/2" T-12 lamps with magnetic ballast. More efficient T-8 and T-5 with electronic ballast are currently available. This plan calls for several immediate, short term and long term actions to address lighting energy consumption.

## **Renewable Energy Alternatives**

In Puerto Rico, we are at a disadvantage with many states because a renewable energy program is practically in the planning phase and still undergoing political debate. Ninety eight percent (98%) of the total energy production is petroleum dependant. The other 2% is mostly hydro electrical power in small communities, like the FERC project in Rio Blanco. Any renewable energy project on the Forest in the near future would have to be a stand alone system (off grid system). The two most viable systems are discussed below.

### **Solar Power**

Generation of energy using photovoltaic cells

- Still expensive; \$65 per monthly KWH for materials only. Would need \$2.9 Million investment + installation + O&M for a system that could handle avg monthly use of 45,000 KWH.
- There are benefits
  - Main is carbon reduction
- Needs 100 SF per 110 monthly KWH. There is sufficient roof area between El Portal and Catalina.

## ...more to come

### Wind Power

Annual Energy Output (AEO) in KWH =  $0.01328 \times \text{rotor diameter (ft.) squared} \times \text{average wind speed (mph) cubed}$ .

Current prices for a complete system installed are around \$60 per monthly KWH for capital investment + O&M for systems operating under 10 mph average winds. Substituting the entire average consumption of 45,000 KWH per month would require an investment of \$2.7 Million plus O&M cost and around 45 turbines of 25 ft diameter rotors or fewer turbines of larger sizes rotors.

Wind turbine cost can range from only 10 percent to as much as 40 percent of the entire wind system's expenses.

## ....reword previous paragraphs

Small-scale wind energy systems require intense routine maintenance and current warranties (most 2 yrs and as high as 5 yrs) are significantly below the break even time of 15-20 yrs just to recover the capital investment. These systems as well as solar power should be carefully evaluated for development of isolated areas where the investment on state generated power could be near the investment on renewable energy sources. Also should be considered for supplementing/replacing state power on small facilities (consuming less than 1,000 KWH/month) where state service is unreliable due to low maintenance of remotely located power lines.

### LEED

**Leadership in Energy and Environmental Design.** Scores are tallied for different aspects of efficiency and design in appropriate categories. For instance, LEED assesses in detail:

1. Site Planning
2. Water Management
3. Energy Management
4. Material Use

5. Indoor Environmental Air Quality

6. Innovation &

Design Process

**.....more to come**

## **Environmental Management System (EMS)**

EMS is a system of check and balances (adaptive management following ISO 14001 cycle) required by EO 13423 and the 2008 Planning rule to address environmental aspects from the EO goals. The Forest Service has implemented the EMS and identified two major categories; 1) Sustainable Operations; and 2) Land Management. The Environmental Aspects identified for Sustainable Operations are:

- Energy conservation
- Water conservation
- Sustainable Acquisition /Green Purchasing
- Pollution prevention / Management of Toxic and Hazardous Material
- Fleet management

The Forest Service is currently focusing in fleet management and there are efforts ongoing and direction in place. This plan addresses energy conservation and the timely implementation of it will place the Forest ahead for implementing EMS.

## **Guiding Principles**

- A. Give priority to employee safety at all times over all other considerations.
- B. Give priority to long term employee comfort and productivity over all other considerations.
- C. Give priority to long term energy and cost efficiency over short term employee comfort and productivity.
- D. Give priority to short and long term energy efficiency over employee convenience.

## Management Direction

- A. Follow Executive Order 13423.
- B. Follow direction on green practices in Forest Supervisor 1110/1330 letter dated July 10, 2008.
- C. Pursue LEED certification for Catalina and El Portal sites.
- D. Perform cost/benefit analysis over a 10 yr period for replacing malfunctioning A/C units. Consider energy consumption and cost savings as well as environmental (carbon reduction and decreasing dependency on fossil fuels) factors in the analysis. Incorporate guiding principles above in the decision making.
- E. Replace A/C components with Energy Star rated units.
- F. Evaluate solar & wind power for new development of facilities in areas without state service.
- G. Evaluate solar & wind power for facilities using less than 1,000 KWH per month in areas where state service is highly unreliable.

## Action Plan

### Immediate Actions

Immediate actions could be implemented by Forest Supervisor letter at any time even before this plan is finalized and no later than 3 months after plan is implemented. They involved minor cost that will be part of the FY08 operating budget and mostly the commitment of employees to follow direction and be part of the solution to the fossil fuels dependency situation.

- A. Install timer for water heater to run water heater for one hour every morning during weekdays. Turn on manually 15 minutes before shower use and turn off after use.
- B. Turn off A/C units outside of business hours, particularly downstairs Catalina.
- C. Use only one office light (2x4 recessed fluorescent) when occupying offices. Turn both fixtures off when leaving the office for over 15 minutes.
- D. Evaluate turning off window units at Catalina modules and replacing with dehumidifiers and natural cross ventilation for humidity control.
- E. Install timer for EP water Feature pump to start pump at the time necessary to assure full flow between 9:00 and 5:00 pm. Turn on and off manually until the timer is installed.
- F. Run only one Ice Maker at Catalina. Disconnect the one in the kitchen. Test once a month, full check and any maintenance as preparation for hurricane season.
- G. Install separate meter for Catalina. This will facilitate monitoring for budget allocation and energy consumption purposes as well as conducting analysis for temperature settings.

## Short Term Actions

The goal is to implement short term actions within a year from the completion of the plan. They involve a moderate cost that could prevent completion within the year as desired.

- A. Install Timers at all A/C units
  - 1. Keep low setting at 74°F during normal operating hours (M-F: 6:30 am to 5:00 pm); and 80°F outside normal operating hours (M-F: 5:00 pm to 6:30 am, F@5:00 pm to M@6:30 am)
  - 2. Program to start at different times
- B. Investigate setting thermostat at higher temperatures without sacrificing reasonable comfort and employee's productivity levels. Perform a week temperature adjustment test at all units.
- C. Install individual meters for A/C units and the El Portal recirculation pump.
- D. Replace as many T-12 lamps with magnetic ballasts as budget allows with T-8 lamps and energy efficient ballast. Prepare a replacement plan if budget does not allow 100% replacement during FY09.
- E. Complete lighting inventory & retrofitting plan in appendix C.
- F. Install occupancy sensors in all offices and office bathrooms
- G. Perform a security assessment to investigate the possibility of discontinuing the practice of keeping parking lights on all night on some areas.
- H. Trim vegetation around parking lights; this make the lights come up earlier than is necessary or sometimes during a cloudy or rainy day.
- I. Right size water heater & replace, continue practice of turning on when needed.
- J. Right size EP Water Feature pump, replace as soon as budget allows.
- K. Train engineering personnel in LEED certification process and techniques to move toward LEED initial certification and retention.

## Long Term Actions

The goal to implement long term actions is starting in FY10 and completing no later than FY15.

- A. Replace EP water feature pump early in FY10 if funding did not allow in FY09.
- B. Perform **building commissioning** by 2010 to ensure that cooling and other building systems work efficiently together to save energy and reduce operating costs.
- C. Replace A/C Units with energy efficient units by 2012 if Catalina expansion project is not funded before 2015.
- D. Perform comprehensive analysis of solar and wind power alternatives and develop action plan to convert small facilities (consuming less than 1,000 KWH/month) to renewable energy. This could be small buildings at El Portal/Catalina or throughout the Forest.
- E. Install alternate energy sources; solar panels, wind mills, etc. when funding is available.
- F. Design the Catalina building expansion to be LEED certified.

## Monitoring

Perform ongoing monitoring of energy consumption and utility cost. Keep track of Catalina vs El Portal cost as well as A/C units and the El Portal recirculation pool. PREPA bills which contain all necessary information can be accessed from their website <http://www.prepa.com>. Once at the site sign on using e-mail: \*\*\*\*\* and password: \*\*\*\*\*. Monitoring forms are available in appendix E.



Appendix A  
Abbreviations & Glossary

**Coming Soon**

Appendix B

Energy Audit Spreadsheet

**El Portal**

Equipment/fixture	Category	Location	Watts/fixt	Qty	Hours	KWH
<b>EL PORTAL OUTSIDE AREA</b>						
Parking lamps	Lighting	Parking	150.00	42	6	37.80
Walkway lamps	Lighting	Sidewalks	40.00	26	6	6.24
Indirect lighths	Lighting	Atrium	265.20	62	0.1	1.64
<b>STORE</b>						
Compressor	HVAC	Store	11561.66	1	5	57.81
Condenser Fan	HVAC	Store	293.25	2	5	2.93
Refrigerator	Appliances	Store	750.00	1	10	7.50
Fax	Office	Store	459.00	1	2	0.92
Lights	Lighting		50.00	12	9	5.40
Recess Lights	Lighting		40.00	12	9	4.32
Display lights	Lighting		7.00	10	9	0.63
Ceiling lights	Lighting		7.00	36	9	2.27
Refrigerator	Appliances		153.00	1	24	3.67
<b>THEATER</b>						
Ceiling lights	Lighting	outside theater	100.00	8	12	9.60
Ceiling lights	Lighting	Inside	7.00	7	12	0.59
Recess Lights	Lighting	Inside	40.00	14	12	6.72
Air Cond	HVAC	under ramp	1373.01	1	10	13.73
Compressor	HVAC	under ramp	12234.56	1	10	122.35
Condensator	HVAC		1830.67	1	10	18.31

Video system	AV	Inside	7305.00	1	9	65.75
<b>OFFICE</b>						
Lights	Lighting	Bathroom	50.00		8	0.00
Lights	Lighting	Bathroom	7.00		8	0.00
Lights	Lighting	Boys Scouts	7.00		8	0.00
Air Cond	HVAC	Boys Scouts	1224.00	1	1	1.22
Lights	Lighting	Stairs	7.00	4	24	0.67
Condensator	HVAC	computer room	699.38	1	12	8.39
Compressor	HVAC	computer room	8839.47	1	12	106.07
Fan	HVAC	computer room	233.13	1	24	5.60
Flourescent Lights T12	Lighting	computer room	160.00	12	10	19.20
Flourescent Lights T12	Lighting	Admin area	160.00	42	10	67.20
Flourescent Lights	Lighting	Admin area	25.00	7	10	1.75
Flourescent Lights	Lighting	Admin area	17.00	2	10	0.34
Flourescent Lights	Lighting	Admin area	13.00	30	10	3.90
Incandescent lights	Lighting	Back porch	200.00	5	1	1.00
Elevator	Mechanical		20494.51	1	0.1	2.05
Refrigerator	Appliances	Breakroom	725.00	1	10	7.25
Ice Machine	Appliances	Compressor	969.00	1	10	9.69
Pump	Appliances	Ice machine	31.00	1	3	0.09
Fan	Appliances	Ice machine	204.00	1	24	4.90
Fax	Office	Reception area	479.40	1	4	1.92
Copier	Office	Photo room	1224.00	1	3	3.67
<b>BIG EQUIPMENT</b>						
Condensator1	HVAC	office air cond	840.65	2	10	16.81
Condensator2	HVAC	office air cond	723.35	2	2	2.89
Fan	HVAC	office air cond	233.13	2	11	5.13

Compressor1	HVAC	office air cond	19452.95	1	10	194.53
Compressor2	HVAC	office air cond	19452.95	1	2	38.91
Water Pumps	Mechanical	water fall	16541.02	1	24	396.98
Water Pumps	Mechanical	Reflective pools	750.00	2	24	36.00
Sanitary pump	Mechanical		4362.57	1	1	4.36

## Catalina

Compressor	HVAC		1591.20	1	10	15.91
Air Cond	HVAC	Outside	116.56	1	10	1.17
Compressor	HVAC		20768.17	1	10	207.68
Fan	HVAC	Outside	559.50	1	10	5.60
Fan	HVAC	Outside	690.05	1	10	6.90
Condensator	HVAC		1525.56	1	10	15.26
Compressor	HVAC		5109.52	1	10	51.10
Fan	HVAC	Outside	233.13	1	10	2.33
Compressor	HVAC		1396.72	1	10	13.97
Fan	HVAC	Outside	158.53	1	10	1.59
Compressor	HVAC		1591.20	1	10	15.91
Fan	HVAC	Outside	116.56	1	10	1.17
Condensator	HVAC	Outside	699.38	1	10	6.99
Ice Machine	Appliances	Kitchen	816.00	1	10	8.16
Refrigerator	Appliances	Kitchen	725.00	1	10	7.25
Water heater	Appliances	downstairs	6000.00	1	10	60.00
Vapo	HVAC	downstairs	699.38	1	10	6.99
Ice Machine	Appliances	modulos	969.00	1	10	9.69
Window Air Cond	HVAC	modulos	1122.00	1	4	4.49

Window Air Cond	HVAC	modulos	1122.00	3	10	33.66
Gate	Mechanical	road	408.00	1	0.1	0.04
Parking lights	Lighting	parking	100.00	16	12	19.20
Copier	Office					0.00
Fax	Office					0.00
Printer	Office					0.00
Dell Monitor	Office	Throughout	153.00	18	8	22.03
Dell laptop	Office	Throughout	153.00	18	8	22.03
Recessed Flourescent lamps L1	Lighting	1st floor	160.00	31	8	39.68
Recessed Flourescent lamps L1	Lighting	2nd floor	160.00	56	10	89.60
Flourescent Industrial L2	Lighting	2nd floor A/C room	80.00	2	0	0.00
Flourescent Channel L3	Lighting	2nd floor bathrooms	80.00	2	10	1.60
Flourescent Channel L4	Lighting	Conf room closet	70.00	2	0	0.00
Recessed Flourescent L9	Lighting	2nd floor	30.00	48	10	14.40
Surface HPS L12	Lighting	stairway	130.00	2	10	2.60
Recessed Incandescent L13	Lighting	Conf room	75.00	7	2	1.05
Rescessed Incandescent L14	Lighting	Conf room	150.00	6	2	1.80
Surface Flourescent L16	Lighting	2nd floor Janitor's closet	60.00	1	0	0.00
Wall mtd fluorescent L19	Lighting	Ext front wall	60.00	3	12	2.16
Flourescent Industrial L2	Lighting	Whare house	80.00	16	2	2.56
Flourescent Channel L3	Lighting	1st floor bathrooms	80.00	4	8	2.56
Wall mounted HPS L6	Lighting	1st floor ext	88.00	5	10	4.40
Wall mtd fluorescent L8	Lighting	1st floor ext hallway	20.00	11	12	2.64

Recessed Flourescent L9	Lighting	1st floor	30.00	33	8	7.92
Wall mounted incandescent L10	Lighting	Elevator	100.00	1	0	0.00
Surface HPS L12	Lighting	1st floor stairway base	130.00	1	10	1.30

Appendix C

Lighting Inventory & Retrofitting Plan

**Coming Soon**

## Appendix D

### Comparison of EO 13423 Base Year and FY08

Bill Month	Monthly KWH		Invoice	
	FY 03	FY 08	FY 03	FY 08
Oct	34,860	46,480	\$5,185.41	\$9,619.74
Nov	36,450	45,780	\$5,479.07	\$10,525.37
Dec	41,160	41,020	\$5,729.34	\$9,327.66
Jan	126,420	42,700	\$13,631.33	\$10,244.21
Feb	70,140	34,160	\$8,778.04	\$8,186.45
Mar	33,180	43,120	\$4,985.11	\$9,318.82
Apr	47,880	36,400	\$6,535.91	\$8,547.97
May	47,040	45,780	\$6,704.82	\$10,677.92
Jun	52,500	41,300	\$7,271.90	\$11,701.36
Jul	47,460	47,040	\$6,500.48	\$14,108.68
Aug	53,340	43,400	\$7,291.80	\$12,020.59
Sep	44,940	49,420	\$6,307.79	\$13,496.25
<b>Total:</b>	<b>635,370</b>	<b>516,600</b>	<b>\$84,401.00</b>	<b>\$127,775.02</b>
<b>Daily Avg:</b>	<b>1,741</b>	<b>1,415</b>		
<b>Difference (%):</b>		<b>-19%</b>		<b>51%</b>



## Appendix E

### Monitoring Forms

**Table E.1 – Monthly Energy Use & Billing Monitoring**

Billing Month	Use Month	Total (KWH)	Power factor	KW	KVA	Excess KVA	Block 1 (KWH)	Block 2 (KWH)	Energy Purchase (\$/KWH)	Fuel Purchase (\$/KWH)	Fuel Adjust (\$)	Monthly bill (\$)	Unit Price (\$/KWH)
Oct-07	Sep-07	46,480	0.85	131.6	155	5	39,480	7,000	0.035977	0.104674		\$9,619.74	\$0.21
Nov-07	Oct-07	45,780	0.85	131.6	155	5	39,480	6,300	0.036575	0.126437		\$10,525.37	\$0.23
Dec-07	Nov-07	41,020	0.85	120.4	142	0	36,120	4,900	0.040190	0.119243		\$9,327.66	\$0.23
Jan-08	Dec-07	42,700	0.85	113.4	133	0	34,020	8,680	0.038799	0.136825		\$10,244.20	\$0.24
Feb-08	Jan-08	34,160	0.85	100.8	119	0	30,240	3,920	0.036540	0.133956		\$8,186.44	\$0.24
Mar-08	Feb-08	43,120	0.85	105.0	124	0	31,500	11,620	0.042694	0.111644		\$9,318.81	\$0.22
Apr-08	Mar-08	36,400	0.85	107.8	127	0	32,340	4,060	0.038867	0.127104		\$8,547.96	\$0.23
May-08	Apr-08	45,780	0.85	116.2	137	0	34,860	10,920	0.038592	0.131952		\$10,677.92	\$0.23
Jun-08	May-08	41,300	0.85	114.8	135	0	34,440	6,860	0.040477	0.176858		\$11,701.36	\$0.28
Jul-08	Jun-08	47,040	0.85	117.6	138	0	35,280	11,760	0.043959	0.193956		\$14,108.68	\$0.30
Aug-08	Jul-08	43,400	0.85	117.6	138	0	35,280	8,120	0.040201	0.171904		\$12,020.60	\$0.28
Sep-08	Aug-08	49,420	0.85	120.4	142	0	36,120	13,300	0.043070	0.168855		\$13,496.25	\$0.27
Oct-08	Sep-08	33,180	0.85	107.8	127	0	32,340	840	0.037474	0.156695		\$8,858.99	\$0.27
Nov-08	Oct-08	38,360	0.85	106.4	125	0	31,920	6,440	0.037660	0.115597		\$8,420.88	\$0.22
Dec-08	Nov-08	37,380	0.85	102.2	120	0	30,660	6,720	0.043771	0.065616	(\$310.40)	\$6,242.41	\$0.17
Jan-09	Dec-08	35,560	0.85	111.6	131	0	33,474	2,086	0.040284	0.070259		\$6,455.48	\$0.18
Feb-09	Jan-09	36,120	0.85	92.4	109	0	27,720	8,400	0.041727	0.091379		\$7,123.81	\$0.20
Mar-09	Feb-09	33,460	0.85	103.9	122	0	31,164	2,296	0.047185	0.079411		\$6,610.29	\$0.20
Apr-09	Mar-09	19,460	0.85	99.4	117	0	19,460	0	0.039258	0.08749		\$4,314.78	\$0.22
May-09	Apr-09	33,600	0.85	110.6	130	0	33,180	420	0.035281	0.099678		\$6,993.86	\$0.21
Jun-09	May-09	31,780	0.85	112.0	132	0	31,780	0	0.035915	0.105081		\$6,894.13	\$0.22
Jul-09	Jun-09	35,840	0.85	128.8	152	2	35,840	0	0.045970	0.101567		\$8,012.97	\$0.22
Aug-09	Jul-09	38,920	0.85	117.6	138	0	35,280	3,640	0.045458	0.08969		\$7,949.76	\$0.20
Sep-09	Aug-09	32,480	0.85	117.6	138	0	32,480	0	0.045296	0.099282		\$7,182.97	\$0.22

## APPENDIX B: Solar Survey

Solar Power Site Rating System						
Site:						
Constraint	Measured Values / Notes	Worst	Rating			Best
( To be accompanied with pictures)		1	2	3	4	5
Available Area						
Facing South: Y / N						
Effective Shading						
Natural Obstructions (Geography)						
Man Made Obstructions						
Proximity to Infrastructure <b>OR-</b>						
Proximity to Power Line						
Site Accessibility						
Ground Condition <b>OR-</b>						
Roof Condition						
Damage Installation will cause to Habitat						
Visibility From Hiking Paths						
Total Numerical Rating						
(Best=50)	(Worst=10)					

## APPENDIX C: Photovoltaic Equipment

Equipment	Manufacturer	Model
235 Watt Solar Panels	Sharp	NU-U235F1
Solar Combiner w/ 600VDC Fuses	MidNite	MNPV6
11,400 Watt DC/AC Inverter	Fronius	IG Plus 11.4-1
60A/240V AC Disconnect	-	-
NEMA 3R Outdoor Electrical Box	Schnieder Electric	DU222RB
600V DC Lightning Arrestor	Delta	LA602DC
300V AC Lighting Arrestor	Delta	LA302R
30' #10USE MC Output Cable	-	-
Two-Way Utility Meter	PREPA	-

## APPENDIX D: Hydropower Equipment

<b>Equipment</b>	<b>Manufacturer</b>	<b>Model</b>
1kW Turbine Generator	ES&D, Ltd.	"Steam Engine"
2,000 Watt DC/AC Inverter	Fronius	IG 2000
600V DC Lightning Arrestor	Delta	LA602DC
400' 2 Conductor #8 AWG Outdoor Wiring Cable	-	-
Two-Way Utility Meter	PREPA	-

## APPENDIX E: Condenser Unit Product Data

### E-1: Unit Capacity and Efficiency

UNIT LABEL	Brand	Model Number	TONNAGE	SEER	EER
<b>El Portal</b>					
<b>1a</b>	CARRIER	38AKS016	13		11
<b>1b</b>	CARRIER	38AKS016	13		11
<b>2</b>	TGM	TCV3-036A	3		10
<b>3</b>	TGM	TCV3-030A	2.5		10
<b>4</b>	CARRIER	38AKS008	7		11.5
<b>5</b>	CARRIER	38ARZ012	10		12.4
<b>CATALINA</b>					
<b>6</b>	CARRIER	38CKC018330	1.5	10	
<b>7</b>	CARRIER	38AKS024--K521	18	11.5	10.5
<b>8</b>	PAYNE	PA10JA060-G	4.75	10	9.4
<b>9</b>	GOODMAN	CKJ18-1T	1.5	10	
<b>10</b>	CARRIER	38CKB018310	1.5	12	9.8

### E-2: Product Data Directory

Model Number	PRODUCT DATA CAN BE FOUND AT:
<b>EL PORTAL</b>	
38AKS016	<a href="http://www.carriercca.com/Supporting_Doc/Light_Commercial_Splits/38a-19pd.pdf">http://www.carriercca.com/Supporting_Doc/Light_Commercial_Splits/38a-19pd.pdf</a>
38AKS016	<a href="http://www.carriercca.com/Supporting_Doc/Light_Commercial_Splits/38a-19pd.pdf">http://www.carriercca.com/Supporting_Doc/Light_Commercial_Splits/38a-19pd.pdf</a>
TCV3-036A	<a href="http://tgmairconditioning.com/">http://tgmairconditioning.com/</a>
TCV3-030A	<a href="http://tgmairconditioning.com/">http://tgmairconditioning.com/</a>
38AKS008	<a href="http://www.xpedio.carrier.com/idc/groups/public/documents/techlit/38ak-3pd.pdf">http://www.xpedio.carrier.com/idc/groups/public/documents/techlit/38ak-3pd.pdf</a>
38ARZ012	<a href="http://www.carriercca.com/Supporting_Doc/Light_Commercial_Splits/38a-19pd.pdf">http://www.carriercca.com/Supporting_Doc/Light_Commercial_Splits/38a-19pd.pdf</a>
<b>CATALINA</b>	
38CKC018330	<a href="http://www.docs.hvacpartners.com/idc/groups/public/documents/techlit/38ckc-8pd.pdf">http://www.docs.hvacpartners.com/idc/groups/public/documents/techlit/38ckc-8pd.pdf</a>
38AKS024—K521	<a href="http://www.carriercca.com/Supporting_Doc/Light_Commercial_Splits/38a-19pd.pdf">http://www.carriercca.com/Supporting_Doc/Light_Commercial_Splits/38a-19pd.pdf</a>
PA10JA060-G	Product Data Listed in Appendix E
CKJ18-1T	<a href="http://www.dnmech.com/lit/good_ckj_ss213s.pdf">http://www.dnmech.com/lit/good_ckj_ss213s.pdf</a>
38CKB018310	<a href="http://www.xpedio.carrier.com/idc/groups/public/documents/techlit/38ckb-c2pd.pdf">http://www.xpedio.carrier.com/idc/groups/public/documents/techlit/38ckb-c2pd.pdf</a>

### E-3: Product Data for Compressor Unit PA10JA060

#### PAYNE PA10JA060-C Air Conditioner

The PA10JA060-C is a residential split-system central air conditioner. Its efficiency rating of 10 SEER makes it a mid-efficiency model. (US Federal requirements specify that no central air conditioners can be manufactured in the US with a SEER of less than 13.) High-efficiency models can reach a SEER of up to 21. The first year that this model appears in our records is 2002.

<b>Brand:</b>	PAYNE
<b>Manufacturer:</b>	CARRIER CORPORATION
<b>Model Number:</b>	PA10JA060-C
<b>Condenser Type:</b>	air-cooled
<b>Coil Model Number:</b>	CC5A/CD5AW060+TDR
<b>System Configuration:</b>	Split System Air Conditioner
<b>Energy Efficiency:</b>	10 SEER 9.4 EER
<b>Cooling Capacity:</b>	57,000 BTUs / hour
<b>ARI Type Code:</b>	RCU-A-C
<b>Electrical Service:</b>	Single-phase
<b>Electrical Input:</b>	6,096 watts per hour

## APPENDIX F: Cost Analysis Tables and Graphs - Solar Power

### F-1: Inflationary Model Cost Analysis for 48.88 kW PV System at El Portal

Year	Annual Growth	Cost/kWh	Lifetime Cost	Annual Output (kWh)	Annual Value of Output	Aggregate Value of Output	Profit
0	-	-	\$305,240.00	0	\$0.00	\$0.00	(\$305,240.00)
1	0%	\$0.2500000000	\$305,240.00	59,621.70	\$14,905.43	\$14,905.43	(\$290,334.58)
2	0%	\$0.2500000000	\$305,240.00	59,621.70	\$14,905.43	\$29,810.86	(\$275,429.15)
3	0%	\$0.2500000000	\$305,240.00	59,621.70	\$14,905.43	\$44,716.29	(\$260,523.72)
4	0%	\$0.2500000000	\$305,240.00	59,621.70	\$14,905.43	\$59,621.72	(\$245,618.29)
5	0%	\$0.2500000000	\$305,240.00	59,621.70	\$14,905.43	\$74,527.15	(\$230,712.86)
6	0%	\$0.2500000000	\$305,240.00	59,621.70	\$14,905.43	\$89,432.58	(\$215,807.43)
7	0%	\$0.2500000000	\$305,240.00	59,621.70	\$14,905.43	\$104,338.01	(\$200,902.00)
8	0%	\$0.2500000000	\$305,240.00	59,621.70	\$14,905.43	\$119,243.44	(\$185,996.57)
9	0%	\$0.2500000000	\$305,240.00	59,621.70	\$14,905.43	\$134,148.87	(\$171,091.14)
10	0%	\$0.2500000000	\$305,240.00	59,621.70	\$14,905.43	\$149,054.30	(\$156,185.71)
11	0%	\$0.2500000000	\$305,240.00	59,621.70	\$14,905.43	\$163,959.73	(\$141,280.28)
12	0%	\$0.2500000000	\$305,240.00	59,621.70	\$14,905.43	\$178,865.16	(\$126,374.85)
13	0%	\$0.2500000000	\$305,240.00	59,621.70	\$14,905.43	\$193,770.59	(\$111,469.42)
14	0%	\$0.2500000000	\$305,240.00	59,621.70	\$14,905.43	\$208,676.02	(\$96,563.99)
15	0%	\$0.2500000000	\$305,240.00	59,621.70	\$14,905.43	\$223,581.45	(\$81,658.56)
16	0%	\$0.2500000000	\$305,240.00	59,621.70	\$14,905.43	\$238,486.88	(\$66,753.13)
17	0%	\$0.2500000000	\$305,240.00	59,621.70	\$14,905.43	\$253,392.31	(\$51,847.70)
18	0%	\$0.2500000000	\$305,240.00	59,621.70	\$14,905.43	\$268,297.74	(\$36,942.27)
19	0%	\$0.2500000000	\$305,240.00	59,621.70	\$14,905.43	\$283,203.17	(\$22,036.84)
20	0%	\$0.2500000000	\$305,240.00	59,621.70	\$14,905.43	\$298,108.60	(\$7,131.41)
21	0%	\$0.2500000000	\$305,240.00	59,621.70	\$14,905.43	\$313,014.03	\$7,774.02
22	0%	\$0.2500000000	\$305,240.00	59,621.70	\$14,905.43	\$327,919.46	\$22,679.45
23	0%	\$0.2500000000	\$305,240.00	59,621.70	\$14,905.43	\$342,824.89	\$37,584.88
24	0%	\$0.2500000000	\$305,240.00	59,621.70	\$14,905.43	\$357,730.32	\$52,490.31
25	0%	\$0.2500000000	\$305,240.00	59,621.70	\$14,905.43	\$372,635.75	\$67,395.74

### F-2: 2.443% Inflationary Model Cost Analysis for 48.88 kW PV System at El Portal

Year	Annual Growth	Cost/kWh	Lifetime Cost	Annual Output (kWh)	Annual Value of Output	Aggregate Value of Output	Profit
0	-	-	\$305,240.00	0	\$0.00	\$0.00	(\$305,240.00)
1	2.443%	0.2500000000	\$305,240.00	59,621.70	\$14,905.43	\$14,905.43	(\$290,334.58)
2	2.443%	0.2561075000	\$305,240.00	59,621.70	\$15,269.56	\$30,174.99	(\$275,065.01)
3	2.443%	0.2623642062	\$305,240.00	59,621.70	\$15,642.60	\$45,817.59	(\$259,422.41)
4	2.443%	0.2687737638	\$305,240.00	59,621.70	\$16,024.75	\$61,842.34	(\$243,397.66)
5	2.443%	0.2753399068	\$305,240.00	59,621.70	\$16,416.23	\$78,258.57	(\$226,981.43)
6	2.443%	0.2820664608	\$305,240.00	59,621.70	\$16,817.28	\$95,075.85	(\$210,164.15)
7	2.443%	0.2889573444	\$305,240.00	59,621.70	\$17,228.13	\$112,303.98	(\$192,936.02)
8	2.443%	0.2960165723	\$305,240.00	59,621.70	\$17,649.01	\$129,952.99	(\$175,287.01)
9	2.443%	0.3032482572	\$305,240.00	59,621.70	\$18,080.18	\$148,033.17	(\$157,206.83)
10	2.443%	0.3106566121	\$305,240.00	59,621.70	\$18,521.88	\$166,555.04	(\$138,684.96)
11	2.443%	0.3182459531	\$305,240.00	59,621.70	\$18,974.36	\$185,529.41	(\$119,710.59)
12	2.443%	0.3260207018	\$305,240.00	59,621.70	\$19,437.91	\$204,967.32	(\$100,272.68)
13	2.443%	0.3339853875	\$305,240.00	59,621.70	\$19,912.78	\$224,880.09	(\$80,359.91)
14	2.443%	0.3421446505	\$305,240.00	59,621.70	\$20,399.25	\$245,279.34	(\$59,960.66)
15	2.443%	0.3505032443	\$305,240.00	59,621.70	\$20,897.60	\$266,176.94	(\$39,063.06)
16	2.443%	0.3590660386	\$305,240.00	59,621.70	\$21,408.13	\$287,585.07	(\$17,654.93)
17	2.443%	0.3678380219	\$305,240.00	59,621.70	\$21,931.13	\$309,516.20	\$4,276.20
18	2.443%	0.3768243048	\$305,240.00	59,621.70	\$22,466.91	\$331,983.10	\$26,743.10
19	2.443%	0.3860301226	\$305,240.00	59,621.70	\$23,015.77	\$354,998.87	\$49,758.87
20	2.443%	0.3954608385	\$305,240.00	59,621.70	\$23,578.05	\$378,576.92	\$73,336.92
21	2.443%	0.4051219467	\$305,240.00	59,621.70	\$24,154.06	\$402,730.98	\$97,490.98
22	2.443%	0.4150190759	\$305,240.00	59,621.70	\$24,744.14	\$427,475.12	\$122,235.12
23	2.443%	0.4251579919	\$305,240.00	59,621.70	\$25,348.64	\$452,823.76	\$147,583.76
24	2.443%	0.4355446017	\$305,240.00	59,621.70	\$25,967.91	\$478,791.67	\$173,551.67
25	2.443%	0.4461849563	\$305,240.00	59,621.70	\$26,602.31	\$505,393.98	\$200,153.98

### F-3: 3% Inflationary Model Cost Analysis for 48.88 kW PV System at El Portal

Year	Annual Growth	Cost/kWh	Lifetime Cost	Annual Output (kWh)	Annual Value of Output	Aggregate Value of Output	Profit
0	-	-	\$305,240.00	0	\$0.00	\$0.00	(\$305,240.00)
1	3%	\$0.2500000000	\$305,240.00	59,621.70	\$14,905.43	\$14,905.43	(\$290,334.58)
2	3%	\$0.2575000000	\$305,240.00	59,621.70	\$15,352.59	\$30,258.01	(\$274,981.99)
3	3%	\$0.2652250000	\$305,240.00	59,621.70	\$15,813.17	\$46,071.18	(\$259,168.82)
4	3%	\$0.2731817500	\$305,240.00	59,621.70	\$16,287.56	\$62,358.74	(\$242,881.26)
5	3%	\$0.2813772025	\$305,240.00	59,621.70	\$16,776.19	\$79,134.93	(\$226,105.07)
6	3%	\$0.2898185186	\$305,240.00	59,621.70	\$17,279.47	\$96,414.40	(\$208,825.60)
7	3%	\$0.2985130741	\$305,240.00	59,621.70	\$17,797.86	\$114,212.26	(\$191,027.74)
8	3%	\$0.3074684664	\$305,240.00	59,621.70	\$18,331.79	\$132,544.05	(\$172,695.95)
9	3%	\$0.3166925203	\$305,240.00	59,621.70	\$18,881.75	\$151,425.79	(\$153,814.21)
10	3%	\$0.3261932960	\$305,240.00	59,621.70	\$19,448.20	\$170,873.99	(\$134,366.01)
11	3%	\$0.3359790948	\$305,240.00	59,621.70	\$20,031.64	\$190,905.64	(\$114,334.36)
12	3%	\$0.3460584677	\$305,240.00	59,621.70	\$20,632.59	\$211,538.23	(\$93,701.77)
13	3%	\$0.3564402217	\$305,240.00	59,621.70	\$21,251.57	\$232,789.80	(\$72,450.20)
14	3%	\$0.3671334284	\$305,240.00	59,621.70	\$21,889.12	\$254,678.92	(\$50,561.08)
15	3%	\$0.3781474312	\$305,240.00	59,621.70	\$22,545.79	\$277,224.72	(\$28,015.28)
16	3%	\$0.3894918542	\$305,240.00	59,621.70	\$23,222.17	\$300,446.88	(\$4,793.12)
17	3%	\$0.4011766098	\$305,240.00	59,621.70	\$23,918.83	\$324,365.71	\$19,125.71
18	3%	\$0.4132119081	\$305,240.00	59,621.70	\$24,636.40	\$349,002.11	\$43,762.11
19	3%	\$0.4256082653	\$305,240.00	59,621.70	\$25,375.49	\$374,377.60	\$69,137.60
20	3%	\$0.4383765133	\$305,240.00	59,621.70	\$26,136.75	\$400,514.35	\$95,274.35
21	3%	\$0.4515278087	\$305,240.00	59,621.70	\$26,920.86	\$427,435.21	\$122,195.21
22	3%	\$0.4650736429	\$305,240.00	59,621.70	\$27,728.48	\$455,163.69	\$149,923.69
23	3%	\$0.4790258522	\$305,240.00	59,621.70	\$28,560.34	\$483,724.02	\$178,484.02
24	3%	\$0.4933966278	\$305,240.00	59,621.70	\$29,417.15	\$513,141.17	\$207,901.17
25	3%	\$0.5081985266	\$305,240.00	59,621.70	\$30,299.66	\$543,440.83	\$238,200.83

### F-4: 0% Inflationary Model Cost Analysis for 48.88 kW PV System at Catalina Service Center

Year	Annual Growth	Cost/kWh	Lifetime Cost	Annual Output (kWh)	Annual Value of Output	Aggregate Value of Output	Profit
0	-	-	\$229,055.00	0	\$0.00	\$0.00	(\$229,055.00)
1	0%	\$0.2500000000	\$229,055.00	44716.3	\$11,179.08	\$11,179.08	(\$217,875.93)
2	0%	\$0.2500000000	\$229,055.00	44716.3	\$11,179.08	\$22,358.15	(\$206,696.85)
3	0%	\$0.2500000000	\$229,055.00	44716.3	\$11,179.08	\$33,537.23	(\$195,517.78)
4	0%	\$0.2500000000	\$229,055.00	44716.3	\$11,179.08	\$44,716.30	(\$184,338.70)
5	0%	\$0.2500000000	\$229,055.00	44716.3	\$11,179.08	\$55,895.38	(\$173,159.63)
6	0%	\$0.2500000000	\$229,055.00	44716.3	\$11,179.08	\$67,074.45	(\$161,980.55)
7	0%	\$0.2500000000	\$229,055.00	44716.3	\$11,179.08	\$78,253.53	(\$150,801.48)
8	0%	\$0.2500000000	\$229,055.00	44716.3	\$11,179.08	\$89,432.60	(\$139,622.40)
9	0%	\$0.2500000000	\$229,055.00	44716.3	\$11,179.08	\$100,611.68	(\$128,443.33)
10	0%	\$0.2500000000	\$229,055.00	44716.3	\$11,179.08	\$111,790.75	(\$117,264.25)
11	0%	\$0.2500000000	\$229,055.00	44716.3	\$11,179.08	\$122,969.83	(\$106,085.18)
12	0%	\$0.2500000000	\$229,055.00	44716.3	\$11,179.08	\$134,148.90	(\$94,906.10)
13	0%	\$0.2500000000	\$229,055.00	44716.3	\$11,179.08	\$145,327.98	(\$83,727.03)
14	0%	\$0.2500000000	\$229,055.00	44716.3	\$11,179.08	\$156,507.05	(\$72,547.95)
15	0%	\$0.2500000000	\$229,055.00	44716.3	\$11,179.08	\$167,686.13	(\$61,368.88)
16	0%	\$0.2500000000	\$229,055.00	44716.3	\$11,179.08	\$178,865.20	(\$50,189.80)
17	0%	\$0.2500000000	\$229,055.00	44716.3	\$11,179.08	\$190,044.28	(\$39,010.72)
18	0%	\$0.2500000000	\$229,055.00	44716.3	\$11,179.08	\$201,223.35	(\$27,831.65)
19	0%	\$0.2500000000	\$229,055.00	44716.3	\$11,179.08	\$212,402.43	(\$16,652.57)
20	0%	\$0.2500000000	\$229,055.00	44716.3	\$11,179.08	\$223,581.50	(\$5,473.50)
21	0%	\$0.2500000000	\$229,055.00	44716.3	\$11,179.08	\$234,760.58	\$5,705.58
22	0%	\$0.2500000000	\$229,055.00	44716.3	\$11,179.08	\$245,939.65	\$16,884.65
23	0%	\$0.2500000000	\$229,055.00	44716.3	\$11,179.08	\$257,118.73	\$28,063.73
24	0%	\$0.2500000000	\$229,055.00	44716.3	\$11,179.08	\$268,297.80	\$39,242.80
25	0%	\$0.2500000000	\$229,055.00	44716.3	\$11,179.08	\$279,476.88	\$50,421.88



### F-5: 2.443% Inflationary Model Cost Analysis for 48.88 kW PV System at Catalina Service Center

Year	Annual Growth	Cost/kWh	Lifetime Cost	Annual Output (kWh)	Annual Value of Output	Aggregate Value of Output	Profit
0	-	-	\$229,055.00	0	\$0.00	\$0.00	(\$229,055.00)
1	2.443%	\$0.2500000000	\$229,055.00	44716.3	\$11,179.08	\$11,179.08	(\$217,875.93)
2	2.443%	\$0.2561075000	\$229,055.00	44716.3	\$11,452.18	\$22,631.25	(\$206,423.75)
3	2.443%	\$0.2623642062	\$229,055.00	44716.3	\$11,731.96	\$34,363.21	(\$194,691.79)
4	2.443%	\$0.2687737638	\$229,055.00	44716.3	\$12,018.57	\$46,381.78	(\$182,673.22)
5	2.443%	\$0.2753399068	\$229,055.00	44716.3	\$12,312.18	\$58,693.96	(\$170,361.04)
6	2.443%	\$0.2820664608	\$229,055.00	44716.3	\$12,612.97	\$71,306.93	(\$157,748.07)
7	2.443%	\$0.2889573444	\$229,055.00	44716.3	\$12,921.10	\$84,228.03	(\$144,826.97)
8	2.443%	\$0.2960165723	\$229,055.00	44716.3	\$13,236.77	\$97,464.80	(\$131,590.20)
9	2.443%	\$0.3032482572	\$229,055.00	44716.3	\$13,560.14	\$111,024.94	(\$118,030.06)
10	2.443%	\$0.3106566121	\$229,055.00	44716.3	\$13,891.41	\$124,916.35	(\$104,138.65)
11	2.443%	\$0.3182459531	\$229,055.00	44716.3	\$14,230.78	\$139,147.13	(\$89,907.87)
12	2.443%	\$0.326207018	\$229,055.00	44716.3	\$14,578.44	\$153,725.57	(\$75,329.43)
13	2.443%	\$0.3339853875	\$229,055.00	44716.3	\$14,934.59	\$168,660.17	(\$60,394.83)
14	2.443%	\$0.3421446505	\$229,055.00	44716.3	\$15,299.44	\$183,959.61	(\$45,095.39)
15	2.443%	\$0.3505032443	\$229,055.00	44716.3	\$15,673.21	\$199,632.82	(\$29,422.18)
16	2.443%	\$0.3590660386	\$229,055.00	44716.3	\$16,056.10	\$215,688.92	(\$13,366.08)
17	2.443%	\$0.3678380219	\$229,055.00	44716.3	\$16,448.36	\$232,137.28	\$3,082.28
18	2.443%	\$0.3768243048	\$229,055.00	44716.3	\$16,850.19	\$248,987.46	\$19,932.46
19	2.443%	\$0.3860301226	\$229,055.00	44716.3	\$17,261.84	\$266,249.30	\$37,194.30
20	2.443%	\$0.3954608385	\$229,055.00	44716.3	\$17,683.55	\$283,932.85	\$54,877.85
21	2.443%	\$0.4051219467	\$229,055.00	44716.3	\$18,115.55	\$302,048.40	\$72,993.40
22	2.443%	\$0.4150190759	\$229,055.00	44716.3	\$18,558.12	\$320,606.52	\$91,551.52
23	2.443%	\$0.4251579919	\$229,055.00	44716.3	\$19,011.49	\$339,618.01	\$110,563.01
24	2.443%	\$0.4355446017	\$229,055.00	44716.3	\$19,475.94	\$359,093.96	\$130,038.96
25	2.443%	\$0.4461849563	\$229,055.00	44716.3	\$19,951.74	\$379,045.70	\$149,990.70

### F-6: 3% Inflationary Model Cost Analysis for 48.88 kW PV System at Catalina Service Center

Year	Annual Growth	Cost/kWh	Lifetime Cost	Annual Output (kWh)	Annual Value of Output	Aggregate Value of Output	Profit
0	-	-	\$229,055.00	0	\$0.00	\$0.00	(\$229,055.00)
1	3%	\$0.2500000000	\$229,055.00	44716.3	\$11,179.08	\$11,179.08	(\$217,875.93)
2	3%	\$0.2575000000	\$229,055.00	44716.3	\$11,514.45	\$22,693.52	(\$206,361.48)
3	3%	\$0.2652250000	\$229,055.00	44716.3	\$11,859.88	\$34,553.40	(\$194,501.60)
4	3%	\$0.2731817500	\$229,055.00	44716.3	\$12,215.68	\$46,769.08	(\$182,285.92)
5	3%	\$0.2813772025	\$229,055.00	44716.3	\$12,582.15	\$59,351.23	(\$169,703.77)
6	3%	\$0.2898185186	\$229,055.00	44716.3	\$12,959.61	\$72,310.84	(\$156,744.16)
7	3%	\$0.2985130741	\$229,055.00	44716.3	\$13,348.40	\$85,659.24	(\$143,395.76)
8	3%	\$0.3074684664	\$229,055.00	44716.3	\$13,748.85	\$99,408.09	(\$129,646.91)
9	3%	\$0.3166925203	\$229,055.00	44716.3	\$14,161.32	\$113,569.41	(\$115,485.59)
10	3%	\$0.3261932960	\$229,055.00	44716.3	\$14,586.16	\$128,155.57	(\$100,899.43)
11	3%	\$0.3359790948	\$229,055.00	44716.3	\$15,023.74	\$143,179.31	(\$85,875.69)
12	3%	\$0.3460584677	\$229,055.00	44716.3	\$15,474.45	\$158,653.76	(\$70,401.24)
13	3%	\$0.3564402217	\$229,055.00	44716.3	\$15,938.69	\$174,592.45	(\$54,462.55)
14	3%	\$0.3671334284	\$229,055.00	44716.3	\$16,416.85	\$191,009.30	(\$38,045.70)
15	3%	\$0.3781474312	\$229,055.00	44716.3	\$16,909.35	\$207,918.65	(\$21,136.35)
16	3%	\$0.3894918542	\$229,055.00	44716.3	\$17,416.63	\$225,335.29	(\$3,719.71)
17	3%	\$0.4011766098	\$229,055.00	44716.3	\$17,939.13	\$243,274.42	\$14,219.42
18	3%	\$0.4132119081	\$229,055.00	44716.3	\$18,477.31	\$261,751.73	\$32,696.73
19	3%	\$0.4256082653	\$229,055.00	44716.3	\$19,031.63	\$280,783.36	\$51,728.36
20	3%	\$0.4383765133	\$229,055.00	44716.3	\$19,602.58	\$300,385.93	\$71,330.93
21	3%	\$0.4515278087	\$229,055.00	44716.3	\$20,190.65	\$320,576.58	\$91,521.58
22	3%	\$0.4650736429	\$229,055.00	44716.3	\$20,796.37	\$341,372.96	\$112,317.96
23	3%	\$0.4790258522	\$229,055.00	44716.3	\$21,420.26	\$362,793.22	\$133,738.22
24	3%	\$0.4933966278	\$229,055.00	44716.3	\$22,062.87	\$384,856.09	\$155,801.09
25	3%	\$0.5081985266	\$229,055.00	44716.3	\$22,724.76	\$407,580.85	\$178,525.85

**F-7: Payback Period for PV Systems under 0% Inflationary Model**

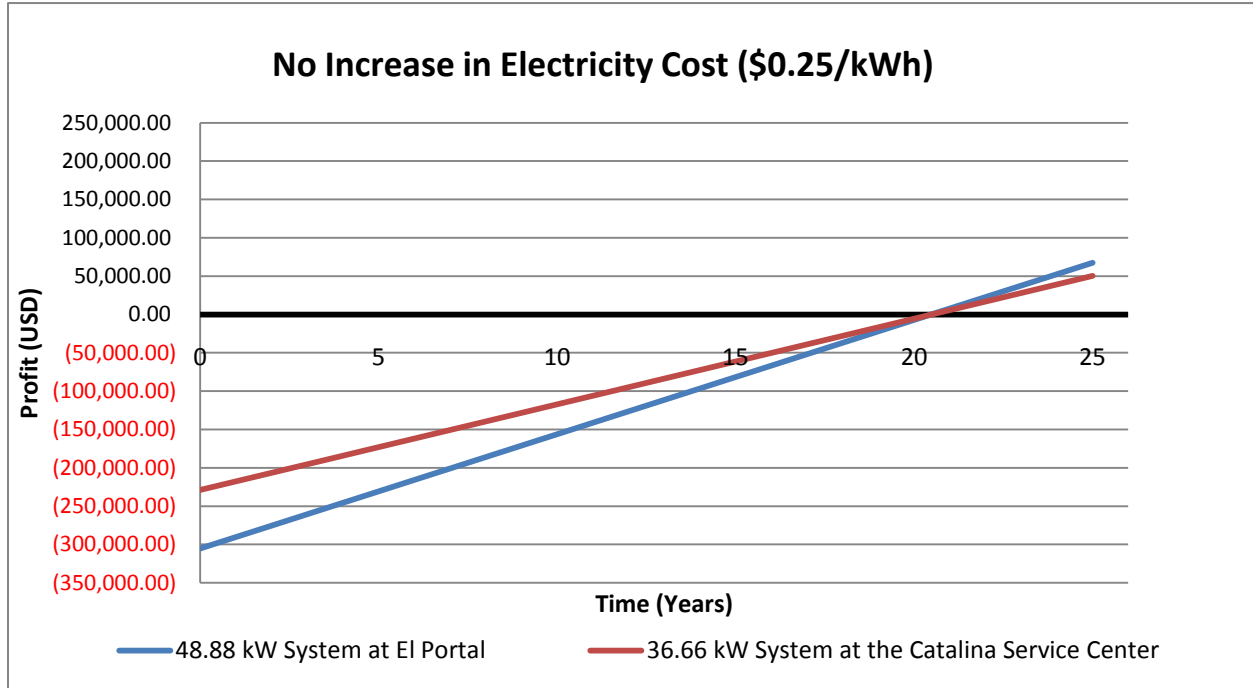

**F-8: Payback Period for PV Systems under 2.443% Inflationary Model**

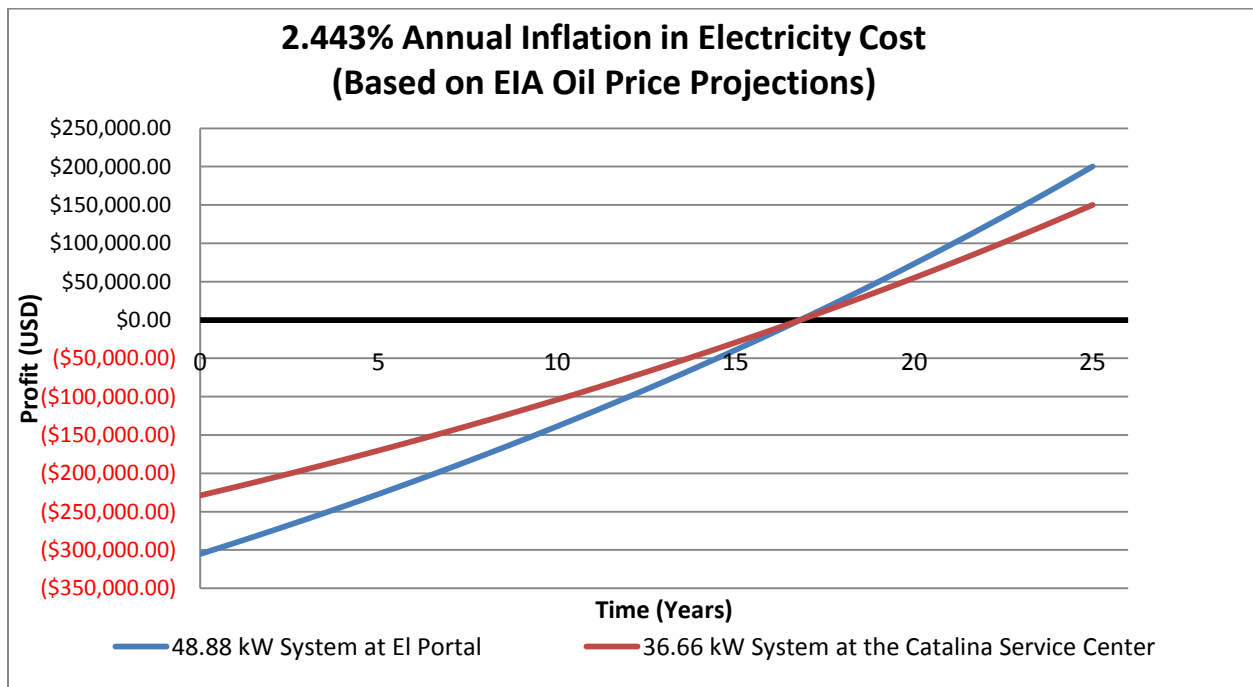

**F-9: Payback Period for PV Systems under 3% Inflationary Model**

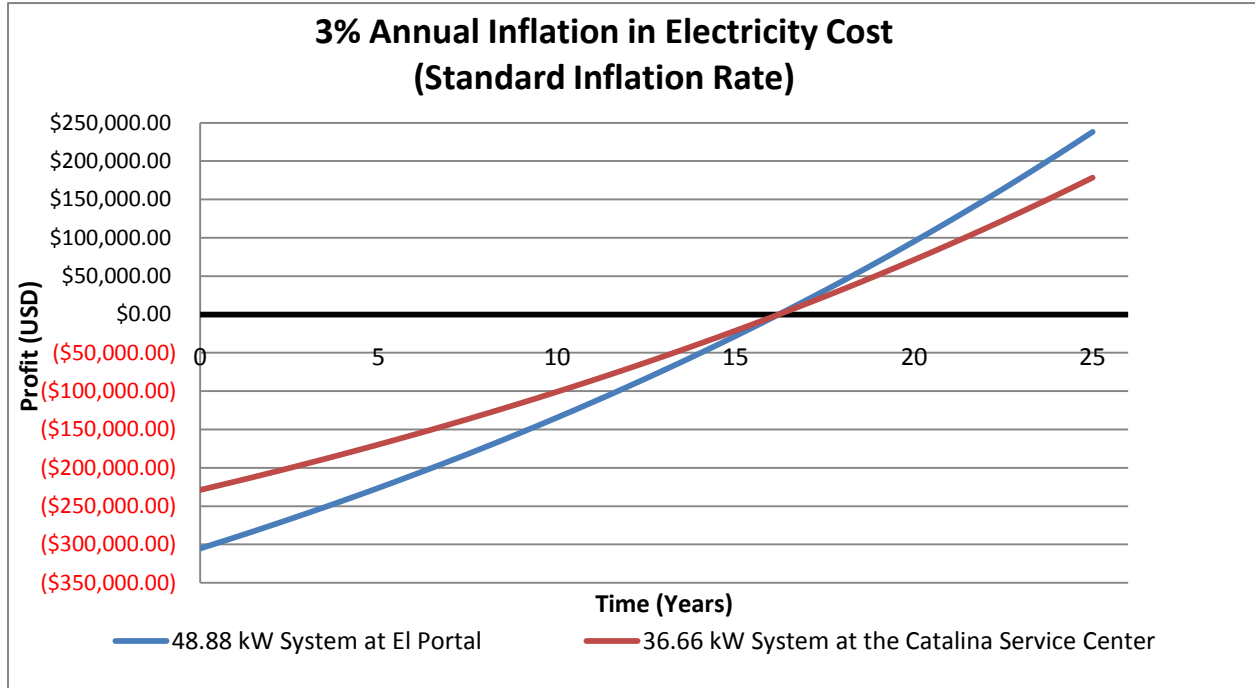

## APPENDIX G: Cost Analysis Tables and Graphs - Hydropower

### G-1: 0% Inflationary Model Cost Analysis for 396 W Hydropower System

Year	Annual Growth	Cost/kWh	Lifetime Cost	Annual Output (kWh)	Annual Value of Output	Aggregate Value of Output	Profit
0	-	-	\$10,000.00	0	\$0.00	\$0.00	(\$10,000.00)
1	0%	\$0.2500000000	\$10,000.00	3,469.00	\$867.25	\$867.25	(\$9,132.75)
2	0%	\$0.2500000000	\$10,000.00	3,469.00	\$867.25	\$1,734.50	(\$8,265.50)
3	0%	\$0.2500000000	\$10,000.00	3,469.00	\$867.25	\$2,601.75	(\$7,398.25)
4	0%	\$0.2500000000	\$10,000.00	3,469.00	\$867.25	\$3,469.00	(\$6,531.00)
5	0%	\$0.2500000000	\$10,000.00	3,469.00	\$867.25	\$4,336.25	(\$5,663.75)
6	0%	\$0.2500000000	\$10,000.00	3,469.00	\$867.25	\$5,203.50	(\$4,796.50)
7	0%	\$0.2500000000	\$10,000.00	3,469.00	\$867.25	\$6,070.75	(\$3,929.25)
8	0%	\$0.2500000000	\$10,000.00	3,469.00	\$867.25	\$6,938.00	(\$3,062.00)
9	0%	\$0.2500000000	\$10,000.00	3,469.00	\$867.25	\$7,805.25	(\$2,194.75)
10	0%	\$0.2500000000	\$10,000.00	3,469.00	\$867.25	\$8,672.50	(\$1,327.50)
11	0%	\$0.2500000000	\$10,000.00	3,469.00	\$867.25	\$9,539.75	(\$460.25)
12	0%	\$0.2500000000	\$10,000.00	3,469.00	\$867.25	\$10,407.00	\$407.00
13	0%	\$0.2500000000	\$10,000.00	3,469.00	\$867.25	\$11,274.25	\$1,274.25
14	0%	\$0.2500000000	\$10,000.00	3,469.00	\$867.25	\$12,141.50	\$2,141.50
15	0%	\$0.2500000000	\$10,000.00	3,469.00	\$867.25	\$13,008.75	\$3,008.75
16	0%	\$0.2500000000	\$10,000.00	3,469.00	\$867.25	\$13,876.00	\$3,876.00
17	0%	\$0.2500000000	\$10,000.00	3,469.00	\$867.25	\$14,743.25	\$4,743.25
18	0%	\$0.2500000000	\$10,000.00	3,469.00	\$867.25	\$15,610.50	\$5,610.50
19	0%	\$0.2500000000	\$10,000.00	3,469.00	\$867.25	\$16,477.75	\$6,477.75
20	0%	\$0.2500000000	\$10,000.00	3,469.00	\$867.25	\$17,345.00	\$7,345.00
21	0%	\$0.2500000000	\$10,000.00	3,469.00	\$867.25	\$18,212.25	\$8,212.25
22	0%	\$0.2500000000	\$10,000.00	3,469.00	\$867.25	\$19,079.50	\$9,079.50
23	0%	\$0.2500000000	\$10,000.00	3,469.00	\$867.25	\$19,946.75	\$9,946.75
24	0%	\$0.2500000000	\$10,000.00	3,469.00	\$867.25	\$20,814.00	\$10,814.00
25	0%	\$0.2500000000	\$10,000.00	3,469.00	\$867.25	\$21,681.25	\$11,681.25

### G-2: 2.443% Inflationary Model Cost Analysis for 396 W Hydropower System

Year	Annual Growth	Cost/kWh	Lifetime Cost	Annual Output (kWh)	Annual Value of Output	Aggregate Value of Output	Profit
0	-	-	\$10,000.00	0	\$0.00	\$0.00	(\$10,000.00)
1	2.443%	\$0.2500000000	\$10,000.00	3,469.00	\$867.25	\$867.25	(\$9,132.75)
2	2.443%	\$0.2561075000	\$10,000.00	3,469.00	\$888.44	\$1,755.69	(\$8,244.31)
3	2.443%	\$0.2623642062	\$10,000.00	3,469.00	\$910.14	\$2,665.83	(\$7,334.17)
4	2.443%	\$0.2687737638	\$10,000.00	3,469.00	\$932.38	\$3,598.20	(\$6,401.80)
5	2.443%	\$0.2753399068	\$10,000.00	3,469.00	\$955.15	\$4,553.36	(\$5,446.64)
6	2.443%	\$0.2820664608	\$10,000.00	3,469.00	\$978.49	\$5,531.85	(\$4,468.15)
7	2.443%	\$0.2889573444	\$10,000.00	3,469.00	\$1,002.39	\$6,534.24	(\$3,465.76)
8	2.443%	\$0.2960165723	\$10,000.00	3,469.00	\$1,026.88	\$7,561.12	(\$2,438.88)
9	2.443%	\$0.3032482572	\$10,000.00	3,469.00	\$1,051.97	\$8,613.09	(\$1,386.91)
10	2.443%	\$0.3106566121	\$10,000.00	3,469.00	\$1,077.67	\$9,690.76	(\$309.24)
11	2.443%	\$0.3182459531	\$10,000.00	3,469.00	\$1,104.00	\$10,794.75	\$794.75
12	2.443%	\$0.3260207018	\$10,000.00	3,469.00	\$1,130.97	\$11,925.72	\$1,925.72
13	2.443%	\$0.3339853875	\$10,000.00	3,469.00	\$1,158.60	\$13,084.31	\$3,084.31
14	2.443%	\$0.3421446505	\$10,000.00	3,469.00	\$1,186.90	\$14,271.21	\$4,271.21
15	2.443%	\$0.3505032443	\$10,000.00	3,469.00	\$1,215.90	\$15,487.11	\$5,487.11
16	2.443%	\$0.3590660386	\$10,000.00	3,469.00	\$1,245.60	\$16,732.71	\$6,732.71
17	2.443%	\$0.3678380219	\$10,000.00	3,469.00	\$1,276.03	\$18,008.74	\$8,008.74
18	2.443%	\$0.3768243048	\$10,000.00	3,469.00	\$1,307.20	\$19,315.94	\$9,315.94
19	2.443%	\$0.3860301226	\$10,000.00	3,469.00	\$1,339.14	\$20,655.08	\$10,655.08
20	2.443%	\$0.3954608385	\$10,000.00	3,469.00	\$1,371.85	\$22,026.94	\$12,026.94
21	2.443%	\$0.4051219467	\$10,000.00	3,469.00	\$1,405.37	\$23,432.30	\$13,432.30
22	2.443%	\$0.4150190759	\$10,000.00	3,469.00	\$1,439.70	\$24,872.00	\$14,872.00
23	2.443%	\$0.4251579919	\$10,000.00	3,469.00	\$1,474.87	\$26,346.88	\$16,346.88
24	2.443%	\$0.4355446017	\$10,000.00	3,469.00	\$1,510.90	\$27,857.78	\$17,857.78
25	2.443%	\$0.4461849563	\$10,000.00	3,469.00	\$1,547.82	\$29,405.60	\$19,405.60

### G-3: 3% Inflationary Model Cost Analysis for 396 W Hydropower System

Year	Annual Growth	Cost/kWh	Lifetime Cost	Annual Output (kWh)	Annual Value of Output	Aggregate Value of Output	Profit
0	-	-	\$10,000.00	0	\$0.00	\$0.00	(\$10,000.00)
1	3.000%	\$0.2500000000	\$10,000.00	3,469.00	\$867.25	\$867.25	(\$9,132.75)
2	3.000%	\$0.2575000000	\$10,000.00	3,469.00	\$893.27	\$1,760.52	(\$8,239.48)
3	3.000%	\$0.2652250000	\$10,000.00	3,469.00	\$920.07	\$2,680.58	(\$7,319.42)
4	3.000%	\$0.2731817500	\$10,000.00	3,469.00	\$947.67	\$3,628.25	(\$6,371.75)
5	3.000%	\$0.2813772025	\$10,000.00	3,469.00	\$976.10	\$4,604.35	(\$5,395.65)
6	3.000%	\$0.2898185186	\$10,000.00	3,469.00	\$1,005.38	\$5,609.73	(\$4,390.27)
7	3.000%	\$0.2985130741	\$10,000.00	3,469.00	\$1,035.54	\$6,645.27	(\$3,354.73)
8	3.000%	\$0.3074684664	\$10,000.00	3,469.00	\$1,066.61	\$7,711.88	(\$2,288.12)
9	3.000%	\$0.3166925203	\$10,000.00	3,469.00	\$1,098.61	\$8,810.48	(\$1,189.52)
10	3.000%	\$0.3261932960	\$10,000.00	3,469.00	\$1,131.56	\$9,942.05	(\$75.95)
11	3.000%	\$0.3359790948	\$10,000.00	3,469.00	\$1,165.51	\$11,107.56	\$1,107.56
12	3.000%	\$0.3460584677	\$10,000.00	3,469.00	\$1,200.48	\$12,308.04	\$2,308.04
13	3.000%	\$0.3564402217	\$10,000.00	3,469.00	\$1,236.49	\$13,544.53	\$3,544.53
14	3.000%	\$0.3671334284	\$10,000.00	3,469.00	\$1,273.59	\$14,818.11	\$4,818.11
15	3.000%	\$0.3781474312	\$10,000.00	3,469.00	\$1,311.79	\$16,129.91	\$6,129.91
16	3.000%	\$0.3894918542	\$10,000.00	3,469.00	\$1,351.15	\$17,481.06	\$7,481.06
17	3.000%	\$0.4011766098	\$10,000.00	3,469.00	\$1,391.68	\$18,872.74	\$8,872.74
18	3.000%	\$0.4132119081	\$10,000.00	3,469.00	\$1,433.43	\$20,306.17	\$10,306.17
19	3.000%	\$0.4256082653	\$10,000.00	3,469.00	\$1,476.44	\$21,782.60	\$11,782.60
20	3.000%	\$0.4383765133	\$10,000.00	3,469.00	\$1,520.73	\$23,303.33	\$13,303.33
21	3.000%	\$0.4515278087	\$10,000.00	3,469.00	\$1,566.35	\$24,869.68	\$14,869.68
22	3.000%	\$0.4650736429	\$10,000.00	3,469.00	\$1,613.34	\$26,483.02	\$16,483.02
23	3.000%	\$0.4790258522	\$10,000.00	3,469.00	\$1,661.74	\$28,144.76	\$18,144.76
24	3.000%	\$0.4933966278	\$10,000.00	3,469.00	\$1,711.59	\$29,856.36	\$19,856.36
25	3.000%	\$0.5081985266	\$10,000.00	3,469.00	\$1,762.94	\$31,619.30	\$21,619.30

### G-4: 0% Inflationary Model Cost Analysis for 283 W Hydropower System

Year	Annual Growth	Cost/kWh	Lifetime Cost	Annual Output (kWh)	Annual Value of Output	Aggregate Value of Output	Profit
0	-	-	\$10,000.00	0	\$0.00	\$0.00	(\$10,000.00)
1	0%	\$0.2500000000	\$10,000.00	2,479.00	\$619.75	\$619.75	(\$9,380.25)
2	0%	\$0.2500000000	\$10,000.00	2,479.00	\$619.75	\$1,239.50	(\$8,760.50)
3	0%	\$0.2500000000	\$10,000.00	2,479.00	\$619.75	\$1,859.25	(\$8,140.75)
4	0%	\$0.2500000000	\$10,000.00	2,479.00	\$619.75	\$2,479.00	(\$7,521.00)
5	0%	\$0.2500000000	\$10,000.00	2,479.00	\$619.75	\$3,098.75	(\$6,901.25)
6	0%	\$0.2500000000	\$10,000.00	2,479.00	\$619.75	\$3,718.50	(\$6,281.50)
7	0%	\$0.2500000000	\$10,000.00	2,479.00	\$619.75	\$4,338.25	(\$5,661.75)
8	0%	\$0.2500000000	\$10,000.00	2,479.00	\$619.75	\$4,958.00	(\$5,042.00)
9	0%	\$0.2500000000	\$10,000.00	2,479.00	\$619.75	\$5,577.75	(\$4,422.25)
10	0%	\$0.2500000000	\$10,000.00	2,479.00	\$619.75	\$6,197.50	(\$3,802.50)
11	0%	\$0.2500000000	\$10,000.00	2,479.00	\$619.75	\$6,817.25	(\$3,182.75)
12	0%	\$0.2500000000	\$10,000.00	2,479.00	\$619.75	\$7,437.00	(\$2,563.00)
13	0%	\$0.2500000000	\$10,000.00	2,479.00	\$619.75	\$8,056.75	(\$1,943.25)
14	0%	\$0.2500000000	\$10,000.00	2,479.00	\$619.75	\$8,676.50	(\$1,323.50)
15	0%	\$0.2500000000	\$10,000.00	2,479.00	\$619.75	\$9,296.25	(\$703.75)
16	0%	\$0.2500000000	\$10,000.00	2,479.00	\$619.75	\$9,916.00	(\$84.00)
17	0%	\$0.2500000000	\$10,000.00	2,479.00	\$619.75	\$10,535.75	\$535.75
18	0%	\$0.2500000000	\$10,000.00	2,479.00	\$619.75	\$11,155.50	\$1,155.50
19	0%	\$0.2500000000	\$10,000.00	2,479.00	\$619.75	\$11,775.25	\$1,775.25
20	0%	\$0.2500000000	\$10,000.00	2,479.00	\$619.75	\$12,395.00	\$2,395.00
21	0%	\$0.2500000000	\$10,000.00	2,479.00	\$619.75	\$13,014.75	\$3,014.75
22	0%	\$0.2500000000	\$10,000.00	2,479.00	\$619.75	\$13,634.50	\$3,634.50
23	0%	\$0.2500000000	\$10,000.00	2,479.00	\$619.75	\$14,254.25	\$4,254.25
24	0%	\$0.2500000000	\$10,000.00	2,479.00	\$619.75	\$14,874.00	\$4,874.00
25	0%	\$0.2500000000	\$10,000.00	2,479.00	\$619.75	\$15,493.75	\$5,493.75

### G-5: 2.443% Inflationary Model Cost Analysis for 283 W Hydropower System

Year	Annual Growth	Cost/kWh	Lifetime Cost	Annual Output (kWh)	Annual Value of Output	Aggregate Value of Output	Profit
0	-	-	\$10,000.00	0	\$0.00	\$0.00	(\$10,000.00)
1	2.443%	\$0.2500000000	\$10,000.00	2,479.00	\$619.75	\$619.75	(\$9,380.25)
2	2.443%	\$0.2561075000	\$10,000.00	2,479.00	\$634.89	\$1,254.64	(\$8,745.36)
3	2.443%	\$0.2623642062	\$10,000.00	2,479.00	\$650.40	\$1,905.04	(\$8,094.96)
4	2.443%	\$0.2687737638	\$10,000.00	2,479.00	\$666.29	\$2,571.33	(\$7,428.67)
5	2.443%	\$0.2753399068	\$10,000.00	2,479.00	\$682.57	\$3,253.90	(\$6,746.10)
6	2.443%	\$0.2820664608	\$10,000.00	2,479.00	\$699.24	\$3,953.14	(\$6,046.86)
7	2.443%	\$0.2889573444	\$10,000.00	2,479.00	\$716.33	\$4,669.47	(\$5,330.53)
8	2.443%	\$0.2960165723	\$10,000.00	2,479.00	\$733.83	\$5,403.29	(\$4,596.71)
9	2.443%	\$0.3032482572	\$10,000.00	2,479.00	\$751.75	\$6,155.04	(\$3,844.96)
10	2.443%	\$0.3106566121	\$10,000.00	2,479.00	\$770.12	\$6,925.16	(\$3,074.84)
11	2.443%	\$0.3182459531	\$10,000.00	2,479.00	\$788.93	\$7,714.09	(\$2,285.91)
12	2.443%	\$0.3260207018	\$10,000.00	2,479.00	\$808.21	\$8,522.30	(\$1,477.70)
13	2.443%	\$0.3339853875	\$10,000.00	2,479.00	\$827.95	\$9,350.25	(\$649.75)
14	2.443%	\$0.3421446505	\$10,000.00	2,479.00	\$848.18	\$10,198.43	\$198.43
15	2.443%	\$0.3505032443	\$10,000.00	2,479.00	\$868.90	\$11,067.32	\$1,067.32
16	2.443%	\$0.3590660386	\$10,000.00	2,479.00	\$890.12	\$11,957.45	\$1,957.45
17	2.443%	\$0.3678380219	\$10,000.00	2,479.00	\$911.87	\$12,869.32	\$2,869.32
18	2.443%	\$0.3768243048	\$10,000.00	2,479.00	\$934.15	\$13,803.47	\$3,803.47
19	2.443%	\$0.3860301226	\$10,000.00	2,479.00	\$956.97	\$14,760.43	\$4,760.43
20	2.443%	\$0.3954608385	\$10,000.00	2,479.00	\$980.35	\$15,740.78	\$5,740.78
21	2.443%	\$0.4051219467	\$10,000.00	2,479.00	\$1,004.30	\$16,745.08	\$6,745.08
22	2.443%	\$0.4150190759	\$10,000.00	2,479.00	\$1,028.83	\$17,773.91	\$7,773.91
23	2.443%	\$0.4251579919	\$10,000.00	2,479.00	\$1,053.97	\$18,827.88	\$8,827.88
24	2.443%	\$0.4355446017	\$10,000.00	2,479.00	\$1,079.72	\$19,907.59	\$9,907.59
25	2.443%	\$0.4461849563	\$10,000.00	2,479.00	\$1,106.09	\$21,013.69	\$11,013.69

### G-6: 3% Inflationary Model Cost Analysis for 283 W Hydropower System

Year	Annual Growth	Cost/kWh	Lifetime Cost	Annual Output (kWh)	Annual Value of Output	Aggregate Value of Output	Profit
0	-	-	\$10,000.00	0	\$0.00	\$0.00	(\$10,000.00)
1	3.000%	\$0.2500000000	\$10,000.00	2,479.00	\$619.75	\$619.75	(\$9,380.25)
2	3.000%	\$0.2575000000	\$10,000.00	2,479.00	\$638.34	\$1,258.09	(\$8,741.91)
3	3.000%	\$0.2652250000	\$10,000.00	2,479.00	\$657.49	\$1,915.59	(\$8,084.41)
4	3.000%	\$0.2731817500	\$10,000.00	2,479.00	\$677.22	\$2,592.80	(\$7,407.20)
5	3.000%	\$0.2813772025	\$10,000.00	2,479.00	\$697.53	\$3,290.34	(\$6,709.66)
6	3.000%	\$0.2898185186	\$10,000.00	2,479.00	\$718.46	\$4,008.80	(\$5,991.20)
7	3.000%	\$0.2985130741	\$10,000.00	2,479.00	\$740.01	\$4,748.81	(\$5,251.19)
8	3.000%	\$0.3074684664	\$10,000.00	2,479.00	\$762.21	\$5,511.03	(\$4,488.97)
9	3.000%	\$0.3166925203	\$10,000.00	2,479.00	\$785.08	\$6,296.11	(\$3,703.89)
10	3.000%	\$0.3261932960	\$10,000.00	2,479.00	\$808.63	\$7,104.74	(\$2,895.26)
11	3.000%	\$0.3359790948	\$10,000.00	2,479.00	\$832.89	\$7,937.63	(\$2,062.37)
12	3.000%	\$0.3460584677	\$10,000.00	2,479.00	\$857.88	\$8,795.51	(\$1,204.49)
13	3.000%	\$0.3564402217	\$10,000.00	2,479.00	\$883.62	\$9,679.13	(\$320.87)
14	3.000%	\$0.3671334284	\$10,000.00	2,479.00	\$910.12	\$10,589.25	\$589.25
15	3.000%	\$0.3781474312	\$10,000.00	2,479.00	\$937.43	\$11,526.68	\$1,526.68
16	3.000%	\$0.3894918542	\$10,000.00	2,479.00	\$965.55	\$12,492.23	\$2,492.23
17	3.000%	\$0.4011766098	\$10,000.00	2,479.00	\$994.52	\$13,486.74	\$3,486.74
18	3.000%	\$0.4132119081	\$10,000.00	2,479.00	\$1,024.35	\$14,511.10	\$4,511.10
19	3.000%	\$0.4256082653	\$10,000.00	2,479.00	\$1,055.08	\$15,566.18	\$5,566.18
20	3.000%	\$0.4383765133	\$10,000.00	2,479.00	\$1,086.74	\$16,652.91	\$6,652.91
21	3.000%	\$0.4515278087	\$10,000.00	2,479.00	\$1,119.34	\$17,772.25	\$7,772.25
22	3.000%	\$0.4650736429	\$10,000.00	2,479.00	\$1,152.92	\$18,925.17	\$8,925.17
23	3.000%	\$0.4790258522	\$10,000.00	2,479.00	\$1,187.51	\$20,112.67	\$10,112.67
24	3.000%	\$0.4933966278	\$10,000.00	2,479.00	\$1,223.13	\$21,335.80	\$11,335.80
25	3.000%	\$0.5081985266	\$10,000.00	2,479.00	\$1,259.82	\$22,595.63	\$12,595.63

**G-7: Payback Period for Hydropower Systems under 0% Inflationary Model**

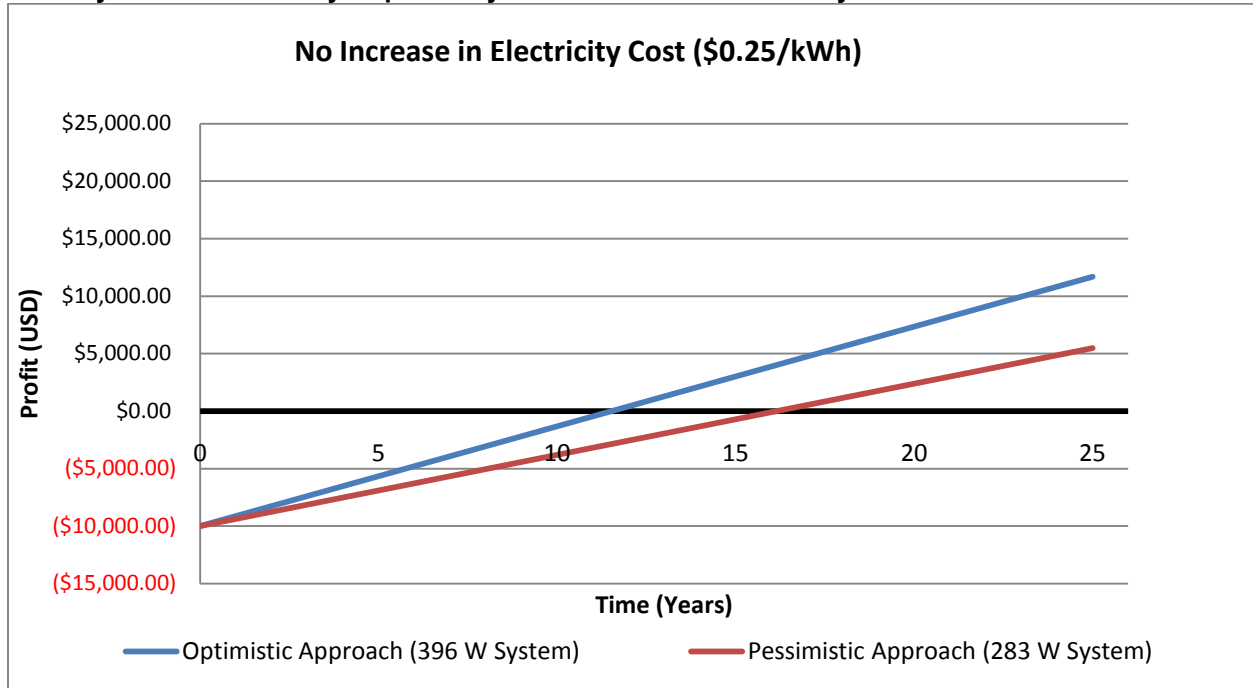

**G-8: Payback Period for Hydropower Systems under 2.443% Inflationary Model**

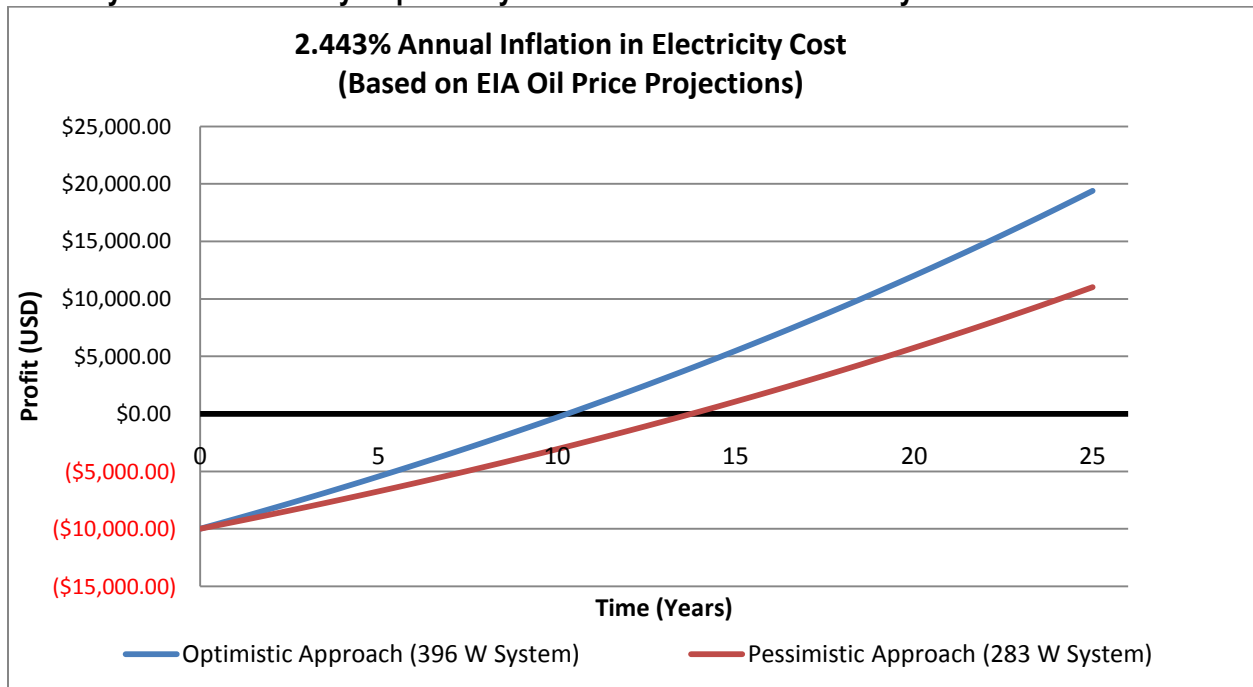

G-9: Payback Period for Hydropower Systems under 3% Inflationary Model

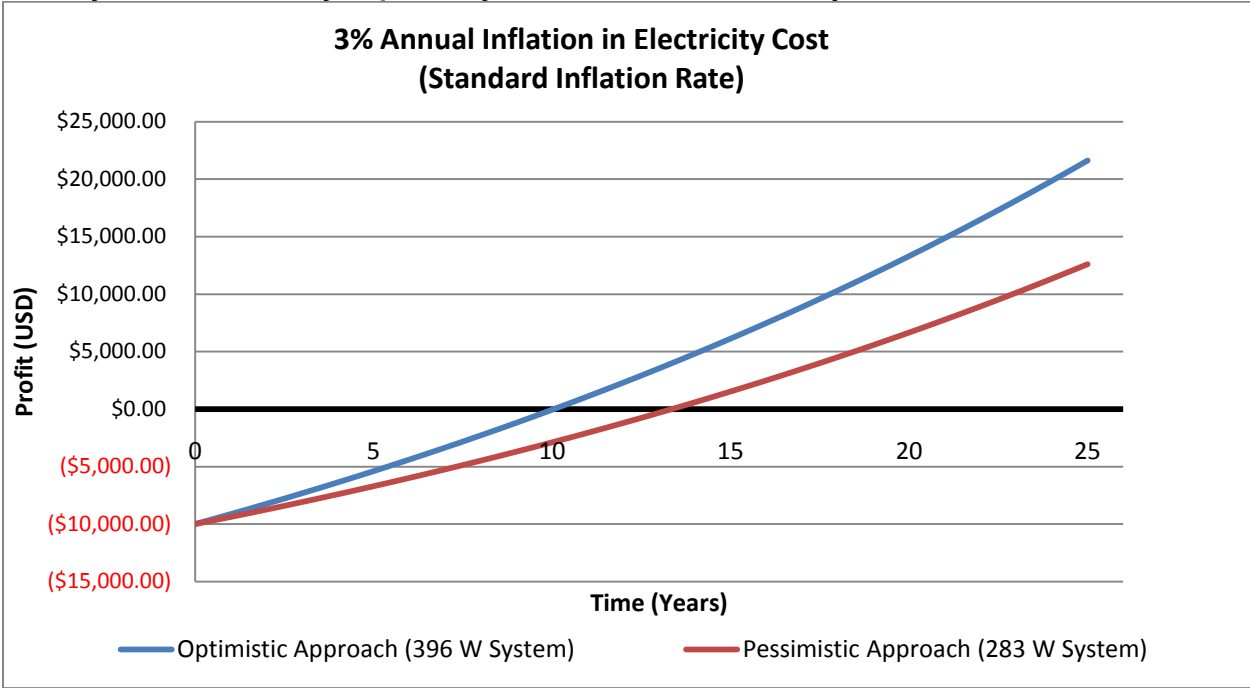



# APPENDIX H: Cost Analysis Tables and Graphs – Air Conditioning

## H-1: Total 25-year Costs for Different Efficiency Units at 2.443% Inflation Rate

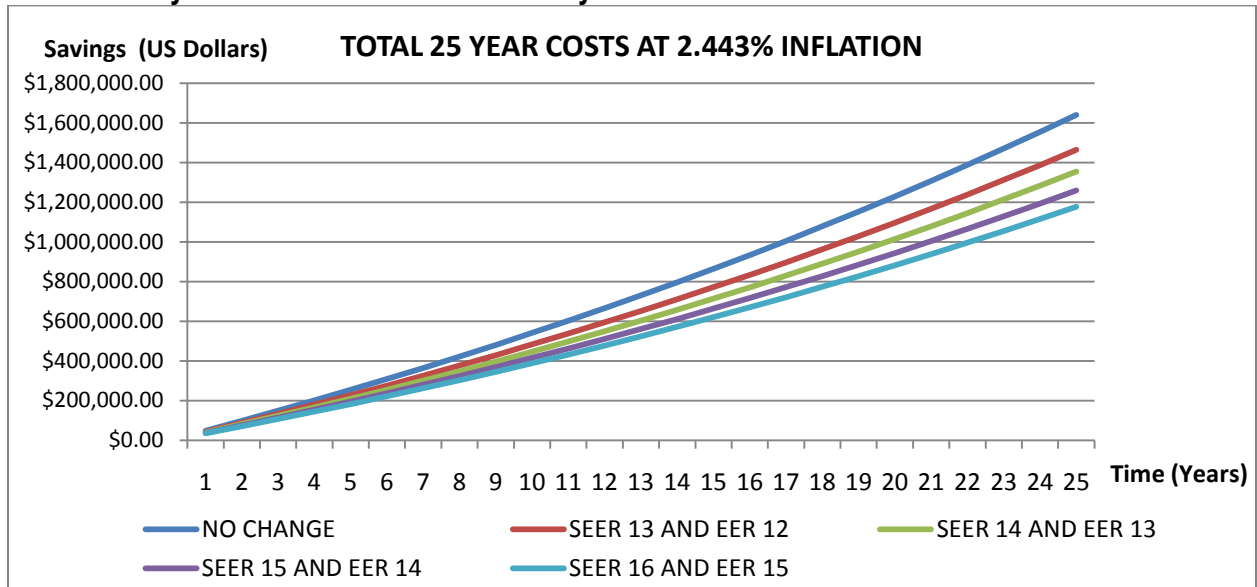

## H-2: Total 25-year Costs for Different Efficiency Units at 3% Inflation Rate

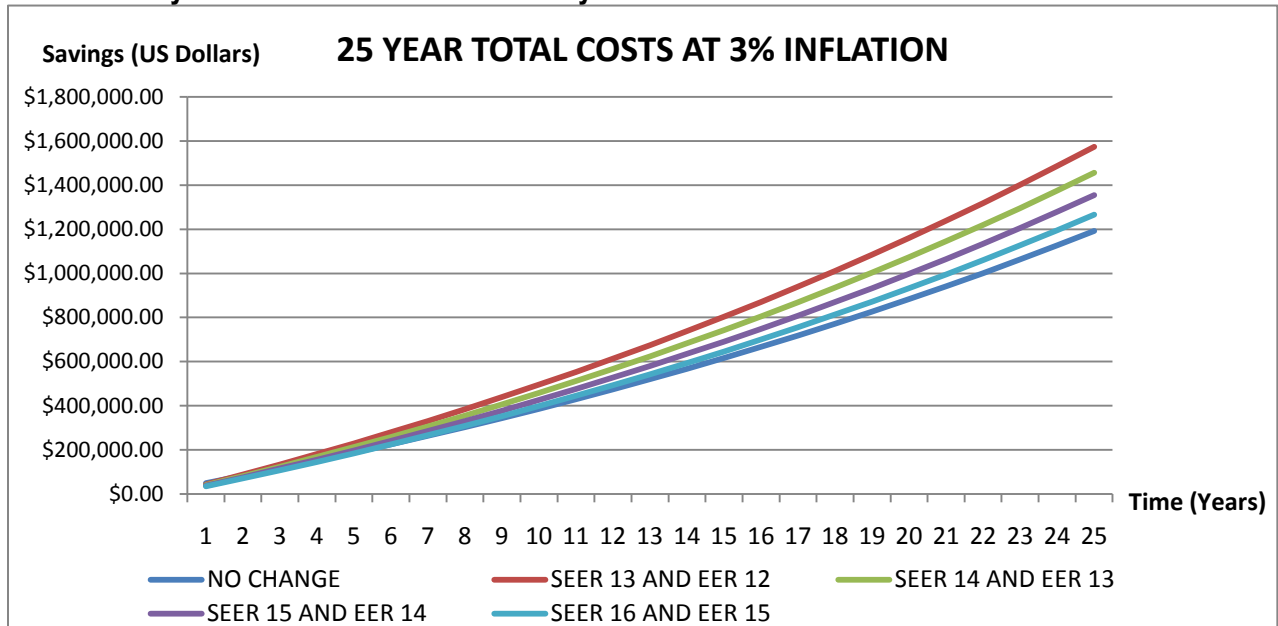

### H-3: Total 25-year Costs for Different Efficiency Units at 3% Inflation Rate

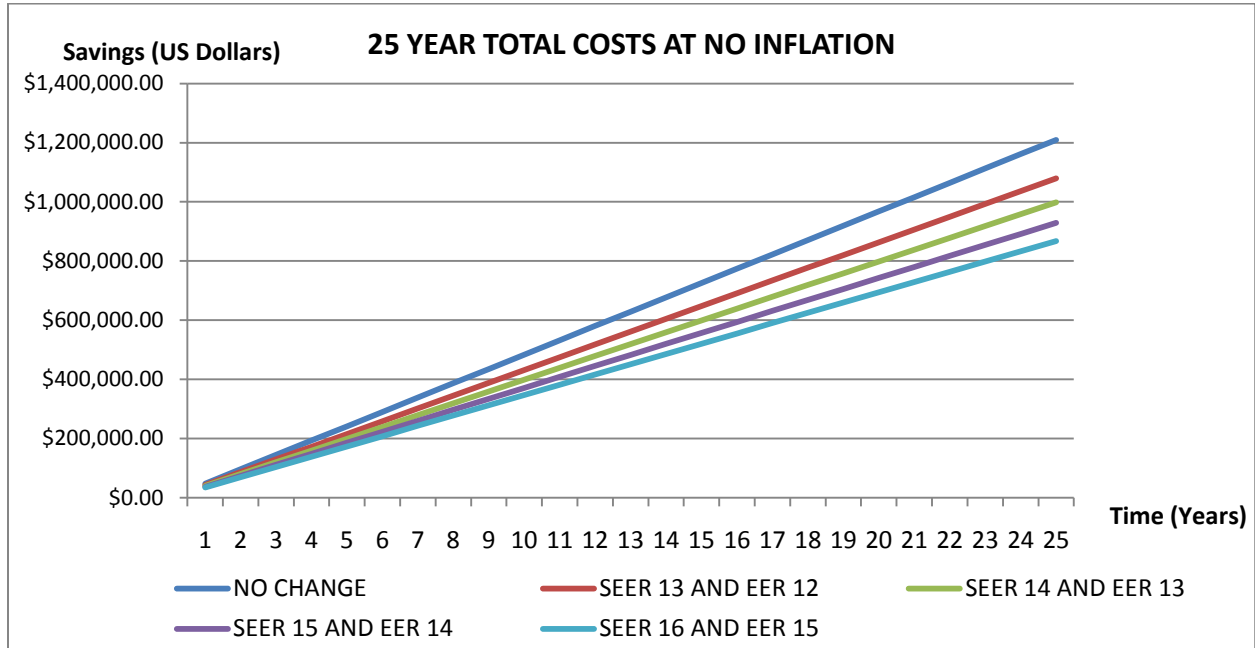

### H-4: Payback Periods for Varying Initial Investments and Varying Inflation Rates (In Years)

INITIAL INVESTMENT	SEER 13 AND EER 12			SEER 14 AND EER 13		
	NO INFLATION	2.443% INFLATION	3% INFLATION	NO INFLATION	2.443% INFLATION	3% INFLATION
\$15,000.00	2.88	2.82	2.80	1.78	1.76	1.75
\$20,000.00	3.84	3.72	3.69	2.37	2.33	2.32
\$25,000.00	4.8	4.60	4.55	2.96	2.89	2.88
\$30,000.00	5.77	5.46	5.39	3.55	3.44	3.42
\$40,000.00	7.69	7.13	7.02	4.74	4.53	4.49
\$50,000.00	9.61	8.26	8.57	5.92	5.59	5.53
\$60,000.00	11.53	10.26	10.05	7.10	6.63	6.53

INITIAL INVESTMENT	SEER 15 AND EER 14			SEER 16 AND EER 15		
	NO INFLATION	2.443% INFLATION	3% INFLATION	NO INFLATION	2.443% INFLATION	3% INFLATION
\$15,000.00	1.33	1.32	1.33	1.10	1.10	1.09
\$20,000.00	1.78	1.76	1.76	1.46	1.45	1.45
\$25,000.00	2.22	2.19	2.18	1.83	1.81	1.81
\$30,000.00	2.67	2.61	2.61	2.20	2.16	2.16
\$40,000.00	3.56	3.45	3.43	2.93	2.86	2.85
\$50,000.00	4.45	4.27	4.24	3.66	3.54	3.52
\$60,000.00	5.34	5.08	5.03	4.39	4.22	4.18

# APPENDIX I: Savings Analysis Graphs – Conservation Techniques

## I-1: Projected 25-year Savings for Drink Dedicated Refrigeration Under 0% Inflationary Mode

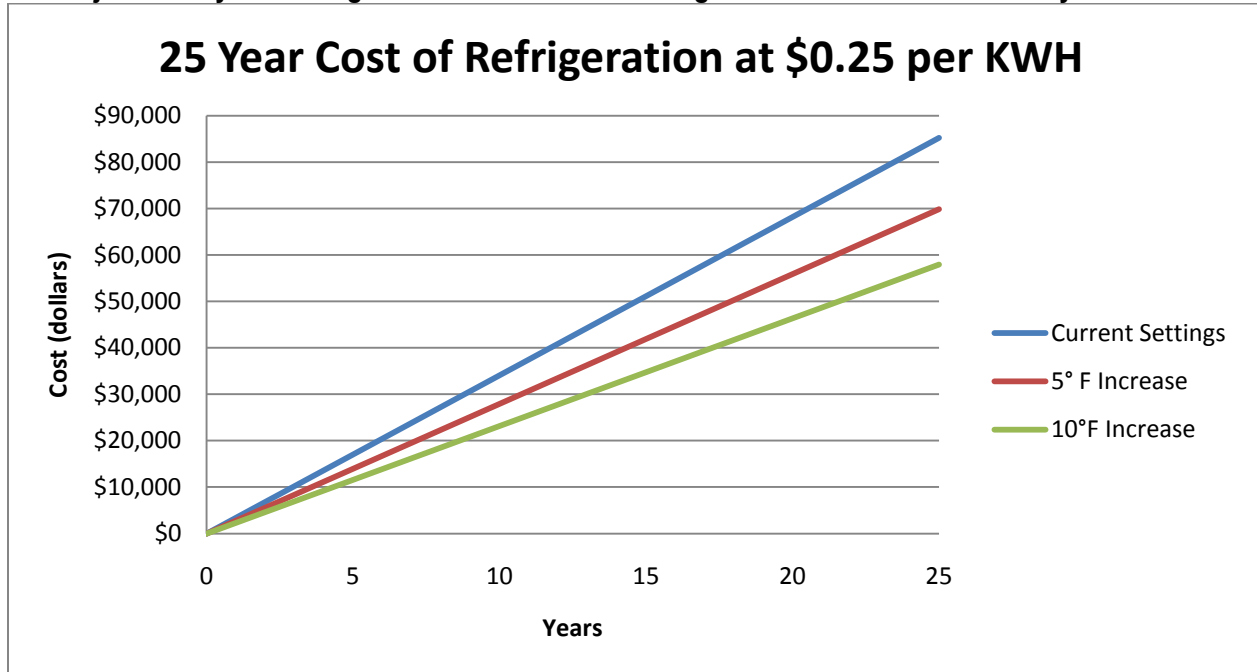

## I-2: Projected 25-year Savings for Drink Dedicated Refrigeration Under 2.443% Inflationary Model

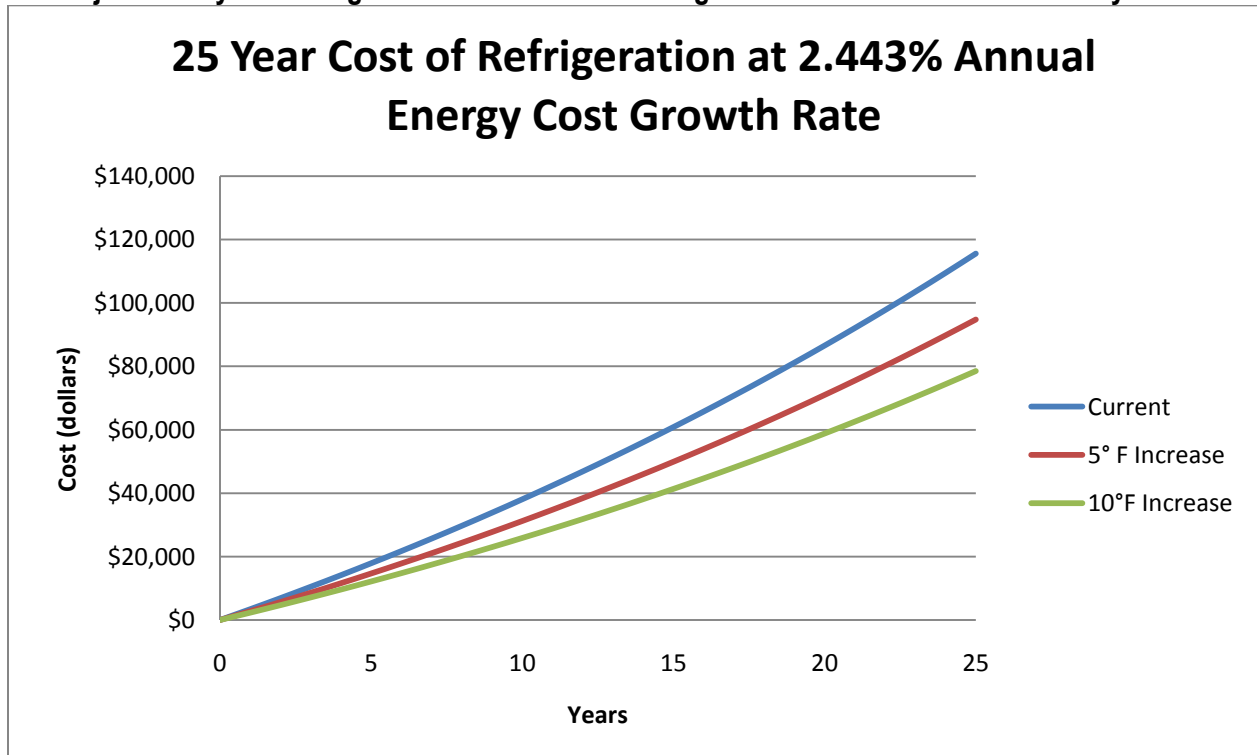

I-3: Projected 25-year Savings for Drink Dedicated Refrigeration Under 3% Inflationary Model

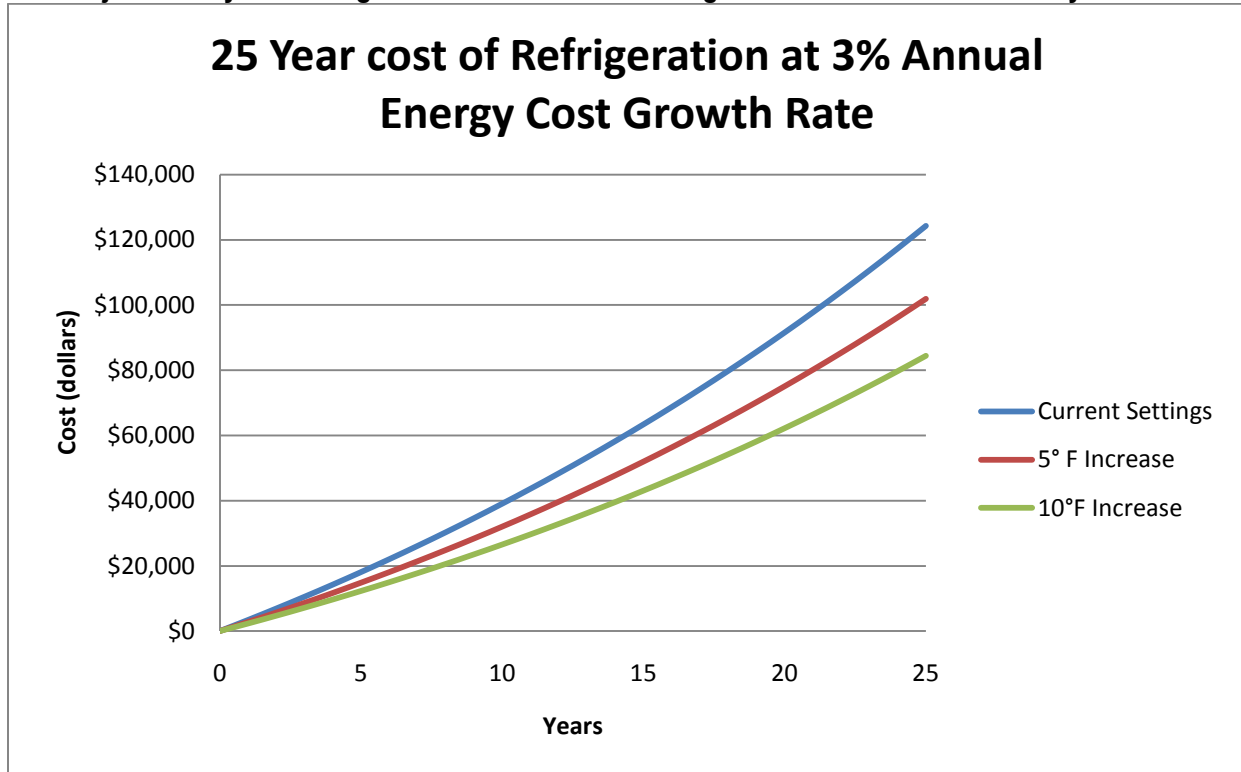

I-4: Projected 25-year Savings for Water Feature Pump Under 0% Inflationary Model

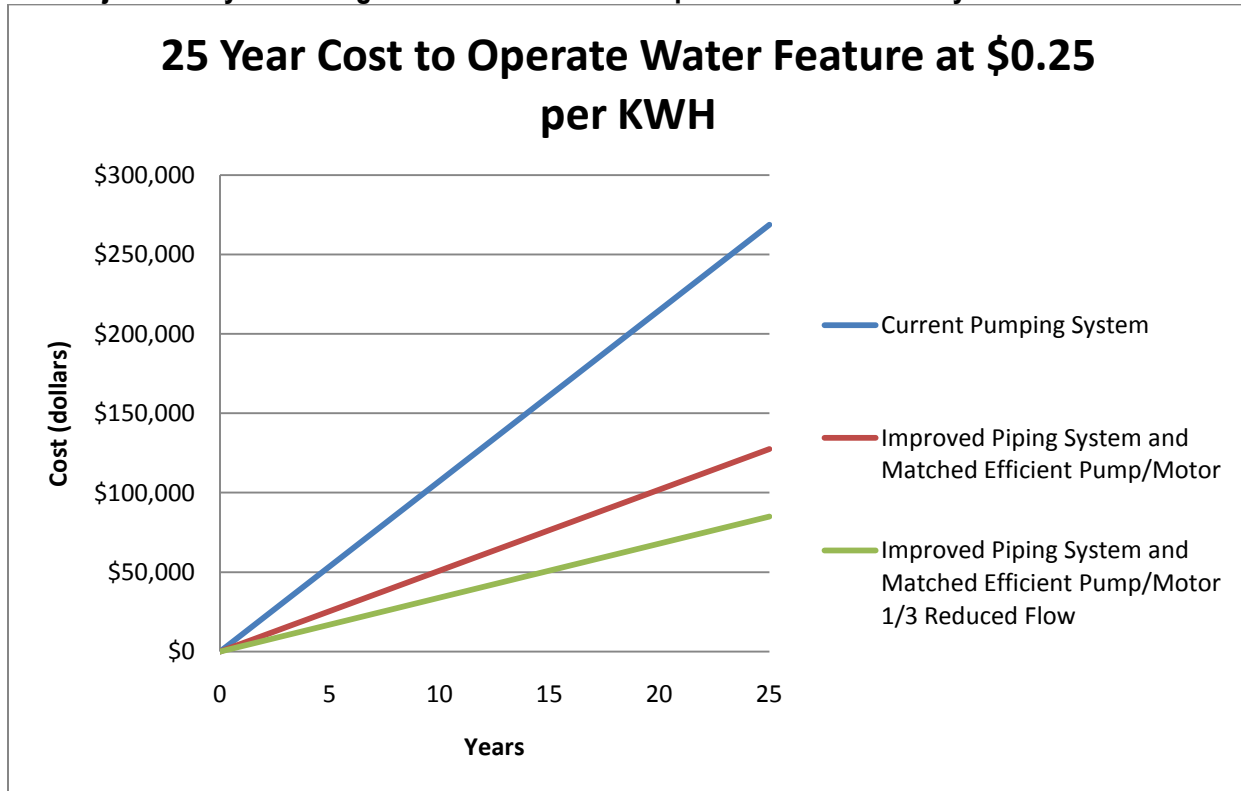

I-5: Projected 25-year Savings for Water Feature Pump Under 2.443% Inflationary Model

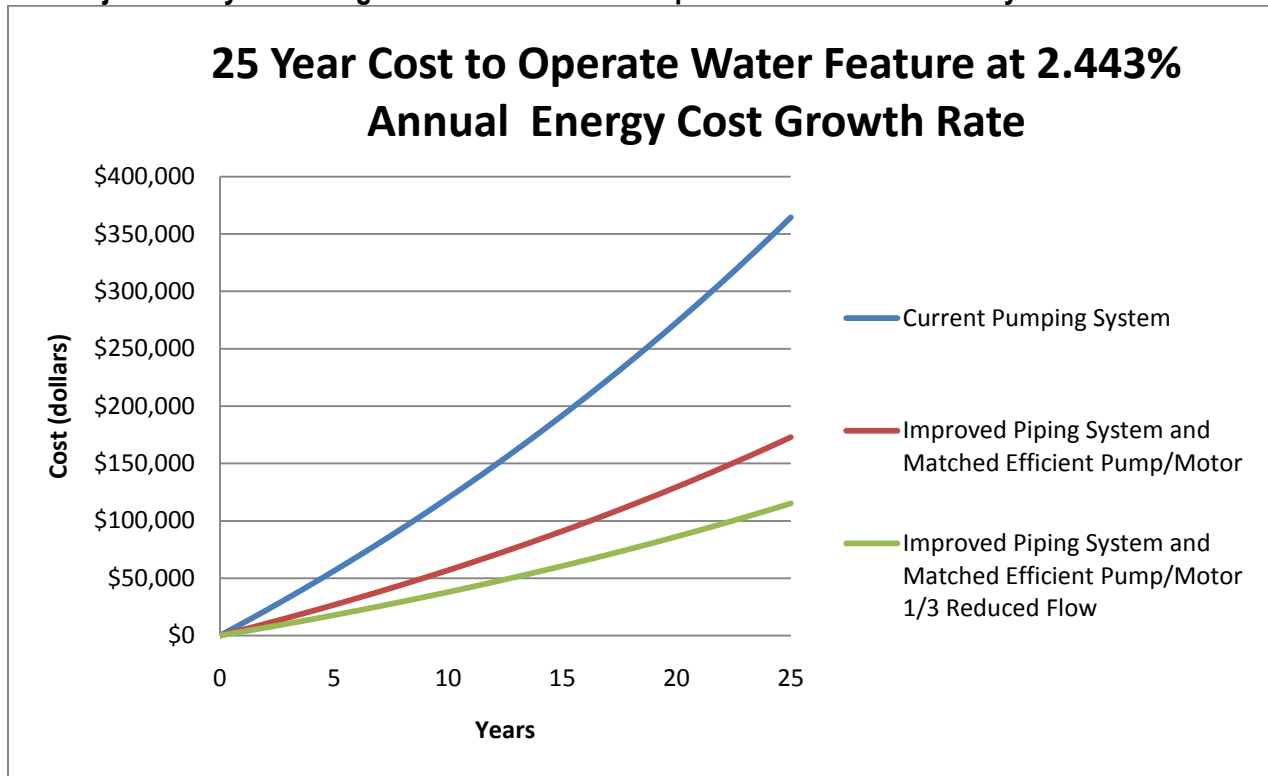

I-6: Projected 25-year Savings for Water Feature Pump Under 3% Inflationary Model

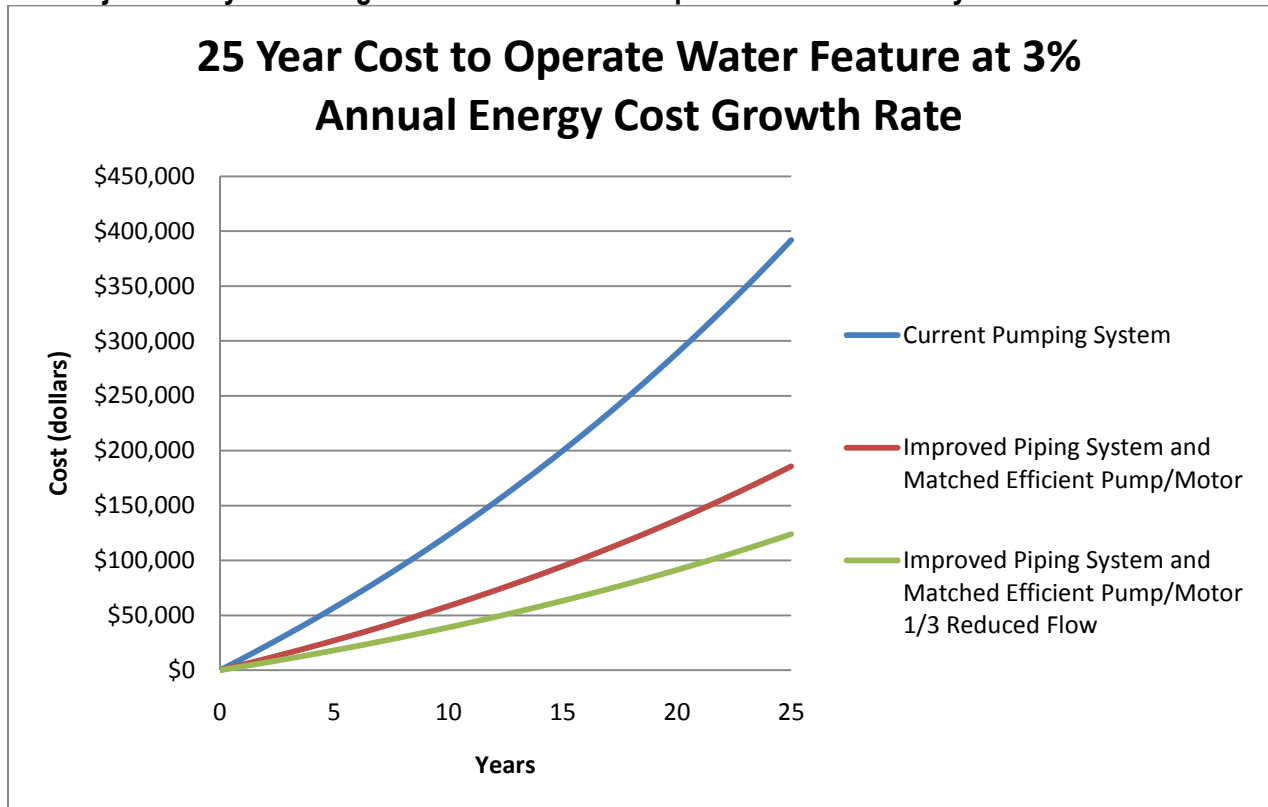

I-7: Projected 25-year Savings for Water Heater Under 0% Inflationary Model

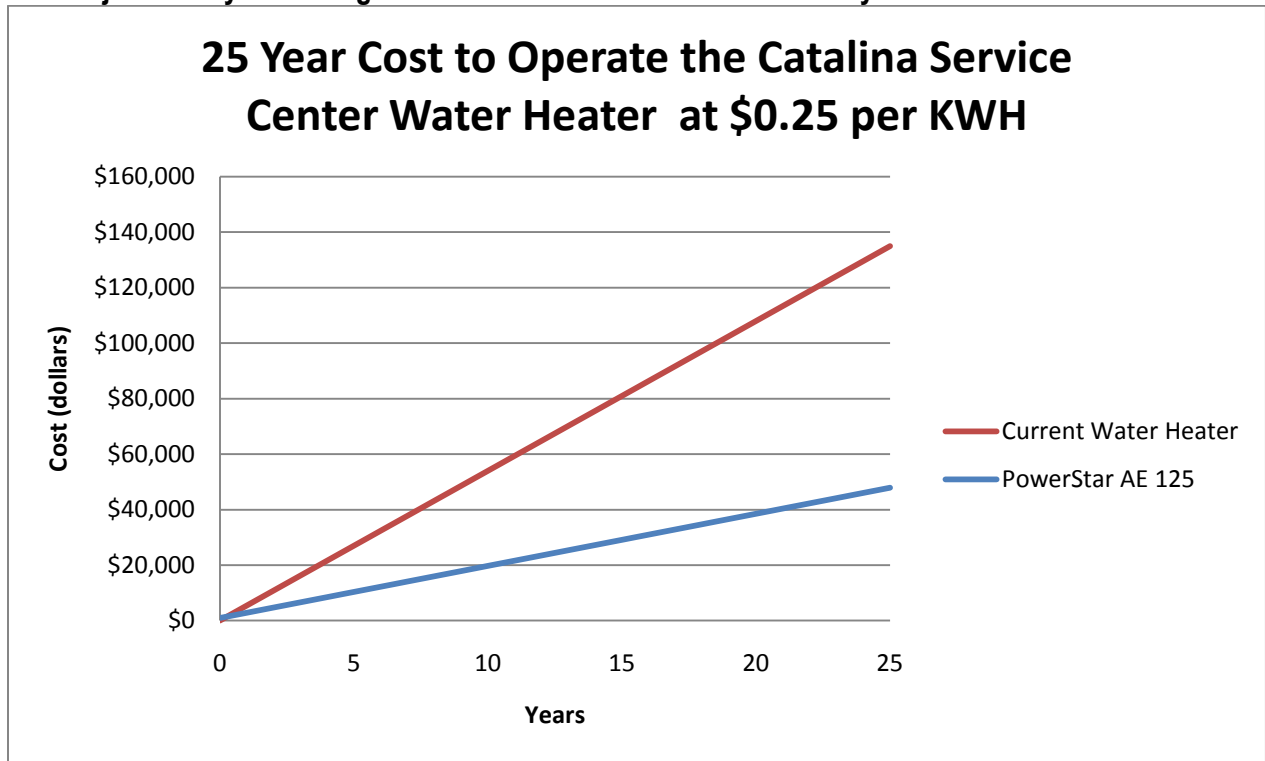

I-8: Projected 25-year Savings for Water Heater Under 2.443% Inflationary Model

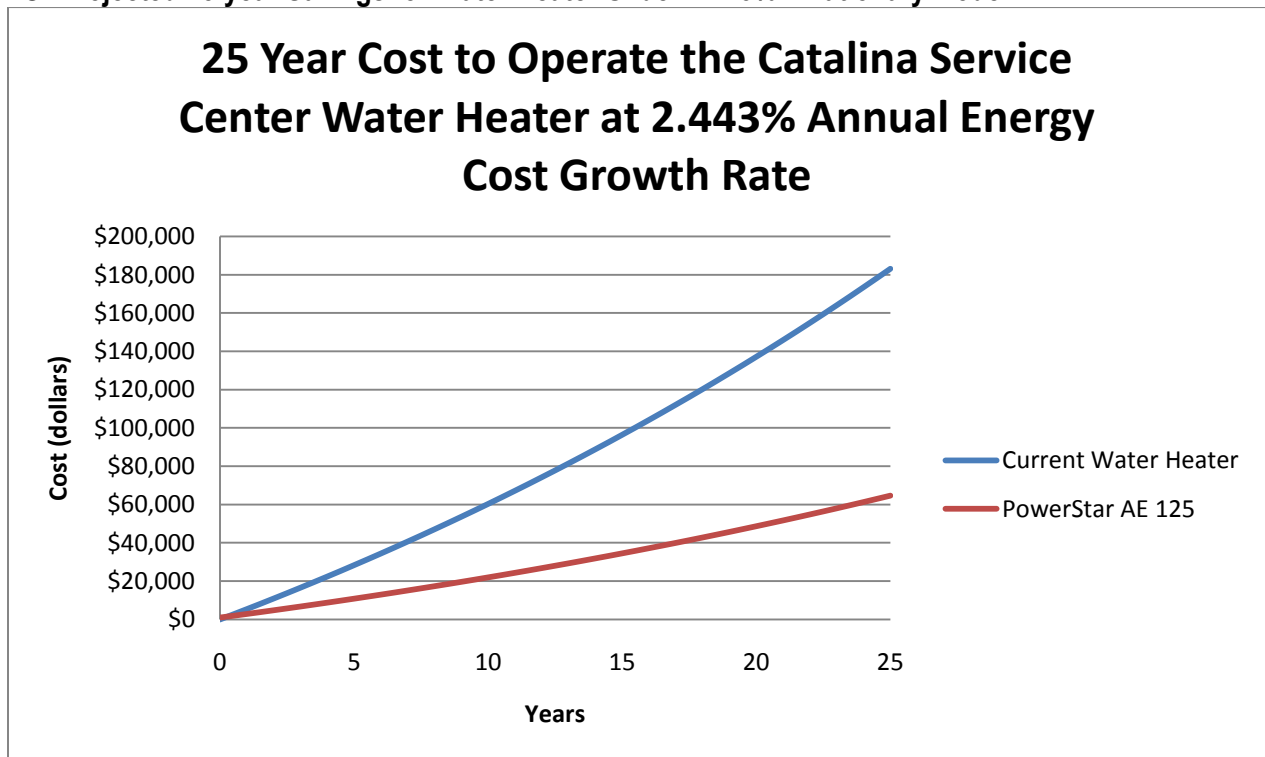

**I-9: Projected 25-year Savings for Water Heater Under 3% Inflationary Model**

