

Producing *The Crucible*

A Major Qualifying Project Report

Submitted to the Faculty

of the

WORCESTER POLYTECHNIC INSTITUTE

in partial fulfillment of the requirements for the

Degree of Bachelor of Science

in Humanities & Arts

concentrated in Drama/Theatre

By:

Richard Thomas Joseph Desilets, Jr.

Date: February 22, 2010

Professor Susan Vick, Advisor

Abstract

As producer of Arthur Miller's *The Crucible*, it was my responsibility to oversee all aspects of the show. As an active participant in theatre and live performance, I had the knowledge necessary to do my part in creating this stage experience. This portfolio follows the process I took in preparing and producing this show.

Executive Summary

Producing *The Crucible* was the labor of two months, utilizing the help of over one hundred members of the WPI community. After being asked to produce and accepting, it was up to me to assemble a complete production staff who were capable of completing the tasks ahead of them. After I assembled the crew, we met to discuss how the production would come together, and for the next few weeks, the various crews worked independently and interdependently to set the building blocks for this wonderful performance.

When fall break was over, it was time to put the pieces together. The set began getting constructed as the lighting plot came together. Fluorescent paint was being tested and re-tested for the strongest effect while the costumes were organized to best offset the paint itself. The poster was designed early to make way for advertising while publicity planned out new ways to reach out to the community. As the show began to come together, it began to form a real picture in all our heads.

When opening night finally arrived, it was like watching clockwork, every aspect moving in sync with the rest to create something beautiful. Over four hundred people came out to see *The Crucible*, selling out the Little Theatre every night. The Little Theatre Conservatory Studio provided us with the means and manner necessary to make this show a reality, and the final product was a masterpiece.

Table of Contents

Abstract	- 2 -
Executive Summary	- 2 -
Table of Contents	- 3 -
Getting Ready	- 4 -
Pre-planning	- 4 -
Scenic Design	- 4 -
Sound Design	- 5 -
Selecting a Crew.....	- 5 -
Meeting Up.....	- 6 -
Getting Started	- 7 -
Set Construction	- 7 -
Costuming	- 7 -
Posters	- 7 -
Getting It Together	- 9 -
Painting.....	- 9 -
Lighting.....	- 9 -
Props.....	- 10 -
Program Design.....	- 11 -
Last-Minute Hiccups	- 12 -
Getting On with the Show	- 13 -
Appendices	- 14 -
Appendix A – Crew List	- 14 -
Appendix B – Cast List	- 15 -
Appendix C – Production Calendar	- 16 -
Appendix D – Meeting Minutes.....	- 17 -
Appendix E – Scenic Design Progression.....	- 25 -
Appendix F – Lighting Design.....	- 28 -
Appendix G – Poster Designs	- 29 -
Appendix H – Program	- 30 -
Appendix I – Photos.....	- 35 -
Appendix J – Play List	- 42 -
Appendix K – Work Log.....	- 46 -
Appendix L – Resume.....	- 50 -

Getting Ready

Pre-planning

When I was first selected as producer for Arthur Miller's *The Crucible*, there were already plans in motion that I was able to assist with, the most important of which was the addition of a stage manager – Cody Shultz. The remainder of the production staff I personally hand-picked for their respective roles. Meanwhile, during the weeks leading up to the fall break, I was being prepared to take on the responsibilities of producer. Before this point, I had only co-produced a one-act festival two summers before, and a comedy festival just prior to that. I had never produced a show on my own before, nor had I produced anything of this specific importance or magnitude. Over the seven weeks that followed, I learned what it takes to be a stage producer and how to make spectacle come alive on the stage.

Scenic Design

One of the largest responsibilities of the producer is to manage and maintain a budget. Every aspect of a theatrical production needs to be accounted for, and the large number of monetary demands by the various facets of a production requires that they be weighed carefully before any decision is made. Thankfully, funding from the Humanities and Arts department was made available for this production, thus overspending was less of a concern than it would normally be.

The most costly portion of a production generally falls under the category of set construction. Before I was selected to produce *The Crucible*, David Stechmann and Professor Vick had already been collaborating on a scenic design. The set continued to transform over the course of A Term, and even into the early stages of construction and production, but the concept and overall structure of the scenic design remained the same throughout.

The basis for the scenic design was two-fold: the platforms were to have no right angles, to pull away from what is considered traditional set construction and to give the set an eerie quality designed to match that of the play itself, and the set was to be extremely basic and abstract, allowing the lights and sounds to be the prominent detail rather than specific set pieces.

The main set consisted of three expansive platforms stacked atop each other, decreasing in size, giving the stage a stair-like effect. On the top platform were flats that would conceal actors backstage, as well as give them as many as five different entrances from the north side of the room.

Separate from the main set was an unusual piece never created in the Little Theatre before. Above the southwest stairwell was a bed for Betty Parris to lie on in the opening scene. Instead of using a solid platform, it was built in a manner similar to jail cell bars. The reason for this was to incorporate this section again in the final scene as an actual jail cell for Sarah Good and Tituba, complete with a removable cell door.

Finally, the only variable element of the scenic design was four painted benches, which swapped in and out for various scenes. The manner in which the set was painted and

incorporated into the artistic design of the show is highlighted in the Ultraviolet Paint section of this paper.

The progression of the scenic design can be seen in Appendix E.

Sound Design

Before I became involved in the production of *The Crucible*, director Steven Vessella had already come up with new and unusual plans for how to integrate the sound design directly into the show, an idea he dubbed the "soundtrack." This soundtrack would incorporate the themes present in the show to provide incidental music as a backdrop to the performance, rather than the traditional use of music as transition material. The end result was a musical experience unheard of in the Little Theatre.

This experiment, however, required that the soundtrack be fine-tuned over the course of the show's production, in order to both give actors time to get acclimated to the music's addition as well as give the soundboard operator time to adjust to the pacing of the show. Both the scenic design and sound design were already shaping up to be complex creatures in need of the best crew I could assemble.

Selecting a Crew

The benefit of producing a B Term show is that it is the only show being put on, excepting Alpha Psi Omega's *Show in 24 Hours*. This meant that I had the entire range and depth of active theatre participants to choose from in order to bring my staff together.

For sound designer, I immediately went to Ben LaVerriere, a skilled electrician and sound engineer. Ben accepted and became the first member of my budding production staff. For master carpenter, the original plan was to have Kosta Filiotis, a conservatory student, as the master carpenter with appropriate assistance and mentoring. Eventually, Kosta decided to audition, and the position of master carpenter was offered to and accepted by RJ LaMura, who was originally intended to be Kosta's assistant. Tristan Spoor approached me about wanting to be the lighting designer, which I quickly took him up on. His experience with unusual lighting setups (particularly those involving color blasts) would prove to be invaluable to the visual dynamic of *The Crucible*. Jake Lee Brown, another conservatory student, was soon added as the master electrician. I approached Elena Ainley, offering her the positions of costume designer and poster designer, both roles in which she has excelled in a very short amount of time. Adriana Betancourt, another conservatory student, was chosen to head up publicity for the show.

After beginning to see my production staff come together, it became obvious to me that some additional help on my end would be necessary. Thus, I tapped Andrew Wilkins to assist me, both as assistant producer and as technical director, allowing him to oversee the more technically and technologically complex elements of the production. Additionally, I added Carol Wood to my staff as art director, to be in charge of creating the physical symbols for use in the show and publicity materials, as well as overseeing the set painting. The members of the

production staff were instructed to assemble teams on their own to assist them in completing their respective tasks.

For a complete crew list, see Appendix A.

Meeting Up

With a sizeable number of crew positions occupied, and the rest of the gaps being quickly filled, it was time to meet with the staff to get everyone on the same page before fall break. The primary goal of this first meeting was to get everyone acquainted, as well as get the production team accustomed to the more unusual elements of the play. Finally, I asked the various crew members to get me estimated budgets by the end of break. People began meeting with each other to discuss how to make everything work, and by the time we got back from fall break, we hit the ground running. Over the course of B Term, we met on a weekly basis to touch base and discuss what was left to do.

For an archive of the production meeting minutes sent out by Andrew Wilkins, see Appendix D.

Getting Started

Set Construction

While the actors were getting accustomed to the script, the set went through numerous stages of build. Initially, chalk lines were used on the floor to denote approximately where the stage and its various levels would be. This helped give Steven and the cast an idea of where entrances and exits could take place, as well as giving Tristan a basis for his lighting plot.

A hollow stage was quickly erected, and the actors were allowed to rehearse upon it, carefully. The stage was not sealed on any side yet so that it could be filled with a large solid foam. The foam would help substantially dampen the sound of footsteps during the show, and would keep the actors from needing to worry about stepping softly.

Once the foam had been added, the sides were closed up, and the focus turned to the more unusual element of the show: the “jail bed.” Made using metal bars, the jail was welded together and affixed to both the wall under the booth and the half-wall blocking the stairwell.

One element that shifted during the production was a set of Mylar images. These pieces would use the Mylar to reflect light in the form of two crosses and two steeples. Eventually the steeples were dropped when they were deemed unrecognizable in shape. The crosses themselves underwent changes, as the Mylar wound up being far too reflective. After trying several material combinations, the crosses were again covered in Mylar and sprayed, in order to reduce the intense reflectivity of its surface.

Costuming

Now that the actors had begun rehearsing and getting into their roles, it was time to get them costumed. Because the set was to be abstract and simple, it was decided that the costumes should be simple in kind. Every actor’s costume was to be entirely black and white, both to match the symbolism of the black-and-white justice system during the Salem Witch Trials and to make the instances of colored ultraviolet paint that much more impressive. One thing that was interesting to note as the show progressed and the costumes evolved was that many of the show’s antagonists wore elements of white in their costumes, while the protagonists wore all black. This agreed with the idea that the antagonists believed that what they were doing was right and just, and that the protagonists – particularly John Proctor – was willing to look the villain in order to do good.

The theme for the costumes’ design was inspired by *Mad Men*, in that the men would be wearing varying combinations of suits, vests, coats, and ties, while the girls and women would wear dresses ranging from simple and neat to something a bit more revealing.

Posters

With Elena as both our costume designer and poster designer, we had the opportunity to really mesh the two ideas together. Originally, both the costumes and the poster were going to involve the symbols painted into the scenery. Over time, however, it was determined that the poster should align with the costumes’ sense of minimalism.

The first poster was built on the themes of fear and vengeance, but was later replaced with the final “white shadow” design when it was realized that much of the symbolism on the poster could be misconstrued as racist or Nazi at first glance. We felt the new poster design was appropriate as in its simplicity it was highly interpretable, ranging from the role reversal of good and evil – similar to how the antagonists were dressed in white and the protagonists in black – to the analog of John Proctor to Jesus as one person willing to stand against fear, religious fervor, and mob mentality. This final poster tested substantially better with the production staff, and was kept.

For the two poster designs by Elena Ainley, see Appendix G.

Getting It Together

Painting

One of the most unique elements of this production was the use of fluorescent paint on the set. Invisible under normal light, the paint would glow a brilliant red, yellow, or blue under ultraviolet light based on the pigment used. This would provide us with the ability to bring some truly chilling effects to the Little Theatre. It additionally allowed us to show the imagery that the girls were inventing to scare the villagers and escape persecution. The paint was used on the flats at the top of the stage, in a fire-like pattern. This section was the most often used portion of the painted stage. The floor and platforms both were spattered in all three colors of fluorescent paint and had large symbols painted on them to have ultraviolet lights focused on, particularly the “yellow bird” Abigail Williams claims to see in the courtroom scene. Finally, the benches themselves were painted in several layers in such a way that it would look like the strange light was trying to literally burst out and envelop the room.

The first instance of fluorescent paint in the show’s presentation was in the opening scene in which Abigail Williams, Tituba, Mary Warren, and the other girls danced around a cauldron in the forest. As the girls danced around, the symbols on the stage and flats would flash on and off. When Reverend Parris discovered the girls dancing, the ultraviolet lights were turned off for most of the remainder of the act. The effect was turned on again when Mary Warren informed Elizabeth Proctor that she saved her life by defending her against accusations of witchcraft. When Mary Warren cried out “I saved her life today!”, the lights activated the paint quickly and faded away, visually mimicking a single heartbeat. This helped bring the audience into the scope and reality of how far the Salem Witch Trials had come, that they were now accusing villagers likely innocent of crime in their entire lives.

In the second act, the paint was used when Abigail Williams begins to cry out that she sees Mary Warren taking different forms and attacking her. As the girls ran screaming through the courtroom, the audience experienced the scene with no light other than the ultraviolet light reflected off the fluorescent paint. The result was an outright eerie, black scene with color seeming to bleed out of the floor, walls, and benches. Finally, at the end of the play, when John Proctor was being led off to be hanged, the lights activated the paint on the flats, symbolizing that, at least for now, the lies had won over the truth.

The incorporation of the fluorescent paint into the production was a very new technique in the Little Theatre, and it was by far the most well-received technical aspect of the play.

For examples of the fluorescent paint in use, see Appendix I.

Lighting

The lighting for this production was going to be a very delicate process, as the show needed to maintain a subdued tone for much of the performance, while being able to snap into the bizarre and frightening at a moment’s notice. As described in the previous section, the

element most crucial to this balance was the inclusion of ultraviolet lights among the rest of the lighting plot. Four lights were used to accent the paint: two were pointed at individual symbols painted onto the stage, and two were pointed at the flats in the back of the stage. Many tests were run with the lights and paint to see what the optimal balance would be.

But the ultraviolet lights weren't the only unusual piece in the lighting. Color blasts were also used, to bring out the intensity of the normal paint when the fluorescent paint was not being activated. One chilling scene in particular was when Abigail Williams threatens the other girls by describing how she witnessed her parents' murder at the hands of the Indians. Several red lights and colorblasts were activated, leaving the entire stage soaked in a blood-red glow. When John Proctor arrived, it all returned to normal lighting in a flash, as if Abigail had turned and hidden the light behind her back as he entered.

Additionally, over the course of the final scene the color blasts were programmed to change color to simulate a sunrise, moving from a deep blue to a lighter blue, finally to a bright orange as John Proctor is carried off to be hanged.

The usual set of lights had their own unique effects as well. Using the barred frame of the bed atop the staircase, red light was shone through as Betty Parris screamed about her mother. The combination of lights, color blasts, and ultraviolet lights made this production a visual spectacle in and of itself.

For the lighting plot used, see Appendix F.

Props

While the list of props was extremely short, the specific props utilized in this production were vital to the progression of the play. A suitable whip was found for the second scene, in which John Proctor threatens to whip Mary Warren for her disobedience. The inclusion of this prop required that a hook be manufactured on the northeast pillar.

Also important to the second scene was Mary Warren's poppet. As she enters the scene, she brings the poppet to Elizabeth Proctor and gives it to her. Later in the scene, Ezekiel Cheever discovers the poppet and finds that a needle has been buried into it, thus confirming the court's suspicion that Elizabeth may be associated with witchcraft.

Shackles were included, both in the arrest of Elizabeth Proctor, and in bringing John Proctor to see her at the end of the play. Additionally, when Elizabeth is being arrested, once she was offstage the shackles were banged against wood and other chains to have the sound of rustling chains ring out into the theatre.

Other minor props were used in the play, including Reverend Hale's books, Ezekiel Cheever's box of papers, and the cauldron used in the opening scene. The limited use of props was intentional in order to maintain the minimalistic nature of the production and to stress the importance of the few that were used.

Program Design

Because I had already been keeping tabs on the staff and crew lists, I decided to take on designing the program myself. Using the final poster design as inspiration, and incorporating the poster's fonts into the program as well, I began work. The front page was a color-inverted image of the poster, once it was finalized. Inside the front cover was a set of short bios for myself, Steven, and Stechmann. Following these came the cast list and two pages of production crew and crew lists.

It is generally a toss-up whether the cast bios included in the program are intended to be serious or satirical. We wanted to give the cast something interesting to do in getting involved in the program, so we came up with an unusual type of cast bio that would relate to the show's theme. Rather than do a normal bio, the cast was asked to write their own fictional obituary, as if they had been accused, tried, and found guilty of witchcraft, to be hanged on opening night – November 19, 2009. This idea was well-received by the cast and audience.

I had noticed, in creating the program, that there was an extra page near the middle that needed to be filled. In talking with Professor Vassallo, our dramaturg, we decided it would be a good idea to include the list of victims in the Salem Witch Trials. I added the list of twenty-three victims, as well as how and when they died.

Following this, we had a list of special thanks, much of which consisted of various institutions and groups within Worcester Polytechnic Institute, particularly within the Humanities and Arts department.

Because this was a B Term show, this meant that our Friday show would be followed by Alpha Psi Omega inductions. During this induction period Elena Ainley, Anika Blodgett, Megan Faulkner, Richard "RJ" LaMura, Ben LaVerriere, and Tristan Spoor would be inducted. Their names were included in the program on their own page, honoring them for their achievements in theatre. Four of the six inductees were members of my production staff, and the remaining two were actors. Megan, who fell extremely ill two days before opening night, was able to return briefly for her induction.

Finally, the back cover listed the upcoming shows and events, including Alpha Psi Omega *Show in 24 Hours*, three Student Comedy Productions shows, both C Term 2010 theatre shows, and both the script submission deadline and show dates for *New Voices 28*.

One element that was new for WPI Theatre programs was the inclusion of quotes from various important members of the production. On the bottom of most pages were a quote from Steven Vessella, myself, Cody Shultz, Professor Vassallo, Professor Vick, or Andrew Wilkins. The content of these quotes ranged from commentary about working on the show, the effect of the show itself, or thoughts on individuals mentioned on the page itself.

There were two inserts in the program as well. The first, a four-page insert, featured both a letter from the director to the audience, welcoming them to the Little Theatre and describing the process of putting the show together, and a letter from Professor Vick to the audience, detailing the Little Theatre Conservatory Studio and how it has helped influence the theatre community at WPI. The second insert was a simple corrections sheet. On this sheet were a

mention of the re-casting of the role of Rebecca Nurse to Elizabeth Ruffa, missing credits for set crew, and a reminder of no food or drink in the Little Theatre.

The program design was praised for its consistency and completeness, as well as incorporating new elements into it.

For the final program design, see Appendix H.

Last-Minute Hiccups

Tech week wasn't without its own brand of problems. Due to some confusion, the stage manager did not have the lighting or sound cues going into the cue-to-cue. As a result, many of the early cues were double-called, or erroneously placed. After fixing this issue and coming back to begin half an hour later, the cue-to-cue went off substantially better.

One issue we had been having for weeks was the unreliability of Adeola Otuyelu, the actor playing Tituba. Nearly always arriving at rehearsals extremely late, or sometimes not at all, she had become a constant source of concern for us. We decided, as a precaution, to cast Chris Sanchez as the stand-in for Tituba. His role would eventually expand to stand-in for the entire cast. While we never found ourselves requiring his services, his dedication to being there in case anything went wrong was very helpful.

The biggest issue going into the shows was the sudden severe illness of Megan Faulkner, who was cast as Rebecca Nurse, two days before opening night. While the role was not particularly large, its inclusion was vital to the plot. Thus, Steven went to Professor Vick's class and held an emergency audition, where he cast Elizabeth Ruffa in her place. After two nail-biting rehearsals (the latter of which was actually a preview), she had learned her lines perfectly, and we were back on track.

Unfortunately, when preparing a show, one sometimes encounters resistance from without. A photographer from *The Towers* had arrived to take photos of the show for a review in their paper. Despite repeated requests to leave, he managed to take one picture that was eventually used in what was less of a review and more of an encyclopedic mention of what the play was about. Additionally, when organizing the live feed and cameras, there was an altercation between members of the group manning the cameras and Professor Vick. When the issue went unresolved, those chosen to man the cameras were asked to leave, and were replaced.

Despite a number of issues that could have, even a little bit worse, ground the production to a halt, we pressed on to make it to opening night, and the show finally opened, to a sold-out audience and a packed live feed area in Riley Commons.

Getting On with the Show

The Crucible was finally performed November 19-21, 2009 in the Little Theatre, to amazing results. The theatre itself was sold out every night, and the live feed was heavily-attended by the crowd overflow on all three nights. While there were some problems that arose in the show – the jail cell door falling on the stage opening night and an injury mid-blackout just prior to the show’s start, for example – the shows were met with high praise. Strike was amazingly quick, all of the project students got their hours in, and the show was finally over. Sixty-five days after I was asked to be the producer for *The Crucible*, I had learned more than I thought possible about what it takes to produce a stageplay. It was sad to see it end, but seeing your work being shown to hundreds of people is a truly rare gift I was proud to receive.

Appendices

Appendix A – Crew List

Executive Producer	Rick Desilets
Director	Steven Vessella
Dramaturg	Helen Vassallo
Little Theatre Liaison	Matt Houstle
Stage Manager	Cody Shultz
Assistant Producer	Andrew Wilkins
Assistant Stage Manager, Production	Caleb Ruvich
Assistant Stage Manager, Script Supervision	Peter Worrest
Scenic Designers	David Stechmann, Susan Vick
Technical Director	Andrew Wilkins
Assistant Technical Director	Sam Moniz
Art Director	Carol Wood
Master Carpenter	RJ LaMura
Assistant Master Carpenter	Patrick Crowe
Lighting Designer	Tristan Spoor
Master Electrician	Jake Lee Brown
Lightboard Operator	Shuchi Mitra
Sound Designer	Ben LaVerriere
Soundboard Operator	Lincoln Barber
Property Master	Dan Pappas
Assistant Property Master	Adam Thibault
Costume Designer	Elena Ainley
Publicity	Adriana Martinez-Betancourt
Poster Designer	Elena Ainley
Program Designer	Rick Desilets
Scenic Photographer	Dan Valencourt
Headshot Photographer	Haz Harrower
House Manager	Emily "Lindy" Bowen
Strike Manager	Matt Houstle
Mentor to Producer	Patrick Crowe
Mentor to Stage Manager	Corey Randall
Mentor to Master Carpenter	Chris Pardy
Mentor to Master Electrician	Matt Houstle
Mentor to Props & Costumes	Megan Faulkner
Mentor to Publicity	Lauren Spada
Mentor to Program Designer	Tom Collins
Mentor to House Manager	Rob Matrow

Appendix B – Cast List

Reverend Parris	Tofer Carlson
Betty Parris	Angela Simpson
Tituba	Adeola Otuyelu
Abigail Williams	Anika Blodgett
Susanna Walcott	Heidi Robertson
Mrs. Ann Putnam	Lauren Spada
Thomas Putnam	Nick Bebel
Mercy Lewis	Holly Fletcher
Mary Warren	Kelsey Mawhiney
John Proctor	Bryan Rickard
Rebecca Nurse	* Beth Ruffa
Giles Corey	Kosta Filiotis
Reverend Hale	Joel Sutherland
Elizabeth Proctor	Carol Wood
Francis Nurse	James Johnson
Ezekiel Cheever	Nick Teceno
John Willard	Dan Hartman
Judge Hathorne	Joshua Luther
Martha Corey	Catherine Coleman
Deputy Governor Danforth	Jon Kelly
Sarah Good	Sarah Judd
Hopkins	Minkyu Lee
Townspeople	Alex Geyster
	Rob Matrow
	Alex Rock

Megan Faulkner was originally cast as Rebecca Nurse, but fell sick two days before opening night. An emergency audition was held, and Elizabeth Ruffa was cast. Additionally, Chris Sanchez was cast as an emergency stand-in for the show.

Appendix C – Production Calendar

October 6	Auditions
October 7	Auditions
October 9	Callbacks
October 13	Design meeting, Readthrough
October 20	Original poster deadline
October 26	Teleconference with David Stechmann
October 29	Production meeting
November 1	Set build
November 2	Original set construction deadline
November 4	Set build
November 5	Set build, Production meeting, Sound recording
November 6	Set build, ISP forms due
November 7	Light hang
November 8	Light hang
November 9	Original props and costumes deadline
November 10	Light focus, Blacklight and color blast hang, Set painting
November 11	Blacklight and color blast hang, Set painting
November 12	Production meeting
November 13	Mylar construction
November 14	Mylar construction, Final costumes deadline
November 15	Sound, lights, and paint deadline, Cue-to-Cue
November 16	Ticket sales begin, Tech rehearsal, Headshots taken
November 17	Tech rehearsal
November 18	Preview night, Scenic photographs taken
November 19	Performance night
November 20	Performance night
November 21	Performance night

Appendix D – Meeting Minutes

October 13, 2009 meeting minutes as sent by assistant producer Andrew Wilkins

SET

- Floor plan!
- Benches need to be assembled
- Paint and crap needs to be moved from Jessica's office asap. (Big Red is on it)
- Mylar needs to be tested with lights
 - Looking into using it on the windows
- DO PAINT TESTS BEFORE PAINTING EVERYTHING!!

PROPS & COSTUMES

- Glowing "tatoos" - painted onto nylon
- Use of latex to hold down nylon; figure out any latex allergies
- Perhaps make it a shawl or a robe or t-shirt, more of a marking
- General look: NOT 1600's Salem
 - "Mad Men" style ("January Jones and Don whathisname")
 - blacks and grays
- Distinguishing children vs. adults? (something to think on)
- Aging? Makeup wise... probably not. Gray hair spraying?
 - whatever we do, let's get something that looks good

POSTERS

- Deadline: 10-20-09
- Three "flavors" of poster: one for the "Big Board" (outside of Alden), one for LT board, one general poster
 - no mention of live feed, or "doors open" time; pay attention to any notes in the script

PUBLICITY

- "team" of publicity people visiting department heads and offices to invite people
- also making invitations
- along with the usual mediums (plus T&G, the Phoenix, craigslist)
- Meet w/ Lauren Spada (mentor) + Carol Wood (art director)

DANCE

- Lindy offered to help choreograph

SOUND

- "punctuate the action" vs "musical collage"?
- we'll "play it by ear" (lololol) and wait until after some rehearsals
- Let's look into options for upgrading sound quality
- VOX has offered to lend us the wireless mics for the dancing scene (if needed)

LIGHTING

- Blacklights should be ready by the end of break. We'll see about sooner
- Need to test mylar under lighting
- Color palette?
 - white and black, minimal "ladybug red", grays
 - punctuated with neons (uv illumination and otherwise - stark contrast)

LIVE FEED

- Potentially some new cameras

GENERAL

- We spent some money, we still have a bunch more money.
- In general: Don't worry about the money, but don't go crazy.
- LT terms of use were read
 - Can be found online, as well as posted in the LT
- LT liaison is Matt Houstle

ANNOUNCEMENTS

- RJ, Pat, Elena, Carol -> Creative Experimental Art Team
- mostly for dicking about with the paint
- The mylar is... bright.
- looking for solutions (hairspray is our best bet)
- LET PEOPLE KNOW WHAT AND WHEN THINGS ARE HAPPENING
- LT rules were summarized
- Don't put crap on the rehearsal tables. They're already ruined enough as-is

SET

- RJ went through the major features of the set
- half-cube step to get onto bed
- suspended over stairs
- cross on E seating bank stairs and over bed
- "ceiling arch" going behind set (N) and behind audience (S)
- jailbed ideas: talking after meeting
- where are symbols going? - tbd ("everywhere")
- deadline for set - Monday
- at the very least the platforms should be in place. Other things will take a bit longer (talking after meeting)

SOUND

- There Will Be Soundtrack
- underscoring of various action from the There Will Be Blood soundtrack
- lighting will talk to sound regarding placement of music
- Need chain. RJ has chain. Problem solved!

PAINT

- samples have been put out for display (on wood and cloth)
- Experimental Art Team: go to town

POSTER

- We've got a proof
- Symbols are kinda dark and illegible ("arian eagle"), but we can work on it
- might take the price off
- "No price means the assumption of 'free' or 'I can't afford it'"
- also people will be led to not carry cash with them if they assume as such
- no reservations being taken

- door open times? esp. w/ no reservations a large number of people are going to show up close to or after 8PM if they don't know better
- tickets designed to look like poster?

LIGHTING

- Design is in motion. Will be completed once set goes up and actors start interacting with it
- Blacklights: looking into renting large blacklights; failing that, an LED option, or something
 - currently the lighting team's number one priority
- stripping grid soon (this weekend?), starting work next weekend or late next week

PROPS

- Be at the Friday rehearsal to talk to Steven and take notes on props needs, also look through script
- Sound wants to talk to props if they'll be backstage during the show

COSTUMES

- "Mad Men" style, color pallet is red, black, white, and gray
- Need to schedule a shopping trip. Tentative deadline 11-09-09
- Capes for the children, shawl length (talking after meeting)
- Costumes + Kingsley + Tristan are going to talk re: fronting money

PUBLICITY

- Looking into various ideas for eye-grabbing things to put around campus
 - as well as ideas for online publicity
- T-shirts? Definitely something to look into, talking to poster designer for design ideas
- Kingsley wants to talk after meeting

HOUSE

- Don't know status of Riley Commons
 - Try to book for the entire week

SET

- We have a set. Needs to paint.
- Good opportunity for lab hours for Susan's class
- Jailbed: materials didn't come in today, and the welding shop is closed tomorrow, so welding will get done Monday
- All the foam is in the set. Sound wants some foam. Pat will get more foam.

LIGHTING

- Lighting design will be done tomorrow
- Lighting will work around the location of the symbols
 - They'll talk after the meeting.
- Light hang starting Saturday at ~11AM, continuing Sunday at ~11AM

SOUND

- Going well. Recording a choir tonight. Got new speakers.

PAINT

- "I've got what I've got, but everything just changed."
- There's a new type of paint that just got released a few days ago that dries clear. Hurray!
- Oh boy, is it expensive though.

PROPS

- We have a props list and a shopping list
- Need a car to get stuff.

COSTUMES

- Cast has been split into three groups: "all set", "want to shop", and "no info"
 - Elena probably just start ordering things for people who haven't told her anything, since there's NO TIME
- Some of the actors who want to go shopping have their stuff, but just want to go shopping
- Set a deadline for when they can't remove costumes from theatre
- Carol gets a heart next to her name
- Need material for shawls. Give some to Pat so he can fiddle with paint.

PUBLICITY

- Need to decide on what the big poster will look like (we'll talk)
- We've got the main poster designed and finalized
- Working on invitations, waiting on crew availability. Facebook event is almost ready.

- Almost ready for t-shirts
- Tickets have not been created. Will be done at least a week before the show
- Tablesitting will be happening

LIVE FEED

- Wiring inside the theatre will hopefully be done by this weekend
- Once Riley is reserved stuff will start going in Riley
 - Riley is reserved from the 15th- onwards
- Three cameras: SW corner, SE corner, and another in the SE corner
 - Feed will be piped downstairs into green room

HOUSE

- Decorations have been ordered
- Need into the props closet.
- No reservations, except tickets can be pre-bought through company members only
 - Still write down their names
 - Need to number tickets.
 - We can't go selling other people's tickets though

PROGRAM

- Prototype of the program will be done by next week. Start giving Rick crew

OTHERS

- Look into painting windows of the bookstore?
- ISP forms due tomorrow!
- Opening night is in 14 days.

Hurray!

GENERAL

- Rick has a prototype program. Look it through.
- If you were talked to about blurbs, get it to Rick by Monday (at the latest)
- If you are in a keyed place, **MAKE SURE IT'S LOCKED WHEN YOU LEAVE.**

SET

- Things are painted. Still need to mylar crosses, need to mylar the steeple and put it up.
- Going to try hairspraying it.
- Grate is welded, and heavy.
- Jailbars are welded.
- Grate should be going up as soon as we get the last support and a lot of crew.

PAINT

- Base coat is done.
- UV paint hopefully done tonight (9PM).
- We need "accurate" crew.
- Sealing it either tomorrow or Saturday.
- Need crews? Make sure it goes out to Susan's crew.

SOUND

- Things are going well.
- Got speakers and sub up.
- Need to talk to Steve.

PROPS

- All props except for one is done
- Need to talk to carpenters about helping with the cane
 - Got pieces, just need mad drilling skillz
 - Kingsley's got mad drilling skillz
- Have an excess of rippable warrants

COSTUMES

- Most actors in costumes
 - Some actors still have not gotten back to me
 - Shopping date for them Saturday, otherwise they are providing it themselves
- Probably turning one of the seat covers into the shawls
 - Will be seeking crew (inc. from Susan's class)

HOUSE

- Have black boxes and petals, will be decorated with symbols
- Have tickets, can give you tickets in exchange for money (by next Wednesday - otherwise they'll get sold)
- Still looking for a few ushers
- Have not heard back from inductees regarding cafe.

LIVE FEED

- Cables are run
- Got crew, plus from Susan's class
- Cables dropping to cameras will NOT be green. Hurray!
- Work starting Sunday evening.

LIGHTING

- Live demonstration of colorblasts and blacklights
- Look at all the UV dots on the ground! Hurray!

GENERAL STUFF

- If you go down the stairs, beware of the pipe. And the speaker. And the lights.
 - Don't scrape the paint before we seal it.
 - Keep the theatre clean!
 - Our publicity person is sick. Transitioning to a "by-committee" state, so please be patient
 - House needs to talk to people (lighting / actors / live feed) to know where to put chairs
 - Chair setup tomorrow or so after rehearsal perhaps.
-
- One week left. Sunday, cue-to-cue at noon.
 - If any problems arise, let Rick know as SOON as you know. (including matters of a financial nature)
 - A very brief meeting will be held next week before the show.

Appendix E – Scenic Design Progression

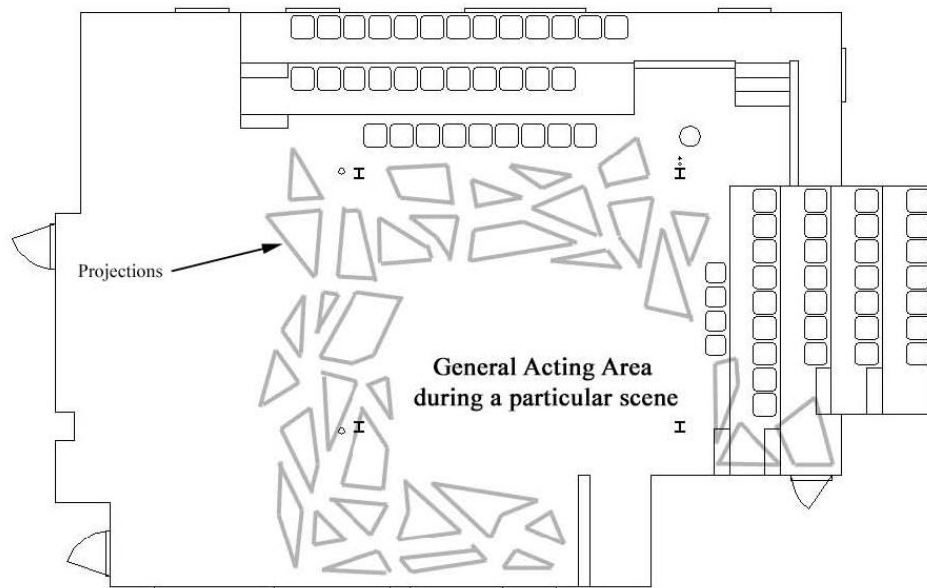

Omitted projection design by David Stechmann

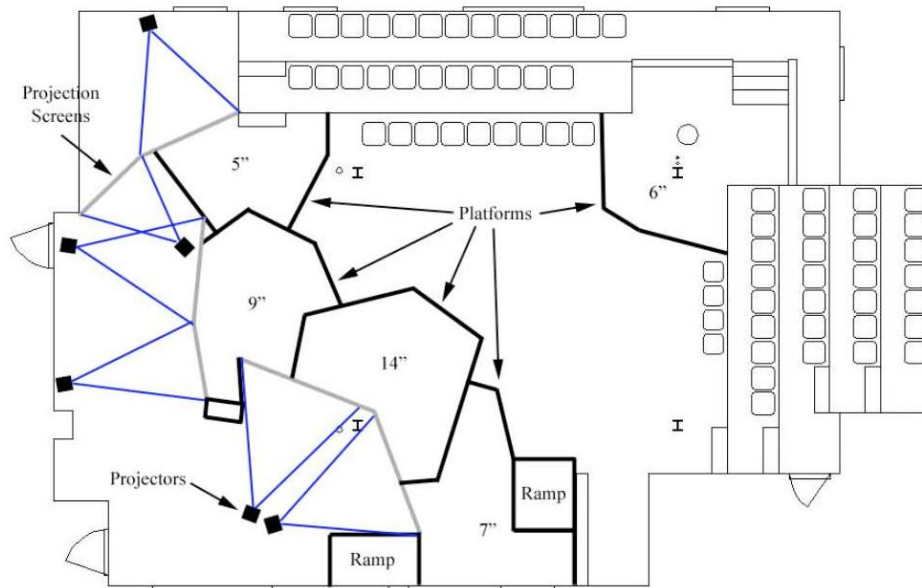

Original scenic design by David Stechmann

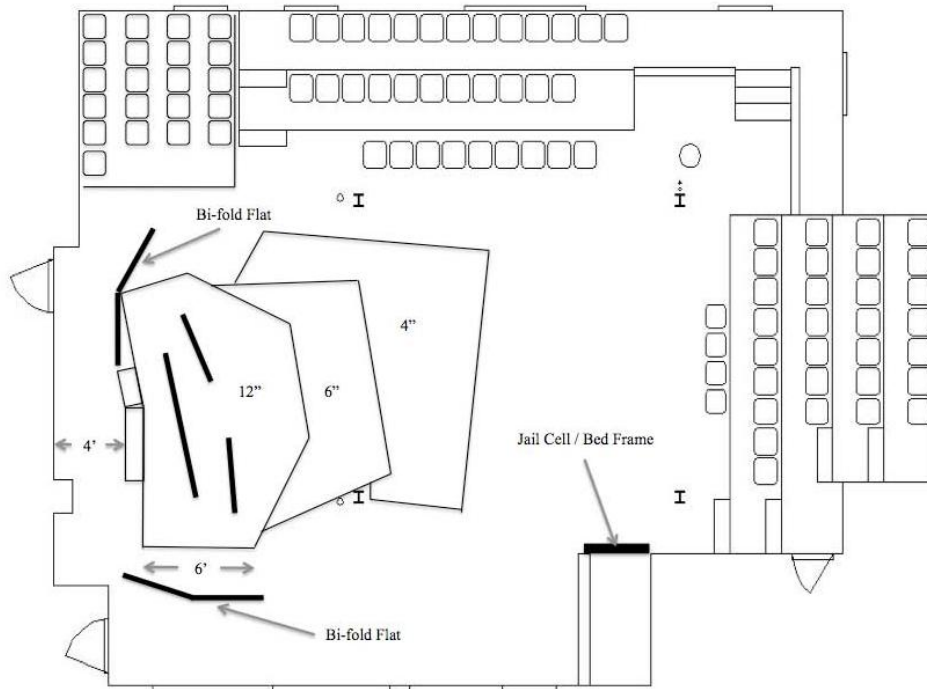

Final scenic design by David Stechmann

12" Platform Construction Elements

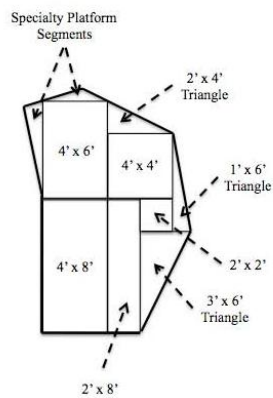

6" Platform Construction Elements

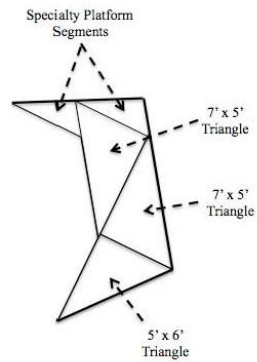

4" Platform Construction Elements

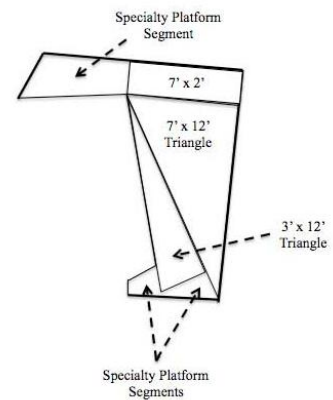

Platform design by David Stechmann

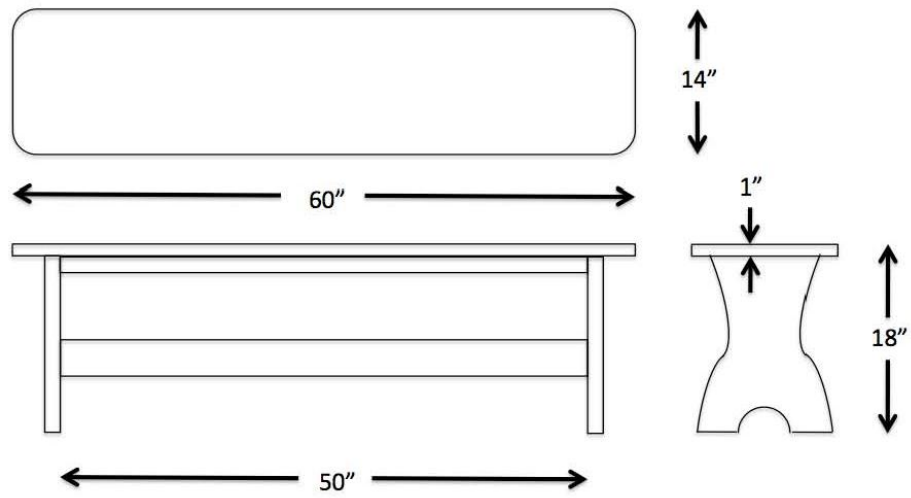

Bench specifications

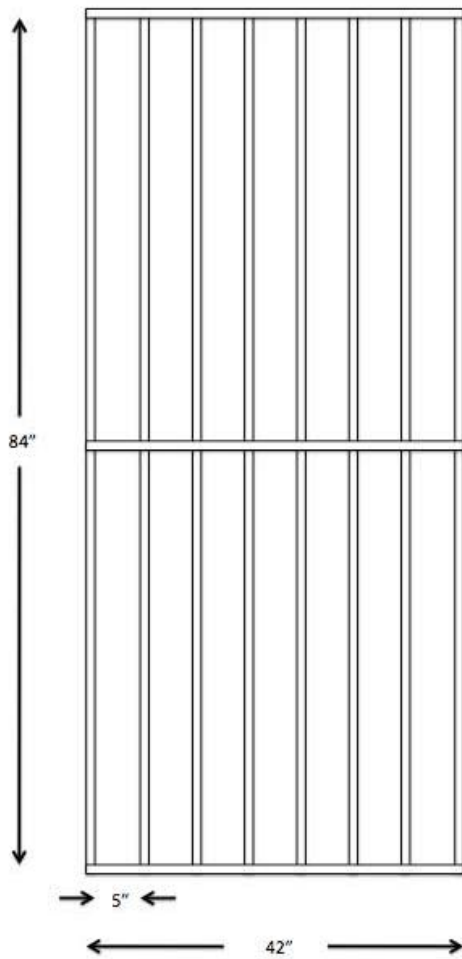

Jail cell door specifications

Appendix F - Lighting Design

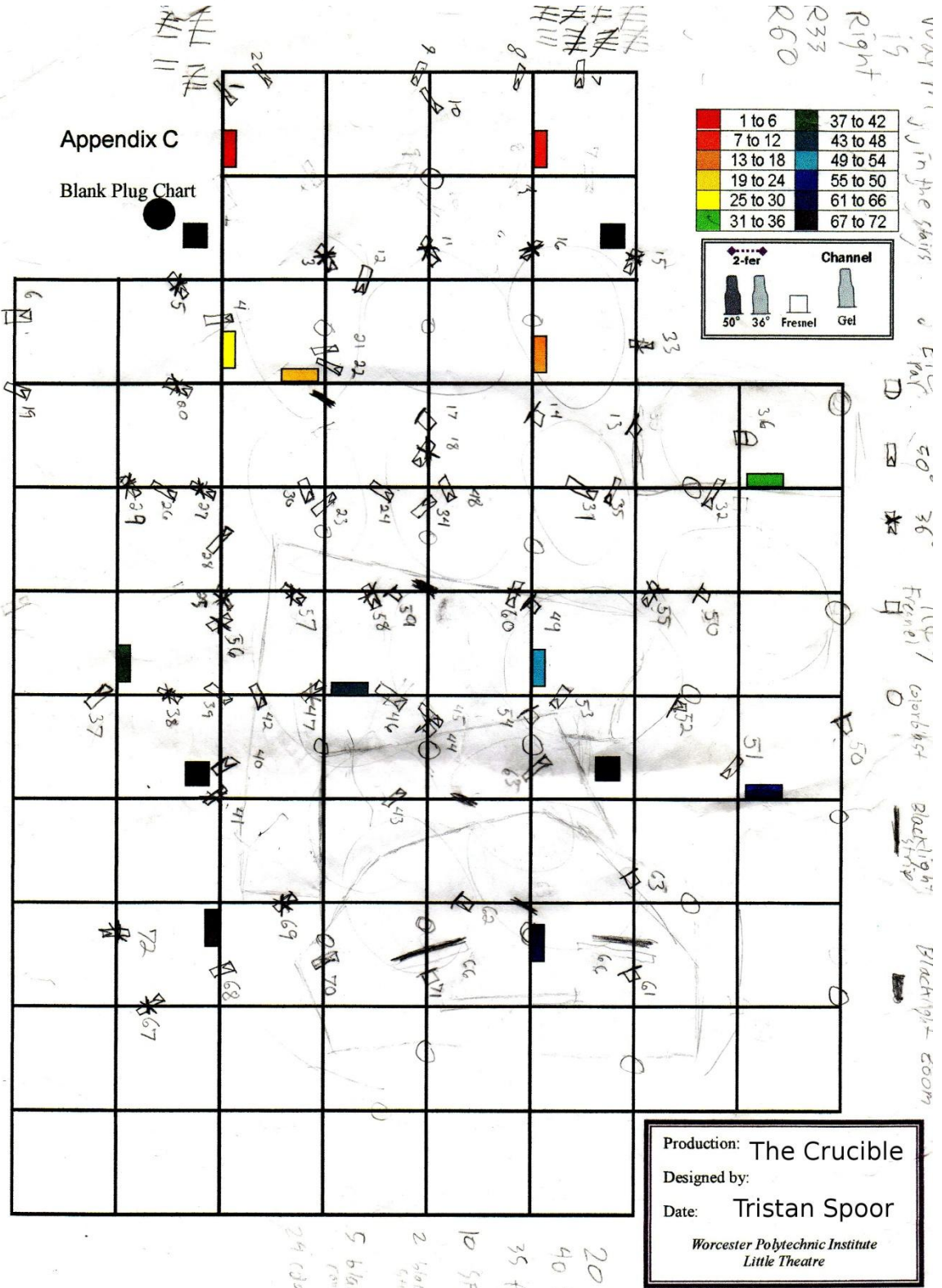

Lighting design by Tristan Spoor

Appendix G – Poster Designs

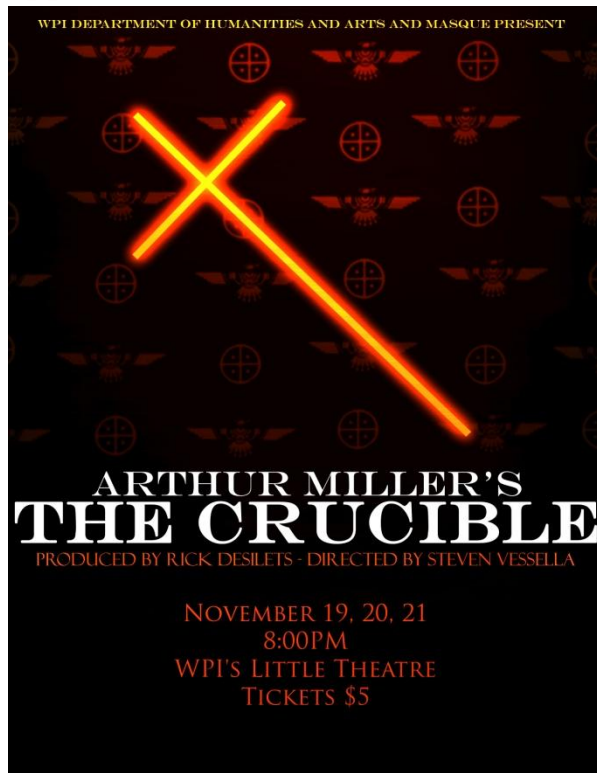

Original poster design by Elena Ainley

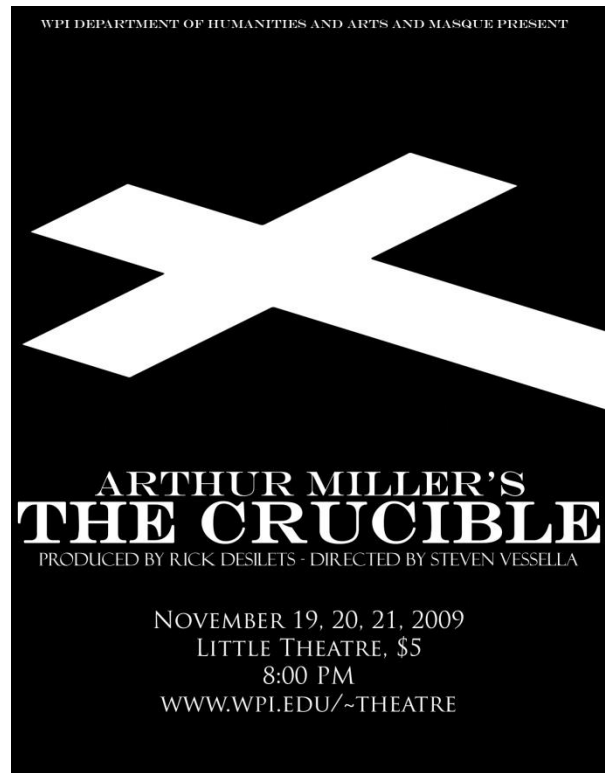

Final poster design by Elena Ainley

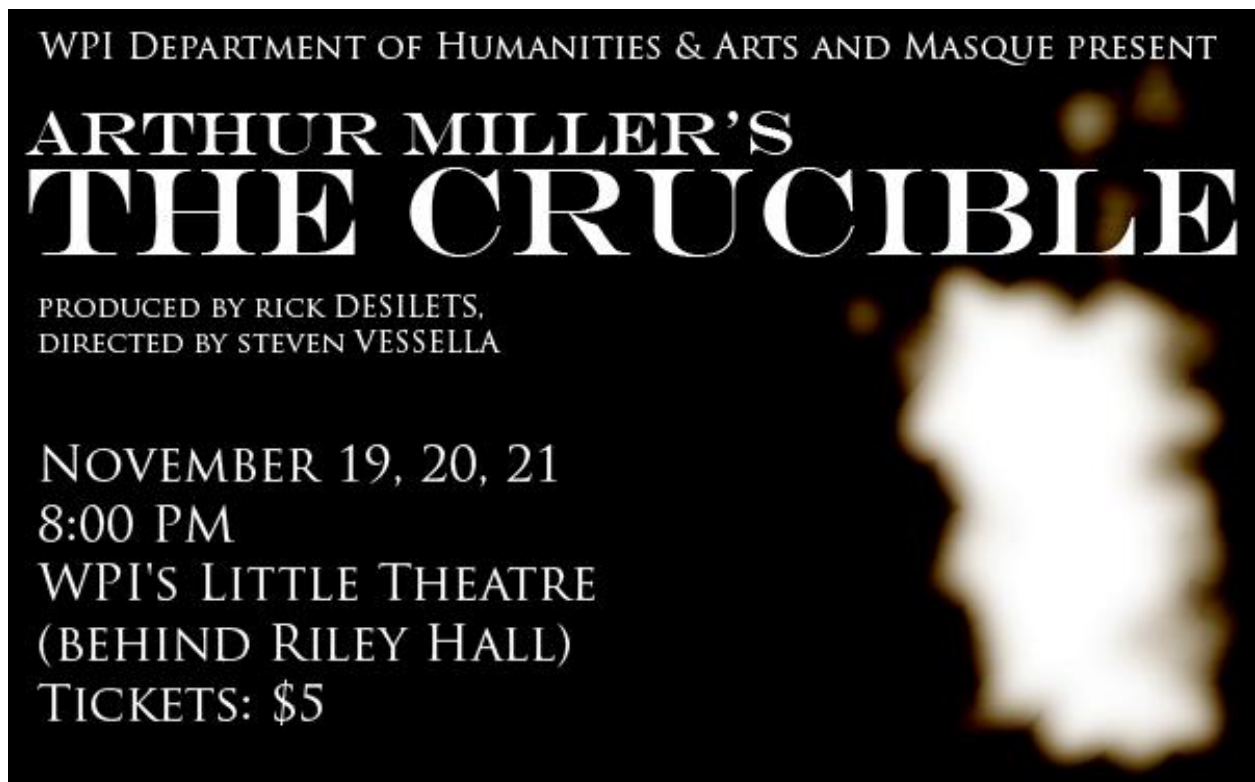

Web banner design by Elena Ainley

Appendix H - Program

WPI DEPARTMENT OF HUMANITIES AND ARTS AND MASQUE PRESENT

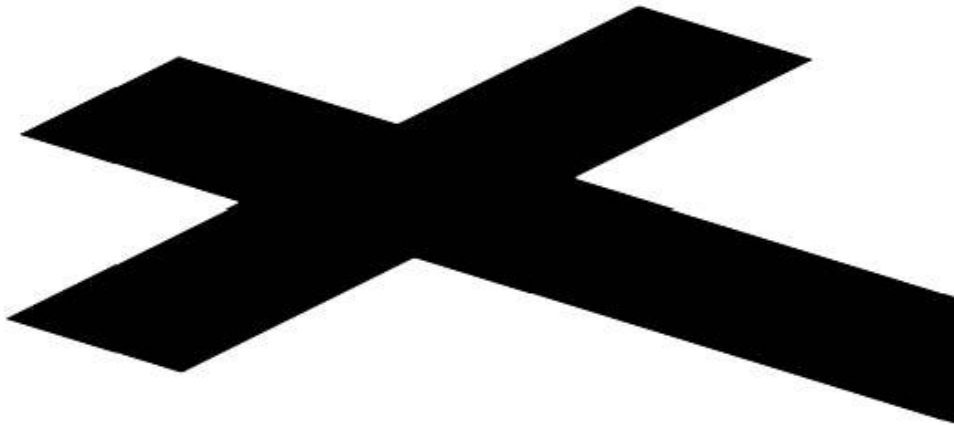

ARTHUR MILLER'S
THE CRUCIBLE
PRODUCED BY RICK DESILETS - DIRECTED BY STEVEN VESSELLA

NOVEMBER 19, 20, 21, 2009

LITTLE THEATRE, \$5

8:00 PM

WWW.WPI.EDU/~THEATRE

Program design by Rick Desilets

FROM THE STAFF

EXECUTIVE PRODUCER **RICK DESILETS** IS A SECOND-TIME PRODUCER IN WPI THEATRE. HIS FIRST EXPERIENCE AS SUCH PRODUCING *THE SUNBURNS SUMMER SHOWCASE* IN 2008. HAVING ACTED IN AND WORKED ON PRODUCTIONS IN HIGH SCHOOL, RICK FIRST BECAME INVOLVED IN WPI THEATRE DURING THE 2007 PRODUCTION OF *HARLEQUIN*. SINCE THEN, RICK HAS BEEN INVOLVED IN NEARLY EVERY SHOW. NOT CONTENT PERFORMING ONLY IN THEATRICAL PRODUCTIONS, RICK BECAME THE FIRST WPI STUDENT TO MAINTAIN ACTIVE MEMBERSHIP IN ALL THREE STUDENT COMEDY PRODUCTIONS GROUPS FOR MORE THAN ONE TERM, AND HAS THROUGHOUT WPI PERFORMED IN OVER 40 SHOWS. HE ALSO STARRED IN *BROKEN WALL* FILMS INDEPENDENT FILM *SOMETHING REMOTE*, WHICH RECENTLY WON "BEST FEATURE" AND "FUNNIEST FLICK" AT THE SHK CITY FLICK FEST. RICK IS MAJORING IN MATHEMATICS AND HUMANITIES AND ARTS (WITH A CONCENTRATION IN DRAMA/THEATRE) IN THE CLASS OF 2010. AMONG MANY LEADERSHIP POSITIONS AT WPI, RICK WAS AN OFFICER OF MASQUE, AND IS CURRENTLY AN ACTIVE MEMBER OF ALPHA PSI OMEGA, THE DIRECTOR OF EMPTY SET, AND PRESIDENT OF STUDENT COMEDY PRODUCTIONS.

DIRECTOR **STEVEN VESSELLA** IS A SECOND-TIME DIRECTOR IN WPI THEATRE. HIS FIRST EXPERIENCE BEING *LOVE AND MONEY* IN 2008. HE HAS BEEN ACTING SINCE CHILDHOOD IN COMMUNITY THEATRE, AND WAS INVOLVED IN HIGH SCHOOL PRODUCTIONS AS MUCH AS POSSIBLE. HE MADE HIS DEBUT ON THE WPI STAGE IN *NEW VOICES 24*, AND HAS BEEN A PART OF MANY MASQUE AND MW REPERTORY PRODUCTIONS INCLUDING *6 DEGREES OF SEPARATION* (TRENT), *CURSE OF THE STARVING CLASS* (TAYLOR), *THE UNDERPANTS* (VERSATI), *GROSS INDECENCY: THE THREE TRIALS OF OSCAR WILDE* (WILDE), *DOG SEES GOD* (VAN) AND *THE BOOK OF HZ* (DONNY). HE HAS ALSO ACTED IN *NEW VOICES 25* AND *27*, AND WAS A FIRST TIME PLAYWRIGHT IN *NEW VOICES 26*. STEVEN IS MAJORING IN BIOLOGY & BIOTECHNOLOGY AND HUMANITIES & ARTS (WITH A CONCENTRATION IN DRAMA/THEATRE) IN THE CLASS OF 2010. HE IS A BROTHER OF PHI SIGMA KAPPA FRATERNITY AND A MEMBER OF THE ALPHA PSI OMEGA SOCIETY.

SCENIC DESIGNERS **SUSAN VICK** AND **DAVID STECHMANN** (CURRENTLY A STRUCTURAL ANALYST WITH BOEING IN WASHINGTON STATE) WORKED TOGETHER ON THE OPENING OF THE LITTLE THEATRE IN NOVEMBER 2005. WHEN DAVID WAS A LIGHTING DESIGNER AND ACTOR. DAVID WAS FOG MASTER FOR *OUR TOWN* IN THE LITTLE THEATRE IN 2006, AND IN 2007 PERFORMED WITH WPI THEATRE IN CATHERINE DARENSBOURG'S *FRENCH VANILLA* AT THE SAMUEL FRENCH OFF-BROADWAY SHORT PLAY FESTIVAL IN NEW YORK CITY. PRIOR TO THE ARRIVAL OF THE LITTLE THEATRE, DAVID CREATED BOTH THE POSTER AND THE SCENIC DESIGN FOR SUSAN VICK'S PRODUCTION OF *DEATH OF A SALESMAN*, WHICH—UNTIL SHE DOES THE NEXT ONE—REMAINS THE LAST ACADEMIC THEATRE PRODUCTION STAGED IN B TERM IN ALDEN HALL. DAVID EARNED A BS IN MECHANICAL ENGINEERING (2006) AND AN MS IN MECHANICAL ENGINEERING (2007) AT WPI. AMONG MANY HONORS RECEIVED AT WPI, DAVID WAS A MEMBER AND OFFICER OF ALPHA PSI OMEGA. HE IS ALSO AN ACCOMPLISHED TAP DANCER AND A PROFICIENT JUGGLER.

PRODUCTION STAFF

EXECUTIVE PRODUCER DIRECTOR DRAMATURG LITTLE THEATRE LIAISON STAGE MANAGER ASST. PRODUCER ASST. SM, PRODUCTION ASST. SM, SCRIPT SUPERVISION	RICK DESILETS STEVEN VESSELLA HELEN VASSALLO MATT HOUSTLE CODY SHULTZ ANDREW WILKINS CALEB RUVICH PETER WORREST
SCENIC DESIGNERS	SUSAN VICK DAVID STECHMANN
PROPERTY MASTER ASST. PROPERTY MASTER COSTUME DESIGNER POSTER DESIGNER PROGRAM DESIGNER SCENIC PHOTOGRAPHER PERSONAL PHOTOGRAPHER STRIKE MANAGER	DAN PAPPAS ADAM THIBAUT ELENA AINLEY ELENA AINLEY RICK DESILETS DAN VAILLANCOURT SHANNON "HAZ" HARROWER MATT HOUSTLE
DIRECTOR OF THEATRE ADMINISTRATOR OF TECHNICAL THEATRE VISITING ADMIN. OF TECH. THEATRE VISITING ACADEMIC PROFESSIONAL MENTOR TO PRODUCER MENTOR TO STAGE MANAGER MENTOR TO MASTER CARPENTER MENTOR TO MASTER ELECTRICIAN MENTOR TO PROPS & COSTUMES MENTOR TO PUBLICITY MENTOR TO PROGRAM DESIGN MENTOR TO HOUSE MANAGER	SUSAN VICK JESSICA SANDS CHRISTOPHER KINGSLEY JEFF ZINN PATRICK CROWE COREY RANDALL CHRIS PARDY MATT HOUSTLE MEGAN FAULKNER LAUREN SPADA TOM COLLINS ROB MATROW

"WHAT AN AMAZING EXPERIENCE TO WORK WITH SUCH A TALENTED CAST AND CREW. MY FIRST ROLE WAS IN A PRODUCTION OF *THE CRUCIBLE*, SO IT IS VERY NOSTALGIC TO BE ABLE TO WORK ON IT AS A PRODUCER. I HOPE YOU ALL ENJOY WATCHING THIS SHOW AS MUCH AS I HAVE ENJOYED WORKING ON IT."

RICK DESILETS
EXECUTIVE PRODUCER

CAST (IN ORDER OF APPEARANCE)

REV. PARRIS BETTY PARRIS TITUBA ABIGAIL WILLIAMS SUSANNA WALCOTT MRS. ANN PUTNAM THOMAS PUTNAM MERCY LEWIS MARY WARREN JOHN PROCTOR REBECCA NURSE GILES COREY REV. JOHN HALE ELIZABETH PROCTOR FRANCIS NURSE EZEKIEL CHEEVER JOHN WILLARD JUDGE HATHORNE MARTHA COREY DEP. GOV. DANFORTH SARAH GOOD HOPKINS TOWNSPEOPLE	TOFER CARLSON ANGELA SIMPSON ADEOLA OTUYELU ANIKA BLODGETT HEIDI ROBERTSON LAUREN SPADA NICK BEBEL HOLLY FLETCHER KELSEY MAWHINEY BRYAN RICKARD MEGAN FAULKNER KOSTA FILIOTIS JOEL SUTHERLAND CAROL WOOD JAMES JOHNSON NICK TECENO DAN HARTMAN JOSHUA LUTHER CATHERINE COLEMAN JON KELLY SARAH JUDD MINKYU LEE ALEX GEYSTER ROB MATROW ALEX ROCK
---	--

"THE ACTORS AND PRODUCTION CREW WORKED INCREDIBLY HARD AND FAST (JUST UNDER A MONTH!) TO TURN MY VISION INTO A REALITY. A FEAT OF STRENGTH IN DEED. WPI IS FLOODED WITH TALENTED STUDENTS AND OUR LITTLE THEATRE IS A MAIN OUTLET. PREPARE TO BE SOAKED!"

STEVEN VESSELLA
DIRECTOR

PRODUCTION CREWS

MASTER CARPENTER ASST. MASTER CARPENTER NICK ALUNNI NICK BEASLEY JARED ERB MIGAN FAULKNER	SET CREW CHRIS MACKENZIE SARAH MACKENZIE IAN MCNEIL KILLIAN NELSON	RJ LAMURA PATRICK CROWE BRYAN PASQUALUCCI ERIN SAARI CHRIS SANCHEZ GABRIEL STERN-ROBBINS
ART DIRECTOR NICK ALUNNI MEGAN FAULKNER MELANIE LEBERGE	PAINT CREW SARAH MACKENZIE KILLIAN NELSON ERIN SAARI	CAROL WOOD GABRIEL STERN-ROBBINS JOEL SUTHERLAND KALEIGH TOMKINSON
LIGHTING DESIGNER MASTER ELECTRICIAN LIGHT BOARD OPERATOR ELENA AINLEY NICK ALUNNI JONY BALBONI NICK BEASLEY ALEX CLARK JUSTIN DEMPSEY CONNOR ELLISON JARED ERB	LIGHT CREW SARAH FISCHER MATT HOUSTLE CHRISTOPHER KINGSLEY MELANIE LEBERGE RJ LAMURA BEN LAVERRIERE ZHAOCHEN LIU	TRISTAN SPOOR JAKE LEE BROWN SHUCHI MITRA THOMAS MACARI SAM MONIZ KILLIAN NELSON ALEX ZOSSEN AUTUMN SHLKE MATTHEW THOMSON VICTORIA VALENCIA ANDREW WILKINS
SOUND DESIGNER SOUND BOARD OPERATOR JONY BALBONI	SOUND CREW BOB CONNICK	BEN LAVERRIERE LINCOLN BARBER JENNA JASER
PUBLICITY SARAH MACKENZIE MARISSA NORTON	PUBLICITY ADRIANA MARTINEZ-BETANCOURT CLAIRE SYLVESTER AUTUMN SHLKE	KALEIGH TOMKINSON
HOUSE MANAGER	HOUSE AND USHERS EMILY "LINDY" BOWEN	
TECHNICAL DIRECTOR ASST. TECHNICAL DIRECTOR EMILY ARRATTE JONATHAN ESTABROOK SARAH FISCHER JOE FUNK	LIVE FEED DANIEL LANIER CHRISTINA MCGLEW KILLIAN NELSON RYAN O'MEARA FRANK PALLER	ANDREW WILKINS SAM MONIZ ERIN SAARI ALEX SCOTT EMILY SCOTT-SOLOMON ANDREW Z. SMITH

SUSAN VICK'S PERSONAL CREW
CONSERVATORY PROJECT ADVISOR
SAMANTHA DUROIS
NICHOLAS MEDEIROS
SUSAN VICK
ELIZABETH RUFA

CAST BIOS

NICK BEBEL (APRIL 15, 1986 - NOVEMBER 19, 2009)

NICK STENT OVER THE YEARS OF HIS LIFE DEDICATED TO WPI THEATRE BEFORE THE ACCUSATIONS STARTED RAINING DOWN. HE FELT HIS UNWAVERING LOVE OF THEATRE AND INVOLVEMENTS AS AN ACTOR, DIRECTOR, WRITER AND COMEDIAN WOULD RAISE HIM ABOVE THE FRY. BUT EVEN THIS DISTINGUISHED MEMBER OF THE ALPHA PSI OMEGA THEATRE HONOR SOCIETY FELL VICTIM TO CRUES OF WITCHCRAFT FOR HIS CONSTANT CHANGING OF CHARACTERS AND INABILITY TO STOP TELLING JOKE. HE PASSED ON BY BEING SET ON FIRE AND THROWN OFF A CLIFF. IT IS STILL UP IN THE AIR IF HE WILL BE MISSED.

ANIKA BIDDGETT (MAY 21, 1990 - NOVEMBER 19, 2009)

ANIKA ABSOLUTELY LOVED WPI. THROUGH HER FRESHMAN EXPERIENCE LAST YEAR TO PRESENT, SHE ACTED GRATEFULLY IN ALMOST EVERY PLAY OFFERED BY MASQUE AND EVEN SERVED AS THE ORGANIZATION'S SECRETARY. SHE DANCED AND SANG AND ACCED IN VOX'S PRODUCTIONS. SHE TRILLED WITH THE CHORUS OF AIDEN VOICES AND FESTIVAL CHOR, AND ROCKED A CAPPILLA WITH THE AUDIOPHILES. SHE GRACED THE DANCE FLOORS WITH THE BALLROOM DANCE TEAM AND LOVED EVERY PERSON SHE MET. UNTIL ONE DAY THE STRESS BECAME UNBEARABLE. SHE ACCUSED EVERYONE OF WITCHCRAFT WITHOUT PROPER CAUSE, RESULTING IN MANY SUBSEQUENT HANGINGS. SHE WAS SOON MURDERED BY THE WARY PEOPLE OF THE WPI CAMPUS WHO SUSPECTED HER FROG. SHE AND HER CONSPIRACIES WILL NOT BE MISSED.

MEGAN FAULKNER (OCTOBER 14, 1988 - NOVEMBER 19, 2009)

PRIOR TO COLLEGE, MEGAN HAD NO EXPERIENCE IN THEATRE. WHILE AT WPI SHE ACTED IN *GROSS INDECENCY*, *DAISY CROCKETT*, *FRONTIERPERSON OR BE SURE YOU'RE RIGHT*, *THEY GO AHEAD*, *AMAZING GRACE*, *LOVE AND MONEY*, AND *THE CRUCIBLE*. TRAGICALLY, MEGAN WAS HANGED AFTER STANDING HER GROUND AND REFUSING TO LIE AND ADMIT TO WITCHCRAFT.

KOSTA FIIHOTIS (AUGUST 17, 1987 - NOVEMBER 19, 2009)

THE FIRST BREAK IN HIS THEATRE ACTIVITIES WAS DURING HIGH SCHOOL WHILE PERFORMING IN AN ACTION PLAY INSPIRED BY SCENES OF *THE MATRIX*. AFTER GRADUATING AND MOVING TO WPI, KOSTA DIRECTED AND ACTED IN VARIOUS SHORT PLAYS AND MUSICALS THAT PROVED POPULAR AMONG A LARGE LOCAL AUDIENCE. WHILE WORKING ON HIS BIGGEST PROJECT, ONE THAT CONTAINS SOME CONTROVERSIAL TOPICS AND THEMES ABOUT RELIGION, HE WAS ARRESTED AND FOUND GUILTY OF WITCHCRAFT. KOSTA WAS SENTENCED TO EXECUTION BY DROWNING. WITH HIS EYES FILLED TO HIM, HE WAS THROWN INTO A VIAL OF MAPLE SYRUP AND DROWNED.

HOLLY FLETCHER (JANUARY 10, 1990 - NOVEMBER 19, 2009)

SOON AFTER STARTING HER COLLEGE EXPERIENCE, HOLLY BECAME A PART OF WPI THEATRE WHEN SHE WAS CAST IN *ROCKY BIRD*, AKA *CRAZIES IN LOVE*. BEFORE HER UNTIMELY DEATH SHE ALSO APPEARED ON THE WPI STAGE IN *PIECE OF FIRE* AND *THE SILENT PRODUCTION*. THE BOOK OF *LIZ*, DURING WHICH SHE WAS ACCUSED OF WITCHCRAFT AND THROWN INTO LAKE QUINSIGAMOND, TO SEE IF SHE FLOATED (AS ALL GOOD WITCHES DO). SHE SANK, PROVING HER INNOCENCE. OOPS.

DAN HARTMAN (MAY 17, 1989 - NOVEMBER 19, 2009)

AFTER GETTING HIS START IN *OUR TOWN*, HE CONTINUED HIS THEATRE CAREER LANDING ROLES AS A DRINKARD IN *GUNS AND DOLLS* AND *THE CRUCIBLE*. UNFORTUNATELY, HIS PRACTICE OF GETTING INTO CHARACTER, BEGAN TAKING OVER HIS LIFE AND HIS HOUSE CAUGHT ON FIRE WHILE HE SLEPT. HE SURVIVED WITHOUT A SCRATCH, BUT BECAUSE OF THE LACK OF BODY HARM, HE WAS TRIED AS A WITCH AND SENTENCED TO BURN AT THE STAKE.

CAST BIOS

HEIDI ROBERTSON (FEBRUARY 20, 1989 - NOVEMBER 19, 2009)

AFTER ATTENDING VARIOUS THEATRE PRODUCTIONS AT WPI AND SEEING THE QUALITY OF SUCH PERFORMANCES HELD THEREIN, HEIDI DECIDED SHE MUST BEGIN HER SERIOUS ACTING CAREER BY BECOMING ONE OF THESE POLYTECHNIC PLAYERS. SHE GAINED HER START BY STAGE MANAGING *THIRTY-SIX STATUATIONS* AND PERFORMING IN *A LETTER UNSENT* AS PART OF *NEW VOICES 27*. HOWEVER, BEFORE HER ACTING CAREER BEGAN, SHE WAS ARRESTED FOR DEALINGS WITH THE DEVIL DUE TO VARIOUS ANONYMOUS REPORTS SENT INTO THE AUTHORITIES CLAIMING SHE WAS EVIL. FURTHER INVESTIGATION REVEALED THAT SHE HAD INDEED SOLD HER SOUL TO LUCIFER WHEN IT WAS DISCOVERED THAT SHE OWNED THE NOVEL AND HAD SEEN THE MOVIE *TWILIGHT*. UNHAPPILY THOUGH, SHE WAS UNABLE TO BE EXECUTED FOR THIS CRIME AS THE UNCLEAR STATE OF THE PRISON CELL IN WHICH SHE WAS KEPT AND HER INABILITY TO CLEAN SAID CELL CAUSED HER DEATH ALMOST IMMEDIATELY UPON INCARCERATION. WE MUST ALL REMEMBER GOD'S WORK IS DONE NONETHELESS.

ALEX ROCK (UNKNOWN - NOVEMBER 19, 2009)

PRIOR TO ALEX ROCK'S DEATH HE PARTICIPATED IN MANY THEATRICAL PRODUCTIONS INCLUDING *SOUTH PACIFIC* AND MANY HIGH SCHOOL PRODUCTIONS. HE DIED WHILE SNORKELING WITH ELECTRIC EELS.

ANGELA SIMPSON (AUGUST 31, 1990 - NOVEMBER 19, 2009)

ANGELA PERFORMED MANY SHOWS DURING HER HIGH SCHOOL CAREER INCLUDING *HOW DOES A THING LIKE THAT GET STARTED?*, *FOOTLOOSE*, AND *A MAD BREAKFAST*. SHE HAD DREAMS OF PERFORMING MANY MORE SHOWS THROUGHOUT COLLEGE WHEN AN UNEXPECTED TRAGEDY OCCURRED. DURING AN EXTREME ROCK PAPER SCISSORS COMPETITION ANGELA RECEIVED A MASSIVE PAPER CUT TO THE THROAT. THEY TRIED TO STOP THE BLOOD FLOW BY USING THE ROCKS WHICH IN THE END SUFFOCATED HER. THE SCISSORS WERE FOUND GUILTY AND WERE MELTED DOWN TO MAKE CHILDREN'S TOYS.

JOEL SUTHERLAND (MARCH 23, 1990 - NOVEMBER 19, 2009)

JOEL SUTHERLAND, HAVING BEEN CLEARED OF ALL CHARGES IN THE INFAMOUS WORCESTER WITCH TRIALS, RETURNED TO HIS HOME IN CALIFORNIA, ONLY TO BE PROMPTLY CONVICTED AND HANGED UNDER SUSPICION OF CHRISTIANITY.

NICK TENCENO (MARCH 22, 1991 - NOVEMBER 19, 2009)

NICK WAS EXPERIENCING HIS FIRST YEAR AT WPI AS WELL AS HIS FIRST YEAR WITH WPI'S A AND B TERM PLAYS. FROM A SMALL TOWN IN MASSACHUSETTS, PLYMPTON, NICK IS NEW TO THE BIG CITY PRODUCTIONS AND THOROUGHLY ENJOYS THEM. HIS ONE DREAM BEFORE HIS TIME OF DEATH WAS TO CONTINUE TO BE INVOLVED IN WPI'S THEATRE PROGRAM. DIED DURING PRODUCTION WEEK OF *THE CRUCIBLE*. DUE TO EXHAUSTION FROM ACTING, MAY HE REST IN PEACE.

TOFER CARLSON, CATHERINE COLEMAN, ALEX GEYSTER, SARAH JUDD, ADRIANA OTUYELLI, LAUREN SPADA, AND CAROL WOOD WERE VICTIMS OF UNNATURAL MURDER AT THE HANDS OF MANY OF THE FOREMENTIONED WITCHES. THEY WERE QUICKLY BURIED IN UNSHARDED GRAVES TO COVER UP THE CRIMES.

"I WAS SO HAPPY TO GET A CHANGE TO WORK WITH SUCH A GREAT CAST AND CREW FOR ARTHUR MILLER'S *THE CRUCIBLE*. A LOT OF PEOPLE TOOK A GREAT CHANCE AND PUT A LOT OF FAITH IN ME COMING IN AS A FRESHMAN NEVER HAVING ANY PRIOR STAGE MANAGING EXPERIENCE. IT'S BEEN A GREAT EXPERIENCE WORKING WITH EVERYONE AND I HAVE LEARNED A LOT. I HOPE PEOPLE ENJOY THE PLAY AS MUCH AS I HAVE ENJOYED THE RIDE."

CODY SHULTZ
STAGE MANAGER

CAST BIOS

JAMES JOHNSON (JULY 5, 1987 - NOVEMBER 19, 2009)

AFTER TRAVELING THE WORLD TO STUDY THE DARK ARTS, JAMES WENT TO MASSACHUSETTS TO FIND A QUIET TOWN WHERE HE COULD BEWITCH PEOPLE INTO BELIEVING HE WAS A QUIET BIBLE SALESMAN. AFTER THE THIRD COW WAS FOUND THE LOCAL LAW ENFORCEMENT TRIED AND SENTENCED JAMES TO DEATH FOR THE PRACTICE OF WITCHCRAFT. AFTER JAMES CURSED THE HANGMAN AT THE GALLOW, THE JUDGE ORDERED A SPECIAL DEUCE, AND JAMES WAS GAGED AND BURNED AT THE STAKE. THE NEWSPAPER ARTICLE MADE FRONT PAGE BECAUSE SOMEBODY HAD BEEN REPORTED SEEN THROWING A CHAINSAW AT THE STAKE.

ION KELLY (FEBRUARY 16, 1983 -)

AFTER A DISTINGUISHED HIGH SCHOOL ACTING CAREER, ION RETREATED TO THE WILDERNESS FOR SEVERAL YEARS. TO LIVE A LIFE OF SOLITARY REFLECTION AND ASCETICISM. AFTER CURSORY VENTURES BACK INTO SOCIETY, ION WAS SEDUCED BACK INTO THE FOLD OF LIVE THEATRE THROUGH THE GUILT OF ONE JAMES JOHNSON, NOW DEPARTED. *THE CRUCIBLE* MARKS ION'S TRIUMPHANT RETURN TO THE STAGE - BUT UNFORTUNATELY, IN HIS ZEAL FOR CHARACTER ACTING, ION VICIOUSLY CONDEMNED HIS FELLOW PERFORMERS AS A VILE BROOD OF GODLESS WITCHES, AND SUMMARILY SAW THEM ALL EXECUTED FOR THEIR CRIMES.

MINKYU LEE (NOVEMBER 15, 1988 - NOVEMBER 19, 2009)

SINCE HE STARTED ACTING IN THE HIGH SCHOOL SHOW *JERKY AND HYDE*, MINKYU JUST STARTED HIS CAREER IN ACTING AND ROCKING ON THE STAGE. MINKYU GOT INTO WPI THEATRE IN *NEW VOICES 26*. HE WAS ALSO IN OTHER SHOWS LIKE *THE SCOTTISH PLAY*, *LITTLE SHOP OF HORRORS*, *PETER PAN*, AND OTHERS. THERE IS A LEGEND ABOUT MINKYU LEE THAT HE WAS CHARGED WITH WITCHCRAFT AND DIED WITH ONE LINE FOR HIS GRIEVED: "I LOVE YOU, QUIL."

JOSHUA LUTHER (MAY 6, 1988 - NOVEMBER 19, 2009)

JOSHUA GOT HIS START IN WPI THEATRE IN VARIOUS NEW VOICES PERFORMANCES. HOWEVER, HIS FIRST REAL ROLE CAME ABOUT IN RAY BRADBURY'S *PILLARS OF THE HEAVENS* A FEW YEARS OF *KARAOKE* AND *GUESS WHO* SHOWS. IT IS SAID THAT JOSHUA DIED AS HE LIVED, CRUSHED UNDERNATH THE WEIGHT OF HIS WORKLOAD. HIS LAST FEW LINES:

ROB MATROW (MARCH 5, 1988 - NOVEMBER 19, 2009)

ROB MATROW HAS BEEN INVOLVED IN WPI THEATRE SINCE *NEW VOICES 25*. HE NEVER NEEDED A RIO UNTIL THIS YEAR. FOR HIS CRIME OF SENDING IN HIS RIO LATE, ROB WAS SENTENCED TO BE PUT TO DEATH BY PAPER CUTS FROM A BOOK ON TAPE.

KELSEY MAWHINNEY (AUGUST 23, 1988 - NOVEMBER 19, 2009)

KELSEY MAWHINNEY HAD BEEN ACTIVELY INVOLVED IN WPI THEATRE STARTING WITH HER ROLE AS KATHIE IN THE *NEW VOICES 26* SHOW. SINCE THEN, SHE HAD PERFORMED IN *GROSS INDECENCY*, *THE TRIAL TRIALS* OF OSCAR WILDE IN *NEW VOICES 27* AS A NEWLY-WED NAMED EVELYN, AND IN THE SUMMER PRODUCTION OF *THE BOOK OF LIZ* AS A SOPHISTICATED VISITOR, DOCTOR GINLEY, AND MS. HOSLEY. SADLY, HER LOVE OF THEATRE PROMPTED HER DEMISE WHEN SHE WAS POSSESSED BY THE LITTLE THEATRE'S ICKUS SPIRIT DURING A REHEARSAL. THE EXORCISM WAS UNSUCCESSFUL AS SHE SUCCEMURED TO THE DARK SIDE OF ACTING.

BRYAN RICKARD (MAY 2, 1988 - NOVEMBER 19, 2009)

AFTER BEING INTRODUCED TO THEATRE HIS JUNIOR YEAR OF HIGH SCHOOL, WPII ROLES IN *THE SURVIVOR AND GREASE*. BRYAN MADE HIS START IN WPI THEATRE WITH THE ROLE OF HOWIE NEWSOME IN *OUR TOWN*. HE WAS DISTRACTED FROM THEATRE FOR A COUPLE OF YEARS AS HE PURSUED POSITIONS IN THE STUDENT ADMIN. SOCIETY AND TAU KAPPA PSI LION FRATERNITY. SADLY, BEFORE MAKING HIS RETURN TO THEATRE AS JOHN PROCTOR IN *THE CRUCIBLE*, BRYAN DROWNED WHILE SWIMMING IN INSTITUTE POND.

VICTIMS OF THE SALEM WITCH TRIALS

THE FOLLOWING IS A LIST OF THOSE WHO EITHER WERE EXECUTED OR DIED WHILE IN PRISON DURING THE SALEM WITCH TRIALS:

SARAH OSBORNE	DIED IN CUSTODY MAY 10, 1692
ROGER TOOTHAKER	DIED IN CUSTODY JUNE 1692
BRIDGET BISHOP	EXECUTED JUNE 10, 1692
REBECCA NURSE	EXECUTED JULY 19, 1692
SARAH GOOD	EXECUTED JULY 19, 1692
ELIZABETH HOWE	EXECUTED JULY 19, 1692
SARAH WILDES	EXECUTED JULY 19, 1692
SUSANNAH MARTIN	EXECUTED JULY 19, 1692
GEORGE BURROUGHS	EXECUTED AUGUST 19, 1692
MARTHA CARRIER	EXECUTED AUGUST 19, 1692
GEORGE JACOBS, SR.	EXECUTED AUGUST 19, 1692
JOHN PROCTOR	EXECUTED AUGUST 19, 1692
JOHN WILLARD	EXECUTED AUGUST 19, 1692
GILES COREY	PRESSED TO DEATH SEPTEMBER 19, 1692
MARTHA COREY	EXECUTED SEPTEMBER 22, 1692
MARY EASTY	EXECUTED SEPTEMBER 22, 1692
ALICE PARKER	EXECUTED SEPTEMBER 22, 1692
MARY PARKER	EXECUTED SEPTEMBER 22, 1692
ANN PUDEATOR	EXECUTED SEPTEMBER 22, 1692
MARGARET SCOTT	EXECUTED SEPTEMBER 22, 1692
WILMOT REDD	EXECUTED SEPTEMBER 22, 1692
SAMUEL WARDWELL, SR.	EXECUTED SEPTEMBER 22, 1692
ANN FOSTER	DIED IN CUSTODY DECEMBER 1692

"IT GRABS YOU FIERCELY BY THE THROAT IN THE VERY FIRST SCENE AND NEVER LETS GO."

HELEN G. VASSALO
DRAMATURG, PROFESSOR OF MANAGEMENT

SPECIAL THANKS

WE THE CAST AND CREW OF *THE CRUCIBLE* WOULD LIKE TO
THANK THE FOLLOWING PEOPLE:

SUSAN VICK
JESSICA SANDS
HELEN G. VASSALLO
WPI DEPARTMENT OF HUMANITIES AND ARTS
KRISTIN BOUDREAU, DEPARTMENT HEAD
JOANN MANFRA
JAMES P. HANLAN
MARY COTNOIR, MARGARET BRODMERKLE, AND KAREN HASSETT
KENNETH J. DANILA AND MARGARET SCHMIDT
LIZ TOMASZEWSKI
PAUL GIRARD
DIRAN APELLIAN
JANET AND JEFFREY H. POLLAK
TERRY PELLERIN
PENNY ROCK
WPI CHAPTER OF ALPHA PSI OMEGA, RHO KAPPA CAST
WPI LENS AND LIGHTS
WPI RECORDING CLUB
JOHN DELOREY AND THE WPI FESTIVAL CHORUS
THE ROBOTICS INTEREST GROUP
WPI OFFICE OF THE PRESIDENT
WPI OFFICE OF THE PROVOST
WPI OFFICE OF DEVELOPMENT AND UNIVERSITY RELATIONS
WPI FACILITIES
WPI STUDENT ACTIVITIES OFFICE

"I'VE REALIZED SEVERAL DREAMS ON THIS PRODUCTION: WORKING WITH 'STECH'
AGAIN, DOING SCENIC DESIGN AGAIN, DOING ARTHUR MILLER AGAIN, FINALLY
GETTING SOME RON MOTTS ABOUT THE LITTLE THEATRE CONSERVATORY STUDIO
INTO THE PROGRAM, WORKING WITH A COOL DIRECTOR AND A NICE PRO-
DUCER, AND OTHER STUFF. LIVE THEATRE AMAZES ME EVERY DAY. THIS IS THE
BEST CAST FOR THE BEST PLAY ON THE BEST SET WITH THE BEST COSTUMES AND
THE BEST LIGHTS AND SOUND AND THE BEST LIVE FEED AND THE BEST OF EVERY
THING IMAGINABLE. EVEN THE LAB WORKERS ARE THE BEST EVER."

SUSAN VICK
DIRECTOR OF THEATRE, CONSERVATORY PROJECT ADVISOR

ALPHA PSI OMEGA WPI CHAPTER — RHO KAPPA CAST

EACH SEMESTER THE WPI CHAPTER OF ALPHA PSI
OMEGA, THE NATIONAL THEATRICAL HONOR FRATER-
NITY, INDUCTS NEW MEMBERS INTO ITS RHO KAPPA
CAST. WE WOULD LIKE TO ANNOUNCE AND CON-
GRATULATE THE FOLLOWING INDUCTEES OF ITS B
TERM 2009 CLASS:

ELENA AINLEY
ANIKI BLODGETT
MEGAN FAULKNER
RICHARD LAMURA
BEN LAVERRIERE
TRISTAN SPOOR

THE INDUCTION CEREMONY WILL FOLLOW THE FRI-
DAY PERFORMANCE OF *THE CRUCIBLE*. ALL ARE IN-
VITED TO ATTEND AND RECOGNIZE THIS AWQ CLASS.

"IF YOU'RE ACTIVELY INVOLVED IN WPI THEATRE, THEN I'M SURE YOU KNOW
EACH OF THE INDUCTEES. IF YOU AREN'T, TRUST ME WHEN I SAY THAT THEY'RE
ALL PHENOMENALLY HELPFUL AND EACH WORTHY OF INDUCTION INTO THE
RHO KAPPA CAST. IF YOU SEE THEM AROUND, BE SURE TO GIVE THEM A HEARTY
CONGRATULATIONS."

ANDREW WILKINS
PRESIDENT OF ALPHA PSI OMEGA, RHO KAPPA CAST

COMING SOON

ALPHA PSI OMEGA — RHO KAPPA CAST PRESENTS
THE 7TH ANNUAL SHOW IN 24 HOURS
SATURDAY, DECEMBER 5, 8PM
LITTLE THEATRE

GUERRILLA IMPROV PRESENTS
ANOTHER (NOT) MURDER-MYSTERY SHOW
MONDAY, DECEMBER 7, 8PM
LOCATION TBD

KILROY SKITCH COMEDY PRESENTS
KILROY: BEDAZZLED!
FRIDAY, DECEMBER 11, 8PM
SL115 — KINNICUTT HALL

NULL SET PRESENTS
BEYOND/BEHIND THE IMPROV DOOR
SATURDAY, DECEMBER 12, 8PM
SL115 — KINNICUTT HALL

WPI DEPARTMENT OF HUMANITIES AND ARTS
AND MASQUE PRESENT
C TERM 2010 SHOW TBA
FEBRUARY 2010
LITTLE THEATRE

MW REPERTORY THEATRE CO. & ETC. PRESENTS
C TERM 2010 SHOW TBA
FEBRUARY 2010
LITTLE THEATRE

WPI DEPARTMENT OF HUMANITIES AND ARTS
AND MASQUE PRESENT
NEW VOICES 28
APRIL 2010
LITTLE THEATRE

SCRIPT DEADLINE
JANUARY 29, 2010
FOR SCRIPT SUBMISSION GUIDELINES, SEE
WWW.WPI.EDU/~THEATRE FOR MORE DETAILS

CORRECTIONS

THERE ARE A FEW CORRECTIONS TO THE PROGRAM:

DUE TO ILLNESS, THE ROLE OF REBECCA NURSE WILL
BE PLAYED BY ELIZABETH RUFFA.

ADDITIONALLY, THE SET CREW ALSO INCLUDES LIZ
CASEY, JULIE EAGLE, CHRISTOPHER KINGSLEY,
ZHAOCHEN LIU, COREY RANDALL, AUTUMN SILKE,
AND NATHANIEL VERLEE.

WE WOULD ASK THAT YOU DO NOT BRING ANY FOOD
OR DRINK INTO THE LITTLE THEATRE, AND THAT YOU
SILENCE YOUR CELL PHONES AND PAGERS. PHOTOG-
RAPHY IS NOT PERMITTED IN THE LITTLE THEATRE.

THANK YOU, AND ENJOY THE SHOW.

RICK DESILETS

FROM THE DIRECTOR

WELCOME TO THE LITTLE THEATRE. HERE WE ARE AT THE END OF THE FIRST DECADE OF THE 21ST CENTURY. CONGRATULATIONS, YOU'VE MADE IT! WHAT A TIME TO BE ALIVE. THE PLAY YOU ARE ABOUT TO SEE WAS WRITTEN 56 YEARS AGO AS FICTION BUT BASED ON TRUE EVENTS AND CENTERED AROUND AN IMPORTANT THEME - POLITICAL CRITICISM. ARTHUR MILLER CHOSE A TERRIBLE PERIOD IN AMERICAN HISTORY TO TELL HIS STORY, WHICH COULD BE WHY AUDIENCES THE WORLD OVER FIND *THE CRUCIBLE* TERRIBLY INTERESTING. IT WAS MY GOAL TO DELIVER A FRESH LOOK AT THIS AMAZING WORK WHOSE THEMES AND IDEAS REMAIN AS RELEVANT IN OUR MODERN AGE AS WHEN MILLER WROTE THEM UNDER THE RED SCARF, OR WHEN THEY WERE LIVED BY THE PEOPLE OF THE SALEM PROVINCE OVER 300 YEARS AGO.

THE GOVERNMENT HAS ALWAYS BEEN THREATENING. PEOPLE WILL ALWAYS PROTEST THE GOVERNMENT. WHAT I LEARN FROM THESE CHARACTERS IS THAT WE MUST HOLD TRUE TO OUR BELIEFS. OUR LIVES ARE OUR LIVES. GIVE OUT BUT DON'T GIVE UP. THOMAS JEFFERSON SAID "WHEN THE PEOPLE FEAR THEIR GOVERNMENT, THERE IS TYRANNY; WHEN THE GOVERNMENT FEARS THE PEOPLE, THERE IS LIBERTY." I THINK, LATELY WE HAVE HAD TOO MUCH TYRANNY AND NOT ENOUGH LIBERTY.

MY NOTE COULD NOT BE COMPLETE WITHOUT RECOGNIZING THE PEOPLE WHO AIDED AND SUPPORTED ME IN THE COMPLETION OF THIS PROJECT. I HAVE LEARNED MORE FROM MY WONDERFUL ADVISOR ABOUT DIRECTING A PRODUCTION AND MEETING THE INEXORABLE PUBLICATION DEADLINE THAN SHE MAY KNOW. THANK YOU, SUSAN - I AM HONORED TO HAVE APREHENDED UNDER YOU. NO DIRECTOR IS AN ISLAND - WHAT YOU ARE ABOUT TO EXPERIENCE IS THE RESULT OF A COMBINED EFFORT BETWEEN MYSELF AND THE PRODUCER, RICK. I AM GLAD I GOT TO WORK WITH YOU - AN AMAZING PRODUCER. I COULD NOT HAVE DONE IT WITHOUT YOU! I AM FORTUNATE TO HAVE SUCH A TALENTED CAST AND CREW. THANK YOU ALL FOR BEING PATIENT, RESPONSIVE AND UNDERSTANDING TO MY CREATIVE PROCESS. THIS SHOW WOULD NOT BE THE SAME WITHOUT YOU! FINALLY I WOULD LIKE TO THANK JESSICA SANDS FOR HER DEDICATION TO AND SUPPORT OF THIS PRODUCTION (LEAVING US ONLY TO HAVE A BABY) AND KINGSLEY FOR TAKING OVER - BOTH OF YOU ARE INCREDIBLE AND I AM SO GRATEFUL THAT YOU ARE PART OF THIS. WE HAVE ALL WORKED HARD AND YOU ARE ABOUT TO EXPERIENCE THE RESULT OF THAT INTENSE PROCESS. ENJOY THE SHOW!

STEVEN VESSELLA

NOTES ON A "CONSERVATORY PRODUCTION"

CAPRA OFFERED OF BEDFORD FALLS WITHOUT GEORGE BAILEY IN *IT'S A WONDERFUL LIFE* AND I PERK UP AND GET BACK TO WORK. I'M NO JAMES STEWART. I KNOW THAT, BUT IT MAKES ME FEEL USEFUL! SO NOW I'M WANTING SOMETHING I CAN'T EVEN PROPERLY DEFINE. THIS YEAR, A COLLEAGUE OF MINE ENCOUNTERED ME AROUND THE TIME THE MACARTHURS WERE ANNOUNCED. I TOLD HIM WHY I WAS SOMEWHAT BLUE. HE REPLIED WITHOUT PAUSE. "I THINK YOU SHOULD HAVE GOTTEN A MACARTHUR JUST FOR STARTING NEW VOICES AT WPI." WOW. SO SOME PEOPLE DO UNDERSTAND WHAT I AM DOING. I DIGRESS - IT'S A PRIMARY CHARACTER TRAIT, BUT I DIGRESS - WHAT IS A CONSERVATORY?

IT'S THAT PLACE WITH GLASS WALLS AND A ROOF WHERE PLANTS ARE GROWN OR DISPLAYED, OFTEN BUILT ONTO THE SIDE OF A HOUSE (ADAPTED FROM DICTIONARIES). OR "AN INSTITUTION OR SCHOOL WHERE STUDENTS ARE TAUGHT ONE OF THE ARTS, MOST COMMONLY MUSIC OR DRAMA, TO A *PROFESSIONAL STANDARD*" (ENCARTA DICTIONARY). WE'RE DEFINITELY ON THE SIDE OF THE HOUSE, AREN'T WE? THERE, I'VE DEFINED IT!

THE PROFESSIONAL STANDARD WE HAVE SET FOR STEVE, RICK, DAN, KOSTAS, ADRIANA, JAKE, Q, LINCOLN, AND OTHERS EARNING CREDIT FOR THIS PRODUCTION COMES FROM A COMMITMENT TO INTENSE, INDIVIDUAL INSTRUCTION FROM ALL THE DRAMA/THEATRE STAFF: SUSAN VICK, DIRECTOR OF THEATRE, PROFESSOR OF DRAMA/THEATRE; JESSICA SANDS, ADMINISTRATOR OF TECHNICAL THEATRE, DRAMA INSTRUCTOR; CHRISTOPHER KINGSLEY, ACTING ADMINISTRATOR OF TECHNICAL THEATRE (WHILE JESSICA IS AWAY ON MATERNITY LEAVE); JEFF ZINN, VISITING ACADEMIC PROFESSIONAL; AND DEAN O'DONNELL, INSTRUCTOR OF PLAYWRIGHTS WORKSHOP AND IMGD GURU. THE STUDENTS HAVE RESPONDED TO THE *PROFESSIONAL STANDARD* AND MADE US LOOK GREAT. HAVEN'T THEY? WOW, Y'ALL ROCK 'N ROLL. THANK YOU.

NOTES ON A "CONSERVATORY PRODUCTION"

I CALL MY CURRENT EDUCATIONAL EXPERIMENT *THE LITTLE THEATRE CONSERVATORY STUDIO*. THE TITLE MAY SEEM "HIGH-FALUTIN'", BUT IT'S WHAT I MEAN. I HAVE HAD SEVERAL BIG IDEAS FOR THE DRAMA/THEATRE PROGRAM OVER THE YEARS. A RECENT ONE HAD ME AND MY PERSONALLY-SELECTED TOUR GROUP DUCKING UNDER COLLAPSING CEILING TILES AND CRAWLING OVER OLD COOKING EQUIPMENT AS I TRIED TO CONVINCE THEM TO ENVISION THIS SPACE AS A THEATRE. THAT WORKED OUT PRETTY WELL. NOW I WANT TO USE THIS SPACE IN EDUCATIONALLY CREATIVE WAYS FOR OUR MAJORS, OUR MINORS, STUDENTS COMPLETING HUMANITIES AND ARTS REQUIREMENTS IN DRAMA/THEATRE, AND THE COMMUNITY THAT PARTICIPATES IN OR SIMPLY ENJOYS ATTENDING THEATRE PERFORMANCES AT WPI. A STUDENT WORKING WITH A PRODUCTION FOR CREDIT IS PART OF MY "CONSERVATORY". ABOUT A HUNDRED UNDERGRADUATES MAKE UP THE CURRENT CONSERVATORY ON THIS PRODUCTION. BUT WHAT'S A CONSERVATORY? AND WHY DO I WANT ONE?

FOR WANT OF A NAME, FOR ONE THING. IN MY EARLY YEARS HERE I FELT STARED AT BY MY WPI NEIGHBORHOOD, AS IF I WERE A VOLUNTEER WHO LIKED TO DO SHOWS IN THE MANNER OF THE JUDY GARLAND / MICKEY ROONEY "LET'S DO A SHOW" MOVIES. THAT I WAS A PROFESSOR SEEMED MERELY CURIOUS, AN ABERRATION. FURTHERMORE, I DON'T DO MOVIES, AND SOME OF YOU KNOW THAT PRETTY WELL. LET ME AT THIS POINT ACCEPT THE THANKS FROM ALL THOSE GROUPS, ORGANIZATIONS, AND PERFORMANCE PROGRAMS ON CAMPUS THAT GOT TO GROW AT WPI IN SOME MEASURE BECAUSE I HAD MADE IT VISIBLE AND POSSIBLE. EVERY YEAR WHEN I DON'T GET A MACARTHUR GRANT - AND I SERIOUSLY KEEP MY PHONE LINE FREE THE DAY OF THE ANNOUNCEMENT BECAUSE I BELIEVE I WILL ONE YEAR GET THE CALL - I GO INTO A BIT OF A DECLINE. THEN I REMEMBER THE BLEAK PICTURE - MOVIE MENTION AGAIN, BUT WORTH IT FOR THE QUICK FRAME OF REFERENCE - FRANK

NOTES ON A "CONSERVATORY PRODUCTION"

FINALLY, I DEDICATE THIS PRODUCTION AND ITS CONSERVATORY TO THE LATE JEAN BOLZ. JEAN SUPPORTED THEATRE AT WPI UNQUESTIONINGLY. I THINK SHE ENJOYED LIVE PERFORMANCES. I REMEMBER CLEARLY WHEN SHE AND DORIS HORGAN ARRIVED ONE DAY FOR A QUICK LOOK AT THIS NEW PLACE, AND - AFTER DORIS HAD GOTTEN MY KEY TO WORK - WHEN I OPENED THE DOOR, THERE WAS THE LITTLE THEATRE, SHINING NEW! THE THREE OF US JUST STOOD THERE STARING. I LIKE TO THINK IN THAT MOMENT WE SHARED THE GREATNESS OF IT ALL, AND I SHALL ALWAYS REMEMBER THAT MOMENT. I MISS YOU, JEAN. I WOULD LOVE FOR YOU TO SEE TONIGHT'S PERFORMANCE. YOU ARE THE BEST!

AND FINALLY, FINALLY... CONGRATULATIONS TO JESSICA SANDS AND BENJ LIPCHAK! FELICITY'S BROTHER HARRY ARRIVED ON NOVEMBER 6TH. ALL ARE WELL.

WHAT A WONDERFUL LIFE - TO COIN A PHRASE - ALL OF THE ABOVE, AND THANK YOU FOR COMING TO THE LITTLE THEATRE TONIGHT.

SUSAN VICK

Appendix I - Photos



The Mylar cross under blue color blasts



The Mylar cross under white light



The girls dancing under color blasts



Ultraviolet light cast on fluorescent paint



Costumes of many of the principal cast



The poppet and needle



White and red benches used throughout the show



Alex Rock, Minkyu Lee, Alex Geyster, Rob Matrow, Alex Daniels, Nick Teceno



*Catherine Coleman, Heidi Robertson, Anika Blodgett,
Kelsey Mawhiney, Holly Fletcher, Angela Simpson*



Tofer Carlson, Jon Kelly, Joshua Luther, Joel Sutherland



Bryan Rickard, Carol Wood

Appendix J – Play List

Bebel, Nick	<i>Blast Radius</i> <i>Risk Analysis</i> <i>The Spy in Size 4's</i> <i>Thinking of Going Home</i>
Bradbury, Ray	<i>Pillar of Fire</i>
Carlson, Tofer	<i>Glow</i> <i>A Letter Unsent</i> <i>A Prayer for Rain</i>
Carmichael, Fred	<i>Any Number Can Die</i>
Castonguay, Amy	<i>The PUNisher: The Play</i>
Ciaraldi, Michael	<i>First Draft</i> <i>Get Me to the Church on Time</i>
Churchill, Caryl	<i>Top Girls</i>
Darensbourg, Catherine	<i>Looking Glass</i>
Dawson, Elizabeth	<i>Happily Ever After</i>
Desilets, Rick	<i>The Morning After</i> <i>The Party Train</i>
DiGiovanni, Dominic	<i>Mad City, Inhabited</i> <i>Trusted Download</i>
Durang, Christopher	<i>Sister Mary Ignatius Explains It All For You</i>
Gilbert, W. S., and Arthur Sullivan	<i>The Mikado or, The Town of Titipu</i>
Goldman, William (adapted for stage by Castonguay, Amy)	<i>The Princess Bride</i>
Hansberry, Lorraine	<i>A Raisin in the Sun</i>

Harrower, Shannon	<i>Bower Bird, aka Crazies in Love</i> <i>Men Are from Oz, Women Are from Venus</i> <i>The Princess and the Body Snatchers</i> <i>Schrodiner's Cat in the Hat (fancy that!)</i> <i>Screw This Noise</i> <i>Sympathy for the Devil, Inc.</i>
Ibsen, Henrik	<i>A Doll's House</i>
Idle, Eric	<i>Monty Python's Spamalot</i>
Johnson, James	<i>Something in the Void</i>
Jones, Rolin	<i>Short Stack</i>
Jordan, Julia	<i>Dark Yellow</i>
Kanami	<i>Matsukaze</i>
Kander, John, and Fred Ebb	<i>Chicago</i>
Kaufman, George S.	<i>The Still Alarm</i>
Kaufman, Moise	<i>Gross Indecency: The Three Trials of Oscar Wilde</i> <i>The Laramie Project</i>
Kelly, Dennis	<i>Love and Money</i>
Larson, Jonathan	<i>Rent</i>
LaVerriere, Ben	<i>Thirty-Six Situations</i>
Lindsay-Abaire, David	<i>Rabbit Hole</i>
Lopez, Robert, and Jeff Marx	<i>Avenue Q</i>
Mamet, David	<i>Glengarry Glen Ross</i>
Massa, Edmund	<i>Love, Love, Love: Three Stories of Love</i>

Massa, Edmund (cont'd)	<i>Memory Card</i>
Medeiros, Nicholas	<i>All the Truth</i>
Miller, Arthur	<i>The Crucible</i>
Nachtrieb, Peter Sinn	<i>Hunter Gatherers</i>
Nakama, Adam	<i>How to Meet Girls, for Voice Actors</i> <i>Walt and Wilde</i>
O'Donnell, Dean	<i>Mother of Invention</i>
Osborn, Christopher	<i>Lumberknight: The Francophone Protocol</i>
Pavis, Richard	<i>Harlequin</i> <i>Infected</i> <i>The Secret of Water</i> <i>Sudden Silence, Sudden Heat</i>
Pavis, Sarah	<i>Shot in the Heart</i>
Pirandello, Luigi	<i>Six Characters in Search of an Author</i>
Rahman, Aishah	<i>Mojo and the Sayso</i>
Rodgers, Richard, and Oscar Hammerstein II	<i>South Pacific</i>
Royal, Bert V.	<i>Dog Sees God: Confessions of a Teenage</i> <i>Blockhead</i>
Russell, Stephen	<i>Daisy Crockett: Frontiersperson! or Be Sure</i> <i>You're Right, Then Go Ahead</i>
Scarborough, Aubrey	<i>Discourses on a Girl</i>
Sedaris, Amy, and David Sedaris	<i>The Book of Liz</i>
Shakespeare, William	<i>Romeo and Juliet</i> <i>The Taming of the Shrew</i>

Shakespeare, William (cont'd)	<i>The Tragedy of Hamlet, Prince of Denmark</i> <i>The Tragedy of Macbeth</i>
Shepard, Sam	<i>Curse of the Starving Class</i>
Smith, Anna Deveare	<i>Fires in the Mirror</i>
Sondheim, Stephen, and George Furth	<i>Company</i>
Sondheim, Stephen, and Hugh Wheeler	<i>Sweeney Todd, the Demon Barber of Fleet Street</i>
Sophocles	<i>Oedipus Rex</i>
Sterhelm, Carl (adapted by Martin, Steve)	<i>The Underpants</i>
Stewart, Michael, and Mark Bramble	<i>42nd Street</i>
Vessella, Steven	<i>The Change</i> <i>To Stop</i>
Webber, Andrew Lloyd	<i>Phantom of the Opera</i>
Wilder, Thornton	<i>Our Town</i>
Williams, Tennessee	<i>A Streetcar Named Desire</i>
Zagone, Nick	<i>Smoke Scenes</i>

Appendix K - Work Log

Date	Hours	Purpose
<i>A Term 2009</i>		
09/21/09	0:20	Email correspondence
09/24/09	1:30	Meeting with advisor
09/25/09	3:20	Email correspondence
09/26/09	0:10	Email correspondence
09/27/09	0:20	Email correspondence
09/28/09	0:30	Email correspondence
09/29/09	1:20	Email correspondence
09/30/09	1:10	Email correspondence
10/01/09	1:30	Meeting with advisor
	2:10	Email correspondence
10/02/09	3:40	Email correspondence
10/03/09	4:00	Reading <i>The Crucible</i>
	2:20	Email correspondence
10/04/09	1:00	Creating audition forms
	2:00	Email correspondence
10/05/09	3:00	Theatre Faire
	2:00	Email correspondence
10/06/09	3:30	Email correspondence
	3:00	Auditions
10/07/09	0:30	Email correspondence
	3:00	Auditions
10/08/09	1:30	Meeting with advisor
	3:40	Email correspondence
10/09/09	0:20	Email correspondence
	2:00	Callbacks
10/10/09	1:20	Email correspondence
10/11/09	4:10	Email correspondence
10/12/09	6:00	Email correspondence
10/13/09	2:20	Email correspondence
	1:00	Production Meeting
	3:00	Readthrough
10/14/09	1:10	Email correspondence
10/15/09	1:30	Meeting with advisor
10/16/09	0:30	Email correspondence
10/18/09	0:20	Email correspondence
10/19/09	0:40	Email correspondence
10/20/09	3:30	Email correspondence

10/21/09	0:40	Email correspondence
10/22/09	0:20	Email correspondence
10/23/09	0:50	Email correspondence
10/25/09	2:20	Email correspondence

B Term 2009

10/26/09	1:00	Teleconference with Stechmann
	3:30	Email correspondence
	3:00	Rehearsal
10/27/09	3:10	Email correspondence
10/28/09	1:10	Email correspondence
	3:00	Rehearsal
10/29/09	3:10	Email correspondence
	1:00	Production Meeting
10/30/09	3:20	Email correspondence
	2:00	Rehearsal
10/31/09	2:20	Email correspondence
11/01/09	0:10	Email correspondence
11/02/09	4:40	Email correspondence
	3:00	Rehearsal
11/03/09	3:40	Email correspondence
11/04/09	1:40	Email correspondence
	3:00	Rehearsal
11/05/09	5:30	Email correspondence
	1:00	Production Meeting
11/06/09	2:00	Email correspondence
	2:00	Rehearsal
11/07/09	0:20	Email correspondence
11/08/09	1:00	Email correspondence
11/09/09	5:40	Email correspondence
	3:00	Rehearsal
11/10/09	4:40	Email correspondence
11/11/09	2:00	Email correspondence
	3:00	Rehearsal
11/12/09	3:30	Email correspondence
	1:00	Production Meeting
11/13/09	5:20	Email correspondence
	3:00	Rehearsal
11/14/09	1:00	Email correspondence
11/15/09	5:00	Cue to Cue

	2:20	Email correspondence
11/16/09	8:50	Email correspondence
	4:00	Tech Rehearsal
11/17/09	2:50	Email correspondence
	4:00	Tech Rehearsal
11/18/09	4:10	Email correspondence
	4:00	Preview
11/19/09	6:10	Email correspondence
	4:00	Performance
11/20/09	5:10	Email correspondence
	4:00	Performance
11/21/09	0:20	Email correspondence
	4:00	Performance
	2:00	Strike
11/23/09	0:40	Email correspondence
11/24/09	0:20	Email correspondence
12/03/09	0:20	Email correspondence
12/09/09	0:20	Email correspondence
12/10/09	0:40	Email correspondence
12/14/09	0:10	Email correspondence
12/17/09	1:00	Writing MQP paper
	0:40	Email correspondence
12/22/09	0:10	Email correspondence

C Term 2010

01/12/10	0:10	Email correspondence
01/13/10	0:30	Email correspondence
01/14/10	1:00	Meeting with advisor
01/21/10	1:00	Email correspondence
01/22/10	1:00	Writing MQP paper
	1:00	Meeting with advisor
	0:40	Email correspondence
01/28/10	0:30	Email correspondence
01/29/10	2:00	Writing MQP paper
	1:00	Meeting with advisor
01/30/10	1:00	Writing MQP paper
01/31/10	1:00	Meeting with advisor
	7:00	Writing MQP paper
02/01/10	2:00	Writing MQP paper
	1:00	Meeting with advisor

02/02/10	1:00	Meeting with advisor
02/04/10	3:00	Writing MQP paper
	1:10	Email correspondence
02/05/10	1:00	Meeting with advisor
	0:10	Email correspondence
02/08/10	0:10	Email correspondence
02/09/10	1:00	Writing MQP paper
	1:00	Meeting with advisor
	1:20	Email correspondence
02/11/10	0:30	Meeting with advisor
	1:30	Email correspondence
02/12/10	1:00	Meeting with advisor
	2:30	Writing MQP paper
	0:50	Email correspondence
02/15/10	1:00	Writing MQP paper
	1:00	Meeting with advisor
	0:10	Email correspondence

Total Hours: 077:30 A Term, 2009

152:00 B Term, 2009

039:10 C Term, 2010

Grand Total: 268:40

Appendix L – Resume

Stage Performance

Production	Role	Company
Birds of a Feather (2009)	Rick	Alpha Psi Omega, Rho Kappa Cast
Pillar of Fire (2009)	First Officer, Third Reader	MW Repertory Theatre Company & Etc.
A Letter Unsent (2009)	Rick	WPI Masque, New Voices 27
Dog Sees God: Confessions of a Teenage Blockhead (2009)	Matt	MW Repertory Theatre Company & Etc.
That's Not a Thing	Rick	Alpha Psi Omega, Rho Kappa Cast
Intervention	Rick	Alpha Psi Omega, Rho Kappa Cast
Gross Indecency: The Three Trials of Oscar Wilde (2008)	Marquess Queensberry, Mavor, Lockwood	WPI Masque
Bower Bird aka Crazies in Love (2008)	Jay	MW Repertory Theatre Company & Etc.
Risk Analysis (2008)	John	Sunburns Theatre Company
Thinking of Going Home (2008)	Josh	Sunburns Theatre Company
The Princess Bride (2008)	Narrator	Sunburns Theatre Company
Sudden Silence, Sudden Heat (2008)	Marcus	WPI Masque, New Voices 26
Sofa King KILROY (2007)	Mat Highland	KILROY sketch comedy
Harlequin (2007)	Leontes, Oliver, Corin	Sunburns Theatre Company
The Laramie Project (2005)	Moisés Kaufman, Shannon, Gomez	Bishop Guertin High School Drama Club
The Crucible (2005)	Marshall Herrick	Bishop Guertin High School Drama Club

Film Performance

Production	Role	Company
Something Remote (2009)	Mat Highland (11 episodes)	Broken Wall Films
Army of Darkness: Sweded (2009)	Wise Man, Commoner 3	Broken Wall Films
Something Remote (2009)	Mat Highland	Broken Wall Films
Comedy Wears a Tie (2008)	Simon Deckerd	{ Empty Set }

Writing

Production	Company
The Party Train (2010)	WPI Masque, New Voices 28
Bird's-Eye View (2009)	Alpha Psi Omega, Rho Kappa Cast
That's Not a Thing (2008)	Alpha Psi Omega, Rho Kappa Cast
The Morning After (2008)	Sunburns Theatre Company

Dramaturgy

Production	Company
New Voices 28 (2010), Associate Executive Dramaturg	WPI Masque, New Voices 28
Schrödinger's Cat in the Hat (fancy that!) (2009)	WPI Masque, New Voices 27
Discourses on a Girl (2008)	Sunburns Theatre Company

Production Roles

Production	Position	Company
2010 Comedy Festival (2010)	Co-Producer	WPI Student Comedy Productions
Student Comedy Action Team (2010)	Co-Director	WPI Student Comedy Productions
Rabbit Hole (2010)	Poster Designer	MW Repertory Theatre Company & Etc.

The Crucible (2009)	Producer	WPI Masque
The Schlubs of Comedy (2009)	Host	WPI Student Comedy Productions
Men Are from Oz, Women Are from Venus (2009)	Stage Manager	WPI Masque, New Voices 27
Running with Scissors: Support Your Local EMS! (2008)	Host	WPI Student Comedy Productions
A Series of Progressively More Abstract Sketches on Kittens (And Their Importance in Stimulating Our Economy) (2008)	Stage Manager	KILROY sketch comedy
Summer Sunburns Showcase (2008)	Producer	Sunburns Theatre Company
Laughtrack: America Runs on Comedy (2008)	Producer, Host	WPI Student Comedy Productions
The PUNisher: The Play	Assistant Director	WPI Masque, New Voices 26
Insert Coin to Continue (2008)	Producer	KILROY sketch comedy
The Underpants (2008)	Soundboard Operator	WPI Masque
Sofa King KILROY (2007)	Chief Editor	KILROY sketch comedy
Romeo & Juliet (2007)	Video Operator	WPI Masque
Curse of the Starving Class (2007)	Property Crew	MW Repertory Theatre Company & Etc.