

Brutalist Building Retrofit

Worcester Polytechnic Institute

A Major Qualifying Project
Submitted to the Faculty
of the
WORCESTER POLYTECHNIC INSTITUTE
in partial fulfillment of the requirements for the
Degrees of Bachelor of Science in Architectural Engineering

March 23, 2018

By:
Priscilla Dunphy
Steven Knott
Katherine Tattersall

Advisors:
Professor M. Farzinmoghdam
Professor H. Saleem
Professor S. Van Dessel

*This report represents work of WPI undergraduate students
submitted to the faculty as evidence of a degree requirement.*

WPI routinely publishes these reports on its web site without editorial or peer review.

*For more information about the projects program at WPI, please see
<http://www.wpi.edu/academics/ugradstudies/project-learning.html>*

Acknowledgements

We would like to thank our advisors, Professors Steven Van Dessel, Mohamad Farzinmoghadam and Hussam Saleem for the guidance throughout the duration of our project. Thank you to Helena Currie at Simpson, Gumpertz & Heger for advising us and her company for sponsoring our project. We would also like to thank the University of Massachusetts at Amherst (UMass Amherst) for giving us access to their files on the Fine Arts Center. Lastly, we would like to thank WPI's Facilities Department for allowing us to access their archived files on the Gordon Library.

Capstone Design Statement

All Design Team members are Architectural Engineering (AREN) majors with structural concentrations. We performed extensive structural analyses on two different buildings. For one of the buildings, we used the existing applied loads on and strength of the structure to design a rooftop art gallery with special consideration for large sculptures with specific guidelines as to how heavy the sculptures are allowed to be. We also considered other areas within our major besides structural engineering. We considered fire protection engineering when we created means of egress from the rooftop, and building envelope engineering when we designed a new waterproofing roof system for the rooftop. The sculpture garden was designed to fit within the existing Fine Art Center (FAC) and our concept. The art garden's function is to display art, models, and sculptures made by students who study in the FAC. We designed the means of egress and elevator to be integrated nicely with the exposed concrete façade of the FAC, as well as improve circulation around the FAC. At the same time, we aimed to avoid blocking any views from inside the FAC. We all acted as designers on this project. The various disciplines were intertwined on this project and were split up in such a way that we had to communicate with each other to understand each other's results and utilize them in various parts of the project. For instance, for Building B, the results of the roofing design were included in the structural design because the structure has to support the new roofing system. The main computer-based technologies we used for this project were Autodesk's AutoCAD, Revit, and RISA. We used AutoCAD to transfer the original hand drawings to computer drawings and draw details. We used Revit to model the FAC and the new design in 3D, and RISA to aid in our structural analysis. We referenced multiple building codes as part of this project, including the 2012 International Building Code (IBC) and the American Society of Civil Engineers (ASCE) 7-10. We considered the FAC's energy performance when we designed the new roofing system. We considered sustainability by working with an existing building and making as few changes to it as possible, therefore minimizing materials.

Abstract

The objective of this project was to design a rooftop art gallery with special considerations for large sculptures for the University of Massachusetts at Amherst's Fine Arts Center (FAC). The FAC is an exposed concrete, Brutalist building completed in 1973 that was designed by Kevin Roche, John Dinkeloo, and Associates. It is composed of a series of interconnected buildings. We conducted a visual inspection of the FAC by visiting the site of interest, performed a structural analysis for two of the interconnected buildings, and designed a rooftop art gallery for Building B. While designing the art gallery, we analyzed the structure under the new loads, designed a new waterproofing roof system, and incorporated new means of egress and an elevator that would allow access to the roof.

Executive Summary

In this project, we designed a rooftop art gallery for the University of Massachusetts at Amherst's Fine Arts Center (FAC). The FAC is an exposed concrete, Brutalist building that was completed in 1973 designed by Kevin Roche, John Dinkeloo, and Associates. It consists of a series of interconnected buildings separated by department or purpose. It houses the Art and Music departments and includes several auditorium spaces as well as classrooms, art studios, and offices. We primarily focused on two of these buildings, the Art Studio Building and the Art Building (Building B). We designed a rooftop art gallery only for Building B with special consideration for large sculptures. Case studies of similar buildings in Massachusetts and the architecture of the FAC itself inspired our project. We conducted a visual inspection of the FAC during a site visit, primarily focusing on the Art Studio Building. Using the original drawing set, we performed structural analyses for both of these buildings, considering both gravity and lateral loads. We also created a separate load combination for the new design's applied loads for Building B. We used this structural analysis to determine the allowable weight of the sculptures on the roof. As part of our new design, we chose new roofing materials, including insulation, waterproofing, and raised pavers to allow water to drain. We also considered fire protection codes, accessibility, and the architectural design of the FAC to design new staircases and a new elevator.

Table of Contents

Acknowledgements.....	1
Capstone Design Statement.....	2
Abstract.....	3
Executive Summary.....	4
Table of Contents.....	5
List of Figures	7
List of Tables	9
Introduction	10
Background	12
Modern Architecture in the 1960s and 1970s	12
Preservation of Exposed Concrete Buildings	12
Brutalism	13
Case Studies	14
Carpenter Center	14
Goddard Library	16
Smith Campus Center	17
Gordon Library	19
East Hall.....	21
The Fine Arts Center	22
Methodology.....	28
Documents Review – Existing Drawings and Files	28
Site Visit	28
Fire Code Requirements	29
Structural Analysis - Art Studio Building	30
Vertical Loads.....	31
Lateral Loads	38
Vertical and Lateral Loads.....	39
Structural Analysis - Building B	42
Columns	44
Beams.....	46
Walls.....	47

Lateral Loads Analysis	48
Footings.....	49
Roof Slab	51
New Design	52
Analysis and Results.....	54
Site Visit	54
Structural Analysis – Art Studio Building	63
Structural Analysis – Building B.....	64
New Design	74
Concept.....	74
Circulation.....	80
Evacuation Plan.....	83
Waterproofing Roof System	84
Conclusions and Recommendations.....	88
Bibliography	89
Appendix A – Typical Structural Details, Notes, and Schedules	94
Appendix B – Original Art Studio Drawings	98
Appendix C – Original Building B Drawings and Schedules.....	101
Appendix D – Site Visit Observations.....	0
Appendix E – Art Studio Design Capacity Calculations	0
Appendix F – Art Studio Wind Combination Calculation	5
Appendix G– Art Studio Seismic Calculations	6
Appendix H – Building B Structural Analysis.....	9
Appendix I – Building B Waterproofing Details	43
Appendix J – Building B Waterproofing Product Data Sheets	1
Appendix K – Building B Weight of New Roof Calculation.....	24

List of Figures

Figure 1: FAC layout.	10
Figure 2: An image of the Carpenter Center in 1963 from the Harvard Archives Collection.	15
Figure 3: Exterior photograph of Goddard Library.	17
Figure 4: The Smith Campus Center.	19
Figure 5: The front of the Gordon Library.....	20
Figure 6: Grid layout of planters on East Hall's green roof.	21
Figure 7: UMass Amherst campus map. The FAC in located in region 4C, just south of the campus pond.	23
Figure 8: FAC building layout.	24
Figure 9: FAC First Floor Plan.	24
Figure 10: Fine Art Center, East elevation, showing Art Studio Building (left), and Building B (right).	26
Figure 11: Section through the bridge showing the North wall and the hallway on the left, and the studio and South wall on the right.....	26
Figure 12: Fine Art Center, North elevation. The windows of the Art Studio are in the back of the center.	27
Figure 13: Art Studio Building East elevation.....	31
Figure 14: Load transfer of the Art Studio Building structural members.	32
Figure 15: Triangle roof area.....	33
Figure 16: Art Studio triangle roof area moment diagram.	34
Figure 17: Art Studio triangle roof area shear diagram.	34
Figure 18: Art Studio roof moment diagram.	34
Figure 19: Art Studio roof shear diagram.	35
Figure 20: Elevation of North wall/beam - West half illustration the rebar used in the column panels....	35
Figure 21: Colum wall panel overall moment diagram.....	36
Figure 22: Column wall panel moment diagram of the East end.	37
Figure 23: Section C1-11 of the Art Studio rib.	37
Figure 24: Rib moment design capacity diagram.....	38
Figure 25: Art Studio split into three parts for wind load analysis.	39
Figure 26: Outline of the Art Studio support columns.....	40
Figure 27: Footing reinforcement of the support columns.	42
Figure 28: Section view of Building B with floor breakdown.....	43
Figure 29: Example drawing displaying load transfers through columns to the first floor beams.....	45
Figure 30: Applied moment of beam BB-13 modeled in Risa-2D.	47
Figure 31: Simply supported beam with two point loads.....	51
Figure 32: Art Studio elevations.....	54
Figure 33: Cross-Section C1-1 showing the exterior (below the green line) and interior (above the green line) layers of the Art Studio floor.	57
Figure 34: East elevation entrance ramp outlined by the red box.	58
Figure 35: Art Studio Building fourth floor plan.	62
Figure 36: North-facing window and acoustic panels inside one of the studios.	63
Figure 37: Wind load combination results.....	64

Figure 38: Roof framing plan showing zones.....	70
Figure 39: Roof plan showing revised zones.....	73
Figure 40: Aerial view of the Fine Arts Center.....	75
Figure 41: Site plan of Building B highlighting its three means of egress and elevator.....	77
Figure 42: General rendering of Art Studio Building and Building B with new design.....	78
Figure 43: Closer view of access points on North wall.....	79
Figure 44: Closer view of means of egress on East wall.....	79
Figure 45: Closer view of a rooftop design layout example.....	80
Figure 46: Circulation plan of the Northern stairs and elevator.....	81
Figure 47: Circulation plan of the Eastern spiral staircase.....	82
Figure 48: Circulation plan of occupants underneath Art Studio Building.....	83
Figure 49: Two example scenarios for occupant evacuation in the event of a fire or other hazard.....	84
Figure 50: The layers of the new waterproofing roof system.....	85
Figure 51: Detail showing how the waterproofing system terminates at the edge parapet.....	86
Figure 52: Key for structural drawings.....	94
Figure 53: General notes on the FAC.....	95
Figure 54: Typical wall footing detail.....	97
Figure 55: Art Studio South wall reinforcement.....	98
Figure 56: Cross Section of the main body of the Art Studio.....	98
Figure 57: Part of the Art Studio North wall elevation.....	99
Figure 58: Part of the Art Studio floor framing plan showing placement of ribs.....	100
Figure 59: Original roof framing plan.....	101
Figure 60: Original third floor framing plan.....	102
Figure 61: Original second floor framing plan.....	103
Figure 62: Original first floor framing plan.....	104
Figure 63: Original library level framing plan.....	105
Figure 64: Original storage level framing plan.....	106
Figure 65: Original ground floor framing plan and foundation plan.....	107
Figure 66: Key and notes for the following framing plans.....	9
Figure 67: Roof framing plan.....	10
Figure 68: Third floor framing plan.....	11
Figure 69: Second floor framing plan.....	12
Figure 70: First floor framing plan.....	13
Figure 71: Library floor framing plan.....	14
Figure 72: Storage floor framing plan.....	15
Figure 73: Ground floor framing plan and foundation plan.....	16

List of Tables

Table 1: Cracks Observed	55
Table 2: Spalls and General Deterioration	57
Table 3: Exposed Rebar and Past Repairs	59
Table 4: Heavy Staining and Efflorescence	60
Table 5: Art Studio Structural Analysis Results	63
Table 6: Applied Loads and Load Capacities for Columns in Building B.....	65
Table 7: Applied Moments and Moment Capacities for Beams in Building B	66
Table 8: Summary of Wind Loads	66
Table 9: Seismic Analysis Summary	67
Table 10: Column Footing Results	68
Table 11: Maximum Allowable Axial Loads in Each Zone	71
Table 12: Members in More Than One Load Path	71
Table 13: Revised Zones.....	72
Table 14: Strength of Roofing Materials	74
Table 15: Weight of New Roofing Layers	87
Table 16: Minimum reinforcement schedule for walls and slabs.....	96
Table 17: Wall footing schedule.....	97
Table 18: Column schedule.....	108
Table 19: Beam schedule.....	109
Table 20: Column footing schedule.....	110
Table 21: Summary of Current and New Design Applied Loads on all Columns	19
Table 22: Summary of Current and New Design Applied Moments on all Beams	20
Table 23: Summary of Load Capacities for All Columns	22
Table 24: Summary of Moment Capacities of All Beams.....	24
Table 25: Building B Wall Applied Loads and Strengths	25
Table 26: Building B Wind Analysis	28
Table 27: Slab Weights.....	31
Table 28: Seismic Analysis, Step 8.....	32
Table 29: Seismic Analysis, Step 10, Part 1	32
Table 30: Seismic Analysis, Step 10, Part 2	32
Table 31: Seismic Analysis, Step 10, Part 3	33
Table 32: Seismic Analysis, Conclusion	33
Table 33: Column Footing Applied Loads	33
Table 34: Strength Calculations, Footings BF-1 through BF-4	34
Table 35: Strength Calculations, Footing BF-5	34
Table 36: Strength Calculations, Footing BF-6.....	34
Table 37: Wall Footing Applied Loads and Capacities	35
Table 38: List of Layers used in new waterproofing roof design	1

Introduction

When Simpson, Gumpertz & Heger (SGH) was assigned to be our sponsor, they suggested multiple proposals for what our MQP project, starting from projects that they were working on at the time. All suggested projects involved historic preservation and had significant structural components. The proposal that we initially chose was to design a rooftop terrace for the Smith Campus Center at Harvard University. We were interested in creating an occupied green roof, or some other sort of gathering space, that would be inviting to Harvard's visitors and the public. We ended up basing our project on the Fine Arts Center (FAC) at UMass Amherst instead, and using the Smith Campus Center as a case study and source of inspiration. If we had chosen to work on the Smith Campus Center, we would likely have focused most of our efforts on the roofing of the structure. Working with the FAC, allowed us to focus most of our efforts on the structural aspects, which was beneficial because we all have concentrations in Structural Engineering. The layout of the FAC is shown in the following figure.

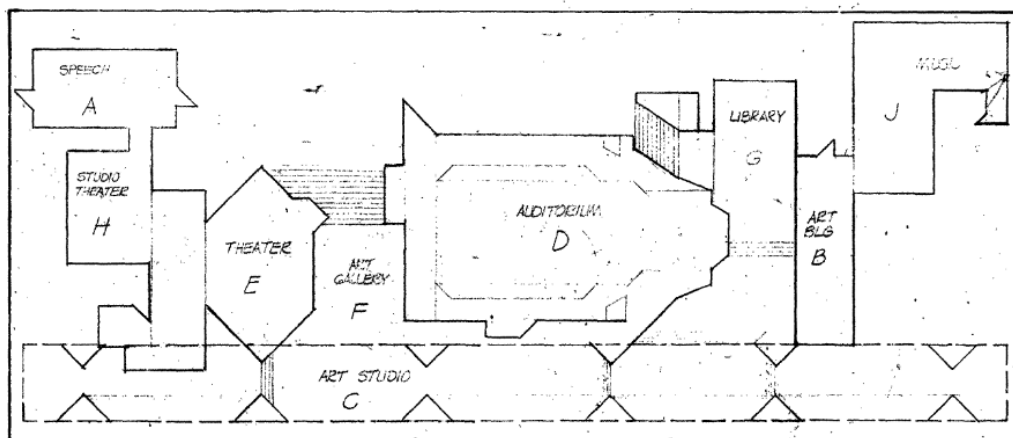

Figure 1: FAC layout.

Kevin Roche John Dinkeloo and Associates 1970, drawing S01.

We discussed where we could put this green roof or gathering space, and what kind of purpose it would serve. Initially, we investigated the Art Studio Building by performing a visual inspection and structural analysis, but later decided against altering it in our new design. We decided to create an art

gallery that would display sculptures and other art pieces created by UMass Amherst students on top of the building that houses the Art department (Building B). The desired function of this space was to act as an extension of the building and make it easily accessible by both the UMass Amherst community and public. In order to design this space, we performed a structural analysis of Building B, both under the existing load case and under the load case after the new design would be implemented. We also designed a new waterproofing roof system for the building to improve the energy performance of the building and protect the roof from water infiltration and ponding. We included two staircases and a freight elevator in our design to improve circulation, provide means of egress, allow handicap access, and provide a means of transporting the sculptures to the roof. We used structural analysis of the existing structure with the new roofing system to determine the weight and placement of the sculptures.

Background

This section first discusses Modern architecture around the time that the FAC was built. It covers the preservation of these buildings, as well as more information about Brutalism, which is the style of the FAC. Next, we discuss several case studies. Most of the case studies are concrete buildings that were built in the same time period as the FAC, except one newer building that has an example of a green roof. Lastly, we study the FAC itself.

Modern Architecture in the 1960s and 1970s

Modern architecture in the 1960s and 1970s mainly focused on function and space compared to decoration. Typically, buildings are designed in pure geometric forms with planar surfaces. There are no ornaments or special decorations on the frames, doorways, or other exterior areas. There is a straightforwardness to the style with a clean and bare look. Industrial material and products are generally used such as reinforced concrete.¹

Preservation of Exposed Concrete Buildings

Many exposed concrete buildings built in the 1960s and 1970s have significant maintenance and preservation issues because the structure is often left exposed to the elements. During the Modernist movement, buildings were not designed to last, and designers often used experimental materials and construction techniques. Only now are some of these concrete buildings being considered historic and worth saving. To maintain the character, historic preservation societies expect minimal change to be made of historic buildings, so preserving their authenticity becomes a major challenge when attempting to renovate or rehabilitate them. The majority of what makes modern architecture unique is deteriorating and/or no longer suitable for today's needs. Additionally, most of these buildings are not

¹ Carrie Ann Pukerson, "Historic Preservation of the Recent Past," (master's thesis, University of Florida, 2007).

energy-efficient or watertight. Comprehensive repair campaigns for these buildings are, therefore, multidisciplinary in nature.²

Brutalism

Brutalism uses uncoated, exposed concrete facades. The structure is visible and the means of construction are evident and architecturally significant. Brutalist buildings have a feeling of weight, solidity, and massiveness. They are monumental buildings, often both dwarfing and standing out visually compared to the buildings around them. Windows cut into the mass of the building, and mechanical, electrical, and plumbing (MEP) systems are often left visible. A rough texture is sometimes added to the concrete before it cures. Generally, Brutalist facades are entirely concrete but can include other materials, such as brick.³ The Brutalist style emerged in Britain post-World War II in response to the countries wartime experience. When the style came to America, its original meaning changed and Brutalist buildings became more monumental. The tragic post-war feeling of Britain changed to a feeling of power from the young and strong United States⁴. Paul Rudolph was one of the foremost developers of Brutalism. His Art & Architecture (A&A) Building at Yale University (now called Rudolph Hall) is one of his most famous buildings. It features a material Rudolph called "corrugated concrete" because of its resemblance to cardboard packing material. Vertical ridges in the concrete were hammered to expose the aggregate.⁵

Brutalism is a fairly divisive architectural style. Those who dislike it say it stands out and does not integrate well with the surrounding buildings, the Smith Campus Center of Harvard University being one example. Additional problems with the style include various aesthetic issues with exposed surfaces,

² Ibid., 9-10, 38, 52.

³ Marcus Whiffen, *American Architecture Since 1780: A Guide to the Styles* (Cambridge, MA: The MIT Press, 1969), 275, 279.

⁴ Pukerson 2007.

⁵ Timothy M. Rohan, *The Architecture of Paul Rudolph* (New Haven, CT: Yale University Press, 2014), 248-249, 93, 244.

such as efflorescence staining concrete structures over time. The following case studies represent the different aspects of Brutalist Architecture of the Northeast.

Case Studies

The case studies we chose are the Carpenter Center, the Goddard Library, the Smith Campus Center, the Gordon Library, and East Hall. All of these buildings are academic buildings located in Massachusetts. East Hall is a case study of a green roof, which is featured in our new architectural design. All other case studies are either Modern or Brutalist buildings that were built in the 1960s or 1970s. We studied how buildings of this age have deteriorated over time, types of renovations necessary to extend the lifespan of these buildings, and types of renovations completed to alter their uses. We used these case studies as inspiration for how to make the Fine Arts Center more inviting.

Carpenter Center

The Carpenter Center located at Harvard University in Cambridge, MA is a prime example of modern architecture deteriorating overtime in the Northeast. Completed in 1963, the Carpenter Center is the only building in the United States designed by Le Corbusier. Le Corbusier is one of the leading architects in the modernist movement who found a new way to shape space. The Carpenter Center is well over fifty years old and has been exposed to the rain, wind, and snow common throughout the Northeast. Heavy staining is visible on the exposed concrete of the building and some areas are even stained black. A curved concrete ramp, as seen in Figure 2, connects the public walkways to the building's entrance. The ramp's incline, however, is too steep to be adequately handicap-accessible and creates daunting shadows below. The building also stands out in comparison to the surrounding

buildings that follow a classic Georgian Revival architectural style.⁶ The true beauty of the building, as with many modern architecture, is not obvious.



Figure 2: An image of the Carpenter Center in 1963 from the Harvard Archives Collection.

Campbell, 2013. Photo by Stephanie Mitchell.

The purpose of the Carpenter Center is to act as a combination of art; where students can combine architecture with painting, sculpture, photography, and film. Natural light is used to illuminate the interior. The classrooms are placed inside to create a feeling that the students are floating above the Harvard yard. The use of space and light throughout the interior of the building is meant to create a comfortable place for students to unlock their creativity. Unfortunately, the exterior masks the true purpose and beauty of the building. The dark entrance, the sharp edges of the building, and the clash of architectural style with the surrounding buildings are all popular complaints about the Carpenter Center.

⁶ Bradley Campbell, "The Ugliest Building on Harvard's Campus just might be its most Beautiful," PRI's The World, September 29, 2013. <https://www.pri.org/stories/2013-09-29/ugliest-building-harvards-campus-just-might-be-its-most-beautiful>.

With time the community has gotten use to seeing the large concrete Carpenter Center⁷. However, time has not soften the sharp edges or lighten the dark edges, instead the deterioration of time has only added to the unappealing aesthetics of the building.

Goddard Library

The Goddard Library is a piece of architecture located on the Clark University campus in Worcester, MA. Designed by John M. Johansen of Perry Dean Rogers Partners Architects, the Goddard Library was constructed in 1969. Four decades later, the building was renovated by Consigli Construction. The main purpose of the renovation was to update the HVAC systems. These systems had poor air ventilation, air quality, climate control, and energy performance. Additionally, the building serves as a hub for campus utilities, therefore utility upgrades needed to be coordinated to account for this. Aside from updating the mechanical systems, new program areas were designed to encourage new opportunities at the university, such as computer labs, study areas, and a café.⁸ A wind tunnel originated outside of this building, but had to be closed in order to allow for the myriad of renovations to be completed.

The goal of these renovations was to introduce new technological, programmatic, and space requirements to a historic structure without drastically changing the exterior appearance or tarnishing the building's original character. Rather than adding glaring additions to the building, the renovated design proposed the use of existing space in and outside of the building. Committing to this idea, an under-used exterior plaza transitioned into a new space outside of the library that houses a 24-hour information commons, media center, and a quiet study space with a café.⁹

⁷ Campbell 2013.

Timothy M. Rohan, *The Architecture of Paul Rudolph* (New Haven, CT: Yale University Press, 2014), 24



Figure 3: Exterior photograph of Goddard Library.

Brutalism Online.

Another part of these major renovations includes immense focus on concrete repairs. A severe amount of concrete cracking and deterioration required focus on these portions of the building in order to maintain safety. An entire concrete parapet was removed to eliminate the possibility of the parapet separating from the building and falling onto passersby. Using this information, we gathered evidence of other buildings fixing concrete-related problems, which is useful in the event that the Fine Arts Center needs such measures to ensure safety for occupants and others passing by.

Smith Campus Center

The Smith Campus Center, originally named the Holyoke Center, is another Brutalist structure located in Harvard Square as part of Harvard University's campus in Cambridge, MA. Finishing construction in 1966, the campus center was primarily designed by the Dean of the Harvard Graduate School of Design. After the original completion of the construction project, a local joke stated that "the only nice feature about the Holyoke Center is that it's the one place in Cambridge from which you can't

see the Holyoke Center."¹⁰ No big renovations were started on the building despite general deterioration over the years.¹¹

Knowing that the building has not experienced any true renovations in decades, Hopkins Architects was hired to begin construction on the building on April 4, 2016 with the hope that the building would contribute to a wider "Common Spaces" university initiative.¹² In this initiative, the university is hoping to foster an improved intellectual, cultural, and social life. These renovations are slowly transitioning the predominately concrete building into a rich combination of concrete and new architecture. Hopkins Architects is looking to bring light to the interior, more visually pleasing views, and planted walls. The structural build of the campus center is also being improved through the removal of entire concrete parapets to prevent collapse onto the ground below, eliminating the possibility of endangering passersby. To date, Hopkins Architects is continuing to focus concrete repairs and aesthetic improvements with the goal to complete all renovations in 2018.¹³

¹⁰ Amdriw T. Wxsl, "Dcan Sert's Buildings," (sic) *The Harvard Crimson*, October 8, 1963, <http://www.thecrimson.com/article/1963/10/8/dcan-serts-buildings-pover-the-past/>.

¹¹ Hopkins Architects, "Harvard University: Richard A and Susan F Smith Campus Center," *Hopkins Architects*, accessed March 23, 2018. <http://www.hopkins.co.uk/projects/2/204/>.

¹² "Richard A. and Susan F. Smith Campus Center at Harvard University," *Architect Magazine*, April 4, 2016, http://www.architectmagazine.com/project-gallery/richard-a-and-susan-f-smith-campus-center-at-harvard-university_o.

¹³ Hopkins Architects.



Figure 4: The Smith Campus Center.

Bruner/Cott Architects. Rendering courtesy of Hopkins Architects.

Gordon Library

WPI's George C. Gordon Library was designed by O.E. Nault & Sons and completed in 1967.¹⁴ It is a reinforced concrete, monumental Brutalist building with both concrete and brick used in the façade. We chose this as a case study because of this exposed concrete on the façade. The structure was also built around the same time as the Fine Art Center, indicating possible similarities between the two. The Library Vision Committee discussed the need to renovate the space in 2002. The building and MEP systems were 35 years old at the time. The MEP systems had nearly outlived their useful lives, and the interior spaces were unattractive and uninviting. They decided that the way the library was set up when it was built no longer suited the university's needs due to the increase in group projects. They recommended the replacement of the HVAC, lighting, and electrical systems, as well as the roof and the windows. They wanted to update the group study spaces and the interior furnishings. They also recommended installing an automatic sprinkler system and creating quiet spaces, a café, and a space for

¹⁴ WPI, "Gordon Library @ 40," *WPI*, accessed September 26, 2017, <https://wpiarchives.omeka.net/exhibits/show/gordon40/timeline>.

archives and special collections.¹⁵ A series of renovations began in 2006 and recently finished. The second floor "underwent a major renovation that included redesign of [the] reference and circulation desk, creation of new staff offices, creation of new Tech Suites and expanded study space, and creation of the George Gladwin Art Gallery."¹⁶ Additional renovations to the library were recently finished. These included a new café, an area with computer workstations designed for collaboration, an IT helpdesk, and a printing area.¹⁷ The roof¹⁸ and HVAC systems were replaced and the bathrooms were updated and expanded.¹⁹



Figure 5: The front of the Gordon Library.

WPI, "George C. Gordon Library."

¹⁵ H.M. Shuster, et. al., "Report of the Library Vision Committee," (committee report, WPI, 2002), 1-2, 5-7.

¹⁶ WPI, "Gordon Library @ 40."

¹⁷ Christine Drew, "Pardon Our Dust this Summer as the Library Renovation Project Continues," *WPI*, accessed September 26, 2017, <http://wp.wpi.edu/library/2010/04/30/pardon-our-dust-this-summer-as-the-library-renovation-project-continues/>.

¹⁸ WPI, "Gordon Library @ 40."

¹⁹ Barry Hamlette, "Library Renewal," *WPI*, accessed September 26, 2017, <https://www.wpi.edu/news/library-renewal>.

East Hall

East Hall, a LEED-certified residence hall at WPI completed in 2008, features Worcester's first green roof. East Hall is a Modernist building and is a useful study for this project because it is an example of a roofing system that serves multiple purposes. In this case study, an unoccupied green roof is featured in the new design of this project. "This layered system provides a high degree of insulation, lowering both heating and cooling loads, while also providing improved sound attenuation for the building residents."²⁰ The plants are in 2-foot by 2-foot planters in a grid layout (See Figure 6). The plants are low maintenance and drought resistant. The roof as a whole is used for storm water research. "In a storm event, the green roof can actually help reduce flooding by retaining water on the roof within the modules. This process not only reduces the rate and volume of storm water leaving the roof, but it also filters pollutants from the water before releasing it slowly into the city's drainage system."²¹ Green roofs also create habitats for birds and other species. The combination of the green roof and the white color of the roof reduces the heat island effect.²² The Environmental Health & Safety Department at WPI recently installed a guardrail system so that the WPI community can have easier access to the roof.



Figure 6: Grid layout of planters on East Hall's green roof.

²⁰ WPI, "WPI Installs Worcester's First 'Living Green Roof' Atop New Residence Hall," *WPI*, accessed September 28, 2017, <https://www.wpi.edu/news/greennews>.

²¹ *Ibid.*

²² *Ibid.*

WPI, "WPI Installs Worcester's First 'Living Green Roof' Atop New Residence Hall."

The Fine Arts Center

We chose the Fine Arts Center (FAC) because we were interested in the historic preservation of Brutalist buildings. We were also interested in designing some sort of occupied green roof or rooftop lounge space for an academic building. The FAC was a good candidate due to its close proximity to WPI and because UMass Amherst allowed us to receive access to the original drawing set. Having access to the original drawing set meant that our structural design, roofing design, and analyses would be more accurate. It also has multiple flat roofs that we could use to create occupied spaces that interact with the surrounding campus area. We wanted to give this building a new purpose and make it more inviting to students and the public.

The FAC, designed by Kevin Roche, John Dinkeloo, and Associates, was completed in 1974. It is part of the University of Massachusetts at Amherst (UMass Amherst) campus in Amherst, MA, which is in Western Massachusetts. It is a site-cast, exposed concrete building. It was designed to connect the two sides of campus, and its lobby addition built in 1999 serves as a gateway into the campus. Figure 7 shows the location of the Fine Arts Center on the UMass Amherst campus map. The following figures show the overall layout of the FAC (Figure 8) and a sample floor plan (Figure 9).

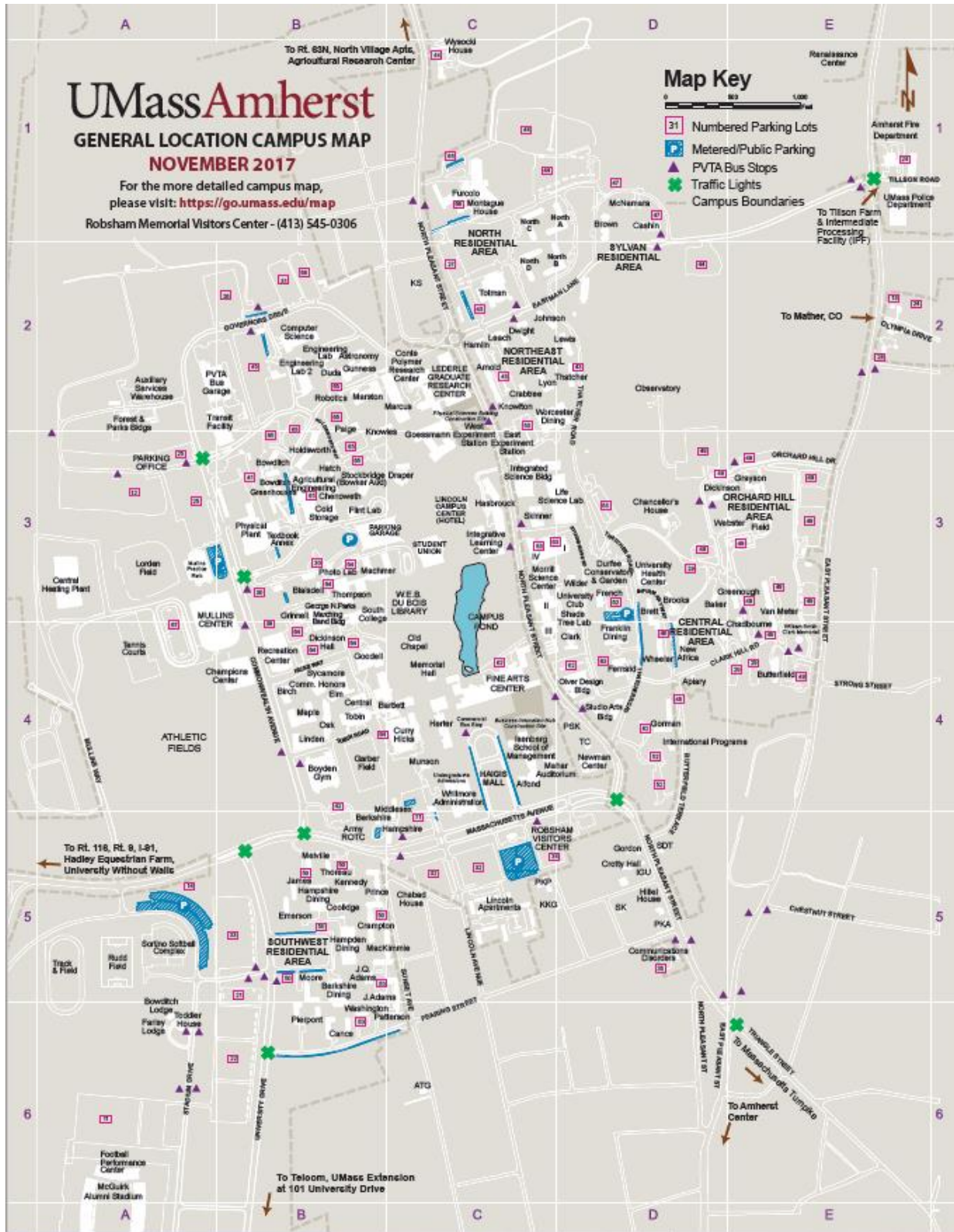

Figure 7: UMass Amherst campus map. The FAC is located in region 4C, just south of the campus pond.

UMass Amherst, "Campus Maps."

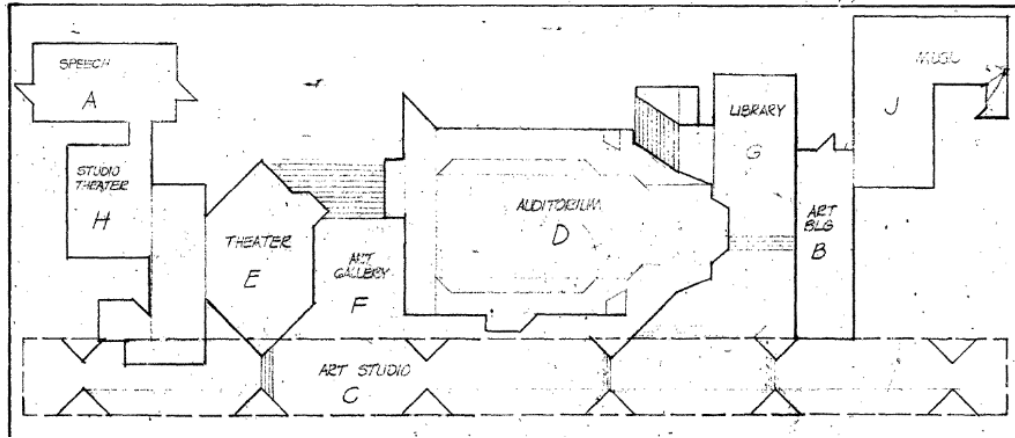

Figure 8: FAC building layout.

Kevin Roche John Dinkeloo and Associates 1970.

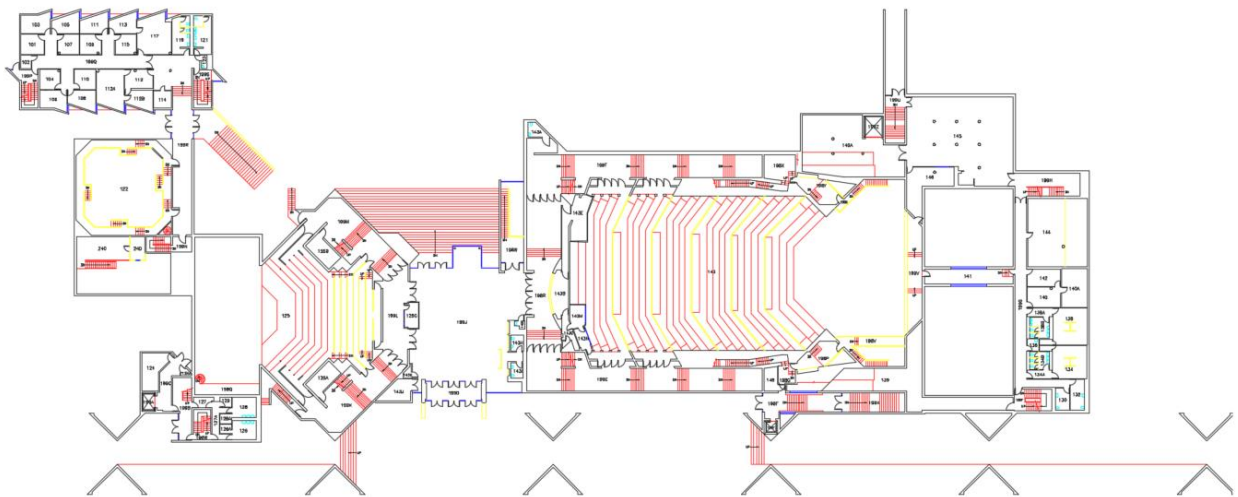

Figure 9: FAC First Floor Plan.

UMass Amherst 2014.

The FAC is composed of nine different exposed concrete buildings. These buildings house the Art and Music departments, which contain studio spaces, offices, and several auditorium spaces.²³ It is a

²³ Special Collections & University Archives, "Fine Arts Center," *UMass Amherst*, last modified June 5, 2015, http://scua.library.umass.edu/youmass/doku.php?id=f.fine_arts_center.

dynamic, Brutalist building with complex geometries. It essentially acts as a sculpture that plays with light and shadows.²⁴ UMass Amherst has been criticized for its monumental, concrete buildings that have become weathered and stained over time. These buildings were designed with the goal of separating the university's visual appeal from the typical look of private schools because they wanted to attract the "common man." Instead of mimicking the exclusive private schools that had long trained New England elites, UMass would proclaim its distinctive belief in excellence combined with broad educational access for the masses by embracing the architecture of the day.²⁵ The GI Bill allowed veterans returning from World War II to get higher education virtually for free, and UMass Amherst built over 10 million square feet of space during the 1960s and 1970s. Many issues with these buildings can be traced to the lack of maintenance after this building boom.²⁶

The Fine Arts Center consists of nine connected concrete buildings. Our project focuses on two of the nine buildings: Building B and Building C (See Figure 8). Building B is the art building, and we decided it would be the best place to design an outdoor terrace space that interacts with the surrounding areas. Building C is the Art Studio Building and we decided to include this building in our structural analysis due to its unique geometry and transfer of loads. We also designed a green roof for Building J, the Music Building.

²⁴ Kevin Roche John Dinkeloo and Associates, "Fine Arts Center University of Massachusetts," *Kevin Roche John Dinkeloo and Associates*, accessed January 10, 2018, <http://www.krjda.com/Sites/UMassInfo1.html>.

²⁵ Max Page, "The Ideals behind UMass Amherst's Stained Concrete," *The Boston Globe*, published March 24, 2013, <https://www.bostonglobe.com/ideas/2013/03/23/the-ideals-behind-umass-amherst-stained-concrete/DsPhAdcV2FSTEv0LpsGUcP/story.html>.

²⁶ *Ibid.*



Figure 10: Fine Art Center, East elevation, showing Art Studio Building (left), and Building B (right).

Kevin Roche John Dinkeloo and Associates, "Fine Arts Center University of Massachusetts."

The Art Studio Building has a unique triangular-shaped roof. The triangle opens to the north and consists of large windows to help natural light enter the art studio spaces below. See Figure 11 for the interior layout of the space.

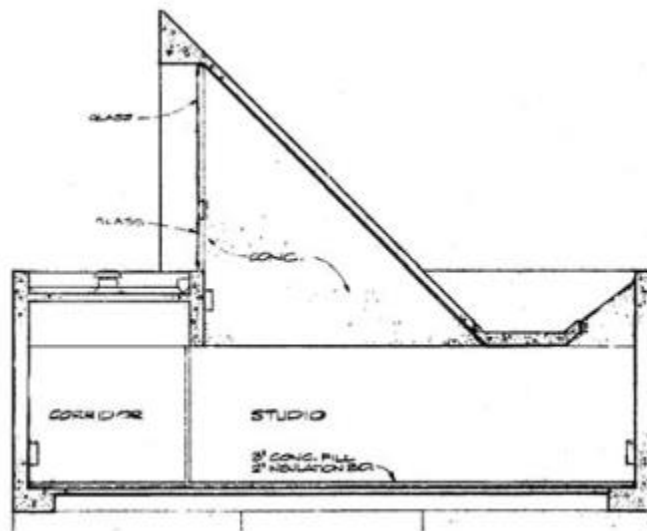

Figure 11: Section through the bridge showing the North wall and the hallway on the left, and the studio and South wall on the right.

Kevin Roche John Dinkeloo and Associates 1970, Drawing A13.

The building has a poured-in-place concrete structure. The bridge is 42 feet wide and 646 feet in length. There are two limited area sprinkler systems in the building, but there are no fire protection

systems installed on the bridge. There are four means of egress from the bridge. The original windows are single-paned glass, but some were replaced with double-pane, insulated glass.²⁷



Figure 12: Fine Art Center, North elevation. The windows of the Art Studio are in the back of the center.

Kevin Roche John Dinkeloo and Associates, "Fine Arts Center University of Massachusetts."

²⁷ Dietz & Company Architects, Inc., "The Fine Arts Center Bridge," (Classroom Conversion Study, Springfield, MA, 2011), 1, 4.

Methodology

The methodology section is broken up into multiple subsections. The first one discusses the review of the existing drawings and files provided by UMass Amherst. This follows by discussion of a site visit to the FAC, and the investigation of fire code requirements for the rooftop art gallery. The next two sections cover the structural analyses of the Art Studio Building and Building B. Lastly, we discuss the new design of the sculpture garden, including the new roofing design as well as other design aspects.

Documents Review – Existing Drawings and Files

UMass Amherst provided us with several resources that we utilized when drafting and modeling the FAC:

- Scanned copies of the original (hand-drawn) drawing set
- Recent digital floor plans in AutoCAD format
- Partial 3D model of the Fine Art Center in Revit

We primarily used the original structural drawings to evaluate the structure. The relevant original drawings and schedules are given in Appendix A, Appendix B, and Appendix C.

Site Visit

On October 1, 2017, the design team visited the site to review and visually assess the existing condition of the Fine Arts Center. The survey included a recorded inspection of the four elevations of the Art Studio Building (See Appendix D), and a visual inspection of the interior. The purpose of this survey was to assess whether the structure was at full capacity so we could assess whether we could safely add more loads to it without altering the structure. We focused our observations on the Art Studio Building and assumed that the rest of the FAC would be in a similar condition. The following conditions recorded when assessing The Fine Arts Center include:

- Cracks in the concrete
- General deterioration
- Spalls defined as concrete pieces that are no longer attached to the underlying reinforcement of concrete element
- Efflorescence defined as white tracks of crystalline deposit left behind by water that has migrated to the surface of the concrete
- Dark staining
- Past repairs

Our observations are discussed in the Results section.

Fire Code Requirements

One of the many focuses of this project was fire code requirements for the new design. The space currently has no general public access. There was originally no need for strict adherence to code requirements on means of egress due to the lack of occupants accessing the space. The addition of a rooftop terrace and art garden meant providing means of traveling in and out of the space, resulting in the need for complying with codes to ensure safety for occupants in the event of a hazard.

A lot of thought went into designing the points of egress for Building B. Fire safety requirements and how to unite multiple spaces both had to be considered. The space is considered an “Assembly: Unconcentrated Seating” function. Using Table 1004.1.1 of the International Building Code (IBC), we were able to calculate a maximum occupancy load of 335 occupants. A minimum of two means of egress in and out of the space was found by using Table 1019.1 and the maximum occupancy. The locations of these exits were placed according to the minimum distance of 66 feet allowed between each exit, which was calculated using Section 1007.1.1. Table 1016.1 was then examined to determine the maximum travel distance to any given exit from the space, which we found to be no more than 200 feet. An egress

width of 8.343 feet was calculated based on Table 1005.1 of the IBC and the maximum occupancy load. Lastly, using the average height of 7" for stairs in the United States, we determined that 54 steps are needed to stretch the staircases from the plaza to the design space. Table 7.2.2.2.1.1(b) of the Life Safety Code, NFPA 101, provided us with the requirement of incorporating two landings into the stair case to comply with the codes.

Structural Analysis - Art Studio Building

We first analyzed the structure of the Art Studio Building. We did not make any changes to the building in our new design. The Art Studio Building has a unique geometric shape. The studio classes within the art studio bridge are raised four stories off that ground supported by arrowhead shaped concrete columns. Ribs on the underside of the bridge support the floor slab. Column panel walls support the triangle shaped roof. Figure 13 **Error! Reference source not found.** shows a section of the Art Studio Building with the structural members as described above labeled. The analysis of the Art Studio Building we split into two parts. The first part considers the horizontal loads such as gravity. The second part considers the lateral loads such as wind and seismic loads.

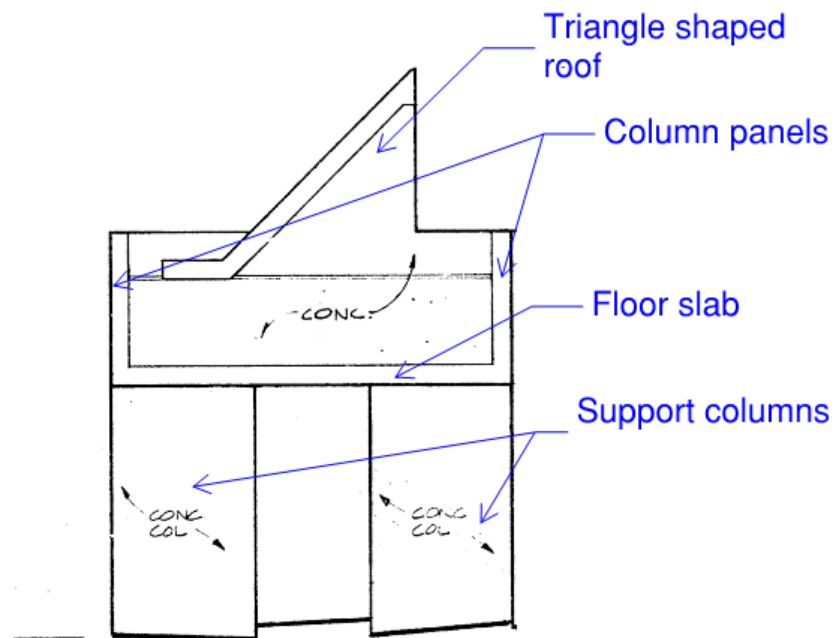

Figure 13: Art Studio Building East elevation.

Adapted from Kevin Roche John Dinkeloo and Associates 1970, Drawing A12.

Vertical Loads

The unique shape of the building created a unique challenge when considering how the loads transfer and with applying the distributed loads to the triangle roof. To create a better picture of how the members work together, we created a load transfer diagram (Figure 14 **Error! Reference source not found.**).

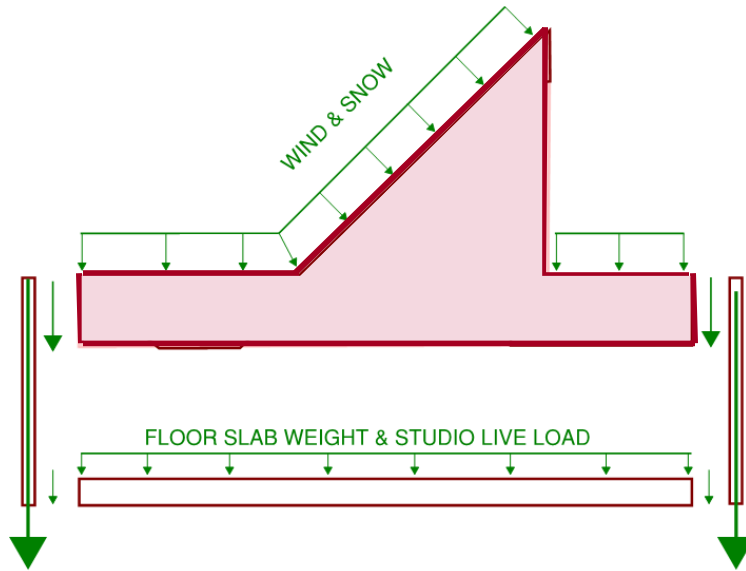

Figure 14: Load transfer of the Art Studio Building structural members.

The shaded area represents the triangle wall member that exists every 30 feet. The other members are continuous along the 646-foot bridge. The structural analysis calculates the loads located at the periodic triangle wall members. The structural members in the diagram above are separated to allow space for the reaction arrows. The reaction arrows represent the load that is being transferred from one member to the other.

We retrieved the design live loads from drawing sheet S01 Typical Details and General Notes, those comply with the current ASCE-10 requirements (See Appendix A, Figure 53).

Area	Design Live Load (LL)
<i>Wind</i>	20 psf
<i>Roof (Snow)</i>	40 psf
<i>Public Area, Corridors</i>	100 psf

The distributed live load (LL) applied to the Art Studio roof is 60 psf and the dead load (DL) is the self-weight. We used RISA-2D to model the structure and determine the end reactions. The load combination used throughout our calculations is equation 16-2 of Utah's 2015 Building Code, which conforms to the 2015 IBC:

Equation 1:²⁸

$$U = 1.2DL + 1.6LL$$

Due to the unique geometry, we had to simplify the analysis by splitting the roof into two parts. Part one models the triangle area of the roof as outlined by the yellow box in Figure 15. **Error! Reference source not found.**

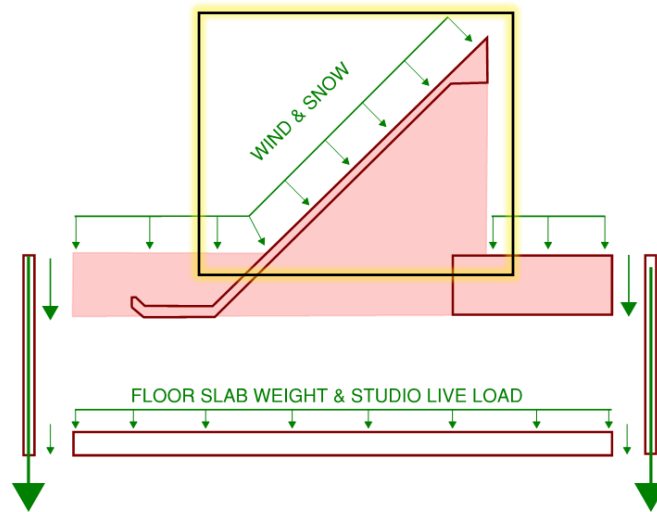

Figure 15: Triangle roof area.

Roof

The first part of the roof should be modeled as a right triangle with the distributed dead load applied along the hypotenuse. The slant of the hypotenuse complicates the problem as the applied loads would not be uniform across the entire roof. To simplify the problem we modeled the triangle roof as a flat 22-foot long continuous beam with two pin supports at each end. A load combination of $1.2DL + 1.6LL$ calculated a maximum moment of -96.1 K-ft (See Figure 16. **Error! Reference source not found.**), and a maximum shear of 17.5 K (See Figure 17).

²⁸ Utah Uniform Building Code Commission, *Building Code 2015 of Utah*, (Utah Uniform Building Code Commission: Utah, 2015), https://up.codes/viewer/utah/ibc-2015/chapter/16/structural-design#1605_

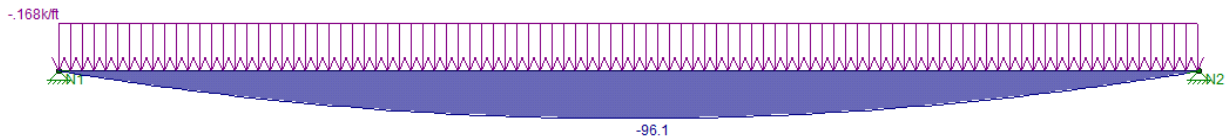

Figure 16: Art Studio triangle roof area moment diagram.

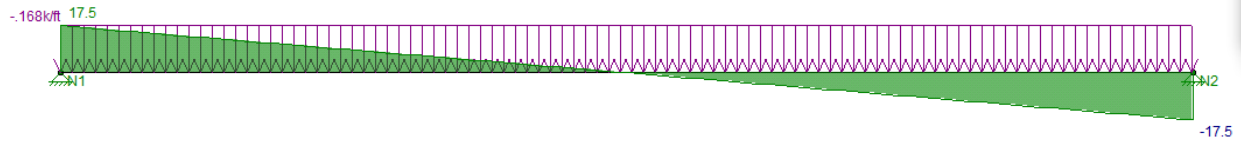

Figure 17: Art Studio triangle roof area shear diagram.

We then used the maximum shear value of 17.5 K, which represents the reaction at the pinned end, as a point load on the overall roof member analysis to represent the load from the triangle area. Following the same approach to calculate the effects of the live loads, we applied the same design live load of 60 psf to the flat areas on the left and right of the triangle. Again, we applied the load combination 1.2DL+1.6LL to calculate the results. We found a maximum moment of -349.1 K-ft (See Figure 18Error! Reference source not found.) and a maximum 34.7 K shear value (See Figure 19Error! Reference source not found.).

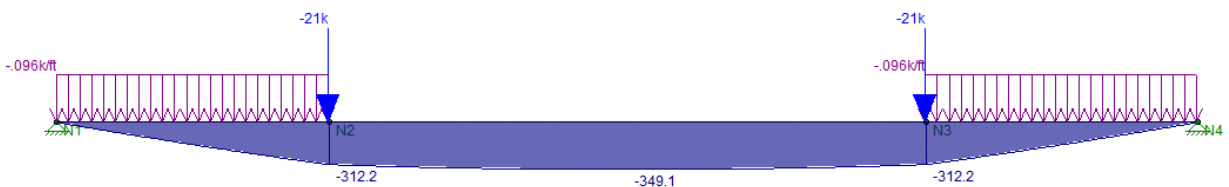

Figure 18: Art Studio roof moment diagram.



Figure 19: Art Studio roof shear diagram.

The combination of the loading (DL+LL) produces a maximum moment value of 349.1 Kips-ft. Therefore, for the Art Studio, 349.1 Kip-ft is the minimum moment capacity value for the roof structure.

Column Wall Panels

We then evaluated and considered the Art Studio column panel walls. The column panels are the walls on the Art Studio Bridge which carry the majority of the Building’s transverse loads. According to Elevation North Wall/Beam – West Half on Drawing Sheet S19, thirteen #11 sized steel rebar work in tension and four #11 sized steel rebar work in compression for the Column Panels (See Figure 20Error! Reference source not found.).

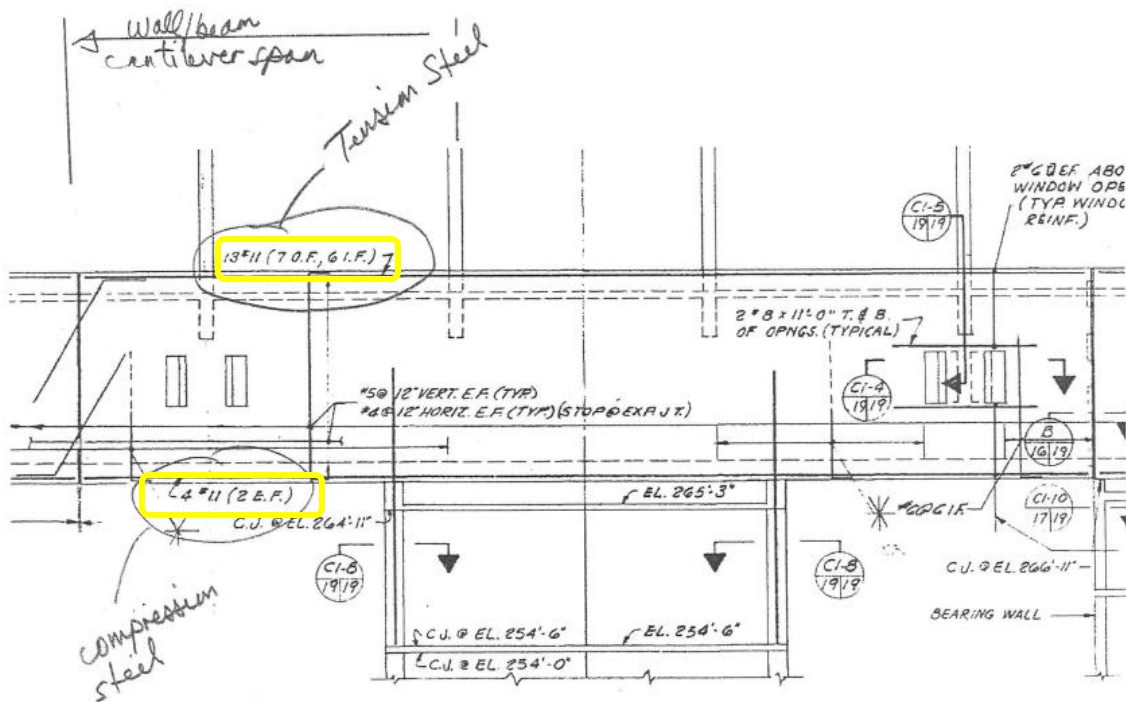

Figure 20: Elevation of North wall/beam - West half illustration the rebar used in the column panels.

Adapted from Kevin Roche John Dinkeloo and Associates 1970, Drawing S19.

We considered the column panel walls to be a doubly reinforced rectangular beam and used the following formula to calculate the design moment capacity (denoted M_n). The compression strength of the concrete is 3,000 psi.

Equation 2:²⁹

$$\phi M_n = \phi \left[A_s f_y \left(d - \frac{a}{2} \right) + A'_s f'_s (d - d') \right]$$

The design moment capacity of the column panel is 15,368 kip-ft. For the full calculation, see Appendix E.

We modeled the column panel walls in RISA. The art studio bridge is 646 ft long and the RISA program has a maximum length of 500 ft. For this reason, the two middle support columns were not included in the RISA analysis. The RISA model includes the reactions from both the Art Studio triangle roof (34.7 kip-ft) and from the floor ribs (8.3 kips-ft). The floor ribs occur every three feet and are represented by the smaller arrows, the roof triangle loads occur less often and are represented by the larger arrows (See [Figure 22](#) ~~Figure 22~~ **Error! Reference source not found.**).

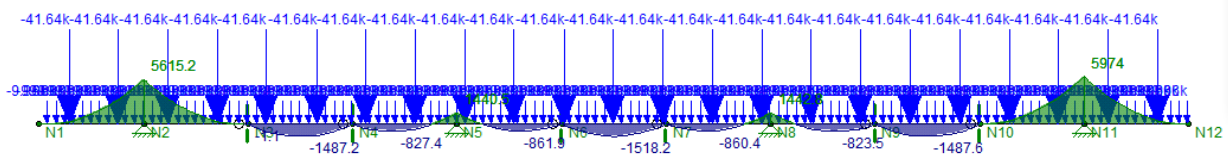

Figure 21: Column wall panel overall moment diagram.

²⁹ *Structural Steel Design*, (McCormac & Brown), 9th ed., 129.

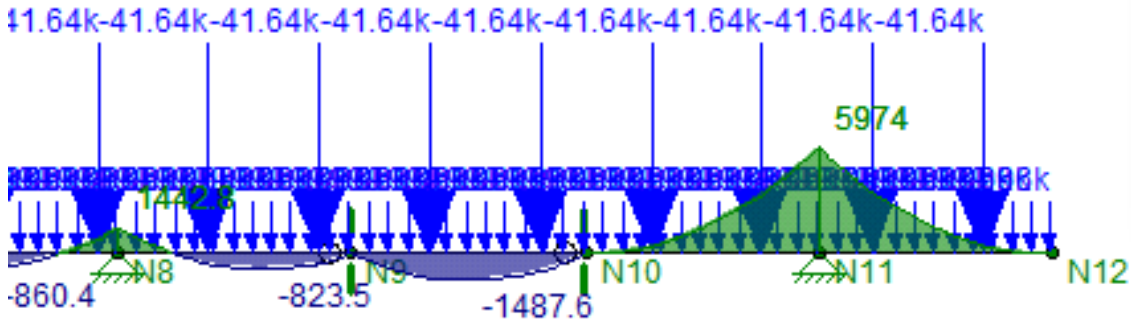

Figure 22: Column wall panel moment diagram of the East end.

The applied load on the column panel is 1518.2 kips-ft. This is acceptable because it is less than the design moment capacity of 15,363 kip-ft.

Floor Rib

Based on Section C1-11 on Drawing Sheet S17 we were able to calculate the moment capacity of the floor ribs. Two #8 sized steel rebar work in compression. Both two #8 sized steel rebar and two #5 sized rebar work in tension (See Figure 23Error! Reference source not found.).

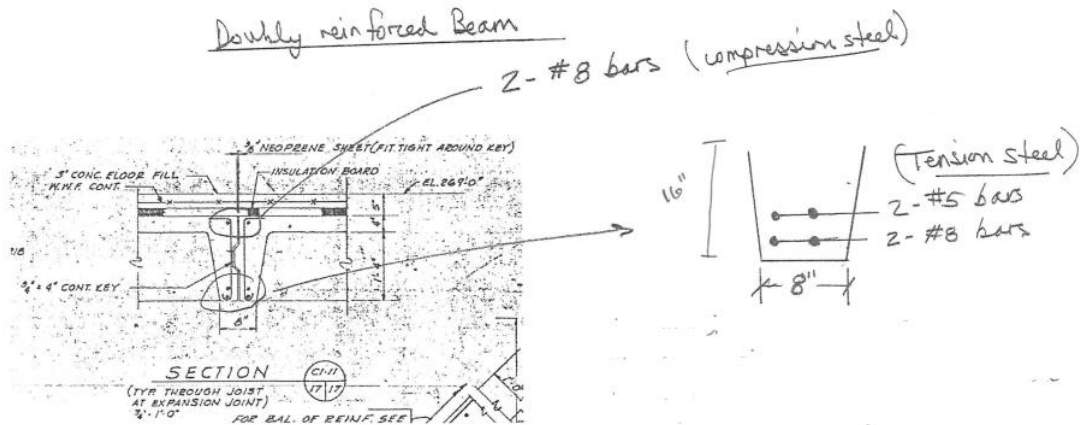

Figure 23: Section C1-11 of the Art Studio rib.

Adapted from Kevin Roche John Dinkeloo and Associates 1970, Drawing S17.

We considered the floor rib to be a doubly reinforced rectangular beam and used **Error! Reference source not found.**, as shown below, to calculate the actual moment capacity (denoted M_n). The compression strength of the concrete is 3,000psi.

$$\phi M_n = \phi \left[A_s f_y \left(d - \frac{a}{2} \right) + A'_s f'_s (d - d') \right]$$

The design capacity of the floor ribs calculated out to 139 kip-ft. For the full calculation, see Appendix E.

The calculated value is more than enough as it is larger than the moment caused by the applied load. We modeled the Art Studio Floor Rib in RISA. The dead load included the weight of the 3-inch floor slab and 2-inch insulation. We used 100 psf as the design live load and the 1.2DL+1.6LL load combination. The applied load of the 34-foot long rib is 70.8 kip-ft (See Figure 24**Error! Reference source not found.**). The applied load is less than the design capacity, which is the desired result.

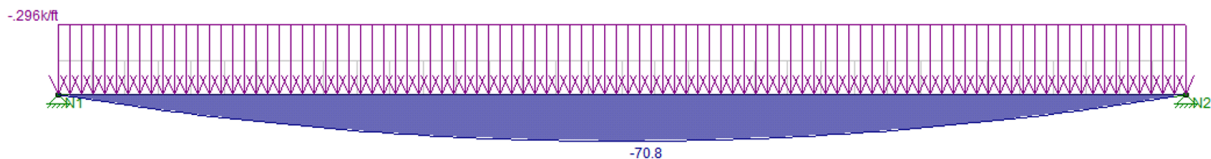

Figure 24: Rib moment design capacity diagram.

Lateral Loads

To calculate the wind load on the Art Studio Building we split the building into three separate parts, the triangle roof, the column wall panels, and the support columns (See Figure 25**Error! Reference source not found.**) to be analyzed separately.

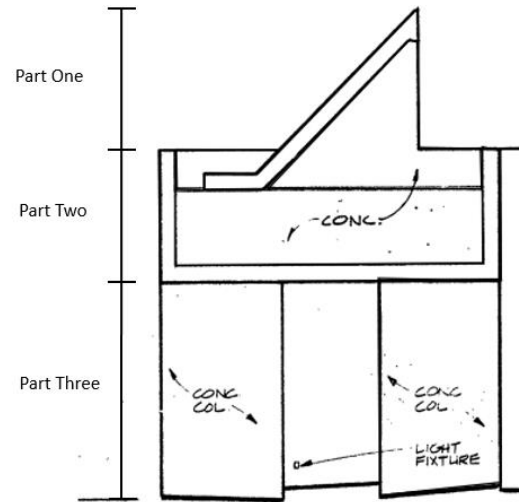

Figure 25: Art Studio split into three parts for wind load analysis.

Adapted from Kevin Roche John Dinkeloo and Associates 1970, Drawing A12.

To calculate each part we determined the height of the section, the width of the area, and the given wind live load. For the full calculations, see Appendix F.

When considering the seismic load on the Art Studio Building we made some simplifications. The first was we considered the fourth floor area to be the bulk of the weight and area affected. The support columns were assumed to be massless. To see the full Seismic calculation refer to Appendix G.

Vertical and Lateral Loads

Support Columns

To evaluate the applied loads on the support columns we considered both the lateral loads and the vertical loads. The vertical load was taken from RISA model of the column wall panels. The lateral load was taken from the wind load calculations. The wind load calculated was larger than the seismic load, therefore it controlled the design.

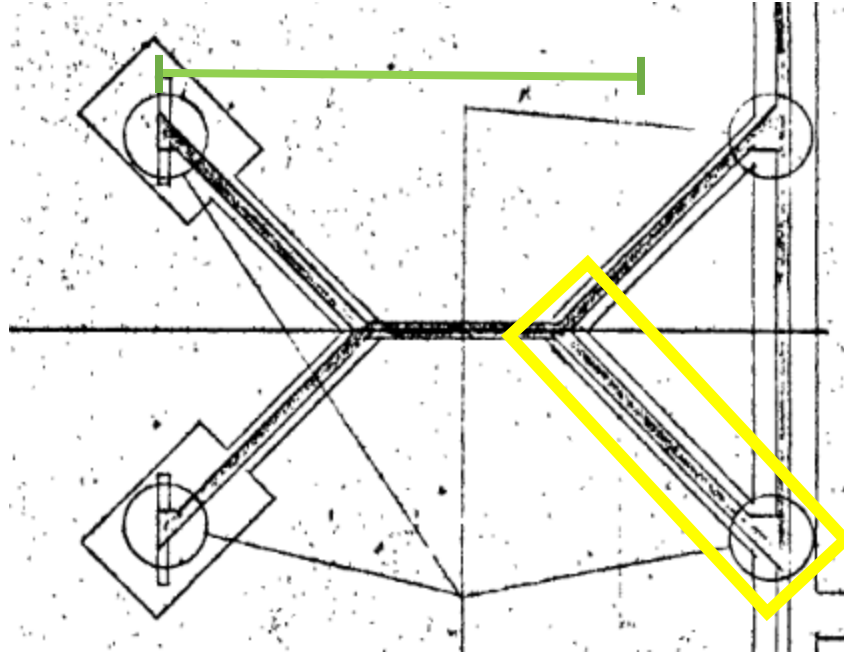

Figure 26: Outline of the Art Studio support columns.

Adapted from Kevin Roche John Dinkeloo and Associates 1970, Drawing S16.

A single support column is shaped as an arrow. Two support columns look like two arrow heads facing each other (See [Figure 26](#)). For this reason we split the support columns into four sections and only analyzed one of the sections as highlighted by the yellow box in [Figure 26](#). For the final applied load we used the following formula to add the vertical load and lateral load together;

Equation 3:

$$\frac{\text{Vertical Load}}{4} + \frac{\text{Sum of (Wind Load)(Height/2)}}{28}$$

The vertical load is divided by four to represent the fourth of the support column being analyzed. The second part of the equation represents the lateral loads. The wind load is the lateral loads, the height/2 represents the location of the load, and the 28 is the distance in feet from one side of the support column to the middle of the opposite support column. The green line in [Figure 26](#) illustrates the 28-foot distance. The value for the applied load on the support column calculated out to be 20,392 kips. For the full calculations see Appendix E.

When calculating the design capacity of the support columns the original structural drawings provided very little information about the reinforcement used in the columns. For this reason, we assumed 2% of the gross area to be reinforcing steel. We used the following formula to calculate the design capacity;

Equation 4:

$$P = f_c A_c + f_s A_s$$

In ~~Equation 4~~^{Equation 4}, P represents the nominal axial load of the column.³⁰ The nominal axial load is the largest calculated load the column can support and the capacity we are looking for. A_c is the area of the concrete and A_s is the area of the steel reinforcement that we had to assume. The variable f_c is the compressive stress and is based off of the concrete design compressive stress, f'_c , of 3,000 psi. The variable f_s is the stress in the steel reinforcement. The nominal axial load for the support column calculated out to be 25,390 kips. This is acceptable because it is larger than the applied load. To see the full calculations see Appendix E.

Footings

When calculating the footings for the support columns, the footing was separated into two sections to reflect the two different reinforcement used throughout the footing supports (See Figure 27 **Error! Reference source not found.**). The applied load on the footing was based on the shear in kips calculated from RISA and the dead weight of the support column. The design capacity was based on the reinforcement listed on Structural Drawing 16. The wall footing (outlined by the yellow box in Figure 27) includes 5 #4 steel reinforcement bars. The Buttress footing (outlined by the green box) includes #7 steel rebar every 6 inches. For the full calculations, see Appendix E.

³⁰ The University of Memphis, "Axially Loaded Members," (PDF, Memphis, TN), 41.

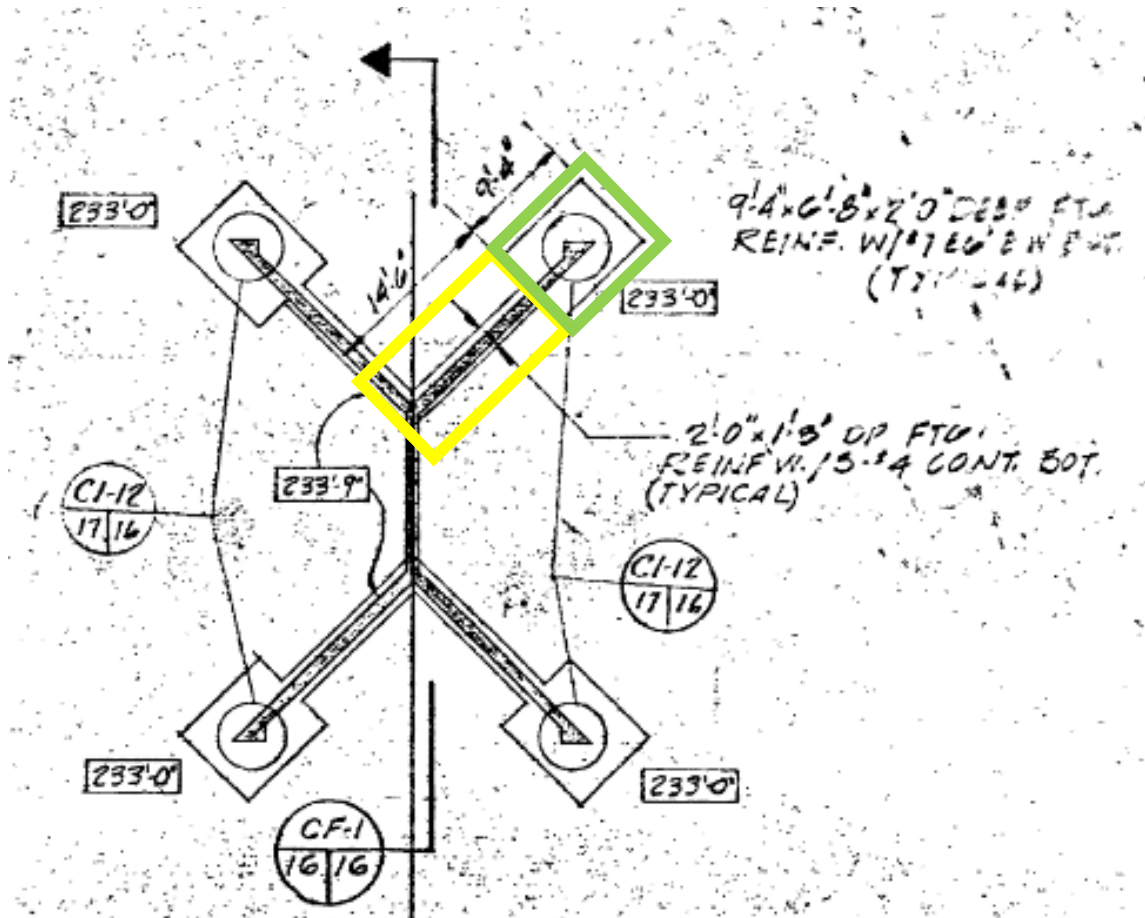

Figure 27: Footing reinforcement of the support columns.

Adapted from Kevin Roche John Dinkeloo and Associates 1970, Drawing S16.

Structural Analysis - Building B

We analyzed the structural capacity of Building B. There are seven levels in this building, listed from top to bottom as follows:

- Roof
- Third floor
- Second floor
- First floor
- Library level
- Storage level

- Ground floor
- Foundation

The purpose of the structural analysis was to determine the maximum weight of sculptures that we could put on top of the roof without altering the existing structure. There are six floors in the building in addition to a roof and foundation. Figure 28 below shows a section view of the building and the floors that it consists of.

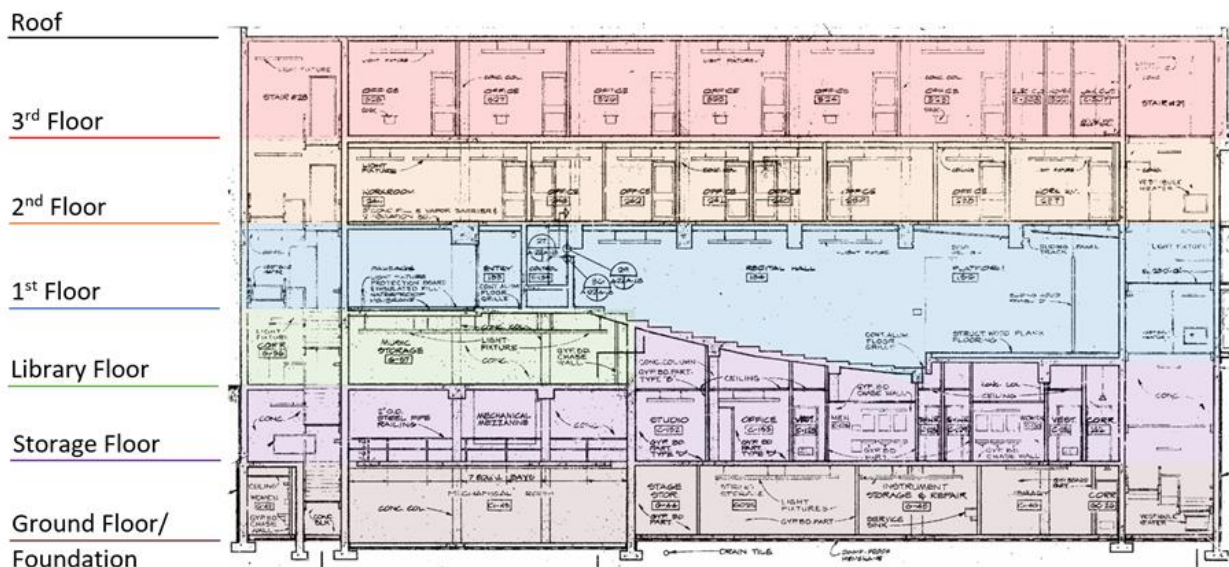

Figure 28: Section view of Building B with floor breakdown.

Adapted from Kevin Roche John Dinkeloo and Associates 1970, Drawing A13.

In Building B, there are load-bearing walls, columns, beams, footings, slabs, and slab-on-grade foundation, all of which are labeled in the framing plans (Figure 67 to Figure 73 , Appendix H). We analyzed all of the structural components except for the floor slabs, slab-on-grade foundation, and most of the walls deemed as load-bearing components in the building. There were a few walls on the East and West sides of third and second floors that we did not analyze because they are at an angle to the main mass of the building (Figure 67 to Figure 69, Appendix H). We assumed that they are sufficient to carry the loads in the building, and that they simply transfer the loads to the walls below them. In

reality, they probably act more like columns, where the size of the column is determined by the cross section of the wall that transfers the load. We found the applied loads on the components, both for the current load case and the new load case, as well as the strength of these components. The current load case is the self-weight, or dead load, of the structure and the live loads given in the original drawing set (Figure 53, Appendix A). The new load case is the current load case with the addition of more live load and new roofing materials to the structure after the implementation of the design. We increased the roof live load from 40 psf to 100 psf to account for occupants regularly accessing the roof. The addition of new waterproofing details on the roof raised the dead load on this level by 27 psf. Then, we compared this new load case against the strength of the structural components to determine the maximum weight of the sculptures that could be placed on the roof. We also performed wind and seismic analyses on the walls. The calculations, including assumptions, are included in Appendix H.

Columns

To determine the loads transferring through the columns, we had to utilize the tributary areas of each column to find the amount of load each is holding from the slab. Determining these load combinations resulted in two different sets of calculations, the first set using the original roof live load of 0.04 ksf and the second set using the new roof live load of 0.1 ksf. Using typical load combination equations, we were able to determine the amount of load being transferred from the roof through the first set of columns on the third floor of the building. These calculations continued to the next set of columns on the second floor, the difference being that these columns are receiving point loads from the third floor columns, as well as their self-weight. In addition to completing load calculations in the same manner, the new dead load also includes the physical weight of the above columns and the load combinations being applied to them. This process continues down the building until the loads travel down to the entry floor of Building B. Instead of having another set of columns to continue transferring

the applied loads, there is a set of six beams that endures all loads from the columns above and transfers it to the east and west walls of the building.

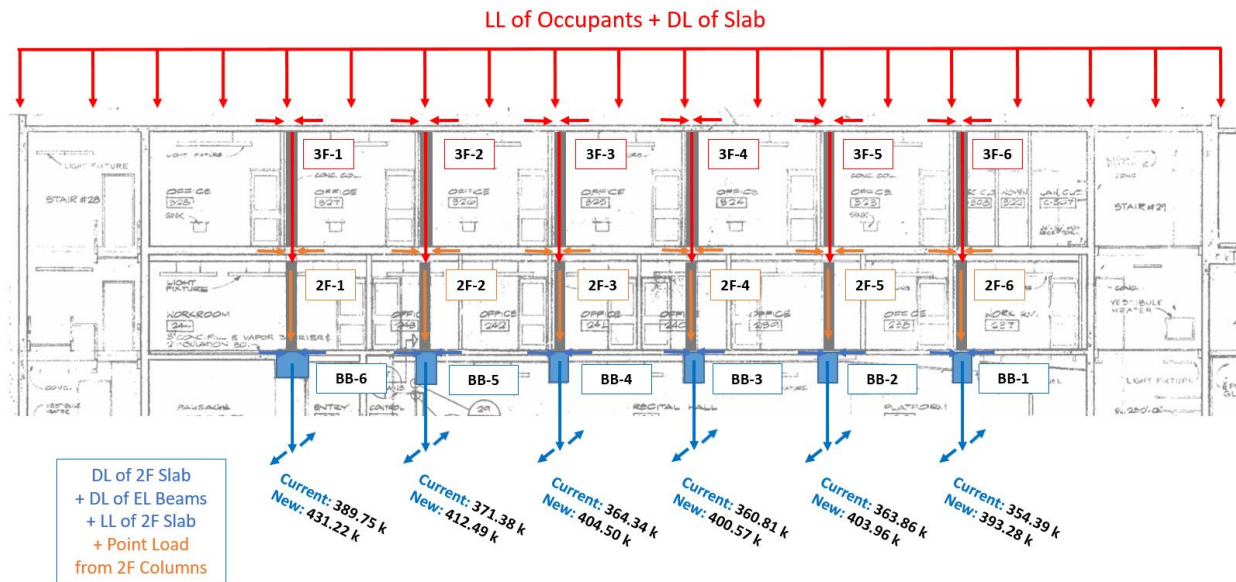

Figure 29: Example drawing displaying load transfers through columns to the first floor beams.

Adapted from Kevin Roche John Dinkeloo and Associates 1970, Drawing A13.

This means that the columns that appear on the library floor, the floor directly underneath the first floor, mark the beginning of the process again, as the only loads being applied to these components are the dead load from the slab and the live load of 0.1 ksf. The load combination equation of $1.2DL+1.6LL$ is used again to determine the loads being applied to these columns. This process continues through the rest of the building to the foundation level. Loads from various columns are either transferring to columns directly underneath on lower floors, to beams that may transfer loads to adjacent walls, or to the column footings. Eventually all loads, whether transferred from columns directly or from the columns to the walls, will be transferred to the various footings found on the foundation level. See Appendix H for a spreadsheet of load combination calculations of the columns.

After determining the applied loads, we had to ensure that the columns were capable of enduring these loads. Given that the lateral loads are carried by the walls, the columns are only carrying

axial load. Therefore, the axial load capacity of each column was calculated and compared against the applied load.

We assumed that each column was a spiral column with reinforcement details taken from the column schedule on drawing sheet S20. For a full list of calculations that show the axial column capacities with references, see Appendix H, Tables 21 and 23. After comparing the column capacities to the applied axial loads of the columns, we were able to determine that each column is capable of holding the current load as well as the new design load from the rooftop terrace concept.

Beams

To calculate the strength of the beams, we first had to determine the loads applied to each beam. All beams were analyzed in Risa-2D to determine the moment in the beams resulted from the applied loads. This was calculated after marking the points along the beam where a load was being applied. Point loads were added to beams where columns on the floor above were transferring loads, while a distributed load was applied along the entirety of the beams to represent the loads from the slab. Beams were assumed to be simply supported, with some beams also being supported by columns from the floor below. Simply supported beams consisted of one member and pins on each end, while the presence of columns were also represented with pins, to symbolize end reactions that would transfer to the columns and walls below. Each beam scenario was modeled in RISA-2D and provided a moment diagram that identified the applied moments on the beam.

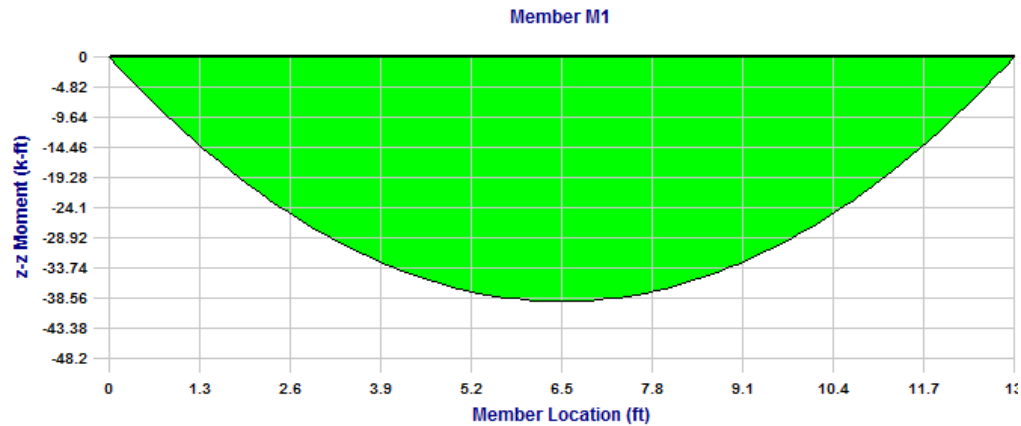

Figure 30: Applied moment of beam BB-13 modeled in Risa-2D.

After determining the applied moments of the beams, we then calculated the moment capacity of each member. We assumed that all beams were doubly-reinforced rectangular beams, therefore, using the appropriate equation based on ACI318-14, we calculated the moment capacity of each beam.

A complete spreadsheet of calculations can be found in Appendix H, Tables 22 and 24 . By comparing the moment capacities to the applied moments on each beam, we were able to assume that the beams are currently structurally sound, and will also be able to accommodate for a change in load occurring from the new design concept.

Walls

For the walls, we studied the framing plans to determine how they transfer loads to the wall footings. The loads on the wall include the self-weight of the wall, the loads transferred from the slab (within its tributary area), and any transfer loads from the structural component(s) directly above. For the diagonal walls on the third and second floors (Figure 68 and Figure 69, Appendix H), we assumed that any loads placed on them would simply transfer down to the walls below. Next, we found the axial, moment, and shear capacities based on the wall reinforcement listed in the original drawing set (Table 16, Appendix A). The equations we used are as follows:

Axial strength

Equation 5:³¹

$$P_n = (0.55f'_c A_g) \left[1 - \left(\frac{kl_c}{32h} \right)^2 \right]$$

Bending strength

Equation 6:³²

$$M_n = A_s f_y \left(d - \frac{a}{2} \right)$$

Shear strength

Equation 7:³³

$$V_n = V_c + V_s$$

Where V_c and V_s are defined as:

Equation 8:³⁴

$$V_c = 2\lambda\sqrt{f'_c h d}$$

Equation 9:³⁵

$$V_s = \frac{A_v f_{yt} d}{s}$$

Lateral Loads Analysis

Next, we performed the lateral load analyses. For the wind load analysis, we applied the wind load given in the original drawing set (20 psf) to the surface area of the walls on the floors that were above ground. The wind load then gets transferred to any walls perpendicular to that wall as a shear load. We compared that shear load against the shear strength of the walls. We also calculated the bending stresses caused by the shear loads and compared them against the bending capacity of each

³¹ ACI Committee 318, *Building Code Requirements for Structural Concrete (ACI 318-14) and Commentary (ACI 318R-14)*, (Farmington Hills, MI: American Concrete Institute, 2014).

³² Arthur H. Nilson, et. al., *Design of Concrete Structures*, (Boston: McGraw Hill Higher Education, 2010), 14th ed., 86.

³³ ACI Committee 318, 2014.

³⁴ Ibid.

³⁵ Ibid.

wall. If the wind loads are acting on Wall 1 and being transferred to Wall 2, the wind load acts along the height of Wall 2. If Wall 1 transfers the load to only one Wall, Wall 2's tributary width is the length of Wall 1. If the loads on Wall 1 transfer to two walls, the tributary width of each wall is half the length of Wall 1. The moment at the bottom of the wall caused by the load is given by the following equation:

Equation 10:

$$M = (0.02 \text{ ksf}) * (\text{tributary width}) * (\text{height of Wall 2}) * (\text{height of Wall 2}) / 2$$

For the seismic load analysis, we referred to S.K. Ghosh Associates' CodeMaster for the 2012 IBC and ASCE 7-10. The equations are given in Appendix H.

Footings

For the wall footings, we found the loads on each footing in k/ft. The loads include the self-weight of the footing, the weight of the wall below the slab-on-grade foundation, and any transfer loads from the ground floor walls. We then found the bending and shear strengths, as well as the maximum point load that the footing could support in addition to the distributed load already applied. The reinforcement schedule is given in Table 17, Appendix A. The bending strength is given by [Equation](#)

[Equation 6:](#)

$$M_n = A_s f_y \left(d - \frac{a}{2} \right)$$

Equation 11:

$$a = \frac{A_s f_y}{0.85 f'_c b} \text{ }^{36}$$

The shear strength, assuming there is no shear reinforcement, is given by

Equation 12: ³⁷

$$V_n = V_c = 2\lambda\sqrt{f'_c}b$$

³⁶ Nilson, et. al. 2010, 86.

³⁷ Ibid., 564.

Next, we had to find the maximum point load (P) the wall footing could support. When analyzing a wall footing, we can assume that the part of the footing that is directly under the wall has the same bending strength as the wall itself since they have the same width. Therefore, the parts of the footing that we are concerned about are the parts that cantilever off the edge of the wall. Looking to one side of the footing, we can treat it as a cantilevered beam that is fixed to the part of the wall footing that is directly under the wall. Taking a 1' slice of the footing, we treated this as a cantilevered beam with the point load, P, located at its free end. Locating P at its free end gives the greatest moment that could be caused by a point load acting vertically on the beam. The resulting moments on the beam are caused by a distributed load (w) and the point load P. To solve for the maximum allowable value of P, we set the sum of the resulting moments equal to the bending capacity of the beam, which gives the following equation:

Equation 13:

$$\phi M_n = PL + \frac{wL^2}{3}$$

Rearranging this equation to solve for P gives the maximum allowable point load. ϕM_n is the bending capacity for the entire footing divided by its length. L is calculated using the following equation:

Equation 14:

$$L = (\text{width of footing} - \text{width of wall})/2$$

For the column footings, we first analyzed the applied loads on each footing. The applied loads include the self-weight of the footing, the weight of the column below the floor slab, and any transfer loads from the ground floor columns. Next, we analyzed the one-way and two-way shear strengths as well as the flexural strength of each footing. We assumed there was no shear reinforcement in the footings. The one-way shear is calculated using the following equation:

Equation 15:³⁸

$$V_n = V_c = 2\sqrt{f'_c}b_w$$

The two-way shear is given by

Equation 16:³⁹

$$V_n = V_c = 4\lambda\sqrt{f'_c}b_o$$

Finally, the flexural strength is calculated using the same equations that we used to find the bending strength of the wall footings.

Roof Slab

For the roof slab, we picked a random section of the roof, took a 1' slice out of it, and treated that slice as a simply supported beam. The section we chose is between the gridlines C and D, and 2 and 3 (see Figure X, Appendix H). We then used the geometry of the roof pavers we chose and the pedestals that support them to find the maximum allowable point load that could be placed on the beam. The pavers sit on small pedestals, which sit on top of additional roofing materials. The pavers are 20" square, with one pedestal at each corner. We can model these four pedestals as acting at two points in the center of the beam. So, we placed two point loads 20" apart in the center of the beam. The following figure shows the point loads (P) on the beam and the reaction forces (R).

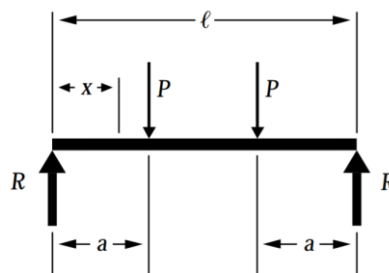

Figure 31: Simply supported beam with two point loads.

³⁸ "Footings Example 1," (PDF).

³⁹ Ibid.

American Wood Council 2007.

We used the minimum slab reinforcement in Table 16, Appendix A to determine the reinforcement of the beam. To find the bending strength of the beam, we used the following equations:

Equation 17:⁴⁰

$$\phi M_n = \phi \rho f_y b d^2 \left(1 - 0.59 \rho \frac{f_y}{f'_c} \right)$$

Equation 18:⁴¹

$$\rho = \frac{A_s}{bd}$$

We then calculated the applied moments due to the distributed load on the beam (w_u) as well as the two point loads, $P/2$ and $P/2$:

Equation 19:

$$M_u = \frac{w_u L^2}{8} + \left(\frac{P}{2} \right) (a)$$

Where variable a is the distance from one end of the beam to one of the point loads.⁴² To find the maximum allowable point load, we equated ϕM_n and M_u and rearranged the equation to solve for P .

New Design

Once we finished the structural analysis of Building B and the waterproofing roof design, we had to determine what the allowable weight of the sculptures on the roof could be without altering the structure any further. We compared the allowable additional point loads of the following components:

- Concrete roofing pavers

⁴⁰ Nilson, et. al. 2010, 87.

⁴¹ Ibid.

⁴² American Wood Council, *Beam Formulas with Shear and Moment Diagrams*, (Washington, DC: American Wood Council, 2007), <http://www.awc.org/pdf/codes-standards/publications/design-aids/AWC-DA6-BeamFormulas-0710.pdf>.

- The rubber pedestals the pavers rest on
- The roof slab
- Any structural components that were included in the load transfers from the roof slab

Comparing the strength of the roofing pavers, pedestals, and roof slab gives the maximum allowable weight of any one sculpture. Comparing the strength of the roof slab and any structural components included in the load path gives the maximum allowable weight multiple sculptures in each zone on the roof. The loads in each zone transfer to a different structural member. After determining the maximum allowable weight in each zone, we combined some of the zones in order to simplify the final design.

Besides determining what would be on the roof of Building B, we had to determine how people would get on and off the roof. To provide egress from the sculpture garden, we used the fire code requirements to determine how many means of egress would be needed. We also investigated the handicap accessibility of Building B and compared them with the current ADA requirements. In addition to the fire code and ADA requirements, we also wanted to create a way to transport the sculptures to the roof.

Analysis and Results

The results section is organized similarly to the Methodology section. We first discuss the site visit to the FAC, then the structural analyses of the Art Studio Building and Building B. Lastly, we discuss the new design of the sculpture garden, including the new roofing design as well as other design aspects.

Site Visit

Overall, the concrete of the building is in good condition with a few localized exceptions. The following summarizes our key observations of the four elevations. The North and South façade extend 646 ft while the West and East façade illustrate the triangular shaped roof, see Figure 32. Reference Figure 32 when elevations are referred to throughout the observations.

NORTH ELEVATION

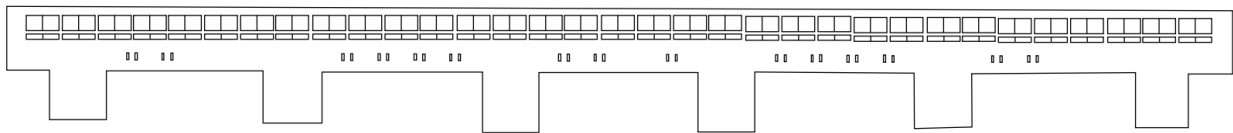

SOUTH ELEVATION

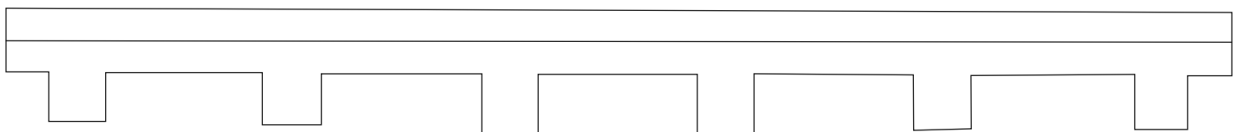

EAST ELEVATION

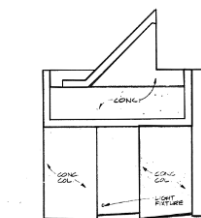

WEST ELEVATION

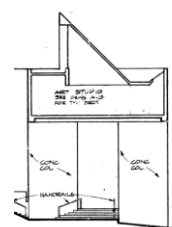



Figure 32: Art Studio elevations.

Adapted from Kevin Roche John Dinkeloo and Associates 1970, Drawing A11 and Drawing A12.

We noted multiple cracks on all four elevations of the Art Studio Building and on the concrete ribs running on the underside of the bridge. The cracks observed incorporated hairline cracks, larger cracks, vertical cracks, and horizontal cracks. See Appendix D for the location of all observed exterior cracking.

Table 1: Cracks Observed

<i>Cracks</i>	
<u>Observation</u>	<u>Photo</u>
<p>A long horizontal exterior crack running North to South along the ribs on the underside of the Bridge outlined with a yellow box.</p>	
<p>A long horizontal interior crack running North to South along the hallway floor slab of the Bridge.</p>	

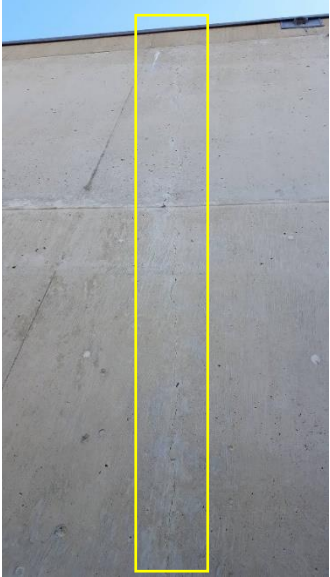
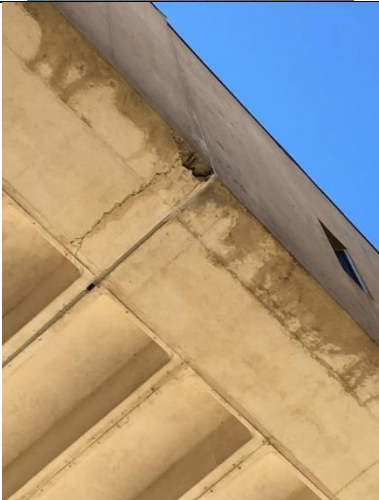
<p>A vertical long crack, outlined by the yellow box, running top to bottom located on the West Elevation of the Bridge</p>	
<p>A large crack and potential spall running North to South near an expansion joint on the underside of the Bridge.</p>	

We observed 18 horizontal cracks running North to South along the underside of the art studio bridge and along the interior of the art studio (Table 1 **Error! Reference source not found.**). The horizontal cracks observed on the interior and exterior are not the same crack due to the following reasons. First, we observed 5-10 interior cracks per art studio room as well as multiple long interior cracks running along the hallway as shown in Table 1.2. We observed and recorded 22 exterior cracks as shown in Appendix D. The exterior cracks were much more spread out along the 646 ft Art Studio Bridge and did not extend as long. Overall, we observed more interior cracks than exterior cracks. Second, according to the drawings, there is a layer of insulation between the exterior concrete ribs and the

interior concrete floor slab, meaning that the interior concrete and exterior concrete are two separate pours (Figure 33Error! Reference source not found.).

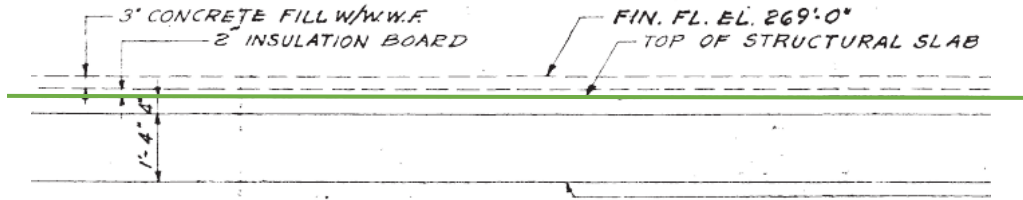

Figure 33: Cross-Section C1-1 showing the exterior (below the green line) and interior (above the green line) layers of the Art Studio floor.

Adapted from Kevin Roche John Dinkeloo and Associates 1970, Drawing S16.

The Cross-Section show that there are two different concrete members separated by the green line that represents the top of the exterior concrete slab. The horizontal cracks on the exterior and interior do not match up. This is an important observation because it illustrates that the exterior rib cracks do not extend through the entire width of the concrete and does not indicate a localized structural failure.

Table 2: Spalls and General Deterioration

<i>Spalls and General Deterioration</i>	
<u>Observation</u>	<u>Photo</u>
Concrete beginning to spall underneath the Ramp leading to the Side door on the East Elevation	

A second area of concrete beginning to spall underneath the Ramp leading to the Side door on **the East Elevation**



We observed signs of possible general deterioration in various areas on the building. Certain patches of the bridge and the walls of the rest of the building appeared rougher and slightly eroded with more sand and aggregate being visible. This may be due to a combination of the freeze-thaw cycle that New England experiences often and heavy exposure to the weather such as wind and rain. Overtime, the top layer of the concrete cement paste diminishes and the thickness of the concrete covering over the underlying reinforcement decreases.

One area of concentrated deterioration and a developing spall we found was located on the East Entrance Ramp leading up to Building B, outlined in a red box on Figure 34.

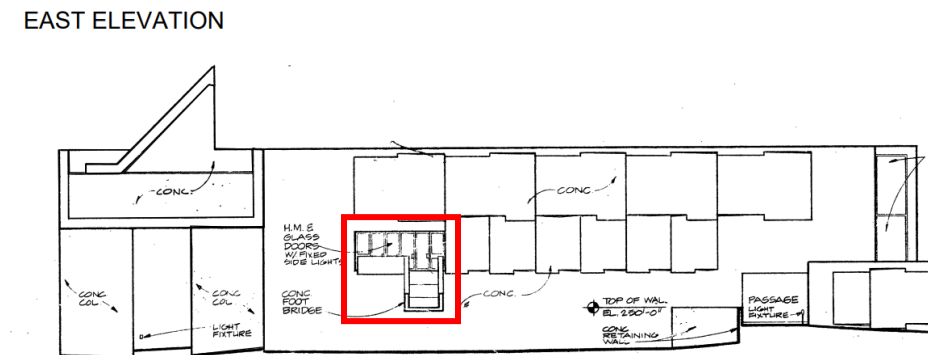





Figure 34: East elevation entrance ramp outlined by the red box.

Adapted from Kevin Roche John Dinkeloo and Associates 1970, Drawing A12.

Spalls are pieces of a building that have become detached from the concrete element and underlying reinforcement making spalls potential falling hazards. Possible causes of spalls pictured in Table 2 could include stress from the constantly changing live loads of people entering and leaving Building B. The

dark staining in the pictures indicate water leakage and the rust staining indicates underlying corroded steel. A second possible cause for the spalled concrete is that there is little to no concrete cover over the underlying reinforcement. We were unable to access the underside of the ramp to confirm one cause over the other. An excessive amount of spalling if not maintained could prove disastrous for the entrance ramp in the future; as this is a major egress route used by U-Mass Amherst faculty and students.

Table 3: Exposed Rebar and Past Repairs



<u>Observation</u>	<u>Photo</u>
Exposed rebar and deterioration of the concrete on the East Elevation Wall	
Evidence of previous spall repairs on South Elevation near entrance stairs.	
Evidence of previous spall repairs on the triangle supports under the Bridge.	

According to the Field Reports issued during February 1971 through January 1972, many issues were found concerning concrete construction work (A period Examination... pg.152). For example, entries from June 3 and June 10 require the formwork to be tighter to reduce stone pockets and loss of matrix. August 26 and September 9 entries refer to concrete formwork not being cleaned or repaired prior to placing columns. An important entry from the old field reports is from June 3, 1971 point 4-j which states, "A minimum of 1" cover for slab reinforcing steel is still not being maintained due to incorrectly sized slab bolsters."⁴³ This is one potential cause for the exposed reinforcement observed on the site visit, shown in Table 3. The past repairs shown in Table 3 are evidence of previous spalls or large cracks.

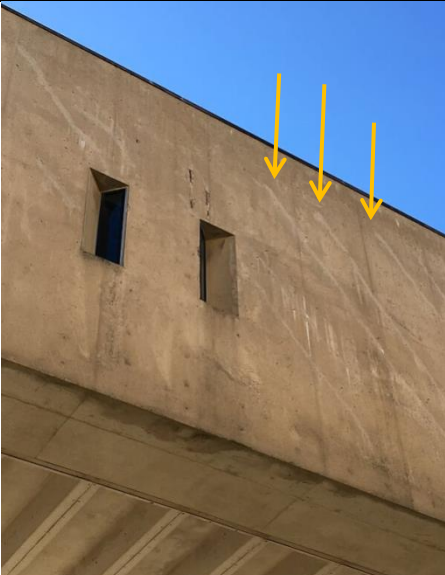
Table 4: Heavy Staining and Efflorescence

<u>Observation</u>	<u>Photo</u>
Efflorescence (indicated with yellow arrows) located on the North Elevation of the Bridge.	

⁴³ L Carl Flocchi, Jr., "A Period Examination Through Contemporary Energy Analysis of Kevin Roche's Fine Arts Center at University of Massachusetts-Amherst" (doctoral dissertation, UMass Amherst, 2016), 828. http://scholarworks.umass.edu/dissertations_2/828

<p>Dark Staining on South Elevation under copper flashing</p>			
<p>Dark Staining on the interior ceiling of Art Studio 435</p>			

The Fine Arts Center has an abundance of efflorescence on all sides of the building. The white streaks are numerous, especially on the bridge. Efflorescence is caused by excess water soaking into the concrete structure. The water migrates to the surface collecting salt along the way. When the water evaporates, the crystalline salt brought to the surface stains the concrete white. Efflorescence itself is not a structural issue, but the excess water that causes it can also cause internal rebar and structural damage that does not always show on the exterior of the building. Noticing efflorescence in multiple places all along the wall is an aesthetic issue that creates an unclean visual. Beyond that, the walls showed generally staining with no signs of damage in those areas.

We also observed efflorescence during the visual interior inspection of the art studio spaces as shown in Table 4. The interior consists of a long hallway expanding from one end of the bridge to the

other with art studio spaces on the South side. Staircases, restrooms, and offices branch off the main hallway as shown in the 2011 Floor Plan.⁴⁴ (Figure 35).

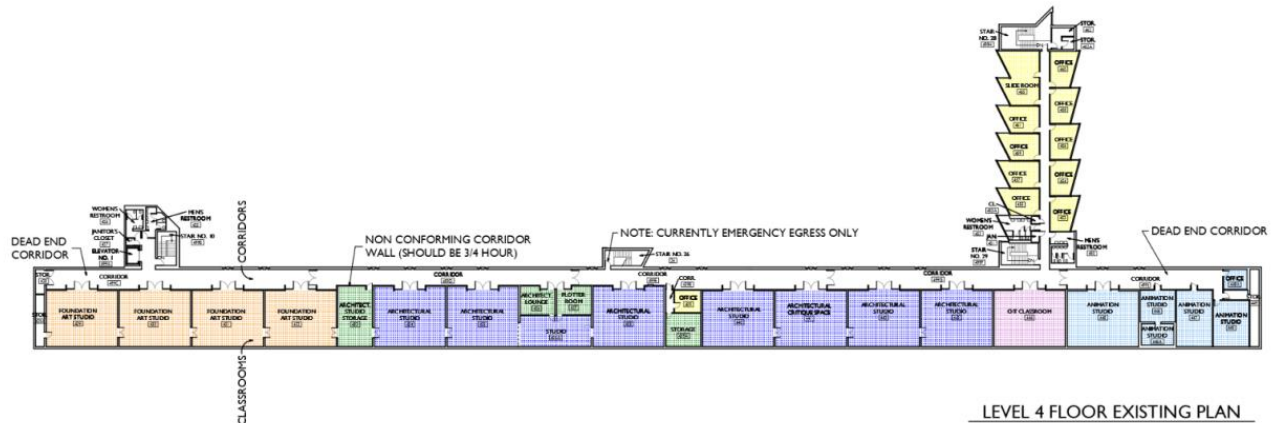

Figure 35: Art Studio Building fourth floor plan.

Dietz & Company Architects, Inc. 2011.

Many of the mechanical systems are exposed, and the floor is polished concrete. The North wall of the building is painted concrete with small windows, and it borders the hallway. The wall that separates the hallway and the studios is also painted concrete, and the walls separating the studios are drywall. The South wall is concrete covered in panels used as pin boards. Looking up, the ceiling above the hallway is flat exposed concrete. In the studios, the ceiling slopes up to large North-facing windows and small South-facing windows. We observed that the ceiling and glazing in the studios are supported by beams perpendicular to the exterior walls, but do not appear to have any supports other than those. The ceiling is exposed concrete and has acoustic panels attached to it (See Figure 36 **Error! Reference source not found.**). The ceiling and floor show cracking and staining.

⁴⁴ Dietz & Company Architects, Inc.



Figure 36: North-facing window and acoustic panels inside one of the studios.

In conclusion, there are no major cracks, spalls, or deteriorations that suggest the structure is not at full capacity. However, we recommend that the façade of the Fine Arts Center be frequently surveyed for potential safety hazards such as spalls and loose materials. Spot repairs and treating the underlying steel to reduce the rate of steel section loss will continue to be a common repair. To reduce the rate of deterioration of concrete and expectantly decrease the number of future repairs, corrosion inhibiting products and clear-water repellent sealers can be used.

Structural Analysis – Art Studio Building

In conclusion, the following table represents all the calculated applied loads and design capacities for each member. All the applied loads are less than the design capacities, which means the structure can support the loads it carries.

Table 5: Art Studio Structural Analysis Results

Vertical Loads		
Item	Current applied loads Kip-ft	Current load capacity Kip-ft

Roof	349	
Column Wall Panel	5,974	15,368
Column Wall Panel	1,518	2,626
Floor Rib	71	139
Item	Current applied loads Kips	Current axial capacity Kips
Support Column	20,932	25,390
Wall Footing	256	343
Buttress Footing	5,593	27,620

The calculated results for the wind loads are represented in Figure 37. Error! Reference source not found. Error! Reference source not found.. Error! Reference source not found.

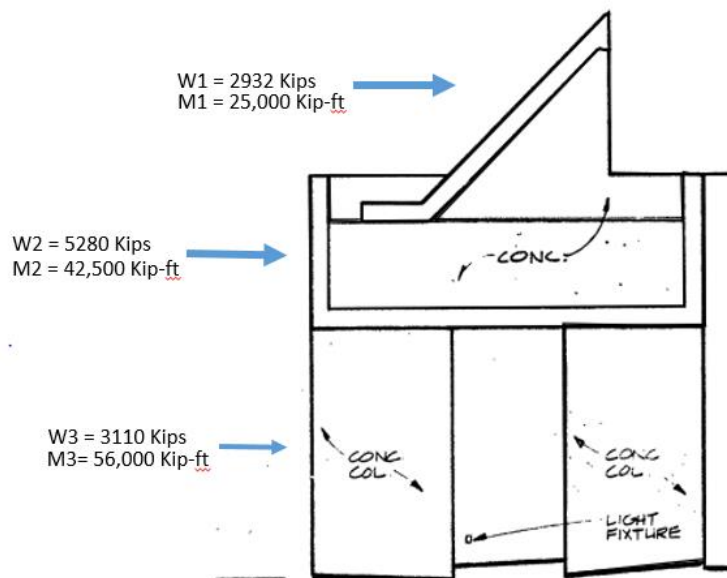

Figure 37: Wind load combination results.

Adapted from Kevin Roche John Dinkeloo and Associates 1970, drawing A12.

Structural Analysis – Building B

After analyzing all columns within Building B, we concluded that these columns are not in danger of cracking due to the current axial loads applied to them. Additionally, despite applying a larger live load and waterproofing details to the roof through this new design, the columns would continue to support the axial loads. In the table below, these numbers represent the current and new applied loads

on the columns, as well as the load capacity of the columns. Each column's load capacity is larger than both applied loads, confirming the structural feasibility of this design. Example calculations that show the process of finding these results can be found in Appendix H.

Table 6: Applied Loads and Load Capacities for Columns in Building B

Item	Current Applied Loads Current P_u (k)	New Design Applied Loads New P_u (k)	Current Load Capacity ΦP_n (k)
Column BC-14 (3F-1)	59.62	101.09	499.3986705
Column BC-13 (3F-2)	59.10	100.21	499.3986705
Column BC-12 (3F-3)	57.74	97.90	499.3986705
Column BC-11 (3F-4)	57.16	96.92	499.3986705
Column BC-10 (3F-5)	57.65	97.75	499.3986705
Column BC-9 (3F-6)	55.91	94.81	499.3986705
Column BC-14 (2F-1)	162.09	203.56	499.3986705
Column BC-13 (2F-2)	160.71	201.81	499.3986705
Column BC-12 (2F-3)	157.06	197.23	499.3986705
Column BC-11 (2F-4)	155.50	195.26	499.3986705
Column BC-10 (2F-5)	156.82	196.92	499.3986705
Column BC-9 (2F-6)	152.17	191.06	499.3986705
Column BC-6' (LF-1)	50.36	50.36	875.791488
Column BC-6 (LF-2)	50.24	50.24	875.791488
Column BC-5' (LF-3)	65.04	65.04	875.791488
Column BC-5 (LF-4)	64.88	64.88	875.791488
Column BC-4 (SF-3)	123.86	123.86	544.2096705
Column BC-3 (SF-4)	87.34	87.34	544.2096705
Column BC-2 (SF-5)	89.74	89.74	544.2096705
Column BC-1 (SF-6)	90.15	90.15	544.2096705
Column BC-6 (SF-1)	119.80	119.80	875.791488
Column BC-5 (SF-2)	127.50	127.50	875.791488
Column BC-6 (Fd-1)	188.66	188.66	875.791488
Column BC-5 (Fd-2)	186.62	186.62	875.791488
Column BC-4 (Fd-3)	204.62	204.62	544.2096705
Column BC-3 (Fd-4)	166.04	166.04	544.2096705
Column BC-2 (Fd-5)	171.08	171.08	544.2096705
Column BC-1 (Fd-6)	167.63	167.63	544.2096705

After analyzing the applied moments and moment capacities of all beams in Building B, we were able to determine that they are all capable of withstanding the axial loads applied along the span of each member. Each moment capacity calculated was greater than the applied moments, meaning that the amount of bending each member endures is not enough to cause structural failure even with the

addition of new loads through our new design concept. Example calculations that show the process of finding these results can be found in Appendix H.

Table 7: Applied Moments and Moment Capacities for Beams in Building B

Item	Current Applied Moments Current Mu (k-ft)	New Design Applied Moments New Mu (k-ft)	Moment Capacity ΦM_n (k-ft)
Beam BB-13	40.859	40.859	915.6038115
Beam BB-6	2386.554	2815.769	9683.436852
Beam BB-5	2802.391	3305.866	22110.85609
Beam BB-4	2740.325	3232.407	22110.85609
Beam BB-3	2711.15	3198.21	22110.85609
Beam BB-2	2736.137	3227.362	22110.85609
Beam BB-1	2654.615	3131.017	22110.85609
Beam BB-12	40.859	40.859	915.6038115
Beam BB-14	73.68	73.68	4040.123823
Beam BB-15	84.248	84.248	4040.123823
Beam BB-16	50.764	50.764	4040.123823
Beam BB-17	56.956	56.956	4040.123823
Beam BB-18	53.205	53.205	4040.123823
Beam BB-19	58.944	58.944	4040.123823
Beam BB-20	58.693	58.693	4040.123823
Beam BB-21	64.162	64.162	4040.123823
Beam BB-8	274.008	274.008	11212.35888
Beam BB-10	0	0	2284.357133
Beam BB-9	325.053	325.053	11212.35888
Beam BB-11	0	0	2284.357133
Beam BB-22	145.931	145.931	6282.880234
Beam BB-7	13.606	13.606	2648.534475

We found that the walls are far stronger than they need to be to meet the applied gravity and lateral loads. A summary showing the applied axial loads as well as the axial, shear, and bending strengths of the walls is in Table 25, Appendix H. The following table gives a summary of the wind loads:

Table 8: Summary of Wind Loads

Wall	Applied Wind Load	Shear Capacity	M from wind (ft-k)	ΦM_n (ft-k)
Wall 3A	7.86 k	13,300 k	47.16 k	6,056 k
Wall 3B	4.78 k	5,570 k	28.68 k	1,342 k
Wall 3C	4.78 k	4,647 k	28.68 k	793 k

Wall 3D	1.66 k	4,535 k	9.96 k	710 k
Wall 3F	3.72 k	6,288 k	18.70 k	1,431 k
Wall 3G	6.58 k	4,619 k	35.86 k	788 k
Wall 3H	3.32 k	13,300 k	19.92 k	6,056 k
Wall 3K	3.26 k	4,619 k	19.56 k	788 k
Wall 2A	7.21 k	13,090 k	39.63 k	6,056 k
Wall 2B	4.38 k	5,481 k	24.10 k	1,342 k
Wall 2C	4.38 k	4,573 k	24.10 k	793 k
Wall 2D	1.52 k	4,464 k	8.37 k	710 k
Wall 2F	3.41 k	6,189 k	15.71 k	1,431 k
Wall 2G	6.03 k	4,546 k	30.13 k	788 k
Wall 2H	3.04 k	13,090 k	16.74 k	6,056 k
Wall 2K	2.99 k	4,546 k	16.44 k	788 k
Wall 1A	1.11 k	6,803 k	4.45 k	1,892 k
Wall 1B	2.00 k	3,672 k	8.00 k	705 k
Wall 1C	3.54 k	4,279 k	14.16 k	793 k
Wall 1D	1.52 k	4,464 k	8.37 k	710 k
Wall 1F	1.89 k	6,189 k	15.71 k	1,431 k
Wall 1G	6.03 k	4,546 k	30.13 k	788 k
Wall 1H	3.04 k	13,090 k	16.74 k	6,056 k
Wall 1I	31.22 k	12,249 k	124.88 k	6,056 k
Wall 1J	1.08 k	3,844 k	4.32 k	594 k
Wall 1K	2.99 k	4,546 k	16.44 k	788 k
Wall 1L	1.74 k	1,102 k	5.26 k	51 k
Wall 1M	1.86 k	3,950 k	5.26 k	671 k

The seismic analysis results showed that the structure meets today's codes.

Table 9: Seismic Analysis Summary

	Ground Floor and Storage Floor	Library Floor and all Floors Above
--	--------------------------------	------------------------------------

Required Load	31 k	230 k
Shear Strength	350,208 k	410,183 k

Comparing the wind and seismic loads, the total wind loads on the structure sum to 124 kips, and the seismic loads sum to 261 k. The wind loads govern in the design of most structures, but this building only has three levels that are completely above ground and exposed to the weather. Also, we used the wind load given in the original 1970 drawing set, today's requirements may be more conservative.

The results for the column footings are included in the following table. The wall footing results are included in Table 37, Appendix H.

Table 10: Column Footing Results

Footing	P_u (current)	P_u (new)	ΦV_n	ΦV_c	ΦM_n
BF-1	174 k	174 k	1,973 k	259 k	1,372 ft-k
BF-2	177 k	177 k	1,973 k	259 k	1,372 ft-k
BF-3	172 k	172 k	1,973 k	259 k	1,372 ft-k
BF-4	211 k	211 k	1,973 k	259 k	1,372 ft-k
BF-5	196 k	196 k	3,127 k	476 k	1,978 ft-k
BF-6	203 k	203 k	3,909 k	476 k	2,311 ft-k

For the roof slab analysis, we modeled a random 1 ft slice of the roof slab and treated it as a beam in order to find the capacity. The moment on the beam due to the distributed load on it is 10 ft-k, and the beam's moment capacity is 73.5 ft-k. These give a maximum allowable point load of 13.5 k.

Next, we had to determine how much additional weight each zone could support. We calculated how applying a point load will affect the members in the load path, comparing the effect to the capacity of each affected member, we can calculate the maximum load to be applied. The following diagram and table show the zones on the roof, and what the limiting members and loads are for each zone. The zones are determined by the tributary areas of the walls and columns that support the roof

slab. Each zone transfers to a different structural member, which is shaded in the same color as the zone it is associated with.

BUILDING B/ART BUILDING ROOF FRAMING PLAN

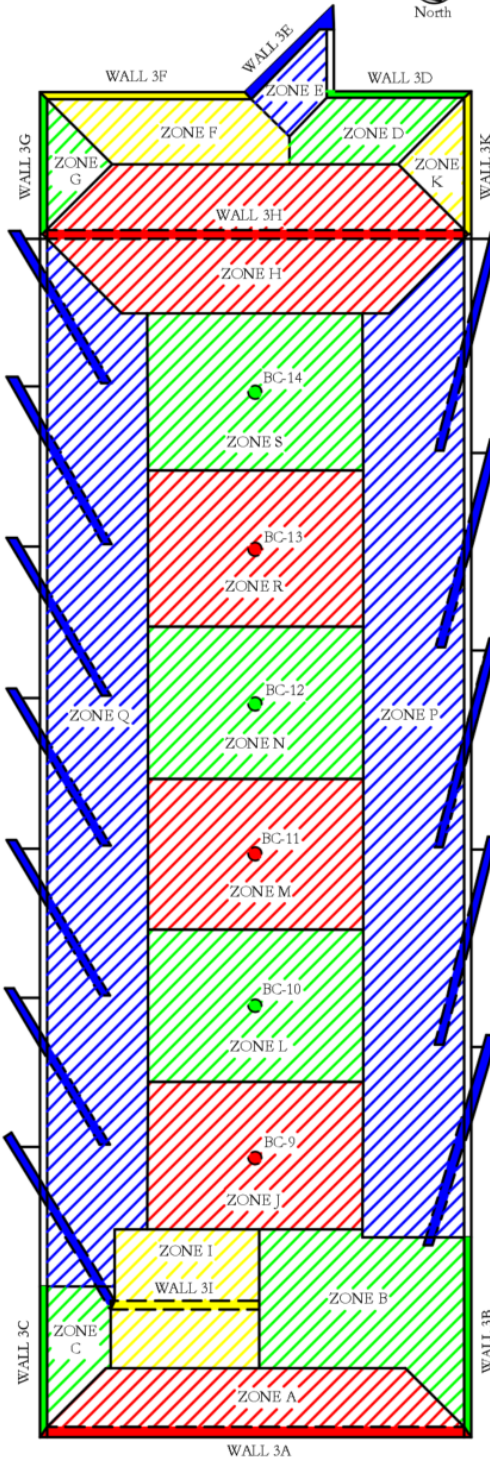

Figure 38: Roof framing plan showing zones.

Table 11: Maximum Allowable Axial Loads in Each Zone

Zone	Limiting Member	Max. P
A	Footing FA	1,417 k
B	Footing FB	1,213 k
C	Footing FC	1,553 k
D	Footing FD	1,555 k
E	Wall GE	1,777 k
F	Footing FD	1,555 k
G	Wall 1G	2,093 k
H	Footing FH	1,601 k
I	Footing FI	1,842 k
J	Column BC-9	314 k
K	Footing FK	1,344 k
L	Column BC-10	309 k
M	Column BC-11	310 k
N	Column BC-12	309 k
P	Footing FK	1,344 k
Q	Footing FG	2,163 k
R	Column BC-13	304 k
S	Column BC-14	302 k

Some of the walls and footings were part of the load path of more than one zone, as shown in the following table.

Table 12: Members in More Than One Load Path

Member	Zones	Max. P
Wall 1P	B, J, L, M, N, P, R, S	16,122 k
Wall LP	B, J, L, M, N, P, R, S	13,921 k
Wall GP	B, J, L, M, N, P, R, S	7,558 k
Wall SR	J, L, M, N, P, R, S	6,389 k
Wall GR	J, L, M, N, P, R, S	6,018 k
Footing FK	J, K, L, M, N, P, R, S	2,006 k
Wall 1Q	J, L, M, N, Q, R, S	16,189 k
Wall LQ	J, L, M, N, Q, R, S	13,994 k
Wall GQ	J, L, M, N, Q, R, S	7,608 k
Wall SS	J, L, M, N, Q, R, S	6,469 k

Wall GS	J, L, M, N, Q, R, S	6,097 k
Footing FG	J, L, M, N, Q, R, S	4,666 k
Footing FS	J, L, M, N, Q, R, S	4,760 k

So, we revised the zones in order to reflect the strengths of these shared members. The revision also combined some zones that have independent load paths for the sake of simplicity. This allowed us to split the roof into five zones for the final design. The following table and diagram show these revised zones and the total allowable weight that can be added to each zone.

Table 13: Revised Zones

Old Zones	New Zone	Total Allowable Load
D, E, F, G, H	1	1,550,000 lb
Q	2	2,00,000 lb
J, L, M, N, R, S	3	300,000 lb
B, K, P	4	1,150,000 lb
A, C, I	5	1,400,000 lb

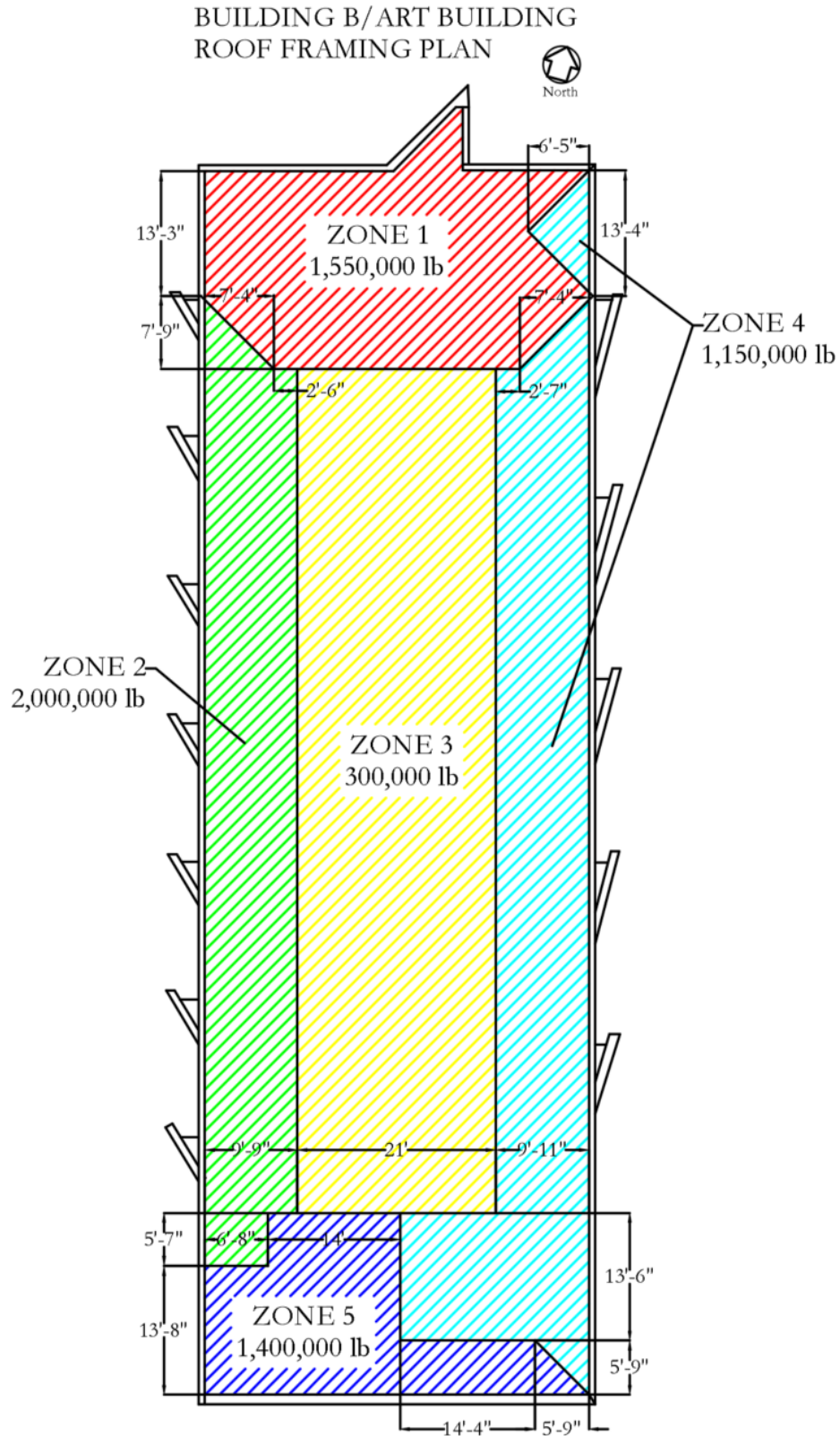

Figure 39: Roof plan showing revised zones.

New Design

To determine the maximum allowable weight of a single sculpture, we had to compare the maximum allowable point loads for the roof pavers, the pedestals that support them, and the roof slab.

The results are in the following table.

Table 14: Strength of Roofing Materials

Component	Maximum Allowable Point Load
Paver	42,000 k
Pedestal	2 k
Roof slab	13.5 k

In conclusion, the pedestals that support the pavers limit the weight of a single sculpture. Dividing a sculpture's weight by 2,000 lb will give the minimum number of pavers that the sculpture's base must rest on. This number does not include the live load on the paver.

Concept

Our new design for the roof top terrace of Building B creates a space for UMass Amherst students to display their artwork especially sculptures that interacts with the surrounding outdoor areas. This would incorporate several parts of the Fine Art Center as outlined by a red box in Figure 40, including the Art building roof (Building B), Library building roof (Building G), which makes up the plaza area, Music building roof (Building J), and the grass area on the East side of the building.

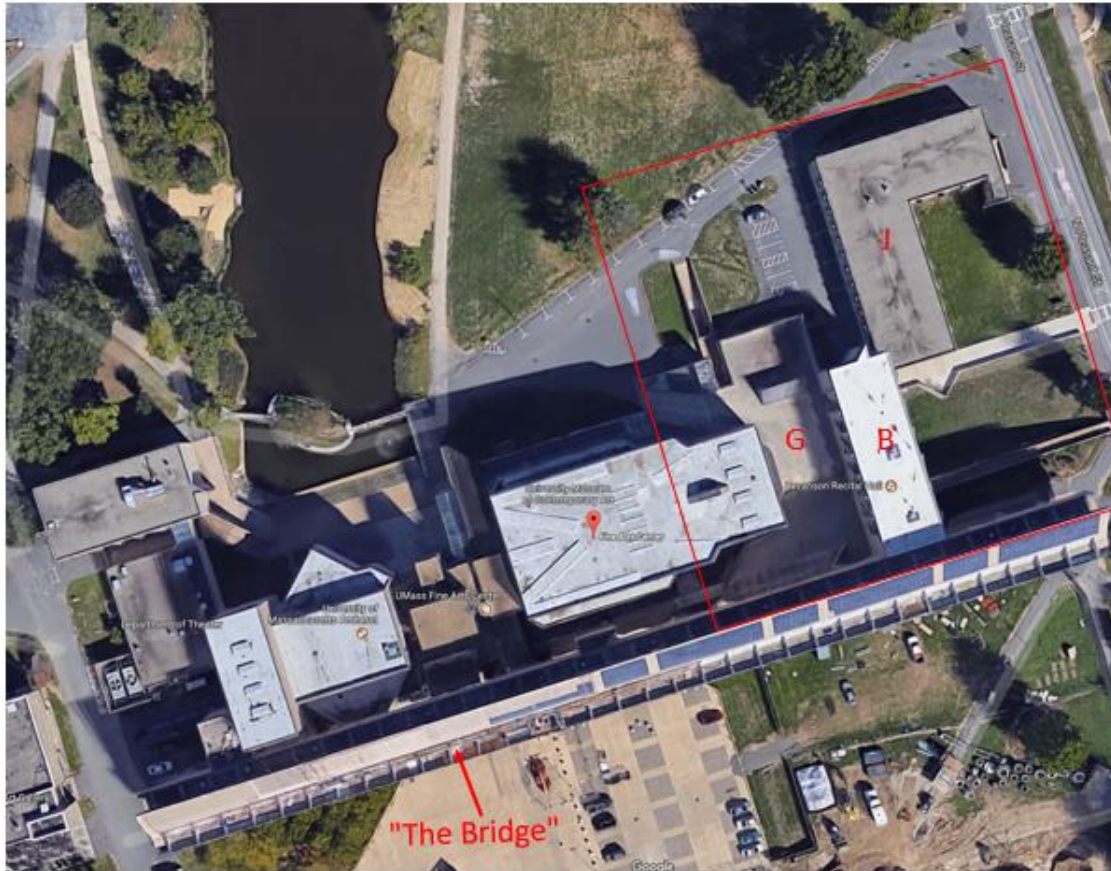

Figure 40: Aerial view of the Fine Arts Center.

Adapted from Google Maps.

Building B is the intended space where people will gather to view artwork created by students of the university. We wanted to create an experience and sense of peace for the occupants on the Building B rooftop terrace four stories above ground. To accomplish this task, we incorporated nearby roofs and surfaces with Building B's rooftop, ensuring connectivity between the Fine Arts Center's various structures and the surrounding U-Mass Amherst Campus. Additional green spaces along the east side of Building B and on the lake to the north were also incorporated into the design. As a part of this concept, the Music building's roof (Building J) will be a "green" or "living" roof featuring plantings. It will not be accessible to the public and, therefore, does not require any additional means of egress. The rest of the

space will be accessible to the public and will feature a rotating display of sculptures and art by UMass Amherst students.

One of the main goals of this design was to successfully combine safety components with egress requirements to create a code compliant space that was not only visually appealing, but also provided safe travel in and out of the space. Using research from the International Building Code (IBC) and the Life Safety Code (NFPA 101), this goal was achieved.

The space of interest is considered an Assembly occupancy with un-concentrated seating. This information was the base for all of our calculations. Using safety factors required for this type of occupancy, we were able to determine that the space can incorporate 335 occupants. Due to the number of occupants, two means of egress were necessary to make the building code compliant. These means of egress had to be spaced at least 66 feet away from one another, and had to be accessed from a distance of no more than 200 feet away for safety in the event of a fire or other hazard. These means of egress must have a width of at least 8.343 feet to safely evacuate the maximum number of occupants from the space. The last component of the means of egress was the number of stairs and landings. To be code compliant, 54 steps are needed to extend from the plaza to Building B's rooftop, and two landings must be incorporated to prevent structural instability. By following these guidelines, we were able to create safe means of egress that will allow occupants to access this new addition to the building.

The final design concept indicates three main points of egress. A spiral staircase on top of a redesigned entrance platform on the eastern side of the building. A staircase system on the north side of the building meant to provide a connection between the parking lot, the plaza level, and the top of Building B. Lastly, a freight elevator on the northern side connected to the plaza by a path attached to Building B's north wall.

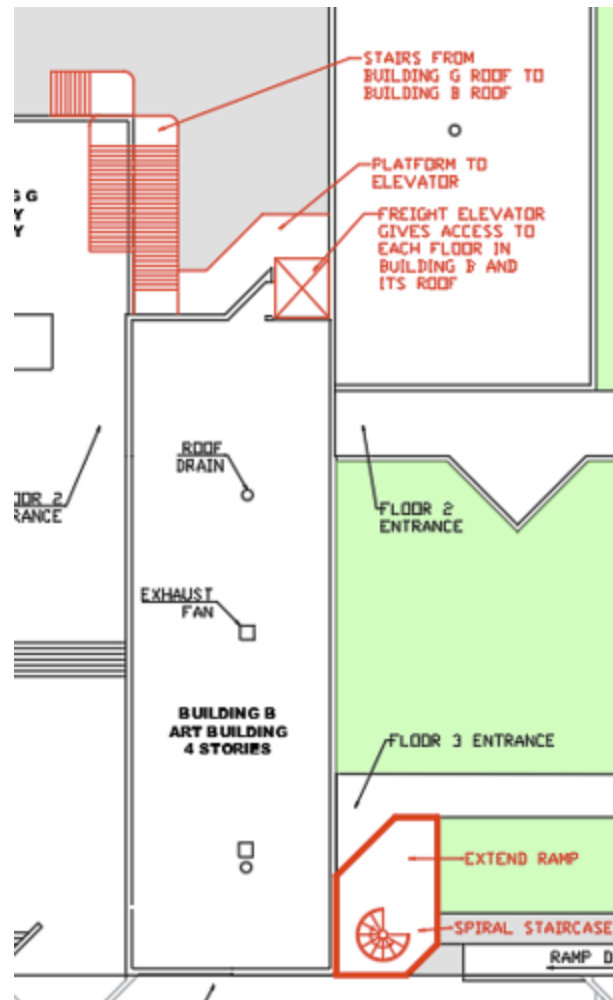

Figure 41: Site plan of Building B highlighting its three means of egress and elevator.

The freight elevator was due to a design challenge of how to make the space accessible to all. This means following ADA requirements and providing an elevator or ramp as a point of egress. During our site visit, we realized that the current ramp-elevator system for people with disabilities is a hassle. The only accessible entrance to the second highest level of the Art building is by an exterior ramp. So, if one wants to go to the top floor of the Art building from the floor below it, one must exit the building, travel down the ramp to the ground, go around to the other side of the Fine Art Center, take the elevator up to the top floor, and travel down the Art Studio building's long hallway to get back to the other side. Whether or not this is code compliant, it is simply unfair to those with disabilities.

The freight elevator located on the North side of Building B that will have access to the plaza level, the Art building's roof, and several levels within the Art building. The freight elevator will have two purposes, first to provide handicap accessible circulation and second, to aid in moving the art structures to the display areas. Another reason for including this elevator in design, is to include more levels in the Art building is to improve the handicap accessibility in the building for those with disabilities, those who are temporarily injured, and even for those who are pushing strollers or other rolling equipment.

The three points of egress integrate the rooftop space with the surrounding areas by offering access from multiple locations and levels. Providing safe means of egress to the rooftop will bring occupants up to the terrace to explore a sculpture garden and art pieces that students have spent countless hours working on. Providing a space for students to showcase their work in front of countless others is important for these creative thinkers, and designing a space for them to do this will definitely benefit those with a keen eye for art, as well as those who are looking for a quiet place to simply admire these works.



Figure 42: General rendering of Art Studio Building and Building B with new design.

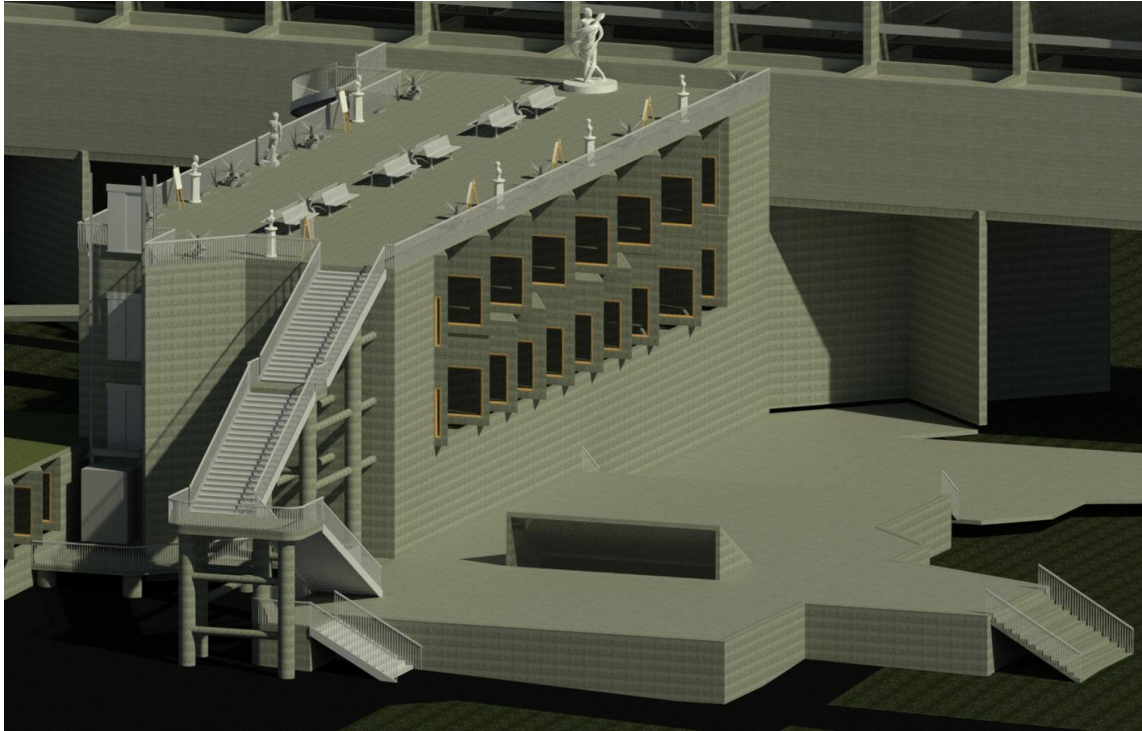

Figure 43: Closer view of access points on North wall.

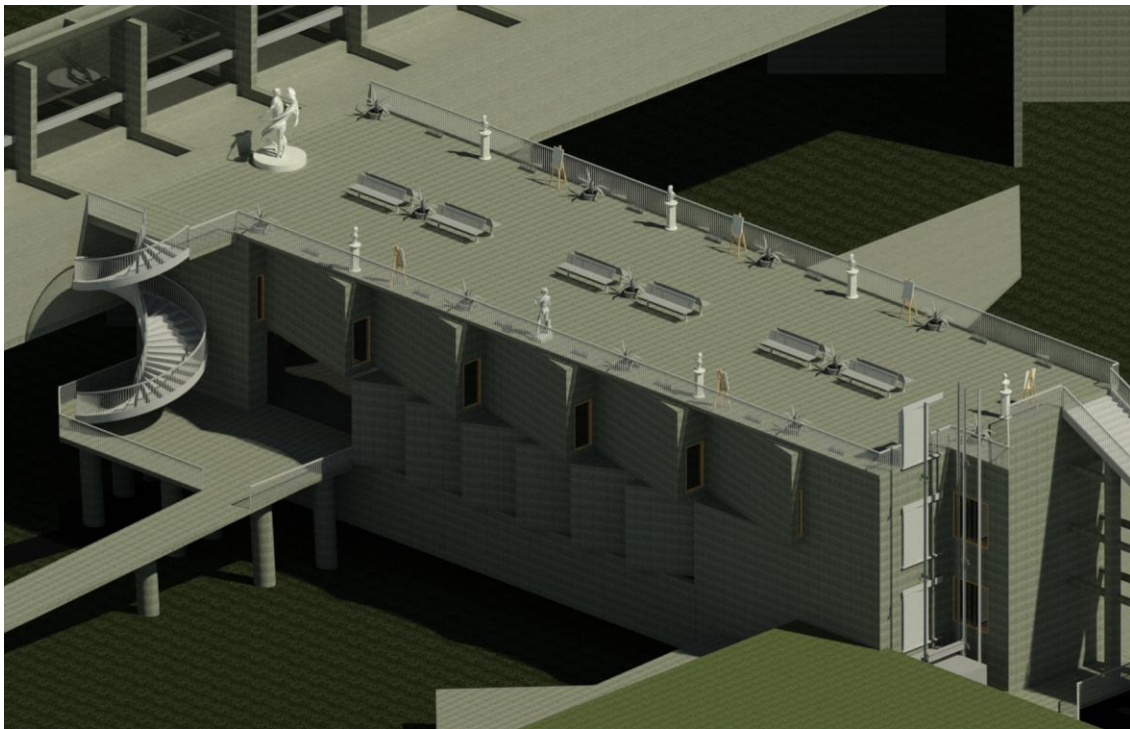

Figure 44: Closer view of means of egress on East wall.

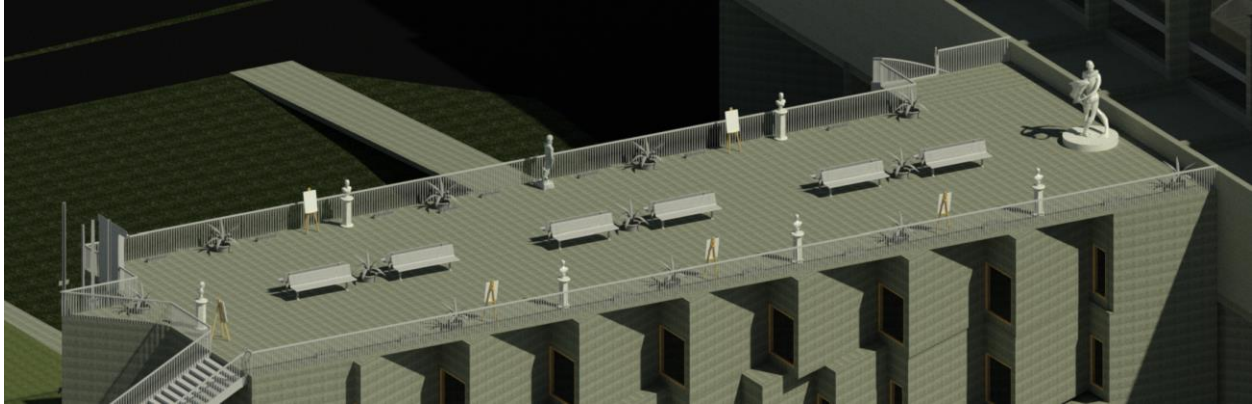

Figure 45: Closer view of a rooftop design layout example.

Circulation

We created a new design with additional means of egress to allow occupants to travel safely in and out of the roof space. To aid in describing how occupants could possibly use each egress component, we designed three different scenarios that identify a variety of possibilities for accessing the rooftop.

The first method to accessing the rooftop is from the north ([Figure 46](#)~~Figure 46~~). Occupants could either utilize the freight elevator if handicapped, or the various staircases now provided to allow quick and easy access to the terrace.

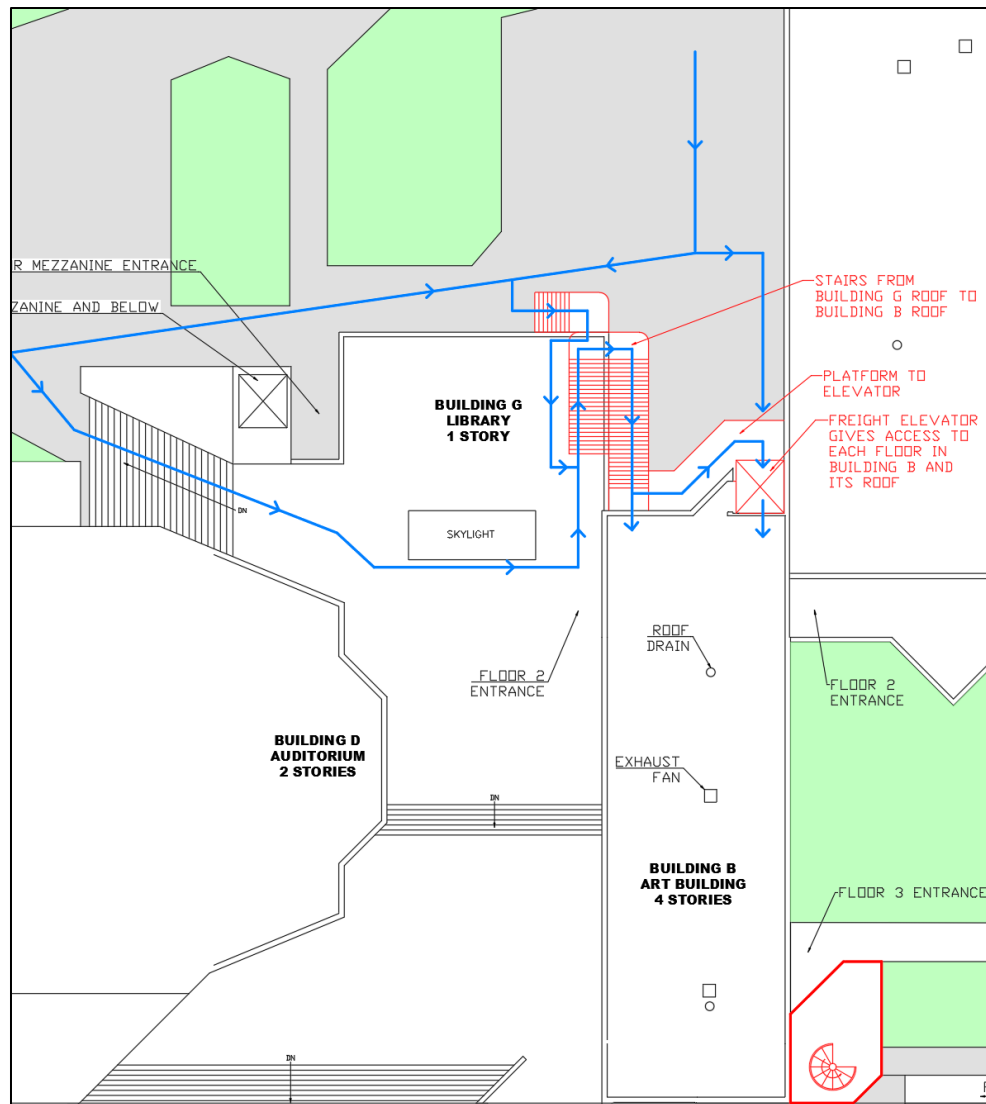

Figure 46: Circulation plan of the Northern stairs and elevator.

The next method to accessing the rooftop is via the east staircase (Figure 47) The spiral staircase on the East side of the building adds a permanent sculptural and architectural element to the design and improves circulation for students coming from the East. Occupants walking along the public access ways and sidewalks can converge at the ramp that leads up to an entrance inside Building B. The platform where this entrance is located is now extended and occupants can utilize the spiral staircase added to walk up to the rooftop terrace.

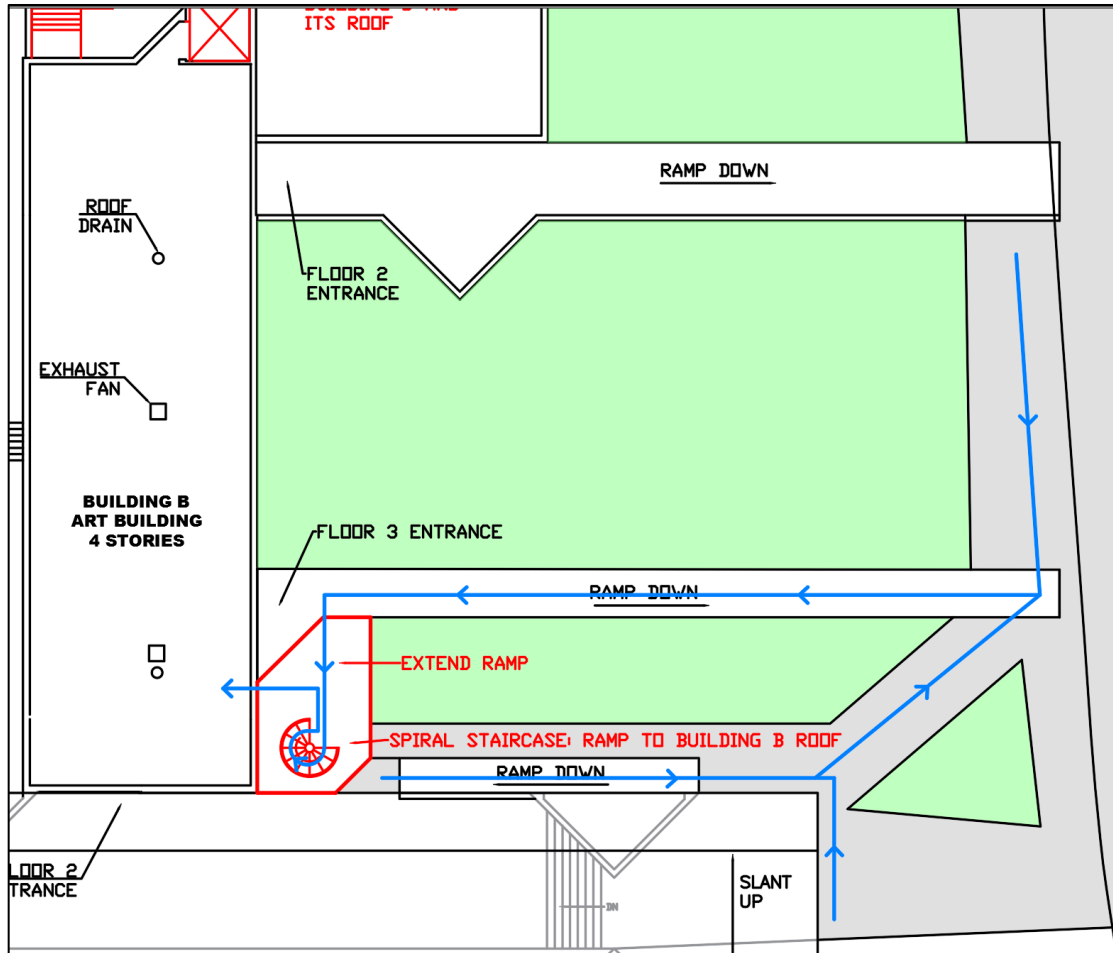

Figure 47: Circulation plan of the Eastern spiral staircase.

The last travel scenario involves those walking underneath the Art Studio Building (Figure 48). If occupants are coming from this direction, they may diverge in two different directions. Some may walk north up the stairs to the plaza and up the staircase to the roof, while others may walk east to walk up the ramp that holds the spiral staircase. Occupants would walk up this staircase and arrive at the roof as well.

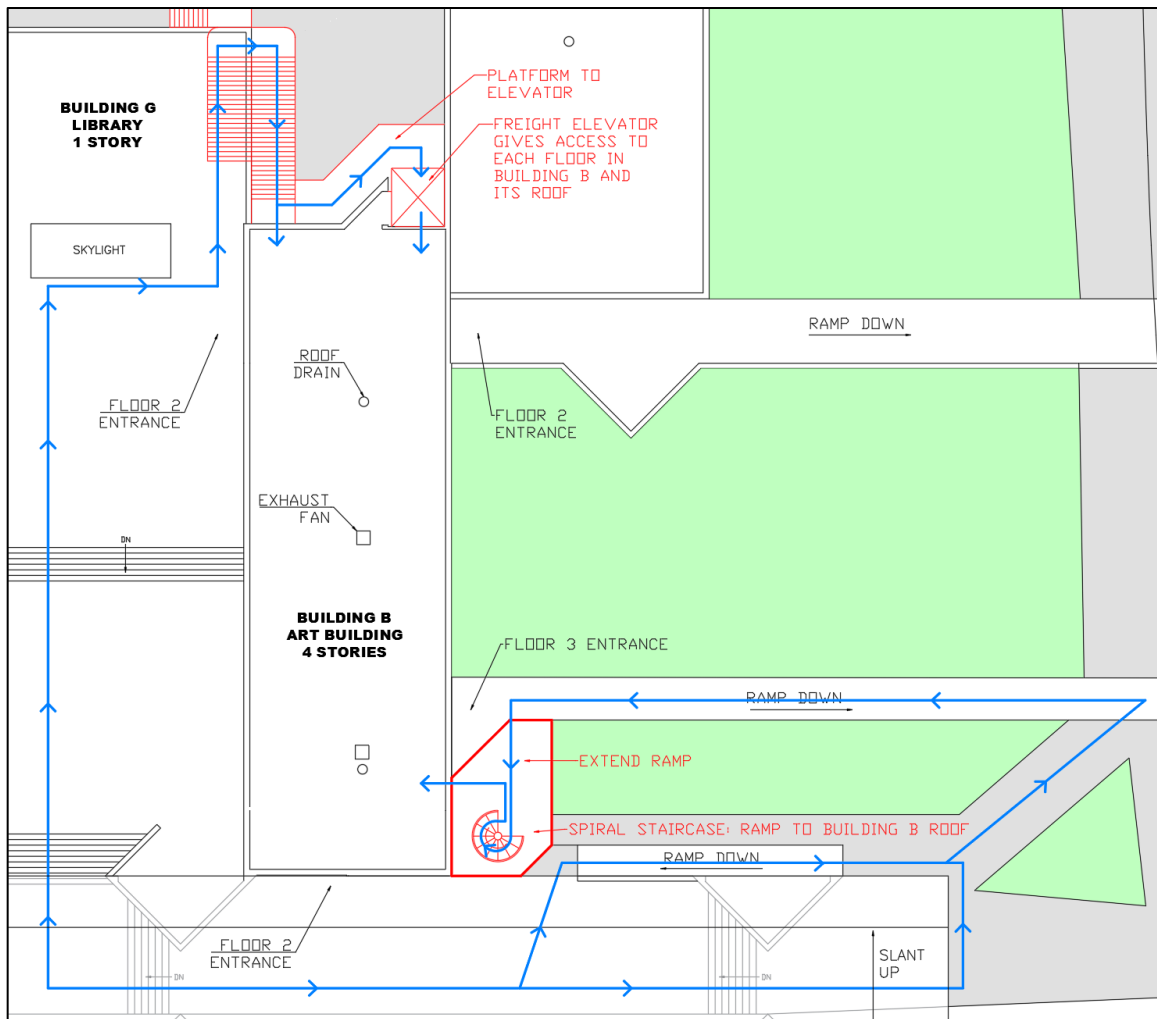

Figure 48: Circulation plan of occupants underneath Art Studio Building.

Evacuation Plan

To ensure that the means of egress would safely evacuate occupants while still complying with the codes, an evacuation scenario was created. The maximum distance allowed for travel to any given exit based on the codes is 200 feet. Figure 49 shows two locations where an occupant may be standing in the event of a hazard requiring evacuation. The distance from the closest exit is less than 200 feet in both cases, and this figure shows how we envision occupants to exit the space when necessary.

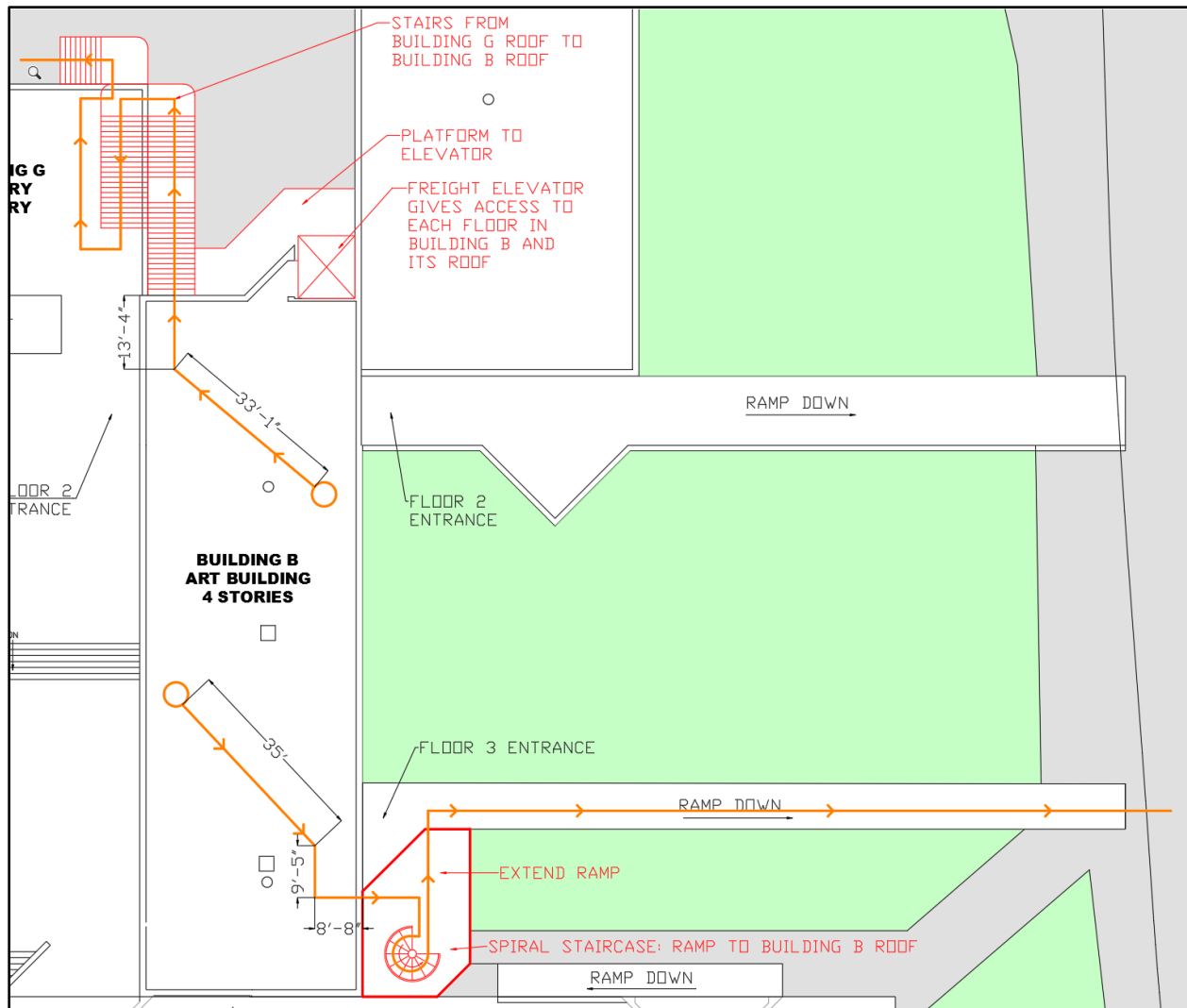

Figure 49: Two example scenarios for occupant evacuation in the event of a fire or other hazard

Waterproofing Roof System

Along with redesigning the purpose of Building B's roof we redesigned the roof system into a rooftop waterproofing system. We looked into Kemper System Waterproofing and decided to reference their recommended Terrace Waterproofing Assembly with insulation and overburden to determine the layers as seen in Figure 50. One challenge in the new design of the roofing system was how to achieve the required Massachusetts minimum R-value. According to the Massachusetts building code 780 CMR Chapter 13, the minimum insulation R-value requirement is R-30.

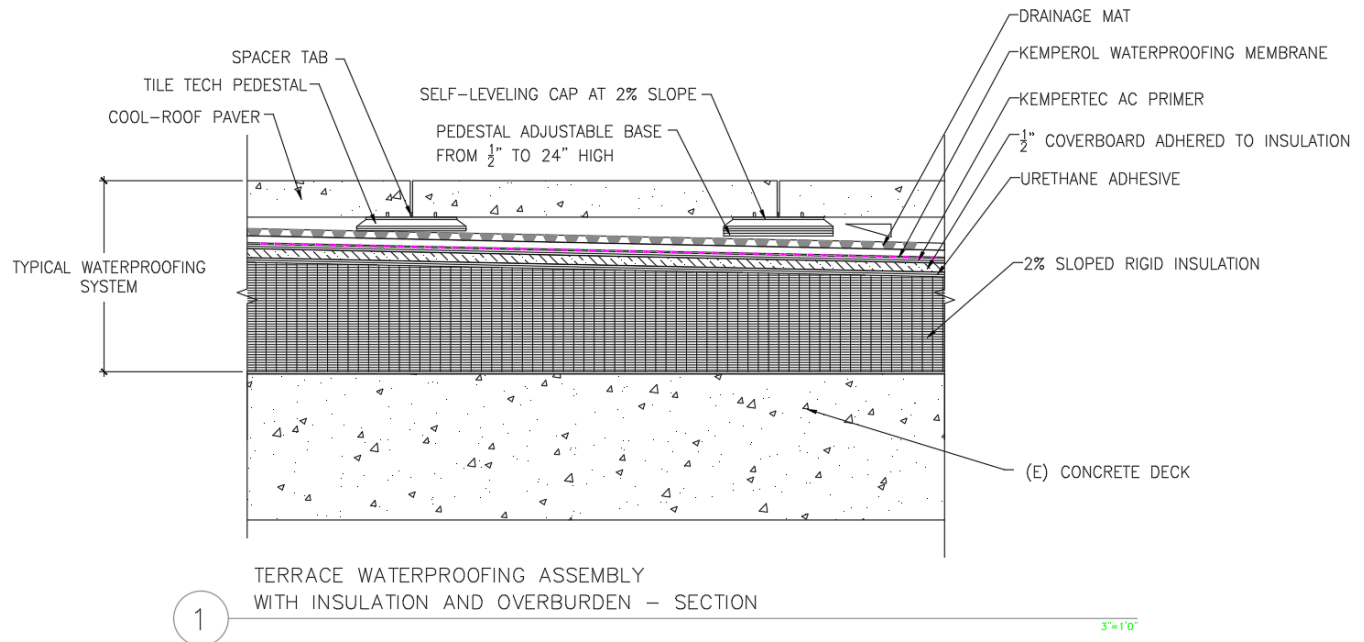
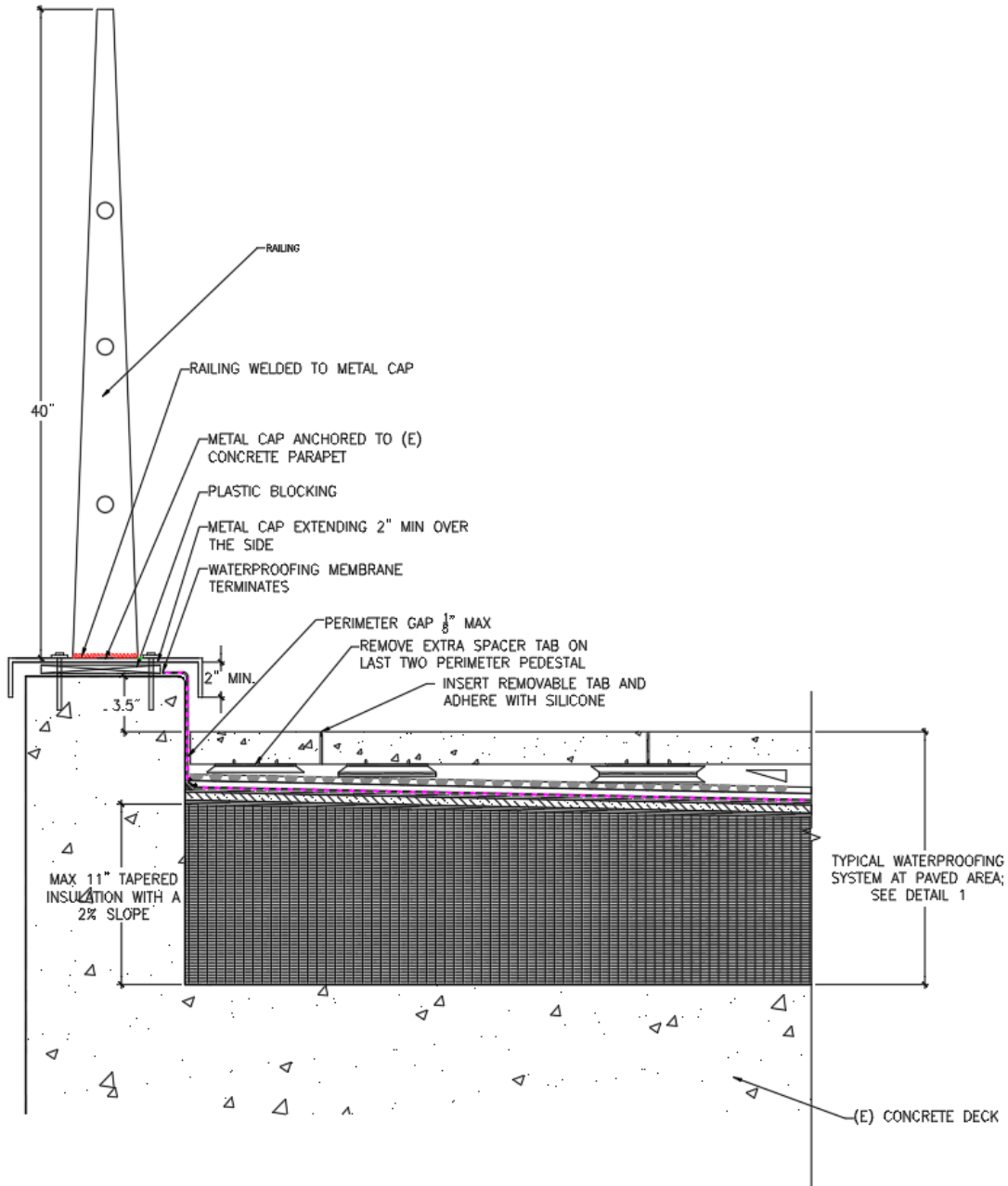

Figure 50: The layers of the new waterproofing roof system.

The product data for each layer is in Appendix J. The rubber pedestal and the pavers are from the Tile Tech Pavers. The pavers are a grey color from the Cool Roof Series and help reflect heat and light. The height of the rubber pedestals can be adjusted to account for the required 2% slope. The roof will slope down from the edge of the roof towards the two existing drains located in the middle of the roof as shown on the site plan in Appendix J. To achieve the 2% slope the insulation will be tapered going from a minimum of 5 inches near the drains to achieve the MA required minimum R-30 value to a maximum of 11 inches at the edge. The average R-value of the roof deck is higher than R-30 because in our design we tapered our insulation so the roof would slope towards the drain. Therefore the insulation at the drain is the thinnest and the insulation at the edge of the roof is the thickest. We made sure that the thinnest area of insulation met the required R-30 value.

One challenge in waterproofing a roof is figuring out how to end the membrane. Building B already has an existing 1'7" concrete parapet. For safety reasons an aluminum metal railing will be added on top of the existing parapet to reach the required height of 42 inches. The waterproofing

membrane will go up the existing parapet and end under the added metal cap and railing as show in Figure 51.



3 CONCRETE WALL FLASHING – SECTION

3/4"=1'-0"

Figure 51: Detail showing how the waterproofing system terminates at the edge parapet.

It is important to know the specific layers of the new roofing system for more than just waterproofing reasons. The new layers, especially the concrete pavers, will add weight to the roof and increase the overall dead load. The existing structure needs to be able to support the new dead load. The product data sheets for the membrane layers were used to calculate the weight of the new roof. The new weight of the roof is 27lbs/sq. ft and was added to the overall dead weight of the building. For the full calculation of the weight of the new roof see Appendix K.

Table 15: Weight of New Roofing Layers

<i>New Deck Layers</i>	<i>Total unit weight per Roof Area lbs/ft²</i>
Pavers	21
Pedestals	1.20
Drainage Mat	0.19
Kemperol Waterproofing	0.73
Kempertec AC Primer	0.09
Coverboard	0.38
Urethane Adhesive	0.03
Rigid Insulation	3.54
Total	27

Conclusions and Recommendations

Our project demonstrates that you can add usable space and bring new life to a historic building while making minimal alterations to the existing structure. Our design of a rooftop sculpture garden creates a new space for the Art department without creating a new building or adding on more stories to the existing building. The elevator that we designed improves the accessibility of Building B while staircases provide means of egress from the roof. The spiral staircase also adds even more architectural interest to the building and functions as a sort of sculpture itself.

For anyone looking to do a similar project, having accurate drawings of the existing conditions is essential. Because we were adding so much additional weight to the structure due to the occupants, roofing, and sculptures, we had to know the strength of the structure in order to get the most use out of the space. We also believe that it's important to preserve the architectural style of the building, even if it's not very popular among the public. The style and original intent of the design is part of its history and should be recognized. New additions or alterations should match the architectural style or at least not compete with it.

Bibliography

ACI Committee 318. *Building Code Requirements for Structural Concrete (ACI 318-14) and Commentary*

(*ACI 318R-14*). Farmington Hills, MI: American Concrete Institute, 2014.

American Society of Civil Engineers (ASCE). *Minimum Design Loads for Buildings and Other Structures:*

ASCE Standard ASCE/SEI 7-10. Reston, VA: ASCE, 2013. [https://ebookcentral-proquest-](https://ebookcentral-proquest-com.ezproxy.wpi.edu/lib/wpi/reader.action?ppg=104&docID=3115654&tm=1518643068604)

[com.ezproxy.wpi.edu/lib/wpi/reader.action?ppg=104&docID=3115654&tm=1518643068604](https://ebookcentral-proquest-com.ezproxy.wpi.edu/lib/wpi/reader.action?ppg=104&docID=3115654&tm=1518643068604).

American Wood Council. *Beam Formulas with Shear and Moment Diagrams*. Washington, DC: American

Wood Council, 2007. [http://www.awc.org/pdf/codes-standards/publications/design-aids/AWC-](http://www.awc.org/pdf/codes-standards/publications/design-aids/AWC-DA6-BeamFormulas-0710.pdf)

[DA6-BeamFormulas-0710.pdf](http://www.awc.org/pdf/codes-standards/publications/design-aids/AWC-DA6-BeamFormulas-0710.pdf).

Bruner/Cott Architects. "Richard A. and Susan F. Smith Campus Center." *Bruner/Cott Architects*.

Accessed March 22, 2018. <http://www.brunercott.com/projects/smith-campus-center/>.

Brutalism Online. "Robert Hutchings Goddard Library, Clark University, Worcester, Massachusetts."

Brutalism Online. Accessed March 23, 2018. [http://brutalism.online/brutalist-buildings/14-](http://brutalism.online/brutalist-buildings/14-usa/248-robert-hutchings-goddard-library-clark-university-worcester-massachusetts)

[usa/248-robert-hutchings-goddard-library-clark-university-worcester-massachusetts](http://brutalism.online/brutalist-buildings/14-usa/248-robert-hutchings-goddard-library-clark-university-worcester-massachusetts).

Campbell, Bradley. "The Ugliest Building on Harvard's Campus just might be its most Beautiful." *PRI's*

The World. Published September 29, 2013. [https://www.pri.org/stories/2013-09-29/ugliest-](https://www.pri.org/stories/2013-09-29/ugliest-building-harvards-campus-just-might-be-its-most-beautiful)

[building-harvards-campus-just-might-be-its-most-beautiful](https://www.pri.org/stories/2013-09-29/ugliest-building-harvards-campus-just-might-be-its-most-beautiful).

Dietz & Company Architects, Inc. "The Fine Arts Center Bridge." Classroom Conversion Study, Springfield,

MA, 2011.

Drew, Christine. "Pardon Our Dust this Summer as the Library Renovation Project Continues." *WPI*

Accessed September 26, 2017. [http://wp.wpi.edu/library/2010/04/30/pardon-our-dust-this-](http://wp.wpi.edu/library/2010/04/30/pardon-our-dust-this-summer-as-the-library-renovation-project-continues/)

[summer-as-the-library-renovation-project-continues/](http://wp.wpi.edu/library/2010/04/30/pardon-our-dust-this-summer-as-the-library-renovation-project-continues/).

Fiocchi, L Carl, Jr., "A Period Examination Through Contemporary Energy Analysis of Kevin Roche's Fine Arts Center at University of Massachusetts-Amherst." Doctoral dissertation, UMass Amherst, 2016. http://scholarworks.umass.edu/dissertations_2/828

"Footings Example 1." PDF.

Hamlette, Barry. "Library Renewal." *WPI*. Accessed September 26, 2017.

<https://www.wpi.edu/news/library-renewal>.

Hopkins Architects. "Harvard University: Richard A and Susan F Smith Campus Center." *Hopkins Architects*. Accessed March 23, 2018. <http://www.hopkins.co.uk/projects/2/204/>.

Kevin Roche John Dinkeloo and Associates. "Classroom and Laboratory Building Including Theater and Auditorium." Architectural drawing, Hamden, CT, 1970.

Kevin Roche John Dinkeloo and Associates. "Fine Arts Center University of Massachusetts." *Kevin Roche John Dinkeloo and Associates*. Accessed January 10, 2018.

<http://www.krjda.com/Sites/UMassInfo1.html>.

Nilson, Arthur H., et. al., *Design of Concrete Structures*, (Boston: MCGraw Hill Higher Education, 2010), 14th ed.

Page, Max. "The Ideals behind UMass Amherst's Stained Concrete." *The Boston Globe*. Published March 24, 2013. <https://www.bostonglobe.com/ideas/2013/03/23/the-ideals-behind-umass-amherst-stained-concrete/DsPhAdcV2FSTEv0LpsGUcP/story.html>.

Pukerson, Carrie Ann. "Historic Preservation of the Recent Past." Master's thesis, University of Florida, 2007.

"Richard A. and Susan F. Smith Campus Center at Harvard University." *Architect Magazine*. April 4, 2016. http://www.architectmagazine.com/project-gallery/richard-a-and-susan-f-smith-campus-center-at-harvard-university_o.

Rohan, Timothy M. *The Architecture of Paul Rudolph*. New Haven, CT: Yale University Press, 2014.

Shuster, H.M., et. al. "Report of the Library Vision Committee." Committee report, WPI, 2002.

S.K. Ghosh Associates. *CodeMaster: Seismic Design (2012 IBC and ASCE 7-10)*. Palatine, IL: A.K. Ghosh Associates, 2012.

Special Collections & University Archives. "Fine Arts Center." *UMass Amherst*. Last modified June 5, 2015. http://scua.library.umass.edu/youmass/doku.php?id=f:fine_arts_center.

Structural Steel Design, (McCormac & Brown), 9th ed., 129.

UMass Amherst. "Campus Maps." *UMass Amherst*. Accessed March 22, 2018.

<https://www.umass.edu/visitorsctr/campusmaps>.

UMass Amherst. "Fine Arts Center First Floor Plan." AutoCAD drawing, Amherst, MA, 2014.

The University of Memphis. "Axially Loaded Members." (PDF, Memphis, TN).

Utah Uniform Building Code Commission. *Building Code 2015 of Utah*. Utah Uniform Building Code Commission: Utah, 2015. <https://up.codes/viewer/utah/ibc-2015/chapter/16/structural-design#1605>.

Whiffen, Marcus. *American Architecture Since 1780: A Guide to the Styles*. Cambridge, MA: The MIT Press, 1969.

WPI. George C. Gordon Library. *WPI*. Accessed March 22, 2018.

<https://www.wpi.edu/about/locations/george-c-gordon-library>.

WPI. "Gordon Library @ 40." *WPI*. Accessed September 26, 2017.

<https://wpiarchives.omeka.net/exhibits/show/gordon40/timeline>.

WPI. "WPI Installs Worcester's First 'Living Green Roof' Atop New Residence Hall." *WPI*. Accessed September 28, 2017. <https://www.wpi.edu/news/greennews>.

Wxsl, Amdriw T. "Dcan Sert's Buildings." (sic) *The Harvard Crimson*. October 8, 1963.

<http://www.thecrimson.com/article/1963/10/8/dcan-serts-buildings-pover-the-past/>.

APPENDICES

Appendix A – Typical Structural Details, Notes, and Schedules

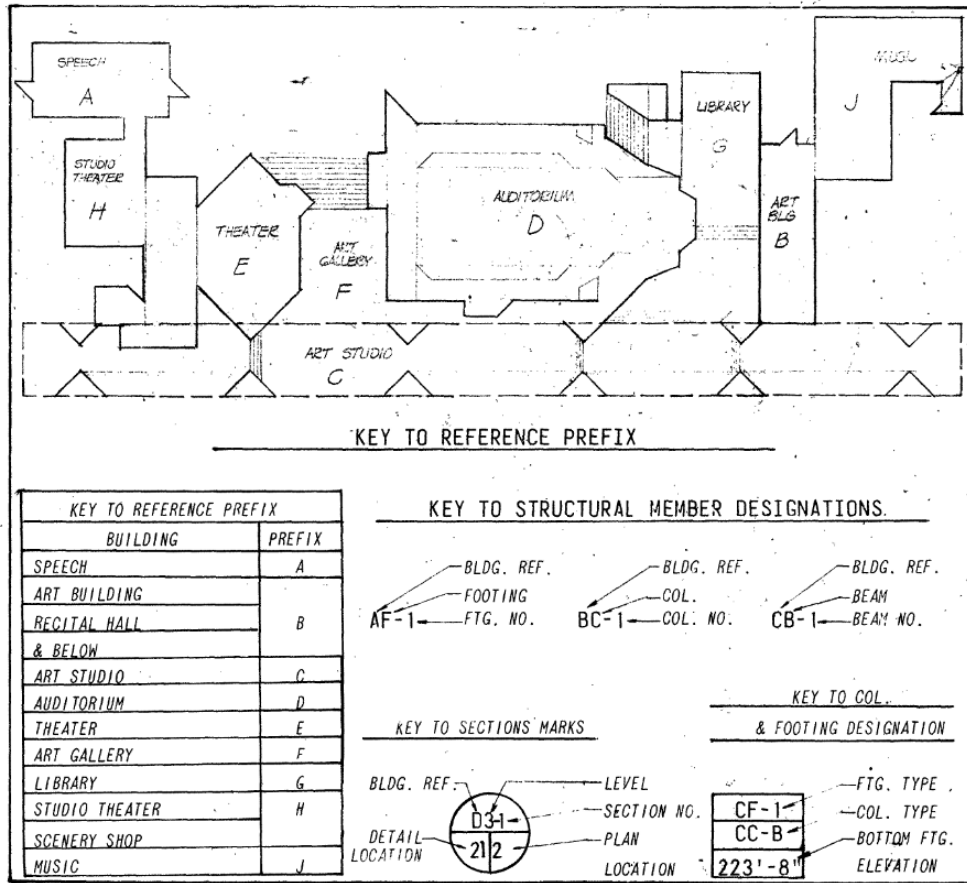



Figure 52: Key for structural drawings.

Kevin Roche John Dinkeloo and Associates, 1970, drawing S01.

GENERAL NOTES -

(INSTRUCTIONS AND INFORMATION OF GENERAL NATURE; FURTHER DETAILS WILL BE FOUND ELSEWHERE ON DRAWINGS AND IN SPECIFICATIONS.)

FOUNDATIONS

1. FOOTINGS ARE DESIGNED FOR A SOIL BEARING CAPACITY OF FOUR (4) TONS/SQ. FT.
2. CENTERS OF GRAVITY OF FOOTINGS AND SUPPORTED ELEMENTS SHALL BE CONCENTRIC UNLESS SHOWN OTHERWISE.
3. FOUNDATION DRAIN PIPES AND DIRECTION OF FLOW ARE INDICATED ON PLANS THUS: 

CONCRETE

1. CONCRETE STRENGTHS (PSI AT 28 DAYS AGE) SHALL BE AS FOLLOWS:

CLASS 1) ALL CONCRETE EXCEPT AS IN CLASS (2)	3000
CLASS 2) HORIZONTAL AND SLOPING SUPPORTED SLABS EXPOSED TO WEATHER	3000
2. PLACEMENT OF CONCRETE SLABS AND WALLS SHALL BE MADE IN CHECKERBOARD AND INTERMITTENT FASHION, RESPECTIVELY, BETWEEN CONSTRUCTION JOINTS. AND 24 HOURS (MINIMUM) SHALL ELAPSE BETWEEN PLACEMENTS OF ADJACENT SECTIONS.

REINFORCING STEEL

1. MINIMUM YIELD STRENGTHS (PSI) OF REINFORCING STEEL SHALL BE AS FOLLOWS:

-- (A) STIRRUPS AND TIES	40,000
(B) COLUMN SPIRALS, WELDED WIRE FABRIC AND ALL OTHER REINFORCING.	60,000
2. MINIMUM COVER OF CONCRETE OVER REINFORCING SHALL CONFORM TO ACI 318-63, ARTICLE 808, EXCEPT 2" MINIMUM WHERE FORMED SURFACES ARE TO BE EXPOSED TO WEATHER OR SOIL, AND 1" MINIMUM WHERE NOT SO EXPOSED.
3. REINFORCING STEEL SHALL BE PROVIDED IN ALL CONCRETE; WHERE NOT SHOWN OR DETAILED, SEE APPLICABLE SCHEDULES OF MINIMUM REINFORCING, TYPICAL AND/OR SIMILAR CONDITIONS, WHERE RESPECTIVELY APPLICABLE.
4. WHERE CONTINUOUS BARS ARE CALLED FOR, THEY SHALL BE RUN CONTINUOUSLY AROUND CORNERS, LAPPED 36 BAR DIAMETERS AT NECESSARY SPLICES OR HOOKED AT DISCONTINUOUS ENDS; LAP BEAM TOP BARS AT MID-SPAN AND BEAM BOTTOM BARS AT SUPPORTS.

STRUCTURAL STEEL

1. ALL WELDED CONNECTIONS SHALL BE SHOP-WELDED EXCEPT WHERE FIELD-WELDED CONNECTIONS ARE SHOWN ON THE DRAWINGS OR APPROVED.
2. ALL WELDS SHALL BE FULL PENETRATION WELDS (ADEQUATE TO DEVELOP FULL STRENGTH OF WEAKER MEMBER CONNECTED) UNLESS OTHERWISE SHOWN.
3. ALL BOLTS SHALL BE HIGH-STRENGTH ASTM A325, 3/4" DIAMETER MINIMUM SIZE UNLESS SHOWN OTHERWISE, BEARING TYPE CONNECTIONS. ANCHOR BOLTS INTO CONCRETE SHALL BE A307 OR A325 AS SHOWN; USE A325 WHERE NOT SHOWN.
4. SIMPLE BEAM CONNECTIONS SHALL BE DESIGNED AND DETAILED IN ACCORDANCE WITH THE SPECIFICATIONS USING TWO BOLTS MINIMUM IN EACH CONNECTION UNLESS SHOWN OTHERWISE ON THE DRAWINGS.

DESIGN LIVE LOADS

(LBS./SQ. FT., IN ADDITION TO DEAD LOAD OF STRUCTURE AND MISCELLANEOUS)

1. PUBLIC AREAS, CORRIDORS, ETC.	100
2. ASSEMBLY AREAS: NO FIXED SEATS	100
FIXED SEATS	60
BALCONIES	80
3. TYPICAL FLOORS, OFFICE AREAS, STUDIOS, ETC.	70
4. CLASSROOMS	50
5. ROOFS (LEVEL; SNOW)	40
6. GRID-IRONS	60
7. CATWALK	35
8. PARTITION ALLOWANCE (ON FLOOR AREA)	20
9. WIND	20

Figure 53: General notes on the FAC.

Kevin Roche John Dinkeloo and Associates, 1970, drawing S01.

MINIMUM REINFORCING SCHEDULE			
THICKNESS OF WALL OR SLAB	SLABS MINIMUM SLAB OR TEMP. REINF. (SEE NOTE 1.)	WALLS	
		HORIZONTAL	VERTICAL
4"	#3 @ 15" B	_____	_____
5"	#3 @ 12" B	_____	_____
6"	#3 @ 10" B	#4 @ 12" MID.	#3 @ 12" MID.
7"	#4 @ 16" B	#4 @ 12" MID.	#3 @ 12" MID.
8"	#4 @ 14" B	#3 @ 11" E.F.	#3 @ 18" E.F.
9"	#5 @ 18" B	#3 @ 10" E.F.	#3 @ 16" E.F.
10"	#5 @ 16" B	#3 @ 9" E.F.	#3 @ 15" E.F.
11"-12"	#5 @ 14" B	#4 @ 12" E.F.	#3 @ 12" E.F.
13"-16"	#6 @ 15" B	#5 @ 16" E.F.	#4 @ 16" E.F.
17"-20"	#7 @ 16" B	#6 @ 17" E.F.	#5 @ 17" E.F.
21"-24"	#7 @ 14" B	#6 @ 15" E.F.	#5 @ 15" E.F.
NOTES: 1. TEMP. REINF. TO BE PLACED PERPENDICULAR TO MAIN REINF. BOTTOM, OR BOTH WAYS BOTTOM WHERE NO REINF. IS CALLED FOR.		NOTES: 1. IN CONCRETE AREAS WHERE NO REINF. IS CALLED FOR OR SHOWN USE MIN. WALL REINF. AS CALLED FOR IN THIS SCHEDULE.	

Table 16: Minimum reinforcement schedule for walls and slabs.

Kevin Roche John Dinkeloo and Associates, 1970, drawing S01.

WALL FOOTING SCHEDULE		
WIDTH ON PLAN	DEPTH	REINFORCING (BOTTOM)
2'-0" FTG.	1'-0"	3-#4 CONT. #4 @ 9"
2'-0" FTGS. 2'-6" FTGS.	1'-3"	3-#4 CONT. #4 @ 9"
3'-0" FTG.	1'-3"	4-#4 CONT. #4 @ 9"
4'-0" FTG.	1'-3"	5-#4 CONT. #4 @ 9"
*4'-0" FTG.	1'-3"	4-#4 CONT. #5 @ 8"
4'-9" FTG.	1'-6"	5-#5 CONT. #5 @ 12"
5'-6" FTG.	1'-6"	6-#3 CONT. #6 @ 10"
3'-6" FTG.	1'-3"	5-#4 CONT. #4 @ 9"

Table 17: Wall footing schedule.

Kevin Roche John Dinkeloo and Associates, 1970, drawing S08.

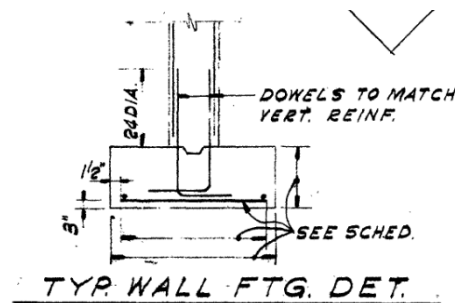

Figure 54: Typical wall footing detail.

Kevin Roche John Dinkeloo and Associates, 1970, drawing S08.

Appendix B – Original Art Studio Drawings

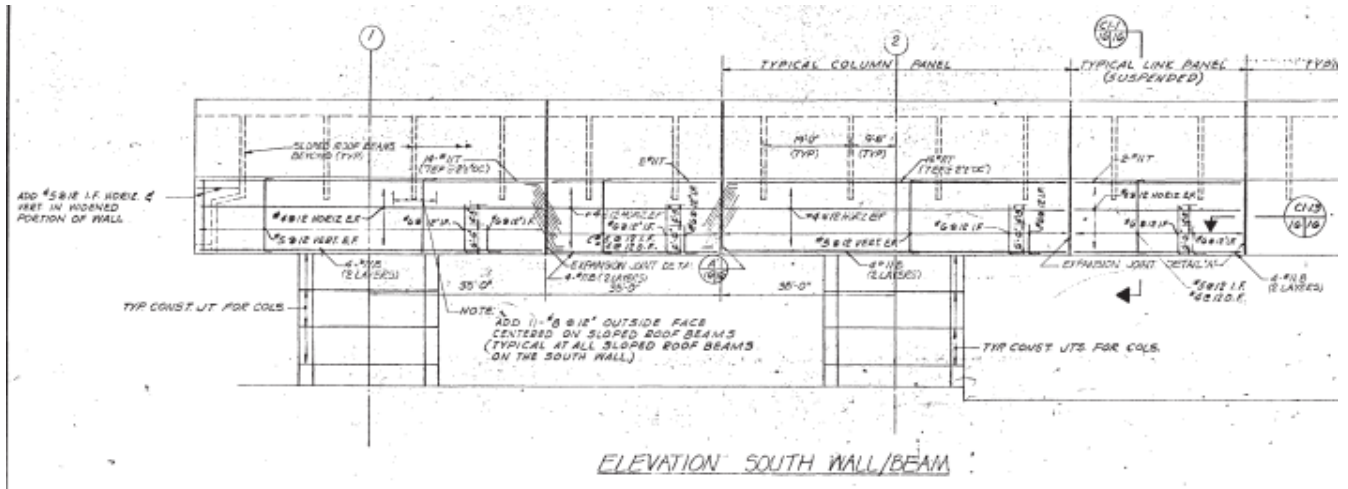

Figure 55: Art Studio South wall reinforcement.

Kevin Roche John Dinkeloo and Associates, 1970, drawing S16.

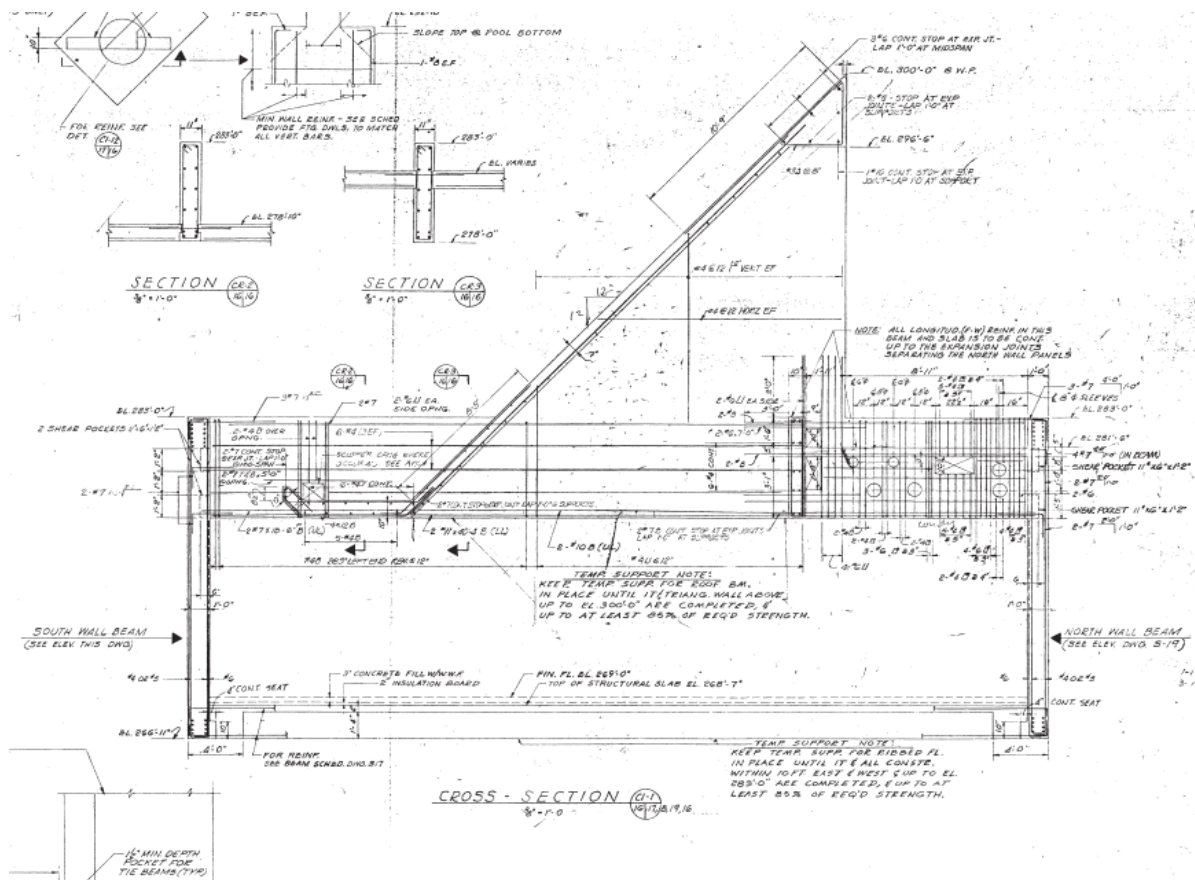
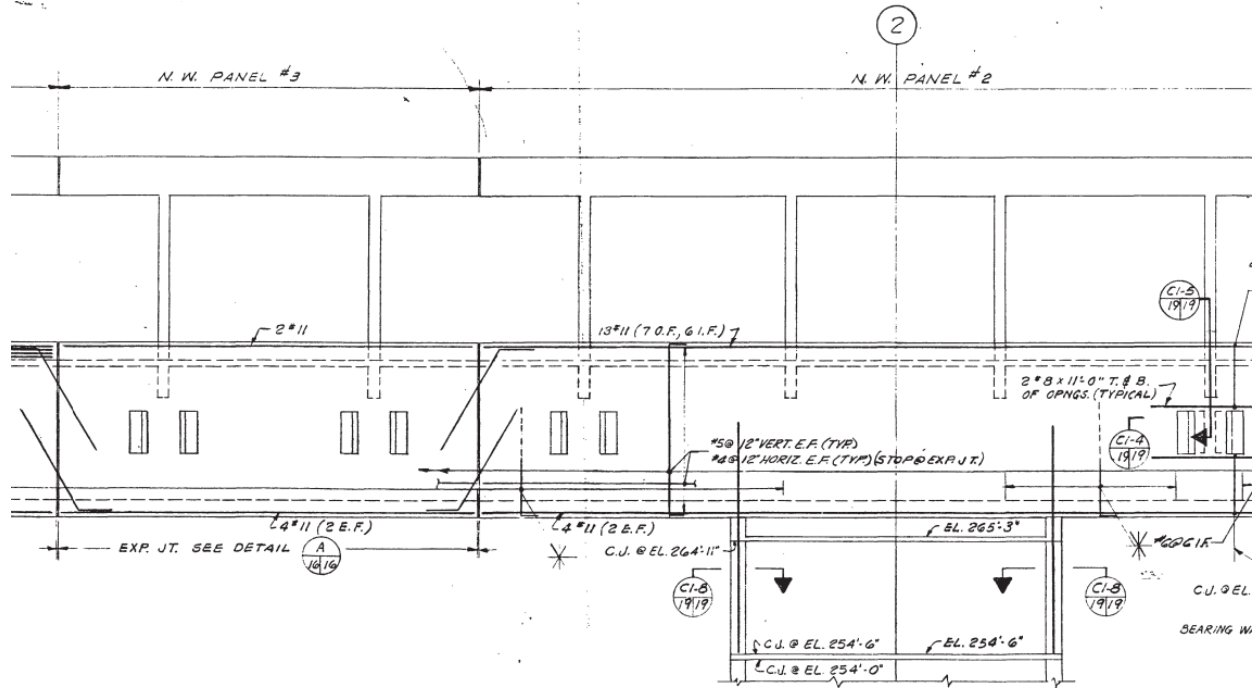

Figure 56: Cross Section of the main body of the Art Studio.

Kevin Roche John Dinkeloo and Associates, 1970, drawing S16.



ELEVATION NORTH WALL/BEAM ~ WEST HALF
6" = 1'-0"

Figure 57: Part of the Art Studio North wall elevation.

Kevin Roche John Dinkeloo and Associates, 1970, drawing S19.

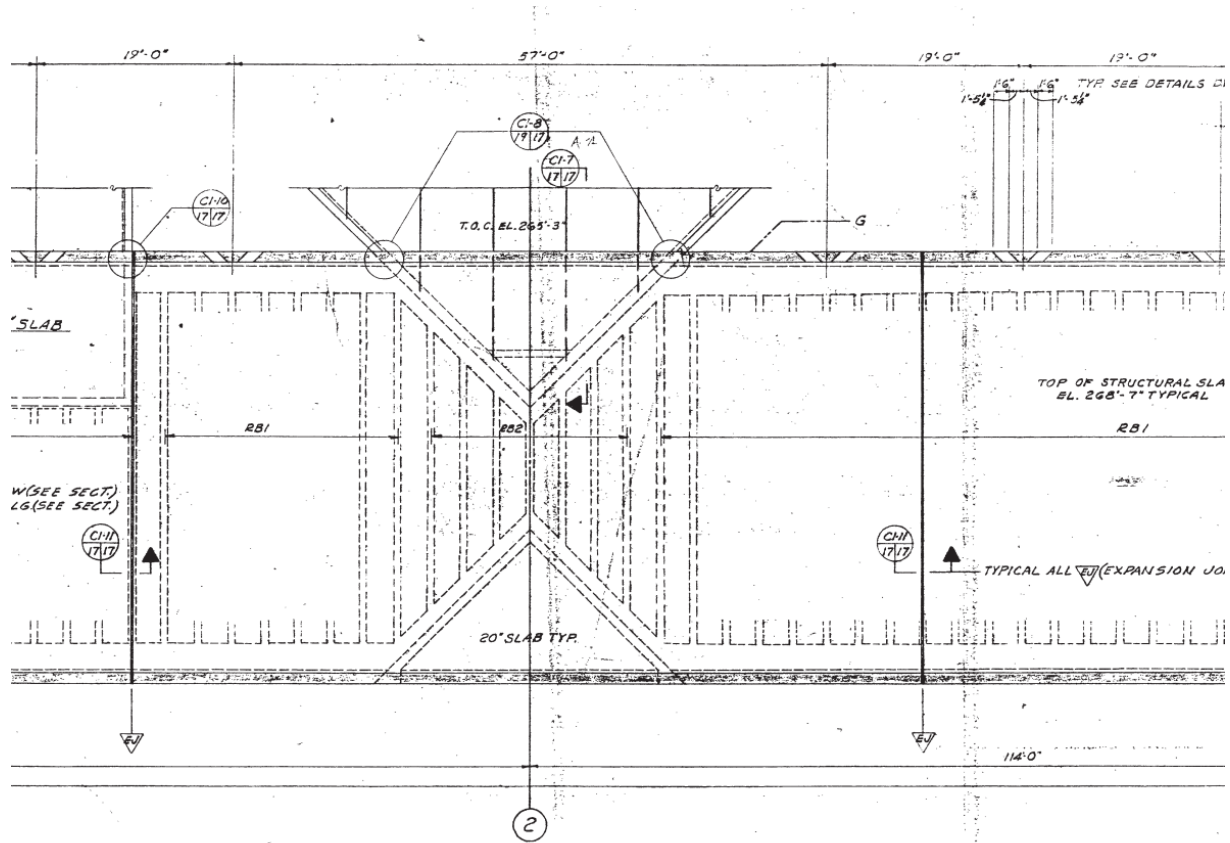

Figure 58: Part of the Art Studio floor framing plan showing placement of ribs.

Kevin Roche John Dinkeloo and Associates, 1970, drawing S17.

Appendix C – Original Building B Drawings and Schedules

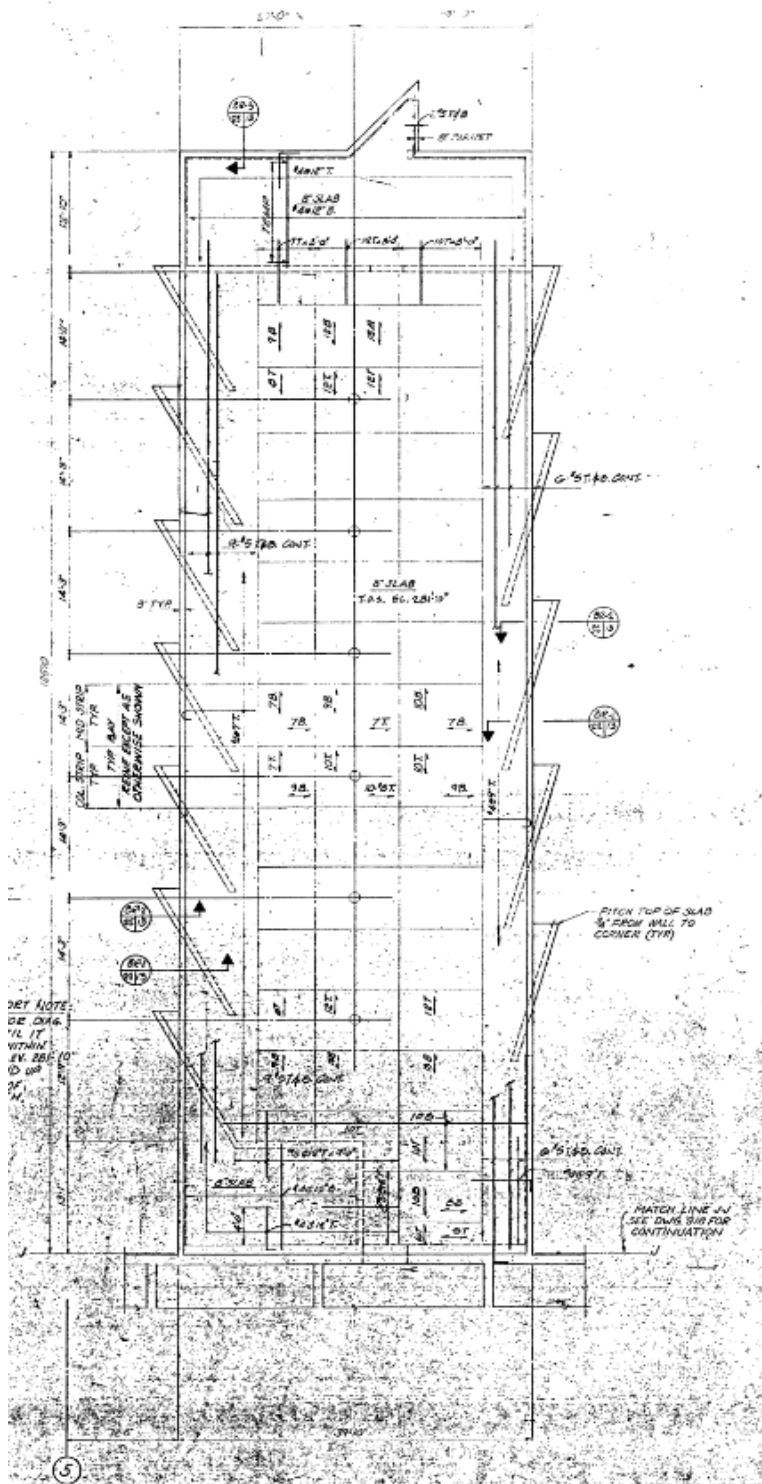

Figure 59: Original roof framing plan.

Kevin Roche John Dinkeloo and Associates, 1970, drawing S13.

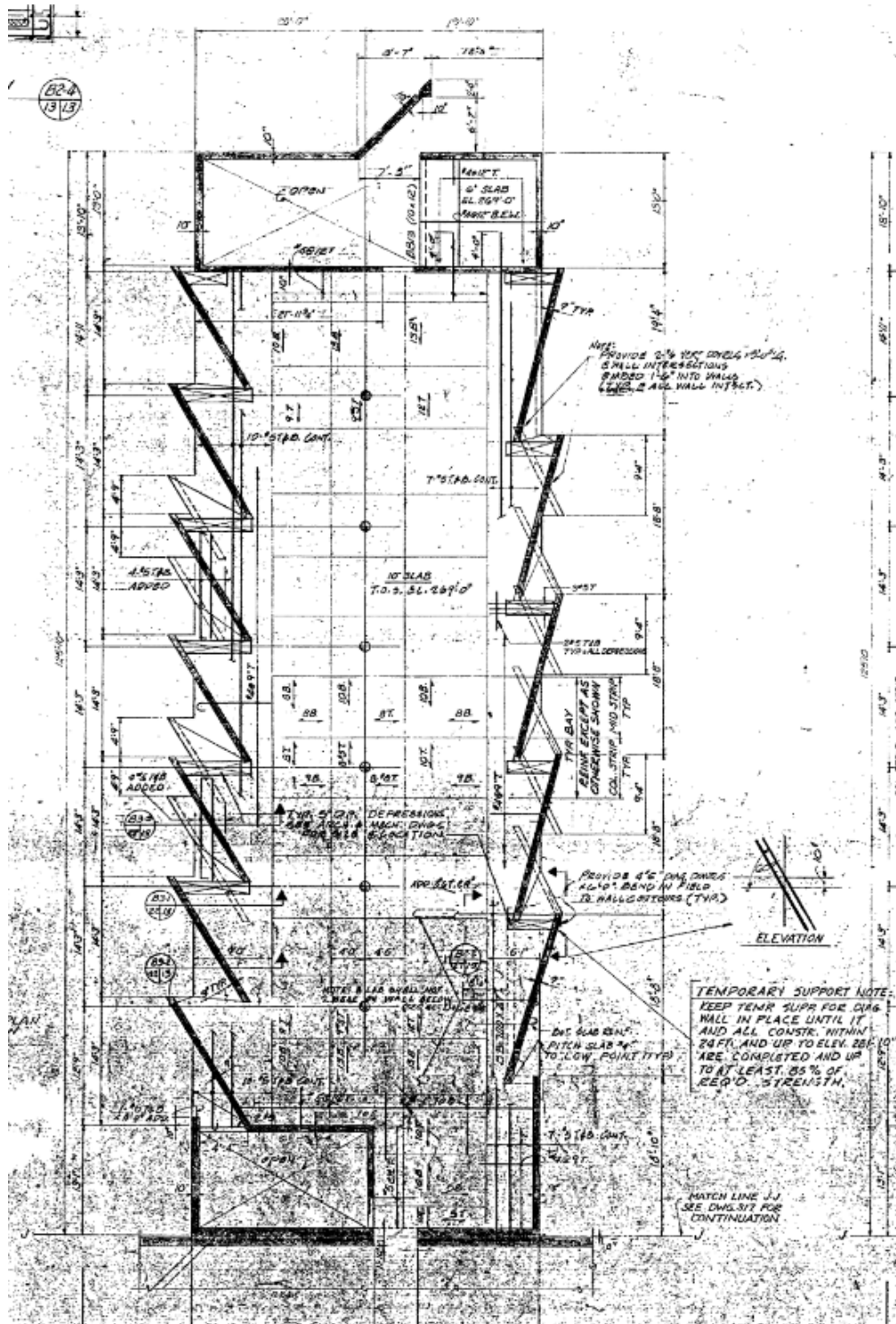

Figure 60: Original third floor framing plan.

Kevin Roche John Dinkeloo and Associates, 1970, drawing S13.

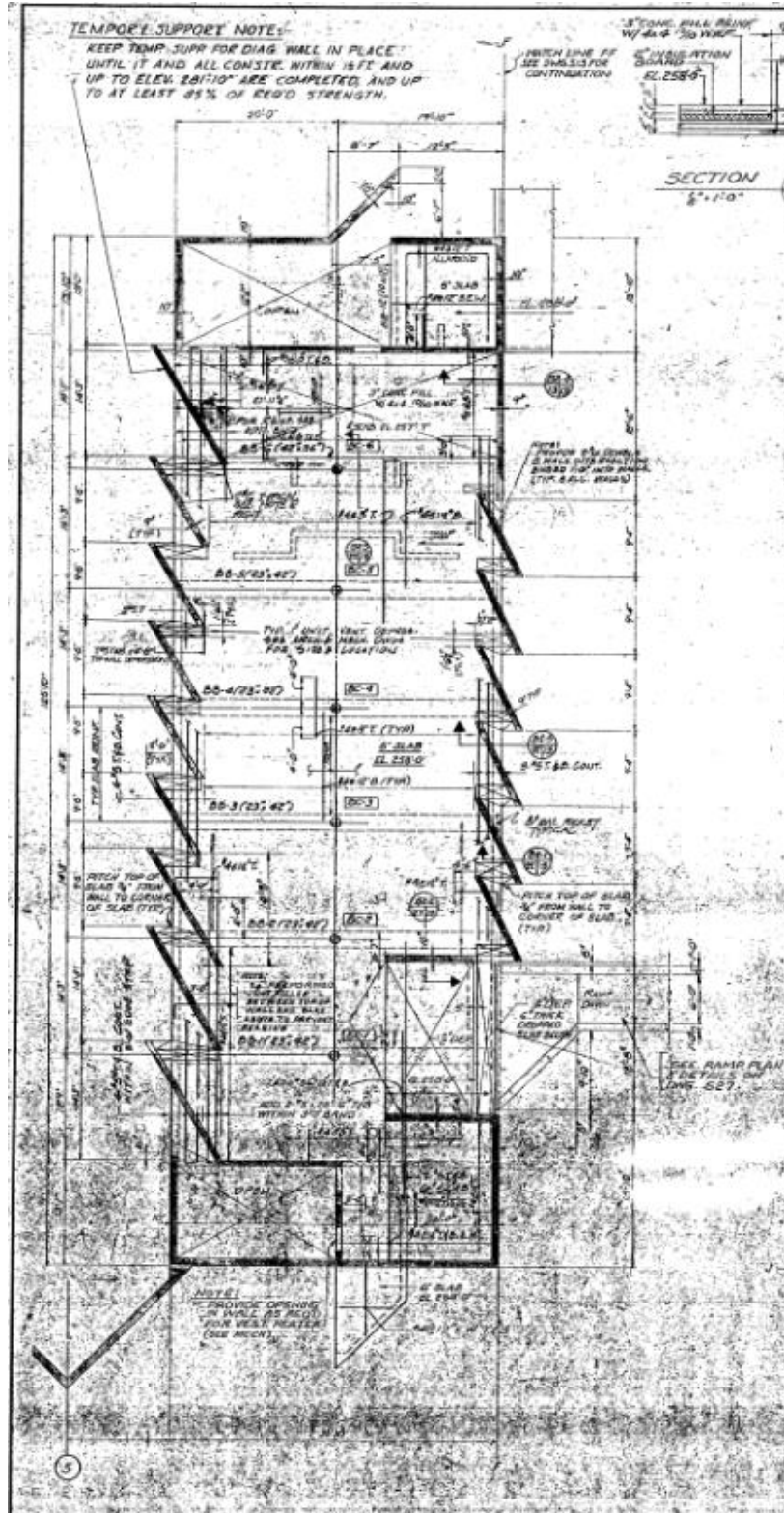

Figure 61: Original second floor framing plan.

Kevin Roche John Dinkeloo and Associates, 1970, drawing S13.

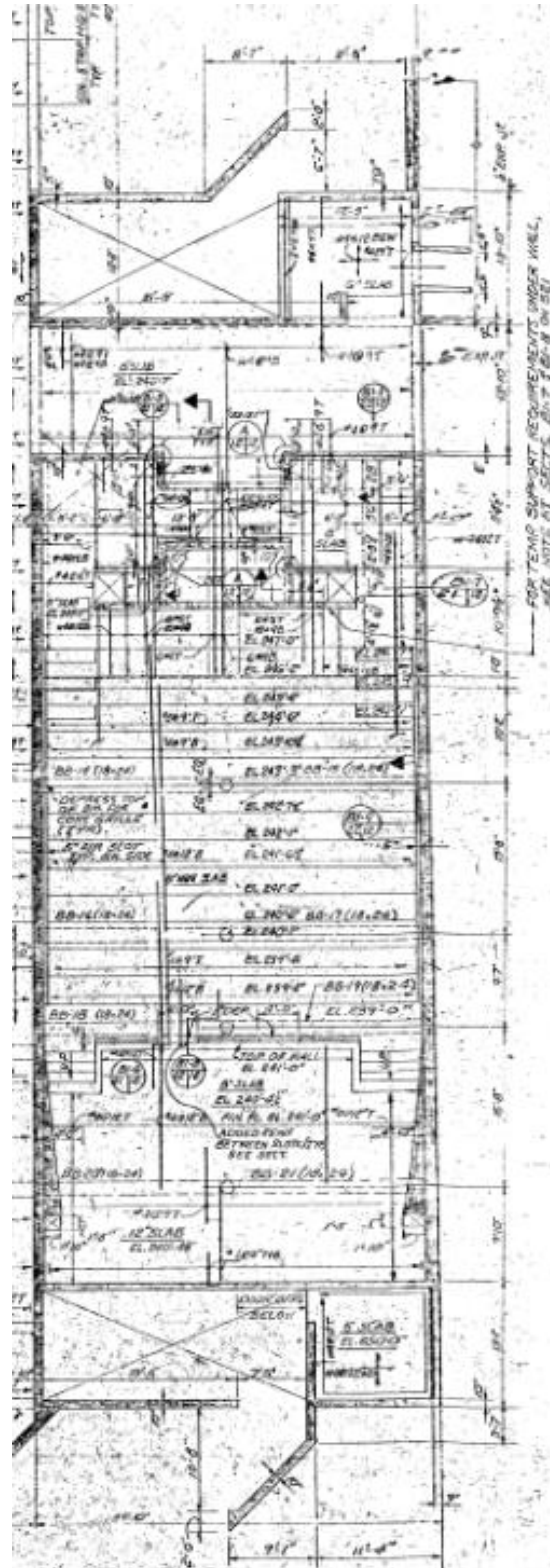

Figure 62: Original first floor framing plan.

Kevin Roche John Dinkeloo and Associates, 1970, drawing S12.

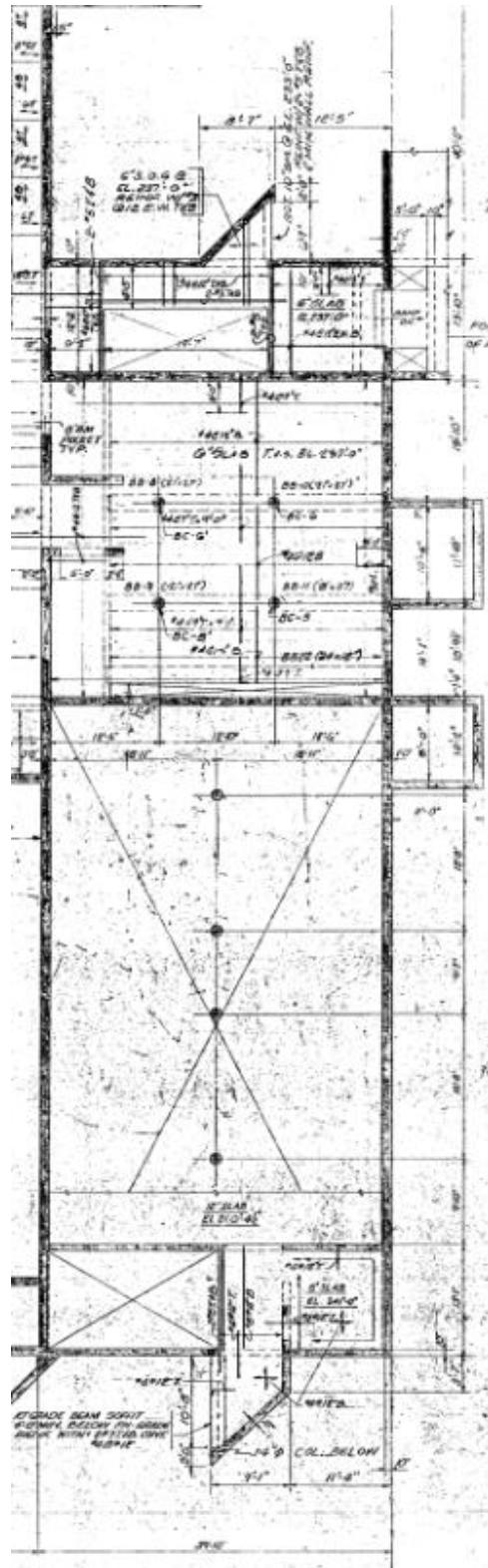

Figure 63: Original library level framing plan.

Kevin Roche John Dinkeloo and Associates, 1970, drawing S12.

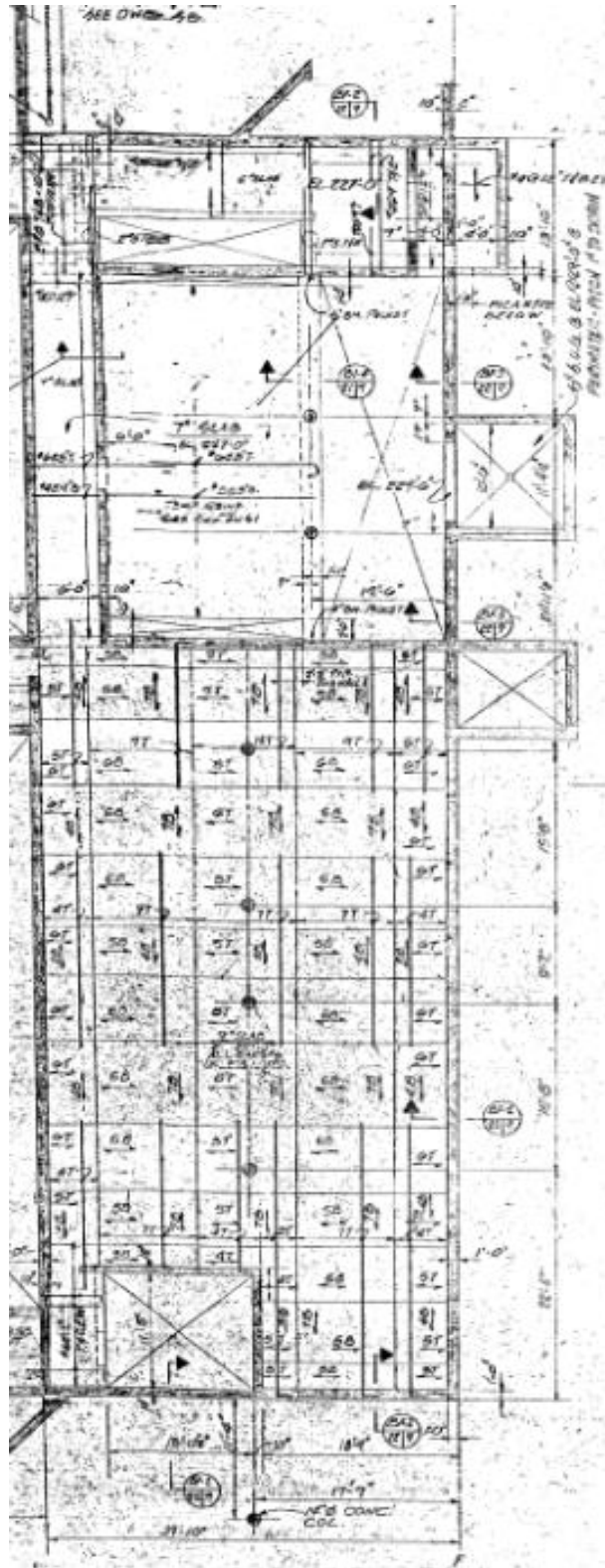

Figure 64: Original storage level framing plan.

Kevin Roche John Dinkeloo and Associates, 1970, drawing S09.

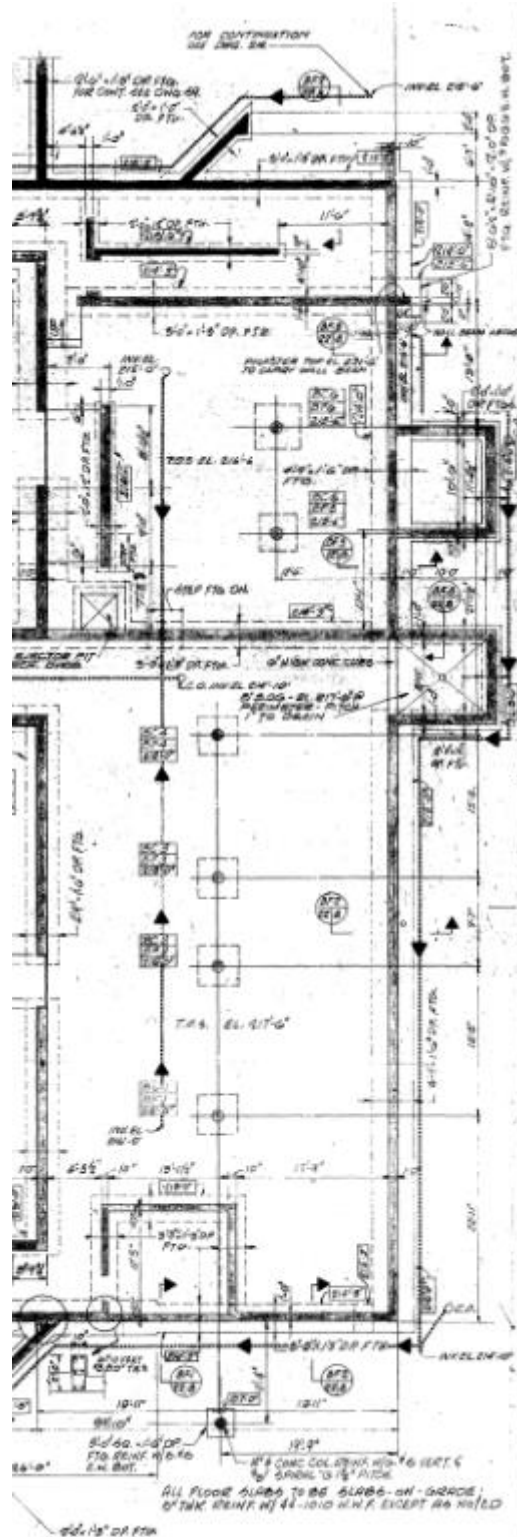

Figure 65: Original ground floor framing plan and foundation plan.

Kevin Roche John Dinkeloo and Associates, 1970, drawing S08.

ART BUILDING				
COLUMN SCHEDULE				
MARK	BC-1 THRU BC-4 INCLUSIVE	BC-5 BC-6 BC-5' BC-6'	BC-7 BC-8	BC-9 THRU BC-14 INCLUSIVE
ROOF				
3RD LEVEL				14"φ 6-#5 3/8" SPIRAL @ 12" PITCH
2ND LEVEL				14"φ 6-#5 3/8" SPIRAL @ 12" PITCH
ENTRY LEVEL				
STORAGE OR DRESSING ROOM LEVEL	14"φ 6-#6 3/8" SPIRAL @ 12" PITCH	16"φ 8-#8 3/8" SPIRAL @ 2" PITCH	16"φ 6-#6 3/8" SPIRAL @ 2" PITCH	
TOP OF FTG.	14"φ 6-#6 3/8" SPIRAL @ 12" PITCH	16"φ 8-#8 3/8" SPIRAL @ 2" PITCH	16"φ 6-#8 3/8" SPIRAL @ 2" PITCH	

OMIT @ BC-5' AND BC-6'

Table 18: Column schedule.

Kevin Roche John Dinkeloo and Associates, 1970, drawing S20.

BEAM SCHEDULE		
MARK	REINFORCING SUPPORT	STIRRUPS SIZE SHAPE SPACING
BB1 BB2		 #4 U @ 10" 12 CB @ 12" 3 @ 15 EE BAL @ 18"
BB3 BB4 BB5		 #4 U @ 10" 9 @ 10.5 @ 14" BAL @ 18"
BB6		 #3 U @ 12"
BB7		 #4 U @ 6" 3 @ 10 EE BAL @ 18"
BB8 BB9		 #4 U @ 10" 4 @ 6 EE 8 @ 6 EE BAL @ 9"
BB10 BB11		 #4 U @ 12"
BB12 BB13		 #3 U @ 10.2" 4 @ 5" 2 @ 8 EE BAL @ 10"
BB14 BB16 BB18 BB20		 #4 U @ 20" 2 @ 6 EE BAL @ 12"
BB15 BB17 BB19 BB21		 #4 U @ 20" 2 @ 6 EE BAL @ 12"
BB22		 #3 U @ 12" THROUGHOUT

Table 19: Beam schedule.

Kevin Roche John Dinkeloo and Associates, 1970, drawing S20.

FOOTING SCHEDULE		
TYPE	SIZE	BOTTOM REINF.
BF 1 THRU BF 4 INCL.	4'-6" x 4'-6" x 1'-6"	6-#5 E.W.
BF 5	5'-0" x 5'-0" x 2'-0"	6-#5 E.W.
BF 6	6'-3" x 6'-3" x 2'-0"	7-#5 E.W.

Table 20: Column footing schedule.

Kevin Roche John Dinkeloo and Associates, 1970, drawing S08.

Appendix D – Site Visit Observations

Key:

- = Efflorescence
- = Repairs
- = Cracks
- = Staining
- = Deterioration
- = Spalls
- = Rebar Showing

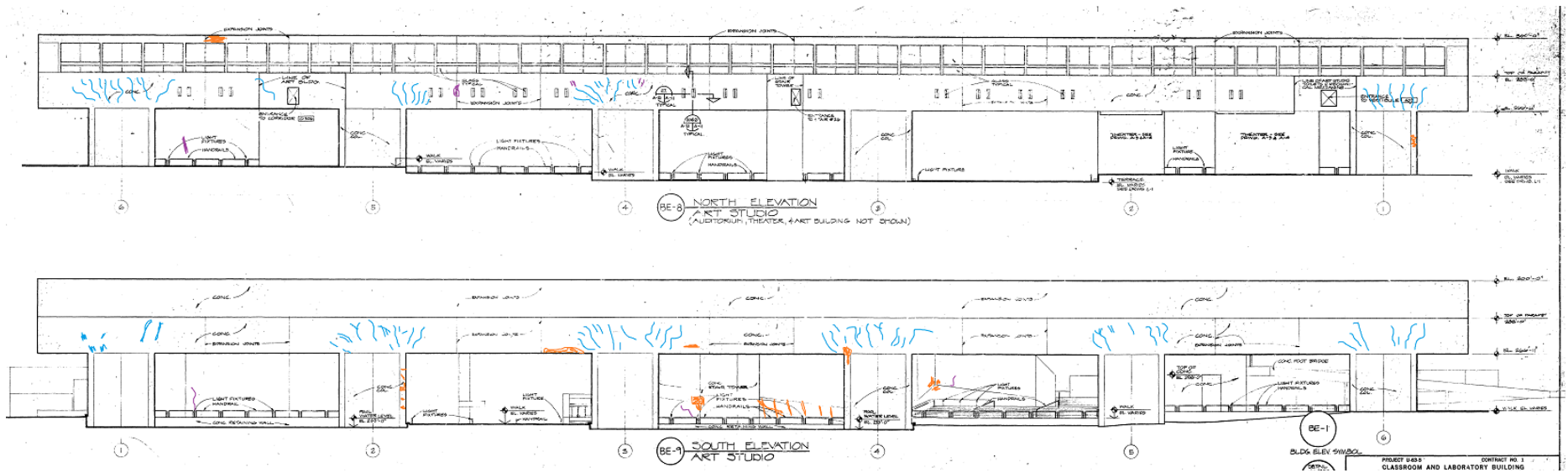

Observations of the North and South elevations of the Art Studio

Kevin Roche John Dinkeloo and Associates, 1970, drawing A11.

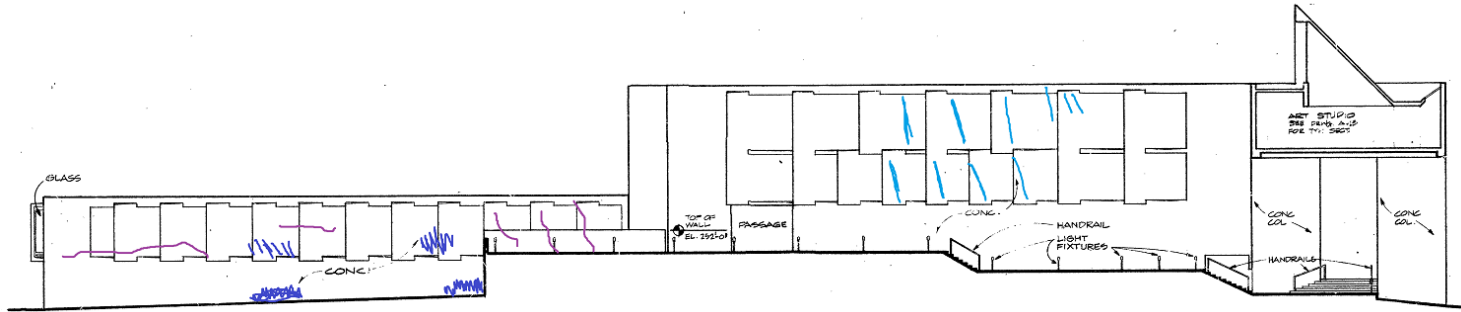

BE-12 WEST ELEVATION
MUSIC & ART



BE-13 EAST ELEVATION
ART STUDIO, ART & MUSIC

Observations of the West and East elevations of the Art Studio.

Kevin Roche John Dinkeloo and Associates, 1970, drawing A12.

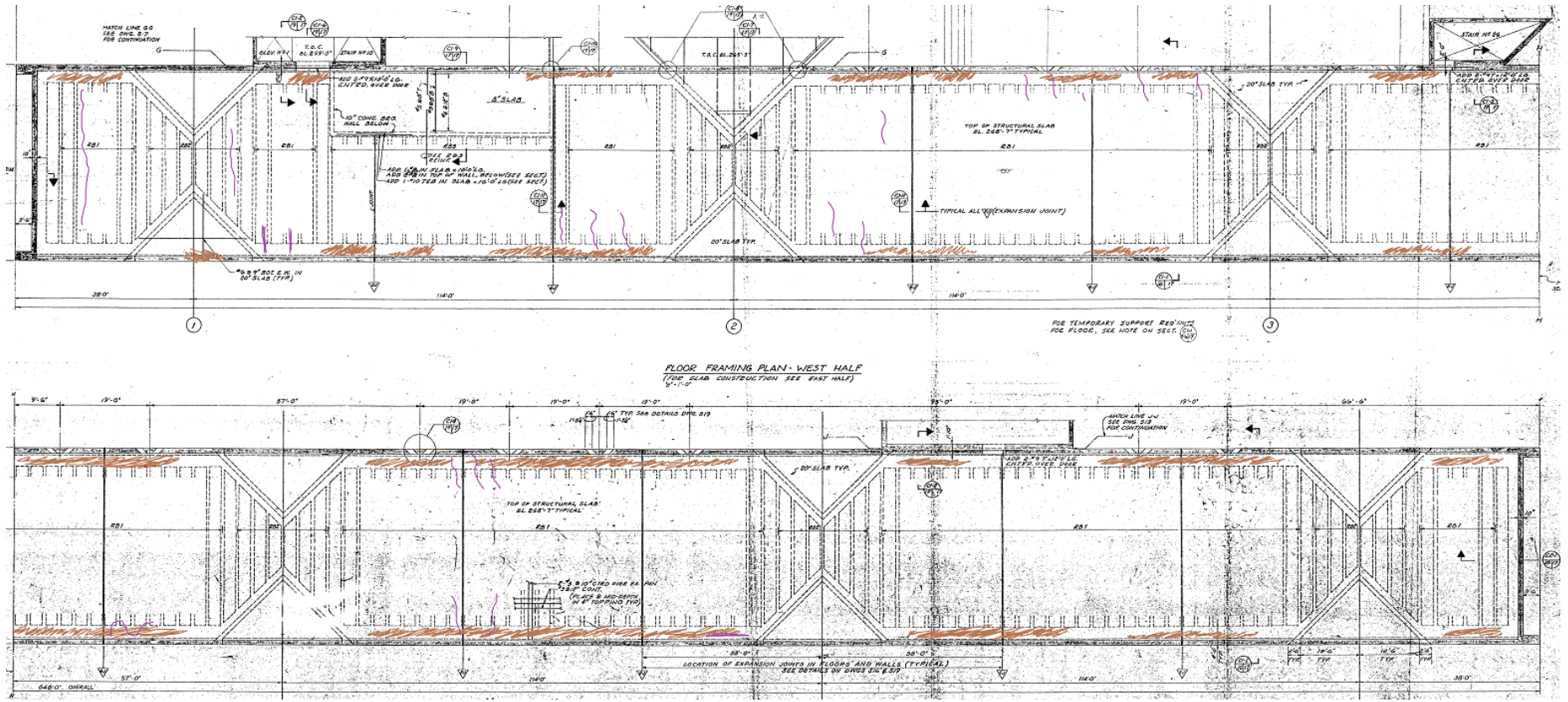

Observations of the West and East halves of underneath the Art Studio.

Kevin Roche John Dinkeloo and Associates, 1970, drawing S17.

Appendix E – Art Studio Design Capacity Calculations

Column Wall Panel Calculations

ELEVATION NORTH WALL/BEAM - WEST HALF

$$f'_c = 3 \text{ ksi}$$

$$f_y = 60 \text{ ksi}$$

$$h = 193 \text{ in}$$

$$b = 12 \text{ in}$$

$$d = 183 \text{ in}$$

$$d' = 18 \text{ in}$$

Tension

$$A_s = 13 (\#11)$$

$$A_s = 13 (1.56 \text{ in}^2)$$

$$A_s = 20.28 \text{ in}^2$$

Compression

$$A_s' = 4 (\#11)$$

$$A_s' = 4 (1.56 \text{ in}^2)$$

$$A_s' = 6.24 \text{ in}^2$$

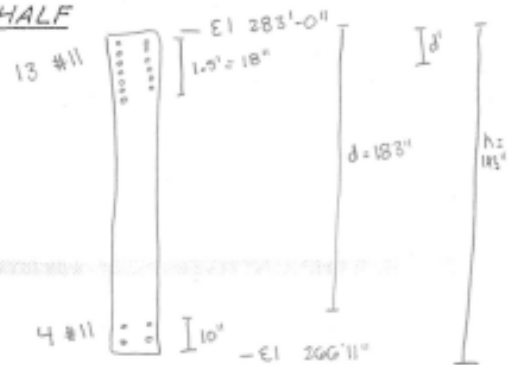

$$\textcircled{1} c = \frac{(A_s - A_s') f_y}{0.85 f'_c \beta_1 b} = \frac{(20.28 \text{ in}^2 - 6.24 \text{ in}^2) (60 \text{ ksi})}{0.85 (3 \text{ ksi}) (0.85) (12 \text{ in})}$$

$$c = 32.39 \text{ in}$$

$$\textcircled{2} a = \beta_1 c = 0.85 (32.39 \text{ in})$$

$$a = 27.53 \text{ in}$$

$$\textcircled{3} \epsilon'_s = \frac{c - d'}{c} (0.003) = \frac{32.39 \text{ in} - 18 \text{ in}}{32.39 \text{ in}} (0.003)$$

$$\epsilon'_s = 0.0013$$

$$\epsilon_y = 0.00207$$

$$\textcircled{4} \epsilon_y > \epsilon'_s$$

$$\textcircled{5} f_s = \epsilon_y E_s = 0.00207 (29,000 \text{ ksi})$$

$$f_s = 38.65 \text{ ksi}$$

$$\textcircled{6} A_{s2} = \frac{A_s' f_s}{f_y} = \frac{6.24 \text{ in} (38.65)}{60 \text{ ksi}}$$

$$A_{s2} = 4.02 \text{ in}^2$$

$$\textcircled{7} A_{s1} = A_s - A_{s2} = 20.28 \text{ in}^2 - 4.02 \text{ in}^2$$

$$A_{s1} = 16.26 \text{ in}^2$$

$$\textcircled{8} \epsilon_t = \frac{d - c}{c} (0.003) = \frac{183 \text{ in} - 32.39 \text{ in}}{32.39} (0.003)$$

$$\epsilon_t = 0.01$$

$$\epsilon_t > 0.005 \text{ so } \phi = 0.90$$

$$\textcircled{9} M_n = \phi [A_{s1} f_y (d - \frac{a}{2}) + A_s' f_s' (d - d')]$$

$$M_n = 0.90 [16.26 \text{ in}^2 (60 \text{ ksi}) (183 \text{ in} - \frac{27.53}{2}) + (6.24 \text{ in}^2) (38.65 \text{ ksi}) (183 \text{ in} - 18 \text{ in})]$$

$$M_n = 15,368 \text{ kip} \cdot \text{ft}$$

Floor Rib Calculations

RIB CAPACITY

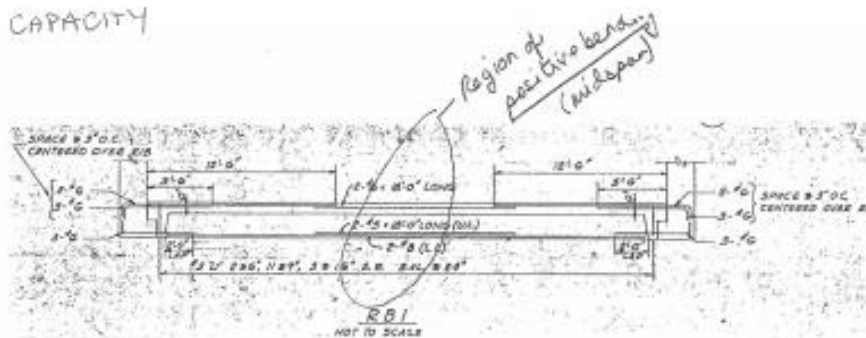

Doubly reinforced Beam

2- #8 bars (compression steel)

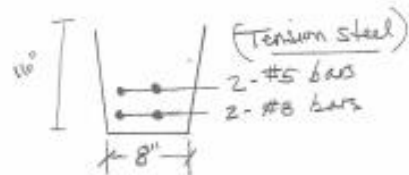
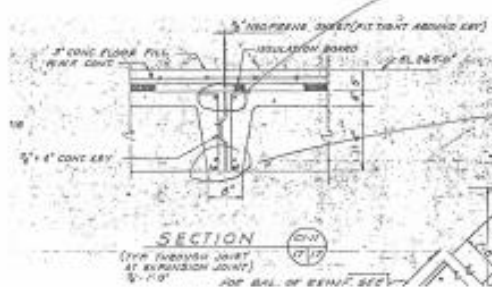

$f_y = 60 \text{ ksi}$
 $f_c = 3,000 \text{ psi}$
 $b = 8''$
 $h = 16''$
 $d = 15''$
 $d' = 1''$

Tension
 $A_s = 2(\#5) + 2(\#8)$
 $A_s = 2(0.31 \text{ in}^2) + 2(0.79 \text{ in}^2)$
 $A_s = 2.20 \text{ in}^2$
Compression
 $A_s' = 2(\#8)$
 $A_s' = 2(0.79 \text{ in}^2)$
 $A_s' = 1.58 \text{ in}^2$

$$A_s f_y = 0.85 f_c \beta_1 c b + A_s' f_y$$

$$\textcircled{1} c = \frac{(A_s - A_s') f_y}{0.85 f_c \beta_1 b} = \frac{(2.20 \text{ in}^2 - 1.58 \text{ in}^2) 60 \text{ ksi}}{0.85 (3 \text{ ksi}) (0.85) (8 \text{ in})}$$

$$c = 2.15 \text{ in}$$

$$\textcircled{2} a = \beta_1 c$$

$$a = 0.85 (2.15 \text{ in})$$

$$a = 1.82 \text{ in}$$

$$\textcircled{3} \epsilon'_s = \frac{c - d'}{c} (0.003) \quad \epsilon_y = \frac{f_y}{E_s}$$

$$\epsilon'_s = \frac{2.15 \text{ in} - 1 \text{ in}}{2.15 \text{ in}} (0.003) \quad \epsilon_y = \frac{60 \text{ ksi}}{29,000 \text{ ksi}}$$

$$\epsilon'_s = 0.0016 \quad \epsilon_y = 0.00207$$

$$\textcircled{4} \epsilon_y > \epsilon'_s$$

$$\textcircled{5} f'_s = \epsilon'_s E_s = 0.0016 (29,000 \text{ ksi})$$

$$f'_s = 46.45 \text{ ksi}$$

$$\textcircled{6} A_{s2} = \frac{A'_s f'_s}{f_y} = \frac{(1.58 \text{ in}^2) (46.45 \text{ ksi})}{60 \text{ ksi}}$$

$$A_{s2} = 1.22 \text{ in}^2$$

$$\textcircled{7} A_{s1} = A_s - A_{s2}$$

$$A_{s1} = 2.20 \text{ in}^2 - 1.22 \text{ in}^2$$

$$A_{s1} = 0.98 \text{ in}^2$$

$$\textcircled{8} \epsilon_t = \left(\frac{d - c}{c} \right) 0.003 = \frac{15 \text{ in} - 2.15 \text{ in}}{2.15 \text{ in}} (0.003)$$

$$\epsilon_t = 0.008$$

$$\epsilon_t > 0.005 \checkmark$$

$$\textcircled{9} M_n = \phi [A_{s1} f_y (d - \frac{a}{2}) + A'_s f'_s (d - d')] + \phi [A'_s f'_s (d - d')]$$

$$M_n = 0.90 [0.98 \text{ in}^2 (60 \text{ ksi}) (15 \text{ in} - 1.82 \text{ in} / 2) + (1.58 \text{ in}^2) (46.45 \text{ ksi}) (15 \text{ in} - 1 \text{ in})]$$

$$M_n = 1667.86 \text{ kip} \cdot \text{in} = \frac{1 \text{ ft}}{12 \text{ in}}$$

$$M_n = 139 \text{ kip} \cdot \text{ft}$$

Support Columns

Applied Load

P	627.7
W1	2932.053161
d1	223
W2	5280.48
d2	96.5
$C_y = (W1 \cdot d1 + W2 \cdot d2) / 28$	41551
Load Combination	20932

Design Capacity

$$f_c' = 3000\text{psi}$$

$$f_y = 60000\text{psi}$$

Art Studio

Support Column One leg of the arrow

Length (in)	Width (in)	Ag (in ²)	Steel Rebar	As (in ²)	Ac (in ²)	fc (psi)	Ec (psi)	Es (psi)	Pn (lbs)	Pn (kips)
286	24	6,864	0.02	137.28	6,726.72	2,550	3,122,019	29,000,000	25,389,936	25,390

Footings**1. APPLIED LOADS****Support Column Wall Footing - Cantilevers out 1.5"**

	Quantity	Length (ft)	Width (ft)	Height (ft)	Volume (CF)	Weight (k)
Self-weight 1	1	14.5	1.25	1.50	27.19	4.08
Column	1	14.50	1	36	522.00	78.30
					Total DL (k):	82.38
		Current P _u (k):	157			
Total:		Current P _u (k):	256			
		Current w _u (k/ft):	18			

Support Column Buttress Footing - Cantilevers out 34"

	Quantity	Length (ft)	Width (ft)	Height (ft)	Volume (CF)	Weight (k)
Self-weight 1	1	9.33	6.67	2.00	124.44	4,480
Column	1	9.33	1	36	336.00	50
					Total DL (k):	4,530
		Current P _u (k):	157			

Total:	Current P_u (k):	5,593
	Current w_u (k/ft):	599

2. DESIGN CAPACITY

Given values:

$f'_c = 3,000$ psi =	3 ksi	$k = 0.8$
$f_y = f_{yt} = 60,000$ psi =	60 ksi	$\Phi = 0.9$
$q_n = 4$ tons/sf =	288 ksi	$\Phi = 0.75$ shear
See S01 for wall reinforcement.		$\gamma = 0.85$
# bars rounded up in A_s and A_v equations		$\lambda = 1$

Support Column Wall Footing

Reinf: 5 #4s

diam. (in)	A_{bar} (in ²)	# bars	A_s (in ²)
0.5	0.2	5	1

wall t (in)	b (in)	d (in)	A_{ftg} (in ²)
12	1.5	14.75	2,610

a (in)	ΦM_n (ft-k)	ΦV_n (k)	Max. P (k)	Max. P (k/ft)
15.6863	4,973	57	4,972	343

Support Column Buttress Footing

Reinf:
#7@6"

diam. (in)	A_{bar} (in ²)	# bars	A_s (in ²)
0.875	0.6	9.33	6

wall t (in)	b (in)	d (in)	A_{ftg} (in ²)
12	34	20.56	8,960

a (in)	ΦM_n (ft-k)	ΦV_n (k)	Max. P (k)	Max. P (k/ft)
4.1522	79,861	1,816	27,620	2,959

Appendix F – Art Studio Wind Combination Calculation

Given Values:		Unit
W	20	psi
L	1368	in
L3	360	in
h1	204	in
h2	193	in
h3	432	in
angle	45	degrees
cos(45)	0.525322	

TRIANGLE

$$W1 = w \cos(45)(h1)(L)$$

Wtotal 2932.053 Kips

$$M1 = W1 * Arm$$

M1 24922.45 kip-ft

Column Panel Walls

$$W2 = w(h2)(L)$$

Wtotal 5280.48 kips

$$M2 = W2 * Arm$$

M2 42463.86 kip-ft

Support Columns

$$W3 = w(h3)(L3)$$

Wtotal 3110.4 kips

$$M3 = W3 * Arm$$

M3 55987.2 kip-ft

Appendix G— Art Studio Seismic Calculations

STEP 1

	<i>Value</i>	<i>Reference</i>
Ss (accelerations at short period) =	0.20g	Figure 22-1 ASCE-7 (g.159)
Ss =	0.2	
S1 (Acceleration at 1-second period) =	0.06g	Figure 22-2 ASCE-7 (g.161)
S1 =	0.06	

STEP 2

Doesn't qualify for an exception

STEP 3

1. Soil classification	Site Class D	2012 IBC section 1613.3.2
2. $S_{ds} = (2/3) * F_a * S_s$		
	$F_a = 1.6$	Table 11.4-1 ASCE-7
	$S_{ds} = 0.21$	
$S_{d1} = (2/3) * F_v * S_1$		
	$F_v = 2.4$	Table 11.4-2 ASCE-7
	$S_{d1} = 0.10$	
3. Risk Category	Category III	Considered a school
4. SDS (Seismic Design Category)		
S_{ds}	B	Table 11.6-1 ASCE-7
S_{d1}	B	Table 11.6-2 ASCE-7

STEP 4

1. Fundamental period, $T_a = (C_t)(h_n)^x$		
	$C_t = 0.016$	Table 12.8-2 ASCE-7 Concrete moment-resisting frames In feet defined by ASCE-7 Section 11.2 "Structural height"
h_n (structural height) =	52.08	
$x =$	0.9	Table 12.8-2 ASCE-7 Concrete moment-resisting frames
	$T_a = 0.75$	
2. T limit = $C_u(T_a)$		
	$C_u = 1.7$	Table 12.8-1 ASCE-7
	$T = 1.275$	
3. $T_s = S_{d1}/S_{ds}$		
	$T_s = 0.45$	
4. Vertical irregularity Type 5a		Table 12.3-2 ASCE-7

STEP 5

R-value = 5.5 Table 12.2-1 E.8 ASCE-7

STEP 6

Seismic Importance factor I_e = 1.25

STEP 7

1. $V = C_s W$

$C_s = S_d1 / (R / I_e) = 0.021818182$ Section 12.8.1.1 Equation 12.8-2
weight of structure
10psf of floor area

$W = 5956375$ pounds

$V = 129957.2727$ pounds

2. TL

6 Figures 22-12 through 22-16 ASCE-7

STEP 8

$F_x = C_{vx}(V)$

$C_{vx} = W_x(h_x)^k / \text{sum of } W_i(h_i)^k$

$k = 2$ Given in Step 8

Assume one story

$C_{vx} = 1$

$F_x = 129957.2727$ pounds

STEP 9

Redundancy Factor (P) 1 Given in Step 9

STEP 10

1. $E = P(Q_e) + 0.2(S_d)D$

$Q_e = F_x = 129957.27$ psi ASCE-7 12.4.2.1

$P(Q_e) = 129957.27$ psi

$D = W = 5956375.00$ psi

$0.2(S_d)D = 254138.67$ psi

$E = P(Q_e) + 0.2(S_d)D = 384095.94$

2. Basic Load Combination

$(1.2 + 0.2S_d)D + P(Q_e) + L + 0.2S$ 12.4.2.3 Equation 5 ASCE-7

$(1.2 + 0.2S_d)D = 7401788.667$

$P(Q_e) = 129957.27$

$L = 60$ psi

$0.2S = 0$ Snow load included in L according to S01

$(1.2 + 0.2S_d)D + P(Q_e) + L + 0.2S = 7531806$ psi

7532 ksi

$$3. E_m = E_{mh} + E_v$$

$$E_{mh} = \Omega(Q_e)$$

$$\Omega = 2.5 \quad \text{Table 12.2.1 ASCE-7}$$

$$E_{mh} = 324893.18$$

$$E_v = 0.2(S_{ds})(D)$$

$$E_v = 254138.67$$

$$E_m = 579031.85$$

Table A: Seismic Weight of Structure

Length	646	ft	
weight	150	lb/ft ³	
<u>Walls</u>			
Height	16	ft	
thickness	1	ft	
	10336		1550400
<u>Floor</u>			
width	42	ft	
thickness	0.583333	ft	
	15827		2374050
<u>Roof Beams</u>			
Height	5	ft	
thickness	1	ft	
Length	42	ft	
Number of roof beams	34		
	7140		1071000
<u>Roof Triangle</u>			
height	17	ft	
thickness	0.583333	ft	
	6406.167		960925
Total Weight			5956375 pounds

Appendix H – Building B Structural Analysis

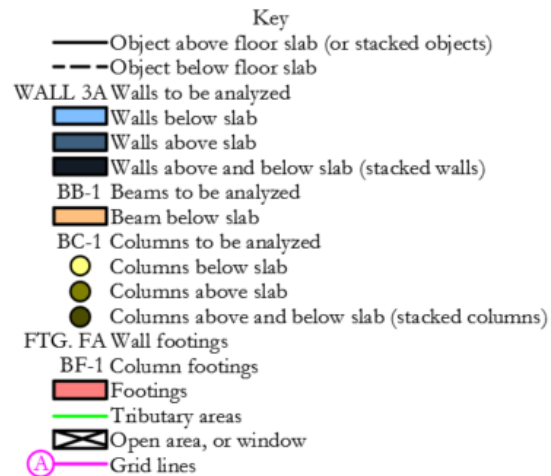

Notes:

There is one framing plan for each floor level. Each framing plan includes the structural members above and below that level's floor slab and information about the floor slab(s) on that level.

The structural members are labeled on the level which they support, i.e. the second floor wall 2A is labeled on the third floor framing plan. The tributary area for wall 2A is also shown on the third floor framing plan.

If an open floor area is not labeled as in the key, it can be assumed that the area extends to the nearest walls, beams and other object lines (not including tributary area lines.)

Figure 66: Key and notes for the following framing plans.

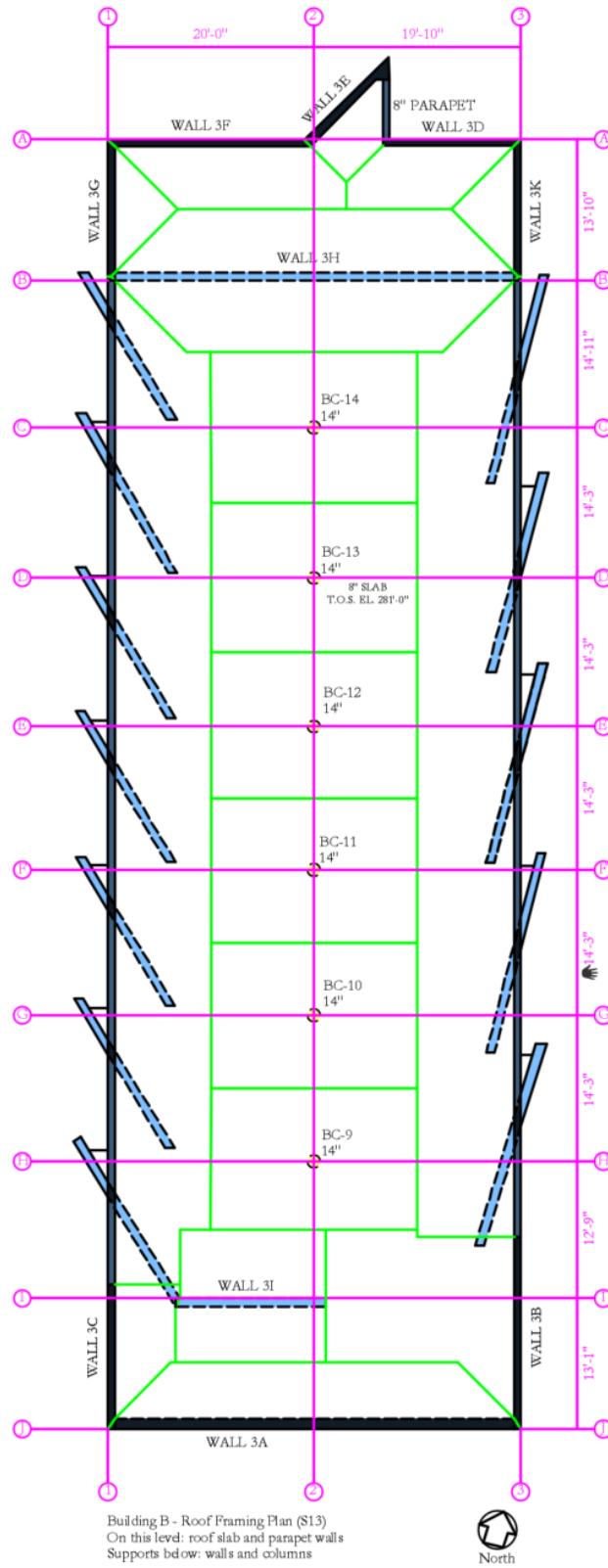

Figure 67: Roof framing plan.

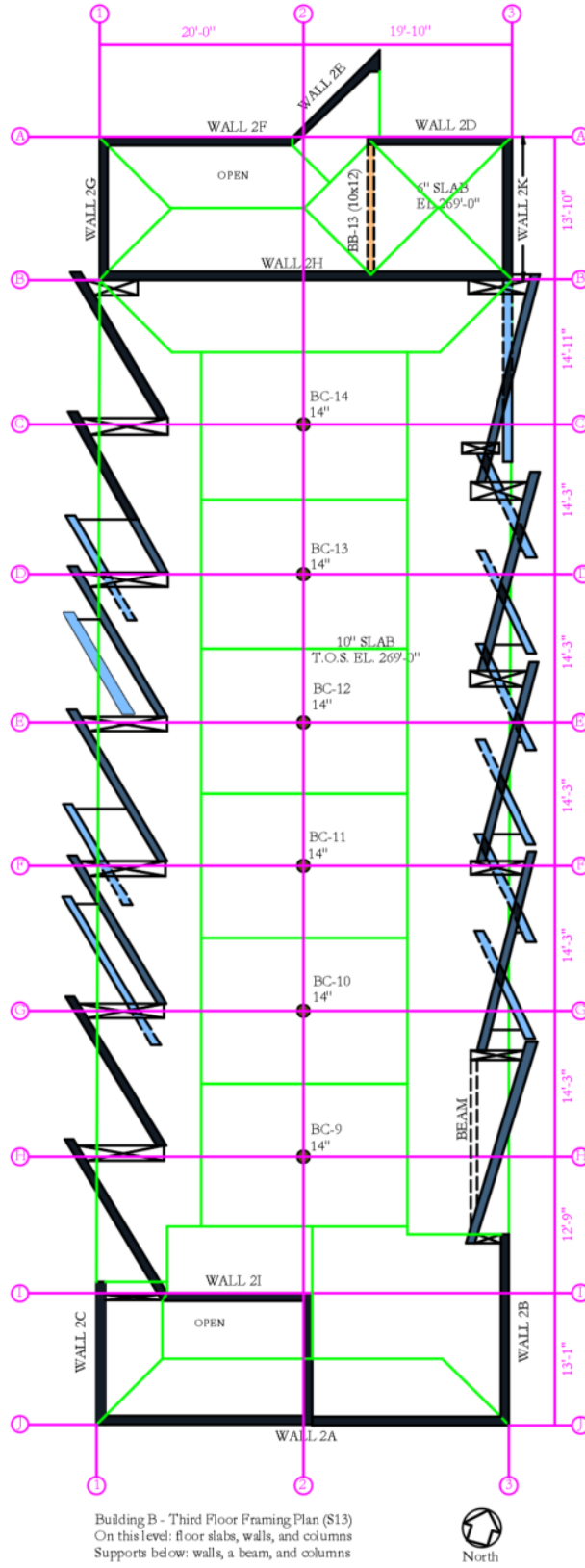

Figure 68: Third floor framing plan.

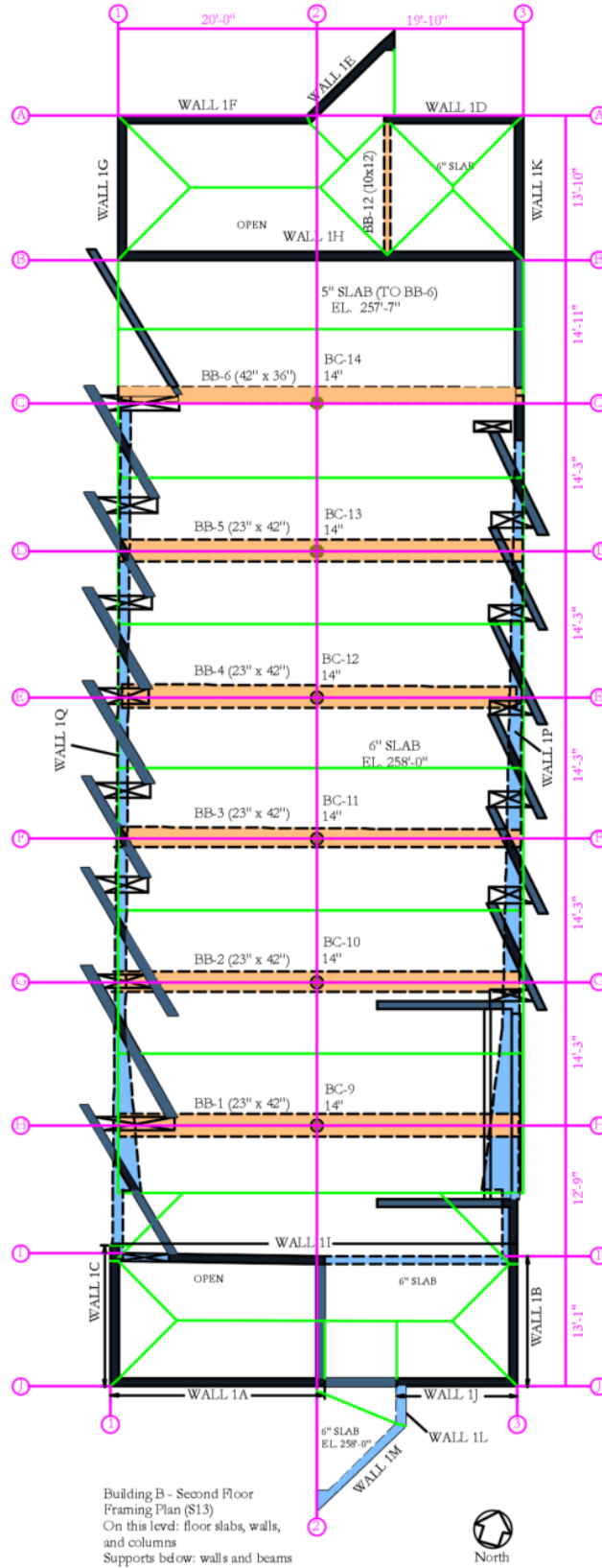

Figure 69: Second floor framing plan.

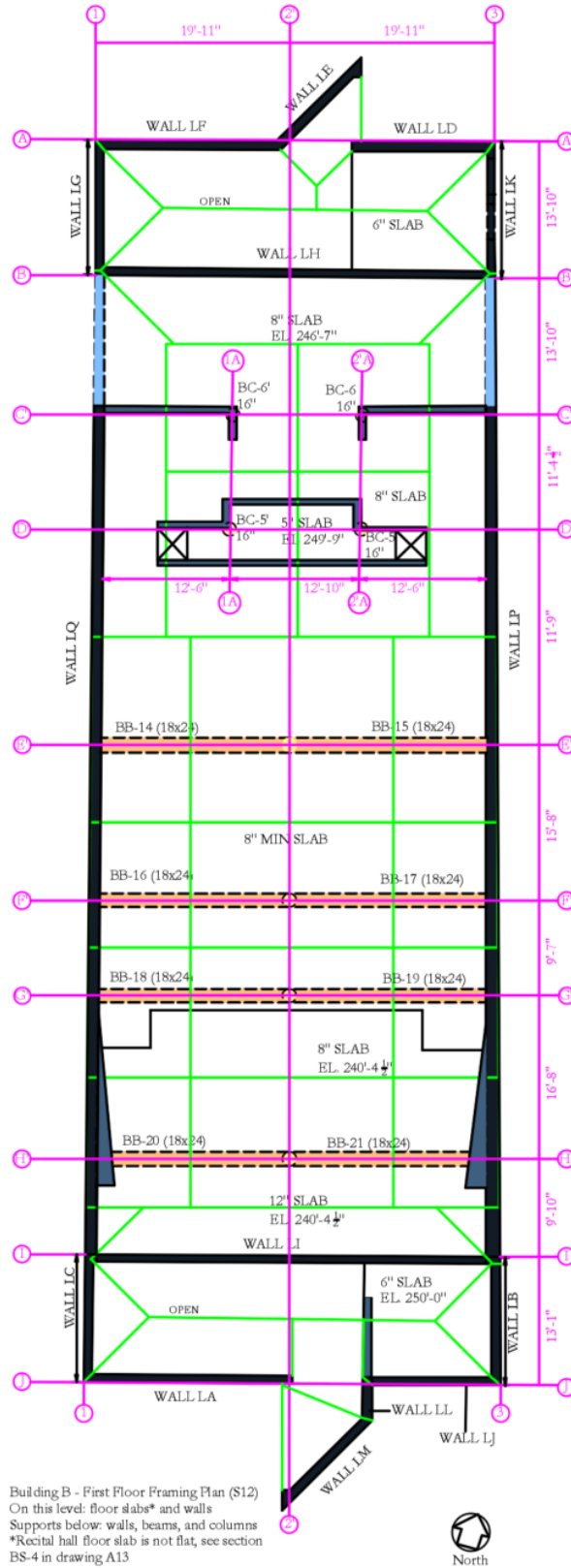

Figure 70: First floor framing plan.

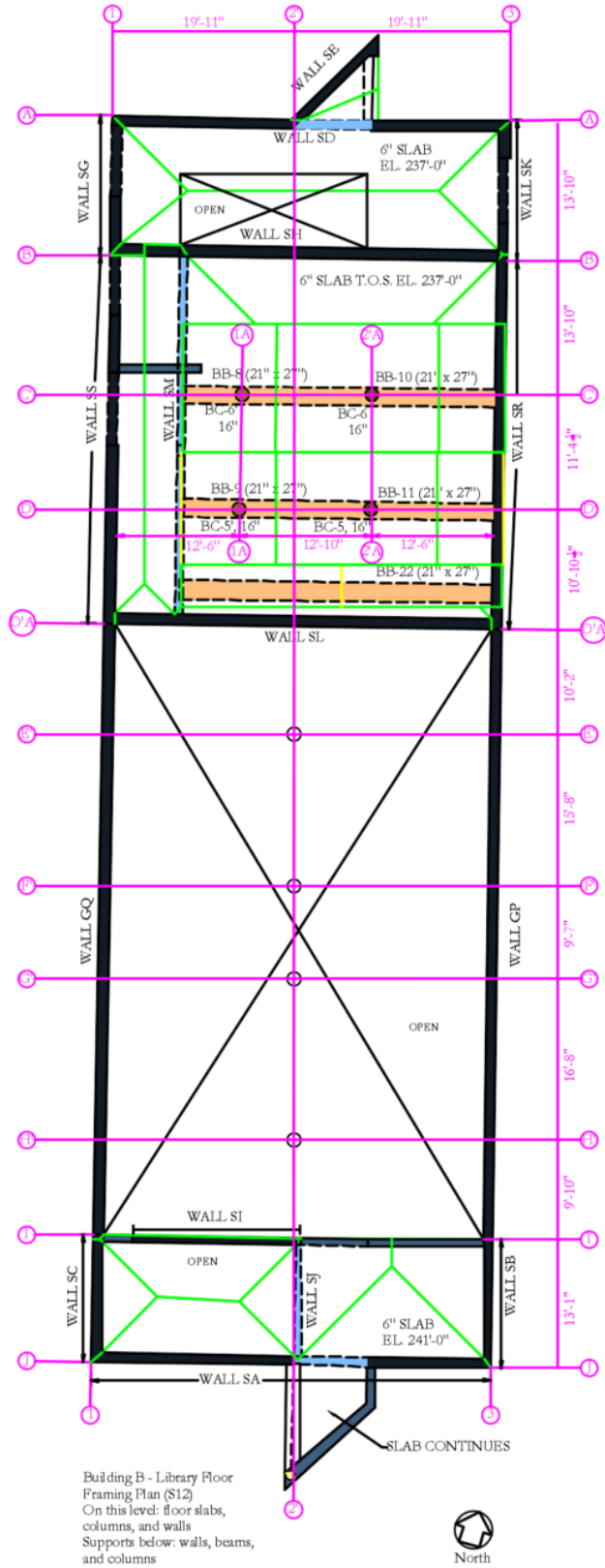
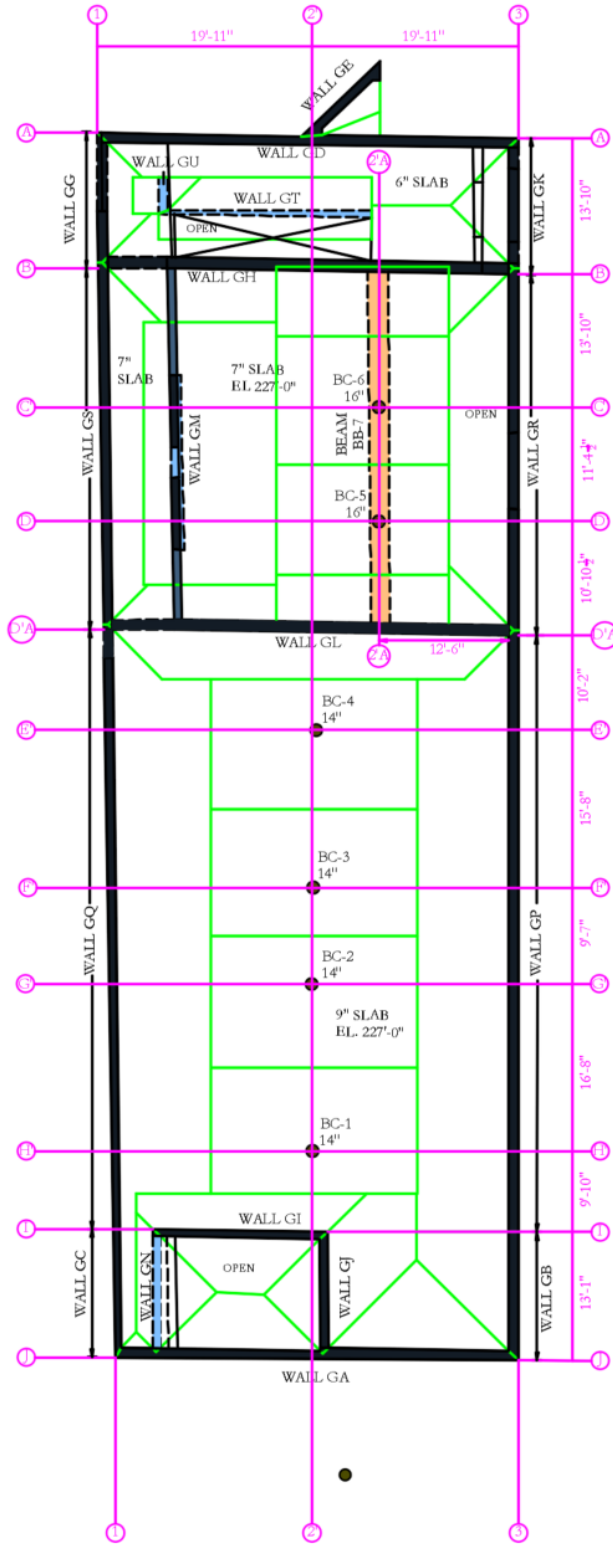

Figure 71: Library floor framing plan.



Building B - Storage Floor Framing Plan (S09)
 On this level: floor slabs, columns, and walls
 Supports below: walls, beam, and columns



Figure 72: Storage floor framing plan.

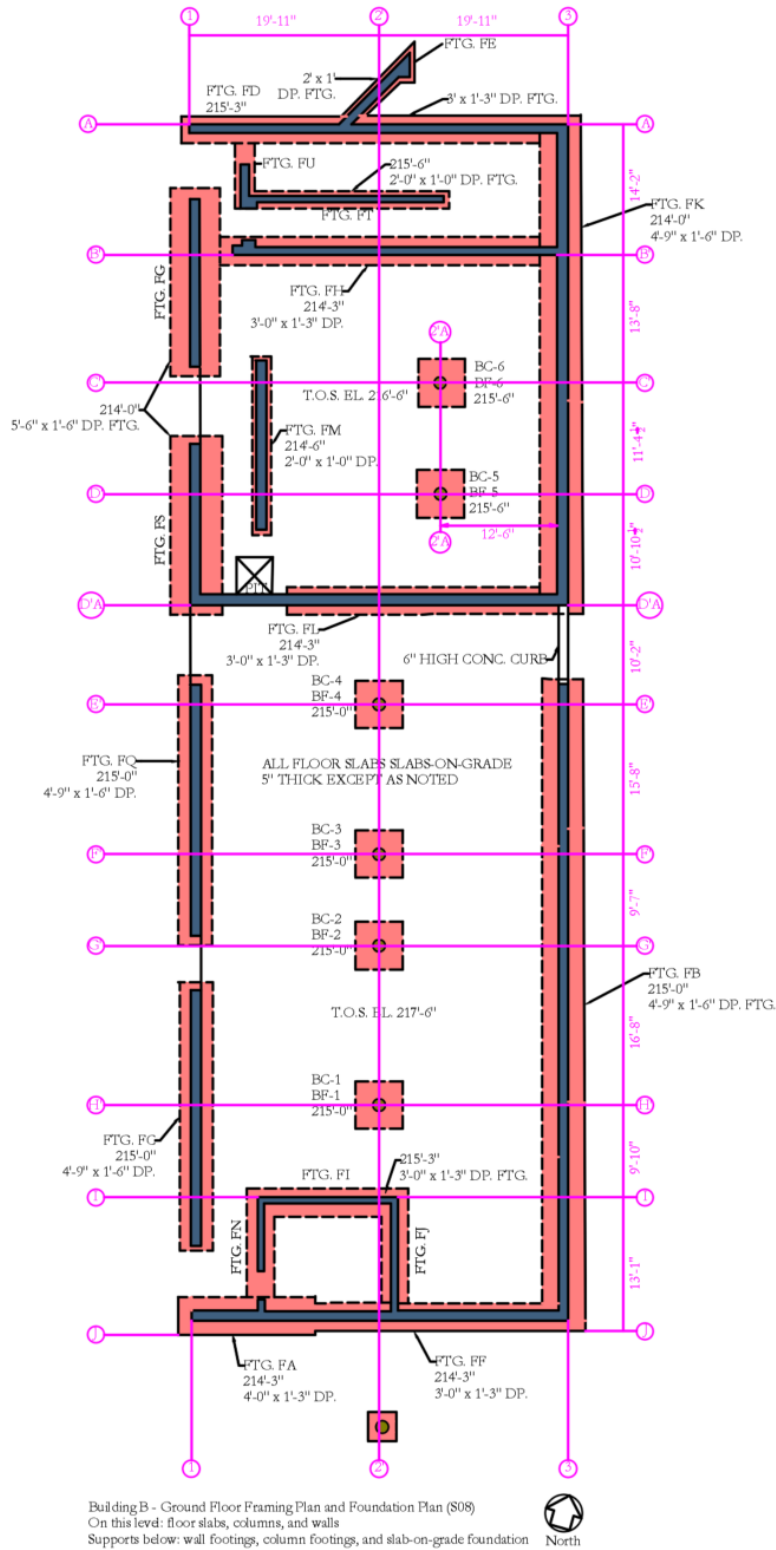

Figure 73: Ground floor framing plan and foundation plan.

Column and Beam Applied Load Calculations

Columns

Example Column Applied Load Calculation Set - Current (Column BC-14, 3F-1)

Step #1 – Determining Dead Load of Slab on Column

Tributary Area of Slab on Column: 322.96 ft²

Slab Thickness: .67 ft

Weight of Concrete: .15 k/ft³

$$DL_{\text{Slab}} = \text{Weight} * \text{Tributary Area} * \text{Thickness} = .15 * 322.96 * .67 = 32.46 \text{ k}$$

Step #2 – Determining Dead Load of Above Columns/Beams on Column

Weight of Concrete: .15 k/ft³

Volume of Above Column/Beam: N/A

Load Transferred from Above Column/Beam: 0 k

$$DL_{\text{Components}} = (\text{Volume} * \text{Weight}) + \text{Load Transferred} = (\text{N/A} * .15) + 0 = 0 \text{ k}$$

Step #3 – Determining Total Dead Load on Column

$DL_{\text{Slab}} = 32.46 \text{ k}$

$DL_{\text{Components}} = 0 \text{ k}$

$$DL_{\text{Total}} = DL_{\text{Slab}} + DL_{\text{Components}} = 32.46 + 0 = 32.46 \text{ k}$$

Step #4 – Determining Live Load on Column

Tributary Area of Slab on Column: 322.96 ft²

Current Live Load: .04 ksf

$$LL_{\text{Total}} = \text{Tributary Area} * \text{Current LL} = 322.96 * .04 = 12.92 \text{ k}$$

Step #5 – Determining Applied Load Combination on Column

$DL_{\text{Total}} = 32.46 \text{ k}$

$LL_{\text{Total}} = 12.92 \text{ k}$

$$\text{Total Load} = (1.2 * DL_{\text{Total}}) + (1.6 * LL_{\text{Total}}) = (1.2 * 32.46) + (1.6 * 12.92) = 59.62 \text{ k}$$

Example Column Applied Load Calculation Set - New (Column BC-14, 3F-1)

Step #1 – Determining Dead Load of Slab on Column

Tributary Area of Slab on Column: 322.96 ft²

Slab Thickness: .67 ft

Weight of Concrete: .15 k/ft³

New Roof Composition: .027 ksf

$$\begin{aligned} DL_{\text{Slab}} &= (\text{Weight} * \text{Tributary Area} * \text{Thickness}) + (\text{Tributary Area} * \text{New Roof Composition}) \\ &= (.15 * 322.96 * .67) + (322.96 * .027) = 41.18 \text{ k} \end{aligned}$$

Step #2 – Determining Dead Load of Above Columns/Beams on Column

Weight of Concrete: .15 k/ft³

Volume of Above Column/Beam: N/A

Load Transferred from Above Column/Beam: 0 k

$$DL_{\text{Components}} = (\text{Volume} * \text{Weight}) + \text{Load Transferred} = (\text{N/A} * .15) + 0 = 0 \text{ k}$$

Step #3 – Determining Total Dead Load on Column

$DL_{\text{Slab}} = 41.18 \text{ k}$

$DL_{\text{Components}} = 0 \text{ k}$

$$DL_{\text{Total}} = DL_{\text{Slab}} + DL_{\text{Components}} = 41.18 + 0 = 41.18 \text{ k}$$

Step #4 – Determining Live Load on Column

Tributary Area of Slab on Column: 322.96 ft²

Current Live Load: .1 ksf

$$LL_{\text{Total}} = \text{Tributary Area} * \text{Current LL} = 322.96 * .1 = 32.30 \text{ k}$$

Step #5 – Determining Applied Load Combination on Column

$DL_{\text{Total}} = 41.18 \text{ k}$

$LL_{\text{Total}} = 32.30 \text{ k}$

$$\text{Total Load} = (1.2 * DL_{\text{Total}}) + (1.6 * LL_{\text{Total}}) = (1.2 * 41.18) + (1.6 * 32.30) = 101.09 \text{ k}$$

Summarized Table of Current and New Design Applied Loads on all Columns

Table 21: Summary of Current and New Design Applied Loads on all Columns

Item	Current Applied Loads	New Design Applied Loads
	Current P_u (k)	New P_u (k)
Column BC-14 (3F-1)	59.62	101.09
Column BC-13 (3F-2)	59.10	100.21
Column BC-12 (3F-3)	57.74	97.90
Column BC-11 (3F-4)	57.16	96.92
Column BC-10 (3F-5)	57.65	97.75
Column BC-9 (3F-6)	55.91	94.81
Column BC-14 (2F-1)	162.09	203.56
Column BC-13 (2F-2)	160.71	201.81
Column BC-12 (2F-3)	157.06	197.23
Column BC-11 (2F-4)	155.50	195.26
Column BC-10 (2F-5)	156.82	196.92
Column BC-9 (2F-6)	152.17	191.06
Column BC-6' (LF-1)	50.36	50.36
Column BC-6 (LF-2)	50.24	50.24
Column BC-5' (LF-3)	65.04	65.04
Column BC-5 (LF-4)	64.88	64.88
Column BC-4 (SF-3)	123.86	123.86
Column BC-3 (SF-4)	87.34	87.34
Column BC-2 (SF-5)	89.74	89.74
Column BC-1 (SF-6)	90.15	90.15
Column BC-6 (SF-1)	119.80	119.80
Column BC-5 (SF-2)	127.50	127.50
Column BC-6 (Fd-1)	188.66	188.66
Column BC-5 (Fd-2)	186.62	186.62
Column BC-4 (Fd-3)	204.62	204.62
Column BC-3 (Fd-4)	166.04	166.04
Column BC-2 (Fd-5)	171.08	171.08
Column BC-1 (Fd-6)	167.63	167.63

Beams

Applied moments on beams were determined by modeling all beams in RISA-3D with accurate loads applied to estimated locations to simulate the beams in real-time. The applied moments were based on the results that the software provided from these simulations.

Summarized Table of Current and New Design Applied Moments on all Beams

Table 22: Summary of Current and New Design Applied Moments on all Beams

Item	Current Applied Moments	New Design Applied Moments
	Current Mu (k-ft)	New Mu (k-ft)
Beam BB-13	40.859	40.859
Beam BB-6	2386.554	2815.769
Beam BB-5	2802.391	3305.866
Beam BB-4	2740.325	3232.407
Beam BB-3	2711.15	3198.21
Beam BB-2	2736.137	3227.362
Beam BB-1	2654.615	3131.017
Beam BB-12	40.859	40.859
Beam BB-14	73.68	73.68
Beam BB-15	84.248	84.248
Beam BB-16	50.764	50.764
Beam BB-17	56.956	56.956
Beam BB-18	53.205	53.205
Beam BB-19	58.944	58.944
Beam BB-20	58.693	58.693
Beam BB-21	64.162	64.162
Beam BB-8	274.008	274.008
Beam BB-10	0	0
Beam BB-9	325.053	325.053
Beam BB-11	0	0
Beam BB-22	145.931	145.931
Beam BB-7	13.606	13.606

Example Column Capacity Calculation (Column BC-14, 3F-1)

Step #1: Identify Necessary Values

Column Diameter: 14 in

$$A_g = \pi * r^2 = 3.14159 * 7^2 = 153.94 \text{ in}^2$$

s = 1 in

$$A_{\text{Core}} = \pi * (r-s)^2 = 3.14159 * 6^2 = 113.10 \text{ in}^2$$

$$A_s = \text{ASTM Section Area} * \# \text{ of Studs} = .31 * 6 = 1.86 \text{ in}^2$$

$F'_c = 3 \text{ ksi}$

$F_y = 60 \text{ ksi}$

$$F_{ys} = 60 \text{ ksi}$$

$$A_{sp} = .11$$

Step #2: Determine if Column Satisfies Minimum Spiral Reinforcement Requirements

$$\rho_s = (4 * A_{sp}) / ((\text{Diameter} - 2 * s) * s) = (4 * .11) / ((14 - 2 * 1) * 1) = .0367$$

$$\text{ACI Required, } \rho_s = ((.45 * F'_c) / F_y) * ((A_g / A_{\text{Core}}) - 1) = ((.45 * 3) / 60) * ((153.94 / 113.10) - 1) = .0081$$

$$\rho_s > \text{ACI Required, } \rho_s \text{ ---} > .0367 > .0081$$

We can state that this column satisfies minimum spiral reinforcement requirements

Step #3: Determine the Column Load Capacity

$$P_N = (A_s * F_y) + .85 * F'_c * (A_g - A_s) = (1.86 * 60) + .85 * 3 * (153.94 - 1.86) = 499.3987 \text{ k}$$

*Summarizing Table of Load Capacities for All Columns**

Table 23: Summary of Load Capacities for All Columns

Item	Current Load Capacity ΦP_n (k)
Column BC-14 (3F-1)	499.3986705
Column BC-13 (3F-2)	499.3986705
Column BC-12 (3F-3)	499.3986705
Column BC-11 (3F-4)	499.3986705
Column BC-10 (3F-5)	499.3986705
Column BC-9 (3F-6)	499.3986705
Column BC-14 (2F-1)	499.3986705
Column BC-13 (2F-2)	499.3986705
Column BC-12 (2F-3)	499.3986705
Column BC-11 (2F-4)	499.3986705
Column BC-10 (2F-5)	499.3986705
Column BC-9 (2F-6)	499.3986705
Column BC-6' (LF-1)	875.791488
Column BC-6 (LF-2)	875.791488
Column BC-5' (LF-3)	875.791488
Column BC-5 (LF-4)	875.791488
Column BC-4 (SF-3)	544.2096705
Column BC-3 (SF-4)	544.2096705
Column BC-2 (SF-5)	544.2096705
Column BC-1 (SF-6)	544.2096705
Column BC-6 (SF-1)	875.791488
Column BC-5 (SF-2)	875.791488
Column BC-6 (Fd-1)	875.791488
Column BC-5 (Fd-2)	875.791488
Column BC-4 (Fd-3)	544.2096705
Column BC-3 (Fd-4)	544.2096705
Column BC-2 (Fd-5)	544.2096705
Column BC-1 (Fd-6)	544.2096705

*Green indicates Capacity > Both Applied Loads

Yellow indicates Capacity > One out of Two Applied Loads

Red indicates Capacity < Both Applied Loads

Beam Capacity Calculations

Example Beam Capacity Calculation (Beam BB-13)

Step #1: Identify Necessary Values

$$F'_c = 3 \text{ ksi}$$

$$F_y = 60 \text{ ksi}$$

$$\text{Beam Height "h"} = 12 \text{ in}$$

$$\text{Beam Width "b"} = 10 \text{ in}$$

$$\text{Nominal Diameter - Top (ASTM Standard)} = .75$$

$$\text{Nominal Diameter - Bottom (ASTM Standard)} = 1.128$$

$$d'_{\text{Top}} = 1.5 + (.5 * \text{Nominal Diameter}) = 1.5 + (.5 * .75) = 1.875 \text{ in}$$

$$d'_{\text{Bottom}} = 1.5 + (.5 * \text{Nominal Diameter}) = 1.5 + (.5 * 1.128) = 2.064 \text{ in}$$

$$d = h - d'_{\text{Bottom}} = 12 - 2.064 = 9.936 \text{ in}$$

$$A_s = \# \text{ of Bars} * \text{Section Area (Bottom)} = 2 * 1 = 2 \text{ in}^2$$

$$A'_s = \# \text{ of Bars} * \text{Section Area (Top)} = 2 * .44 = .88 \text{ in}^2$$

Step #2: Calculate "c" and "a"

$$c = ((A_s - A'_s) * F_y) / (.85 * F'_c * \beta_1 * b) = ((2 - .88) * 60) / (.85 * 3 * .85 * 10) = 3.1003 \text{ in}$$

$$a = \beta_1 * c = .85 * 3.1003 = 2.6353 \text{ in}$$

Step #3: Verify Assumption that the Beam is Yielding

$$\epsilon'_s = ((c - d'_{\text{Top}}) / c) * .003 = ((3.1003 - 1.875) / 3.1003) * .003 = .001186$$

$$\epsilon_y = 60 \text{ ksi} / 29000 \text{ ksi} = .002069$$

$$\epsilon'_s < \epsilon_y \text{ ---} > .001186 < .002069$$

We can state that the beam is yielding

Step #4: Compute Strains, Stresses, and Steel Areas

$$F'_s = \epsilon'_s * E_s = .001186 * 29000 = 34.38491 \text{ ksi}$$

$$A_{s2} = (A'_s * F'_s) / F_y = (.88 * 34.38491) / 60 = .504312 \text{ in}^2$$

$$A_{s1} = A_s - A_{s2} = 2 - .504312 = 1.495688 \text{ in}^2$$

$$\epsilon_t = ((d-c)/c) \cdot .003 = ((9.936 - 3.1003) / 3.1003) \cdot .003 = .02681$$

$$\epsilon_t > .005 \text{ ---} \rightarrow .02681 > .005 \text{ ---} \rightarrow \phi = .9$$

Step #5: Determine Design Moment Strength

$$\phi M_n = \phi * (A_{s1} * F_y * (d - (a/2)) + A_{s'} * F'_s * (d - d'))$$

$$= .9 * (1.496 * 60 * (9.936 - (2.6353/2)) + .88 * 34.385 * (9.936 - 1.875)) = 915.6038 \text{ k-ft}$$

*Summarizing Table of Moment Capacities of All Beams**

Table 24: Summary of Moment Capacities of All Beams

Item	Moment Capacity ΦM_n (k-ft)
Beam BB-13	915.6038115
Beam BB-6	9683.436852
Beam BB-5	22110.85609
Beam BB-4	22110.85609
Beam BB-3	22110.85609
Beam BB-2	22110.85609
Beam BB-1	22110.85609
Beam BB-12	915.6038115
Beam BB-14	4040.123823
Beam BB-15	4040.123823
Beam BB-16	4040.123823
Beam BB-17	4040.123823
Beam BB-18	4040.123823
Beam BB-19	4040.123823
Beam BB-20	4040.123823
Beam BB-21	4040.123823
Beam BB-8	11212.35888
Beam BB-10	2284.357133
Beam BB-9	11212.35888
Beam BB-11	2284.357133
Beam BB-22	6282.880234
Beam BB-7	2648.534475

*Green indicates Capacity > Both Applied Moments

Yellow indicates Capacity > One out of Two Applied Moments

Red indicates Capacity < Both Applied Moments

Wall Applied Load and Wall Strength Calculations

Assumptions and Notes

P_u is the load combination 1.2DL + 1.6LL

Unit weight of concrete = 150 pcf (normal weight)

Current roof LL = 40 psf

New roof LL = 100 psf

LL for all other levels = 100 psf (does not change in new design)

New DL = 9.03 psf (due to new roofing materials)

See Appendix A for wall reinforcement.

$f'_c = 3,000$ psi = 3 ksi

$k = 0.8$

$f_y = f_{yt} = 60,000$ psi = 60 ksi

$\Phi = 0.9$ or 0.75 for shear

$q_n = 4$ tons/sf = 288 ksi

$\gamma = 0.85$

$\lambda = 1$

The number of bars rounded up in A_s and A_v equations.

Table 25: Building B Wall Applied Loads and Strengths

Item	Current P_u	New P_u	ΦP_n	ΦM_n	ΦV_n
Wall 3A	119 k	149 k	6,178 k	6,056 ft-k	13,300 k
Wall 3B	84 k	120 k	2,537 k	1,342 ft-k	5,570 k
Wall 3C	41 k	50 k	2,159 k	793 ft-k	4,647 k
Wall 3D	43 k	54 k	2,107 k	710 ft-k	4,535 k
Wall 3E	33 k	40 k	1,883 k	576 ft-k	4,053 k
Wall 3F	61 k	78 k	2,921 k	1,431 ft-k	6,288 k
Wall 3G	36 k	42 k	2,146 k	788 ft-k	4,619 k
Wall 3H	163 k	227 k	6,178 k	6,056 ft-k	13,300 k
Wall 3I	64 k	90 k	2,301 k	845 ft-k	4,053 k
Wall 3K	37 k	42 k	2,146 k	788 ft-k	4,619 k

Wall 2A	263 k	293 k	6,325 k	6,056 ft-k	13,090 k
Wall 2B	198 k	234 k	2,614 k	1,342 ft-k	5,481 k
Wall 2C	86 k	96 k	2,210 k	793 ft-k	4,573 k
Wall 2D	91 k	102 k	2,157 k	710 ft-k	4,464 k
Wall 2E	63 k	69 k	1,928 k	576 ft-k	3,989 k
Wall 2F	113 k	73 k	2,991 k	1,431 ft-k	6,189 k
Wall 2G	66 k	73 k	2,197 k	788 ft-k	4,546 k
Wall 2H	358 k	422 k	6,325 k	6,056 ft-k	13,090 k
Wall 2I	147 k	173 k	2,355 k	845 ft-k	4,874 k
Wall 2K	71 k	76 k	2,197 k	788 ft-k	4,546 k
Wall 1A	217 k	235 k	3,716 k	1,892 ft-k	6,803 k
Wall 1B	167 k	193 k	2,011 k	705 ft-k	3,672 k
Wall 1C	110 k	120 k	2,337 k	793 ft-k	4,279 k
Wall 1D	134 k	145 k	2,157 k	710 ft-k	4,464 k
Wall 1E	92 k	99 k	1,928 k	576 ft-k	3,989 k
Wall 1F	165 k	182 k	2,991 k	1,431 ft-k	6,189 k
Wall 1G	97 k	103 k	2,197 k	788 ft-k	4,546 k
Wall 1H	548 k	612 k	6,325 k	6,056 ft-k	13,090 k
Wall 1I	329 k	355 k	6,689 k	6,056 ft-k	12,249 k
Wall 1J	133 k	145 k	2,099 k	594 ft-k	3,844 k
Wall 1K	106 k	110 k	2,197 k	788 ft-k	4,546 k
Wall 1L	28 k	28 k	602 k	51 ft-k	1,102 k
Wall 1M	29 k	29 k	2,157 k	671 ft-k	3,950 k
Wall 1P	2,244 k	2,499 k	18,621 k	39,220 ft-k	32,374 k
Wall 1Q	2,184 k	2,432 k	18,621 k	39,220 ft-k	32,374 k
Wall LA	263 k	282 k	3,345 k	1,635 ft-k	6,334 k
Wall LB	203 k	229 k	3,111 k	1,431 ft-k	5,891 k
Wall LC	143 k	153 k	3,111 k	1,431 ft-k	5,891 k
Wall LD	172 k	184 k	2,220 k	710 ft-k	4,320 k
Wall LE	119 k	126 k	1,984 k	576 ft-k	3,861 k
Wall LF	212 k	230 k	3,079 k	1,431 ft-k	5,990 k
Wall LG	125 k	131 k	2,261 k	788 ft-k	4,400 k
Wall LH	724 k	788 k	8,029 k	7,569 ft-k	15,746 k
Wall LI	488 k	515 k	6,581 k	6,056 ft-k	12,459 k
Wall LJ	174 k	186 k	2,010 k	578 ft-k	3,805 k
Wall LK	137 k	142 k	2,261 k	788 ft-k	4,400 k
Wall LL	45 k	45 k	592 k	51 ft-k	1,121 k
Wall LM	55 k	55 k	2,122 k	671 ft-k	4,018 k
Wall LP	2,661 k	2,916 k	16,838 k	39,710 ft-k	31,877 k

Wall LQ	2,596 k	2,844 k	16,838 k	39,710 ft-k	31,877 k
Wall SA	579 k	609 k	7,475 k	7,569 ft-k	15,937 k
Wall SB	270 k	295 k	3,534 k	1,699 ft-k	7,535 k
Wall SC	190 k	200 k	2,764 k	1,431 ft-k	6,587 k
Wall SD	505 k	534 k	6,459 k	6,056 ft-k	12,880 k
Wall SE	142 k	149 k	1,968 k	576 ft-k	3,925 k
Wall SG	163 k	169 k	2,773 k	920 ft-k	5,136 k
Wall SH	857 k	921 k	5,324 k	4,211 ft-k	10,616 k
Wall SI	549 k	575 k	3,143 k	1,831 ft-k	7,490 k
Wall SJ	51 k	51 k	1,908 k	679 ft-k	4,547 k
Wall SK	174 k	178 k	2,773 k	920 ft-k	5,136 k
Wall SL	89 k	89 k	7,986 k	7,569 ft-k	14,790 k
Wall SM	326 k	326 k	6,162 k	5,597 ft-k	12,287 k
Wall SR	1,150 k	1,246 k	7,635 k	7,056 ft-k	15,054 k
Wall SS	1,073 k	1,166 k	7,635 k	7,056 ft-k	14,140 k
Wall GA	680 k	710 k	3,582 k	1,517 ft-k	6,591 k
Wall GB	324 k	350 k	3,800 k	1,699 ft-k	6,993 k
Wall GC	229 k	238 k	3,800 k	1,699 ft-k	6,993 k
Wall GD	624 k	653 k	7,931 k	7,569 ft-k	15,077 k
Wall GE	165 k	171 k	1,948 k	576 ft-k	3,925 k
Wall GG	197 k	203 k	2,754 k	920 ft-k	5,236 k
Wall GH	1,005 k	1,069 k	7,931 k	7,569 ft-k	15,077 k
Wall GI	607 k	634 k	2,845 k	1,155 ft-k	5,526 k
Wall GJ	102 k	102 k	2,128 k	679 ft-k	4,135 k
Wall GK	211 k	216 k	2,754 k	920 ft-k	5,236 k
Wall GL	261 k	261 k	7,931 k	7,569 ft-k	15,077 k
Wall GM	448 k	448 k	3,459 k	1,485 ft-k	6,576 k
Wall GN	33 k	33 k	2,128 k	679 ft-k	4,135 k
Wall GP	2,036 k	2,196 k	9,754 k	17,056 ft-k	26,524 k
Wall GQ	1,990 k	2,146 k	9,754 k	17,056 ft-k	26,524 k
Wall GR	1,254 k	1,349 k	7,367 k	6,504 ft-k	14,004 k
Wall GS	1,177 k	1,270 k	7,367 k	6,504 ft-k	14,004 k
Wall GT	55 k	55 k	2,985 k	1,612 ft-k	6,071 k
Wall GU	11 k	11 k	730 k	69 ft-k	1,388 k

Lateral Load Calculations

Applied wind load is 20 psf (drawing S01).

The third, second, and first floors are entirely above ground and exposed to the weather. The levels below that are at least partially underground.

Sometimes the wind loads are transferred to a wall at an angle that is neither perpendicular nor parallel to the surface of the wall. This resultant force is split into its components, one of which acts as an additional lateral force that gets transferred to the wall(s) perpendicular to the original wall, and the other acts as a shear force.

Table 26: Building B Wind Analysis

Item	Wind Load	Transfers to	Transfer Load	Bending Moment (ft-k)
Wall 3A	9.56 k	Wall 3B	4.78 k	28.68 ft-k
		Wall 3C	4.78 k	28.68 ft-k
Wall 3B	4.52 k	Wall 3A	4.52 k	27.12 ft-k
Wall 3C	3.34 k	Wall 3A	3.34 k	20.04 ft-k
Wall 3D	3.26 k	Wall 3K	3.26 k	19.56 ft-k
Wall 3E	2.91 k	Wall 3F	2.91 k	
		Wall 3G	2.06 k	8.74 ft-k
		Wall 3F	2.06 k	8.74 ft-k
Wall 3F	4.52 k	Wall 3G	4.52 k	27.12 ft-k
Wall 3G	3.32 k	Wall 3F	1.66 k	9.96 ft-k
		Wall 3H	1.66 k	9.96 ft-k
Wall 3K	3.32 k	Wall 3D	1.66 k	9.96 ft-k
		Wall 3H	1.66 k	9.96 ft-k
Wall 2A	8.76 k	Wall 2B	4.38 k	24.10 ft-k
		Wall 2C	4.38 k	24.10 ft-k
Wall 2B	4.14 k	Wall 2A	4.14 k	22.79 ft-k
Wall 2C	3.06 k	Wall 2A	3.06 k	16.84 ft-k
Wall 2D	2.99 k	Wall 2K	2.99 k	16.44 ft-k
Wall 2E	2.67 k	Wall 2F	2.67 k	
		Wall 2G	1.89 k	7.34 ft-k
		Wall 2F	1.89 k	7.34 ft-k
Wall 2F	4.14 k	Wall 2G	4.14 k	22.79 ft-k
Wall 2G	3.04 k	Wall 2F	1.52 k	8.37 ft-k
		Wall 2H	1.52 k	8.37 ft-k
Wall 2K	3.04 k	Wall 2D	1.52 k	8.37 ft-k
		Wall 2H	1.52 k	8.37 ft-k
Wall 1A	3.54 k	Wall 1C	3.54 k	14.16 ft-k
Wall 1B	2.16 k	Wall 1I	1.08 k	4.32 ft-k
		Wall 1J	1.08 k	4.32 ft-k
Wall 1C	2.23 k	Wall 1A	1.11 k	4.45 ft-k

		Wall 1I	1.11 k	4.45 ft-k
Wall 1D	2.99 k	Wall 1K	2.99 k	16.44 ft-k
Wall 1E	2.67 k	Wall 1F	2.67 k	
		Wall 1G	1.89 k	7.34 ft-k
		Wall 1F	1.89 k	7.34 ft-k
Wall 1F	4.14 k	Wall 1G	4.14 k	22.79 ft-k
Wall 1G	3.04 k	Wall 1F	1.52 k	8.37 ft-k
		Wall 1H	1.52 k	8.37 ft-k
Wall 1J	2.00 k	Wall 1B	2.00 k	8.00 ft-k
Wall 1K	3.04 k	Wall 1D	1.52 k	8.37 ft-k
		Wall 1H	1.52 k	8.37 ft-k
Wall 1L	0.57 k	Wall 1M	0.29 k	
		Wall 1L	0.29 k	1.15 ft-k
		Wall 1M	0.41 k	1.15 ft-k
Wall 1M	2.06 k	Wall 1L	2.06 k	
		Wall 1M	1.45 k	4.11 ft-k
		Wall 1L	1.45 k	4.11 ft-k
Wall 1P	14.51 k	Wall 1I	14.51 k	58.05 ft-k
Wall 1Q	14.51 k	Wall 1I	14.51 k	58.05 ft-k

Seismic Analysis

STEP 1

$S_s = 0.2g = 0.2$ Figure 22-1 ASCE-7 (g.159)

$S_1 = 0.6g = 0.06$ Figure 22-2 ASCE-7 (g.161)

STEP 2

Doesn't qualify for an exception

STEP 3

1. Soil classification

Site Class D 2012 IBC section 1613.3.2

2. $S_{ds} = (2/3)F_a S_s$

$F_a = 1.6$ Table 11.4-1 ASCE-7

$$S_{ds} = 0.2133$$

$$S_{d1} = (2/3)F_v S_1$$

$$F_v = 2.4 \quad \text{Table 11.4-2 ASCE-7}$$

$$S_{d1} = 0.096$$

3. Risk Category

Category III (Considered a school)

4. SDS (Seismic Design Category)

S_{ds} : B Table 11.6-1 ASCE-7

S_{d1} : B Table 11.6-2 ASCE-7

STEP 4

1. Fundamental period, $T_a = (C_t)(h_n^x)$

$C_t = 0.02$ Table 12.8-2 ASCE-7 Other structural systems

$h_n = 64.5$ ft Defined by ASCE-7 Section 11.2 "Structural height"

$x = 0.75$ Table 12.8-2 ASCE-7 Other structural systems

$$T_a = 0.4552$$

2. $T_{limit} = C_u T_a$

$C_u = 1.7$ Table 12.8-1 ASCE-7

$$T = 1.275$$

3. $T_s = S_{d1}/S_{ds}$

$$T_s = 0.45$$

4. Irregularities

Horizontal irregularity type 5 Table 12.3-1 ASCE-7

No vertical irregularities Table 12.3-2 ASCE-7

STEP 5

$R = 5.5$ Table 12.2-1 E.8 ASCE-7

STEP 6

Seismic Importance Factor

$$I_e = 1.25$$

STEP 7

$$1. V = C_s W$$

$$C_s = S_{d1} / (R / I_e) = 0.0218$$

Section 12.8.1.1 Equation 12.8-2

Table 27: Slab Weights

Level	Slab Weight
Roof	531 k
Third	541 k
Second	335 k
First	427 k
Library	157 k
Storage	395 k
Ground	296 k

$$W = 2,682 \text{ k}$$

$$V = 59 \text{ k}$$

$$2. T_L = 6 \quad \text{Figures 22-12 through 22-16 ASCE-7}$$

STEP 8

$$F_x = C_{vx} V$$

$$C_{vx} = w_x h_x^k / \sum (w_i h_i^k)$$

$$k = 2 \quad \text{Given in Step 8}$$

Model structure as two levels:

Level 1 - storage floor, ground floor, and footings, 12" thick walls

Level 2 - all floors above storage floor, 8" thick walls

Table 28: Seismic Analysis, Step 8

	Level 1	Level 2
w_x	692 k	1,991 k
h_x	9.5 ft	54 ft
C_{vx}	0.011	0.99
F_x	1 k	58 k

STEP 10

$$1. E = P Q_e + 0.2 S_{ds} D$$

Table 29: Seismic Analysis, Step 10, Part 1

	Level 1	Level 2
Q_e	1 k	58 k
$P Q_e$	1 k	58 k
D	692 k	1,991 k
$0.2 S_{ds} D$	30 k	85 k
E	30 k	143 k

2. Basic Load Combination

$$(1.2 + 0.2 S_{ds}) * D + P Q_e + L + 0.2 S \quad 12.4.2.3 \text{ Equation 5 ASCE-7}$$

Snow load included in L according to S01

Table 30: Seismic Analysis, Step 10, Part 2

	Level 1	Level 2
$(1.2 + 0.2 S_{ds}) * D$	859 k	2,474 k
$P Q_e$	1 k	58 k
L	2,055 k	858 k
$0.2 S$	0 k	0 k
$(1.2 + 0.2 S_{ds}) * D + P Q_e + L + 0.2 S$	2,915 k	3,390 k

$$3. E_m = E_{mh} + E_v$$

$$E_{mh} = \Omega Q_e$$

$$E_v = 0.2 S_{ds} D$$

$$\Omega = 2.5 \quad \text{Table 12.2.1 ASCE-7}$$

Table 31: Seismic Analysis, Step 10, Part 3

	Level 1	Level 2
$E_{mh} =$	2 k	145 k
$E_v =$	30 k	85 k
$E_m =$	31 k	230 k

CONCLUSION

Table 32: Seismic Analysis, Conclusion

	Level 1	Level 2
$E_m =$	31 k	230 k
ΦV_n (k)	350,208 k	410,183 k
OK?	OK	OK

Note: We did not analyze the diagonal walls on the second and third floors. They are included in the weight of the structure, but not the shear capacity.

Column Footing Applied Load Calculations

Column loads transfer straight to the column footings.

Dead load on column footings is the column below T.O.S. EL. of floor slab.

Table 33: Column Footing Applied Loads

Footing	Volume	Self-weight	Dead load	Transfer Load Combination (current)	Transfer Load Combination (new)	Total Load Combination (current)	Total Load Combination (new)
BF-1	30.38 CF	4.56 k	0.4009 k	167.63 k	167.63 k	173.58 k	173.58 k
BF-2	30.38 CF	4.56 k	0.4009 k	171.08 k	171.08 k	177.03 k	177.03 k
BF-3	30.38 CF	4.56 k	0.4009 k	166.04 k	166.04 k	171.99 k	171.99 k
BF-4	30.38 CF	4.56 k	0.4009 k	204.62 k	204.62 k	210.57 k	210.57 k
BF-5	50.00 CF	7.50 k	0.2094 k	186.62 k	186.62 k	195.88 k	195.88 k
BF-6	78.13 CF	11.72 k	0.2094 k	188.66 k	188.66 k	202.97 k	202.97 k

Column Footing Capacity Calculations

See footing Schedule (Appendix A) for reinforcement.

$$f'_c = 3 \text{ ksi,}$$

$$f_y = 60 \text{ ksi}$$

$$\lambda = 1 \text{ (normal weight concrete)}$$

$$\alpha_s = 40 \text{ (interior column)}$$

$$\Phi = 0.75 \text{ (shear), } 0.9 \text{ (moment)}$$

$$V_s, v_s = 0 \text{ (no shear reinforcement)}$$

$$\beta = 1$$

Table 34: Strength Calculations, Footings BF-1 through BF-4

b_w	d	ΦV_n			
54"	14.0625"	1,973 k			
c	b_0	v_c Eq. 1	v_c Eq. 2	v_c Eq. 3	ΦV_c
14"	112.25"	219 psi	329 psi	384 psi	259 k
A_s	b	a	ΦM_n		
1.86 in ²	54"	0.810457516"	1,372 ft-k		

Table 35: Strength Calculations, Footing BF-5

b_w	d	ΦV_n			
60"	20.0625"	3,127 k			
c	b_0	v_c Eq. 1	v_c Eq. 2	v_c Eq. 3	ΦV_c
16"	144.25"	219 psi	329 psi	414 psi	476 k
A_s	b	a	ΦM_n		
1.86 in ²	60"	0.729411765"	1,978 ft-k		

Table 36: Strength Calculations, Footing BF-6

b_w	d	ΦV_n			
75"	20.0625"	3,909 k			
c	b_0	v_c Eq. 1	v_c Eq. 2	v_c Eq. 3	ΦV_c
16"	144.25"	219 psi	329 psi	414 psi	476 k
A_s	b	a	ΦM_n		
2.17 in ²	75"	0.680784314"	2,311 ft-k		

Wall Footing Calculations

For assumptions and notes, see wall assumptions.

Table 37: Wall Footing Applied Loads and Capacities

Item	Current w_u	New w_u	ΦM_n	ΦV_n	Max. P
Footing FA	48.9 k/ft	50.9 k/ft	31,016 ft-k	1,465 k	1,417 k
Footing FB	36.4 k/ft	39.1 k/ft	158,207 ft-k	2,175 k	1,213 k
Footing FC	30.4 k/ft	32.3 k/ft	83,059 ft-k	2,175 k	1,533 k
Footing FD	15.8 k/ft	16.5 k/ft	65,237 ft-k	1,099 k	1,555 k
Footing FE	15.3 k/ft	15.9 k/ft	15,724 ft-k	546 k	2,411 k
Footing FF	8.2 k/ft	8.4 k/ft	50,705 ft-k	1,099 k	1,792 k
Footing FG	39.1 k/ft	41.4 k/ft	96,885 ft-k	2,508 k	2,163 k
Footing FH	29.3 k/ft	31.1 k/ft	59,531 ft-k	1,099 k	1,601 k
Footing FI	37.0 k/ft	38.6 k/ft	33,937 ft-k	1,099 k	1,842 k
Footing FJ	9.0 k/ft	9.0 k/ft	26,044 ft-k	1,099 k	1,882 k
Footing FK	29.8 k/ft	31.7 k/ft	133,632 ft-k	2,175 k	1,344 k
Footing FL	9.5 k/ft	9.5 k/ft	54,462 ft-k	1,099 k	1,756 k
Footing FM	24.7 k/ft	24.7 k/ft	22,676 ft-k	546 k	2,426 k
Footing FN	3.4 k/ft	3.4 k/ft	27,407 ft-k	1,099 k	1,957 k
Footing FQ	51.5 k/ft	55.5 k/ft	83,059 ft-k	2,175 k	1,531 k
Footing FS	36.4 k/ft	39.3 k/ft	93,420 ft-k	2,508 k	2,195 k
Footing FT	3.0 k/ft	3.0 k/ft	25,094 ft-k	546 k	1,679 k
Footing FU	2.1 k/ft	2.1 k/ft	11,188 ft-k	546 k	3,274 k

Roof Slab Calculations

Picked a random section of the roof slab, took a 1' slice of it, and treated it as a simply supported beam.

Beam dimensions:

Length = 20.42 ft

Height = 0.67 ft

Width = 1 ft

Reinforcement:

#4 @ 14", 1" from the bottom of the beam

Applied loads:

$$DL = 0.027 \text{ k/ft}$$

$$LL = 0.1 \text{ k/ft}$$

$$w_u = 0.1924 \text{ k/ft}$$

$$M_u = 10.025 \text{ ft-k} \quad \text{*distributed load only}$$

Moment capacity:

$$f'_c = 3 \text{ ksi}$$

$$f_y = 60 \text{ ksi}$$

$$\Phi = 0.9$$

$$b = 12 \text{ in}$$

$$h = 8 \text{ in}$$

$$d = 7 \text{ in}$$

$$A_s = 0.2 \text{ in}^2$$

$$\rho = 0.00238$$

$$\Phi M_n = 73.476 \text{ ft-k}$$

Max. point load:

$$P = 13.54 \text{ k}$$

Load Transfers from Roof

Zone A

	Max. P		Max. P
Wall 3A	6,030 k		
Wall 2A	6,032 k		
Wall 1A	3,481 k	Wall 1J	1,954 k
Wall LA	3,064 k	Wall LJ	1,824 k
Wall SA	6,866 k		

Wall GA	2,872 k		
Footing FA	1,417 k		
Limiting P:	1,417 k	Footing FA	

Zone B

	Max. P		Max. P
Wall 3B	2,417 k		
Wall 2B	2,380 k		
Wall 1B	1,818 k	Wall 1P	16,122 k
Wall LB	2,883 k	Wall LP	13,921 k
Wall SB	3,239 k	Wall GP	7,558 k
Wall GB	3,451 k		
Footing FB	1,213 k		
Limiting P:	1,213 k	Footing FB	

Zone C

	Max. P		
Wall 3C	2,108 k		
Wall 2C	2,114 k		
Wall 1C	2,217 k		
Wall LC	2,959 k		
Wall SC	2,564 k		
Wall GC	3,562 k		
Footing FC	1,553 k		
Limiting P:	1,553 k	Footing FC	

Zone D

	Max. P		
Wall 3D	2,053 k		
Wall 2D	2,055 k		
Wall 1D	2,012 k		
Wall LD	2,037 k		
Wall SD	5,926 k		
Wall GD	7,278 k		
Footing FD	1,555 k		
Limiting P:	1,555 k	Footing FD	

Zone E

	Max. P
Wall 3E	1,843 k
Wall 2E	1,858 k
Wall 1E	1,828 k
Wall LE	1,858 k
Wall SE	1,820 k
Wall GE	1,777 k
Footing FE	2,411 k

Limiting P: 1,777 k Wall GE

Zone F

	Max. P
Wall 3F	2,843 k
Wall 2F	2,918 k
Wall 1F	2,809 k
Wall LF	2,849 k
Wall SD	5,926 k
Wall GD	7,278 k
Footing FD	1,555 k

Limiting P: 1,555 k Footing FD

Zone G

	Max. P
Wall 3G	2,104 k
Wall 2G	2,124 k
Wall 1G	2,093 k
Wall LG	2,130 k
Wall SG	2,604 k
Wall GG	2,551 k
Footing FG	2,163 k

Limiting P: 2,093 k Wall 1G

Zone H

	Max. P
Wall 3H	5,951 k
Wall 2H	5,903 k

Wall 1H	5,713 k
Wall LH	7,241 k
Wall SH	4,404 k
Wall GH	6,862 k
Footing FH	1,601 k

Limiting P: 1,601 k Footing FH

Zone I

	Max. P
Wall 3I	2,210 k
Wall 2I	2,182 k
Wall 1I	6,334 k
Wall LI	6,066 k
Wall SI	2,568 k
Wall GI	2,211 k
Footing FI	1,842 k

Limiting P: 1,842 k Footing FI

Zone J

	Max. P	
Column BC-9	411 k	supports roof
Column BC-9	314 k	supports 3rd floor
Beam BB-1	1,906 k	transfers column loads

	Max. P		Max. P	
Wall 1P	16,122 k	Wall 1Q	16,189 k	half to 1P, half to 1Q
Wall LP	13,921 k	Wall LQ	13,994 k	1P to LP, 1Q to LQ
Wall GP	7,558 k	Wall GQ	7,608 k	LP to GP & SR
Wall SR	6,389 k	Wall SS	6,469 k	LQ to GQ & SS
Wall GR	6,018 k	Wall GS	6,097 k	SR to GR, SS to GS
Footing FK	1,344 k	Footing FG	2,163 k	GR to FK, GS to FG & FS
		Footing FS	2,195 k	

Limiting P: 314 k Column BC-9 (supports 3rd floor)

Limiting max. P for 1P down:	1,344 k	Footing FK
Limiting max. P for 1Q down:	2,163 k	Footing FG
Limiting max. P for 1P or 1Q down:	1,344 k	Footing FK

Zone K

	Max. P
Wall 3K	2,104 k
Wall 2K	2,121 k
Wall 1K	2,086 k
Wall LK	2,119 k
Wall SK	2,595 k
Wall GK	2,538 k
Footing FK	1,344 k

Limiting P: 1,344 k Footing FK

Zone L

	Max. P	
Column BC-10	408 k	supports roof
Column BC-10	309 k	supports 3rd floor
Beam BB-2	1,896 k	transfers column loads
Same load transfer as for Zone J		

Limiting P: 309 k Column BC-10 (supports 3rd floor)

Zone M

	Max. P	
Column BC-11	409 k	supports roof
Column BC-11	310 k	supports 3rd floor
Beam BB-3	1,899 k	transfers column loads
Same load transfer as for Zone J		

Limiting P: 310 k Column BC-11 (supports 3rd floor)

Zone N

	Max. P	
Column BC-12	408 k	supports roof
Column BC-12	309 k	supports 3rd floor

Beam BB-4 1,896 k transfers column loads
 Same load transfer as for Zone J

Limiting P: 309 k Column BC-12 (supports 3rd floor)

Zone P

Same load transfer as for Zone J (starting at 1P)

Limiting P: 1,344 k Footing FK

Zone Q

Same load transfer as for Zone J (starting at 1Q)

Limiting P: 2,163 k Footing FG

Zone R

Max. P
 Column BC-13 406 k supports roof
 Column BC-13 304 k supports 3rd floor
 Beam BB-5 1,888 k transfers column loads
 Same load transfer as for Zone J

Limiting P: 304 k Column BC-13 (supports 3rd floor)

Zone S

Max. P
 Column BC-14 405 k supports roof
 Column BC-14 302 k supports 3rd floor
 Beam BB-6 708 k transfers column loads
 Same load transfer as for Zone J

Limiting P: 302 k Column BC-14 (supports 3rd floor)

The strongest zones have independent load paths:

Zone A can support 1,417,152 lb

Zone C can support 1,552,536 lb

Zone D can support 1,555,494 lb

Zone E can support 1,777,235 lb

Zone F can support 1,555,494 lb

Zone G can support 2,093,253 lb

Zone H can support 1,600,940 lb

Zone I can support 1,842,463 lb

If all zones are at full capacity,

Loads on 1P to foundation: 4,825,828 lb

Capacity of 1P to foundation load path: 1,344,226 lb NG

Loads on 1Q to foundation: 3,087,103 lb

Capacity of 1Q to foundation load path: 2,163,103 lb NG

Appendix I – Building B Waterproofing Details

Roof plan with details in light gray called out

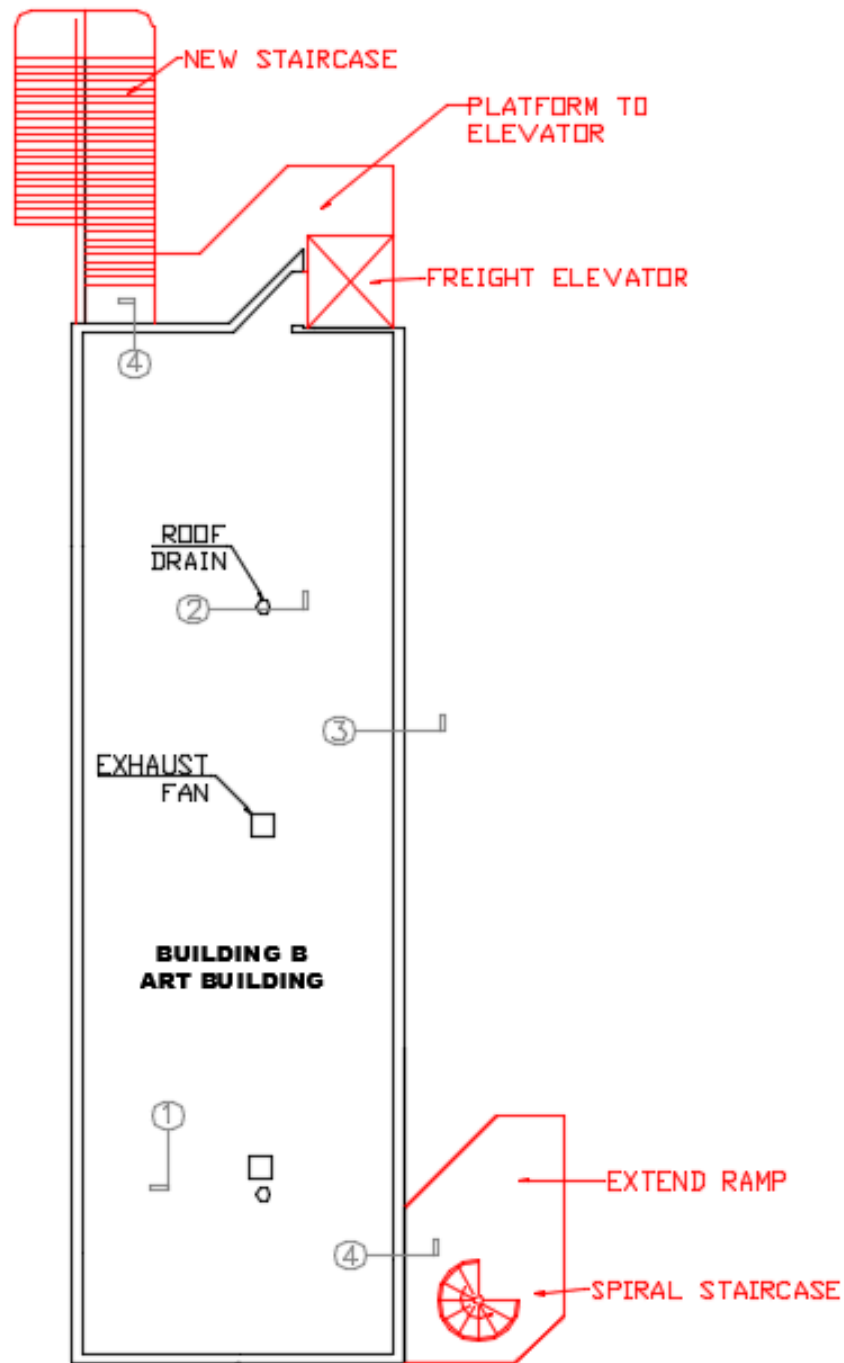

Ⓐ BUILDING B ROOF PLAN WB

Detail 1 – Kemper waterproofing system

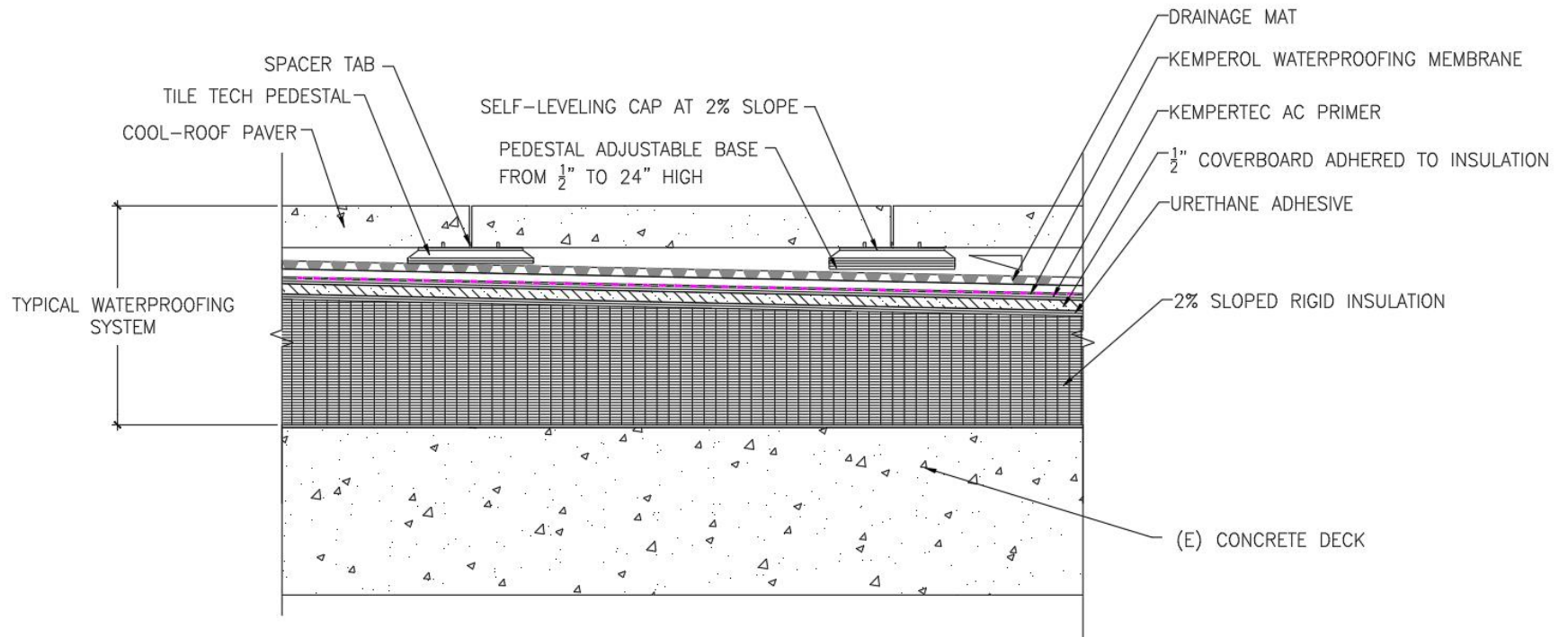

TERRACE WATERPROOFING ASSEMBLY WITH INSULATION AND OVERBURDEN – SECTION

1

Detail 2 – Drain Detail

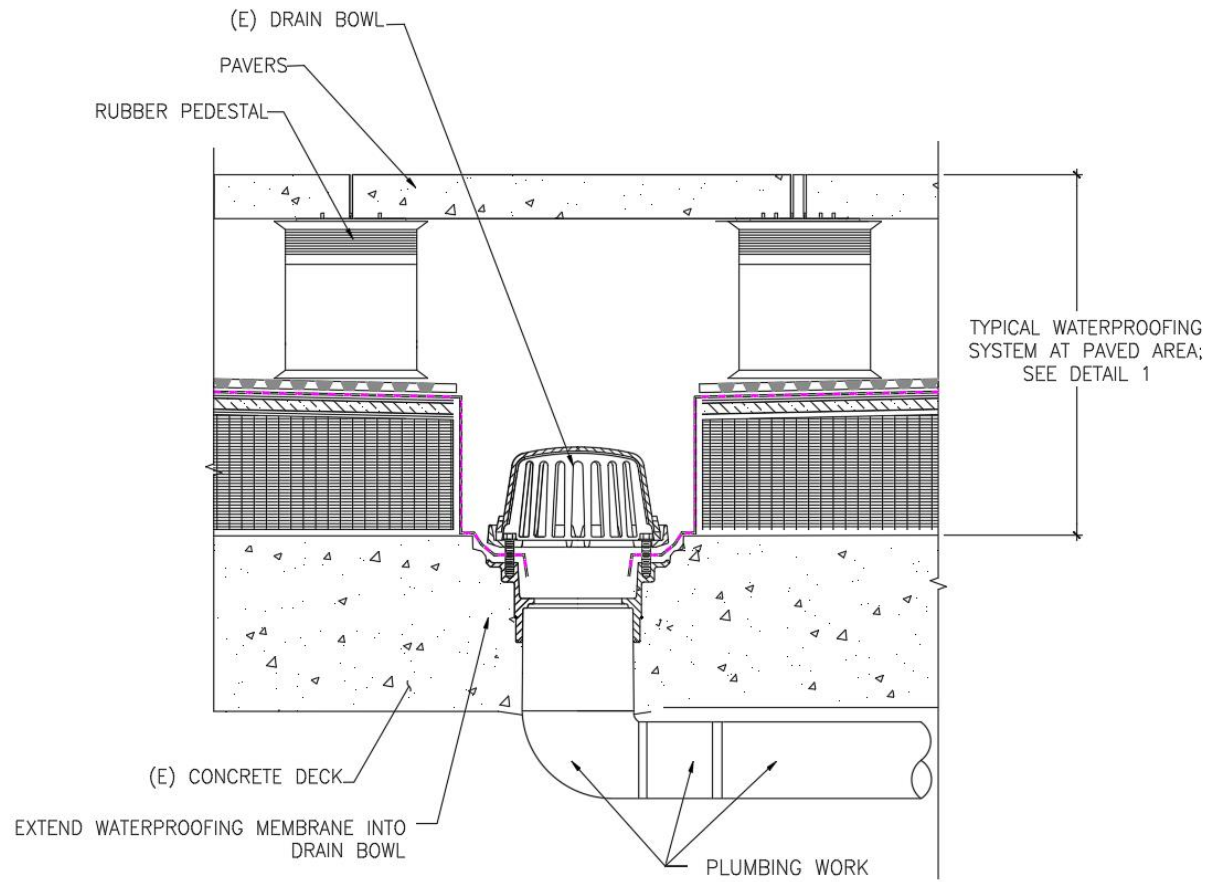

2 DRAIN BOWL WATERPROOFING – SECTION

3"=1'0"

Detail 3 – Parapet edge detail

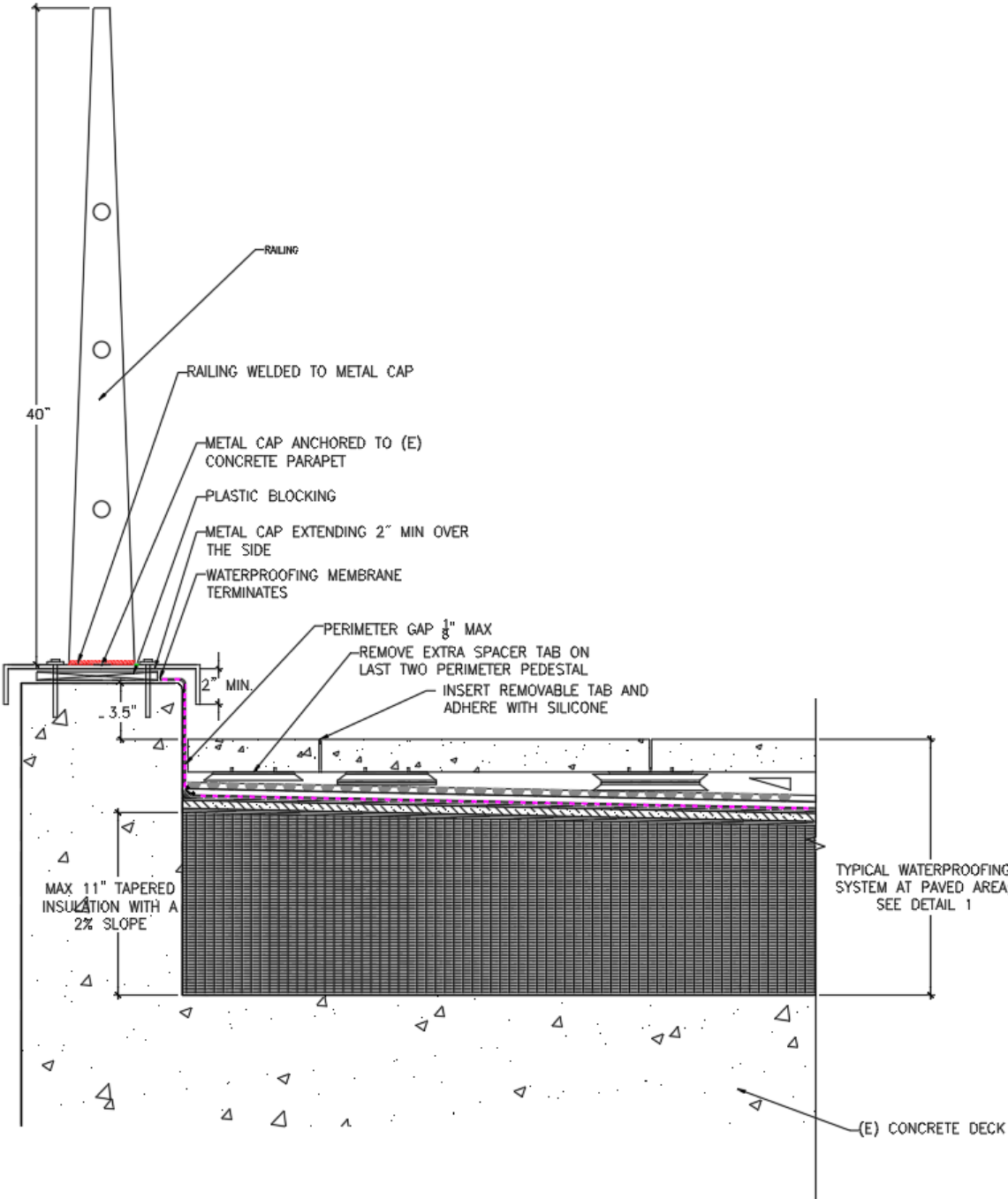

3 CONCRETE WALL FLASHING – SECTION

3"=10"

Detail 4 – Stair Connection Detail

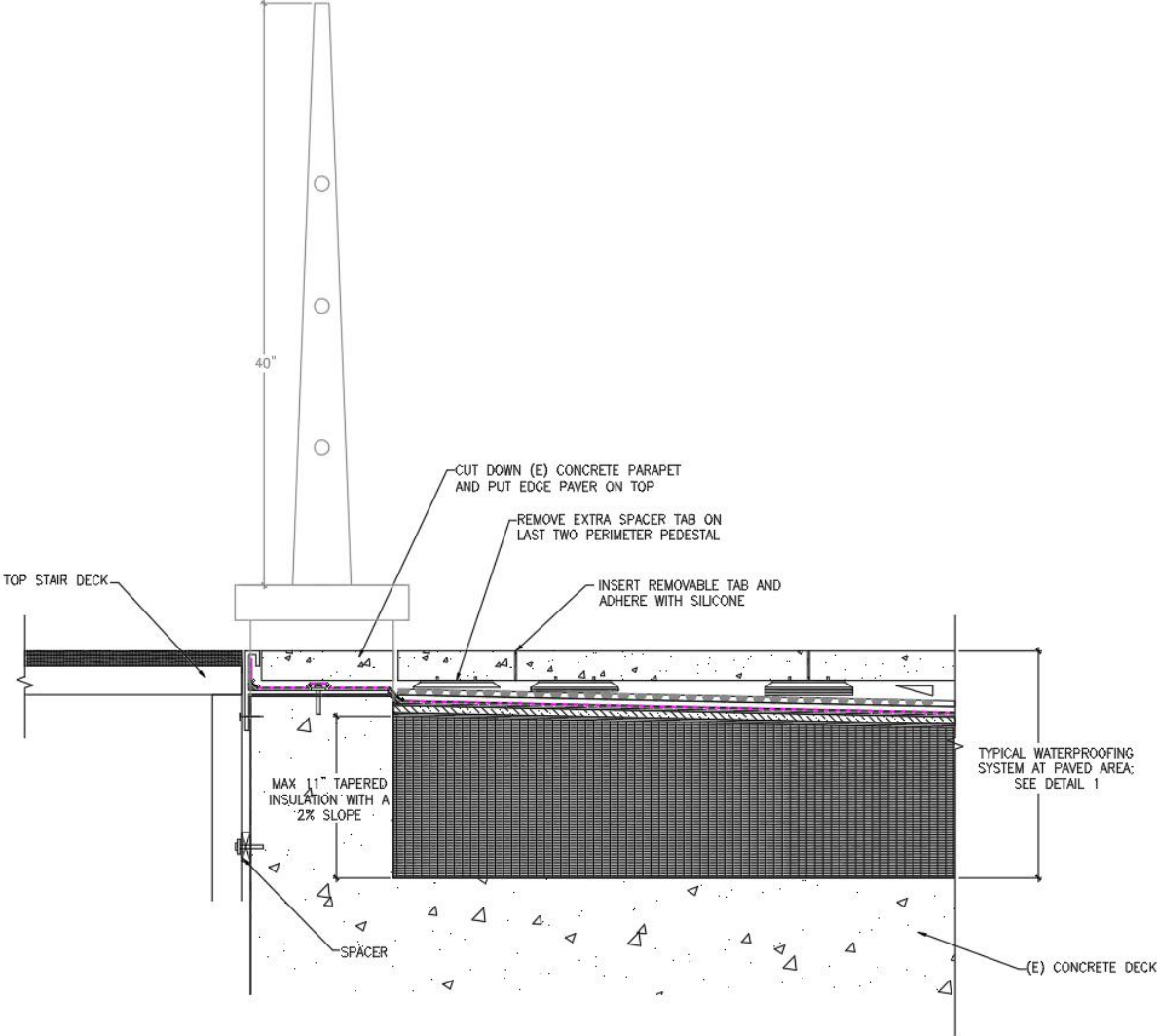

4 STAIR PLATFORM TO CONCRETE WALL CONNECTION – SECTION

3/10

Appendix J – Building B Waterproofing Product Data Sheets

Table 38: List of Layers used in new waterproofing roof design

<i>New Deck Layers</i>	<i>Product Name</i>	<i>Manufacturer</i>
1. Pavers	Cool-Roof Paver Series	Tile Tech Pavers
2. Pedestals	Stadard Adjustable Pedestals	Tile Tech Pavers
3. Drainage Mat	ArmorDrain 110 Protection/Drainage Mat	Marflex
4. Kemperol Waterproofing	Kemperol 2K-Pur	Kemper Systems
5. Kempertec AC Primer	Kempertec AC primer	Kemper Systems
6. Coverboard	Isogard HD Cover Board	Firestone
7. Urethane Adhesive	I.S.O Twin pack Adhesive	Firestone
8. Rigid Insulation	Tapered ISO 95+	Firestone

1. Pavers

Cool-Roof™ Series Pavers



Most of the roofs in the world including over 90% of the roofs in the United States are dark-colored. To help reduce the heat island effect created by the dark densely placed urban roofs which, contributes to global warming, Tile Tech has developed the Cool-Roof™ series pavers. Solar-reflective Cool-Roof™ Pavers are ideal for creating functional and attractive rooftop, terraces, balconies and plazas.



Superior Color Stability

Produced from premium, ultra white, raw materials that is uniformly distributed throughout the thickness of the paver insures lifetime color stability.



Heat & Light Reflecting: A cool roof is one that reflects the sun's heat and emits absorbed radiation back into the atmosphere. The roof literally stays cooler and reduces the amount of heat transferred to the building below, keeping the building a cooler and more energy efficient.



Superior High Strength

Produced under extreme hydraulic pressure by bonding crushed granite & quartz in a cement matrix duplicating the forces of nature.

Our Cool-Roof™ pavers utilize a high reflective value and low emissivity rate resulting in a high Solar Reflectance Index (SRI) value; Tile Tech Cool-Roof™ pavers have a minimum SRI value of .78. This high SRI value allows you to meet the needs for "LEED" certified projects when used on your roof and balconies and can also be installed on pedestals for a complete roofing system.

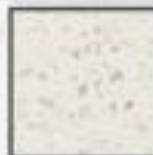

Superior Surface Finish

Surface is ground to expose the natural beauty of the quartz chips and can be honed and shot blasted resulting in a granite-like, slip resistant paver.

Standard Sizes



12 x 12



16 x 16



20 x 20



12 x 24



16 x 24

Please Note: Colors & finishes shown are only a representation. Please request samples for approval.

tiletechpavers.com

36 Cool-Roof™ - Colors



Cool-White



Cool-Blue



Cool-Green



Cool-Yellow



Cool-Gray



Cool-Red



Cool-Orange



Cool-Roof™ paver can become an integral part of achieving LEED value credits under LEED NC Version 2.1 Credit 7.2. Full one credit value under Heat Island Effect Roof for compliance with ASTM E 408 in conjunction with this LEEDS version can be

achieved by specifically utilizing the Penny Lane or Cool-White colors with a value of .9 or greater. Our Cool-Roof™ pavers can be used for plaza or roof applications requiring LEED certification in either pedestal configurations or loose-laid applications.



Energy efficiency at your feet...

Architectural Pavers - Sizes & Specs 37

PAVER SPECS	Size L x W (inch)	Thickness (inch)	Weight per SqFt (Lb)	Weight per Unit (Lb)	Unit per Pallet (pcs)	Colors				
						Granite Tech	Stamp Tech	Oceanic Ser.	Cool Reef	
 12x12	11.875" x 11.875" 300mm x 300mm	1" 1-1/2" 2"	• • •	11lb	11lb	350	•	•	•	•
				21lb	21lb					
 12x24	11.875" x 23.622" 300mm x 600mm	1" 1-1/2" 2"	• • •	16lb	32lb	95	•	•	•	•
				20lb	40lb					
 16x16	15.75" x 15.75" 400mm x 400mm	1" 1-1/4" 1-1/2" 2"	• • • •	15lb	30lb	108	•	•	•	•
				15lb	30lb					
 16x24	15.75" x 23.622" 400mm x 600mm	1" 1-1/4" 1-1/2" 2"	• • • •	16lb	42lb	55lb	•	•	•	•
				21lb	55lb					
 20x20	19.68" x 19.68" 500mm x 500mm	1" 1-1/2" 2"	• • •	21lb	50lb	48	•	•	•	•
				21lb	50lb					
 Coping	48" x 14" 1200mm x 400mm	1" 1-1/2" 2"	• • •	18lb	70lb	12	•	•	•	•
				18lb	70lb					
*Full Rounded Bullnose										

PAVER PROPERTIES	TEST METHOD	RESULTS
Compressive Strength	ASTM C-140	8,000psi Min
Flexural Strength	ASTM C-293	700psi/Min
Water Absorption	ASTM C-696	5% Max
Coefficient of Friction	ASTM C-1038	0.6% Min
Freeze Thaw	ASTM C-67	1% Max
Dimensional Tolerance	±1/16" Length, width, height, corners, corners.	

For complete material & installation specifications, please visit our website or contact us.

MAINTENANCE

Pavers will require some periodic maintenance to keep them in a reasonable condition. Dirt, dust and leaves should be regularly removed and any weed growth should be sprayed and controlled.

CLEANING

All pavers will require cleaning from time to time. Oil, rust, efflorescence and other stains can detract from the appearance of the paver. Specialized cleaning products for concrete pavers are readily available.

SEALING

If a more protective surface is required or the pavers will knowingly be subject to salt attack then we suggest sealing your paving. Tile Tech recommends sealing pavers not for structural reasons but for aesthetic and maintenance purposes.

tiletechpavers.com



Tile Tech® Pedestal

Paving America one step at a time!

Uni-Just™ & Stak-Cap™ Pedestal System



- Single Model Design
- PVC Pipe Adjustable
- Screw Adjustable
- Self-Leveling
- Stackable

HYBRID PEDESTAL SYSTEM - TECHNICAL DETAILS







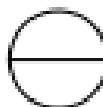







National Distribution Tel: 213-380-5580
Toll Free: 888-380-5575 Fax: 213-380-5581



TILE TECH PEDESTAL SYSTEM

COMPLETE PRODUCT LINE & COMPONENTS LIST

PRODUCT LINE	MODEL NUMBER	DESCRIPTION
	SPACERS 1/8" & 1/4"	ALLOW FOR 1/8" SPACING GAP BETWEEN PAVERS FOR DRAINAGE. TABS ARE PERFORATED FOR EASY REMOVAL.
	UNI-SHIM™ - 1/8" & 1/16"	USED FOR FINE TUNING OF INDIVIDUAL PAVERS. CAN BE USED ON TOP OR BOTTOM OF PEDESTALS. CAN BE STACKED & BROKEN IN TO QUARTERS OR HALVES.
	STAK-CAP™	USED FOR LOW HEIGHT REQUIREMENTS. ROTATE AND STACK CAPS FOR SLOPE & HEIGHT ADJUSTMENT. CAN ALSO BE USED WITH PVC PIPE TO REACH 6" MAX.
	UNI-CAP™	SELF-LEVELING & ADJUSTABLE IN ANY DIRECTION FROM 0% TO 4% SLOPE. ALIGN & LOCK TO UNI-INSERT™.
	UNI-INSERT™ -75 (3/4")	USED FOR SCREW HEIGHT ADJUSTABILITY OF PEDESTAL. SCREWS IN TO UNI-COLLAR™. PROVIDES ADDITIONAL 3/4" OF HEIGHT ADJUSTMENT IN ADDITION TO PVC PIPE.
	UNI-INSERT™ -150 (1-1/2")	USED FOR SCREW HEIGHT ADJUSTABILITY OF PEDESTAL. SCREWS IN TO UNI-COLLAR™. PROVIDES ADDITIONAL 1-1/2" OF HEIGHT ADJUSTMENT IN ADDITION TO PVC PIPE.
	UNI-COLLAR™	USED FOR SCREW HEIGHT ADJUSTABILITY OF PEDESTAL SYSTEM. COMPRESSION FITS ON TO TOP END OF PVC PIPE.
	UNI-BASE™	USED AS BASE OF PEDESTAL SYSTEM. COMPRESSION FITS ON TO END OF PVC PIPE. CAN ALSO BE USED WITH UNI-INSERT™ FOR LOW HEIGHT APPLICATIONS. LARGE SURFACE AREA PROVIDE ADDED STABILITY.
	BASE SLOPE PLATE (BSP)	USED FOR SLOPE COMPENSATION AT BASE OF PEDESTALS. EACH PLATE COMPENSATES FOR 1/4" PER FOOT (2%) SLOPE AND ADDS 3/8" TO THE OVERALL HEIGHT OF PEDESTAL. MAXIMUM OF FOUR PLATES MAY BE STACKED FOR COMPENSATION OF UP TO 1" PER FOOT (0-8%) SLOPE.
	BUFFER PAD	PROVIDES PROTECTION TO WATERPROOFING MEMBRANE FROM WEAR AND PROVIDES SLIP RESISTANCE TO PEDESTAL. ATTACHES TO BOTTOM OF BASE. ALIGN PERIMETER NOTCHES WITH CHALK LINES.

GENERAL NOTES: APPLY TO ALL OF THE ABOVE PRODUCTS

1. INSTALLATION MUST BE COMPLETED IN ACCORDANCE WITH TILE TECH INC PRODUCT SPECIFICATIONS.
2. DRAWING NOT TO SCALE.
3. USE OF BUFFER PADS IS MANDATORY.
4. CONTRACTOR'S NOTE: FOR PRODUCT AND COMPANY INFORMATION VISIT www.TILETECHPAVERS.com



National Distribution Tel: 213-380-5560
Toll Free: 888-380-5575 Fax: 213-380-5561

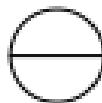

STAK-CAP™ PEDESTAL SYSTEM

COMPONENT ASSEMBLY INSTRUCTIONS.
HEIGHT ADJUSTMENT FROM 1/2" TO 2-1/4" & SLOPE ADJUSTMENT
FROM 0% TO 5%

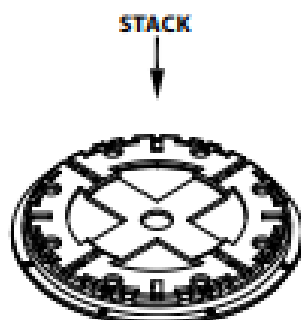
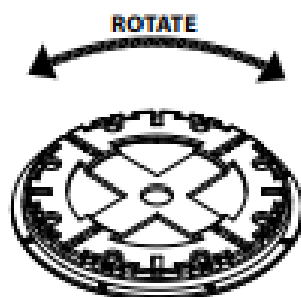

PRODUCT CHARACTERISTICS:

EACH CAP WILL COMPENSATE FOR UP TO 1/8" PER FOOT SLOPE (1%) & ADD 3/8" TO THE OVERALL HEIGHT OF A PEDESTAL. PVC PIPE SHOULD **NOT** BE USED. ROTATE ONE CAP RELATIVE TO ANOTHER BY ALIGNING THE ALPHABETS TO CHANGE SLOPE. A & A WILL REACH MAXIMUM SLOPE AND A & E WILL CANCEL SLOPE. A MAXIMUM OF 5 CAPS CAN BE STACKED WITH TOTAL SLOPE OF 5/8" PER FOOT (5%) & WITH TOTAL HEIGHT OF 2-1/4" INCLUDING THE USE OF BUFFER PADS.

CONFIGURATION CHART:

1 CAP	= 5/8" HIGH	1/8" PER FOOT	1% MAX
2 CAPS	= 1" HIGH	1/4" PER FOOT	2% MAX (A+A)
3 CAPS	= 1-3/8" HIGH	3/8" PER FOOT	3% MAX (A+A+A)
4 CAPS	= 1-7/8" HIGH	1/2" PER FOOT	4% MAX (A+A+A+A)
5 CAPS	= 2-1/4" HIGH	5/8" PER FOOT	5% MAX (A+A+A+A+A)

PVC + 2 CAPS	= VARIABLE HEIGHT	0% MAX
PVC + 3 CAPS	= VARIABLE HEIGHT	1% MAX
PVC + 4 CAPS	= VARIABLE HEIGHT	2% MAX
PVC + 5 CAPS	= VARIABLE HEIGHT	3% MAX

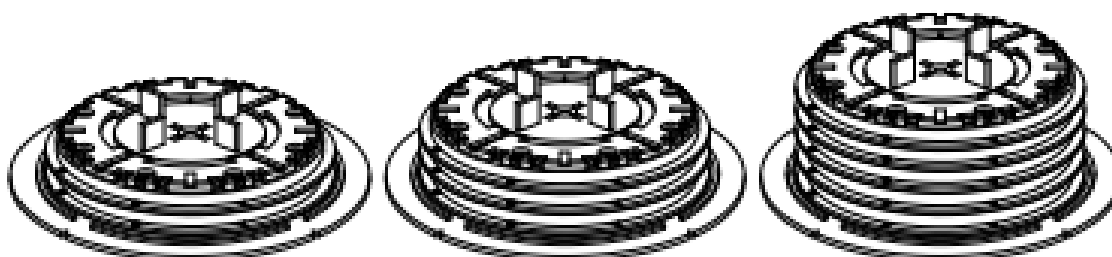

GENERAL NOTES: APPLY TO ALL OF THE ABOVE PRODUCTS

1. INSTALLATION MUST BE COMPLETED IN ACCORDANCE WITH TILE TECH INC PRODUCT SPECIFICATIONS.
2. DRAWING NOT TO SCALE.
3. USE OF BUFFER PADS IS MANDATORY.
4. CONTRACTOR'S NOTE: FOR PRODUCT AND COMPANY INFORMATION VISIT www.TILETECHPAVERS.com



National Distribution Tel: 213-380-5580
Toll Free: 888-380-5575 Fax: 213-380-5581

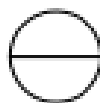

UNI-JUST™ PEDESTAL SYSTEM

COMPONENT ASSEMBLY INSTRUCTIONS.
HEIGHT ADJUSTMENT FROM 2-1/4" TO 24" & SLOPE ADJUSTMENT
FROM 0% TO 4%

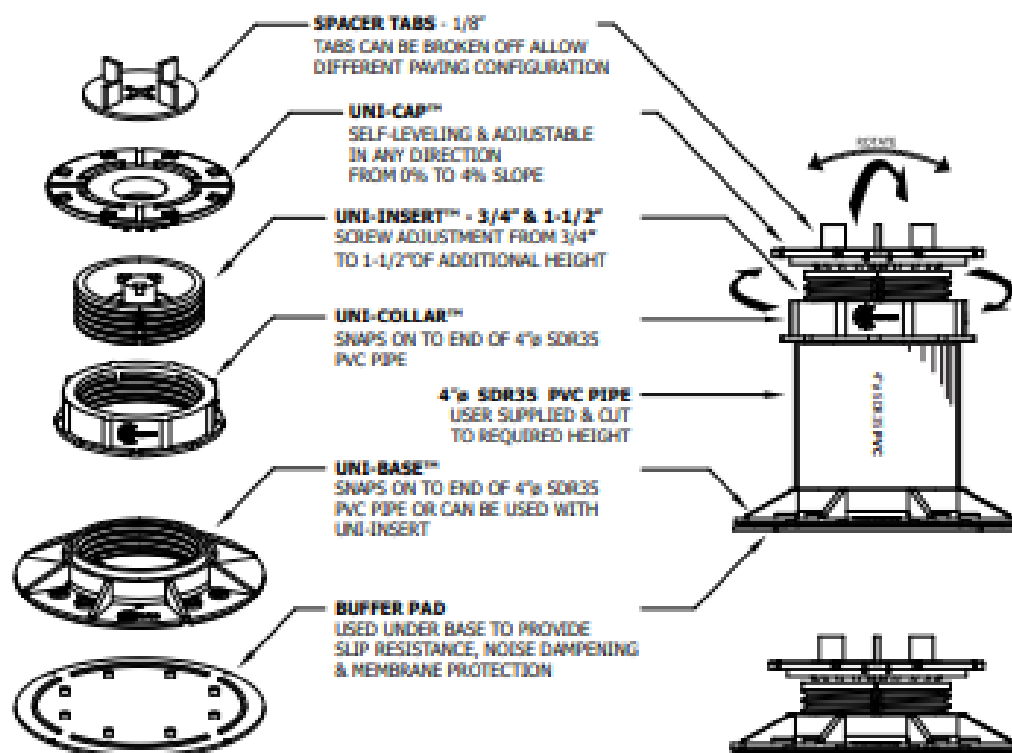

PRODUCT CHARACTERISTICS:

ADJUSTABLE HEIGHT FROM 2-1/4" TO 24" WITH USE OF 4" SDR35 PVC PIPE.
SELF-LEVELING CAP AUTOMATICALLY ADJUST SLOPE FROM 0% TO 4%.
SCREW ADJUSTABLE WHILE PEDESTALS ARE LOADED FOR FINAL HEIGHT ADJUSTMENT OF 1-1/2"
RESISTANT & IMPERVIOUS TO FREEZE-THAW, WATER, MOLD, ACID & ULTRAVIOLET DETERIORATION.
RESISTANT TO TEMPERATURES BETWEEN -22°F AND +250°F.
LARGE FOOT PRINT SPREADS WEIGHT OVER ROOFING MEMBRANE AND SUBSTRATE
BUFFER PADS PROVIDE NOISE DAMPENING, SLIP RESISTANCE AND PROTECTION TO ROOFING MEMBRANE AND
SUBSTRATE.
MAXIMUM DESIGN CAPACITY OF 2,000 LBS PER PEDESTAL.

GENERAL NOTES: APPLY TO ALL OF THE ABOVE PRODUCTS

1. INSTALLATION MUST BE COMPLETED IN ACCORDANCE WITH TILE TECH INC PRODUCT SPECIFICATIONS.
2. DRAWING NOT TO SCALE.
3. USE OF BUFFER PADS IS MANDATORY.
4. CONTRACTOR'S NOTE: FOR PRODUCT AND COMPANY INFORMATION VISIT www.TILETECHPVERS.com

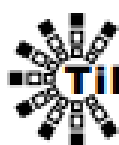

Tile Tech Inc.
Paving another one step at a time!

National Distribution Tel: 213-380-5580
Toll Free: 888-380-5575 Fax: 213-380-5561

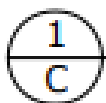

CORNER PEDESTAL APPLICATION

ENLARGED PLAN VIEW & SECTION DETAILS

ENLARGED PLAN VIEW

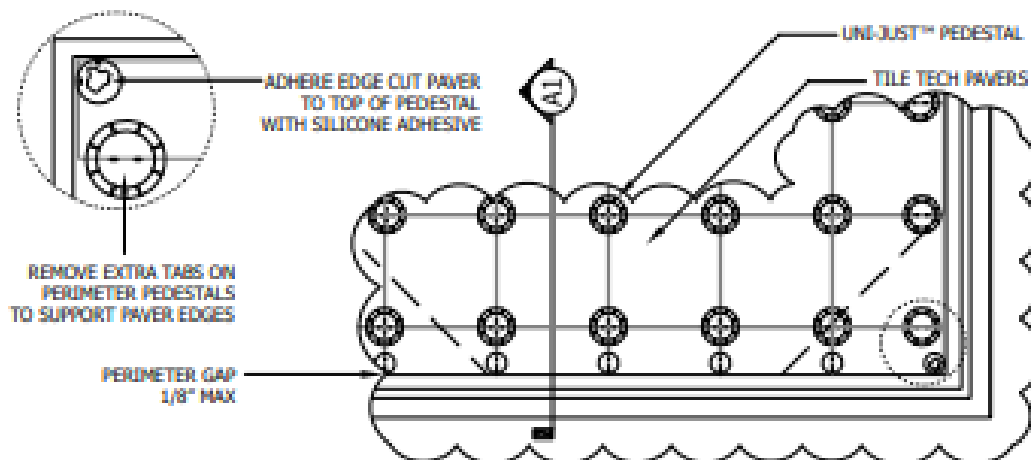

CORNER PEDESTAL APPLICATION - SECTION DETAILS

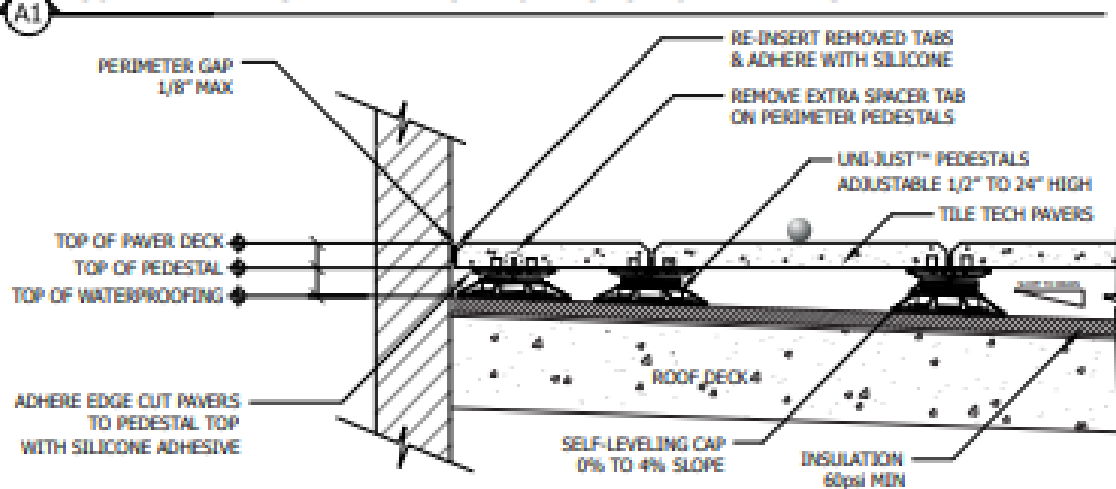

GENERAL NOTES: APPLY TO ALL OF THE ABOVE PRODUCTS

1. INSTALLATION MUST BE COMPLETED IN ACCORDANCE WITH TILE TECH INC PRODUCT SPECIFICATIONS.
2. DRAWING NOT TO SCALE.
3. USE OF BUFFER PADS IS MANDATORY.
4. CONTRACTOR'S NOTE: FOR PRODUCT AND COMPANY INFORMATION VISIT www.TILETECHPAVERS.com



National Distribution 888-360-5575

SECTION 07760

ROOF PAVER SYSTEM

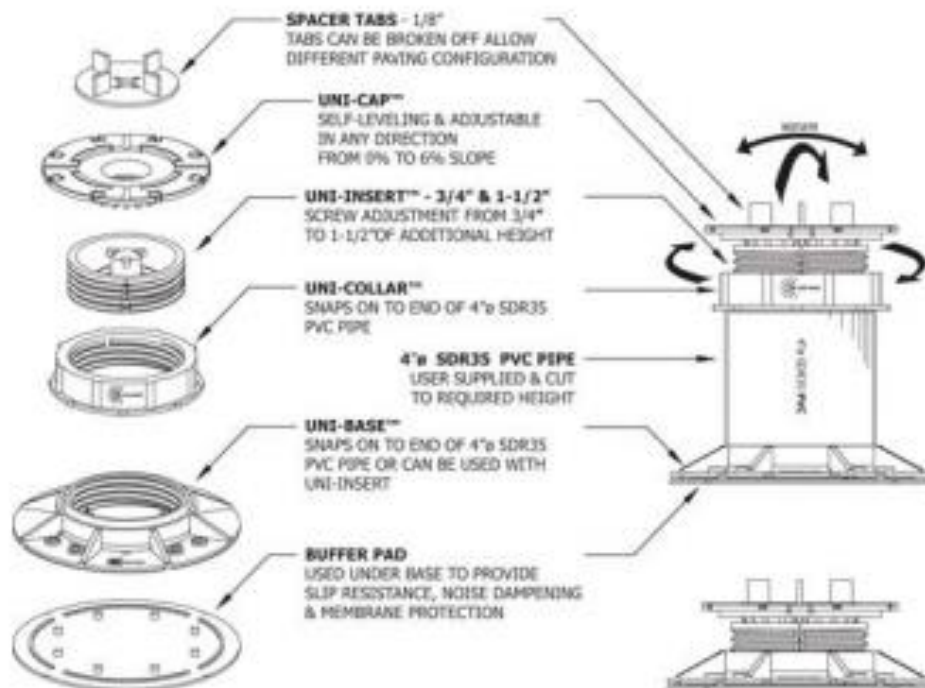

Formula for Calculating Pedestals

<p>Example No.1</p> <p>Materials used: 20" x 20" Tile Tech Paver (2.78 SF per paver)</p> <p>Square Feet Coverage 1,000 SF (20' x 50')</p> <p>Formulas: 1,000 SF/2.78 SF = 360 Pedestal & Pavers needed</p> <p>Calculation of Perimeter (Lineal feet) 20' x 50' area = 140 lineal foot perimeter 140-feet x 12-inch = 1,680-inch 1,680" / 20" (length of paver) = 84 pedestals</p> <p>Total: 360 + 84 = 444 pedestals needed</p>	<p>Example No.2</p> <p>Materials used: 16" x 16" Tile Tech Paver (1.73 SF per paver)</p> <p>Square Feet Coverage 800 SF (20' x 40')</p> <p>Formulas: 800 SF/1.73 SF = 463 Pedestal & Pavers needed</p> <p>Calculation of Perimeter (Lineal feet) 20' x 40' area = 120 lineal foot perimeter 120-feet x 12-inch = 1,440-inch 1,440" / 16" (length of paver) = 90 pedestals</p> <p>Total: 463 + 90 = 553 pedestals needed</p>
---	---

Calculation of perimeter should include inner spaces such as planters!

3. Drainage Mat



**WATERPROOFING &
BUILDING PRODUCTS**



**COMMERCIAL
PRODUCT**

For Heavy Duty Vertical Drainage Applications

ArmorDrain 110 Protection/Drainage Mat

Description

ArmorDrain 110 is a light duty impermeable polymeric sheet that while under heat and pressure is formed into a dimpled drainage core.

The core is then bonded to a single layer of non-woven filter fabric. The filter fabric retains soil and sand particles as well as freshly placed concrete or grout, allowing water to pass into the drainage core.

Purpose

ArmorDrain 110 is engineered to provide ample strength to protect waterproofing membranes against back fill soil and sediment and to provide excellent drainage capabilities providing hydrostatic relief.

AD 110 is ideal for basement foundations, retaining walls, planters or bridge abutments.

Advantages

- Resistance to hydrostatic pressure
- High flow dimpled drainage core
- Protects foundation waterproofing membrane
- Easy installation

Leeds Data

ArmorDrain 110 Core is considered a GREEN product and can be used toward LEEDS building credits.

Prep/Application

After the waterproofing membrane has been applied, start at a corner and install the 110 horizontally against the surface with the non-woven filter fabric side facing out-ward.

Extend the roll from the top of the footer to finished grade. When two edges come together from two separate rolls, overlap the dimples to create a continuous coverage of the wall.

For good adherence, apply uniform pressure throughout the surface area, not just the edges and corners. If needed, secure rolls to the wall using powder actuated mechanical fasteners. Install top fasteners within the top 4" (102 mm).

If the roll overlaps the membrane once you have reached the grade line, a utility knife or similar tool can be used to cut the rolls to the correct height.

Backfilling/Drainage

Backfilling should begin no sooner than 24 hours after the installation of the board, but must be backfilled within 15 days.

Technical Data

Product Name	ArmorDrain 110	Method
Color	Black	
Material	Drainage core: co-polymer polypropylene Geotextile: Polypropylene	
CORE		
Dimple Height	.40" (10.16mm)	ASTM D1777
Compressive Strength	11,000 psf (527 kN/m ²)	ASTM D1621
Geocomposite water flow rate@1/4" Grad 0.1	18 g/min/ft-22.3L/min/M	ASTM D4716
Drainage Core Impact resistance	2.9 J mean failure energy at 50° C	ASTM D4226-09
Drainage core maximum tearing strength	MD 550N CD 800N	ASTM D5884-04a
Drainage core stress cracking resistance	504 hrs @ 156 kPa (No cracking at test termination)	SAGEOS GD 001-2012
Fabric		
Geotextile water flow rate	140 gal/min/ft ² (5704 L/min/m ²)	ASTM D4491
Geotextile grab tensile strength	100 lbs (.45kN)	ASTM D4632
Geotextile elongation	60%	ASTM D4632
Geotextile trapezoidal tear	45 lbs. (200N)	ASTM D4533
Geotextile puncture strength	250 lbs (1.1113 kN)	ASTM D6241
Geotextile mullen burst	210 psi (1446 kPa)	ASTM D3786
Geotextile apparent opening size (AOS)	70 US Sieve (.212mm)	ASTM D4751
Geotextile weight (typical)	4.0 co-yd ² (135 g/m ²)	ASTM D5261
Geotextile UV resistance	70% strength retained	ASTM D4355
Usability		
Roll size/weight	Non-toxic, non-volatile 7'4" x 50' (1.2 x 15.25m) 38 lbs. (15.87kg) 16.5' or 8' widths available at special order	
Service life expectancy	>25 years (at 60% relative humidity and temperature below 77°F / 25°C) (No wet exposure to UV light for more than 30 days)	

www.Mar-flex.com 1-800-498-1411

4. Kemperol Waterproofing



Product Information

KEMPEROL® 2K-PUR

Work pack includes:

Component A: Cream Formulation, Component B: Dark Brown Formulation

Product Description

KEMPEROL® 2K-PUR is a two-component, UV-stable, "odor-free," solvent free, Low VOC, high performance cold liquid-applied waterproofing and roofing resin.

KEMPEROL® 2K-PUR reinforced membrane system can be surfaced with traffic coatings, reflective coatings, aggregate surfacing coatings and other granular materials to achieve a desired function and appearance.

Composition & Materials

A monolithic membrane is created in the field by combining the KEMPEROL® 2K-PUR two-part, cold liquid-applied reactive-cure polyurethane resin with KEMPEROL® polyester reinforcing fleece. Membrane may be applied using standard fleece available in 4, 8, 10, 13, 20, 27, and 41-inch nominal widths.

Use

KEMPEROL® 2K-PUR membrane is suitable for a wide range of interior and exterior applications including roofs, plazas, planters, foundations, mechanical rooms and other waterproofing applications.

Limitations

Interior or exterior applications of KEMPEROL® 2K-PUR membrane exposed to UV-light may yellow or discolor. Use of a coating or aggregate surfacing systems are recommended where color-fast applications are required.

KEMPEROL® 2K-PUR may be applied when the ambient temperature is 41 °F (5 °C) and rising, and the substrate temperature is a minimum of 5 degrees above the dew point. The maximum application temperature is approximately 90 °F (32 °C).

Note: Viscosity increases with falling temperature. For temperatures below 50 °F (10 °C), KEMPEROL® A 2K-PUR Accelerator should be added to component A to reduce set time.

Yield

Using 165 Fleece: 38 ft² (3.53 m²) per 12.5 kg work pack.
Using 120 Fleece: 45 ft² (4.20 m²) per 12.5 kg workpack.

Note: All yields are approximate and may vary depending upon smoothness and absorbcency of substrate.

Storage

Always store in cool and dry location. Do not store in direct sunlight or in temperatures below 35 °F (1.7 °C) or above 80 °F (27 °C). Approximate shelf life 12 months with proper storage.

For best use, 24 hours before application, the material is to be acclimated at temperatures between 65-70 °F (18-21 °C).

Precautions

Review Safety Data Sheets before handling, available online at kempersystem.net.

Surface Preparation

All surfaces must be free from gross irregularities, loose, unsound or foreign material such as dirt, ice, snow, water, grease, oil, release agents, lacquers, or any other condition that would be detrimental to adhesion of the primer and membrane. This requires careful preparation of existing horizontal and vertical substrates; cracks are filled, expansion joints are prepared, flashings are removed or modified, and termination points are determined. Substrates and penetrations are prepared to rigorous industry standards, and may require scarifying, sandblasting or grinding in some cases to achieve a suitable substrate.

Mixing of Resin

Sustainability Information	
Rapidly Renewable Resource	80%
Recycled Content % (post / pre)	0 / 0
Manufacture Location	Buffalo, NY, USA

Allow primer to cure completely prior to application of the KEMPEROL® membrane.

Note: Prior to opening the containers of KEMPEROL® 2K-PUR Resin, wear appropriate safety glasses and protect hands and wrists by wearing gauntlet-type neoprene gloves.

Step 1: Mix resin Component A (cream formulation) with a spiral agitator until the liquid is a uniform cream color.

Step 2: If the ambient temperature is below 50°F (10°C), A2K-PUR Accelerator, a cold weather additive, should be mixed into the Component A. The accelerator should be mixed with the spiral agitator for 2 minutes or until both liquids are thoroughly blended.

Step 3: Add hardener Component B (dark brown formulation) to Component A and mix with a spiral agitator for 2 minutes or until both liquids are thoroughly blended.

NOTE: DO NOT break down workpaks into smaller quantities – mix the entire workpak.

Application (165 Fleece)

Step 1: After the Resin is mixed, using a Kemperol roller nap or brush apply 2/3 of the resin liberally and evenly onto the surface in even stroke. Covering one working area at a time, between 10 - 15 ft².

Step 2: Roll the Kemperol Fleece directly into the Resin, making sure the SMOOTH SIDE IS FACING UP (natural unrolling procedure), avoiding folds and wrinkles. Use the roller or brush to work the resin into the fleece, saturating from the bottom up. The appearance of the fleece should be light opaque yellow/gray with no white spots. White spots are indications of unsaturated fleece or lack of adhesion. It is important to correct these areas before proceeding.

Step 2: Roll the Kemperol Fleece directly into the Resin, making sure the SMOOTH SIDE IS FACING UP (natural unrolling procedure), avoiding folds and wrinkles. Use the roller or brush to work the resin into the fleece, saturating from the bottom up. White spots are indications of unsaturated fleece or lack of adhesion. It is important to correct these areas before proceeding.

Surfacing

KEMPEROL® 2K-PUR Membrane accepts a wide variety of KEMPERDUR® topcoats and aggregate surfacings for aesthetic or mechanical wear. The KEMPEROL® 2K-PUR membrane must be surfaced within 16-48 hours of membrane application to ensure proper bond between the membrane and surfacing. After the 48 hour window the membrane will require surface abrasion.

Disposal

Cured 2K-PUR resin may be disposed of in standard landfills. This is accomplished by thoroughly mixing all components. Note: Uncured 2K-PUR resin is considered a hazardous material and must be handled as such, in accordance with local, state and federal regulations. Do not throw uncured resin away.

Membrane Properties		
Physical Property	Test Method	Value
Color		Yellow-Gray
Physical State		Cures to Solid
Thickness (165 Fleece)		80 mils
VOC Content		6 g/l
Peak Load @ 73 °F, avg.	D5147	>70 lbf/in
Elongation	D5147	Min 30%
Tearing Strength	D5147	90 lbf
Puncture resistance	D5602	56 lbs.
Dimensional stability	D1204	0.15%
Water absorption	D570	>1%
Impact Resistance	D2240	Shore A:75
Water vapor transmission	E96	0.08 Perms
Crack spanning		2 mm/0.08 inch
Short-term temperature resistance		250 °C/482 °F
Usage time*		30 minutes
Water resistant after*		2 hours
Solid to walk on after*		24 hours
Can be driven on after*		48 hours
Apply coating/surfacing after*		16-48 hours
Apply overburden after*		48 hours
Completely hardened*		3 days

* values obtained at 72°F, 50% relative humidity; may vary depending upon air flow, humidity and temperature.

5. Kempertec AC Primer



Product Information

KEMPERTEC® AC Primer

Work pack includes:

Component A: Base Resin, Component B: Catalyst Powder

Product Description	KEMPERTEC® AC PRIMER is a quick-curing, high bonding Polymethyl Methacrylate (PMMA) primer used between acceptable prepared substrates and KEMPEROL® cold liquid-applied reinforced membrane and coating systems.
Composition & Materials	KEMPERTEC® AC Primer is a 2-part, cold liquid-applied Polymethyl Methacrylate resin consisting of Component A (resin), and Component B (catalyst powder).
Use	KEMPERTEC® AC Primer is used to prime a variety of substrates. Please check the current Substrate Primer Selection Table for a complete list of approved substrates.
Limitations	<p>Kemperol AC Primer may be applied when the ambient temperature is between 35°F (2°C) and rising. The substrate temperature must be a minimum of 5 degrees above the dew point. Kemperol membrane must be applied to primer within 48 hours of primer application. Primer exposed for more than 48 hours must be re-primed.</p> <p>Provide and maintain positive airflow over freshly applied KEMPEROL® AC materials during entire curing period to facilitate complete cure. Natural airflow is typically sufficient for exterior applications, but locations such as beneath large mechanical units, at inside corners, at the base of high walls, and other similar areas where stagnant air may occur should be provided with powered fans.</p>
Yield	<p>125 ft² (11.6 m²) per 5 kg work pack.</p> <p><i>Note: All yields are approximate and may vary depending upon smoothness and absorbency of substrate.</i></p>
Storage	<p>Always store in cool and dry location. Do not store in direct sunlight or in temperatures below 35°F (1.7°C) or above 80°F (27°C). Approximate shelf life 12 months with proper storage. Catalyst Powder must be stored separately.</p> <p>For best use, 24 hours before application, the material is to be acclimated at temperatures between 65-70°F (18-21°C).</p>
Precautions	Review Safety Data Sheets before handling, available online at kempersystem.net.

Step 2: Add the Catalyst Powder, Component B, to Component A and mix with the same agitator for 2 minutes or until the powder is completely mixed throughout the liquid resin. The amount of Catalyst Powder must be adjusted according to the ambient temperature (see table).

NOTE: *Kempertec® AC Primer is extremely fast curing. Excessive mixing time reduces the available working time for the Primer.*

Catalyst Powder Requirements

Material Temperature °F	Kemperol Catalyst Powder (100g/bag)	Pot Life (min)	Completely Cured
35°F - 50°F	2 bags	20	45
50°F - 65°F	2 bags	20	30
65°F - 85°F	1 bag	15	30
>85°F	1/2 bag	10	15

Sustainability Information	
Rapidly Renewable Resource	0%
Recycled Content % (post / pre)	0 / 0
Manufacture Location	Italy / Germany

Primer Properties	
Physical Property	Value
Color	Transparent
Physical State	Cures to solid
VOC Contents	62 g/l
Usage Time*	15 minutes
Water Resistant After*	30 minutes
Cures After*	30 minutes
Apply Membrane/Coating After*	30 minutes

* values obtained at 73°F, 50% relative humidity, may vary depending upon air flow, humidity and temperature.

Application

After mixing, apply the primer with a roller or brush evenly onto the surface in a cross directional method, or utilizing the pour and spread method to fully cover the substrate. Porous substrates may require an adjustment to the primer application rate or multiple coats to achieve proper pore saturation.

Note: Kemperol membrane may be applied when the primer is completely dry and without tack. Do not apply Kemperol membrane to tacky or wet primer.

Disposal

Cured KEMPERTEC® AC Primer may be disposed of in standard landfills. This is accomplished by thoroughly mixing all components. Note: Uncured KEMPERTEC® AC Primer resin and hardener are considered hazardous materials and must be handled as such, in accordance with local, state and federal regulations. Do not throw uncured resin or hardener away.

ISOGARD™ HD Cover Board

[Home](#) » [Roofing Systems](#) » [Roofing Insulation](#) » [Cover Boards](#) » ISOGARD™ HD Cover Board

ISOGARD™ HD Cover Board

The Best Added Measure of Protection for Any Roof

Firestone Building Products ISOGARD™ HD Cover Board is the next generation in high density cover board that combines impact resistance, energy savings and ease of installation in a single durable product.



Features and Benefits

- Extremely lightweight.
- 12 fasteners per 4'x8' sheet.
- 2.5 R-Value per ½" of thickness.
- At only 12 lbs. per 4'x8' sheet, this product can offer savings from reduced transportation costs, labor and material during application.
- When compared to competitors' standard HD board, our product saves 15-25% in fastener costs.

Application

- Commercial Roofing



FIRESTONE ISOGARD™ HD COVER BOARD

AN ADDED MEASURE OF PROTECTION

Cover boards can add strength and protection to a roofing system, enhancing the system's long-term performance. Firestone ISOGARD HD Cover Board is a high compressive strength, ultra-lightweight, easy to install polyisocyanurate board that provides superior impact resistance and durability, while boosting the energy-saving value of the roofing system.



FEATURES & BENEFITS

- 1/2" thickness, with high-density core
- Closed-cell polyisocyanurate (*polyiso*) core made with ISOGARD™ foam technology
- Superior wind-uplift performance (see below)
- Manufactured with a coated fiberglass facer
- Incorporates blowing agent that contains no hydrochlorofluorocarbons (*zero ozone depletion potential*)
- Mold-resistant material per ASTM D3273
- Provides an industry leading R-value of 2.5 for valuable energy savings
- Easy to cut and lightweight, reducing installation time and labor costs
- Firestone requires I-90 wind-uplift performance at 12 fasteners per board where our competition requires 16 fasteners per board
- Approved for a Severe Hail Rating by Factory Mutual (FM) Global
- Contains recycled content

TOUGH, LIGHTWEIGHT CONTENDER

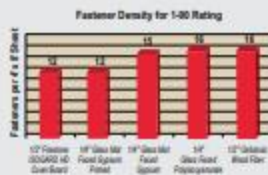

Excellent wind uplift performance means Firestone ISOGARD HD Cover Board requires fewer fasteners than other comparable cover boards.

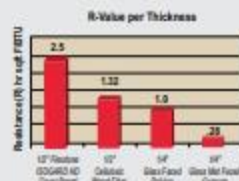

In terms of energy efficiency, easy handling and other important advantages, Firestone ISOGARD HD Cover Board is the clear winner when matched against other leading cover boards.

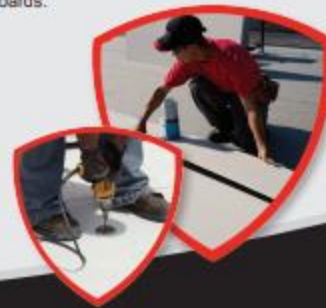

TECHNICAL INFORMATION SHEET



I.S.O. Twin Pack™ Adhesive

Packaging

Property	Value
Kit Contents:	I.S.O. Twin Pack Insulation Adhesive is packaged as a kit consisting of one 750 ml Part A cartridge fastened together with one 750 ml Part B cartridge.
Each Case Contains:	4 Part A – Part B Kits, 4 Static Mixers, Instruction Sheet
Weight of Case:	20 lb (9 kg)
Number per Pallet:	48
<p>NOTE: Coverage rates of each I.S.O. Twin Pack kit, when properly mixed, dispenses 150' (45.7 m) of mixed adhesive in a bead ½" (12.7 mm) wide. This bead will rise ¾" - 1" (19.0 mm – 25.4 mm). This equates to a coverage area of 600 ft² (55.74 m²) per carton when installed in beads 12" (304.8 mm) on center (typical spacing).</p> <p>NOTE: Coverage rate may be reduced due to irregularities in substrates.</p>	

Beads Dispensed at - Coverage per Carton

4" o.c. (102 mm)	200 ft² (27.87 m²)
6" o.c. (152 mm)	300 ft² (18.58 m²)

Typical Set Up Times

At 60 °F (16 °C) to 90 °F (32 °C):	5-8 minutes
At 20 °F (-7 °C) to 60 °F (16 °C):	8-15 minutes

Typical Properties

Property	Minimum Performance
Color: Part A	Amber
Color: Part B	Off-White
Composition Part A	Isocyanate pre-polymer
Composition Part B	Polyol
Mix Ratio of A:B	1:1 by volume
Specific Gravity Part A	1.18 + 0.06
Specific Gravity Part B	1.02 + 0.05
Viscosity Part A/Part B	3,000-24,000 cps, #52 spindle at 5 RPM, 77 °F (25 °C)
V.O.C. Content:	0 fl. (0 lb/gal)

TECHNICAL INFORMATION SHEET



I.S.O. Twin Pack™ Adhesive

Acceptable Substrates	
Property	Notes
Structural Concrete (New)	New poured decks must have a minimum 28 day cure time
Structural Concrete (Existing)	Positive adhesion test required
Steel	New steel decks may require cleaning to remove processing oils
Gypsum Decks	Positive adhesion test required
Cementitious Woodfiber	
Modified Bitumen Roofs	
Plywood and OSB	
SBS Base Sheets	
V-Force Membrane	Positive adhesion test required
Lightweight Concrete	Acceptable Lightweight concrete substrates include cellular or air-entrained concrete.
Existing Asphalt and Modified Bitumen Roofs (mineral or Smooth Surfaced)	Existing substrates containing residual asphalt must be cleaned and scraped smooth as possible.
Coal Tar Pitch	Positive adhesion test required. Primer may be required.
Insulation ISO95+™ GL HD, RESISTA™, FiberTop™ Woodfiber, Dens-Deck® Product, Expanded Polystyrene, Extruded Polystyrene	Non-Firestone brand insulations require a positive adhesion test.
NOT ACCEPTABLE :	Single Ply membrane, Fiberglass insulation, Perlite insulation
NOTE: Dens-Deck is a registered Trademark of Georgia-Pacific.	

Necessary Equipment:

The following equipment is necessary to dispense I.S.O. Twin Pack Insulation Adhesive:

- **Static Mixer:** Supplied with I.S.O. Twin Packs. Static mixer tubes are bolted onto the plugged end of kit after plugs removed. As Part A and B are simultaneously extruded through the tube, the static mixer properly and thoroughly mixes Part A and Part B. The tip at the end of the static mixer (opposite bolt end) dispenses mixed I.S.O. Twin Pack Insulation Adhesive in a 1/2" (12.7 mm) wide bead.
- **I.S.O. Twin Pack 4 Bead (Firestone Item No. W56RACINT4) and 13 Bead MBA+ Multi Bead Dispenser (sold separately):** Cart and wheel mounted, hand maneuverable, with battery driven plungers, these dispensers mix and dispense multiple beads of I.S.O. Twin Pack Insulation Adhesive simultaneously from 12" (304.8 mm) on center all the way up to full coverage on open, unobstructed roof areas. Pre-marked cartridge slots provide consistent application for desired bead spacing of the I.S.O. Twin Pack.
- **I.S.O. Twin Pack Single Bead Hand Dispenser (Firestone Item No. W56RACINTG); Battery Powered Single Bead Applicator and Pneumatic Single Bead Applicator (sold separately):** Mixes and dispenses one bead of I.S.O. Twin Pack Insulation Adhesive and are necessary for dispensing I.S.O. Twin Pack Insulation Adhesive on roof areas where Multi Bead Dispensers cannot be maneuvered.

The POWER of POLYISO

High performance – cost efficient polyiso delivers the **highest R-value per inch in cold temperatures** making it the smartest investment you can make when insulating your building. At low temperatures competing polyiso boards require additional thickness to achieve the same R-value of Firestones polyiso.



Product Benefits

- Highest R-value per inch in cold temperatures.
 - Thermal resistance outperforms industry standard by up to 18%.
 - A 500,000 square-foot roof can get a cost savings of up to 40k.
- Requires less embodied energy to manufacture than mineral wool
 - From raw material to product and transportation, polyiso requires 85% less energy to manufacture than mineral wool.
 - Mineral wool requires twice as many boards as polyiso and is 4.5 times heavier.
 - Polyiso can also be recycled and reused on roofing applications, where mineral wool cannot.
- Does not require thermal barrier because it acts as one (per IECC 2012 ASHRAE 90.1).
- Excellent compressive strength allows polyiso to stand up to foot traffic from routine maintenance.

TECHNICAL INFORMATION SHEET



ISO 95+™ GL Insulation

Item Description

Flat and Tapered Polyiso Boards

<u>Flat Boards:</u>	4' x 4' (1.22 m x 1.22 m)
	4' x 8' (1.22 m x 2.44 m)
<u>Tapered Boards:</u>	4' x 4' (1.22 m x 1.22 m)
<u>Slope range:</u>	1/16" per foot (.5%) to 1/2" per foot (4%)
<u>Thickness range:</u>	0.5" (12.7 mm) to 4.5" (114.3 mm)

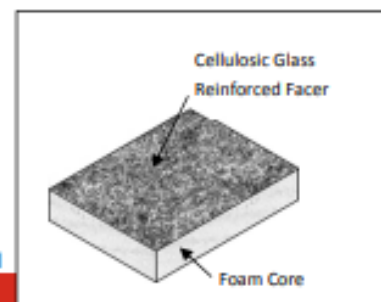

Meets or exceeds performance requirements of ASTM C 1289, Type II, Class 1

Product Information

Description:

Firestone ISO 95+ GL flat and tapered roof insulation consists of a closed-cell polyiso foam core laminated to a black glass reinforced mat facer on both major surfaces. Flat and tapered ISO 95+ GL insulation provides outstanding thermal performance on commercial roofing applications, while providing positive rooftop drainage to help eliminate ponding water when tapered ISO 95+ GL insulation is used.

All Firestone polyisocyanurate insulations use EPA accepted blowing agents. Firestone ISO 95+ GL incorporates a HCFC-free blowing agent that does not contribute to the depletion of the ozone layer (ODP-free).

Method of Application:

- Insulation shall be neatly fitted to all roof penetrations, projections and nailers.
 - No more insulation shall be installed than can be covered with membrane and completed before the end of each day's work or before the onset of inclement weather.
 - Firestone ISO 95+ GL board may be installed using:
 - Firestone fasteners and plates
- NOTE:** For ballasted systems, the top layer of Firestone insulation may not be mechanically attached.
- Hot asphalt (requires a cover board)
 - Firestone approved insulation adhesives
 - I.S.O. Twin Pack™
 - I.S.O. Stick™
 - I.S.O. Spray™ R
 - I.S.O. FIX™ II

Acceptable Immediate Substrates:

- 3,000 psi Structural concrete (must be clean, dry, and properly cured)
- Steel deck (min 22 ga)
- Plywood and OSB (min 1/2")
- Lightweight concrete
- Gypsum deck (min 2")

NOTE: Please consult the Design Guides and QuickSpecs online at www.firestonebpco.com to review specific information regarding the assembly.

Storage:

- Keep insulation dry at all times
- Elevate insulation above the deck or ground
- Cover insulation with waterproof tarps

TECHNICAL INFORMATION SHEET

Firestone
BUILDING PRODUCTS

ISO 95+™ GL Insulation

Precautions:

- Polyiso foam will burn if exposed to a flame of sufficient heat and intensity. Keep away from heat, sparks, and open flames.
- Protect against dust that may be generated during installation.
- Refer to Safety Data Sheet (SDS) for additional information.
- Take care when transporting and handling Firestone insulation to avoid physical damage.

Specification Compliance:

ASTM C1289, Type II, Class 1
UL Classified-UL1256
FM Class 1 Approved
Manufactured in an ISO 9001 Registered Facility
CAN/ULC-S704, Type 1, Class 3



CMC 13274-L

LEED® Information:

See Recycled Content in table below.

Manufacturing Locations: Florence, KY Corsicana, TX Bristol, Ct
De Forest, WI Salt Lake City, UT Youngwood, PA
Jacksonville, FL

NOTE: Miami Dade Classified polyiso is only produced in the Jacksonville, FL and Youngwood, PA facilities.

Typical Properties (Meets ASTM C 1289, Type II, Class 1)

Property	ASTM Test Method	Firestone Typical Performance
Compressive Strength:	D1621	Grade 2: 20 psi (138 kPa)
		Grade 3: 25 psi (172 kPa) *
Density:	D1622	2 pcf (32 kg/m ³)
Dimensional Stability:	D2126	<2%
Moisture Vapor Transmission:	E96	<1 perm (<57.5 ng/(Pa·s·m ²))
Water Absorption:	C209	<1% by volume
Service Temperature:	----	-100 to 250 °F (-73 to 121 °C)
Flame Spread:	E84	Index 50
Smoke Development:	E84	Index 160 - 180

*25 psi (172 kPa) available upon request.

TECHNICAL INFORMATION SHEET



ISO 95+™ GL Insulation

Product Information

Thickness*		(R-Value) **	Max Flute Span		Approx. Recycled Content		
Inches	mm		Inches	mm	Post Consumer	Post Industrial	Total
0.5	12.70	2.9	1.50	38.10	52%	15%	67%
1.0	25.40	5.7	2.62	66.67	37%	15%	52%
1.1	27.94	6.3	2.62	66.67	36%	15%	51%
1.2	30.48	6.8	2.62	66.67	34%	15%	49%
1.3	33.02	7.4	3.67	93.34	32%	15%	47%
1.4	35.56	8.0	3.67	93.34	30%	15%	45%
1.5	38.10	8.6	4.37	111.12	29%	15%	44%
1.6	40.64	9.1	4.37	111.12	27%	15%	42%
1.7	43.18	9.7	4.37	111.12	26%	15%	41%
1.75	44.45	10.0	4.37	111.12	26%	15%	41%
1.8	45.72	10.3	4.37	111.12	25%	15%	40%
1.9	48.26	10.8	4.37	111.12	24%	15%	39%
2.0	50.80	11.4	4.37	111.12	24%	15%	39%
2.1	53.34	12.0	4.37	111.12	22%	15%	37%
2.2	55.88	12.6	4.37	111.12	21%	15%	36%
2.25	57.15	12.9	4.37	111.12	21%	15%	36%
2.3	58.42	13.2	4.37	111.12	21%	15%	36%
2.4	60.96	13.8	4.37	111.12	20%	15%	35%
2.5	63.50	14.4	4.37	111.12	20%	15%	35%
2.6	66.04	15.0	4.37	111.12	19%	15%	34%
2.7	68.58	15.6	4.37	111.12	18%	15%	33%
2.75	69.85	15.9	4.37	111.12	18%	15%	33%
2.8	71.12	16.2	4.37	111.12	18%	15%	33%
2.9	73.66	16.8	4.37	111.12	17%	15%	32%
3.0	76.20	17.4	4.37	111.12	17%	15%	32%
3.1	78.74	18.0	4.37	111.12	16%	15%	31%
3.2	81.28	18.6	4.37	111.12	16%	15%	31%
3.25	82.55	18.9	4.37	111.12	16%	15%	31%
3.3	83.82	19.2	4.37	111.12	16%	15%	31%
3.4	86.36	19.9	4.37	111.12	15%	15%	30%
3.5	88.90	20.5	4.37	111.12	15%	15%	30%
3.6	91.44	21.1	4.37	111.12	14%	15%	29%
3.7	93.98	21.7	4.37	111.12	14%	15%	29%
3.75	95.25	22.0	4.37	111.12	14%	15%	29%
3.8	96.52	22.3	4.37	111.12	14%	15%	29%
3.9	99.06	23.0	4.37	111.12	14%	15%	29%
4.0	101.60	23.6	4.50	114.30	14%	15%	29%
4.1	104.14	24.2	4.50	114.30	13%	15%	28%
4.2	1.6.58	24.9	4.50	114.30	13%	15%	28%
4.25	107.95	25.2	4.50	114.30	13%	15%	28%
4.3	109.22	25.5	4.50	114.30	13%	15%	28%
4.4	111.76	26.1	4.50	114.30	13%	15%	28%
4.5	114.3	26.8	4.50	114.30	13%	15%	28%

*Other thicknesses available upon request.

**R- values provide a 15-year time-weighted average in accordance with CAN/ULC-S770.

Appendix K – Building B Weight of New Roof Calculation

<i>New Deck Layers</i>	<i>Area of Roof ft²</i>	<i>Given Information</i>	<i>Area per unit ft²</i>	<i>Total Amount for roof area</i>	
Pavers	5040	20"x20" sized pavers at 21lb/ft ²	2.78	1814.4	pavers
Pedestals	5040			2013.6*	pedestals
Drainage Mat	5040	38lbs per 4'x50' roll	200	25.2	rolls
Kemperol Waterproofing	5040	12.5kg (27.56lbs) per 38ft ²	38	132.6	work packs
Kempertec AC Primer	5040	5 kg (11.023lbs) per 125ft ²	125	40.32	work packs
Coverboard	5040	12lbs per 4'by8' sheet	32	157.5	sheets
Urethane Adhesive	5040	600ft ² per case and 20 lb per case	600	8.4	cases
Rigid Insulation	5040	1.77lb/ft ² (Two 2.5" board sized 16ft ²)	16	630	boards

*(Roof Area/Paver area) + (Perimeter of roof/Length of paver) was used to estimate the amount of pedestals needed as given in the product data sheets for the tile tech pavers in Appendix J.

<i>New Deck Layers</i>	<i>Weight per unit lbs</i>	<i>Total Weight lbs</i>	<i>Total unit weight per Roof Area lbs/ft²</i>
Pavers	58	105840	21
Pedestals	3	6040.80	1.20
Drainage Mat	38	957.60	0.19
Kemperol Waterproofing	27.55778	3655.03	0.73
Kempertec AC Primer	11.0231	444.45	0.09
Coverboard	12	1890.00	0.38
Urethane Adhesive	20	168.00	0.03
Rigid Insulation	28.32	17841.60	3.54
Total		136837	27