

# DEVELOPMENT OF MULTI-MODAL CONTROL INTERFACES FOR A SEMI-AUTONOMOUS WHEELCHAIR



Major Qualifying Project Report

Submitted to the Faculty of

WORCESTER POLYTECHNIC INSTITUTE

In partial fulfillment of the requirements for

The Degree of

Bachelor of Science

by

Gilmar Bento Da Vitória Jr (RBE)

Runzi Gao (RBE)

Ran Li (ECE)

Date: 1/29/ 2014

Submitted to

Prof. Taskin Padir, Advisor

Dmitry Sinyukov, Co-advisor

WPI routinely publishes these reports on its website without editorial or peer review.

## ABSTRACT:

The purpose of the project is to assist people with different levels of disabilities to control a semi-autonomous wheelchair. A semi-autonomous wheelchair developed by Robotics and Intelligent Vehicles Research Laboratory (RIVeR Lab) is able to perform assistive control to avoid obstacles and cliffs and to follow walls. With a joystick control adapter, the basic joystick of the wheelchair can take commands directly from computers. In addition to joystick mechanical adapter control, human-machine interaction and control methods such as voice and electromyography (EMG) are deployed, with the aim of enabling people with different levels and types of disabilities to control the wheelchair. These non-physical motion based user control interfaces allow people with limited mobility to control the wheelchair with a desired accuracy.

## ACKNOWLEDGEMENTS

We would like to express our very great appreciation to our adviser Professor Taskin Padir and graduate advisor Dmitry Sinyukov for their patience, engagement and advise to the development of the project.

We would also like to extend out thanks to the following organizations and institutions for their generous supports.

- National Science Foundation

For their sponsorship of the project.

- Northeastern University

For providing material storage for the project.

- Worcester Polytechnic Institute

For the use of their laboratories and manufacturing facilities and all members of the Robotics Engineering department who supported our project through their efforts and advice.

## Contents

ABSTRACT:	2
ACKNOWLEDGEMENTS	3
1. Introduction	7
2. Background	8
2.1. Alternative Methods of Wheelchair Control	8
2.2. Ongoing Research	11
2.3. Previous Project Work	12
2.4. User Control Technology and Application	14
2.5. Social Impact	17
3. Goals	19
3.1. Improve Previous Project	19
3.2. Implement Multiple Interfaces	22
4. Design	24
4.1. Improvements on the Project	24
4.2. Control Interfaces	35
5. Results and Analysis	44
5.1. Voice Control:	44
5.2. EMG Control:	47
5.3. Control Interface Software Architecture.	53
5.4. Back Rack	54
5.5. Casings	55
5.6. Joystick Interface	57
5.7. Multiple User Interfaces Wheelchair Test	58
6. Discussion	60
6.1. Improving the Accuracy of Speech Recognition	60
6.2. EMG Control Accuracy Discussion	61
6.3. Future Work	63
7. Conclusion	64
References	65
Appendices	67
Appendix A: Technical Documentation	67

## List of Figures:

Figure 1: Sip-and-Puff system in use [8] .....	9
Figure 2: Eye and Gaze Drive system [9] .....	10
Figure 3: Georgia Tech Assistant Professor Maysam Ghovanloo and Jason DiSanto showing the tongue drive system [4] .....	10
Figure 4: Alpha prototype Headrest .....	13
Figure 5: IR sensor trapped inside of assemble casing .....	13
Figure 6: Electrical model for EMG .....	16
Figure 7: BCI devices available: mindwave mobile [19], Ibrain [20], EPOC Emotiv [21] .....	17
Figure 8: Original position of LIDAR .....	19
Figure 9: Ultrasonic sensors interferes with each other .....	24
Figure 10: Sensor layout to minimize the effect of interfering .....	25
Figure 11: Distance conversion .....	26
Figure 12: Geometry analysis for a random sensor scan .....	27
Figure 13: Alternative laser scan .....	30
Figure 14: Wheelchair path from recorded rosbag file .....	31
Figure 15: Bottom mounting point .....	32
Figure 16: SolidWorks rendering of Back Rack .....	33
Figure 17: Ultrasonic sensor with top knocked off .....	34
Figure 18: Original sensor board casing, Left demonstrating no exit specifically for power wire, Middle demonstrating the miss aligned screw hole, Right proposed new casing model .....	34
Figure 19: Motor controller board, Left components and ports, Middle heat sink plate, Right proposed design for casing .....	35
Figure 20: Voice Control system diagram .....	36
Figure 21: The microphone and receiver units .....	38
Figure 22: The Logitech UE Mobile Boombox .....	39
Figure 23: The speaker mounted on the back rack .....	40
Figure 24: Hardware setup among headset, computer and wheelchair .....	41
Figure 25: Software flow chart of EPOC Emotiv control mode .....	42
Figure 26: SolidWorks rendering of Joystick System .....	43
Figure 27: Voice commands .....	44
Figure 28: Testing voice commands with fake turtlebot in the simulator .....	46
Figure 29: An example of expressive SDK application .....	47
Figure 30: Expression accuracy for individual .....	49
Figure 31: Expression accuracy experiment .....	49
Figure 32: An example of cognitive control SDK application .....	50
Figure 33: Bar chart of the cognitive mode control experiment results .....	51
Figure 34: An example of affective control SDK application .....	52
Figure 35: Control interface software architecture design .....	53
Figure 36: Back Rack with mounted components .....	54
Figure 37: Left- old version of IR sensor casing, Right – new version of IR sensor casing .....	55

Figure 38: Disassemble ultrasonic sensor casing with “UP” label on bottom plate .....	56
Figure 39: Sensor board casing with labeled wires .....	56
Figure 40: Motor controller casing mounted on wheelchair.....	57
Figure 41: Joystick manipulator.....	58
Figure 42: EMG control going forward .....	59
Figure 43: EMG control turning left.....	59
Figure 44: Voice control going forward .....	59
Figure 45: Voice control turning left .....	59
Figure 46: A good head sensor signal strength.....	61
Figure 47: Pre-run Test .....	62
Figure 48: Component of EPOC Emotiv [27] .....	67
Figure 49: Motor driver case.....	69
Figure 50: Sensor board case .....	70
Figure 51: IR sensor case.....	70
Figure 52: Ultrasonic range sensor case .....	71

## List of Tables:

Table 1: The mapping from keywords or phrases to commands .....	37
Table 2: Control mode comparison.....	41
Table 3: Voice command tests.....	46
Table 4: Expression accuracy experiment on 4 subjects .....	48
Table 5: The cognitive mode control experiment results.....	51
Table 6: Usabilities comparison of three control methods using EPOC Emotiv.....	53
Table 7: Different colors indicate different signal strength.....	61

## 1. Introduction

Different disability levels requires different assistive user control interfaces. Some of assistive interfaces can provide motion based command such as a joystick. However, such interfaces are not able to adapt to different control requirements. A conventional wheelchair requires the mobility of the upper body. In many cases, this cannot help people who are paralyzed. Technologies like voice recognition provides a solution for people to communicate with computers which can then be used to send out the operation commands for the users. Furthermore, to help people with other types of disabilities with even less control of their bodies, electroencephalogram (EEG) and electromyogram (EMG) controls are considered good approaches. With brain signal processing devices getting more and more commercialized, reading brain signals are no longer restricted to research institutes. Products like EPOC Emotiv [1] and Mindwave [2] make it very easy to access the brain signals at a relatively high accuracy level. With these technologies, it is possible to develop a user control interface for the wheelchair to utilize the EEG and EMG signals for people who are suffering from disabilities like quadriplegia [3].

To increase the control abilities and personalize the control interfaces for different individuals' requirements, the current team decides to integrate the control interfaces into a wheelchair system. By merging multiple user control interfaces such as voice control and EMG control with traditional controls, adaptive wheelchair can help to assist more people who have different level of mobility impairment.

The report is organized in such manner: section 1 outlines the current problems of adapting to different type disabilities and our approach to integrate multiple interfaces into the control system; section 2 describes the technologies used in the project; section 3 specifies the requirements of the project, section 4 lists and explains the design processes; section 5 presents the results and analysis of the project. Section 6 extends the open discussion of the project and suggests some further steps for development. Section 7 summarizes the project achievements.

## 2. Background

This chapter presents the relevant research conducted to better understand the topics related to the successful completion of this project. Using the knowledge obtained for this research, the team was able to make more educated design decisions. Before attempting to improve the design of the smart wheelchair, or develop new methods for interfacing with the wheelchair, members of the previous team were consulted and research into existing methods of controlling powered wheelchairs for users unable to use their hands was conducted. These changes and improvements also stuck to the idea of keeping the system modular and working in a variety of wheelchairs. The knowledge obtained from this research guided the team in making sound design choices supported by facts.

This chapter presents the relevant research conducted to better understand the topics related to the successful completion of this project. Using the knowledge obtained for this research, the team was able to make more educated design decisions. Before attempting to improve the design of the smart wheelchair, or develop new methods for interfacing with the wheelchair, members of the previous team were consulted and research into existing methods of controlling powered wheelchairs for low mobility users. These changes and improvements also stuck to the idea of keeping the system modular and working in a variety of wheelchairs. The knowledge obtained from this research guided the team in making sound design choices supported by facts.

### 2.1. Alternative Methods of Wheelchair Control

Some wheelchair users are unable to, or have difficulty, using the standard joystick interface that come with most wheelchairs, such is the case for users suffering from Lock-In Syndrome (LIS), a condition where the person may be conscious and alert but is unable to communicate or interact with the world. Research in this field has seen a rise in the past decade to help victims of accidents who have been left without use of their arms and hands, or for those with degenerative disease such as Amyotrophic Lateral Sclerosis (ALS), as condition that leads to LIS [4] [5] [6]. These different methods of operation provide these users with much needed control of their locomotion, as is stressed by “A Literature Review of Smart Wheelchairs” [7].Some wheelchair uses are unable to, or have difficulty using the standard joystick interface that come with most wheelchairs, such is the case for people Lock-In Syndrome (LIS), a condition where the person maybe conscious and alert but is unable to communicate or interact with the world. Research in this field has seen a rise in the past decade to help victims of accidents who have been



left without use of their arms and hands, or for those with degenerative disease such as Amyotrophic Lateral Sclerosis (ALS), as condition that leads to LIS [4] [5] [6]. These different methods of operation provide these users with much needed control of their locomotion, as is stressed by “A Literature Review of Smart Wheelchairs” [7].

A more common solution is the sip-and-puff system (SNP). In this system the user either draws in air, or blows air into a wand or tube. This system requires calibration for each user, once calibrated it will only recognize the specific user’s sips and puffs. SNP recognizes four different commands, hard sip, soft sip, hard puff, and soft puff. Figure 1 shows the sip-and-puff system in use.



**FIGURE 1: SIP-AND-PUFF SYSTEM IN USE [8]**

By tracking the eyes for blinks and estimating gaze direction through a camera placed in front of the wheelchair users are able to operate an electric wheelchair. This system was adaptable to any powered wheelchair by placing a camera in front of the wheelchair to capture the image of the user. The camera is connected to a computer that uses image processing. To navigate the computer estimate their gaze direction using the triangle formed by the nose and the eyes, and the frequency of the blink for the duration of the time traveled. Figure 2 shows the physical system and some of the image processing occurring.



**FIGURE 2: EYE AND GAZE DRIVE SYSTEM [9]**

A different and newer ideal is the Tongue Drive System (TDS) developed by the team at Georgia Tech. This system uses two magnetic sensors placed on side of the users head and magnetic tongue barbell [4]. By placing the magnetic barbell inside specific sports of their mouth users are able to control the direction and speed of the wheelchair with better results than similar systems for users without the use of their hands. Figure 3 shows the system in use.



**FIGURE 3: GEORGIA TECH ASSISTANT PROFESSOR MAYSAM GHOVANLOO AND JASON DiSANTO SHOWING THE TONGUE DRIVE SYSTEM [4]**

The MIT Intelligent Wheelchair Project is a successful example of implementing voice control technology in wheelchair. [6] Their voice-controlled wheelchair which would allow a user to be able to tell the wheelchair to go to a specific location, rather than control every twist and turn manually. The wheelchair was made available to patients at the Boston Home in Dorchester. [5] As it has been proven that voice control interface could benefit a big group of wheelchair users, we think it would be a good idea to develop voice control along with other control interfaces in our project.

There are many applications that are using electroencephalogram (EEG) and electromyogram (EMG) signals for control purposes. Many of them are related to the biomedical device development for helping people with disabilities. Several commercialized products are released into the market for users to build their own applications, such as Puzzlebox Brainstorms [10]. It is an open source software suite used for brain-computer interfaces. It uses the EPOC Emotiv EMG reading device to process the signal to control a wheelchair. The parts of this system [11] include an electric wheelchair, a laptop computer, an Arduino, an interface circuit, and an EEG headset. The EMG signal is sampled and processed by the EMG reading headset, then the analyzed signal is sent to the laptop, after which the Arduino board controls the motors of the wheelchair. There are many applications that are using electroencephalogram (EEG) and electromyogram (EMG) signal for control purposes. Many of them are related to the biomedical device development for helping people with disabilities. Several commercialized products are released into the market for user's to build their own application such as Puzzlebox Brainstorms [10]. It is an open source software suite used for brain-computer interfaces. It uses the EPOC Emotiv EMG reading device to process the signal to control a wheelchair. The parts of this system [11] include an electric wheelchair, a laptop computer, an Arduino, an interface circuit, an EEG headset. The EMG signal is sampled and processed by the EMG reading headset, then the analyzed signal is sent to the laptop, after which the Arduino board controls the motors of the wheelchair.

## 2.2. Ongoing Research

This project is an ongoing effort funded by the National Science Foundation to develop a semi-autonomous wheelchair to improve the condition of patients who are unable to or have issues using the joystick interface for the wheelchair. This project also include Northeastern University, their portion of the project includes working on the Brain Computer Interface (BCI). Two previous WPI teams have worked on expanding this project. The first creating much of the add-ons for the wheelchair, such as the Wheel-On-Wheel encoders, headrest mount, sensor

casings, and sensor board and its casing, developing the ROS framework for the project. The second team worked on improving the navigation, added ROS joystick support, and introduced the addition of an arm to the project. Some of the contributions by our team are directly related to these previous additions. This project is an ongoing effort funded by the National Science Foundation to develop a semi-autonomous wheelchair to improve the condition of patients who are unable to or have issues using the joystick interface for the wheelchair. This project also include Northeastern University, their portion of the project includes working on the Brain Computer Interface (BCI). Two previous WPI teams have worked on expanding this project. The first creating much of the add-ons for the wheelchair, creating the Wheel-On-Wheel encoders, headrest mount, sensor casings, and sensor board and its casings, developing the ROS framework for the project. The second team working on improving the navigation, added ROS joystick support, and introduced the addition of an arm to the project. Some of the contributions by our team are directly related to these previous additions and efforts of the Northeastern team.

### 2.3. Previous Project Work

A semi-autonomous wheelchair is provided by the ongoing research lab (Robotics and Intelligent Vehicles Research Laboratory). With the LIDAR device mounted on the wheelchair, the wheelchair can generate an environment map for navigation. Based on the map, the assistive control allows the wheelchair to navigate within indoor environments including avoiding obstacles and stair cliffs, and following walls. The following observations are made.

1. Sensors data sometimes is unreliable. Systematic errors are identified. Some Ultrasonic sensors need to be power cycled to get the correct reading. IR sensors should be mount vertically as instructed in the sensor user guide. The original design for the autonomous wheelchair placed the LIDAR at the right hand side of the wheelchair. This placement only allowed for limited use of the angular range of the LIDAR due to a large portion being blocked by the chair and user. The position and method of fastening the LIDAR also caused unexpected changes in its position, requiring time for sensor recalibration.
2. The previous team designed a headrest mount for fastening the Kinect sensor and other devices, shown in Figure 4. This headrest only used two points of contact at its base and due to the plastics flexibility it would become unstable move from its original position while the wheelchair was in operation.



**FIGURE 4: ALPHA PROTOTYPE HEADREST**

3. The first iteration of the sensor casings also suffered from some issues. They were designed to be assembled completely by gluing, trapping the sensor inside of the casing once assembled, this can be seen in Figure 5. The sensor board casing lacked a port for its power wire, the holes for the ports proved to be difficult to use, and bent the USB connector port.



**FIGURE 5: IR SENSOR TRAPPED INSIDE OF ASSEMBLE CASING**

## 2.4. User Control Technology and Application

This section outlines the background research. It introduces two types of technologies that will be used to implement different user interfaces: voice control and EMG control. With a joystick control interface, the team hopes to achieve a less invasive method of controlling the wheelchair. Two other control interfaces are also designed and implemented, namely voice control and EMG control. This section outlines the background research. It introduces two types of technologies that will be used to implement different user interfaces: voice control and EMG control. With a joystick control interface, people can operate the wheelchair very easily if they have control ability of their upper bodies. However this will not accommodate the requirements of other forms of disabilities, such as quadriplegia. So the current team design and implement two other control interfaces, voice control and EMG control.

### 2.2.2 Speech recognition and synthesis

Speech recognition and synthesis technologies have come a long way in the past few years, thanks to the ongoing research and development in Sphinx (speech recognition) and Festival (speech synthesis) projects. Together with the contribution from Carnegie Mellon University, which has brought us the version of Sphinx and Festival with easy to use APIs.

#### 2.2.2.1. CMU SPHINX AND POCKETSPHINX

CMUSphinx is a large vocabulary continuous speech recognizer developed by Carnegie Mellon University and released under BSD style license. It recognizes speech by taking the waveform, splitting it to utterance and recognizing each of them. The recognition takes place by matching all the possible combinations with the audio. [12] PocketSphinx is a version of Sphinx that works on Cross-platform: Linux, Windows, Mac OS X, iPhoneOS. It is the best option for our system running on Ubuntu and ROS.

#### 2.2.2.2. FESTIVAL TEXT-TO-SPEECH

The CMU Festival System is the contribution by Carnegie Mellon University to The Festival Speech Synthesis System, a general framework for building speech synthesis systems [13]. It comes with full text to speech functionalities, easy to use APIs, as well as variety of built in voices to choose from.

### 2.2.2.3. POCKETSPHINX PACKAGE

The pocketsphinx ROS package provides access to the CMU PocketSphinx speech recognizer. With Ubuntu gstreamer package installed, it will recognize incoming audio by splitting it into utterances. [14] The recognizer node matches the voice commands in the audio input stream to the words and phrases defined in the current vocabulary. It will publish a message on the /recognizer/output topic when a match is found. [15] The recognizer requires a language model and dictionary file as input. These can be automatically built from a corpus of sentences using the online CMU language model tool located at <http://www.speech.cs.cmu.edu/tools/lmtool-new.html>. The pocketsphinx ROS package provides access to the CMU PocketSphinx speech recognizer. With Ubuntu gstreamer package installed, it will recognize incoming audio by splitting it into utterances. [14] The recognizer node matches the voice commands in the audio input stream to the words and phrases defined in the current vocabulary. It will publishes a message on the /recognizer/output topic when a match is found. [15] The recognizer requires a language model and dictionary file as input. These can be automatically built from a corpus of sentences using the online CMU language model tool located at <http://www.speech.cs.cmu.edu/tools/lmtool-new.html>.

### 2.2.2.4. SOUND\_PLAY PACKAGE

Together with Festival text to speech, this ROS node provides service to transform a ROS message to physical sound that play out of the speaker. This is extremely helpful for building feedback in our voice control system, so our wheelchair can talk back to the user. [16]

## 2.2.2 EMG controls

Electromyography (EMG) is a technique widely used for many biomedical research projects. It records the electrical activities generated from skeletal muscles by detecting the electrical potential between two points on the skeletal muscle surface. The signals are captured for activation level and interpreted as certain behavior patterns of the muscles, such as contraction state or relaxation state.

### 2.2.2.1 BASIC PRINCIPLE

Figure 6 [17] shows the basic model for EMG technology. The electrical potential is measured between two electrodes above the skin. When a signal transfer in the sarkolemm, it

creates an electrical potential between the depolarized membrane areas. Because the signal is at millivolt level, a differential amplifier is used to make the original voltage differences more observable for analysis.

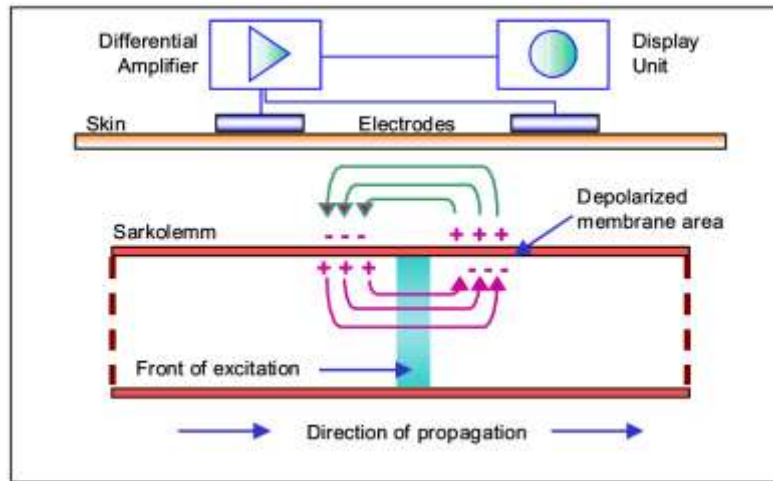

FIGURE 6: ELECTRICAL MODEL FOR EMG

EMG signals are used as a control signal in many places. For example, the Human Senses Group at the NASA Ames Research Center are using EMG directly for communication between a person and a computer. Many video games are also developing different controller based on EMG signals. EMG signals are used as a control signal in many places. For example, the Human Senses Group at the NASA Ames Research Center are using EMG directly for communication between a person and a computer [18]. Many video games are also developing different controller based on EMG signals.

In our project it is implemented as an operation interface for a conventional wheelchair to help people who might not have control of their limbs or voice.



### 2.2.1.2 AVAILABLE DEVICES:



FIGURE 7: BCI DEVICES AVAILABLE: MINDWAVE MOBILE [19], IBRAIN [20], EPOC EMOTIV [21]

There are several products in the market that have demonstrated the functionalities which are utilizing the EMG signals that are suitable for our projects as a control interface: Mindwave mobile, Ibrain, and EPOC Emotiv as shown in Figure 7.

Previous project used the EPOC Emotiv device as the BCI device. It provides a more commercialized headset, documentation and API available compare to the other two devices. So the current team decided to develop the BCI system with this device.

## 2.5.Social Impact

This section deals with how this project may affect society. The two most relevant topics include the changes for those requiring assistive technologies and the environmental impact by some of the team's material choices.

### 2.5.1. Assist the disabilities

People with disabilities have difficulty in performing certain tasks. Moving freely is one of the challenges in their daily lives. A powered wheelchair can assist them in such activities to an extent. However, a traditional powered wheelchair often requires the user's upper body mobility. This sets a barrier for those who lost control of their upper body or full body.

The current development made an effort to help the people with low mobility to control wheelchairs by non-motion based control interfaces such as voice control and EMG control. By implementing different control interfaces and testing their accuracies and reliabilities, the current team hopes to improve the quality of life for them through these control technologies.

### 2.5.2. Environmental Impact

The prototype casings and some mounting equipment was designed and created using acrylic and 3D printed plastic. Acrylic can be difficult to acquire, recycle, is fragile, and is a costly material. Like acrylic, 3D printed plastic can also be expensive, difficult to acquire, and fragile. In an attempt to improve those conditions a different material would be taken a look at.

In order to replace acrylic plywood was looked at. Plywood is more commonly available and cheaper, from hardware stores in the 6mm variety and from hobby shops in its 3mm variety and costing only a fraction of the cost of acrylic per square foot. Plywood is also more durable, it is less likely to crack and more flexible than acrylic. But the most significant part is that plywood is biodegradable and easily recyclable, acrylic being a class 7 recyclable plastic, meaning it is likely to not be recycled. And in order to replace the 3D printed plastic extruded aluminum was looked at. While also costly, aluminum is easier to acquire. One of the large benefits of aluminum over plastic is its strength, several times that of plastic. And most importantly aluminum is recyclable.

Plastic is a part of our everyday lives, the US alone produced 32 million tons of plastic in 2011, out of which only 8% was recycled [22]. Environmental pollution can ruin ecosystems, and understanding how our design choices impact them is our responsibility. With the proposed changes to the semi-autonomous wheelchair we look to lower the environmental impact caused by the production of our system.

### 3. Goals

The goal for the project has two sections including improving the previous implementation of the sensor and mechanical systems and the integration of multiple user interfaces. The specific requirements and functionalities for the development of the features are listed in the following section.

#### 3.1. Improve Previous Project

This section discusses the changes that were made to improve the previous teams design. This includes the method of mounting sensors, casing design for sensors, motor controller casings, sensor boards casings, and lowering the number of sensor boards used. This section discusses the changes that were made to improve the previous teams design. This includes the method of mounting sensors, casing design for sensors, motor controller, and sensor boards, and lowering the number of sensor boards used.

##### 3.1.1. Improving LIDAR Sensor Positioning

In the original design for the wheelchair the LIDAR was placed in a position that wasted a large portion of its range, shown in Figure 8, and was very susceptible to being misaligned due to collisions. In order to improve the LIDAR usage it is to be placed in location on the wheelchair that uses most, if not all of its range, and becomes less likely to be misaligned.



**FIGURE 8: ORIGINAL POSITION OF LIDAR**

A similar issue occurred when using the Kinect sensor and camera. Both were mounted in the headrest mount designed by the previous group. The head rest did not provide enough height, the camera and Kinect would detect the top of some user's heads. In order to improve this both the Kinect and camera are to be mounted in a place where they would no longer be interfered by the user.

### 3.1.2. Range Sensor Measurement System:

Previous team selected two type of sensors, the Sharp GP2Y0A21 IR and the Maxbotix LV-EZ0 Ultrasonic sensor. There are 26 sensors mounted on the base frame of the wheelchair. They are able to cover the field around the wheelchair. However feedback reading from the sensors are not accurate during several tests. The goal for the current team is to improve the accuracy of the sensor signals and combine the sensor's measurement into an alternative laser scan map. The functionality specification is described as following:

1. Desired results:
  1. Generate an alternative laser scan to replace the LiDAR device.
  2. The scan points shall reflect the distances from the center of the wheelchair to the obstacles in the sensors' ranges.
2. Customizable design:
  1. Scan capacity shall be customizable.
  2. Scan range shall be customizable.
  3. The number of sensors shall be customizable.
  4. The location and orientation of sensors shall be customizable.
  5. The types of sensors shall be customizable.
  6. The number of sensors in the wheelchair system shall not affect the validation of the scan field.

### 3. Quality design:

1. The lag of response from the scan reading in Rviz due to ROS python node shall be less than 0.08 sec.

#### 3.1.3. Back Mounting System

Design a mounting system for other components such as laptop, BCI equipment, and tray. This mounting system should be stable, use existing mounting points on the wheelchair. It should be able to withstand the force an arm swing and support 30 pounds. This system is to replace the prototype headrest mount.

#### 3.1.4. Evaluate the Number of Sensor Boards Used

After inspection it was noted that most sensor boards were only using half to two thirds of their ports, along with a proposed reduction in the number of sensors. In order to improve efficiency and cost, the number of boards used should be reduced.

#### 3.1.5. Casings

##### 3.1.5.1. Sensor Casings

The previous design of the sensor casings provided for a one time assembly into a solid construction, trapping the sensor inside with play in its position. The sensor casings are to be redesigned to allow for replacement of the sensor in case they break, and remove the play in the sensors to avoid noisy readings from vibrations. The previous design of the sensor casings provided for a one time assembly into a solid construction, trapping the sensor with play. The sensor casings are to be redesigned to allow for replacement of the sensor in case they break, and remove the play in the sensors to avoid noisy readings from vibrations.

##### 3.1.5.2. Sensor Board Casing

The following were the requirements for the sensor board casing:

1. Hole for power wire
2. Easier to use sensor port hole
3. No more bending of USB interface

### 3.1.5.3. Motor Controller Casing

The following were the requirements for the motor controller casing:

1. Provide access to all ports
2. Cover most of motor controller
3. Allow for heat dissipation from bottom metal plate

## 3.2. Implement Multiple Interfaces

Based on the existing resources and common use for our targeting users with different levels of mobility, the team has come up with the following requirements and functionalities for developing the user interfaces control system:

### 3.2.1. Requirements and Functionalities of EMG and Voice Control

#### 3.2.1.1. Emotiv Control

To utilize the Epoc Emotiv EMG interface for the wheelchair control, the following functionalities shall be implemented.

1. The EMG control system shall allow the user to control the motion of the wheelchair.

Including: stopping, moving forward, moving backward, and turning left/right.

2. The EMG control system shall send voice feedback to the user for every command issued from headset.

3. The EMG control system shall be able to evaluate the control accuracy in a pre-drive test on the operator before using it to prevent unstable control.

#### 3.2.1.2. Voice Control

1. The voice control system shall allow the user to control the motion of the wheelchair.

Including: stopping, moving forward, moving backward, turning left/right, and increasing/decreasing speed.

2. The voice control system shall allow the user to control the wheelchair to go to a predefined goal location, e.g., kitchen, lab... User will be able to cancel the goal while on the move.

3. The voice control system shall send voice feedback to the user if received a valid command. Or ask the user to say again if the command was unrecognizable or invalid.

4. Some other types of voice feedback shall be provided to demonstrate other possible interactions between the user and the voice control system. e.g., greetings, asking for the time.....

#### 3.2.1.3. Mechanical Joystick Interface

In order to improve the system's modularity, remove the necessity for invasiveness, and avoid proprietary controls, a joystick control system is to be developed. The system is to be capable of controlling the position of the joystick mechanically, in a method that does not require the original to be modified or damaged. This part of the system must also be able to communicate with the computer running ROS.

## 4. Design

This section deals with the team's ideas and decisions that are implemented to improve the semi-autonomous wheelchair. This section contains explanation behind the designs for the improvements made to the old design as well as the new control interfaces for the wheelchair.

### 4.1.Improvements on the Project

In the improvements section of the design portion we go over the discussion behind the changes made to the IR and US sensors, Back Rack, and the sensor casings. This includes how requirements were achieved for each part of the semi-autonomous wheelchair.

#### 4.1.1. IR and Ultrasonic Sensors

After testing the previous project, the measurements from the sensors could have a systematic errors. Further investigation proved that this was caused by sensors' interfering with each other because of their mounting locations are not far enough.

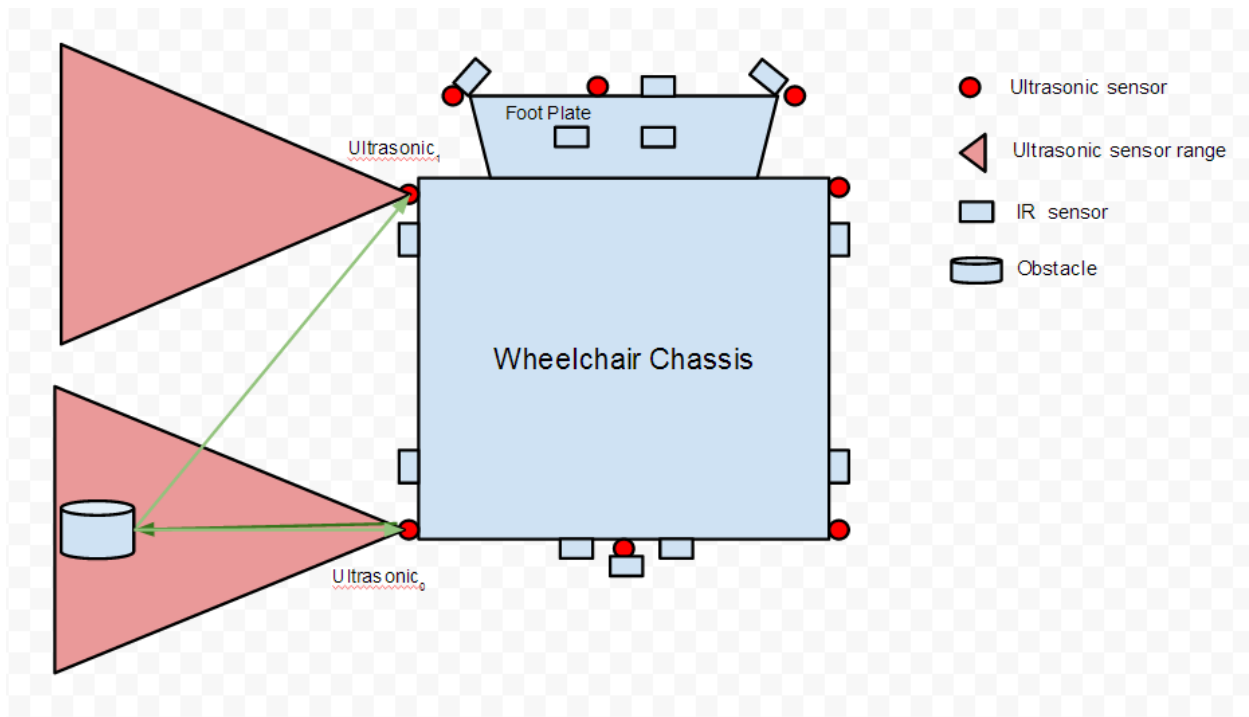

FIGURE 9: ULTRASONIC SENSORS INTERFERES WITH EACH OTHER

An example of how Ultrasonic sensors can interfere with each other is shown in Figure 9. The initial sound (dark green arrow) shots from Ultrasonic<sub>0</sub> hits on the obstacle. The echo is reflected back to Ultrasonic<sub>0</sub>. The distance is calculated based on the time that starts from the sound



gets sent out to its echo gets received, Ultrasonic<sub>0</sub> can detect obstacle that is in its range. However, in this case, the echo is also reflected to Ultrasonic<sub>1</sub> due to the curve surface of the obstacle. This undesired echo will confuse Ultrasonic<sub>1</sub> to treat the echo as its own, therefore a wrong time difference is used by Ultrasonic<sub>1</sub> to calculated distance. Based on the wrong calculations both Ultrasonic sensors treat the obstacle as if they are in their detection ranges. This unexpected behavior leads to the systematic errors from the sensors measurements.

#### 4.1.1.1. Hardware Layout

By removing Ultrasonic sensors that are on the same side, which could lead to an interfering situation, a new sensor layout was developed, it is shown in Figure 10. The detect distance for GP2Y0A21 IR sensor [23] used on the wheelchair is up to 0.8m. The detect distance for Maxbotix LV-EZ0 Ultrasonic sensor [24] used on the wheelchair is up to 6.45m. By rearranging the sensors position according to the sensor's coverage, the unexpected echo is minimized to an accepted level. With new sensor placement as shown in Figure 10, we are not able to detect any interferences between the sensors.

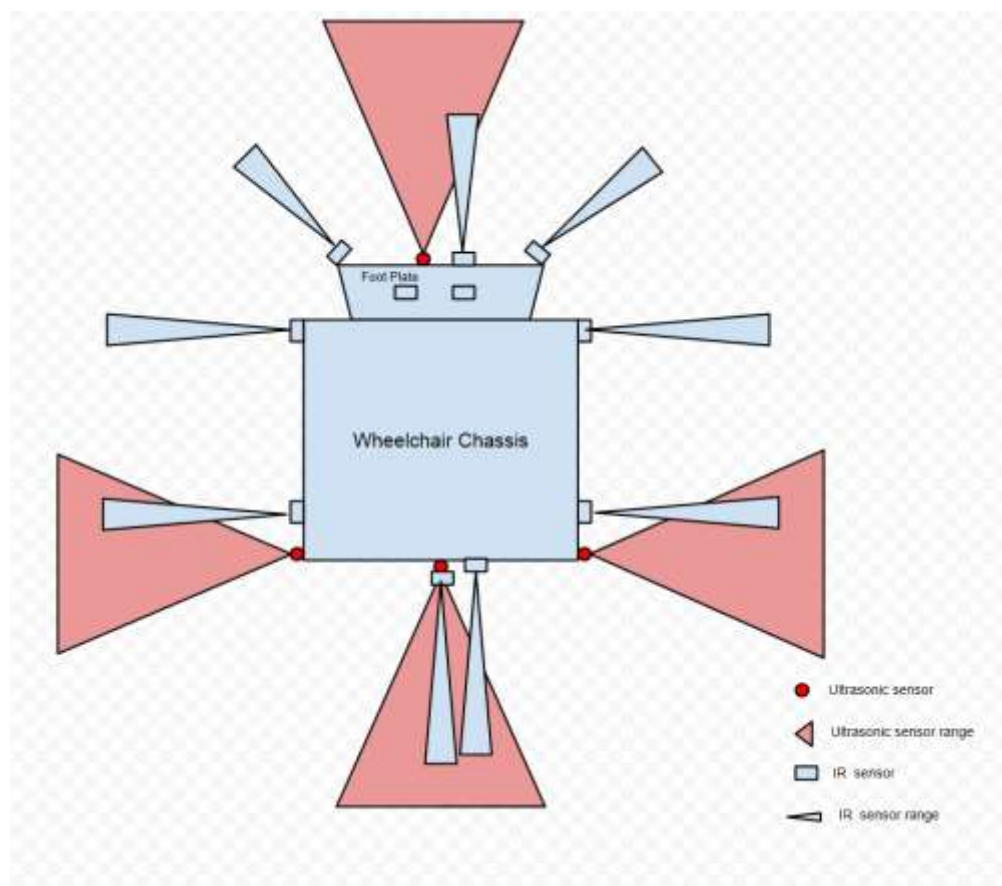

FIGURE 10: SENSOR LAYOUT TO MINIMIZE THE EFFECT OF INTERFERING

#### 4.1.1.2. Algorithm for Converting Range Sensors Measurement into a Laser Scan Format

Laser scan is a standard sensor format which is used for the navigation libraries. In ROS system, a fake laser scan is a terminology which describes the laser scan data that is not generated by a standard laser scan device. To provide a fake laser scan from the combination of sensors to replace the LiDAR scan, the sensor system collects and parses the distance measurements from each sensor and converts them into a laser scan format.

As shown in Figure 11, the algorithm converts the distance between the sensor and the obstacle,  $D_s$ , to the distance between the reference turning center of the wheelchair (O) and the obstacle,  $D_o$ . With the common reference center (O), all the sensors can convert the distances from a direct measurement to a relative distance reference to the center point O to form a complete laser scan.

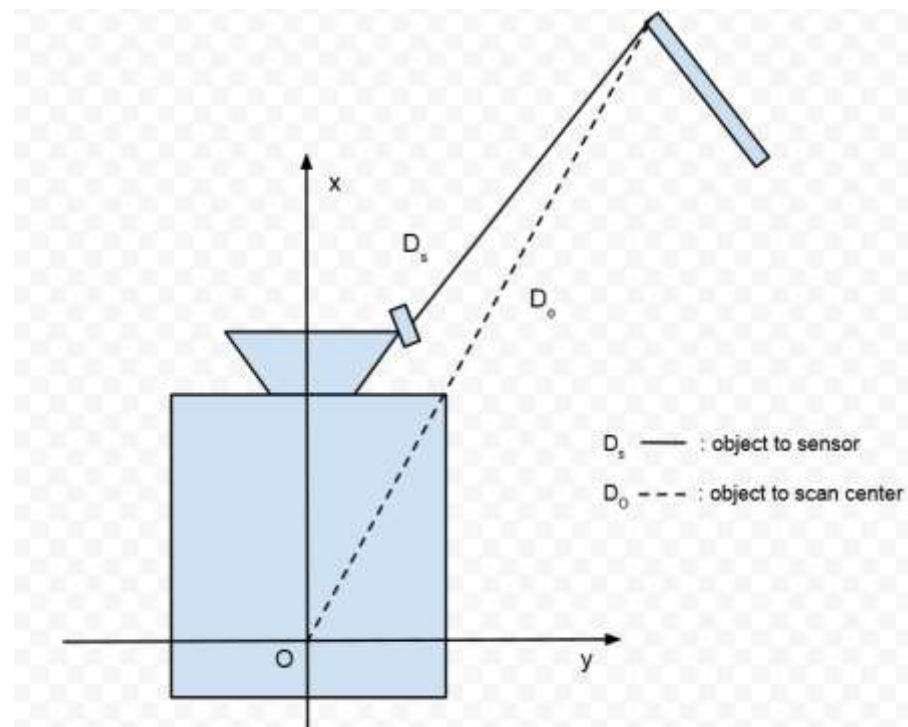

FIGURE 11: DISTANCE CONVERSION

As presented in Figure 12, sensor  $P_s$  is located on the wheelchair's footplate. Object  $P_1P_0$  is within the range of the sensor. Assume  $O$  is the reference center of the wheelchair. The following initial conditions can be known from the geometry configurations specified by the user:

- Orientation of sensor  $P_s$ :  $\alpha$
- Coordinates of sensor  $P_s : P_s(x_s, y_s)$
- Distance reading from sensor:  $|P_sP_m|$
- Relation between  $|P_sP_m|$  and  $|P_1P_0|$  as described by user defined function:  $|P_1P_0| = \text{beamFunction}(|P_sP_m|)$

Given an object  $P_1P_0$ , calculate the intersection point  $P_k$  for any given line with slope angle,  $\beta$ , from origin,  $O$ , namely  $|P_0P_k|$

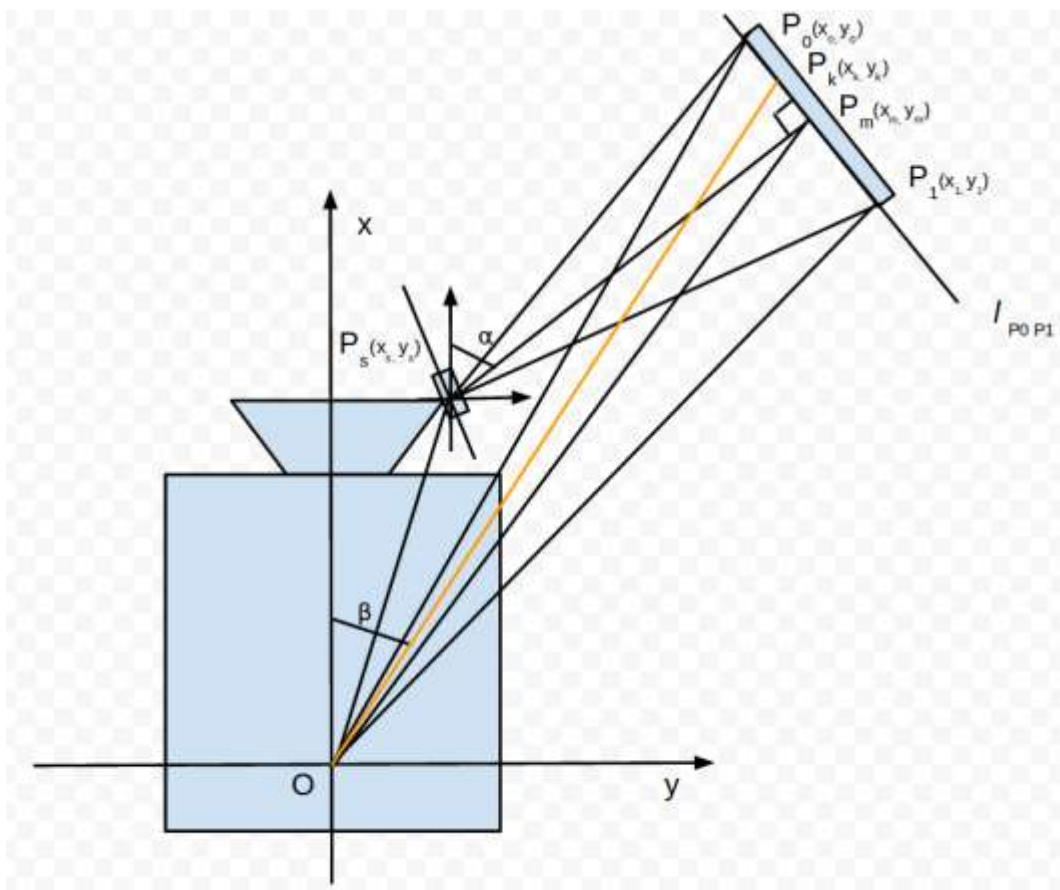

FIGURE 12: GEOMETRY ANALYSIS FOR A RANDOM SENSOR SCAN

Unit vectors are calculated based on the known condition:

$$\left\{ \begin{array}{l} \overrightarrow{i_{P_s P_m}} = \{ \cos(\alpha), \sin(\alpha) \} \\ \overrightarrow{i_{P_1 P_0}} = \{ \cos\left(\frac{\pi}{2} - \alpha\right), \sin\left(\frac{\pi}{2} - \alpha\right) \} \end{array} \right.$$

a, b, c from equation calculation form:  $(y_1 - y_2)x + (x_2 - x_1)y + (x_1 y_2 - x_2 y_1) = 0$

Vector  $\overrightarrow{OP_s}$  is the sensor's location corresponding to origin O:

$$\overrightarrow{OP_s} = (x_s, y_s) \quad (1)$$

$$\overrightarrow{P_s P_0} = \overrightarrow{P_s P_m} + \overrightarrow{P_m P_0} = |P_s P_m| * \overrightarrow{i_{P_s P_m}} + \frac{f(|P_s P_m|) * \overrightarrow{i_{P_1 P_0}}}{2} \quad (2)$$

$$\overrightarrow{OP_0} = \overrightarrow{OP_s} + \overrightarrow{P_s P_0} \quad (3)$$

Plug equations ( 1 ) and

( 2 ) into ( 3 ),  $\overrightarrow{OP_0}$  is calculated.

$$\overrightarrow{OP_0} = (x_{P_0}, y_{P_0})$$

The same calculation process for  $\overrightarrow{OP_1}$ :

$$\overrightarrow{OP_1} = (x_{P_1}, y_{P_1})$$

The general form expression of line  $l_{P_1 P_0}$ :

$$l_{P_1 P_0}: ax + by + c = 0 \quad (4)$$

Plug these two points,  $P_0, P_1$  into equation (4):

$$l_{P_1 P_0}: (y_{P_0} - y_{P_1})x + (x_{P_1} - x_{P_0})y + (x_{P_0} y_{P_1} - x_{P_1} y_{P_0}) = 0$$

The general form of line  $l_{OP_k}$  :

$$l_{OP_k}: a_k x + b_k y = 0 \quad (5)$$

With any given  $\beta$  :

$$\begin{cases} a_k = -\cos \beta \\ b_k = \sin \beta \end{cases}$$

Plug  $a_k, b_k$  into (5):

$$l_{OP_k} : -\cos \beta x + \sin \beta y = 0$$

In order to calculate the intersection, solve the follow equations for intersection points:

$$\begin{cases} l_{P_1P_0} : ax + by + c = 0 \\ l_{OP_k} : a_kx + b_ky = 0 \end{cases}$$

$$\begin{cases} l_{P_1P_0} : (y_{P_0} - y_{P_1})x + (x_{P_1} - x_{P_0})y + (x_{P_0}y_{P_1} - x_{P_1}y_{P_0}) = 0 \\ l_{OP_k} : -\cos \beta x + \sin \beta y = 0 \end{cases}$$

The intersection point  $P_k$  can be calculated  $(x_{P_k}, y_{P_k})$

$$|P_0P_k| = \sqrt{x_{P_k}^2 + y_{P_k}^2}$$

According to the user's scan interval set in the parameter file, different  $\beta$  values are assigned to calculation to form a circle of fake laser scan.

#### 4.1.1.3. Alternative Sensor System Scan Result

Within the user defined laser range, Figure 13 shows the generated fake laser scan by the sense system. The scan range covers 270 degrees as customized in the configuration. The white arc is made of the scan points and is displayed for showing the maximum range of the laser scan field. There are four white points in the circle range, which represents the objects detected by the

sensor scan system. From observation during test, as wheelchair approaches the objects, the white points move smoothly towards the center of the wheelchair as expected.

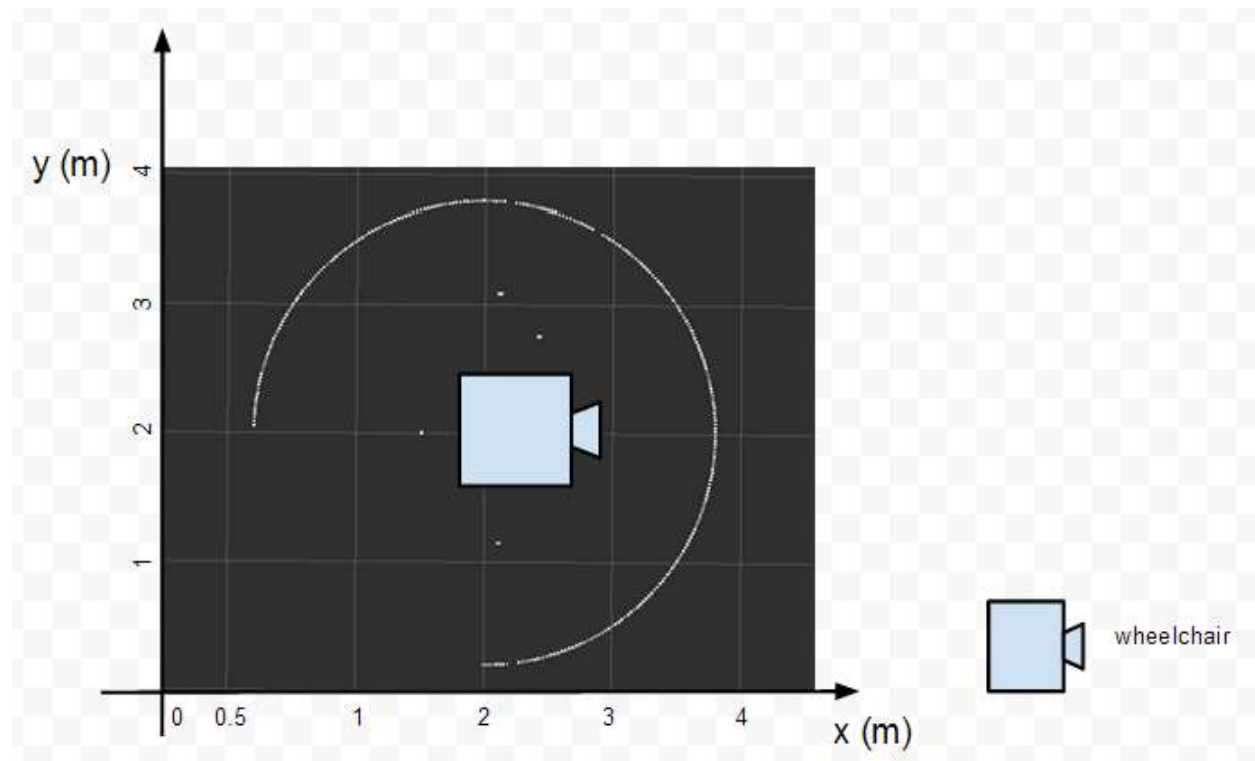

FIGURE 13: ALTERNATIVE LASER SCAN

#### 4.1.2. User Operation History Visualization

Other than the planned control interfaces, the current team believes it is necessary to develop a program for collecting user control history. They will be used for artificial intelligence programs associated with the wheelchair in the future development. By recording the decisions made by people over time, the program will reasonably predict the next movement the user might make. In order to track the user's behavior history and commands history, a log system need to be implemented. Several ROS topics are selected for the project purpose:

- camera : video
- cmd\_vel : speed
- verbalStates : verbal explanation of status

- odom: location
- amcl\_pose: pose
- tf: transfer frame

The ROS messages are recorded in rosbag. They captured the environment situation, wheelchair path, control interfaces' command history and user's verbal description. For storage purpose, the camera records are downsized, also with a frame speed of 5 sec per frame. This results in a ROS bag size of 11Mb/ min.

To visualize the bag file, especially the track path and odometry data more direction to the developers, a data converter is implemented in ROS platform. With data replay from ROS node, the path of the wheelchair will be displayed from the Rviz panel.

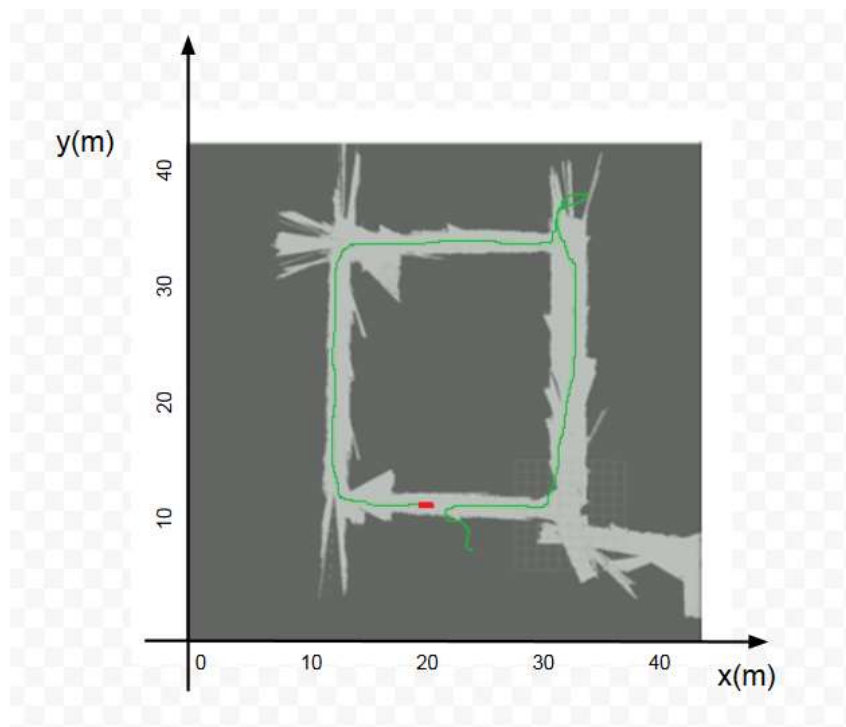

**FIGURE 14: WHEELCHAIR PATH FROM RECORDED ROSBAG FILE**

The Figure 14 is the first floor of Atwater Kent Laboratories, WPI. The red dot represents the moving wheelchair. The green tracer is the path that the wheelchair travelled. By visualizing the path information, it makes observing the user behavior more direct and convenient.

#### 4.1.3. Back Rack

As a design solution to providing a location on the wheelchair where sensors and equipment such as LIDAR, Kinect, camera, stereo vision, speakers, and a laptop would not receive interference the Back Rack was developed. Upon inspecting the bottom mounting points of the wheelchair, shown in Figure 15, it was discovered that the frame was 1 ¼” metal tubing with 1/8” walls, providing us with a 1”x 1” square hole. 80/20 1010 extruded aluminum has 1”x 1” outside dimensions, resulting in a very snug fit and a perfect candidate for creating a structure on the back of the wheelchair. 80/20 also offers a verity of mounting options and brackets to design a desired structure.



**FIGURE 15: BOTTOM MOUNTING POINT**

In order to create a stable mounting structure another point was chosen for mounting the Back Rack. This point was the same as the headrest mount, the car seat beams from the headrest. This allowed for the construction of an area approximately 22” tall by 10” wide on the back of the wheelchair. On top of this structure another structure made of 80/20 was mounted, with 24” high and 8” wide. The full structure while mounted on the wheelchair stands approximately 63” tall, or 5’3”. The original model can be seen in the SolidWorks rendering shown in Figure 16.





**FIGURE 16: SOLIDWORKS RENDERING OF BACK RACK**

In order to meet the design requirements of being able to withstand an arm swing some research was done into human physical strength. No research was found on the strength of an arm swing, but research was found on the pushing force of a human being. A male of average height pushing the wheelchair would be instead chosen as a possible worst case scenario. In that case the study showed that while pushing at elbow height the average force a male of average height was able to exert was approximately 250N [25]. Using a team member of very similar height, to that of the US average of 1.763m, it was determined that the elbow pushing point would be approximately around 1.2m high, approximately 20 cm of beam in the second structure.

#### 4.1.4. Casings

##### 4.1.4.1. Sensor Casings

In order to allow the sensors to be removed and the casings two things were changed from the previous design. The first was that holes were introduced for both the top cover and bottom plates of the sensor casings, matching those present on the sensors, so that screws could be driven through to fasten the top cover, the rest of the sensor casing remained assembled by glue. And secondly the holes that the sensor wires ran through were either expanded or changed so that the

sensor could be removed with less effort. And in an attempt to stop any kind of play, or possible vibration of the sensors, spacers were added to the screw while being fastened. Shown below in Figure 17 is an Ultrasonic sensor that has had its case top knocked off, the top was held on solely by friction.



**FIGURE 17: ULTRASONIC SENSOR WITH TOP KNOCKED OFF**

#### 4.1.4.2. Sensor Board Casings

The changes made to improve the functionality of the sensor board casings were the addition of a hole for the power cord of the board, widening the hole for the sensor ports, and increasing the length of the casing so that the screw hole matched the boards, some of these issues can be viewed in Figure 18. Another design choice was to include extension cables from the ports of the board.

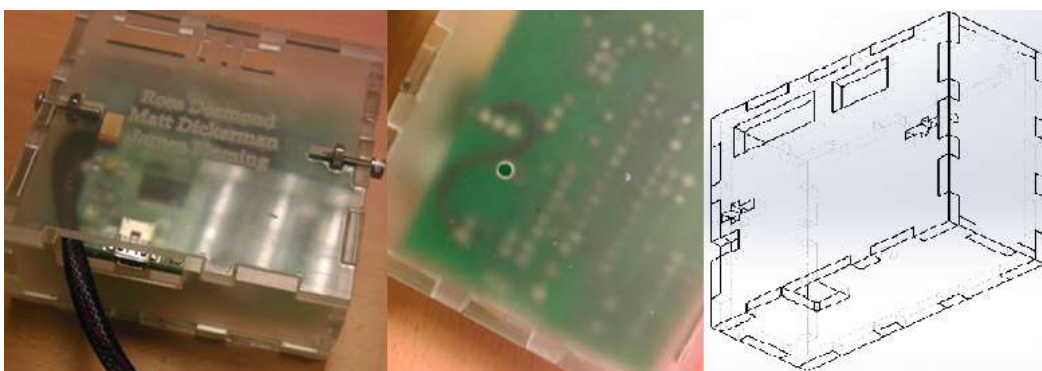

**FIGURE 18: ORIGINAL SENSOR BOARD CASING, LEFT DEMONSTRATING NO EXIT SPECIFICALLY FOR POWER WIRE, MIDDLE DEMONSTRATING THE MISS ALIGNED SCREW HOLE, RIGHT PROPOSED NEW CASING MODEL**

#### 4.1.4.3. Motor Controller Casing

The motor controller casing was first imagined as a box encompassing the whole board, displayed in Figure 19, and all of its components. Sections of each of the walls were removed to allow access to ports and screw terminal so that the board remained serviceable even while in the casing. Holes were inserted to the top plate to match the screw holes on the board, these were meant for screws with spacers to allow for mounting while preventing any play in the component's position. The final design choice was to remove the bottom of the box, allowing the metal heat dissipation plate to remain exposed to air.



**FIGURE 19: MOTOR CONTROLLER BOARD, LEFT COMPONENTS AND PORTS, MIDDLE HEAT SINK PLATE, RIGHT PROPOSED DESIGN FOR CASING**

## 4.2. Control Interfaces

This section explains the control interfaces design process for voice control, EMG control and the mechanical joystick adapter control.

### 4.2.1. Voice Control Interface Design

Based on the specifications and functionalities planned for voice control interface, the team works on the design and prototype of a working voice control system. With the software implementation and hardware set up, this system allows user to interact with the wheelchair through voice commands.

#### 4.2.1.1.1. Voice Control System Architecture

As presented in Figure 20, when user says a command into the microphone, the voice will be converted to an electric signal. The recognizer will then split the incoming signal into utterances

and match them to the words or phrases in the current vocabulary. When the recognizer node matches a word or phrase, it publishes a message which the main voice\_control node subscribes to.

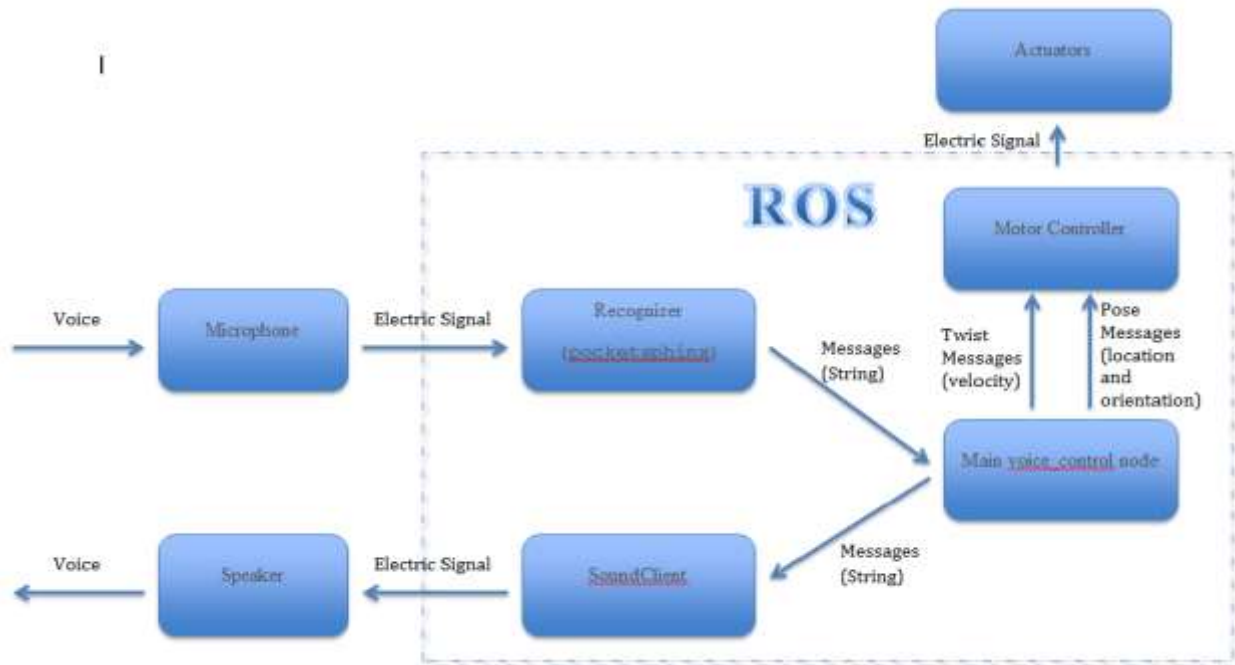

FIGURE 20: VOICE CONTROL SYSTEM DIAGRAM

The main voice\_control node serves 2 major functionalities in the voice control system. It allows controlling of the wheelchair using simple speech commands, as well as sending voice feedback to the user based on what is heard by the pocketsphinx recognizer.

The voice\_control node subscribes to the /recognizer/output topic published by the recognizer.py node. It looks for valid commands from the message received, and then maps most valid voice commands into Twist or Pose messages that can be used to control the wheelchair. A keywords-to-command map is used to map different verbal words and phrases into the same action. As it is the highest priority to be able to stop the robot once it is moving, the “stop” command has to work anytime without lag. However, our test result shows that not every word has 100% accuracy of being recognized. So a number of alternative ways of telling the robot to stop were provided like "halt", "abort", and "help" to increase the response rate when emergency stop is needed. The mapping from keywords to commands is shown below.

To send voice feedback to the user, the node keeps a map of commands and feedbacks. So it can find the right feedback for each command, and talks to the sound\_play server using the

SoundClient class imported from the sound\_play library. The SoundClient class then publishes a SoundRequest message to the sound\_play node.

Command	Keywords
'hello'	'hi', 'hello'
'time'	'time', 'the time', 'whats the time'
'wheelchair'	'anna', 'wheelchair', 'auto wheelchair'
'stop'	'stop', 'halt', 'abort', 'kill', 'panic', 'off', 'freeze', 'shut', 'shut down', 'turn off', 'help', 'help me'
'slower'	'slow down', 'slower'
'faster'	'speed up', 'faster', 'go faster'
'forward'	'forward', 'ahead', 'straight', 'go forward', 'go straight'
'backward'	'back', 'backward', 'back up', 'go back', 'move back'
'rotate left'	'left', 'rotate left'
'rotate right'	'right', 'rotate right'
'turn left'	'turn left', 'left'
'turn right'	'turn right', 'right'
'quarter'	'quarter speed'
'half'	'half speed'
'full'	'full speed'
'kitchen'	'kitchen', 'go to the kitchen', 'go kitchen'
'lab'	'lab', 'go to the lab', 'go lab'
'pause'	'pause speech'
'continue'	'continue speech'
'cancel'	'cancel'

TABLE 1: THE MAPPING FROM KEYWORDS OR PHRASES TO COMMANDS

The sound\_play node translates message into sounds, and makes speech synthesis via festival. The synthesized voice will then played out through the speaker.

#### 4.2.1.2. Hardware Components

For the voice control interface to work properly, good hardware set up is as essential as the software implementation. It ensures that the recognizer get high quality voice input, and helps to play out a clear voice feedback. To reduce the complexity of wire connections on the wheelchair, the team decided to go wireless with the microphone and speaker for voice input/output.

##### 4.2.1.2.1. Sony ECM-AW3 Wireless Microphone

As the voice recording quality of the laptop's built in microphone is very limited at a distance, we ordered the Sony ECM-AW3 Bluetooth Microphone which comes with a microphone (transmitter) unit and a receiver unit.

To record wirelessly, connect the output jack on the receiver to the audio input jack of a computer as shown Figure 21. Then turn on both the microphone and receiver, and wait for them to pair (the flashing blue lights on both unit indicate the pairing status). You can now record voice to the computer remotely by speaking to the microphone.



**FIGURE 21: THE MICROPHONE AND RECEIVER UNITS**

##### 4.2.1.2.2. Tips for Use

The output volume from the receiver is a little bit low even with the volume button on it turned all the way up. At times it is necessary to amplify the input from the audio settings of the

computer. Extremely caution is advised, as the recognizer picks up more noise in high amplification settings.

#### 4.2.1.2.3. Logitech UE Bluetooth Speaker

The Logitech UE Mobile Boombox is a portable compact Bluetooth speaker. It can connect with a line input or wirelessly via Bluetooth with devices that support Bluetooth® wireless audio profile. The unit has a built-in rechargeable battery, and it charges via a USB connection on back.



**FIGURE 22: THE LOGITECH UE MOBILE BOOMBOX**

#### 4.2.1.2.4. Mounting of the Speaker

The team has come up several ways of mounting the speaker, but decided to mount it on the Back Rack behind the headrest. This way the sound will come at the place relatively close to the ears of a user in a sitting position. The speaker was fastened using an elastic armband, so we can take it off easily for charging the battery and etc.

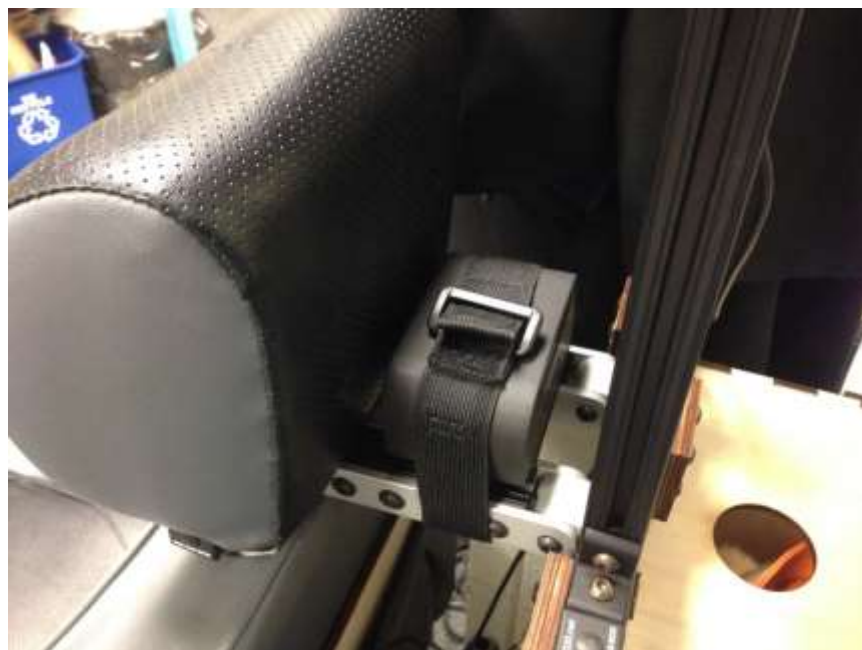

**FIGURE 23: THE SPEAKER MOUNTED ON THE BACK RACK**

#### 4.2.1.2.5. [Tips for use](#)

The Logitech UE Bluetooth speaker unit has a built in power saver feature that puts the speaker to sleeping mode when inactive for a certain amount of time. This causes an issue when using the voice control system. If a sound hasn't been played in several minutes, the next sound won't be played until it wakes up from sleeping mode. To solve the issues our talkback node send a dummy sound every 5 minutes of inactivity.

#### 4.2.2. [EMG Control](#)

This section explains the hardware setting, software flow mechanism and logical reasoning of the design process of EMG control interface.

##### 4.2.2.1. [Hardware Components](#)

EPOC Emotiv has three main components, Neuroheadset, USB wireless receivers, headset pads. The neuroheadset receives signals (EEG or EMG) from the user, then converts these analog signals to digital form. They are analyzed by the headset and transferred to the USB receivers. A post-processing software API runs on the PC will help the developers to read and parse these information as desired and finally applied in the customized programs.



As presented in the following Figure 24, the headset communicate with PC to transfer the EMG signal, which allows the PC send the corresponding commands to control the wheelchair.



**FIGURE 24: HARDWARE SETUP AMONG HEADSET, COMPUTER AND WHEELCHAIR**

#### 4.2.2.2. Software

EPOC emotiv development kit comes with several control mode: Cognitive control, Expressive control and Affective control.

After several experiments described in latter sections, Table 2 sums up most of the characteristics that are in the control interface design consideration.

<b>Control mode</b>	<b>Source signal</b>	<b>Technology</b>	<b>Control ability</b>	<b>Disability</b>
<b>Expressive mode</b>	Facial expressions	EMG	Easy	Quadriplegia
<b>Affective mode</b>	Emotional states	EEG	Hard	LIS
<b>Cognitive mode</b>	Conscious thoughts	EEG	Hard, training needed	LIS

**TABLE 2: CONTROL MODE COMPARISON**

#### 4.2.2.3. Software Setup

Based on the hardware connection and setup, the PC will handle the signals generated from the headset as a pre-process. A ROS package, `emotiv_control`, is created by the current team to process the EMG signal using Emotiv API. After processing the EMG data, the ROS node will send the motion commands and voice feedback to the wheelchair. 25 demonstrates the implementation of the ROS node in `emotiv_control`.

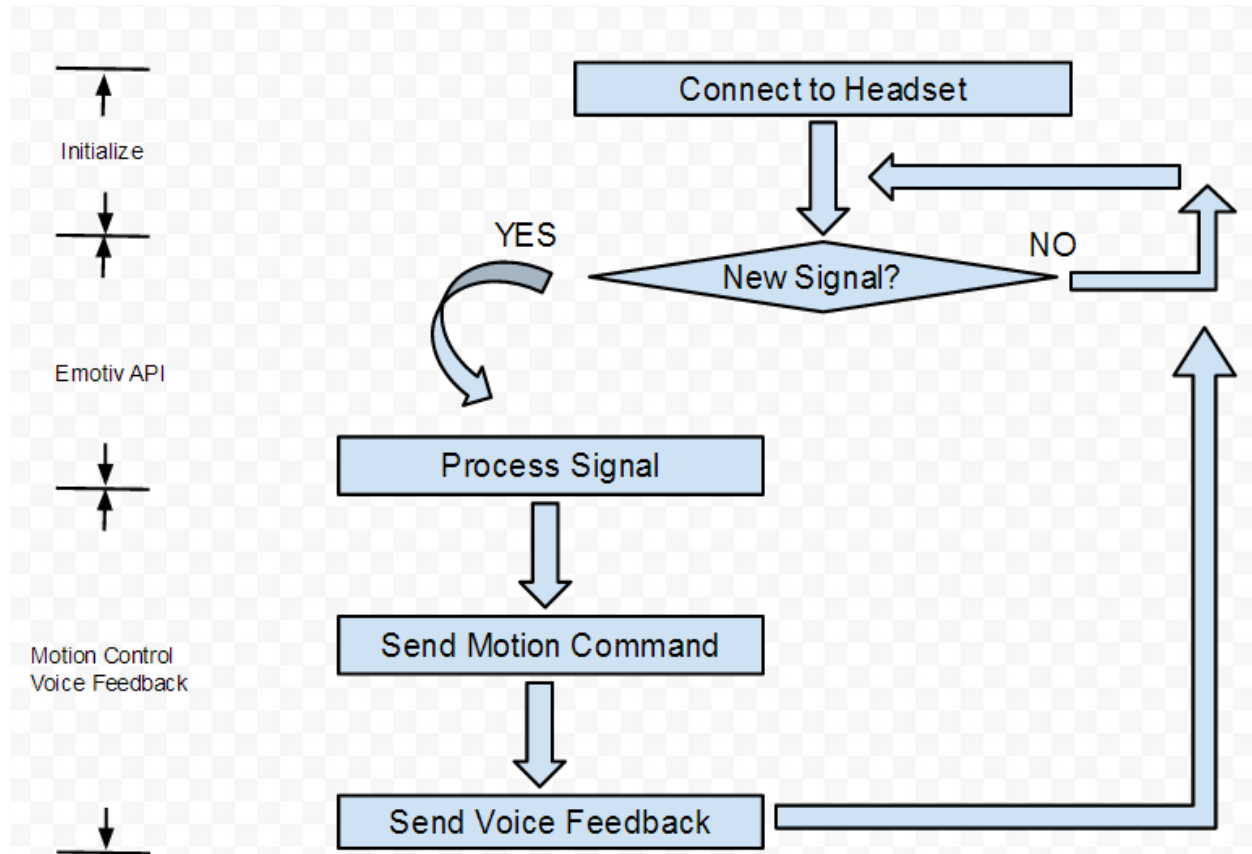
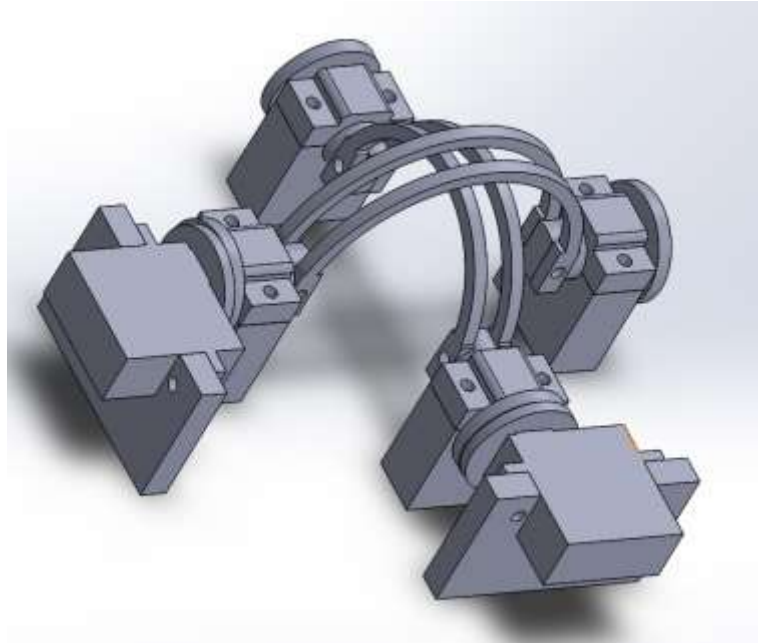

FIGURE 25: SOFTWARE FLOW CHART OF EPOC EMOTIV CONTROL MODE

#### 4.2.3. Mechanical Joystick Interface Control

The initial challenge was to create an interface for the physical joystick system. This was done by designing a system consisting of two overlapping double parallel archers with rotational axis orthogonal to one another, this would provide the motion necessary to control the X and Y

position of the joystick. The reason for the double parallel arches is so that a gap is formed in which the joystick or something attached to the joystick may reside inside of the gap. This structure's mechanical power came from two servo mounted to the end of each rotating axis. Due to the part complexity 3D printing was chosen as the method of fabrication. In order to avoid issues with 3D printing complicated structures, parts were divided into smaller components to be later bolted together. A SolidWorks rendering of the system can be seen in Figure 26.



**FIGURE 26: SOLIDWORKS RENDERING OF JOYSTICK SYSTEM**

The interfacing with the computer was done through an Arduino using the ROS Arduino library, this library allows Arduinos to publish and listen to topics in ROS via serial. Note that in order for ROS to work on an Arduino the computer must also be running the ROS serial package. This allows for the Arduino to interact with the rest of the system.

## 5. Results and Analysis

This section presents the result and analysis for the project. It includes each control interface developed: voice, EMG, and joystick, as well as improvements on the Back Rack and casings of the wheelchair.

### 5.1.Voice Control:

With the successful implementation of the voice control system, users can now control the wheelchair using the voice commands present in Figure 27.

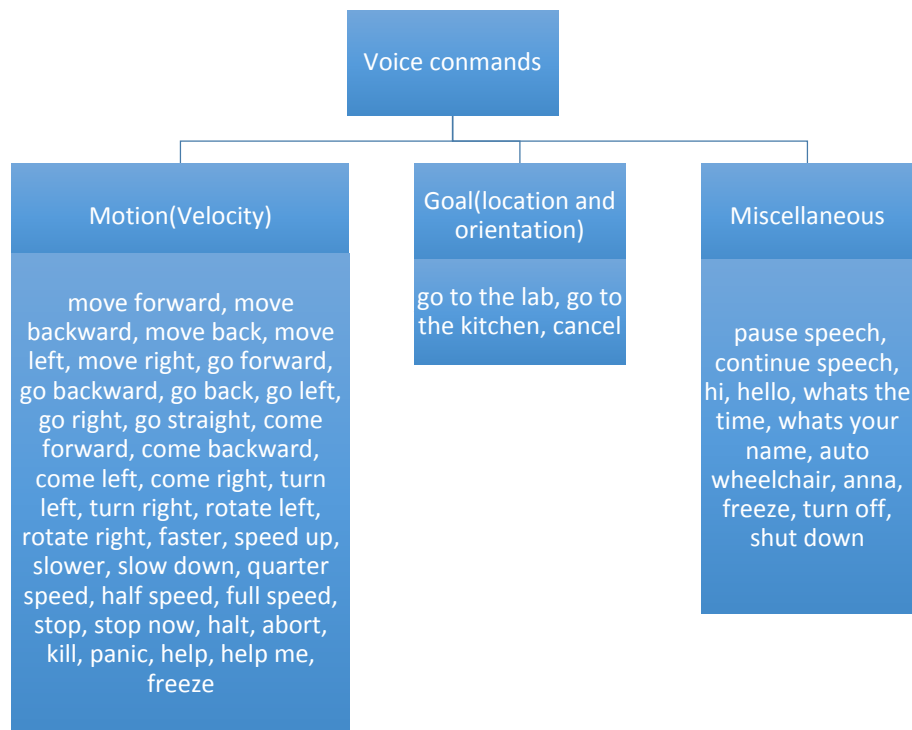

FIGURE 27: VOICE COMMANDS

### 5.1.1. Recognizer Accuracy Testing

The team conducted accuracy test for each available voice command. Result of 3 test subjects was recorded. Test subjects were asked to say each voice command 3 times, and the percentage for the command to be correctly recognized is shown in the chart:

Command	Subject 1 (%)	Subject 2 (%)	Subject 3 (%)
pause speech	33	33	0
continue speech	66	33	0
move forward	100	33	100
move backward	100	100	66
move back	100	100	100
move left	100	66	100
move right	66	66	100
go forward	100	0	100
go backward	100	33	100
go back	100	100	100
go left	100	66	100
go right	100	100	100
go straight	33	100	66
come forward	100	66	66
come backward	100	100	100
come left	100	100	100
come right	100	66	100
turn left	100	33	100
turn right	66	66	100
rotate left	100	66	100
rotate right	100	100	100
faster	100	33	100
speed up	100	33	100
slower	100	66	100
slow down	100	33	100
quarter speed	100	33	100
half speed	100	100	100
full speed	33	0	33
stop	100	100	100
stop now	100	66	100
halt	33	33	0
abort	100	66	100
kill	100	66	100
panic	100	100	100
help	100	66	100
help me	100	100	100
freeze	100	66	100
turn off	100	0	100
shut down	100	100	100
cancel	100	66	100

hi	66	100	100
hello	0	33	100
whats the time	100	100	100
whats your name	100	100	100
auto wheelchair	66	100	100
anna	100	100	100
go to the lab	100	66	100
go to the kitchen	100	100	100

TABLE 3: VOICE COMMAND TESTS

As shown in the chart, some commands get overall higher percentage of being recognized correctly than others. And the accuracy for each command also differs from each test subject. This is because each individual has slightly different pronunciation and accent for each word or phrase.

### 5.1.2. Test Voice Navigation in the ArbotiX Simulator

Before using voice control with the wheelchair, the team conducted tests of it on the Arbotix simulator with a simulated turtlebot. Tests were conducted using voice commands, these commands controlled the motion and velocity of the simulated turtlebot while monitoring its behavior.

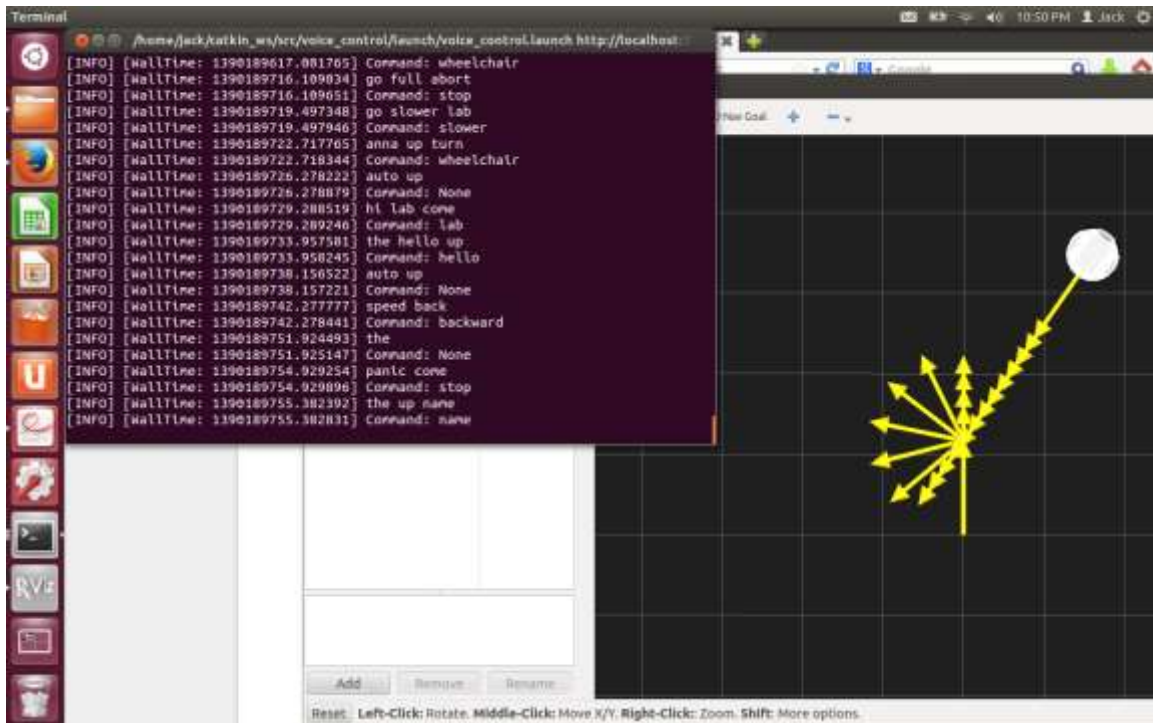

FIGURE 28: TESTING VOICE COMMANDS WITH FAKE TURTLEBOT IN THE SIMULATOR

The Figure 28 shows a test of the recognizer and voice commands. The terminal monitors the words and phrases being recognized and the commands they match to, and the simulator shows the motion of the turtlebot under voice control.

## 5.2. EMG Control:

This section presents the experiments and results of EPOC Emotiv control system, including expressive control, cognitive control, and affective control.

### 5.2.1.1. Expressive Control:

In the SDK application, it shows the basic expression signal collected from the user. Usually the signals are binary, they reflect the blink, wink, look, and smirk facial expression. There are also some complicated expression like raise brow, smile, clench and laugh that are described in the example SDK application in Figure 29.

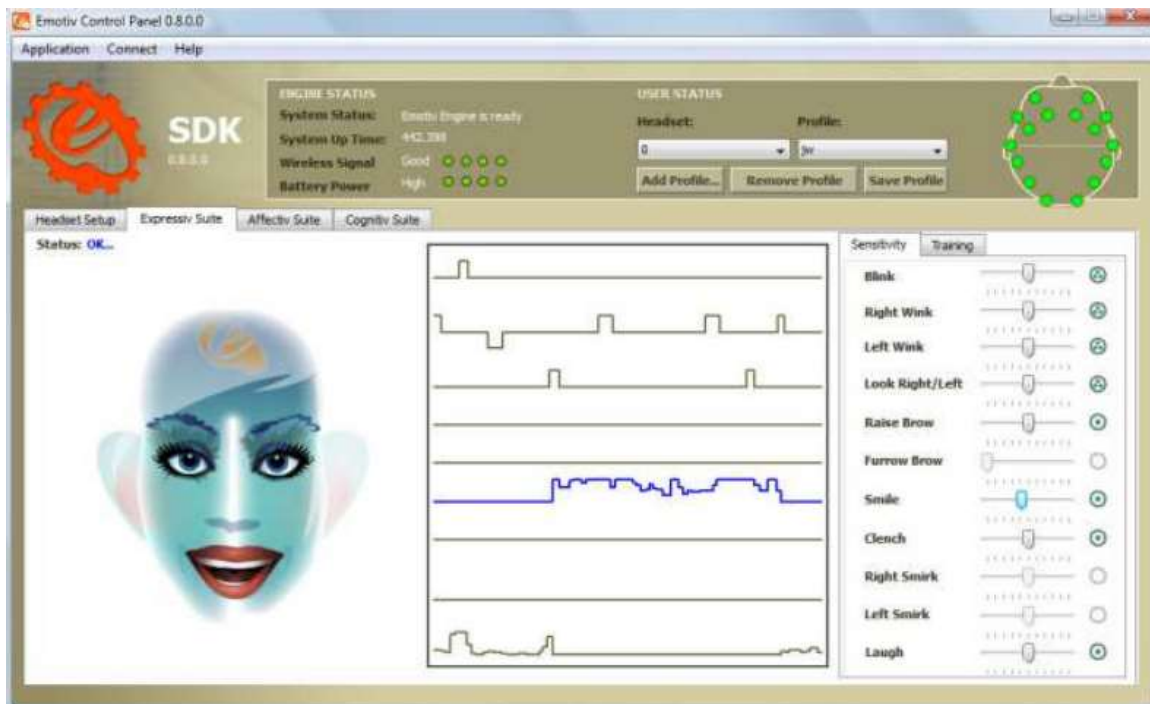

FIGURE 29: AN EXAMPLE OF EXPRESSIVE SDK APPLICATION

To conduct an experiment investigating the accuracy of the expressive control, the following experiment procedure are followed:

- Clean skin to get rid of died skin cell.
- Put the headset on the subject's head and make sure the signals are green on the control panel
- The subjects need to be trained before the experiment to get adapted to the extension of their muscle contraction and relaxation level to which will trigger the signal to be recognized by the program.
- Execute the accuracy generator program until it reaches 10 rounds for every expression.

The same experiment is conducted on four subjects. The results are in Table 4.

Expression	Subject 1	Subject 2	Subject 3	Subject 4	Average
laugh	0.00%	20.00%	0.00%	60.00%	20.00%
left wink	70.00%	0.00%	50.00%	30.00%	37.50%
smile	70.00%	10.00%	40.00%	40.00%	40.00%
look right	100.00%	0.00%	70.00%	40.00%	52.50%
blink	0.00%	50.00%	100.00%	80.00%	57.50%
look left	100.00%	0.00%	100.00%	30.00%	57.50%
right wink	100.00%	0.00%	100.00%	40.00%	60.00%
clench	100.00%	100.00%	30.00%	40.00%	67.50%
furrow brow	90.00%	70.00%	40.00%	80.00%	70.00%
raise brow	100.00%	40.00%	100.00%	50.00%	72.50%
right smirk	100.00%	40.00%	70.00%	90.00%	75.00%
left smirk	100.00%	80.00%	40.00%	100.00%	80.00%

**TABLE 4: EXPRESSION ACCURACY EXPERIMENT ON 4 SUBJECTS**



Different individuals' accuracy testing results range from 35% and 75%. But for certain expressions the accuracy are high enough to generate repeatable commands as control interfaces as presented in Figure 30.

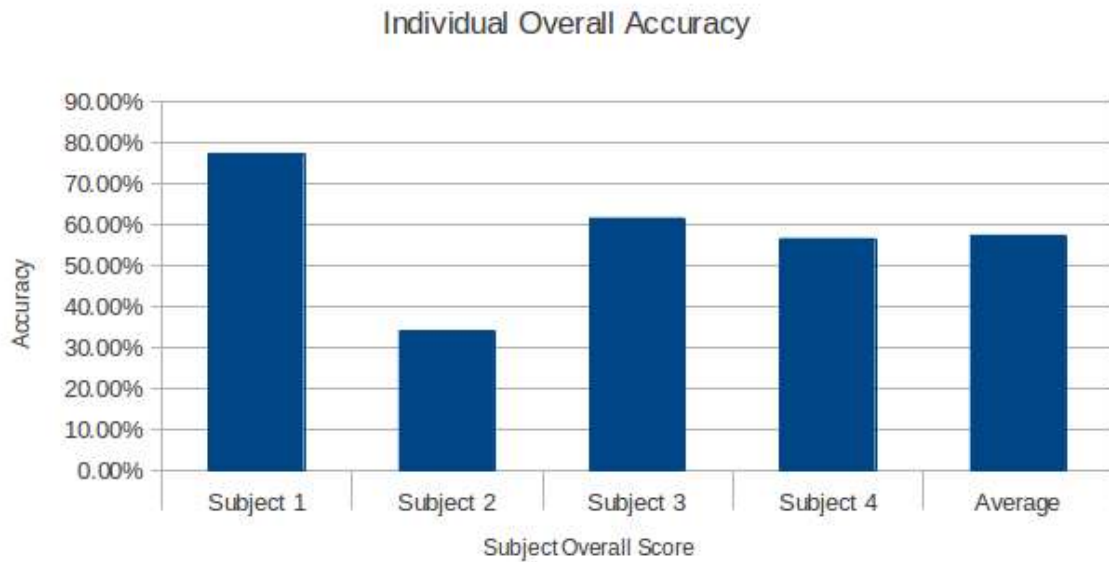

FIGURE 30: EXPRESSION ACCURACY FOR INDIVIDUAL.

From comparing the accuracy of different expressions as shown in Figure 31, there are 5 expressions whose accuracy are more than 65%: left smirk, right smirk, raise brow, furrow brow, clench. They are selected to be used as the control expression triggers.

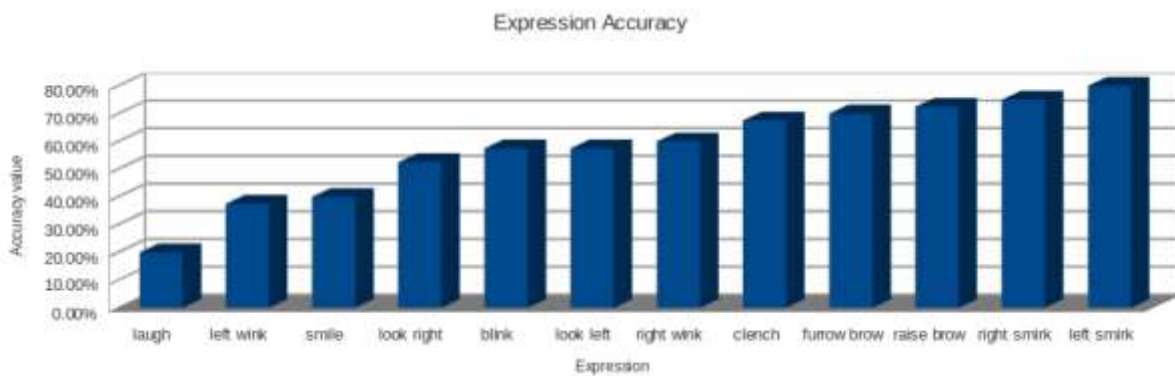

FIGURE 31: EXPRESSION ACCURACY EXPERIMENT

### 5.2.1.2. Cognitive Control:

Cognitive control mode requires the users to be trained for each action. And each training takes 8 sec. There are multiple actions that are listed for the users, such as push, rotate left, lift, etc. However the more actions that are trained, the more errors the user will make. Because there are high probabilities for an extra action to be predicted. The control panel graphic user interface from the SDK application is shown in Figure 32

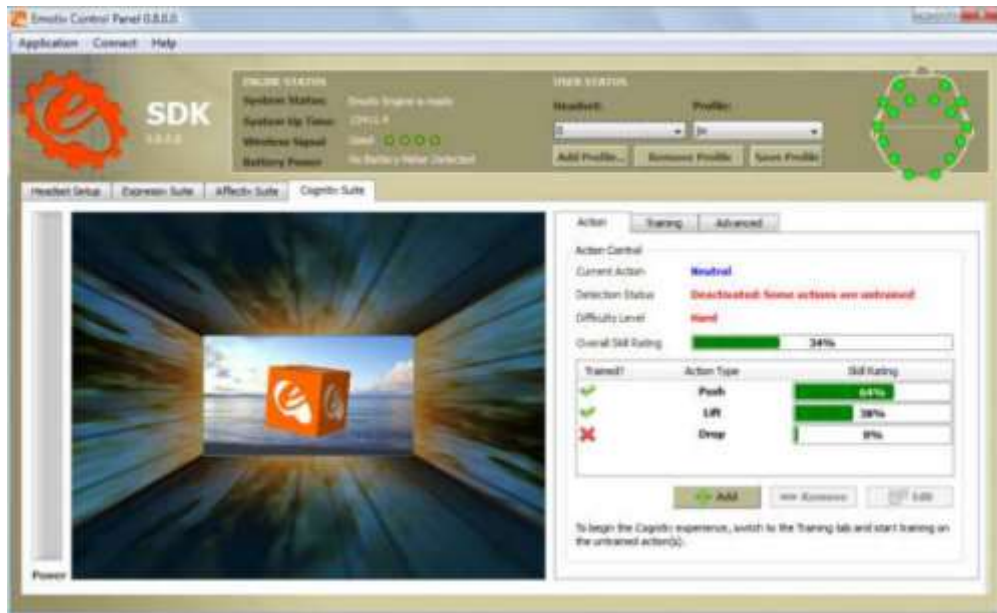

FIGURE 32: AN EXAMPLE OF COGNITIVE CONTROL SDK APPLICATION

To measure the accuracy in the experiment, the users need to be trained in advance. Three actions are trained as the following experiment conducted by Matt Lang [26] : Neutral, left, and right.

The accuracy test is listed as in Table 5:

Left	Neutral	Right	Average
75	37.5	0	37.5
25	25	87.5	45.83
37.5	37.5	50	41.67

50	25	37.5	37.5
0	25	25	16.67
0	50	25	25
37.5	12.5	25	25
25	100	62.5	62.5
37.5	25	37.5	33.33
75	25	12.5	37.5
AVERAGE:			
36.25	36.25	36.25	36.25

**TABLE 5: THE COGNITIVE MODE CONTROL EXPERIMENT RESULTS**

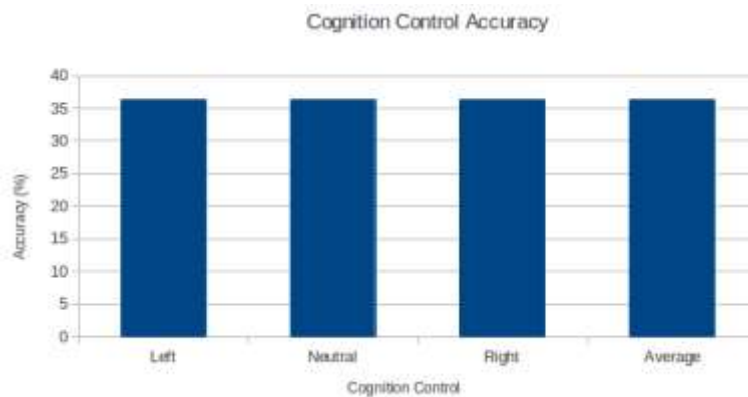

**FIGURE 33: BAR CHART OF THE COGNITIVE MODE CONTROL EXPERIMENT RESULTS**

The results show within an action set of three commands, the accuracy is about 35%. The low accuracy shows that sending command through EEG signal is not a reliable way for controlling purpose. In addition to the accuracy, the time spend to generate a signal for a certain action is also not fast enough for controlling a wheelchair.

#### 5.2.1.3. Affective Control:

In the affective control mode, several signals, such as broadness, excitement can be detected by EPOC as presented in the SDK application in Figure 34. However because there are not enough recognizable commands for basic control the navigation, and it is consider not a very good controls signal reply on user's emotion. So, no further experiments are conducted for investigation of validity of affective mode control accuracy.



FIGURE 34: AN EXAMPLE OF AFFECTIVE CONTROL SDK APPLICATION

#### 5.2.1.4. Comparison Among the Three Control Methods:

Based on the experiments of different mode controls, the expressive mode is selected among three control modes for the control interface. The following criteria are considered most desired for the project purpose.

- Time cost for user to generate recognizable signals, e.g., how long does it take to issue a “go forward” command to the wheelchair.
- Ability to assign multiple commands, such as “go forward”, “go backward”, “go left”, “go right”, “stop”, “pause/resume”, etc.
- Accuracy for repeatable commands.
- Easiness for the user to generate the same signal for control purposes. e.g., can the user generate the same signal as trained the next day, or does he have to be trained again to generate the same signal.

Summarizing the experiment results into Table 6, expression method is selected for the control purpose because of the relatively high accuracy and less time cost on recognition.

<b>Control mode</b>	Time cost for recognition	5 commands available	Accuracy For 5 commands	Easiness
<b>Expression</b>	1s~3s	YES	> 70%	Easy
<b>Cognition</b>	>20s	YES	~ 35%	Hard
<b>Affection</b>	N/A	NO	N/A	Hard

TABLE 6: USABILITIES COMPARISON OF THREE CONTROL METHODS USING EPOC EMOTIV

### 5.3. Control Interface Software Architecture.

The project developed several control interfaces, including voice, EMG, and Mechanical joystick adapter. They co-exist in the same system with the conventional wheelchair controls such as joystick. Figure 35 shows the software structure. It is designed to be an open architecture so that new interfaces and applications can be integrated into the system through ROS standard communication protocols as a ROS Publisher. A direction command can be send out from any interface publisher to the ROS topics. ROS subscribers such as voice feedback and motor controller can listen to the desired topics to see if any command message is published.

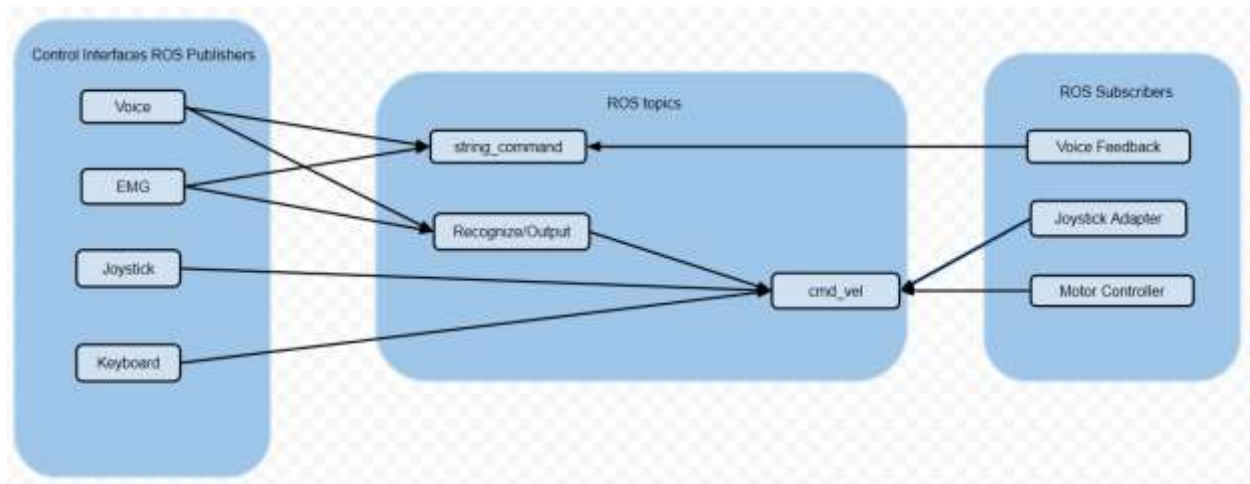

FIGURE 35: CONTROL INTERFACE SOFTWARE ARCHITECTURE DESIGN

## 5.4. Back Rack

The Back Rack design was successful in achieving the desired goals, however there were some unforeseen issues. It was able to support the desired 30 lbs. It provided a high mounting place, free of interference, for the Kinect, LIDAR, and camera. There is a large number of possibilities on ways to mount onto the back rack due to 80/20 screw and washer mounting anywhere along the extrusion, so future expansion and component mounting will be easier. The fully assembled and mounted Back Rack can be seen in Figure 36.



**FIGURE 36: BACK RACK WITH MOUNTED COMPONENTS**

The first issue comes from its design and the mounting brackets originally provided. The connection between the two sections of the Back Rack was only locked in two dimensions, allowing it to spin. This was later solved by adding additional brackets to lock both sections together more securely and to limit mobility of both sections.

The second issue is the price for production. The Back Rack cost nearly 300 dollars, over 10% of the price of a new wheelchair of the same model currently being used in the project as

listed on Amazon. It serves its purpose for the research project where things may need to be moved and tested on different spots and nothing is finalized. But for a finished product it would be advantageous to look into alternative materials. A custom build square aluminum tubing frame, or wooden frame, could very well prove to be just as reliable and much cheaper.

## 5.5. Casings

The original casings were made from acrylic, a plastic material. In these revisions the material was switched from acrylic to plywood, this change brought along several advantages. Plywood, unlike acrylic, is biodegradable and recyclable, causing a smaller impact in the environment. Plywood is also cheaper, and more readily available, 6mm can be found at most hardware stores while 3mm can be found at hobby or arts and crafts stores.

### 5.5.1. Sensor Casings

The sensor casings were successful in achieving the desired functionality. Sensor could now be removed from their casings by unscrewing the sensor casing lid. They also saw next to no ability to move while inside of the casing with the spacers present. Some differences, such as the free sensor wire, can be seen between the original and the newer model of IR sensor casings in Figure 37.



**FIGURE 37: LEFT- OLD VERSION OF IR SENSOR CASING, RIGHT – NEW VERSION OF IR SENSOR CASING**

There was an unforeseen issue with the US sensor casing design. Due to the screw holes being on the diagonal and the wall joints being symmetrical, the bottom plate can be assembled backwards, causing the casing to be unusable. As can be seen in Figure 38 the top section of the bottom plate was labeled “UP” before assembly as to avoid errors.

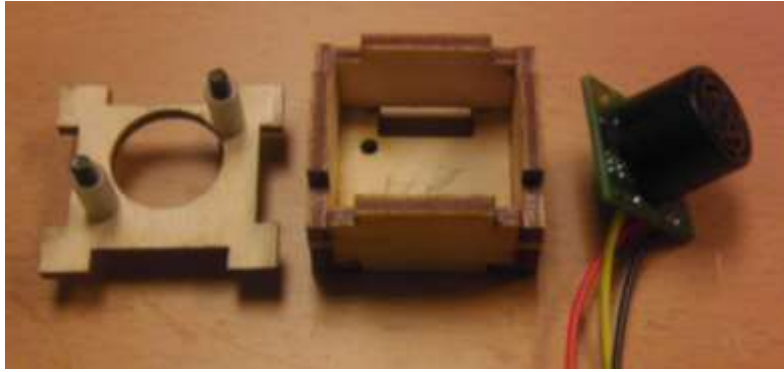

**FIGURE 38: DISASSEMBLE ULTRASONIC SENSOR CASING WITH “UP” LABEL ON BOTTOM PLATE**

### 5.5.2. Sensor Board Casing

The sensor board casing designed achieved all of preset goals. A small design change was made to the lid to allow the power wire for the boards to hang outside. By extending the length of the casing the USB interface board was no longer being pushed to the point of bending its pins. The hole which allowed for the USB to be plugged in also saw a significant size reduction, so that only the USB port, and not the board would, protrude. The lid holes for the sensor ports were widened to allow for easier access, Figure 39 show this. After the introduction of extension cords to the sensor ports it was decided that by adding them to the board and leaving them label it would provide easier access to the board, meaning the only reason someone would attempt to service the board is if something was wrong with the board itself.

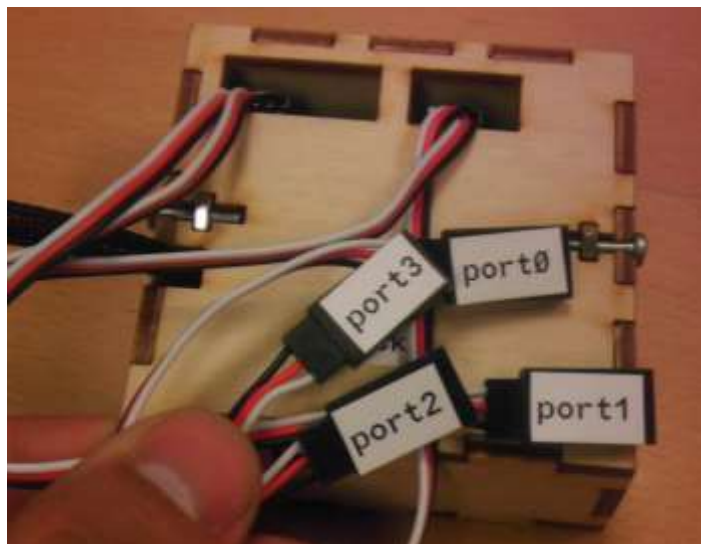

**FIGURE 39: SENSOR BOARD CASING WITH LABELED WIRES**



### 5.5.3. Motor Controller Casing

The motor controller casing design also achieved its goals. It provided protection for the motor controller, covered as much of it as possible while still allowing easy access to all its ports. Its final design also allowed for the back plate to be in contact with the air. Figure 40 shows the Motor Controller Casing in place on the wheelchair.



**FIGURE 40: MOTOR CONTROLLER CASING MOUNTED ON WHEELCHAIR**

## 5.6. Joystick Interface

The joystick interface design was successful in manipulating the joystick to the desired position without any modification to the original system it was fastened to. Some minor issues surfaced with the low quality 3D printing used, they were resolved by minor work involving sanding or drilling the issue spots. Separating complicated parts into smaller components meant to be 3D printed also proved to be a valuable decision in the production of this prototype, shown in Figure 41.



**FIGURE 41: JOYSTICK MANIPULATOR**

By using both ROS library for Arduino and ROS Serial communications was easily established with the computer. Testing was done using `teleop_twist_keyboard` node, the same one used during wheelchair operations where the keyboard is used to operate the wheelchair. The Arduino was able to listen to the `cmd_vel` topic, to acquire the desired  $x$  and angular velocity, published by the `teleop_twist_keyboard` node assuming the desired position. For further verification the Arduino also published a topic called `chatter`, this was monitored to ensure the desired angle of the system was being achieved. During the testing a connection issue was noted using the ROS serial package. The Arduino would lose connection several times a minute, making the connection unstable and unusable. This could be attributed to the Arduino ROS library and the ROS used being different version.

## 5.7. Multiple User Interfaces Wheelchair Test

Based on the control interfaces developed during the project, the current team conducted multiple tests with different user interface control, including EMG and voice. Motion commands send out by the user through both interfaces. Then they are executed by the wheelchair. As demonstrated in Figure 42 and Figure 43, the user is using EMG interface to control the wheelchair to go straight and turn left. The user is trained in advance for several expressions commands, such as raising eye brow for stopping, looking left or right to control the driving direction. The test on controllability of EMG user interface shows that basic motion operation control through the EMG

headset is reliable and the EMG user interface can help people with limb disability to perform certain control actions of assistant equipment such as powered wheelchairs. Figure 44 and Figure 45 shows the controlling of wheelchair by voice commands. The user was able to move the wheelchair in a straight line as well as turning.



**FIGURE 42: EMG CONTROL GOING FORWARD**



**FIGURE 43: EMG CONTROL TURNING LEFT**



**FIGURE 44: VOICE CONTROL GOING FORWARD**



**FIGURE 45: VOICE CONTROL TURNING LEFT**

## 6. Discussion

This section discusses about the control interfaces and their solutions. It also provides some suggestions for future development of the project.

### 6.1. Improving the Accuracy of Speech Recognition

If the accuracy of speech recognition is low, it is recommended to check the microphone and sound setting first. The accuracy may not be ideal even with high quality voice recording. This is because the vocabulary of the language model defines only one pronunciation for each word or phrase, but each individual might have different pronunciation, this is specially the case with accents. Luckily, CMUSphinx wiki [12] has provided the following instructions for improving the accuracy of Sphinx recognizer for different circumstances and needs.

#### 6.1.1. Adapting the Default Acoustic Model:

If the accuracy falls when using different recording environments, or when speaking in a different accent, acoustic model adaptation can be used. The adaptation improves the fit between the adaptation data and the model, so it works well in specific configuration of user's environment and accent. [12]

Detailed instructions for doing simple acoustic model adaptation can be found at:

<http://cmusphinx.sourceforge.net/wiki/tutorialadapt>

#### 6.1.2. Training Acoustic Model for CMUSphinx:

If an acoustic model for new language/dialect or a specialized model for small vocabulary application needs to be created, adaptation with the current won't work. Instead, training your own model for the CMUSphinx speech recognition engine is recommended. [12]

Data preparations and instructions can be found at:

<http://cmusphinx.sourceforge.net/wiki/tutorialam>

### 6.1.3. Building Language Model:

The recognizer takes input of two types of models that describe language - grammars and statistical language models. [12] When users feel the need of building new grammars and statistical language models, they can follow the instructions at:

<http://cmusphinx.sourceforge.net/wiki/tutoriallm>

## 6.2. EMG Control Accuracy Discussion

When conducting the experiment or driving the wheelchair involving EMG or EEG signals, the user need to make sure that the signals for the pads have good quality as displayed in Figure 46.

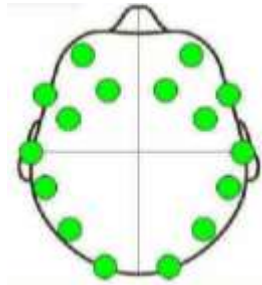

FIGURE 46: A GOOD HEAD SENSOR SIGNAL STRENGTH

Different colors of the sensor pads indicates the strength of the signal as presented in Table 7. Keeping at least 10 out of 14 pads green will help to generate a good control results.

Black	no signal
Red	Very poor signal
Orange	Poor signal
Yellow	Fair signal
Green	Good signal

TABLE 7: DIFFERENT COLORS INDICATE DIFFERENT SIGNAL STRENGTH

In order to guarantee a safe drive, a pre-driving accuracy test program is implemented. The pre-run test diagram is shown in Figure 47. Each time before operation on the wheelchair using EMG control, the operators should do a pre-driving accuracy routing test to make sure the

commands can be send successfully. The following chart explains the implementation of this ROS node.

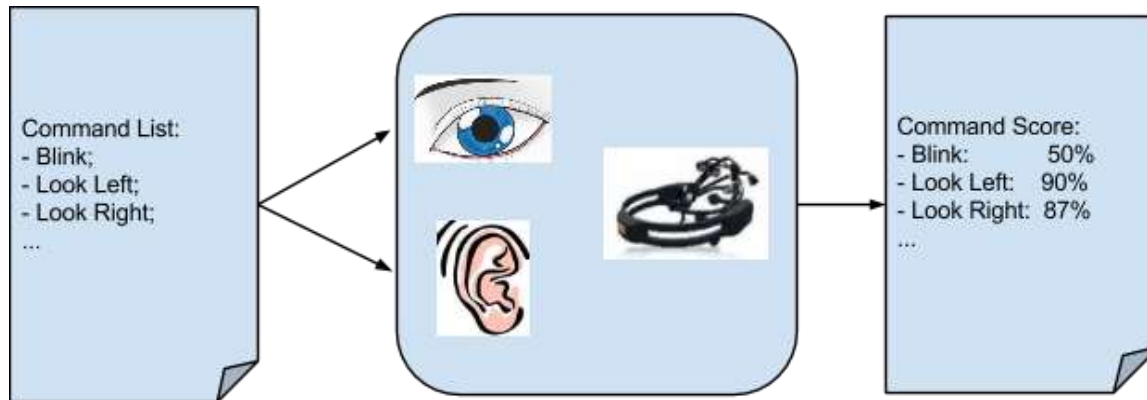

FIGURE 47: PRE-RUN TEST

The operators are able to define a list of expressive actions in a parameter file for the ROS node to read. This list will be performed by the operators one by one. The action will be send to the operators both by printing on the screens and pronounced through the speakers so that different disability can take the most advantages out of the test program. At the same time, there's a time filter applied for each action test. It will start record the time from the moment the actions are sent. If the user failed to perform the action within a user defined time interval, the action will be hold as a miss. It leads to a score as a results.

The score is calculated by the following equation:

$$\text{Command Score} = \frac{\text{successfully perform times}}{\text{command sent times}} * 100\%$$

If the scores for the navigation command are over 70%, it's relatively safe for the operators to drive on it. Otherwise, adjust the headset position and check the signal to retry the test until qualified.

## 6.3.Future Work

This section lists several possible improvements and features that can be implemented based on the current development status.

### 6.3.1. Back Rack

Further work can be done to improve the Back Rack. Adding functionality to allow the top section of the back rack to retract would further improve its end product purpose allowing it to fit into civilian vehicles. Adding an actuated tilt mechanism, to allow for back and forth motion required for 3D mapping, to the LIDAR would also improve the mapping capabilities of the wheelchair.

### 6.3.2. Sensor Board Casing

The sensor board casing could be further improved by making all sensor cables flow through a single hole. By doing so it would allow for easier cable management.

### 6.3.3. Joystick Control

Future research on adaptive control system can be done using this mechanism. Developing a control system for the Joystick Interface that allows it to be installed into a random wheelchair and adjust to how the wheelchair behaves.

Further testing on the stability of ROS Serial should also be considered. In its current state it is very unstable and almost unusable for practical purposes.

### 6.3.4. Voice and EMG Control Interface Accuracy Improvement

Based on the data collected through the user history, a more intelligent command predictor is possible to be used to improve the accuracy of voice and EMG control interface accuracy. When an unfamiliar or a less possible command is received by the predictor, it will remind or asked the user again to confirm. At the same time, it can “learn” the new command and the situation it is used to increase the possibility of the command and to generate a more accuracy prediction.

A Graphic User Interface would be very helpful for the developers and users to visualize the details including the prediction and parameter setting.

## 7. Conclusion

Through the implementation of the wheelchair's range sensor system, the assistive control is able to fully utilize the modular sensor system for navigation indoor environment. It provides a universal laser scan interface to enable different ROS packages to use the sensor data information. Many improvements were made to the mechanical aspects of the project, further mechanical analysis can be done to improve the stability of the Back Rack. The Joystick control interface works but further testing is required to assess its usability and reliability. Through accuracy tests on different user interfaces such as EMG and voice, the current team shows the EMG and voice control on a powered wheelchair is feasible and reliable. The performance of the final implementations of multiple control interfaces through EMG and voice recognitions proved that a multiple user interface controlled wheelchair is dependable and such user interfaces have the potential to benefit more people with different levels of disabilities in their daily life.



## References

- [1] "EPOC Emotiv," [Online]. Available: <http://emotiv.com/>.
- [2] "MindWave," [Online]. Available: <http://store.neurosky.com/products/mindwave-1>.
- [3] "Wiki," [Online]. Available: <http://www.apparelyzed.com/quadruplegia-quadruplegic.html>. [Accessed 27 1 2014].
- [4] Georgia Institute of Technology, "GT | News Center - Tongue Drive Wheelchair," Georgia Institute of Technology, December 2013. [Online]. Available: <http://stm.sciencemag.org/content/5/213/213ra166>. [Accessed 27 1 2014].
- [5] "MIT adds robotics, voice control to wheelchair," Mass High Tech, 19 September 2008. [Online]. Available: <http://www.bizjournals.com/boston/blog/mass-high-tech/>.
- [6] MIT, "Intelligent Wheelchair Project at MIT," [Online]. Available: <http://rvsn.csail.mit.edu/wheelchair/>.
- [7] R. C. Simpson, "Smart Wheelchairs: A Literature Review," *Journal of Rehabilitation Research & Development*, vol. 42, p. 423, 2005.
- [8] M. Brain, "How Stuff Works," [Online]. Available: <http://health.howstuffworks.com/medicine/healthcare/shepherd-center5.htm>. [Accessed 27 January 2014].
- [9] D. Purwanto, R. Mardiyanto and K. Arai, "Electric wheelchair control with gaze direction and eye blinking," *Artif Life Robotics*, 2009.
- [10] Puzzlebox Brainstorms, [Online]. Available: <http://brainstorms.puzzlebox.info/>. [Accessed 27 1 2014].
- [11] Puzzlebox, [Online]. Available: <http://www.emotiv.com/ideas/brain-controlled-wheelchair-6.html>. [Accessed 27 1 2014].
- [12] "CMUSphinx wiki, Open Source Toolkit For Speech Recognition," Carnegie Mellon University. [Online].
- [13] T. C. f. S. T. Research, "The Festival Speech Synthesis System," The University of Edinburgh, [Online]. Available: <http://www.cstr.ed.ac.uk/projects/festival/>.
- [14] "pocketsphinx-ROS Wiki," [Online]. Available: <http://wiki.ros.org/pocketsphinx>.
- [15] R. P. Goebel, "A Do-It-Yourself Guide to the Robot Operating System," in *Ros By Example*, 2013.
- [16] "sound\_play-ROS Wiki," [Online]. Available: [http://wiki.ros.org/sound\\_play](http://wiki.ros.org/sound_play).

- [17] P. Konrad, "The ABC of EMG - A Practical Introduction to Kinesiological Electromyography (Version 1.0)," April 2005, p. 7.
- [18] NASA, [Online]. Available: [http://www.nasa.gov/centers/ames/research/technology-onepagere/human\\_senses.html](http://www.nasa.gov/centers/ames/research/technology-onepagere/human_senses.html). [Accessed 30 1 2014].
- [19] "mindwave," [Online]. Available: <http://store.neurosky.com/products/mindwave-mobile>. [Accessed 28 1 2014].
- [20] Ibrain-device. [Online]. Available: <http://neurovigil.com/index.php/technology/ibrain-device>. [Accessed 28 1 2014].
- [21] "Epoc Emotiv," [Online]. Available: <http://emotiv.com/>. [Accessed 28 1 2014].
- [22] US Environmental Protection Agency, "Plastic Common Waste & Materials | US EPA," United States Environmental Protection Agency, [Online]. Available: <http://www.epa.gov/osw/conservation/materials/plastics.htm>. [Accessed 28 January 2014].
- [23] sharpsma, [Online]. Available: [http://www.sharpsma.com/webfm\\_send/1489](http://www.sharpsma.com/webfm_send/1489). [Accessed 28 1 2014].
- [24] sparkfun, [Online]. Available: <https://www.sparkfun.com/products/8502>. [Accessed 28 1 2014].
- [25] M. L. Resnick and D. B. Chaffin, "An ergonomic evaluation of handle height and load in maximal and submaximal cart pushing," *Applied Ergonomics*, vol. 26, no. 3, pp. 173-178, 1995.
- [26] M. Lang, "Investigating the Emotiv EPOC for cognitive control in limited training time," 2012, p. 16.
- [27] emotiv, [Online]. Available: [http://emotiv.com/eeg/download\\_specs.php](http://emotiv.com/eeg/download_specs.php). [Accessed 28 1 2014].
- [28] *SONY Wireless Microphone Operating Instructions*.
- [29] "UE Mini Boom Tech Specs," [Online]. Available: <http://www.ultimateears.com/en-us/mini-boom>.

## Appendices

### Appendix A: Technical Documentation

1. Device Specification:
  - 1.1 EPOC EMOTIV: [27]

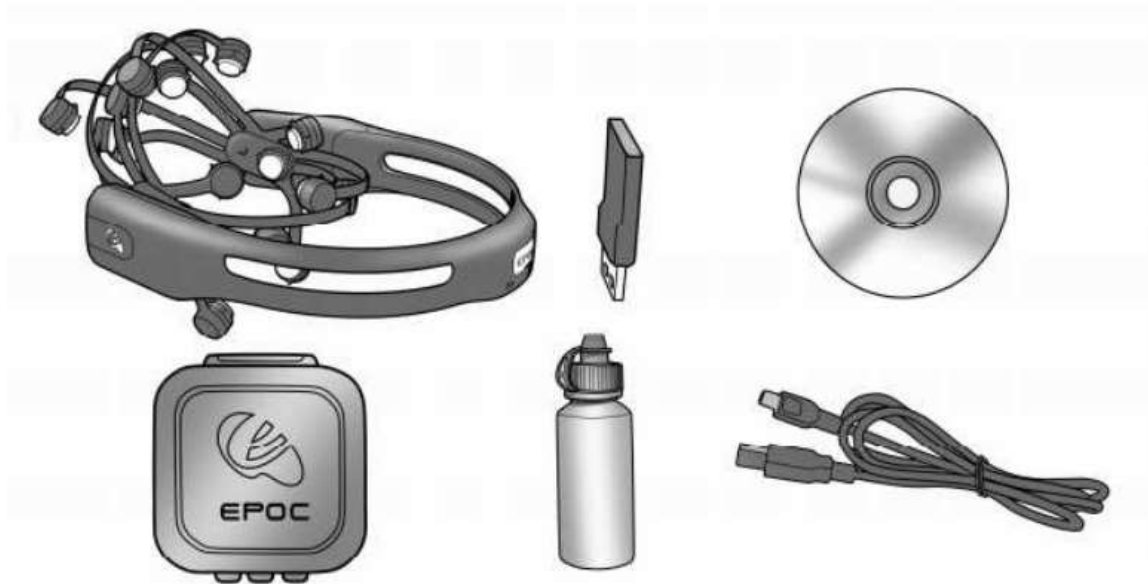

FIGURE 48: COMPONENT OF EPOC EMOTIV [27]

#### Key specifications

Number of channels 14 (plus CMS/DRL references, P3/P4 locations)

Channel names (International 10-20 locations) : AF3, F7, F3, FC5, T7, P7, O1, O2, P8,  
T8, FC6, F4, F8, AF4

Sampling method: Sequential sampling. Single ADC

Sampling rate: 128 SPS (2048 Hz internal)

Resolution: 14 bits 1 LSB =  $0.51\mu\text{V}$  (16 bit ADC, 2 bits instrumental noise floor discarded)

Bandwidth: 0.2 - 45Hz, digital notch filters at 50Hz and 60Hz

Filtering: Built in digital 5th order Sinc filter

Dynamic range (input referred):  $8400\mu\text{V}$  (pp)

Coupling mode: AC coupled

Connectivity: Proprietary wireless, 2.4GHz band

Power: LiPoly

Battery life (typical): 12 hours

Impedance Measurement: Real-time contact quality using patented system

## 1.2 SONY ECM-AW3 BLUETOOTH MICROPHONE

### **Key specifications** [28]

Communication system: Bluetooth specification Ver. 2.0

Working range: Up to 50m(150ft.)

Standby time(microphone): Approx. 9 hours

Standby time(receiver): Approx. 3 hours

Microphone/receiver system: Monaural, non-directional

Power requirements: 1.5 V AAA battery

Frequency response: 300 - 9000 Hz

Continuous operating time: Approx. 3 hours

## 1.3 THE LOGITECH UE MOBILE BOOMBOX

### **Key specifications** [29]

Maximum Sound level SPL = 86dBC

Frequency Range = 130 Hz - 20 kHz

Drivers = Two 1.5", 4 Ohm Drivers; One 3" x 1.5" Passive Radiator  
Rechargeable Lithium-Ion Battery for up to 10 hours of battery life.

Charge time: 3.8 hours

Mobile range of play is up to 15m (50 ft).

## 1.4 ULTRASONIC RANGE FINDER - MAXBOTIX LV-EZ0:

### **Key specifications** [24]

42kHz Ultrasonic sensor

Operates from 2.5-5.5V

Low 2mA supply current

20Hz reading rate

RS232 Serial Output - 9600bps

Analog Output - 10mV/inch

PWM Output - 147uS/inch

Small, light weight module

#### 1.5 GP2Y0A21YK0F IR SENSOR:

##### **Key specifications** [23]

Distance measuring range : 10 to 80 cm

Analog output type

Package size : 29.5×13×13.5 mm

Consumption current : Typ. 30 mA

Supply voltage : 4.5 to 5.5 V

#### 2. CAD Drawings for Cases:

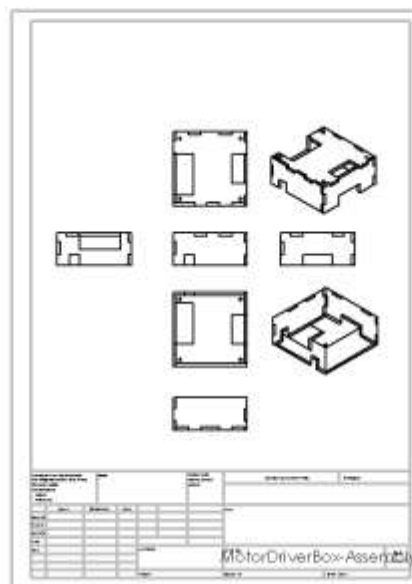

**FIGURE 49: MOTOR DRIVER CASE**

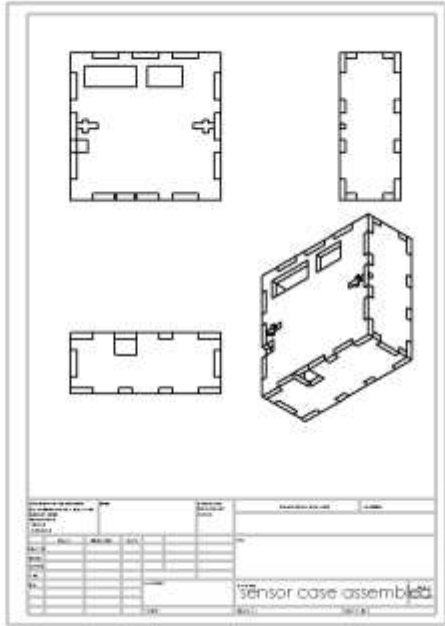

**FIGURE 50: SENSOR BOARD CASE**

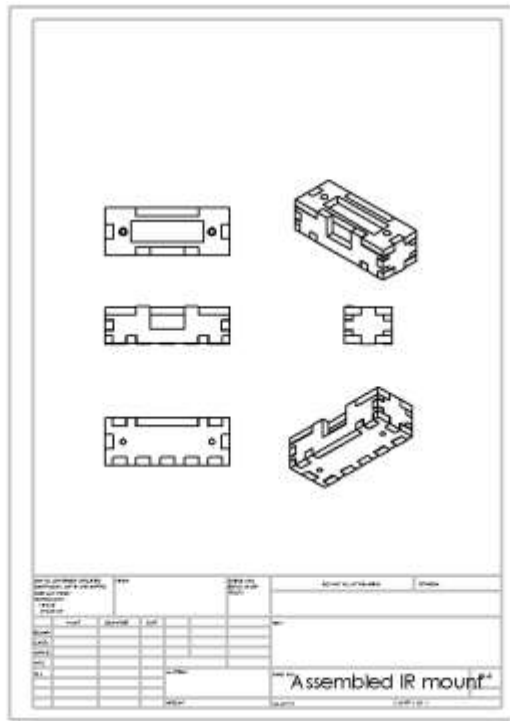

**FIGURE 51: IR SENSOR CASE**

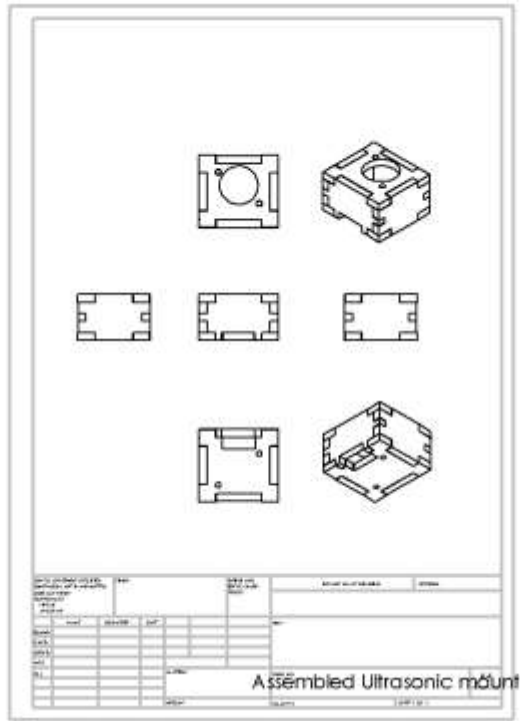

FIGURE 52: ULTRASONIC RANGE SENSOR CASE