

The Virtual Tour

Interactive Qualifying Project

Submitted to the Faculty

of the

Worcester Polytechnic Institute

in partial fulfillment of the requirements for graduation

by

Runzi Gao

Kai He

Seth Lipkind

Elizabeth Mayor

Justin McLaughlin

Professor Jeffrey L. Forgeng, Major Advisor

Abstract

This project integrated technology and history to transform the visitor experience at the Higgins Armory Museum. The team upgraded the museum's "Virtual Armory" website, creating a Virtual Tour with interactive and multimedia content for over a dozen pieces in the Higgins collection, including videos, animations, interactive graphics, and a Flash-based minigame. The team also implemented pilot QR code technology, allowing museum visitors to access Virtual Armory content onsite using their smartphones.

Table of Contents

Abstract.....	iii
Authorship	1
About the Authours.....	4
Introduction.....	6
Background Research	12
Two handed swords	12
Bearing Swords.....	13
Two-handed sword (“Zweihander”).....	14
Staff Weapons.....	16
'Maximilian' Field Armor with a visor for ceremony and tournament	19
Target (shield) with breech- loading gun.....	22
Matchlock Musket	25
The Halberd of the Trained Band	30
The Sword of Justice.....	34
Helmet of the Gladiator	42
Nandaka	47
Armor from a Garniture.....	51
Turkish Grouping.....	55
Medieval European Sword History.....	59

Sword	61
Boarding Sword,	63
Smallsword	67
Japanese Swords	70
Folding Spetum.....	76
Jamadhar	80
Breast plate from siege cuirass	85
Bronze swords.....	90
Appendix A: Matchlock Musket.....	101
Appendix B: War hammer	102
Appendix C: Sword of justice.....	103
Appendix D: Halberd of the Trained Band.....	104
Appendix E: Gladiator	105
Appendix F- Nandaka	107
Appendix G - Siege Breastplate.....	108
Appendix H - Bronze Sword.....	110
Appendix I : Jamadhar	112
Appendix J: Folding Spetum	115
Appendix K: Mini Game	116
Appendix L - The Virtual Tour manual.....	119

The Format.....	119
Troubleshooting	120
Appendix M - Spirit of the Katana	121
Appendix N: QR Code Template.....	124
Appendix O: 3D Scan to 3D pdf Workflow	125
Appendix P – Generating QR Codes	126
Appendix Q - Survey Questions	127
Bibliography	128

Authorship

Abstract-Kai He, Runzi Gao, Elizabeth Mayor, Justin Mclaughlin, Seth Lipkind

Introduction-Kai He, Runzi Gao, Elizabeth Mayor, Justin Mclaughlin, Seth Lipkind

Background Research

Two handed swords-Runzi Gao

Bearing Swords-Runzi Gao

Two-handed sword (“Zweihaender”)-Runzi Gao

Staff Weapons-Runzi Gao

'Maximilian' Field Armor with a visor for ceremony and tournament-Runzi Gao

Target (shield) with breech- loading gun-Runzi Gao

Matchlock Musket-Justin Mclaughlin

The Halberd of the Trained Band-Justin Mclaughlin

The Sword of Justice-Justin Mclaughlin

Helmet of the Gladiator-Seth Lipkind

Nandaka-Seth Lipkind

Armor from a Garniture- Seth Lipkind

Turkish Grouping-Seth Lipkind

Medieval European Sword History-Kai He

Sword-Kai He

Boarding Sword-Kai He

Smallsword-Kai He

Japanese Swords-Kai He

Folding Spetum-Elizabeth Maayor

Jamadhar-Elizabeth Mayor

Breast plate from siege cuirass-Elizabeth Mayor

Bronze swords-Elizabeth Mayor

Appendix A: Matchlock Musket-Justin Mclaughlin

Appendix B: War hammer-Justin Mclaughlin

Appendix C: Sword of justice-Justin Mclaughlin

Appendix D: Halberd of the Trained Band-Justin Mclaughlin

Appendix E: Gladiator-Seth Lipkind

Appendix F- Nandaka-Seth Lipkind

Appendix G - Siege Breastplate-Elizabeth Mayor

Appendix H - Bronze Sword-Elizabeth Mayor

Appendix I : Jamadhar-Elizabeth Mayor

Appendix J: Folding Spetum-Elizabeth Mayor

Appendix K: Mini Game-Runzi Gao

Appendix L - The Virtual Tour manual-Seth Lipkind, Elizabeth Mayor

The Format

Troubleshooting

Appendix M - Spirit of the Katana-Kai He

Appendix N: QR Code Template-Kai He

Appendix O: 3D Scan to 3D pdf Workflow-Kai He

Appendix P – Generating QR Codes-Runzi Gao

Appendix Q - Survey Questions- Kai He, Runzi Gao, Elizabeth Mayor, Justin Mclaughlin,

Seth Lipkind

Bibliography- Kai He, Runzi Gao, Elizabeth Mayor, Justin Mclaughlin, Seth Lipkind

About the Authours



Beth Mayor

Beth Mayor is a Biomedical Engineering Major from WPI. She specializes in Tissue Engineering and hopes to pursue a PhD in the area in the future. History has always been an interest of Beth's and bringing together history and technology for the Virtual armory website proved an exciting and challenging project. She is a brother of Alpha Phi Omega community service fraternity and involved in the Society of Women Engineers, and Engineering World Health.

Justin McLaughlin

I am Justin McLaughlin; I am a chemical engineer at WPI. I have always liked the idea of working on something that is going to have a practical application in this world. I felt that the web site and content that we developed as a group will help people in learning about the artifacts in the museum in a new and interesting way.

Seth Lipkind

I am Seth Lipkind, and I am a Robotics Engineering Major from WPI. I am a brother of Alpha Phi Omega, the community service fraternity at WPI. I have always liked working with

technology, and learning about arms and armor, so this project was very exciting for me. Over the past several years, I have earned the nickname “The Hammer”. I feel that “The Hammer” was brought down on this project, and we were able to create a successful beginning to a great website.

Kai He

I’m Kai He, an Interactive Media and Game Development Art student at Worcester Polytechnic Institute. A friend of mine once told me: “People never draw others. They have always been drawing themselves, from the moment they hold their pens.” I think that is why I want to be an artist. Even if it's the same copy, different artists deliver different feelings. The best thing of all, a picture can capture all the drama and emotion of a specific moment that it seems to almost freeze time. By spending my time with art and growing up, I begin to see more and more from the world around me, and also know more and more about myself. One day, I hope when people look at my works, something in my art will touch their hearts.

Runzi Gao

Runzi (Jack) Gao is currently an undergrad at Worcester Polytechnic Institute (WPI) double major in Interactive Media & Game Development (IMGD) and Robotics Engineering. When getting out of the labs where he builds mobile robots and develop video games, he becomes a complete sports guy. He enjoys playing all kinds of sports that you could possibly think of. He also loves arms and armors and he is excited about developing technology in the armory museum.

Introduction

The Higgins Armory Museum's superb collection of arms and armor gives patrons a unique experience of weaponry of many eras from around the world. Engaging patrons in the collection is critical to ensuring that their experience at the museum is entertaining, vibrant, and educational. A dynamic and interactive experience will help visitors achieve full immersion in the subject matter. Onsite demonstrations, video content, and interactive games, as well as a dedicated website provide a fantastic platform for creating these experiences. This team created an in-depth online experience, "The Virtual Tour", a novel way for visitors to explore and discover the Higgins Armory collection. The Virtual Tour is a collection of many types of web content, audio, video, text, and interactive media that are tailored to specific items on display at



Figure 1: The Homepage of the Virtual Tour

the Higgins Armory Museum. The Virtual Tour is easily navigated from the web, and through the use of smartphones and the QR codes, the content will be directly available to patrons from within the Higgins Armory Museum. This format provides a foundation for integrating the internet and the collection, and immersing patrons into the history of the Higgins Armory Museum.

The Higgins Armory contains over 5600 pieces; we have chosen to research a few selected pieces to represent the entire collection. The museum holds quite a few pieces about the evolution of European armor. This part of the collection is shown mostly in the great hall,

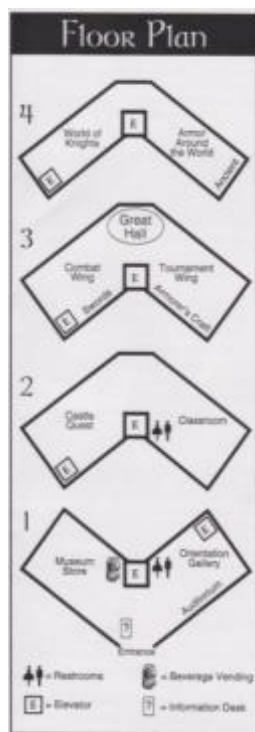

Figure 2: Floorplan of the Higgins Armory

and presents the arms race of the middle ages, and how armor was forced to change due to the evolution of western warfare. There are also quite a few pieces from other cultures around the world. These include areas such as the Ottoman Empire, the Congo region, and Japan. These items are displayed in the museum along with other areas such as the Tournament Wing, and World of Knights. In The Virtual Tour we highlight the variety of the collection and emphasize as many areas of the Higgins Armory as possible.

The Armory has been integrating a web presence with their physical museum since the 1990's. A web presence for the Armory allows them to reach out to new audiences. A website can be easily found through a simple search and increases the Museum's visibility. The official Higgins Armory Website contains not only important information such as hours and location but also valuable information about the collection. Information like this can entice new visitors, and pique interest in the Higgins Armory Museum. In order to create more awareness of the Higgins Armory collection and to give visitors more information about the pieces on display, a multitude of IQP teams over the past decade have been working with the Higgins Armory to develop new web content. Much of that content has found a home on "the Virtual Armory", a website designed by an IQP team in 2010-11 that focuses specifically on housing web content for the Higgins Armory that is informative and entertaining,



Figure 3: Interactive 3D model of a Katana, web content on the Virtual Tour

and created by IQP teams, but it is not yet integrated with the official Higgins Armory website.



Figure 4: IQP team web content from 2001, now featured in the Virtual Tour

can also create a wide range of content that is interactive or passive, and incorporates audio, visual and text. These different types of content appeal to diverse learning styles and can help better explain the history of arms and armor to many patrons. Through this format we are able to interest people in visiting the museum to see firsthand the arms and armor they learned about in the Virtual Tour. It also allows people who can't visit the museum to take a virtual tour.

The Virtual Tour currently consists of nine categories of arms and armor: Ancient, Armor, Swords and Daggers, Asian, Islamic, African, Unusual, Ranged Weapons, and Staff Weapons. These categories each contain subpages; each subpage is dedicated to a very specific topic, generally a specific item in the collection. There is a wide variety of content types showcasing the versatility of the Virtual Tour platform. There are currently 14 different subpages in total most of which were generated by our team (see Appendices for documentation).

We focused on creating a “Virtual Tour” a subpage on the Virtual Armory website that can be used to house a wide variety of web content in an easy-to-navigate format. In a web-based platform we

The Virtual Tour has a secondary purpose aside from increased web presence; it links online and physical visits to the Armory through QR code technology. We used QR code technology to allow visitors to access media associated with 4 select pieces within the Armory. Each code links to a different piece of media on the Virtual Tour webpage. Codes were placed near the relevant pieces and can be scanned by any visitor who owns a smart phone with access to the Internet. QR codes provide a novel method for the museum to reach out to its patrons because they allow visitors to choose what pieces they would like to know more about and which they would like to pass over. QR codes were fairly easy to create. With many free QR Code Generators that are available online, we can generate the QR codes for our web-based content free of cost.

The usage of QR codes is expanding in the US with the increase of smart phones. During the month of June 2011, according to one study, 14 million mobile users scanned a QR code or a barcode. QR code reader software is available for most mobile platforms, which includes Google Android, Nokia Symbian, Apple iOS, BlackBerry devices and Windows phone 7. That means most smart phones with cameras are able to read the QR code. According to an early 2010 study by ComScore, over 45.5 million people in the United States owned smart phones out of 234



Scan with your smart phone for audio content.

The Higgins Armory, in conjunction with a student team from Worcester Polytechnic Institute, is developing a QR Code system for delivering online content for museum visitors. We'd welcome your feedback as we experiment with the technology!

HAM 2630

Figure 5: Sample QR code with instructions for within the Armory

million total subscribers. So we can roughly expect that about 20% of the visitors to the museum have access to a smart phone which would allow them to scan our QR codes. Piloting a QR program at the Armory as QR codes are growing in popularity means that we have a fully developed program once QR codes reach the peak of their popularity.



Figure 6 - A 3D scan of the Bronze Spearhead

The team also investigated the new 3D scanning technology using the NextEngine 3D Scanner. We were able to capture data using the scanner and create 3D models that highly resembled the actual artifacts. We were also able to convert 3D models into 3D pdf files that can be easily distributed through the Internet and

viewed by anyone with Adobe Reader. However, we did encounter various problems using the 3D scanner. Due to the nature of the scanner (it could only scan one side of the artifact at a time) and range limitations, so far we only successfully scanned rather small artifacts. The one artifact that was successfully scanned and added to the Virtual Tour was the bronze spearhead.

The Virtual Tour contains videos, standard text and image webpages, slideshows, interactive images, and games. The current QR codes link to the standard text and image webpages and videos because those are most compatible with a handheld platform. All of the other content is fully available through the website. Adding new content to the site is a low-difficulty procedure so future teams can easily develop their own content for the Virtual



Figure 7 A flash game on the Virtual Tour A Knight and His Arms

Tour, and generate their own QR codes for their content. Through the Virtual Tour platform, the experience of a visit to the Higgins Armory could be at once a fully digital and tangible and totally engross visitors in their adventure in the Museum.

Background Research

Two handed swords

By the middle of the 13th century, the grip of the sword had been extended so it could now be held with both hands. (North 1982) But the Two-handed Sword was really an invention of the 14th century. And it formed one of them ordinary weapons of the foot soldier. (Ashdown 1967) The two-handed sword was a specialized and effective infantry weapon, and was recognized as such in the fifteenth and sixteenth centuries. Although large, measuring 60-70 inch overall, it was not as hefty as it looked, weighing something of the order of 5-8 lbs. (Coe et al, p. 48)

While the ordinary one-hand swords were of limited effectiveness against an opponent in plate armor, so those two-handed were developed to deal with armored soldiers through sheer power. Employed by specially trained professional infantry, those two-handed swords were used to force gaps in the ranks of enemy troops. The Swordsman, usually reinforced by halberdiers or similar hafted- weapon-wielding troops, were followed by the main body of Spikemen. (Duval and Karcheski 1983)

At the beginning of the 15th century, swords came with numerous variations of the details of the pommel and cross-guard. And there began to be a new type of sword that seems to have had a longish, broad blade with a long hilt, that became good representative of the "two-handed" sword. (Wagner)

But by the time those sword was made, such swords no longer played a significant role on the battlefield, so most of them were carried for military and political display.

Bearing Swords

Accession: 1901

Passau, 1400s-1500s; hilt decorated early 1600s

The Bearing Sword from Passau which was made of steel, iron, brass, wood and velvet weighs over 14 lb. This oversized sword is a ceremonial weapon that was possibly carried by a royal bodyguard, and it was never meant for battle. Though some other large size two-hand swords were used in combats against staff weapons.

It has a very long double edged blade of hollow ground flattened hexagonal section tapering to slightly rounded tip. On both faces were the shallow, wide central fuller with 6 incised talismanic symbols retaining traces of brass inlay. Both sides of blade were decorated with traces of stamped & chiseled dots, commas, flowers, letters. One face with Passau stamps of "bishop's crosier" and "running wolf" marks, also cut into both faces of forte. The cruciform hilt come with

long straight crossguard of flattened rectangular section decorated like forte. And the long wooden grip has necked swelling at mid-height & covered in worn red velvet. It also has the stout octagonal pommel with central depression on both faces.(HAM)



Figure 9: Bearing Sword



Figure 8: The Bearing Sword on Display

Two-handed sword (“Zweihander”)

Accession Number: 2483

Germany, about 1600

This German sword made of steel, iron, modern wood, leather and fabric weighs 7lb.



Figure 10: Two Handed Sword

15oz. This is about just half of the Bearing Sword which makes it possible to use in battle.

The "Zweihander" has a steel. Long double edge blade of flattened hexagonal section, which expanded gently to triangular point. The long rectangular ricasso come with pair of pointed lugs. Its broad iron crossguard curved gently towards blade with voluted terminals and projections. It has a pair of large open side rings with trilobated, pointed and voluted projections within. And the guard is blackened with chiseled crescents & filed notches. The restored black wooden grip has 3-stage molding at mid-height. Its mushroom-shaped iron pommel, was cut into 4 vertical facets, colored & decorated to match crossguard. (HAM)

These swords represent the final stage in the trend of increasing size started in the 14th century. In its developed form, the Zweihänder (German for “Two hander”) acquired the characteristics of a polearm rather than a sword. Consequently, it was not carried in a sheath, but across the shoulder like a halberd.

The Zweihänder could be up to 6 ft long from the base of the pommel to the tip of the blade, with a 4–5 ft blade and 1–1½ ft hilt. The weight could range between 4½ and 7. However, a ceremonial Zweihänder, which was unsuitable for combat, could weigh up to 16 lb.

Swords such as these could only be used by muscular individuals fighting on foot, and they had no real place in the close press of battle. In the 15th century, men began to use them in single-

fights and in the defense of castle or town walls, and occasionally they were employed on the field of battle by picked men detailed to guard and banner. (Oakeshott 1980)

By the second half of the 16th century, these swords had largely ceased to have a practical application, though they continued to see ceremonial or symbolic use well into the 17th century.

Staff Weapons

Vouge

Accession Number: 2044

Perhaps France (Brittany), 1700s

Halberd

Accession Number: 2546.6

Italy, end of the 1500s

Kuse

Accession Number: 2479

Southern Germany, 1550-1600

The staff weapon, also known as polearm, is a generic term for weapons mounted on poles or shafts, and the handles or shafts are usually longer than the blades.

Swords were dominant through most of the Bronze Age during the course of the sixth century B.C. while the spear gained popularity as more suitable to counteract the protective effect of the newly developed shield. (Brown 1967)

Through the Middle Ages and the Renaissance, swords were the most highly regarded of all weapons. But vying with the sword for popularity was the family of staff weapons which offered a great variety of forms. (Anglo 2000)

The variety of forms of staff weapons (polearms) can be categorized to four classes:



Figure 13: Vouge

Figure 13: Halberd



Figure 13: Kuse

- 1) Polearms for thrusting.
- 2) Polearms for cutting.
- 3) Polearms for cutting and thrusting.
- 4) Polearms for special purposes.

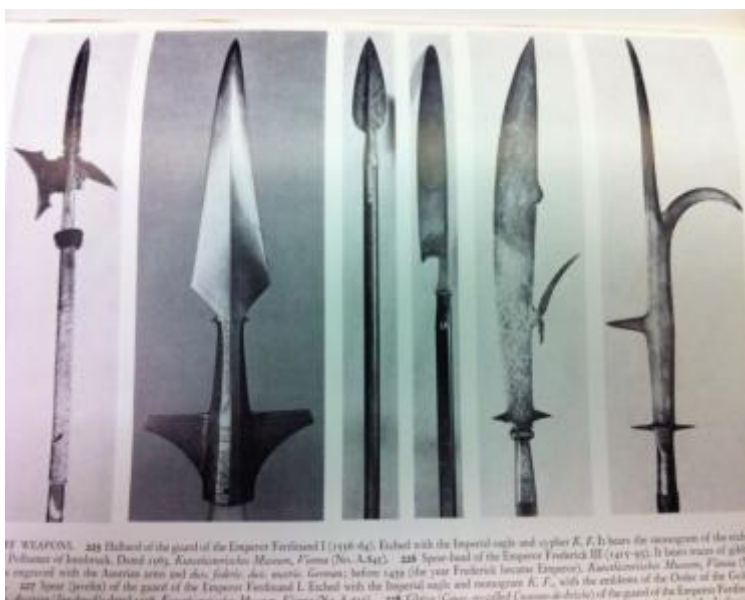

Figure 14: Variety forms of staff weapons

Except for the club and spear, which are probably the oldest of all weapons, staff weapons seem to derive ultimately from agricultural implements, while every period such implements were frequently used offensively with little or no

modification. (Blair 1962)

The varieties of form of staff weapons have greatly developed and modified throughout the Middle Ages and the Renaissance as is shown in the chart below.

One big category in the family of staff weapons is the Halberd. The word “halberd” was from the German words: Halm, a “staff”, and Barte, “ax”. The first form of the halberd was actually fixing the scramasax to the end of a staff.

By fixing the scramasax to the staff, this weapon was able to combine the advantages of both the spear and the ax. And foot soldiers equipped with the halberd were very effective against the horseman, because this weapon made them able to both cut and thrust. (Blair 1982)

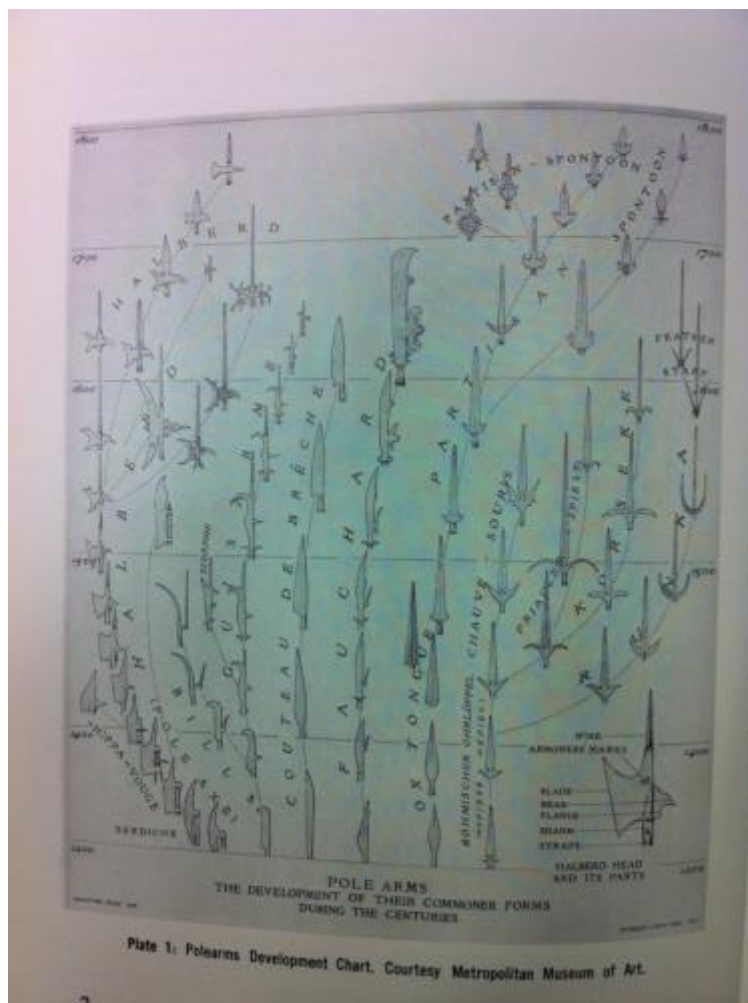

Figure 15: polearm evolution (Blair 1982)

blade fixed at the side of a shaft, and attached to it by two or more rings which spring from the back of the blade. The latter is invariably carried up to a sharp point over the axis of the shaft, and some examples show a spike upon the side opposite to the blade. (Ashdown 1967)

The halberd was developed and modified in design by the end of the 15th century. The newly designed halberd comes with a powerful spike within the axis of the staff, a fluke used to break open helmets or armor, and the join between blade and spike by means of a step of varying degrees.

The voulge may be regarded as a cousin to the guisarme, from which at times it differed but little. In its simplest form it consists of a broad

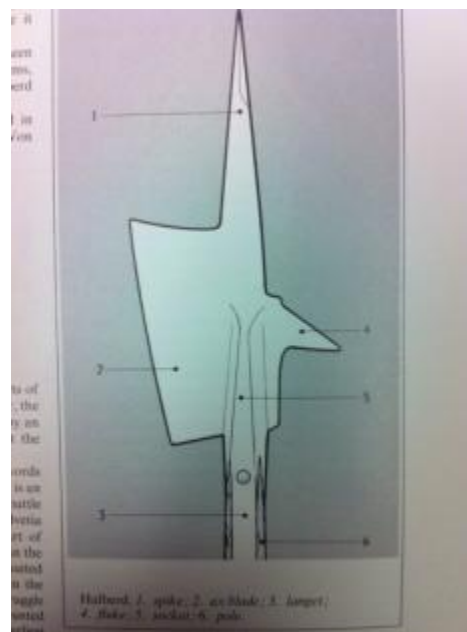

Figure 16: The newly designed halberd

'Maximilian' Field Armor with a visor for ceremony and tournament

Accession Number: 2877

Southern Germany, 1510-20

This "Maximilian" style field armor, with a visor for ceremony and tournament from Southern Germany was made about 1510-20. It was made of steel, modern leather and restorations and weights 50lb. 4.5oz.

It would seem that by the middle of the 14th century plate armor was still at a very early stage of development and that mail still predominated. But throughout the 14th century plate armor more and more took pride of place and during the last quarter and in certain cases at the very beginning of the following century the complete suite of plate armor was evolved. (Eduard 1962)

Full plate armor was fashioned to provide freedom of movement, as well as maximum protection and personal comfort. By the early 16th century, the following categories had been delineated:

Combat: Strong, maneuverable, with smooth, glancing surfaces. Relatively lightweight, averaging forty-five to sixty-five well-distributed pounds.

Ceremonial: Of thinner, softer metal, ornately or fancifully decorated. Not designed for battlefield use.

Tournament: Heavyweight - some surviving examples are one hundred pounds in weight.

(Duval and Karcheski 1983)



Figure 17: The Maximillian Field Armor

The term Maximilian armor refers to the style of early 16th-century German plate armor that was introduced during the reign of Emperor Maximilian I.

Not every armor worn by Maximilian I is necessarily Maximilian-style armor, and actually the most famous armor worn by Maximilian was gothic-style armor. Maximilian I became emperor in 1493 and died in 1519, but classic Maximilian armors are known from 1515 to 1525, and similarly-shaped armor with less or different fluting was produced from 1500.



Figure 18: Emperor Maximilian I

(Oakeshott 2000)

Gothic plate armor is the plate armor of steel made in the regions of Germany and the Holy Roman Empire during the 15th century that provide full body protection to the knight who wore it. These armors were modeled with curves, fluting and ridges in order to enhance the strength of the armor and deflect arrows. Such armor was common during the 15th century in central Europe and reached its peak in the 1480s when it was

considered the best in Europe.

At the turn of the sixteenth century, substantial changes occurred in the design of German armor from the influence of the Italian Renaissance. A new type of armor developed in Germany around 1505. It was characterized by parallel or radiating ridges and channels, known as fluting that covered most its surface. While essentially decorative, the light-catching ridges also strengthened the steel plates without adding extra weight. Because fluted armor emerged during the reign of Emperor Maximilian I, it has been called “Maximilian-style” armor since the

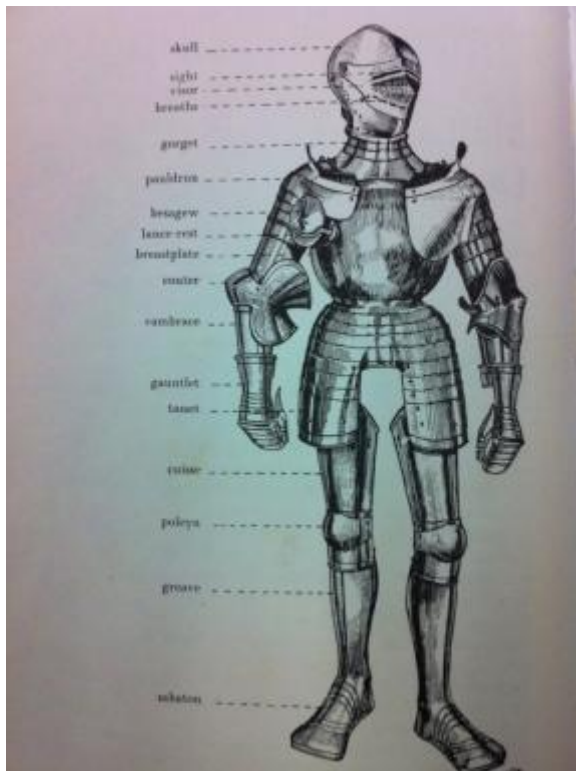

Figure 19: A Maximilian Style Armor

to Froissart, Thomas Mowbray sent to Germany for armor for his famous but abortive duel with Henry Bolingbroke, while the later sent to Italy for his armor. From this time onwards, the armorers of south Germany seem to have made rapid progress and after 1450 they began increasingly to rival the armorers of North Italy.” (Blair 1959)

The most important centers of production were Augsburg, Nurnberg, Innsbruck and Landshut. Their products were marked with a city mark to show that they had satisfied guild requirements.(David 2002)

Armor design and clothing fashions were often closely related. The sabatons (foot defenses) of "Gothic" armor reflect the male shoe style of the fifteenth century. The rounded breastplate of "Maximilian" armor closely follows the doublet lines of the early sixteenth century. (Duval and Karcheski 1983)

nineteenth century. Its popularity was greatest in southern Germany and Austria, where the fashion lasted until the early 1530s. (Met Museum)

The reputation of Italian armorers was such that their products were in demand all over Europe. A vast export trade was built up, while Italian styles commanded wide influence. Only in southern Germany and in Austria were there comparable centers of armor manufacture during this particular period of time. (Robinson 2011)

It was recorded that: “In 1397, according

Target (shield) with breech- loading gun

Accession number: 2533

Italy, about 1540

Target is a contemporary name for a type of round shield which was carried by a foot soldier and the infantry officer.

This Target with breech-loading gun in Higgins

Armory Museum is one of the few surviving examples of so-called gun shields. It was made of wood, steel, tinned iron, brass, fabric, paint, and modern restorations. It has the diameter of 19 1/8 in. and it weighs 9lb. 10oz.



Figure 20: Target on Display



Figure 21: The Target

This circular gun shield is concave to the body and is formed of cross-layered wood strips, which are faced with eight steel plates in a spoke-like pattern. At the center is a riveted, domed circular plate pierced for the gun and aiming holes. (Duval and Karcheski 1983)

Extending transversely across inner face of shield is large rectangular area with trace remains of glued pad for forearm. And its steel outer face formed of 8 overlapping, truncated wedge-shaped plates. The center of the shield has slightly rounded, circular boss with shield-shaped escutcheon-plate, the center of which pierced for gun barrel and sighting. The gun is restored with 11" in length, a barrel of circular section, and a 15 mm bore at muzzle. The integral

breech is of square section, with "U"-shaped, pivoted cover, by recurved spring-release. Both cover and bracket on which gun is mounted lack pierced lug-and-pin mounts. The bore of breech



Figure 22: Gun mount and aiming holes

is 24 mm., and lacks tubular cartridge. Above and to right of breech is serpentine and mount. (HAM)

This gun-shield was once used by King Henry's bodyguard as the king's personal defense. The barrel of the gun was extremely

short which limited its accuracy to a few feet, so it would only be useful for close range combat.



Figure 23: Saxons with circular shields

From the beginning of the Middle Ages until the 16th century, the shield seems usually to have been made of wood covered with leather, sometimes reinforced with strips or plates of metal or pieces of horn. (Blair 1958)

There are two general forms of shields in the early part of the period:

i) A large, oval or circular shield concave towards the body, carried by the Saxons.

ii) A large, kite-shaped shield, concave towards

the body, carried by the Normans.



Figure 24: Normans with their kite-shaped shields (image from: classes.maxwell.syr.edu)

The circular shield was used, chiefly by foot-soldiers, throughout our period. And itself was categorized again in two forms:

i) The target or targe, fairly large and fitted with enarmes for

attachment to the arm.

ii) The buckler, small and equipped with a cross-bar inside by means of which it was gripped.

Those shields continued to be used occasionally in battle until the 17th century, a special bullet-proof made entirely of steel having been devised in the late 16th century.

An unusual group of the circular shields are the so-called gun-shields. All of the surviving examples of them are of wood faced with steel plates with a breech-loading match-lock pistol projecting from the center often with a small observation grating above. (Blair 1958)

Matchlock Musket

Accession Number: 460

Late 1500s- early1600s

Probably German



Figure 25: The Matchlock Musket

When looking at weapons that revolutionized the battlefield the musket is definitely one that needs to be taken into consideration. It is a weapon that completely changed the tactics of war.

Before firearms came into play the only major ranged weapon was the bow. Although a well-trained bow man could shoot 4 or 5 times faster than a musketeer the bow was of limited use against armor (Archer 2003). The major drawback of the bow was that it was a weapon that needed a lot of practice; a bowman would have needed years of experience before he could be considered a professional.

The musket eventually replaced the bow but was in no way perfect. One of the most notable drawbacks to the musket was the reload time. One of the only ways that this could be remedied was by sheer volume. There needed to be massive amounts of musketeers in order to have a continuous stream of fire at the enemy. The other way to fix this problem was to have a wall but this could only be done in a well-defended area such as a fort. One of the biggest problems was accuracy. (Hall 1997) This would be slowly fixed over the years but until then was also remedied with massive numbers. There were also some definite benefits to the musket. A

musketeer needed only days to learn how to fire a musket this allowed armies to be formed much more quickly. Also the musket actually could penetrate armor. This was a big step forward since during that time an armored man had very few weak points.

Another major problem of the musket was its weight; it weighed about 20 lbs. This was much heavier than other weapons. (Neumann 1967) Many times larger men were the only ones who were capable of carrying and using the musket. The musket was so heavy that it required a forked support called a “musket rest”. This was large pole that was forked at the end to rest the musket in.

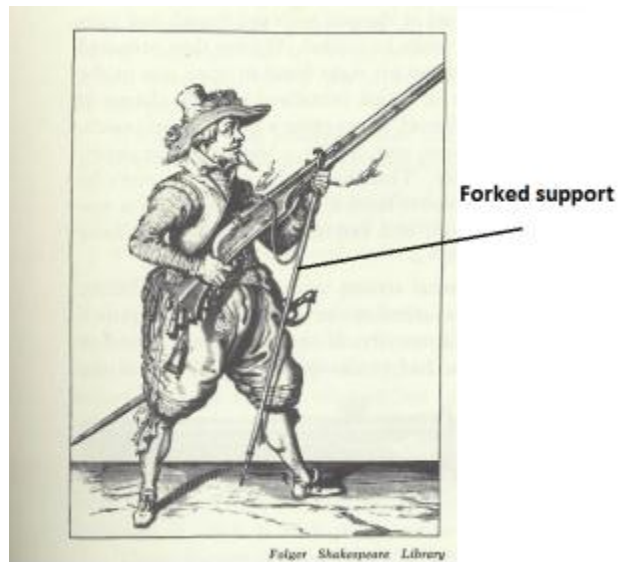

Figure 26: Musketeer with forked support

Even with all of these problems the musket replaced all pole arms and bows and became the weapon to be used by infantry men.

A musketeer had to carry specific items on him.

- A few yards of matchcord (was said to be lit at both ends)
 - This consisted of a loosely braided cord that had been soaked in a saltpeter solution (Nuemann 1967)
 - Burned at a rate of 4 to 5 inch per hour
- A pouch of musket balls and musket cleaning kit
- A small flask of priming powder
- A large flask of coarse powder (many were replaced by smaller vials with prepared amounts)

- A small sword (many preferred to use the butt of a musket as a club)

(Roberts 2002)

The matchlock firing system was fairly simple. The matchcord would be held in a clamp called a serpentine. When the trigger was squeezed it would lower the serpentine into the flash pan igniting the powder.

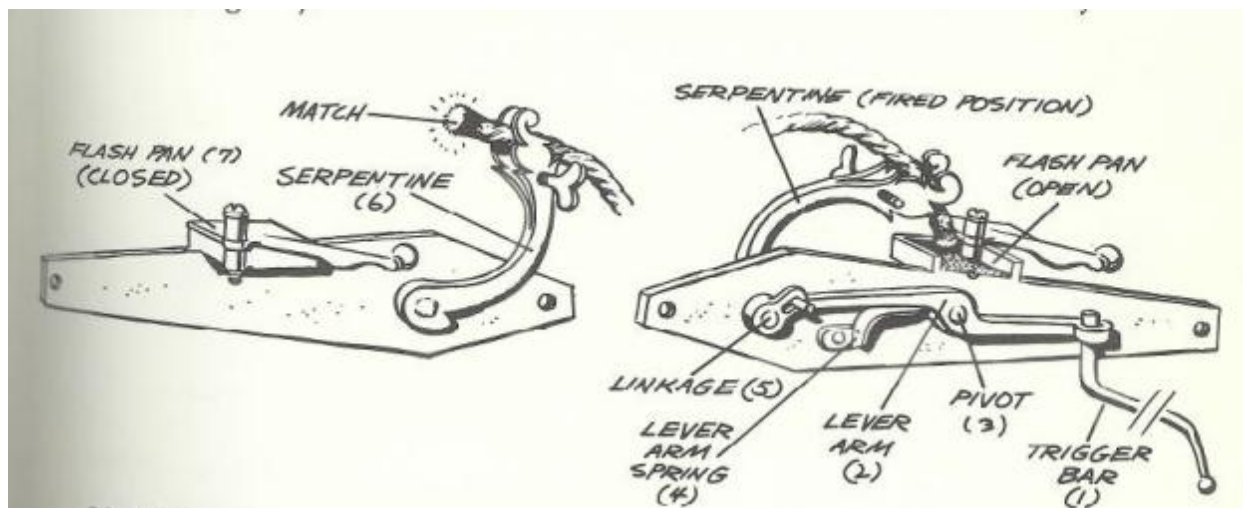

Figure 27: Matchlock Mechanism

The matchlock musket was not the first or last type of firearm. The first type of firearm was hand ignition cannon. This type of weapon lasted from 1300 to about 1500. The system for shooting this was to load powder and projectile into the muzzle then inserting a hot wire, coal, or match into the touch hole. This type of system was inaccurate and there was always the danger of the barrel breaking; although it was the first personal weapon with gunpowder. The only good thing about it was that it was very intimidating with its smoke and loud noise. (Nuemann 1967)

From about 1410 to the 1500's the Arquebus matchlock musket was used. This weapon was the earliest form of matchlock at 3 to $3\frac{1}{2}$ *ft* and weighed 10 lbs. Although it had terrible accuracy it had a .72 caliber (large enough to damage armor). (Nuemann 1967)

Starting at about the mid 1500's the matchlock musket became the most formidable firearm. This musket was 20 lbs with a bore of .77 to .83 caliber. (Nuemann 1967) This firearm

was known for large charges (up to 2 ounces) which led soldiers to bracing the gun with their shoulder rather than the front of the chest. (Peterson 1956)

The caliver matchlock is the next gun to come along and was used mainly during the late 1500's and early 1600's. This was a light version of the musket. This form included a cover for the priming pan, this allowed for shot to be prepared before battle. This also had a more controlled system for the ignition action. There was also the improvement that modernized the trigger creating a vertical trigger rather than the horizontal ones that had been used before.

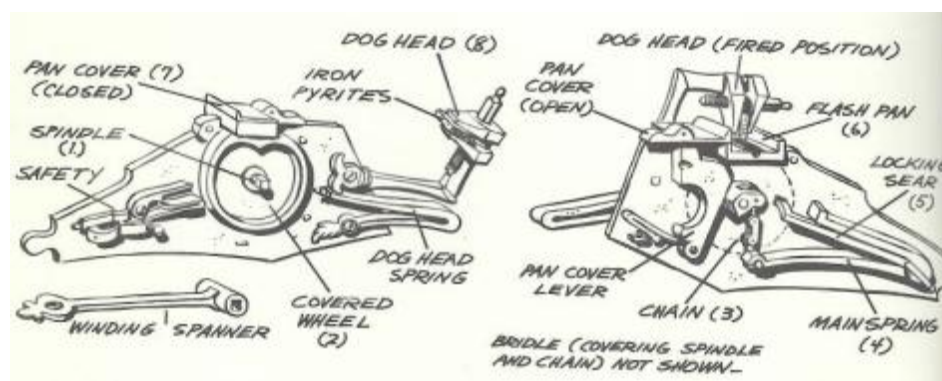

Figure 28: Wheel lock system

as early as the 1500's but by the late 1600's was replaced by the flintlock. This type of ignition was known about since at least 1505 (Vernand); but since this mechanism was difficult to make it was much less common than the matchlock. It was extremely useful since it allowed for quick firing without any open flame. This mechanism allowed for pistols and firing from horseback but never became common for the infantry. (Neumann 1967) By the late 1600's this form of ignition was replaced by the flintlock system.

The flintlock system was another form of firing that didn't need a flame. This ignition system would last quite a while. It was originally used as early as 1550 and lasted till the 1840's.

There was also an ignition that was better suited for combat known as the wheel lock. The wheel lock ignition was seen

This firing was done by pulling a trigger to release the flint to strike against a steel plate. This would create a shower of sparks igniting the powder. (Nuemann 1967)

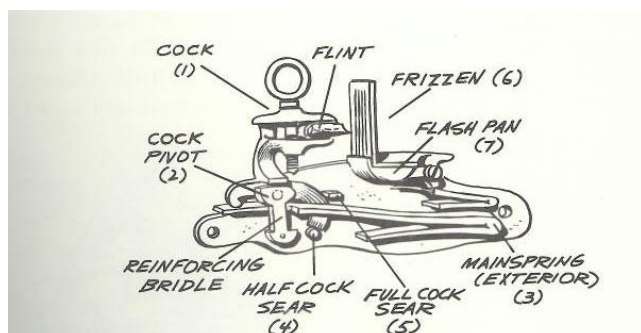

Figure 29: Flint lock system

The Halberd of the Trained Band

Accession Number: 2501

Massachusetts, 1678

The halberd was originally made in Switzerland and early versions of it are often confused with the Swiss vogue. The Swiss appreciated it so much that in the 1400s it replaced the pike. (Stone 1961) The Swiss used staff weapons in 1315 to win the battle of Moragarten. They later gained their freedom and expressed it through the everyday life with staff weapons. They quickly became well known for



Figure 30: halberd of the trained band

their use of halberds and goendendags. (Devries 2007) They wore these as sort of badges to prove they had won their freedom.

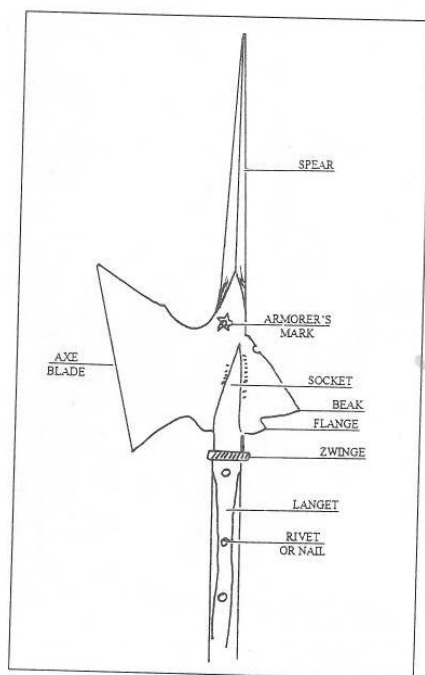

Figure 31: Parts of the halberd

blocking enemy's weapons. Over the years these parts changed according to use and fashion.

The name of the halberd comes from 2 separate words: hild (which means battle) and bard (which means axe) so together they are battle axe. (Brown 1967) This name is very apt since there are many tales of a halberd cutting off someone's head, sometimes even through armor.

Although the halberd took many forms over time it does have a few basic parts. It has the pike, the axe blade, and the fluke. Many halberds were held in place by metal straps, called Langets, which had spikes through them to make it effective for

Early halberds were built very sturdy and could take quite a bit of abuse while later halberds became much more decorative as they were mainly to be used as parade weapons. The earlier version of the halberd had much broader axe blades (Brown 1967)

The halberd has actually been tested through a modern recreation. The results were that the blade could cut through flesh but was basically useless at cutting through any armor. The spear on the other hand was very good at piercing the breast plate and the beak was even able to go through a man's helmet. These results of course could not be used as undeniable proof since it would be difficult to completely duplicate the methods or the armor used back then. (Waldman 2005)

There are 3 main ways that a halberd was made. The first way is that the spear tip, axe blade, and fluke are all one piece. The second is that there is a hole put into the pole just below the spear tip which allowed the beak and fluke to pass through and then was secured with rivets or shrinking. The final way that a halberd was made was that the beak/ axe blade was the piece that had the hole; the spear tip would then be slipped through this hole and then either fastened or shrunk to keep it in place. Out of all three of these methods New England halberd makers would generally use one of the latter 2 methods. (Brown 1967)

The halberd that I am researching seems to use the second of these forms of crafting. The ring that the beak and blade are connected to suggest that the pole was passed through the ring and the large spear tip was added later.

The halberd was many times used as a symbol of status. In 1624 there was an order of pole arms. Two partisans one for the captain one for the lieutenant, 3 halberds for 3 sergeants, 60 pikes, and 20 half pikes. This shows that the halberd was the staff of the Sergeant. While the top men carried partisans the lower group got either pikes or half pikes. (Kienbusch 1940) This

practice was carried on even when the use of pole arms was dwindling. Although the pole arm would not be used in battle it allowed the sergeant to be identified by his men. By the late 17th century the halberd was solely there as a representation of rank which allowed many metal crafters to make more intricate designs and leave their mark on the weapon. (Neumann 1967)

Sadly many halberds have not survived either due to breaking or much more likely being melted down to make other metal items. Halberds were a major part of the development of America. They had been known to be in use up to about 1689, when Governor Leisler threatened to run a councilor through with a halberd. (Peterson 2000)

The halberd was for centuries a major weapon but around the time this particular one was made was going out of style. By this time the halberd was almost completely for representing status and for decoration in parades.

This weapon in particular is one that was used by the trained band. The trained band was one of the original forms of military that the colonies had. At the beginning of their settlement they had no professional army. They were forced to rely on civilian soldiers: every man had to attend training days or else face a fine. Due to the fact that these soldiers were neighbors there was a group pressure to attend. In this system every able-bodied man was encouraged to carry a gun, even servants (Ahearn 1989). Since surprise attacks seemed to be the favored strategy in the new land they had to be ready. They were run by a town militia committee which was made up of the town's people. It was not until later when the colonies hired professional soldiers to train the citizen bands that they gained actual unity. This was established by 1676 when Edward Randolph gave a satisfactory report of New England's readiness. (Ahearn 1989) These are some of the first men to fight in America and later generations would continue the fight for freedom.

During the time of King Philips war, 1675-1676, Essex County sent 357 soldiers. They

had more men but they were mostly farmers and they were in need of farmers. 52 of those men who fought died. (Zelner 2009)

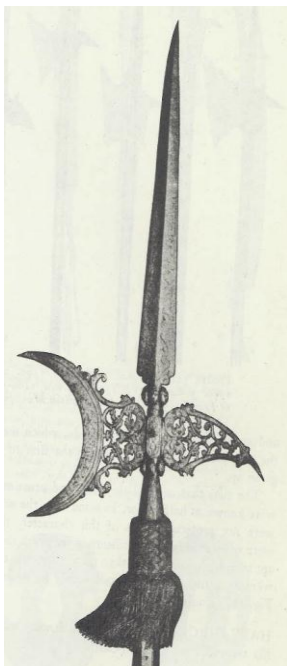

Figure 35: Italian halberd



Figure 35: The evolution of many different halberd

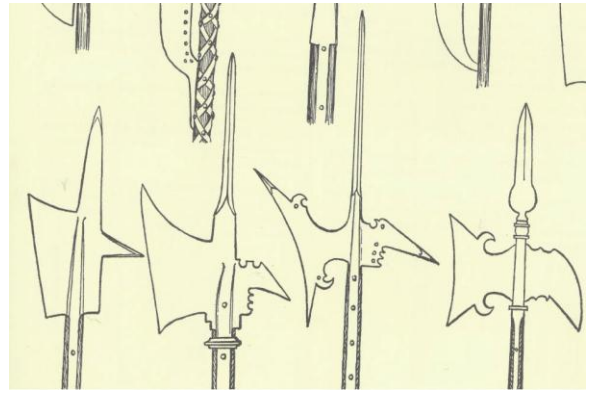

Figure 35: Various forms of halberds



Figure 35: Swiss vogue believed to

Afterwards the colonies came out stronger than before with a completely new attitude. This halberd in many ways could have

2009)

been a way to celebrate their new assertiveness and show that they were ready for a fight. (Zelner

The Sword of Justice

Accession number: 1996.01.3.a

1700-1735

Through the ages there have been many ways to put people to death and one way is by the sword. This is no ordinary type of sword; the sword used to behead someone is the sword



Figure 36: The sword of justice

of justice, also called the executioner's sword. This sword was made differently than swords that were made for battle. It was much heavier and stronger than a typical military sword. It needed this so that it could handle the job of severing a human spine in a single swing. In general the executioner's sword was about 2 in wide and about 40in long. It also had a blunt end; there was no need for a sharp end since the executioner did not stab the criminal to death. (Farmington, 1996) The sword also needed a few things so that there were no mistakes; a grip that was guaranteed not to slip, big enough for 2 hands, good balance to make it accurate, and it needed to be heavy to build momentum (Abbott, 1991); even the slightest mistake with the sword could lead to disaster.



Figure 37: Close up of the executioner's sword

The executioner's sword was meant for chopping off heads but many of them have intricate designs or poems placed into them. Many times the poem would pray for the executioner's soul as well as the criminal as he was sent to god. There were also the pictures that were put into the swords; some of them represented justice while others revealed gruesome ways in which people were put to death. It all depended on who made the sword and how he wanted the implement of execution to be depicted.

This particular sword has on it a German poem. When translated the poem reads "When the poor sinner is deprived of life,/then he will be placed under my hand./ When I raise the sword/may God give the poor sinner eternal life." With this symbol of justice they ask that the criminal be granted eternal life.

This sword also depicts the lady of justice. The lady of justice has a scale in one hand and a sword in the other. The scale represents the fairness of justice and the sword represents the penalty for breaking that balance. She is also blindfolded to represent the fact that justice should be blind or nonbiased.



This symbol of lady has a very long heritage. There is Themis the Greek goddess of justice depicted as a woman holding scales. Going further back there is Maat from Egypt who measured people as they enter the afterlife (Resnik 2010). Her main tool was the scale; she was sometimes even was part of the scale. The symbol of the scale goes back even further. In Mesopotamia there was a god by the name Samash who carried a scale and served as a judge (Resnik 2010).

This sword in particular was never used in execution but was mainly for ceremonial purposes. It would be hung in different areas especially in places like court rooms. People used it as a symbol to represent the unforgiving consequences of breaking the law.



For its time the sword was a good way of beheading but there were many dangers of this type of execution. Due to the shape of the sword there could be no block for a person to rest their head. This forced people to be kneeling when they were killed. This turned out to be a big problem since if a person flinched at the last second it could cause the executioner to miss his mark. This could result in multiple blows and more pain than necessary for the criminal. (Farmington 1996) There was even more danger added if the person to be executed had to be restrained since the executioner had to watch out for the assistants as well. Despite the drawbacks

Figure 38: Gruesome pictures on the blade of a executioner's sword

of the sword it was seen as a better way of execution as opposed to the alternatives.

Beheading was the way of execution for many higher nobles and was seen as more fitting than other forms of execution such as burning or drowning. The original way of beheading was by the axe. The axe had a bad reputation to deliver an unclean cut and was not able to get the job done in a single blow. The sword was not perfect but was much better suited to do the job in a single blow. Eventually the sword was also deemed inadequate and was eventually replaced by the guillotine although there were reports of the sword being used up until 1893 (Farmington 1996).

There were also other forms of execution besides beheading. Up until 1513 people were put to death by being buried alive. This was eventually replaced, due to public argument, by drowning. This was also eventually replaced by beheading since it was a quicker way of putting someone to death. (abbott, 2005)

In London hangings were extremely popular; In fact there was only one account of beheading with the sword. This was the beheading of Anne Boleyn. For this event there were no experienced Englishmen for the beheading of a queen. A Frenchman had to be brought over from Calais. Anne was dressed in extremely elegant and expensive cloths as well as jewelry. It is said that when her head was held up her mouth opened and closed convulsively. (Abbott 1991)

Through the spectacles that were made of beheadings stories began to grow. Some of them seem to amazing to believe while others are about pitiful failures.

One story tells of a man who refused to kneel and merely told the executioner to get on with it. The skilled executioner skillfully cuts the man's head off in a single slice leaving it resting upon the shoulders for a few seconds after. The story ends with the executioner telling the criminal "shake yourself- its done"(Abbott 2005)

Another story tells of a criminal who volunteered to be an executioner in order to save his own skin. This inexperienced amateur was utterly shamed when it took him 29 blows to cut through one man's neck(Farmington 1996).

War hammer

Accession Number: 2005.01

1440

The war hammer is a single weapon that had many uses. It had the spear tip to be used as a pike; this was perfect to stop a charging horse or stabbing through armor. There was the thick beak opposite the hammer which was very good for piercing through the armor. Then there is also



Figure 39: War hammer

the main weapon which is the hammer. The hammer was there so that even if a soldier could not pierce a piece of armor he could still deliver a powerful blow to hopefully kill or cripple the enemy (Blair 1962). This part many times was made into a blade almost like an axe (stone 1961); this probably why the name of this weapon became interchangeable with the name poleaxe. If any of these pieces were not enough then there was always the staff which could be used to disarm or unhorse a man. Some war hammers also included some type of spike at the bottom of the staff. A master with this weapon could be very fearsome and effective on the battlefield.

It is thought that the war hammer started around the time of the crusades, when even peasants were brought into battles. Since few of them had weapons they were forced to bring what they could. A hammer could do some serious damage but was also practical since it could still be used to drive in stakes to set up camp. (Norman 1967) From this humble beginning the war hammer started to branch out.

There were two major forms of war hammers, the long staff war hammer and a short war hammer. The short war hammer was much more popular than its longer counterpart. The shorter one allowed for it to be carried as a secondary weapon and even used on horseback. (Edge 1988) The shorter version of the war hammer was seen as early as the mid thirteenth century. The

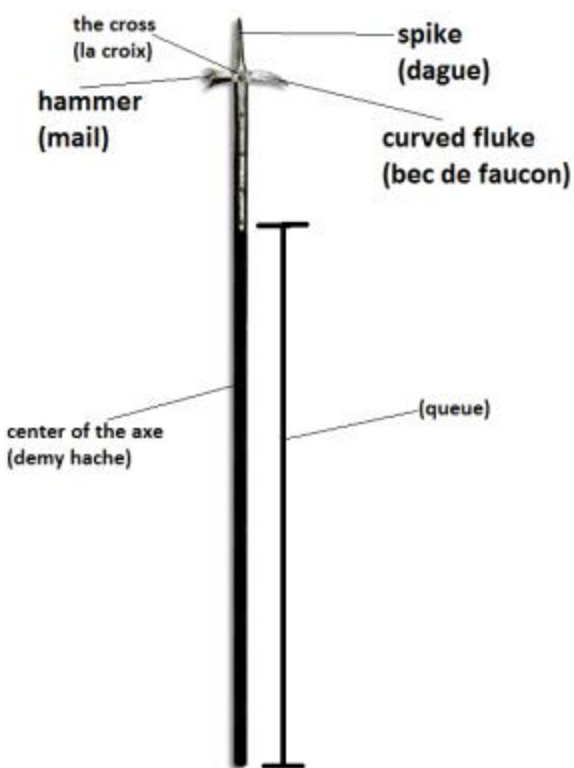

Figure 40: Parts of a war hammer with terminology from Le Jeu de la Hache

bec-de-corbin. (Blair 1962) As time progressed the war hammers purpose mainly became for decoration. The crafters created weapons that served no military purpose and were solely there for decoration. (Blair 1962)

When it came to fighting with a staff weapon there was not much difference in the way a soldier would fight with one. In fact many instructions from the Middle Ages combine all staff weapons making no separation between the different varieties. (Anglo 2000) In many cases they barely touch upon how to fight with them. These types of weapons were later

seen as ungentlemanly. This could be due to the fact that they were a fairly easy weapon to make since the basis is nothing more than a wooden pole. This could also be due to the fact that it was one of the more useless weapons in actual combat (Anglo 2000). Although the pole ax was one

longer version of the war hammer was a much more intimidating weapon but could only be used by infantry.

There were 2 major forms of the long war hammer. The first is very similar to the crude maul; this was given names like marteau and mantel. (Blair 1962) The second form of the long war hammer is the traditional one with the beak and 4 pronged hammer. This form of hammer received

names like bec-de-faucon or



Figure 41: Short war hammer

of the better weapons for a spectacle it was not necessarily harmful. There had been accounts of two men going against each other with poleaxes delivering multiple blows and leaving completely fine afterwards. (Anglo 200)

The large pole arms did have a few major drawbacks, first of which was their size. The size allowed soldiers to keep enemies at bay but made them hard to carry around and difficult to maneuver in tough terrain. The second major problem that they had was the fact that their attacks were obvious because of such large windups. This gave enemies plenty of time to block or dodge. (Anglo 2000)

Although the pole arms had some problems that did not mean that they could not be useful. When used correctly they could be used effectively. They were long with a spike so they could be used as a pike. Due to the protrusions they could also be used to reach around peoples legs and trip them. Other than that it seems that one of the main ways to use them was to treat them as a quarter staff. (Jeu de le Hache)

Helmet of the Gladiator

Accession Number 1129



Figure 42: Helmet of the Gladiator

This helmet was used in the ancient Roman gladiatorial games. It dates back to approximately the first century AD. The gladiators were a spectacle in Ancient Rome. The origins of the sport can be traced back to Roman funerals. Public funerals were held for the most important

Romans. During the funeral, the munera would show the prestige of the noble. The munera were people who would perform reenactments of events throughout the life of the deceased. The idea of the games came from two possible areas in Italy: the Etruscans, or the Samnites. The Etruscans had paintings displaying games played at a funeral, including combat, dating before the 3rd century B.C.E. The figure on the right shows two Etruscan gladiators fighting. The Samnites were known to have gladiatorial games during meal times. The purpose of having gladiatorial games at funerals was to have a human sacrifice. It was believed that “men fought to the death at the funeral of a much-valued



Figure 43: Etruscan painting of gladiatorial combat image from <http://thehistoriantravels.com/etruscans/etruscan-interesting-facts.htm>

leader, whose spirit benefited from the spilling of blood” (Futrell 2006, pg 6). Eventually the

games grew larger, attracting more crowds. In the middle of the second century B.C.E., the games started to be held further away from the date of the actual funeral, but were still meant to honor the dead. The reason it was becoming further away was that the preparation for the games was taking much longer. The combatants would fight on a stage, and food would be served, as if it were a festival (Futrell 2006).

Augustus Caesar was the first emperor to hold enormous gladiatorial performances. His shows averaged 1,250 fighters, and approximately 135 animals. It was at this point that the reasons for the spectacle changed from a funeral setting to a more celebratory state. The shows would be performed after Rome won a battle, or to celebrate the anniversaries of events that were important to Rome. Eventually

buildings such as the Colosseum were built to house these events. The Colosseum was built after the collapse of the “temporary” structures made under the rule of Tiberius. This structure took 8 years to build, starting the construction in 72 AD, and



Figure 44: Roman Colosseum image from:
<http://www.languedochouse.com/colleseum.html>

finishing in 80 AD. This is where the games were held. It was made out of marble, brick and concrete. It was estimated that the Colosseum was capable of holding between 50,000 and 80,000 people (Futrell 2006, pg. 34).

Being a gladiator was not a position that was desired. Although there were a few Roman citizens who became gladiators, most were slaves who were bought in the slave market. In Roman society, the word gladiator was accepted as a term of abuse. People would comfort

mothers who lost their son prematurely by saying “had he grown old he might have squandered his fortune and sunk to the level of fighting as a gladiator” (Wisdom 2001, pg.13).

Gladiators were trained in schools known as *ludi gladiatorii*. These schools often trained the gladiators every day, using harsh physical exercise and long combat practices. Although the conditions were harsh, the schools would employ skilled masseurs, also known as *unctores*, and fight trainers, or *doctores*. These people were employed to make sure the fighters remained healthy enough to fight. If a gladiator was sick, then the fight would not last as long, and the people enjoying the show would be disappointed, so it was important to keep them healthy (Wisdom 2001, pg. 13-14).

The harsh treatment of the gladiators would lead to revolts. The most well-known revolt was that led by Spartacus. In 73 B.C.E. Spartacus and his Celtic friend, Krixus, overpowered the guards at their school using only kitchen knives. They began to collect followers, and eventually the large number of followers proved too much for the two to handle, so they split up into two groups. Unfortunately, Krixus and his troops were caught shortly after they split up from Spartacus. Spartacus, however, was able to lead his troops to defeat the Roman forces. He then forced the Romans to fight against each other in gladiatorial combat, much like he was forced to do. In 71 B.C.E. the Romans troops, under Crassus, were able to capture Spartacus. He was slain, and his troops were given the option of returning to slavery or being crucified. Approximately 6,000 of Spartacus’s troops were crucified along the Via Appia, which was the main road between Capua and Rome (Wisdom 2001, pg 14).

The gladiators were not the only ones who were forced to fight. People who committed crimes such as robberies, rape, and murder would also compete for survival in the ring. These people were known as *noxii*, and would be pitted against other *noxii*, or gladiators. The

differences between noxii and gladiators were that noxii were not trained to fight, and were not given armor. When the noxii fought against each other, both men had no armor, but when fighting against the gladiators, the gladiator would receive armor. The gladiator was also a veteran combatant who had fought many battles before (Wisdom 2001, pg 14).

Gladiators wore helmets to protect against aggressive blows to the head. If a gladiator

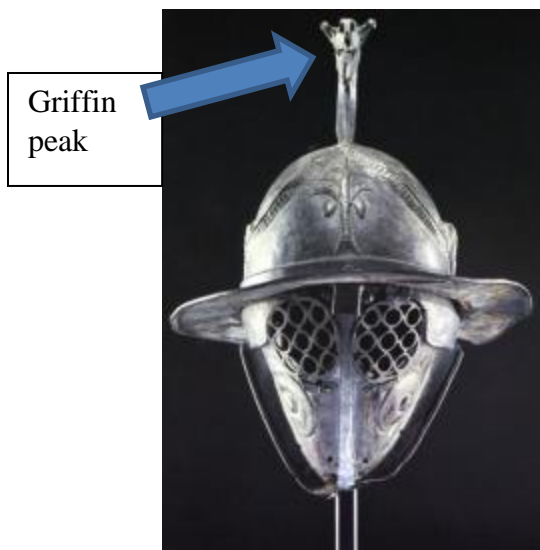

Figure 45: Thracian Helmet image from: <http://www.utexas.edu/courses/introtogreece/gladiators/img11thrachelmt.html>

received a blow to the head that would render them unable to continue fighting, or even unconscious, the show would end early. This would upset the audience watching the show. As a result, multiple types of helmets were developed.

The first type of helmet developed was the Thracian. This helmet is easily recognizable because the peak of a helmet resembles a griffin. This helmet has two separate brims that are fused together and flared out. It also contains two face plates that are connected by the ears. There are nine holes in front of where the eyes are, providing very good vision in front of the gladiator. The second type of helmet was the myrmillo. The only major difference between the two was the dorsal fin peak in place of the griffin. This dorsal fin was inspired by the mormylos, or the sea fish (Wisdom

received a blow to the head that would render them unable to continue fighting, or even unconscious, the show would end early. This would upset the audience watching the show. As a result, multiple types of helmets were developed.

The first type of helmet developed was the Thracian. This helmet is easily recognizable because the peak of a helmet

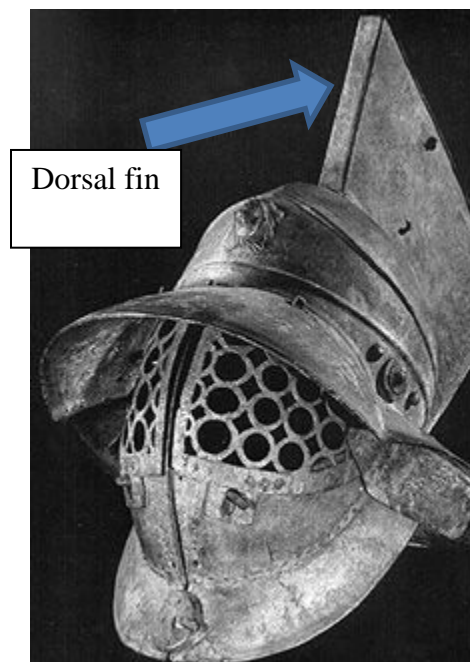

Figure 46: Myrmillo Helmet image from: <http://www.history-of-armor.com/romangladiatorarmor.html>

2001, pg. 29).

Most paintings of gladiators depict them as naked except for a loincloth. This loincloth was held in place by a metal belt. They would also wear shin-guards above their knees. Many of the gladiators would fight with a large shield and a sword. The sword was often of a medium-sized length, and had a straight blade with a sharp point.

There were several different types of gladiators. The samnis were the warriors who fought with a helmet, a large shield, a sword, and a greave (shin-guard) on the left leg. Eventually the samnis fade away, but are believed to be the origins of the similar murmillio and secutor gladiators. The next type of gladiator was the galli. The only thing known about this type of gladiator was that the combatants came from Gaul. This type of gladiator was not depicted in many paintings, and quickly disappeared from the games. Another type of gladiator was the thraeces. The thraeces fought using Attic crested helmets, a pair of greaves, a small rectangular shield, and a short curved sword. The equites were known to ride on horseback. They had a brimmed helmet, a medium rounded shield, armor from the republican cavalry, and carried a sword. The last type of gladiator was the provocatores. These fighters wore a helmet that contained feathers or horsehair, a breastplate, a loincloth, a greave above the left knee, an arm-guard, and carried a medium sized shield and a short straight-edged sword (Köhne 2000, pg. 35-8).

Nandaka

Accession Number: 1495



Figure 48: The Nandaka

India was a country that heavily relied on religion to explain many events. The idea of the sword being developed was tied with the myths of the Gods. There was a story about the asuras, or devils, defeating the devas, or gods, in combat. The gods then went to the Creator, Brahma, for aid. Brahma performed a sacrifice, a yajna, and

gave what was produced to the elder daughter of king Daksha Prajapati. When she was given the offering, Jaya conceived, and nine months later gave birth to a sword, also called an asi. This sword was then used to vanquish the asuras. It was with this tale that the Hindus believed the first sword came to be (Pant 1980, pg. 1).

As a result, in the fifteenth and sixteenth centuries, India had many distinct regions, which practiced many different religious beliefs. At approximately the same time the Bahmanids were established, the Vijayanagar kingdom established

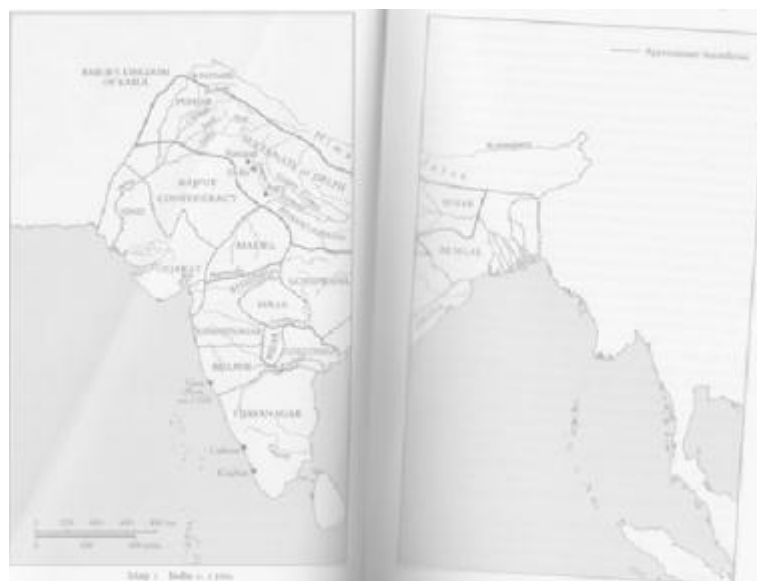

Figure 47: Map of India from A Cultural History of India (Metcalf)

itself. The Vijayanagar kingdom was founded by brothers who served under the Tughluqs, and were brought up with the Muslim faith. However, as they grew older, they started studying the Shaivite tradition. As a result, when they expanded their kingdom, they also expanded the idea

of worshipping Lord Shiva, which was a very different practice than their neighboring Sultanate and Bahmanids. The kings of these regions called themselves “the sultan among Hindu Kings,” (Metcalf 2002, pg. 8-12).

One of the largest groups of people who believed in the formless god was the



Figure 49: The Goddess Vishnu image from: <http://students.ou.edu/P/Bijal.M.Patel-1/storybook.html>

Vaishnavites. The Vishnavites followed Hinduism. These people worshipped their god, Lord Vishnu (Metcalf 2002, pg. 14). The god Vishnu represented “The Supreme Person.” Vishnu was believed to be “ultimate, eternal, and Absolute.” It was believed that Vishnu was lonely at the beginning of time, and diversified himself to create the cosmos. They believed that because of this, all people have their own individuality, but contain a connection to the gods (Basham 1975, pg. 120).

The Nandaka was very important to the Indians in the south. This sword was believed to be the sword that Vishnu himself used. The goddess Bhayavati was also believed to reside in this sword. This sword was not used in battle, or used to make sacrifices, it was only used for ritual

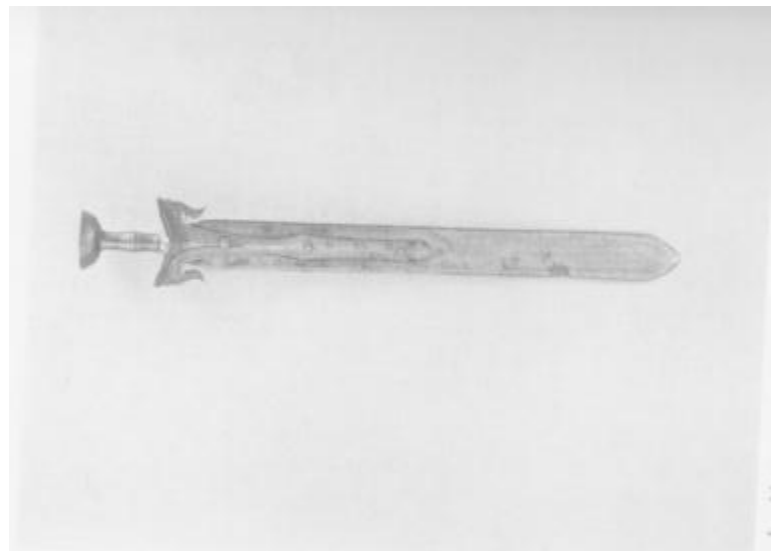

Figure 50: Old Indian Hilt image from *The Indian Sword* (Rawson)

purposes. These swords had a thin blade, since they were required to vibrate. It was often carried by the Nairs. It is still used by the Kerala in some rituals today (Elgood 2004, pg. 80).

The Nairs were also known for fighting in large battles. The Rajah of Travancore was said to have controlled an army of 1,400 Nairs. One Nair was described by Duncan: “He walks along with his naked sword held up as a walking stick; others have it fastened to their back, the hilt being stuck in the waistband, and the blade rising up and glittering between their shoulders,” (Egerton 1968, pg. 80). The Nairs would undergo training from a young age. At seven years old they would be sent off to school to learn how to use weapons. They would be trained to use bows, clubs, lances, swords, and bucklers. The men that would teach the children were often captains that served in war, also known as Panicars. Men were trained to fight, and even die for their lord. If someone attacked their King or lord, a Nair would take the blow instead, and try to take out the attacker in the process. Due to this, sometimes 10-12 Nairs would die to protect their King (Egerton 1968, pg. 80).

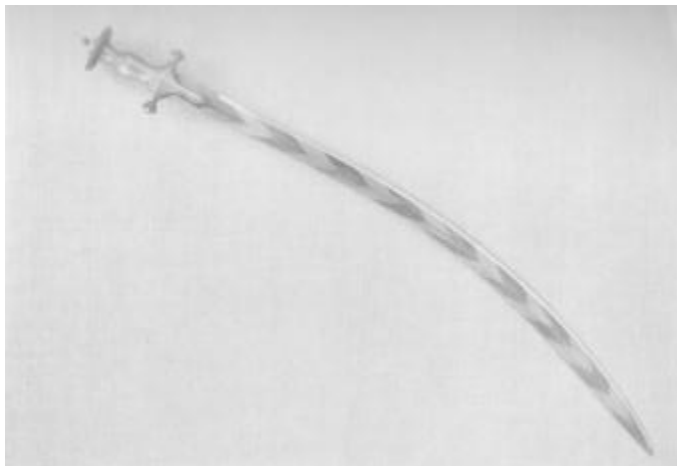

Figure 51: – Indo-Muslim Hilt from *The Indian Sword* (Rawson)

could be cylindrical, saucer, or have a flattened bulb shape. This style is similar to the nandaka shown in Figure 1.

There were many different styles of hilts in Southern India. The image to the right shows an example of an old Indian hilt. This type of hilt had a grip that contained a duofoil guard. The two seating processes are then riveted to the blade. The grip has a large circular pommel at the top, who

The second type of hilt that was often used was the Hindu Basket Hilt. This type of hilt was developed around 1500 AD in West Deccan. This style was similar to the Old Indian Hilt, but had a few key differences. It contained broadened ears of the guard, and included a plate knuckle guard. There was also usually a long, forward-curved horn on

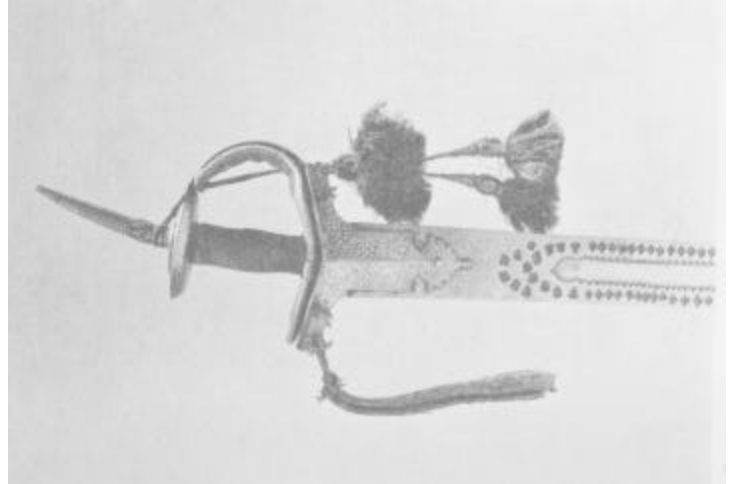

Figure 52: A Basket Hilt image from *The Indian Sword* (Rawson)

the dome of the pommel. The reason for horn was to be able to deliver a back-handed blow or to be able to grip the sword with both hands. The image to the right shows the grip with the long horn at the end. The third type of hilt was the Indo-Muslim Hilt, which is shown on the image to the left. This hilt also derived from the Old Indian Hilt. This hilt got its shape from the Mughals. This is due to the smooth contours of the hilt, and also the average sized quillion stems and pommel. It was also decorated with floral and calligraphic designs, and could have an inlay of gold (Rawson 1968, pg. 80).

Armor from a Garniture

Accession Number 425.1-a-r



Figure 53: Armor From a Garniture

The figure to the left displays a suit of field armor from a Garniture. This armor was believed to be fashioned North Italy, specifically Milan. This armor was very complex. It was made from steel, iron, brass, silver, and leather. The armor is believed to have substitutions in several places, indicating parts of the suit were exchanged.

The earliest known account of plate armor was given by Giraldus Cambrensis, describing a Danish attack on Dublin on May 16th, 1171 (Blair 1958, pg. 37). It is not known whether the armor being discussed here was scale armor or if it was a coat-of-plates design. The next image of plate armor came from the writing of Gillaume le Breton. Breton was writing about a fight between Richard, Count of Poitou (and later King Richard of England), and

William de Barres. Here, Breton mentioned that they were wearing plate armor under the hauberk, or mail shirt.

The cuirie was introduced in the late 1100's. This was a defense for the torso that was worn over the hauberk, but under the surcoat. It was made from cuir-bouilli leather. It would sometimes have metal plate reinforcements, and might contain fabric. In the 1400's the cuirass and pair of cuirasses could refer to the breast- and back-plates as a single entity.

Around 1250 A.D., plates were developed to protect the knees. These plates were small at first, only covering the front of the knees, but later developed to a hemispherical shape, covering the front and sides of the knees. Coulers, or the disc-shaped plates used to cover the



Figure 54: Image showing the defense for the limbs

elbows of the hauberk were created around 1260 A.D., but not used commonly until 1310 A.D. (Blair 1957, pg. 38-39). The plates that were used to protect the limbs were originally developed to reinforce the surcoat. Long rectangular pieces of metal were attached to the surcoat. The first known representation of this came from the statue of St. Maurice in the Magdeburg Cathedral, which was shown in the middle of the 1200's. The image to the left shows the rectangular metal plates being used to reinforce the surcoat on the arms and legs.

The bascinet was the most popular type of helmet in the 1300's. It had two different sizes, medium and tall. The tall size would cover the ears. Visors were developed to protect the face. In the 1200's, the helm typically covered the whole face, and rested on the shoulders (Martin 1967, pg.132). During the

late 1200's, a cross wider than the ventilation holes was added. The purpose of the cross was to be able to connect the helm to the breast-plate. The helm began to become longer in the 1300's, and became an additional neck-guard. The helm went out of use in the 1300's other than for tournament purposes. Camille Enlart was quoted: "The helm was worn over the skull-piece or over the bascinet. The helm was an excellent protection against blows, but was stifling, heavy, and so uncomfortable that it was only put on for the fight or parade," (Martin 1967, pg. 132).

A major change to the creation of armor was adopted in the 1500's. This was when "pieces of exchange" were introduced. This meant that a piece of the suit of armor could be used to make different types of suits. Other terms for being able to exchange pieces of armor were "pieces of advantage" or "double pieces". These pieces were both reinforcing and alternative pieces, which could be used to vary armor for different purposes. An example of armor like this

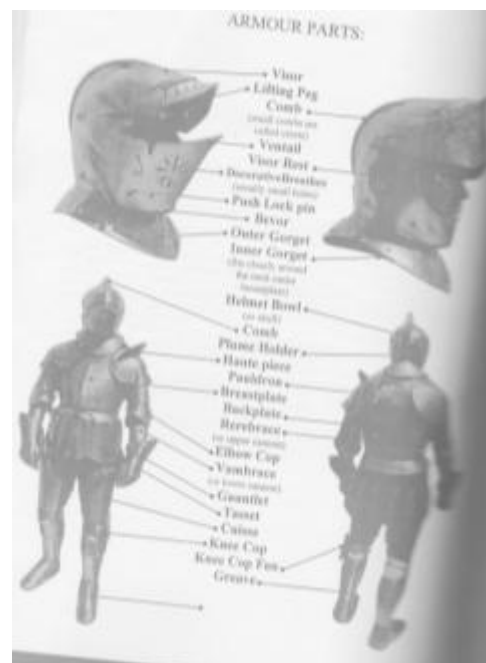

Figure 55: Parts of Armor image from *The Art of making armour* (Valentine)

was created between 1506 and 1510. Koloman Helmsch designed the armor for Andreas von Sonnenberg. It contained an ordinary field harness, but used an alternative helmet, and reinforcing pieces in the tassets, breastplate, bevor, left shoulder, left elbow, and left hands. By doing this, it was converted from field armor to tournament armor.

The "pieces of exchange" idea became so popular, that garnitures of armor would take pieces from many suits of armor, and combine them. In 1547, Jorg Seusenhofer made a suit of armor for Ferdinand. This suit consisted of sixty different pieces, which were all decorated. It contained armor that would demonstrate three types of tournament armor and five types of field armor. This suit was known as the "Eagle" garniture. It contained a plate for the top of the helmet, as well as plates for the side wings of the couters. It contained a bulletproof vest, and a gauntlet on the right hand known as a locking-gauntlet (Martin 1967, page 117).

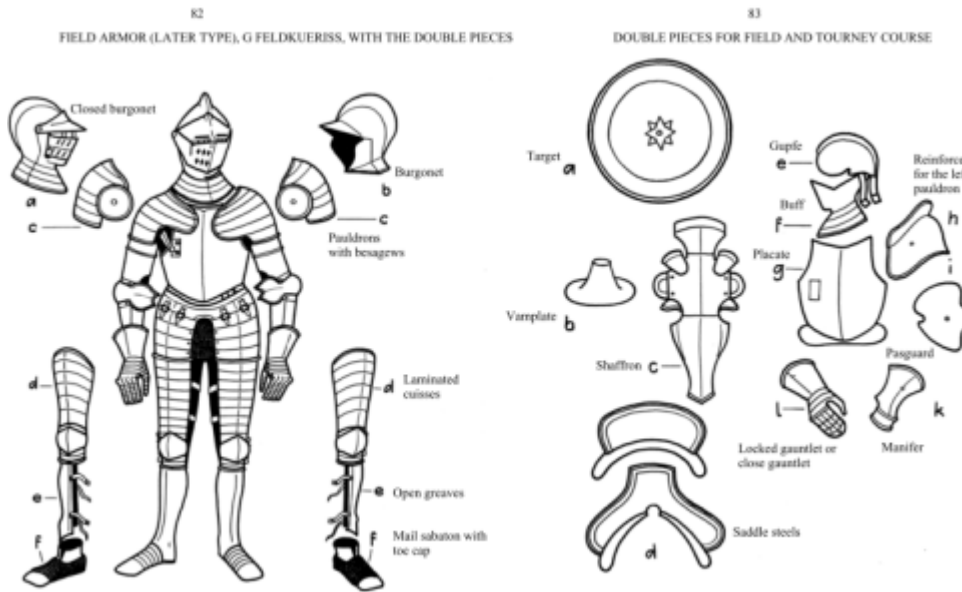

Figure 56: mage displaying double pieces from Glossarium Armorum

of helmets, two types of shoes and greaves, two styles of cuisses, and two shoulder guards.

Based on the event the knight was participating in would depend on the set of parts that were used.

The image to the left displays the double pieces of armor. This shows that one suit of armor could be used in different fashions. In the image, there are three different types

Turkish Grouping



Figure 58: The composite bow image from <http://users.wpi.edu/~jforgeng/CollectionIQP/artifact.pl?anum=2409>

The Ottoman Empire had a large Mongol influence. In 1265, Hulegu Khan, grandson of Genghis Khan, died. The Ilkhans of Persia became his successors, and they embraced Islam, as well as civilization. As a result of the Ilkhans taking over, disputes began to occur between Persia and the outlying territories. The Ottomans were one of these territories, who used this to claim their

independence. In the late 1200's, the Persian leader Anatolian Turcomans was killed after rebelling against the Mongols. His son Ali tried to take revenge, but eventually found himself aligned with the Seljuks. Ali then tried to overtake the Byzantine territory, but peaceful relationships developed between the two. This is Osman decided to attack the Byzantine territory instead. Osman led the ghazis, or "holy warriors" against the Byzantines, and won.

The composite bow was a style of bow often used by the Turks. To construct this bow, the Turks would divide the frame into three parts: the grip, the dustars, and the siyahs. It was very important for the grip to be thick and rigid. If the grip were to bend when grabbed, the bow would kick when it was shot,

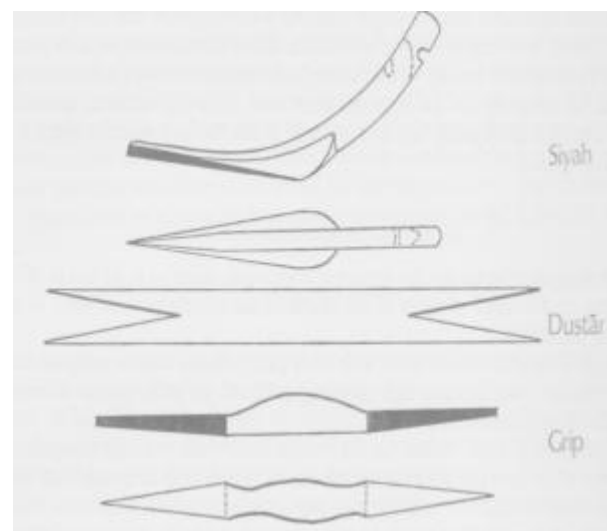

Figure 57: Parts of the composite bow image from Saracen Archer (Latham)

making it very inaccurate. The second parts of the frame, the dustars, were where the bending occurred. The dustars were flat or oval shaped, and approximately an eighth of an inch thick. The siyahs were the final part of the bow frame. The purpose of the siyahs was to give the frame the strength it needed. The next part of the composite bow to be attached was the horn. The horn was often made out of water buffalo, goat, or antelope horns. The horns would often span from the grip to the center of the dustars, and was attached by gluing the horn to the frame. The last part of the bow to be put on was the cord. The cord could be used to overcome any of the defects in the other parts of the bow (Latham 1970).

The Turkish soldiers were able to use bows very effectively. This came from the large amounts of time dedicated to training with the bow. An eyewitness in the sixteenth century remarked “The Turks are wondrous expert at shooting with the Bow; ... their Skill so great, that they will hit the smallest Mark with their Arrows” (Mohamed 2008). The bows were often used on horseback. The mounted Turks would pretend to flee from battle. When their opponents would chase them, the Turks would turn back and shoot their pursuers. The use of mounted archery



Figure 59: Composite bow case from the Higgins database

was very important in the Turkish campaigns, and it is believed that this strategy was important in defeating the Byzantine Empire (Mohamed 2008).

Shooting on horseback was divided into two types: “shooting at a slant” and “gourd-shooting”. The term “shooting at a slant” would refer to the mounted archer shooting his arrows downwards. “Gourd-shooting” indicated that archers would shoot up into the air. Both types of shooting occurred when the horse was at a full gallop. It was



Figure 60: Mounted Turkish Archer image from
[“http://bhaa.org.uk/blog/category/world-horseback-archery/page/3/”](http://bhaa.org.uk/blog/category/world-horseback-archery/page/3/)

important for the archer to train on horses from a very young age, so the movements were performed instinctively. It was claimed that: “A combination of these skills has only ever been brought to full perfection in the case of certain Turks in Islam” (Latham 1970). Figure 3 shows Sultan Murad III practicing his shooting. Aiming downward indicated that this was “shooting at a slant”.



Figure 61: The shaffron image from
<http://users.wpi.edu/~jforgeng/CollectionIQP/artifact.pl?anum=14>
 65

Horses were very important to the Turks. As a result, they needed to be protected in battle. The Ottoman cavalry had two main types of horse units. The Sipahis were the elite cavalry and the sultan’s personal guard. These men tended to not have Turkish or Muslim origins, but were instead war captives or child tributes. They were armed with a

bow, sword, shield, lance, and mace. The akinjis were the lightest cavalry. They were armed with a sword, shield, scimitar, lance, and mace. These were the units that would go ahead of the rest of the army, and scout out the area. These men took two horses, that way they would have a place to store any items they procured from the enemy camps.

Horse armor was usually a standard build. The Turks used the Persian armor design when protecting their horses. The shaffron was generally used to protect the horses' face and cheeks. It was unusual to see ear pieces on any of the armor. Horses would also be given chain mail (Robinson 1967).

Medieval European Sword History

The sword, also romantically described as the "White Arm", is one of man's most primary weapons that has been in use for millennium. Before firearms came into use, swords had "always occupied a high position in the hierarchy of weapons"(North 1982) . Even after retiring from the battlefield as a weapon, swords have never disappeared from people's vision. The sword is more than a tool used for cutting and thrusting, but also a representation of might, love and violence. The figure below shows a very basic sword model with its different parts explained.

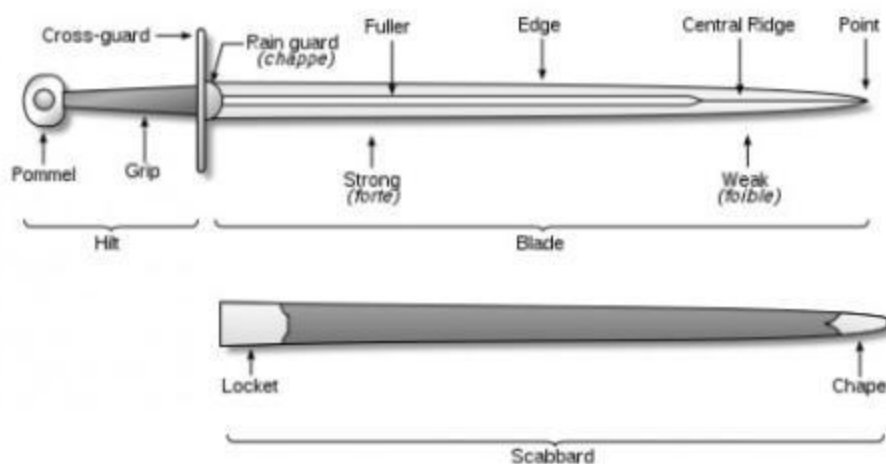

The primary part of the sword is the blade, with the cutting surface called the edge and the thrusting end called the point.

The grip, ending in

Figure 62: http://s2.hubimg.com/u/4905877_f520.jpg

the pommel, is designed to balance the weight of the blade and is also open for decoration. The guard, which eventually developed into much more complicated forms, is designed to protect the hand.

As time went on, swords evolved to accommodate changes in warfare. During the 1200s, the point of the sword became preferred to be used to the edge, possibly due to the emergence of plate armor (warriors had to stab into the joints of the plate armor in order to damage the opponent). As a result, by the middle of the 1300s, blades ended up much narrower with long

points for easy stabbing. After the 1400s, swords tend to be made lighter and swifter, enabling them to be suitable for both cutting and thrusting. As time went on, the sword became "an accepted part of civilian dress" (Coe 1989). Fashion and decorations of the sword became more and more important. The rapier, a longer and thinner version of sword was developed early in the 1600s. Later in the 1700s, a lighter version of the rapier known as the smallsword was invented as fencing techniques developed.

Sword

Accession Number: 3262

Europe, perhaps Italy

c 1470-80



Figure 63: Sword accession number 3262

During the 1400s, dramatic developments of the hilt and blade were taking place, probably in Italy, where this sword might come from. Around 1480 one of the quillons was curved up to form a guard for the hand. The lugs on the quillons were also extended until they united and formed a horizontal ring on the side. The hand of the sword wielder ended up much more protected with a series of loops and bars.

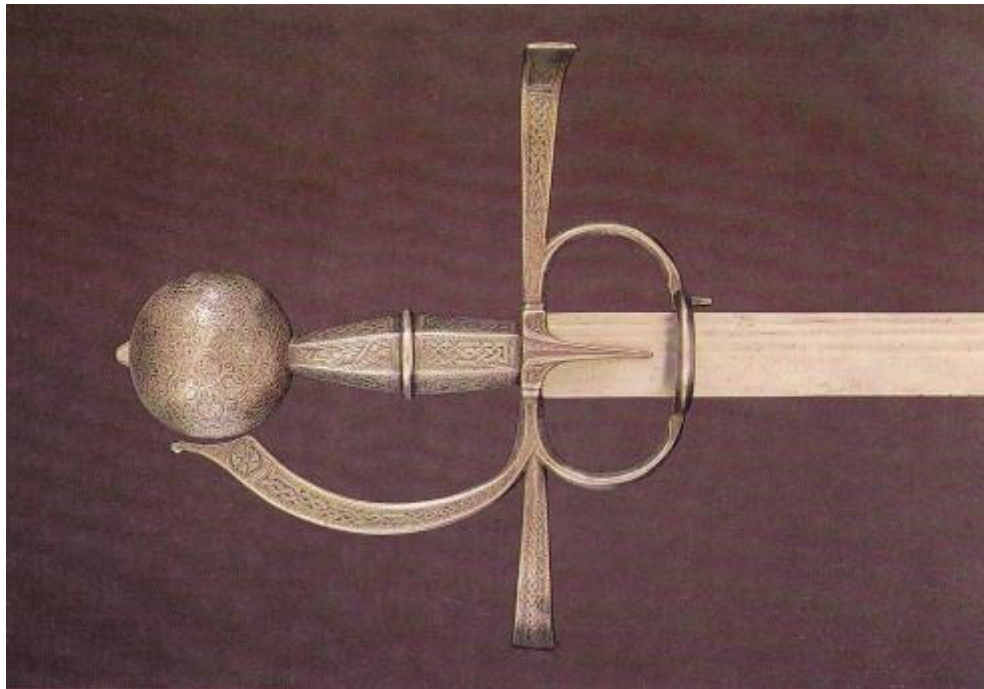

Figure 64: Hilt of an Italian rapier made in Venice in about 149 (Coe 1989)

During the 1400s plate armor became more and more sophisticated and thrusting became as critical as cutting on

battlefields. A type of sophisticated infantry wearing only absolutely necessary armor also became very popular. Such troops generally didn't wear gauntlets so swords with advanced hilts were needed to offer protection for the hand. Figure.2 shows the Italian rapier hilt which was fully developed and favored by the lightly armored Italian infantryman at that time.

Boarding Sword,

Accession Number: 3261

c1500-25

Italy (Venice)

**Figure 65: The Boarding Sword**

Starting from the end of the 1400s, warfare at sea gradually expanded in Europe. Essentially, warfare at sea is a contest about maritime lines of communication, which were "used for trade, for the projection of military power and for

resource extraction"(Glete, 2000). The Spanish and Ottoman empires became the dominant naval forces during the first half of 1500s, but later in the 1600s they were surpassed by north-western Europe.



Figure 66: 1500 Gentile Bellini, Miracle of the Cross at the Bridge of S. Lorenzo Galleria dell'Accademia, Venice.
 (http://upload.wikimedia.org/wikipedia/commons/d/d4/1500_Gentile_Bellini%2C_Miracle_of_the_Cross_at_the_Bridge_of_S._Lorenzo_Galleria_dell%27Accadem)

The Boarding Sword in the Higgins Armory from around 1500-25 originated probably in Venice, Italy. Being dominant in both warfare and trade at sea, northern

Italy "was economically and technologically the most sophisticated area of Europe"(Glete 2000). As a very important city of Italy and the origin of this boarding sword, Venice was a great ship owning city and served as a middleman between Asia and Europe.

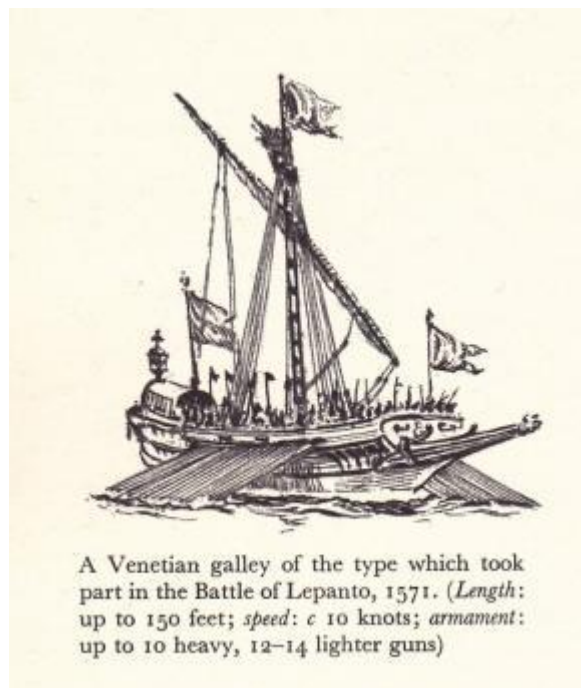

Figure 67: The Venetian Galley

In the 16th century Venice typically fought on the Venetian galley (figure.3). This kind of ship sails at around 240 nmp (nautical mile per) 24h.

Note:1 nautical mile = 1.852 kilometers. (Warner 1968)

Until the 1500s, Europeans hardly had any direct contact with East Asia nor America. As history tells us, Columbus did not sail and discover the "new land" - America, until 1492. Therefore lots of naval events mainly concentrated in the

Mediterranean area, where this sword may have seen action in combat at sea.

Throughout the 15th century, there was the tendency for swords to be made lighter. The boarding sword probably followed that tendency, especially when warfare at sea was actually more difficult than cases on land. At minimum a crew of well trained mariners and sufficient supplies were needed for sailing at sea. Due to the difficulties of sailing, this sword was typically



Figure 68: A representation of the Battle of Lepanto in 1571, a crushing defeat of a massive Turkish fleet by the forces of Don John of Austria, representing Spain, Venice, Genoa, Malta and the Papal States (Oliver 1968)

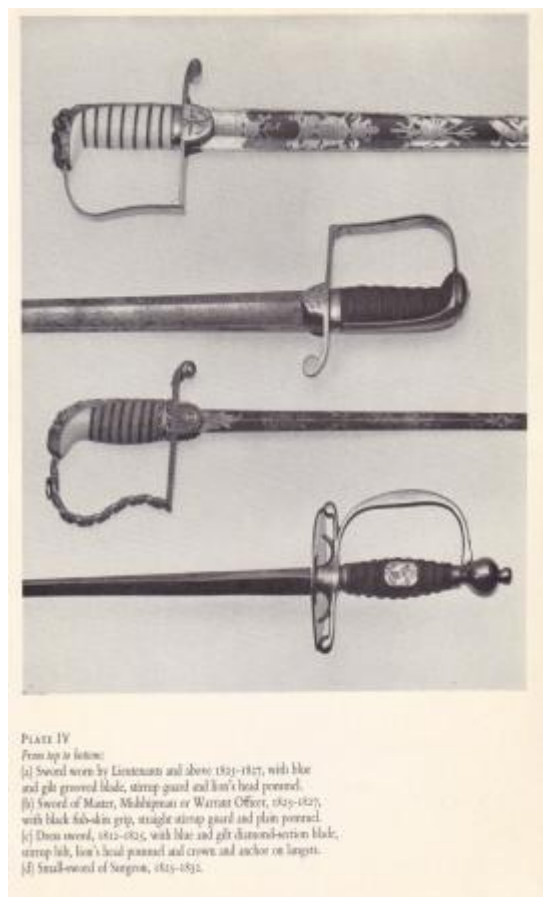

Figure 69: Typical swords for the British officers early in the 19th century (May 1962)

designed and made for shipboard use. "Its short length made it suitable for close-quarter fighting, the flat profile was ideal for storage in a sea-chest, and the saw-toothed edge may have been intended for use against heavy lines and cables. The reinforced point would have been effective against the light body armor often used at sea."(Higgins)

This boarding sword was probably one of the earliest naval swords. Later the British developed a uniform pattern of swords for naval officers in the early years of the nineteenth century. Thinner and

lighter swords

came up much

more handy in the

melee of a sea

battle than the longer rapiers and military broadswords. Also the swords became much more decorative as fashion became more important on those days. Some naval officers ended up bringing their smallswords onto their ships as shown in figure.5. However, broader swords (as shown in figure.6) known as the cutlass were also developed. Those swords resembled the Venetian boarding sword much more and were

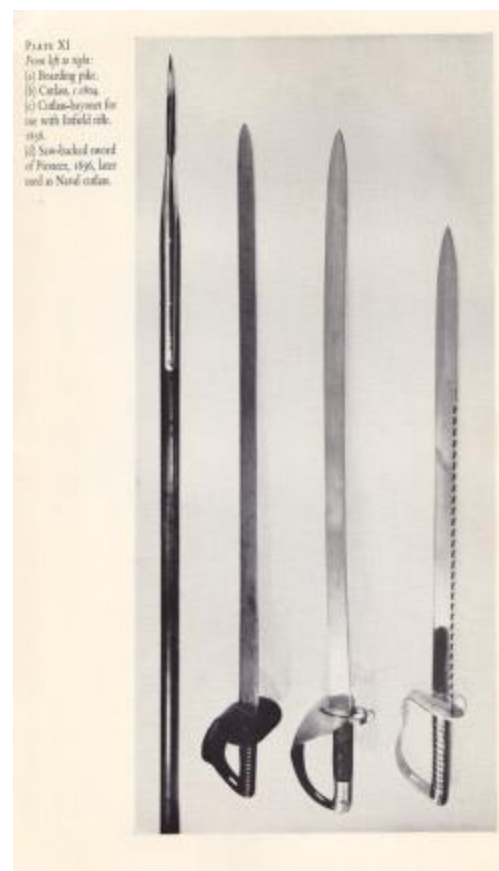

Figure 70: Pike and cutlass in the 19th century (May 1962)

used for similar purposes like cutting through enemy bodies and causing damage to the ships.

Smallsword

Accession Number: 1999.02.1

England (perhaps Birmingham and

Burslem)

c1790



Figure 71: Smallsword

In the second quarter of the 1600s,

the smallsword was invented due to

the development of new fencing techniques in France. The new techniques required great speed in both attack and defense, and the use of the point of the sword was preferred. Therefore, the smallsword came in as a quicker and lighter sword to replace the rapier. Also, the smallsword was always made very decorative because it was "worn principally as an adjunct to civilian dress"(North 1982).

The earliest known smallsword was made in 1635. Near the end of the 1600s it became the most fashionable sword in civilian and military use almost in the whole Western Europe. The smallsword continued to evolve and different styles and designs were developed. The most beautifully decorated smallswords were probably the neo-classical style swords made by goldsmiths and silversmiths for presentation purposes in the late 1700s. Those swords were rewards for military or naval success and were luxuriously decorated with jewelry. The smallsword remained popular in dueling and all the other uses as a weapon until the end of the 1800s.

Increased mechanization in the 18th century accelerated the process of standardization of military equipment. Regulations were gradually issued to set out details on the appropriate swords that soldiers and officers should wear. "British infantrymen carried a sword until 1786 when they were officially withdrawn"(Wilkinson 1967). British officers continued to carry swords mostly in the style of a small-sword with a fairly light blade. An official order was made in 1796 setting out details of the swords officers should wear: "a hilt of gilt brass with a straight blade, although this might be single or double edged"(Wilkinson 1967). However, the smallsword we have here has a triangular section, which was introduced from Germany in about 1660. This type of design combined strength and lightness and was almost perfect as a thrusting weapon. It is also referred to as the "hollow blade", since it was "a blade with a hollow back in which mercury is placed so that, in its descent, it gives an impetus to the blow"(Avlward 1946).

This fascinating sword was also witness to the Industrial Revolution, where the famous metal smith Boulton and the potter Wedgwood were both involved. Boulton was the first manufacturer to produce civilian dress swords in factory. By the 1780s, Boulton and Wedgwood cooperated to make jasperware plaques fitted with cut-steel faceted beads

resembling the shape of diamonds.



Figure 73: 1792 portrait of Matthew Boulton(http://en.wikipedia.org/wiki/Matthew_Boulton#cite_note-wedgwood-37)



Figure 73: Portrait of Josiah Wedgwood (http://en.wikipedia.org/wiki/Josiah_Wedgwood)

Matthew Boulton (3 September 1728 – 17 August 1809) was known as the chief producer of decorative metalwork of Britain in

the 1700s. He inherited his father's 'toymaking' business and developed it further by himself. By 1766, Boulton's factory at the Soho Works in Birmingham had a team of 600 employees and more than 60 workshops. In the end his factory became one of the most famous factories for polished metal products in Britain.

Josiah Wedgwood (12 July 1730 – 3 January 1795), founder of the Wedgwood company, was well known for his excellence in pottery. His works were highly appreciated by the highest level of nobility in Britain, including Queen Charlotte. He was also a prominent slavery abolitionist and was known for his "Am I Not A Man And A Brother?" medallion.

Boulton and Wedgwood were both interested in producing decorative items for the aesthetic purposes at their time. Despite possible competitions in business, Boulton and Wedgwood were actually sincere friends and held great respect to each other. As it says on a letter Wedgwood wrote to Thomas Bentley in September 1769: 'It doubles my courage to have the first Manufacturer in England to encounter with - The match likes me well - I like the Man, I like his spirit' (Smiles 1894). For several times they collaborated to produce some small decorative items like buckles, jewellery and personal accessories. Boulton and Wedgwood were both members of the Lunar Society, "a dinner club and informal learned society of prominent figures in the Midlands Enlightenment, including industrialists, natural philosophers and intellectuals, who met regularly between 1765 and 1813 in Birmingham, England" (The Wedgwood Museum)

Japanese Swords

Katana (sword), late 1700s-early 1800s

Accession Number: 1860

Japan

late 1700s-early 1800s

Figure.1



Figure 74: Katana

Wakizashi (short sword) 1500s

Accession Number: 2290.1

Japan

1500s

Just like the Europeans, ever since the invention of swords in the Bronze Age the Japanese had used swords as a primary military weapon. It was probably



Figure 75: Wakizashi

the Chinese who made the earliest swords in Asia, which typically had a straight long shape (figure.3, a typical Chinese sword in the Han Dynasty).

Early in the Heian Period (794-1185) the Japanese sword acquired its unique form which was different from any other Asian swords like the Chinese or Korean swords. It didn't take too long then for the Japanese swords to become the "samurai" sword that has the long elegant curve we are familiar with today.



Figure 76: Japanese Sword
<http://s3.amazonaws.com/files.posterous.com/temp-2011-04-06/kwtkBFpstramfdmGdtFuGINemyEkjfmjgooqcEptqEFojkxubuijfnBvrqyn/2.png.scaled500.png?AWSAccessKeyId=AKIAJFZAE65UYRT34AOQ&Expires=1320955805&Signature=f>

Japanese swords mostly fell into three types: tachi, katana and wakizashi (from long to short). The tachi was the predecessor of the other two types and was longer and more curved. The length of the katana ranged from 60 to 73 cm whereas the length of the wakizashi ranged from 30 to 60 cm. Sometimes the katana and wakizashi could be very

similar to each other, only differentiating in the way they were worn and the fittings of the sword. However, rather than a primary battlefield weapon, the wakizashi was considered as a secondary sword used to deliver the final thrust on defeated enemies. It was also known as the “Honor Blade” which was used for the Japanese ritual suicide.

It is surprising to know that the swordsmith (kaji) was of the artisan class, which was after the farmer and the military class. However, the swordsmith and the amourer were privileged for furnishing the samurai’s all important equipment, and “nobles,

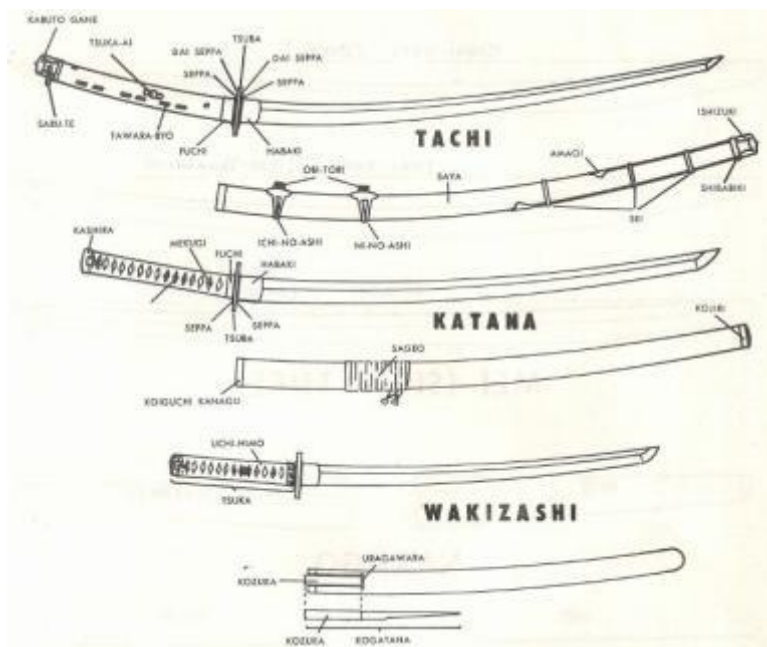

Figure 77: Types of Japanese Swords
<http://home.comcast.net/~colhartley/Oriental/TypesOfSwords.jpg>

and even emperors, have been known to work as kaji” (Robinson 1969).

The sword is believed to have a spirit in Japan, making it a great companion of the samurai. Therefore the forging of a sword was also considered as a religious act. The workshop had to be purified before the forging of any new swords. The swordsmith was required to live on a special vegetable diet and without the normal desires of a human (probably not allowed to have sex). He had to concentrate all his body and heart in the sword forging. When the forging actually began, the swordsmith offered prayers to the kami (god in Japanese) with his assistants. Then they prepared the metal and started hammering.

After a long and careful process the sword would finally be completed. The sword was always polished again and again by the smith until he was satisfied. The smith believed that the sword inherited his character and had unique qualities which "made his blades superior to others"(Robinson 1969). Usually the smith would chisel his name on the tang when the sword was finished.



Figure 78: Sanjō Munechika (938-1014) forging the famous blade Little Fox aided by the fox-spirit in the form of a woman, by Utagawa Kuniyoshi (1798-1861). Black ink and tinted colours on paper. Japan, c.1835.

When finally being completed, the sword is not only a extremely effective weapon but also a

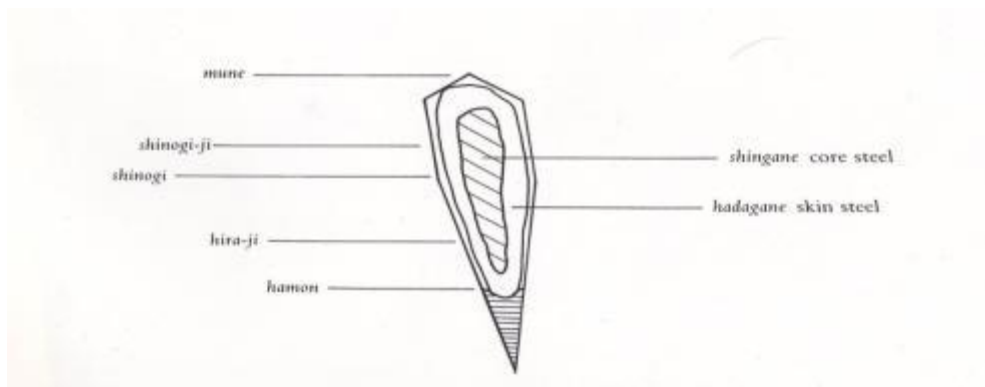

Figure 79: Metallurgy of the Japanese Sword (Coe 1989)

masterpiece of art. The beauty of the sword was regarded by the Japanese as close to that of "sumie (ink painting) and calligraphy, widely felt to be the highest forms of art" (Coe 1989). The finished blade would have a fine visible grain pattern resulted from the forging process. The

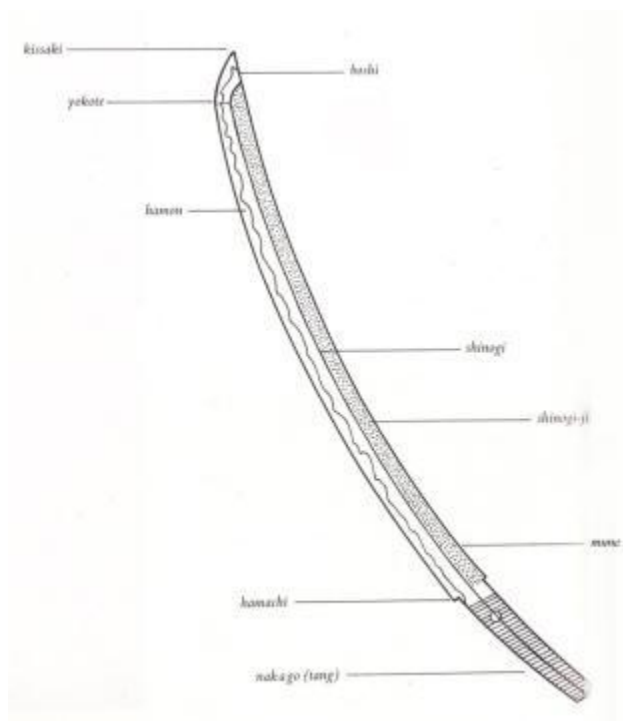

Figure 80: Metallurgy of the Japanese Sword-b (Coe 1989)

shown in figure.8). It is extremely hard and can cut through enemy bodies easily.

grain pattern from different swordsmith was different and therefore could be used to identify the maker. As shown in figure 6 above, the shingane (core steel of the blade which contained less carbon than the hadagane) was covered by the hadagane, giving the sword the resilience to resist the brutal impacts of battle and the sharpness to cut through tough enemies.

The most deadly part of the blade, the hamon, always has a beautiful pattern on it that looks like the forms from the great nature - clouds, mountains, mists etc (as



Figure 81: Beauty of the Hamon (<http://www.sword-buyers-guide.com/images/PPK-hamon.gif>)

After being forged, the sword was then generally tested upon criminals by an officially appointed skillful tester. The tester would perform different cuts on the criminals' bodies to prove the sword's

effectiveness. Sometimes the results of the tests were recorded upon the tangs of the sword stating the many lives such sword had taken.

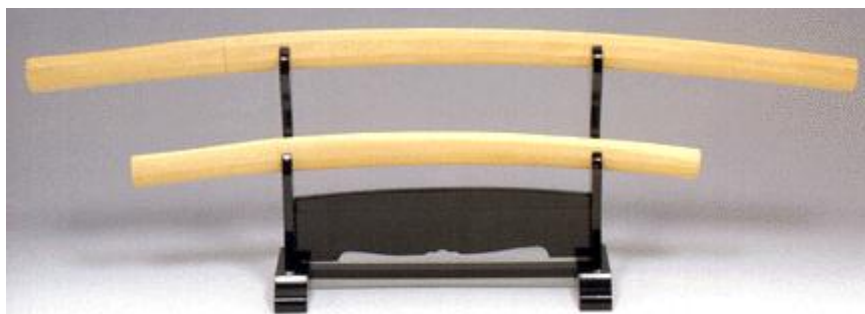

Figure 82: The shirazaya (<http://www.kura.com/jpart/shirazaya.gif>) case called the shirazaya (figure.82).

When the sword was finally ready to be purchased by a samurai, it was equipped with a white-wood storage

The sword's mounting and fittings (e.g. style of the hilt and scabbard) would be chosen by the samurai in his own taste. Very often by this time the sword would be embellished with a chiseled design of some sacred creature such as the good-luck god Bishamon-ten, the Buddhist deity Achala or dragons.

The samurai had been the primary military force of Japan starting around the 10th century. They followed a set of rules known as the bushido, which mainly taught them to have honor, dignity and loyalty. Later in the 19th century, the era of samurai finally came to an end as Japan completed the transformation into modern warfare. The samurai class may have been abolished, but the heroic spirit remained.

Folding Spetum

1999.01

1400's Milan



Figure 83: Folding spetum: the folding spetum fully unfolded

The spetum's unique form, fighting style, and the major users of this weapon make it one of the most fascinating items in the Armory. The spetum is composed of a long shaft, a blade and two concave wings at the union of the blade and the shaft. The spetum is believed to have evolved from a partisan, a polearm with a long blade and minute

wings on the edge of the blade near the base (Snook 1998). In the 1400's and 1500's these wings became much more pronounced and began to take on curves inward, toward the blade, or outward toward the butt of the weapon (Snook 1998). So, while a spetum is any partisan with inward facing wings, a corseque would be a partisan with outward facing wings. These wings were not simply for show, but were sharpened and could potentially be used to thrust or slash at an opponent (Snook 1998). The wings and the long blade made it easy to deflect blows from an attacker (Monte 1509). One contemporary, Pedro Monte describes the fighting style of the spetum as:

“As to specific blows for harming the enemy, there are few who have any great secret with these weapons...the trick lies in parrying and setting aside the opponent's weapon” (Monte 1509)

The most effective use for this weapon was not to directly attack the opponent, but instead to disarm them. This style of weapon was therefore an effective tool for bodyguards of

Figure 84: Evolution of the Spetum: Note the outlines of the partisan, corseque, and chauve souris. Note the small wings on the partisan (63), and the wings polearms that evolve from the partisan. The spetum (66), displays concave wings, and the chauve souris (50) is an elaborate modification of the spetum's form. The corseque (51) however, has wings bent outward. Figures adapted from "The Halberd and other European Polearms ". Snook, George. 1998.

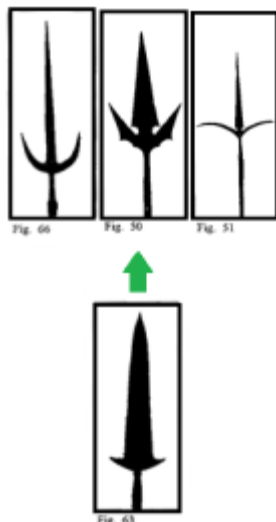

the royalty to use in crowd control

(Waldman 2005). This amazingly intricate folding apparatus of the spetum actually had nothing to do with fighting with the spetum and everything to do with portability (Walman 2005). Because such apparatus requires much more labor to create, this was likely made for a wealthy man or his guards to use while travelling

or hunting (Waldman 2005)

The attention to detail in the craftsmanship of the spetum indicates that it was created by a very fine artisan and is a prime example of renaissance Italian weaponry. During the late 1400's and 1500's Milan was a major hub for supreme armorers and weapons crafters. One of the most well-known artisan families of this time were the Missaglias. There were many famous artisans in the Missaglia house but probably one of the most talented armorers was Filippo Negroli (Breiding 2002). Filippo Negroli was often commissioned to produce pieces for the Holy Roman Emperor. In this time a beautifully crafted, gilded weapon was considered as much a piece of art as a painting or sculpture (McIver 2006).

This spetum was clearly created by artisans of the caliber of the Missaglia, evidenced by the elaborate folding mechanism, steel blade, and gold inlay.

The materials and techniques used to create the spetum are evidence of its grandness , and showcase



Figure 85: Close up of folding mechanism: spetum with base folded in

many techniques of weapon crafting in this period. The spetum is made of iron, steel, and a wooden handle with gold inlay. The iron and steel portions were likely forged in a charcoal furnace (Williams 1999). The blade and wings of the spetum are steel, and are one of the clues that this was a luxury item. Steel was a higher class metal than iron, and cost nearly 3 times as much per pound (Williams 1999). The gold inlay is another feature that was indicative of ceremonial weaponry, particularly at this time. Early in the 1500's there was a significant increase on the amount of gold and gilding of especially ceremonial weaponry (Williams 1999).

This piece was clearly made for one of the famous ruling families of the renaissance. This piece was made in Milan, which was the home of some of the most prominent ruling families of Italy including the Sforza and the Visconti (Black 2009). Though the spetum was probably made in Milan then exported, these families are representative of the caliber of family that this spetum likely belonged to.

The folding spetum is a challenging piece to bring to life in text alone. The main obstacle with this piece is that it is difficult to visualize the way the piece moves when it is stationary. The best way to explain the spetum is by showing the visitors footage of the spetum in motion with a voiceover, or overlay text, that explains the function and historical context surrounding this artifact. This content will certainly contain general information on the spetum, it's form and function as well as the fighting style associated with it. However there are several options for additional historical information that could be provided in this content. The initial plans were to explore the crafting of weaponry in renaissance Milan, the evolution of polearms, or the ruling families in renaissance Europe. Craftsmanship in Milan is a unique topic with a prominent history that would be relevant and interesting. Using the ruling families in Europe might allow us to tie the spetum to historical figures, allowing patrons to build off of their own knowledge

base. Therefore, this research focused more on expanding and exploring the basic uses of the spetum, the crafting of weapons in Milan, and the spetum's place in society.

Jamadhar

1553, 1552, 1108.a

1600 India

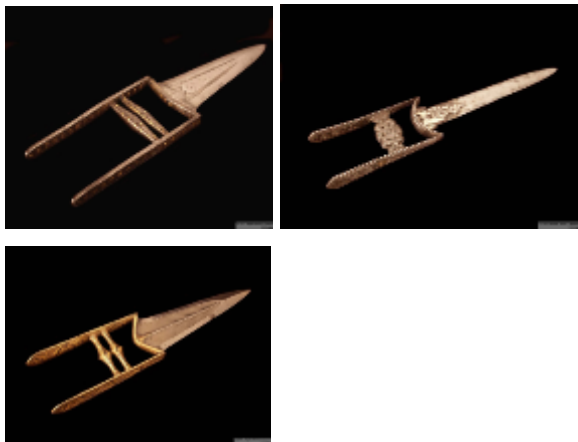

Figure 86: Top left: Artifact 1108.a jamadhar for a child, top right: 1553 a jamadhar from south india, European blade. Bottom 1552 a north indian jamadhar

The jamadhar is a classic piece of weaponry that is native to India and found nowhere else in the world. In the 1500's and 1600's, it was one of the most common and popular weapons to carry.

However, the jamadhar has never been a military weapon, it was mostly found on princes, kings, and assassins. The name "jamadhar" comes from a combination of two Sanskrit words: "jam" meaning

the god of death, and "dhar" meaning sharp edge. The blades were double edged, around one foot long. The handle is unique, always having a characteristic H-shape. This allows the dagger to be gripped easily, while the sides of the "H" protect the owner's hands. The dagger is used as a simple thrusting weapon that is incorporated into a boxing fighting style. Though here we have only examples of 1 bladed jamadhar, nearly every permutation of this weapon imaginable was created. Jamadhar could have up to 5 blades that fanned out radially from the hilt. Alternatively, one dagger could be concealed inside a larger hollow jamadhar. There is even an example of a "jamadhar pistol" in which the two legs of the H-shaped handle can be attached to the barrels of two pistols. Though these pieces are not quite so extravagant, it is interesting to note that these are a part of a much larger category of Indian weaponry. (Pant 1970, 1980)

This collection of daggers includes 2 of north Indian origin and one of southern Indian origin, so along with being a classic representation of weaponry of this period, they also represent the regional differences that spread across the Indian subcontinent. As these pieces are

a representation of Indian culture, a good grounding in Indian history is necessary to understand the context of these pieces. The early history of India shows the different development of northern India versus the south, so understanding the early regional development is key to understanding this collection. Studying the rulers and ruling dynasties of the 1600's can also give a better context for these pieces.

The Gupta empire reigned in the early 300's A.D. This period was one of the first fully cohesive societies in Indian history. The religions that developed in earlier times became established across India; Vedic Hinduism, Buddhism, and Jainism. Vedic Hinduism dominated the peninsula, and for many years, and to this day India was heavily influenced by the Vedic Hindu caste system. The system consisted of two different classification schemes, *Varna* and *jati*. A Varna was an occupational classification, either priest, warrior, merchant/farmer or servant. These classifications were widely accepted throughout all of India. Jati, however were social and hereditary classifications, and compared to the Varnas were determined much more by

regional influences. (Walsh 2006)

One of the biggest changes to Indian ruling society occurred with the advent of Muslim and Turkish rulers in the region, particularly the north of India. In the early 1000's northern India was taken over by Mahmud of Ghazi, of the Ghazni kingdom from the afghan region (Kulke 1997). His campaigns were brutal; he caused destruction and looted the major temples of the



Figure 87: Map of Ghurid conquests: this map shows the expansion of the Ghurid empire

region (Walsh 2006). Mahmud was succeeded by the ghurids, who took the existing kingdom and made a serious effort to expand it until they controlled all of northern India.

At the end of Ghurid rule, northern India, along with southern India, was controlled by the Delhi Sultanate. The sultanate was not so much a dynasty as a series of 5 separate dynasties, the Mamluk, Khalijis, Tughluqs, Sayyids and Lodis (Walsh 2006). These dynasties were a collection of Turko-Afghan regimes of Muslim rulers that controlled India for the 300 years (Metcalf 2002). Though they were Muslim rulers, they did not actively seek to convert their empire to Islam (Metcalf 2002). However, there were many that left the Vedic Hindu religion with its strict caste system, in favor of the relatively lenient requirements of Islamic traditions.

In 1526, the Lodi Dynasty of the Delhi Sultanate was succeeded by the Mughal empire (Metcalf 2002). One of the most famous Mughal rulers is Shah Jahan, a master military strategist who commanded a total of 102,00 heavy Muslim cavalrymen (Bronkhorst 2007). The majority of our knowledge of Shah Jahan's rule comes from the Pad shah Nama of 1647, an illustrated text of the history of Shah jahan's rule created for him (Bronkhorst 2007). the Shah was a major patron of the arts, and his art and architectural program has been far more memorable than his military campaigns. He created the beautiful peacock throne, and the Taj Mahal, now considered one of the 7 wonders of the world (Bronkhorst 2007). The jamadhar is a piece that may be cotemporary to Shah Jahan, and was likely owned by a wealthy family of the time.

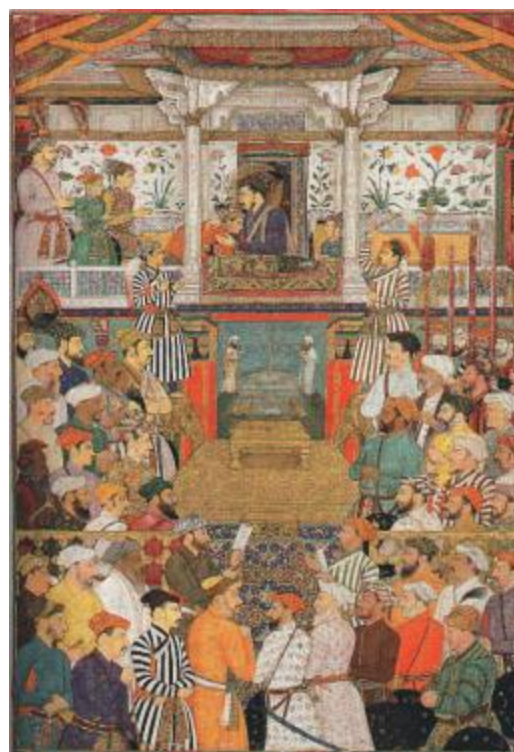

Figure 88: A plate from the Pad shah Nama: This piece shows Shah-Jahan and his three eldest sons and Asaf Khan during his accession ceremonies

In fact another dagger embellished with gold and jewels was owned by Shah Jahan, and was recently sold for 3.3 million dollars (prince George Citizen 2008). One of Shah Jahan's wives, Nur Jahan, is known to have had a beautiful dagger made of ruby (Pant 1980). Shah Jahan's father, Jahangir, also owned an elaborate jamadhar that he used as a hunting knife (Pant 1980). There are many accounts of jamadhar in the age of shah Jahan including this story recounted in "Indian arms and Armor" by G.N. Pant:

"the Hindi poet Banwari describes that one Salawat Khan, the general of Shah Jahan, abused Amar Singh of Rajasthan, in Mughal court. Amar Singh got furious and with his jamadhar killed Salawat Kahn then and there"

As seen in this story, jamadhar were not simply to show the wealth and status of the owner, but could be very deadly.

Shah Jahan ruled from 1628 to 1658, when he fell very ill his sons began fighting each other to take his place. The Mughal dynasty continued until the mid-1800's when Britain took over India.



Figure 89: Jamadhar are pictured on royalty in many pieces of Indian art, such as the plate above picturing a prince with a jewel encrusted jamadhar in the belt around his waist.(Pant 1980).

Though the northern empire of the Mughals and the southern Hindu empires were based around different cultures, most specifically the Muslim Mughals and the Hindu kings, both cultures were nearly identical. In fact from looking strictly at images of prominent figures on both sides it is nearly impossible to spot differences in dress or weaponry (Nicolle 1993). The jamadhar in particular was common to both cultures. The belief that it was strictly a Hindu

weapon is completely false, as it was a common tool of the Mughals as well (pant 1980). There are some distinct differences between north Indian and southern Indian jamadhar. The south Indian daggers tend to be broader at the hilt and have elaborate grooves in the blade (pant 1980). Due to the European forays into southern India at this time, there are also many examples of jamadhar made with European blades instead of the hilt and blade being continuous, including the example here number 1552 (pant 1980).

Breast plate from siege cuirass

Northern Europe (perhaps Germany),

1590-1600



Figure 90: Breast Plate from a Siege Cuirass

This breastplate is a perfect example of the military revolution of the 1500's. During this time there were drastic changes to military technology, strategy, and demographics, and this breastplate represents of all these changes. The piece was developed in the period where gunpowder weapons were first coming into widespread

use, which was the main cause of all this uproar. Though guns were developed earlier in history, they did not dominate the battle field until the end of the 1500's. This development affected every type of warfare. This breastplate was made specifically for siege warfare, and the use of large guns in siege warfare was very apparent as early as 1400. Their drawbacks, they were heavy to transport, relatively inaccurate, and slow to fire, were inconsequential against large castles. The adoption of such guns led to a need for major improvements to armor and the structure of armies. However, these changes were too much for the armor industry and armor gradually became obsolete. (Williams 2003)

With the advent of firearms, armorers needed to prove that their armors could effectively protect the wearer from gunfire. One of the most common methods for demonstrating the strength of the armor was by proofing. Proofing was the firing of a gun at a piece of armor to prove that it could withstand a bullet. Blair said of proofing in the 1500's that "fine quality armor had always been tested or proved on completion by discharging the most powerful hand weapon of the day at the breastplate backplate and helmet" (Blair 1979). Both iron and lead bullets were

used in proofing armors, and by looking at the dents from proofing you can tell which metal it was proofed with. Lead bullets, being so soft, deformed on impact and left an oblong, or irregular dent, but iron left a perfectly round dent (Williams 2003).

Traditional armors could never have withstood a bullet, lead or iron; they were designed to withstand blows from a sword, and the force exerted by a bullet was many times greater.

There were three main changes to the style of armor to protect from bullets: the thickness of the armor, the angle of plate, and the quality of the steel. A bullet of this time exerted about 2000J on the armor. To withstand that kind of force, a thickness of steel of about 3mm was required. The armor was also made much more globular at this time. This meant that bullets rarely impacted the armor dead on, and were much more likely to glance off at an angle. Clearly, the more obtuse the angle of the impact was, the less force the armor had to absorb, so rounder armor fared better than flatter armor. There were also some improvements to the quality of steel at this time, but it was much more common to increase the thickness of the metal to create bulletproof armor. The thickness of armor, especially horseman's armor, tended to increase from 1450 to 1650. There were drawbacks to this strategy, namely weight. In the 1300's and 1400's armor rarely weighed more than 15kg but by the late 1500's average weight had risen to 25 kg. There were a few other changes specifically made to the breastplates at this time. In particular the breastplate was made much higher, and longer to increase surface area (Blair 1979). From the end of the 1500's special siege armor was made chiefly for use by sappers, the engineers of siege warfare (Blair 1979). (Williams 2003)

Around this time there was a significant decline in the use of armor. In the early 16th century breastplates became commoner, but heavier, so soldiers began to wear only the helmet,

breastplate, and back plate not the other pieces of the armor (Blair 1979). A famous military strategist published his opinion on the declining use of armor in 1590:

“they thinke verie well armed with some kind of head peece a collar a deformed high and long bellied breast, and a backe at the prooffe, but as for pouldrons, vambraces, gauntlets, tasses and greves they hold all for superfluous...the imitating of which their unsoliderlike and fond arming cost sir Philip Sidney his life by not wearing his cuisses” (Blair 1979)

Note the reference to “at the prooffe”, indicating that essentially all armor had been proofed by firing a weapon at it. Despite Smythe’s arguments, from about 1570 on, full armor was worn only by the most conservative (Blair 1979). The weight of the armor was certainly the limiting factor. Another contemporary, Montaigne claimed in 1580 that “as many men were lost by the weight of their armor as were saved by its protection” (Williams 2003). This led to a habit of donning armor at the last possible minute. Another factor that decreased the use of armor was that the cost of armor increased greatly in the mid-1500s onward because better and more material was required to make bullet proof armor. The better quality metal was too expensive, and especially as highly skilled bowmen were replaced with less skilled gunners, the money that was available for soldiers to spend on their armor decreased. Armies could no longer afford armor and the industry slowly declined, becoming essentially obsolete by the beginning of the industrial revolution. (Williams 2003)

This breastplate was made specifically for use in siege warfare so it is important to explore the changes in warfare at this time, particularly sieges . In a traditional medieval army, men served for a limited time in return for land terms (Ropp 1959). Field armies could only feed

themselves few weeks of summer; armies could hide behind a fortress and be completely safe from attack (Ropp 1959). There are three main points summarized by Geoffrey Parker of a medieval army that changed drastically with the development of firearms.

- “
- 1) localization of military power therefore of economic and political power
 - 2) Technological advantage of defensive over offensive
 - 3) Centralization around heavily armored and armed horsemen” (1997)

As guns became more prominent, slowly the artillery began to emerge alongside the other branches, the cavalry and the infantry, with its own skilled technicians such as the wheelwrights, carriage makers, carpenters, gunpowder experts, and metal foundries. One of the reasons for the slowness of the development was the difficulty of transporting such large guns from one place to the other. A full cannon of the mid-sixteenth century weighed over 8,000 pounds and they were nearly impossible to relocate during battle. At the battle of Rocroi it took hours and a dozen horses for the French to move only 2 artillery pieces. However, this meant that armies with large firepower now have many new tools available to them for siege warfare. Now, the offensive side of the battle has a much better advantage than the defending side. Heavy artillery was extremely effective against the medieval castles; their high thin walls were designed to withstand scaling ladders and under cannon fire they crumbled. (Tallett 1997)

One of the classic examples of the differences of siege warfare, Charles the VIII's French invasion of Italy, was recounted by Guicciardini, a contemporary military historian, in 1530:

“Before the year 1494, wars were protracted, battles bloodless, the methods followed in besieging towns slow and uncertain; and though artillery was already in use it was managed with such want of skill that it caused little hurt. Hence it came about that the ruler of the state could hardly be deposed. But the French in

their invasion of Italy infused so much liveliness into our wars that up to the year 1521 whenever open country was lost [thus making siege possible] the country was lost with it.” (Hall 1996)

Clearly after the rise of firearms, the strategies and importance of siege warfare changed. The military writer Vauban categorized the two main objectives and strategies of siege warfare: Breach the wall with guns, and move up the trenches to get a better position (Hall 1996). The most important point in both of these objectives is the focus on the guns to attacking the wall. Therefore, wars became influenced more by force of weapons than the number of men an army had (Parker 1997). But just as artillery was revolutionizing siege tactics, military engineers were improving the style of fortifications to withstand these new technologies. Walls were built lower and thicker with wide moats around them. However this was very expensive and difficult to accomplish. Though this new strategy was an important attempt to adapt traditional defensive strategies, the expense was too much for most kingdoms. (Parker 1997)

There is so much content that has been closely related to this piece that it is difficult to choose a specific part to focus on. If good visuals can be found the concept of proofing would be interesting, because it is very unique to this period. showing the differences between pre firearm armor and post firearm armors and perhaps showing a metamorphosis between the two could be really informative. A depiction of a siege could also be very relevant, maybe a walkthrough of a siege battle with key points highlighted, possibly exploring Charles the VIII’s invasion of Italy using some of the contemporary accounts of that battle, simply because it is so iconic. The biggest challenge with this piece is incorporating all of the information into a succinct, functional piece of content.

Bronze swords

220 and 238.101

Central Europe 6th century, 1300-900 B.C



Figure 91: top- 238.101 bronze sword about 1300-900 B.C. bottom-220 6th century B.C.

The bronze swords are a classic representation of the bronze age in northern Europe. The European bronze age stretched from 2300 B.C. to around 800 B.C., and was clearly marked by a use of bronze as the metal of choice (Scarre 1996). The sword was one of the major features of the Middle Bronze Age, and by 1600 B.C. it was widespread in Europe (Vandkilde 2007).

One of these swords has been dated to the late bronze age and the other is dated to the iron age.

During the iron age, bronze was still used, particularly for elaborate or decorative items

(Coe). When studying any artifacts from

northern Europe of this age research relies

heavily on archaeological evidence because there is no written record, unlike other societies of this time such as the Myceneans and the Egyptians. The development of swords in Europe was also completely separate from development in these areas of the world (Fagan 1996).

The sword was an integral part to the culture and history of the bronze age.

The Bronze Age is divided into three stages, early 2300 B.C.-1500 B.C., middle 1500 B.C.-1300 B.C., and late 1300 B.C.-800 B.C. (Scarre 1996). The early bronze age was the age of the dagger while the late and middle bronze age was defined as the “golden age of the sword”

(Vandkilde). Bronze age Europe was defined by a multitude of small scale societies with small villages, that gradually developed into some more concentrated centers that would become the fortified towns of the Iron Age (Scarre 1996). Clearly in the Bronze Age the most important metal was copper, and there are many large mining sites that are well known such as the Mitterberg mine in Austria. Ore was extracted using wedges and picks and fire setting (Scarre 1996).

In northern and central Europe there were two major cultures of the middle and late Bronze Ages, the Tumulus and the Urnfield (Vandkilde 2007).

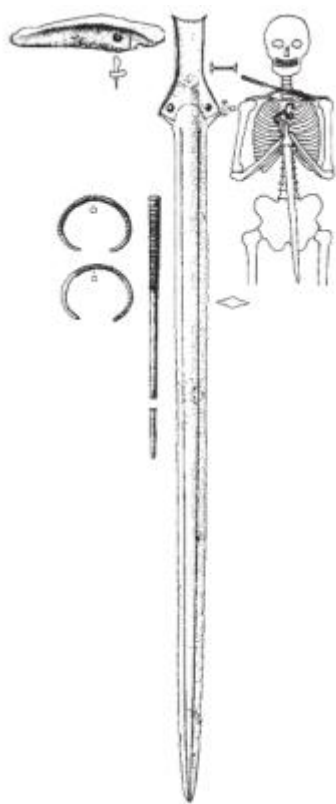

Figure 92: the items from a burial in Bavaria, featuring the sword prominently displayed centrally on the body

These cultures are mostly defined by their burial methods, and the differences between the two likely is a result of different religious beliefs about death and the afterlife (Scarre 1996).

Tumulus culture was defined by interring their dead, Tumulus means mound or barrow indicating the burial of bodies in mounds (Scarre 1996). The items that people were buried with tell a good deal about who they were and the society of the Bronze Age. Burial with swords, in particular, is a sign of the upper echelon of society, top level princes were buried in immense wagons with many artifacts including swords (Vandkilde 2007). These sort of elaborate burials occur all across Europe from Italy to Denmark and France to the Balkans (Vandkilde 2007).

The Tumulus societies were succeeded by the Urnfields. Around 1300 B.C. it is clear that society changed, especially funeral practices, and cremations replaced burials (Scarre 1996). Ashes were collected and placed in an urn in an “urnfield”, so the name arises (Scarre 1996).

This method was widespread across Europe, and common burial themes exist on both sides of the continent. This gives some evidence that there was a clear exchange network across Europe. Valuable goods and personalized gifts traveled long distances and may have played a role in developing of early political alliances. This focus



Figure 93-recreation of an urnfield funeral for an upper echelon member of society

on goods brought bronze smithing to a major part of Urnfield society, and bronze was deeply integrated into daily life. Metalworking was likely organized into two major groups, small things for ordinary life and larger more technically demanding pieces with great decoration and detail for rituals and the elite. The urnfield culture saw a great increase in population in concentrated fortified sites. Small villages housed around 60-180 people but the fortified cities housed from 600-1000. These fortified towns were located on top of a hill overlooking a series of villages. The rise of these fortified towns is an indication of the rise in warfare in Urnfield society. (Vandkilde 2007)

Warfare in urnfield society was common and played a function in societal organization. The wars between communities required a military organization. There were massive amounts of weapons that are weathered from action and use, and many skeletal remains show trauma. Warrior representations in art and depictions from the bronze age are likewise very common, so clearly war was a major factor in urnfield society. Military power was likely used to back up and enhance economic or ideological power (scarre 1996) (Vandkilde 2007)

Bronze era European swords had some very specific features and styles. The first swords, emerging in the Middle Bronze Age, were essentially elongated daggers. The triangular blade

was attached to the hilt using a row of rivets. As the techniques developed a specific style emerged the grip tongue or flange hilt, and it is one that is used in these pieces. At the hilt a tongue-like grip extends from a triangular shoulder. The leaf shaped blade in the older sword was developed specifically to allow more forceful blows to be struck with the weapon. These style of swords were found all over Europe, from the Ukraine to Spain. Some were even found in Egypt,

likely as a result of mercenaries brought to fight there. (Coe)

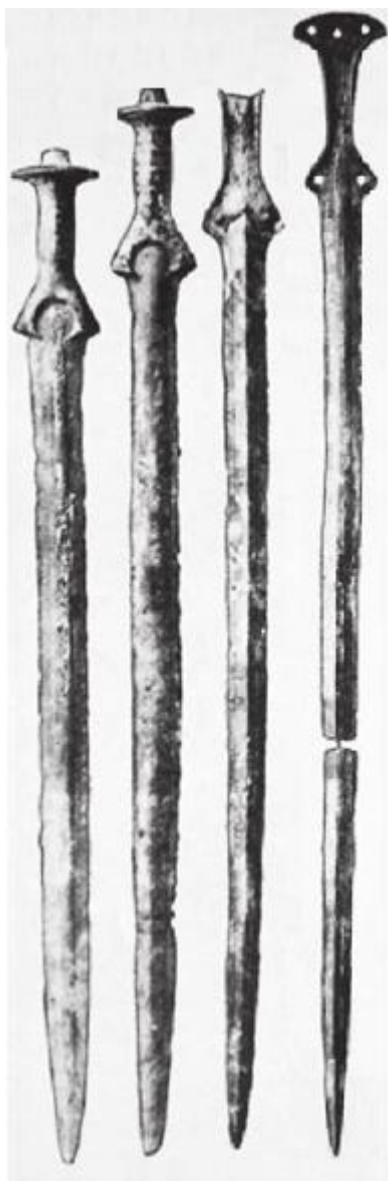

Two major categories arose in bronze age swords, a metal hilted sword, the style of both of these pieces, and an organic hilted sword for fighting. It is also possible that these two sword categories were also identifiers of different strata of society, such as between chiefs and warriors. (Vandkilde 2007)

Figure 94: two example each of the sword types in Europe. two "rapiers" on the left and 2 more organic hilts on the right

Conclusion

During A term, the pre IQP, the project team spent most of our time developing the project proposal. The team developed a plan for the project. The project team planned to create different types of content that could go onto the Virtual Armory website. Items were decided on and resources were identified for research into the history of the artifacts was done. For this project, we had a wide variety of sources available to use. The first resource was the information from the Higgins Armory Museum. The museum provided us with facts about our objects, as well as on the Higgins Armory website. The website contains the entire collection of the Armory in a database. This allowed us to look up artifacts online, and gave us starting details about each of them. A second resource is the Gordon Library. The library not only provided us with the books on the many topics, but also provided information online as well. If the library did not contain a book we desire, the Interlibrary Loan allows us to look up and order books from other libraries. Also, the librarians are a great resource, as they aided us in researching our topics.

Throughout B term the project team gathered a great amount of background information on the chosen artifacts. The bibliographies that had been developed in the past term were used as a beginning spot for our research. As the project progressed we found that many of the books in our bibliographies were inadequate for particular artifacts. Due to this many members of the group continued to add to the bibliographies that had been developed. Each group member had their own respective item to research but found that there was quite a bit of overlap in the research content for many of the items. This allowed for the sharing of books between group members and to easily add to the bibliographies.

Once the research was complete the project team was able to start developing content. The project team started out C term with the easiest types of content such as pictures or simple videos. As C term progressed the content that was developed became much more complex and in-depth. There were even a few group members who chose to disregard some of their items in order to develop extensive content for a single item. It was beneficial that we had two different types of content creation since it provides us with content for all areas and a few items with extremely well developed content.

Also during this time the project team was able to format the Virtual Tour area for the Virtual Armory website. This allowed for content to be put up on the Virtual Armory website which allowed the project team to view the content from the point of view of the patron.

Finally came D term where the main goals were to finalize the created content and develop the project report. The beginning of this part was dedicated to finishing the content that had not been completed during C term. This was necessary in order to make the website presentable. After the website was deemed satisfactory for public view the project team began working on the project presentation.

The Virtual Tour is a useful lasting addition to the Higgins Armory's Web presence. The Virtual Tour is a living format that can be easily updated by future IQP teams or the Higgins Armory Museum and changed to reflect the collection. Each item featured in the Virtual Tour has its own dedicated page on the website. In this way new pages can be easily added without disrupting any of the existing content. The division of categories in the Virtual Tour homepage is broad enough to encompass the entire collection, so new content can be easily included in the visitors' online experience. The Virtual Tour format also puts very few restrictions on the types

of content that can be added in the future, giving wide creative license for future teams while providing an easy to use template.

The team was able to generate a variety of content during this project. As a team, were able to create webpages the contained textual, audio, visual, and interactive formats. The team had multiple videos generated for the katana, matchlock musket, war hammer, jamadhars, and spetum. We had text and images for items such as the Nandaka, halberd, and gladiator page. The sword of justice and bronze swords contained interactive images. We also had a game developed that encompassed many types of weapons and armor from the entire Higgins' collection.

Overall we generated a good deal of content that is now live on the Virtual Tour. The volume of the content means that a visitor to the Virtual Tour can have a complete well rounded experience even though the Virtual Tour is brand new. The large amount of content also means that there are already 4 pieces of content utilizing the QR technology, a large enough sample size to examine the effectiveness of a QR program in the Armory.

As a team, we were able to get several different QR Codes placed in the Armory for this project. The project team placed an initial QR code for the Teuffenbach armor during the first term of our IQP. By the end of the IQP, we had placed four other QR codes in the Armory. The artifacts that the team generated QR codes for were the katana (1860), the Nandaka (1495), the matchlock musket (460), and the war hammer (2005.01). Having placed these QR codes in the Armory, the patrons will be able to have a variety of educational resources when visiting the museum.

Overall though the Virtual Tour was a success there were some struggles along the way. During this project, this team had many times that we found it was difficult to work on

the website. Due to the design of the Virtual Armory, changes were very time-consuming to make. When the project team had to change different items on the site, we had to go through every page and make sure that the format on all of the pages was consistent. This became particularly time consuming when designing the buttons, because each html page that was designed had to have the buttons placed individually on each page. Once a consistent format was created, the team was able to just copy and paste the format on all of the pages, but it still consumed a lot of time. Other, smaller, issues would occur, such as the copyright symbol looking like a '?' on some of the pages, and random links breaking. When issues like this occurred, the best thing to do was talk to someone at the helpdesk, and they would be able to assist us.

Another issue that came up was that the team was pressed for time. As a team, we wanted to come up with various types of content, but only wound up generating a few different types. This was due to a number of reasons, including underestimating the time it would take to work on the project, the team members working on only their own items, and having to maintain the site while generating content.

Possibly the largest issue that came up while we worked on this project was having five people trying to update the site simultaneously. This became less of an issue when we all had our own pages to develop, however, at the beginning of the project we had issues modifying the pages, since multiple team members were trying to work on the same page at the same time. Also, the permissions became an issue when working on the project. The team discovered that unless the automatic permissions tool was run, each person could only edit the pages that he/she added to the group account. This was a problem that took a while to figure out the

solution, but once the team learned to run the permissions tool after every change to the website, the permissions issue disappeared.

During the stage of developing the Virtual Tour contents, we worked as a de-centralized team. Each of us was responsible for developing contents for our chosen artifacts. This of course allowed more pieces of content to be created overall, and in fact we were able to generate as many as 12 pieces of content in a variety of formats including factual and artistic films, 3D scanning, interactive web content, as well as a flash game. This gave us a good amount of content to kick off our Virtual Tour page.

But we also faced lots of difficulties while working as a de-centralized team. Basically each of us were working on our own to develop each piece of content, which made it hard to assist each other in areas other than one team members focus. It's also hard to critique team members' work because background and goals of that section were not fully realized by all team members. Another problem that the de-centralized team brought to us is lack of communications and sharing ideas. Since each of us just focused on our own contents, we became less familiar with others' work which made it difficult in sharing ideas. On the other hand, if we could cooperate a little more, each member would be able to utilize his/her skills in developing the shared content instead of have only one of us working on it.

Our advice for future teams is to have the students work on content together. We feel that this would be helpful in developing a higher quality of content. Although this would reduce the quantity of the content being developed, our team feels that there is enough of a base that other teams should focus on working together to come up with a higher quality of content. Also, one person on the team should be in charge of maintaining the site, and not have to develop content. This would make it far easier to work on the site.

In order for future groups to work on the Virtual Armory project there are a few skills that would be greatly beneficial for them to have. A basic knowledge of HTML and Dream Weaver would help tremendously while dealing with the website. It is possible to learn this during the project but it is much better if there is at least one person who has worked with it before, perhaps even one who has created their own website. Through working on the project the group learned that it would be best if there was one person who was greatly experienced in the building of websites to be designated the web master. This person would have a responsibility to monitor the website and make sure that everything worked. Another useful skill that would be highly recommended for this project would be creativity. Someone who is pursuing a career in art could do an amazing job coming up with some fresh content for the Virtual Armory website. Having people with these skills will make working on this project much easier and will create remarkable content.

Through this project the team grew a great deal. This group went from 5 associates who didn't know each other to an actual team who knew each other's strengths and weaknesses. This team learned what was necessary to work together efficiently to get things done as well as learning individual skills. The individual members of the project gave it their all by learning about anything that they felt could be useful such as 3D scanning to a whole bunch of Adobe products. Through this project the future for the museum grew as well as each team as a whole developed.

This project group accomplished some amazing things. The group was able to give the Higgins Armory a jumpstart on new technology such as the QR codes which we began setting up in the Armory. Through the new format of the website that was created this project has integrated past generations of IQPs into the now usable website. Also with the new format future

teams will have a basis to work off of which will allow them to forge new pathways in the future.

Appendix A: Matchlock Musket

Matchlock musket Accession Number: 460- With the match lock musket the team felt that the best thing to do was to compare it to later firing mechanisms and that the easiest way to do this would be to use a video. We used this text for the background:

This matchlock musket was manufactured in late 1500's. The matchlock musket is one of the earliest firing mechanisms. To fire the musket, an ignited match cord would be lowered into the flash pan by the serpentine. The flash pan would be filled with powder, causing the musket to fire. The match cord was always lit on both ends, which could lead to disaster when the fire accidentally made contact with stored powder.

Two other safer mechanisms were also created during this time: the wheel lock and the flintlock. The wheel lock ignited gun powder roughly the same way a modern day lighter ignites the butane. The wheel lock made it possible to fire on horseback, because it did not require an open flame. However, the design was too complex to mass produce, and few soldiers could afford it. The flintlock mechanism used a flint to create a spark that would ignite the powder. By the late 1700's, the flintlock replaced the other mechanisms, since it was safer to use and easier to make.

Appendix B: War hammer

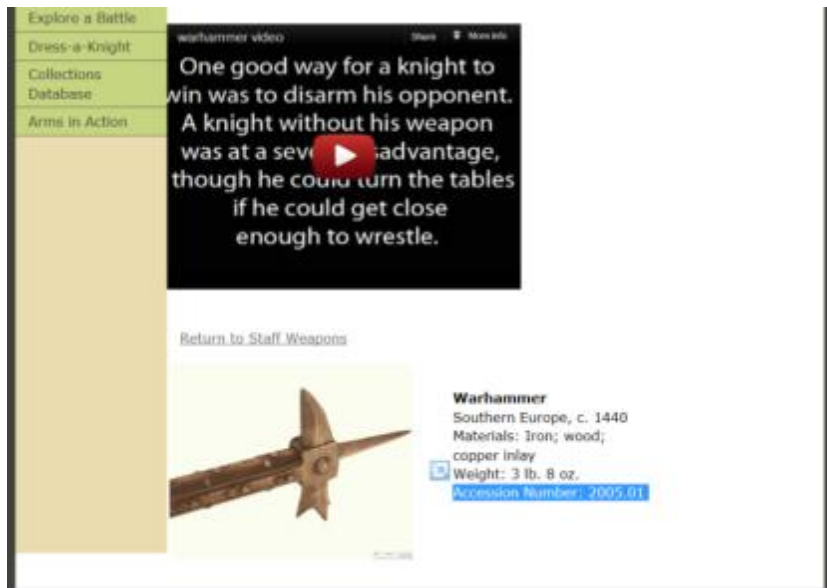

Figure 95: Screenshot of the Warhammer content

The team felt that the best way to work with the war hammer was very close to an instructional video of the basics of the war hammer. It was also hoped that this could spark a few kids interest in the medieval weapons lessons that the museum has.

We used these scripts for the slides:

Slide 1

The warhammer's main use was to break through an opponent's armor. The head had 3 tools designed to pierce or damage plate armor, and there was a spear tip on the butt of the staff

Slide 2

One of the main ways to use the warhammer was to deliver powerful blows that could either break through the opponent's armor or dent it.

Slide 3

A knight also needed to know how to use warhammer to block incoming blows.

Slide 4

One good way for a knight to win was to disarm his opponent. A knight without his weapon was at a severe disadvantage, though he could turn the tables if he could get close enough to wrestle.

Appendix C: Sword of justice

With the sword of justice the team wanted to do something a little different to add a little variety to the content. So what the team did was create a mouseover to explain

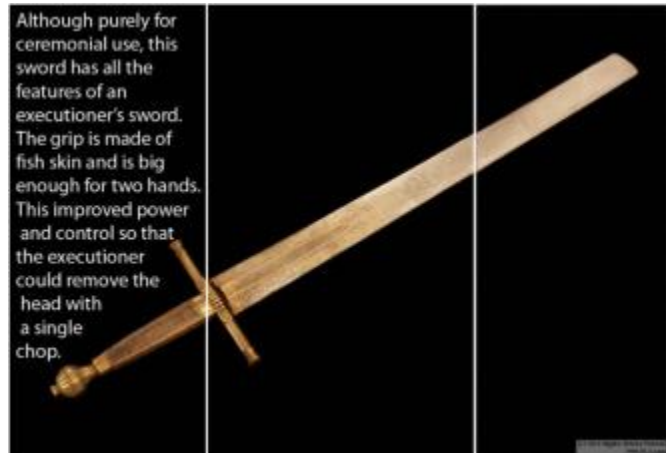

Figure 96: Sword of Justice mouse over image

each part of the sword.

We used the following texts for each respective mouse over

1.

Although purely for ceremonial use, this sword has all the features of an executioner's sword.

The grip is made of fish skin and is big enough for two hands. This improved power and control so that the executioner could remove the head with a single chop.

2.

The writing on the sword is a German poem that reads "When the poor sinner is deprived of life, then he will be placed under my hand. When I raise the sword may God give the poor sinner eternal life."

It also depicts the lady of justice, a reminder that the executioner carries out the will of the law.

3.

Instead of having a pointed tip like a fighting sword, this sword has a square tip. The extra weight at the tip delivers a more powerful blow, allowing the executioner to sever the neck in a single blow.

Appendix D: Halberd of the Trained Band

With the halberd of the trained band the team decided to create a quick slide show that could show the movements of someone who carried the halberd and the different stances they would have to take.

Coming to Attention

The image contains three numbered diagrams illustrating halberd stances:

- Slide 1: Handle yo' Pike.** Shows a soldier in profile, leaning forward with the butt of the pike on the ground. Below the diagram: *Standing at the but end of yo' Pike, fall backw'rd with yo' left foot, and with yo' right hand turned, take your Pike by the But end, and bring yo' right hand up to your hip.*
- Slide 2: Recouer your Pike & Orden.** Shows a soldier standing upright, holding the pike with both hands. Below the diagram: *Bring yo' left foot before yo' right, and with yo' left hand take yo' Pike forward, bearing the buttend downward, and remove yo' right hand above yo' left*
- Slide 3: Orden yo' Pike.** Shows a soldier standing upright, holding the pike vertically with the butt on the ground. Below the diagram: *See the but end of yo' Pike nere your right foot on the but side, holding it right up in yo' right hand, about the height of yo' eye, and your arme a little Bending, and yo' right foot forward*

Show:

[Slide 1](#) [Slide 2](#) [Slide 3](#) [Slide 4](#) [Slide 5](#) [Slide 6](#) [Slide 7](#) [Slide 8](#)

Figure 97: Halberd of the Trained band Slide

Appendix E: Gladiator

This webpage was designed to display different types of gladiators. This has six clickable links and images which reveals more information about the different types of gladiators.



Figure 98 - Gladiator Main Page

This webpage is an example page when a link or image is selected.

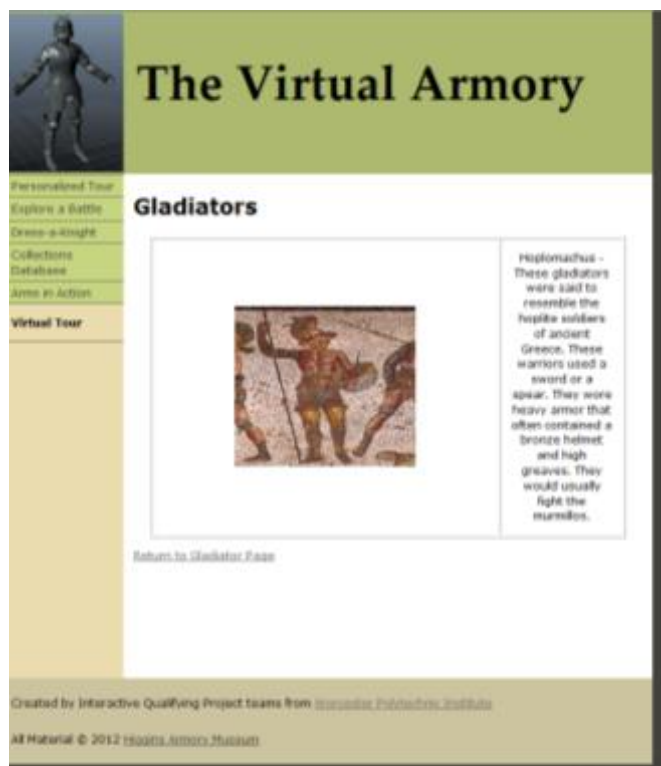

Figure 99 - Hoplomachus Web Page

Texts:

Bestiarius - These gladiators were the ones that fought against beasts. They would fight against animals such as lions or bears. There were two types, those sentenced to death, and those who voluntarily fought against the large animals.

Hoplomachus - These gladiators were said to resemble the hoplite soldiers of ancient Greece. These warriors used a sword or a spear. They wore heavy armor that often contained a bronze helmet and high greaves. They would usually fight the murmillos.

Equites - These were the gladiators who fought on horseback. These type of gladiators could be seen wearing brimmed helmets, and carrying a sword, and using a medium rounded shield for protection

Provocatores - These fighters wore a helmet that contained feathers or horsehair, a breastplate, a loincloth, a greave above the left knee, an arm-guard, and carried a medium sized shield and a short straight-edged sword. They only fought against other Provocatores.

Murmillio - The murmillio wore a helmet that resembled a dorsal fin of a fish. These warriors fought with a gladius, and would usually be pitted against the Thracians.

Thracians - These warriors wore a helmet that resembled a griffin. They often used a curved sword to fight. They most often battled against the Murmillos.

Appendix F- Nandaka

Virtual Tour

Personalized Tour

Explore a Battle

Dress-a-Knight

Collections Database

Arms in Action

Nandaka



Vishnu and Lakshmi.

Nandaka is the legendary sword of Vishnu, one of the three main gods of Hinduism: Brahma the creator, Vishnu the preserver, and Shiva the destroyer. Like many Hindu gods, Vishnu has multiple avatars, including Rama and Krishna. He is paired with a consort goddess usually known as Lakshmi, but among the Nayars of southern India, she is known as Bhagavati. For the Nayars, this sword is regarded as a vessel for Bhagavati, and her devotees traditionally carry such swords in religious processions. The thin blade is pierced along the edge to attach bells: when the blade vibrates, the bells ring, making a powerful shimmering sound in the hands of the goddess's devotees.



Kerala, on the southwest coast of India, is the home of the Nayar caste.

Nandaka (sword of Vishnu)

Southern India, c. 1600's

Steel; silver; iron

Weight: 1 lb. 13 oz.

Accession number: 1495



Figure 100 - The Nandaka Web Page

Appendix G - Siege Breastplate

Here patrons have a chance to interview a knight from the 17th century. 7 questions are provided for visitors to choose from, arranged around an image of the knight. When a visitor clicks on a question the knight responds in bold text above the image. Visitors can then continue to ask the knight the other questions in any order they choose.



Figure 102: Initial page of the content



Figure 101: Page after clicking a question

The answers for all the questions are provided below:

-When did you live?

I'm a soldier from the late 1500s. I lived through one of the greatest military revolutions in history, the adaptation of gunpowder.

-What kind of battles do you fight in?

I use this armor to fight in sieges . To capture fortifications, you have to dig trenches to bring you closer and closer to the walls. This armor protects me when I am in the trenches.

-What do the castles look like?

Well, in the old days, castles were built with high thin walls so attacking armies couldn't climb over them, but nowadays cannon can take those out easily. Today military engineers are building walls that are low and thick, so they don't fall so quickly. You can also put a moat around a castle to stop attackers from getting close to the walls, but it costs a fortune, most places can't afford it.

-How heavy is your armor?

This breastplate weighs about 25 pounds, and the back plate is about 16 pounds, so I'm wearing an extra 40 pounds of metal when I have it on.

-Can it stop bullets?

It certainly can. Look at the breastplate just above the heart. See that dent? That's the proof mark. Armor makers prove the quality of his armor by firing a bullet at the metal.

This armor has saved my life many times, there are 8 other bullet dents in the metal, see if you can find them.

-Do you wear it all the time?

No, this armor is far too heavy, I only put it on when I need to.

-How much armor do you wear?

I only wear a breastplate, a backplate, and a helmet. Nobody wears a full suit of armor these days, it's too heavy. Some people joke that as many men are killed under the weight of their armor as are saved by it.

Appendix H - Bronze Sword

This content incorporates visual and audio content. An image of a typical Urnfield burial is provided with a short description of Urnfield society. The visitor then clicks on different regions of the image to hear what is happening in each segment of the image.



Figure 103: Initial image of the web content

The texts for each voiceover are provided below:

- 1) The Urnfield culture is defined by using cremation on a funeral pyre like this one. The ashes were placed in a ceramic urn then buried
- 2) Wealthy members of Urnfield society were often buried with their prized possessions. Swords, like these bronze swords, along with other valuables were placed in large wagons and buried along with their owners.
- 3) Crowds would have gathered for a burial like this one. This scene depicts a burial for a wealthy elite, such as a lord or prince

Virtual Tour	<h2>Bronze Age Swords</h2> <p>The earlier of these two swords was probably buried with a high-ranking warrior of the Urnfield society, who lived in Northern and Central Europe during the late Bronze Age. The later one comes from the Halstatt society from the same region. This image depicts a typical Urnfield funeral. Click on the image to hear more about what is happening in each area.</p> 
Personalized Tour	
Explore a Battle	
Dress-a-Knight	
Collectors Database	
Arms in Action	

Image adapted from "Vandkilde, Helle (2007). Culture and Change in Central European Prehistory: 6th to 1st Millennium BC. Aarhus, Denmark: Aarhus UP"

Figure 104: when a segment of image is moused over it is highlighted. When clicked a short voiceover of what is happening is played

Appendix I : Jamadhar

The jamadhar was best incorporated through use of a slideshow that showcases many types of jamadhar. The slideshow incorporates texts, images, and videos with voiceovers. The slides only advance when the visitor clicks the next slides, not automatically.

Virtual Tour
Personalized Tour
Explore a Battle
Dress-a-Knight
Collections Database
Arms in Action

Jamadhar-Indian Punch Daggers

The slideshow below showcases many different variations on the traditional Indian weapon.

5. Variations on the Jamadhar: Two in One

Jamadhar were not only used as status symbols among India's elite, they were also treated as collectables by many foreigners as well. For these reasons many unique forms of this dagger were made to be sold as novelty items. This jamadhar, which conceals a smaller jamadhar inside it, is one. The outer blade is dull and would likely be useless as an attack weapon.

Show: 5. Variations on the Jamadhar: Two in One

Slide 1 Slide 2 Slide 3 Slide 4 Slide 5 Slide 6

[Return to Asian Weapons](#) [Return to Swords and Daggers](#) [Return to Islamic](#)

Figure 105: Example of a slide with a video

The text for each voiceover is provided below:

Slide 1 Video: This piece is a classic example of the Indian Jamadhar. The characteristic H-shaped hilt protects the wearers hand, and forearm, in a fight .

Slide 4 Video: Indian weapons makers experimented in many ways to improve the Jamadhar. For a time, a metal shell guard, like this one here, was added over the hilt to protect the users knuckles. However the guard made it harder to fight with, and the concept was abandoned

Slide 5 Video: Jamadhar were not only meant for fighting, they were also symbols of wealth and status. Jamadhar like this one were made as novelty items, and were used for personal

decoration, mostly for noblemen to impress their friends. As you can see, the outer blade of this “2 in 1” jamadhar is dull and impractical to cut with

Slide 6 Video: Another novelty variation, is seen here. When the wearers hand is relaxed the jamadhar appears to have a single blade. However when the wearer squeezes the hilt, a hidden mechanism reveals another blade inside. Though this would not give any combat advantage it shows the skill of the maker.

The texts for the slides are provided here:

Slide 1 “The Jamadhar”: The Jamadhar is a style of weapon found exclusively in India. During the 1500s and 1600s it was one of the most popular and common weapons to carry. The name “jamadhar” comes from a combination of two Sanskrit words: “jam” meaning the god of death, and “dhar” meaning sharp edge. The Jamadhar is defined by its unique H-shaped handle that was meant to be gripped in a fist. When in a fight this special hilt would protect the wearer’s hand and forearms.

Slide 2 ” Jamadhar of the North”: Northern India in the 1600s and 1700s was dominated by the Mughal Empire. The members of the Mughal Court would often carry extravagant weapons, such as jamadhar, to prove their wealth and status. This jamadhar is decorated in gold, a common style in the Mughal Empire. The blade is also shorter and wider than many daggers, another clue that it was made in the north.

Slide 3 “Jamadhar of the South”: Southern India during the 1600s saw some of the first trading between the British and the Indian subcontinent. This influence can be seen in the weapons of this time, as European and Indian parts were often combined to form one weapon. This jamadhar is actually not a purely Indian piece, but a recycled European sword blade attached to an Indian

handle. The silver decorations and slimmer blade are also classic indications of a southern Indian dagger.

Slide 4 “Variations on the Jamadhar: Shell Guard”: Early in the development of jamadhar, people experimented with shell guards like this one. It was hoped that this would offer better protection than the H-shaped hilt alone. However these shelled guards were a short lived-development, and were soon replaced with the classic handles once more.

Slide 5 “ Variations on the Jamadhar: Two in One”: Jamadhar were not only used as status symbols among India’s elite, they were also treated as collectables by many foreigners as well. For these reasons many unique forms of this dagger were made to be sold as novelty items. This jamadhar, which conceals a smaller jamadhar inside it, is one. The outer blade is dull and would likely be useless as an attack weapon.

Slide 6 “Variations on the Jamadhar: Scissors”: Another inventive modification to the classic weapon, this “scissors” jamadhar features a blade that opens up to reveal another blade when the handle is squeezed. As with the “Two in One” jamadhar this piece was mostly for show; no advantage is gained in a fight by having one blade inside the other, it was only meant to look exciting and interesting.

Appendix J: Folding Spetum

Because the Spetum is such a unique item that few people know much about, we created a short video that described the spetum's history and use, and showed it folding and unfolding.



Figure 106: Screenshot of Spetum Content

Appendix K: Mini Game

Runzi Gao made the flash game Knight and His Armors for the Virtual armory website. This game can be played right in the browser when visit the website, and it's also playable on Android mobile devices. However it can be played on iPhones due to the fact that flash is not supported by iOS.

This game was designed to be a puzzle game to teach the visitors about the collections in Higgins Armory Museum and the knowledge of arms and armors. Runzi came up initially with 3 ideas on designing the game.

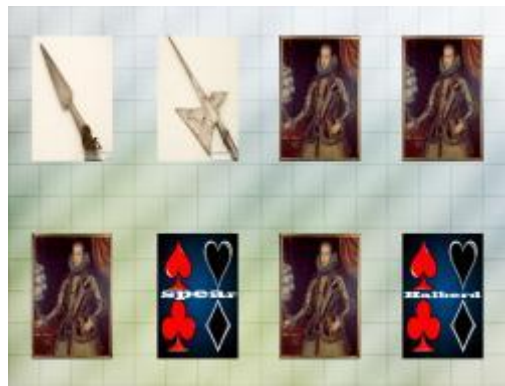

Figure 107: Flip game Mockup

The first idea was a flip game that let the player flip cards to match the piece of armors with its name.



Figure 108: Quiz Mockup

The second idea was simply a series of multiple choice quizzes that help learning the facts about Higgins's collections.



Figure 109: Barrel Mockup

The third idea which is the closest of the final design was a barrel game that let the players catch the armors of the correct type.

Then he adopted the idea of barrel game to the story of a knight and his servant. The unsatisfying knight is always demanding some piece of his amour and the player has to catch the one that the knight asks for.

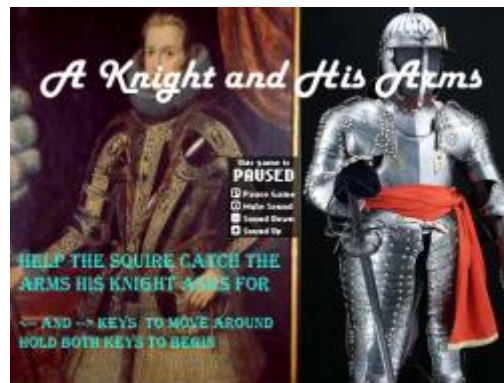

Figure 110: Front page screenshot

The gameplay is that the player controls the servant moving left and right and catching the correct piece of armor dropping from top of the screen. The score reflects the player's performance and he will either win or lose the game.



Figure 111: Game Screenshot

Appendix L - The Virtual Tour manual

This manual is for updating and revising the Virtual Tour, to find information on updating the Virtual Armory site in general please refer to the IQP report “The Virtual Armory Survey and Portal”. The virtual tour is designed to incorporate many different types of web content in an easy to navigate format. This section describes how to add new pages and sections to the existing content.

The Format

The virtual tour has 3 layers, the homepage, the artifact type, and the artifact page. The homepage is a 3x3 table with each cell containing an image and a word or phrase for each artifact type. The reason for using a table, was to organize the categories easily into a confined space. These categories should cover all the artifacts in the armory and it is unlikely that the homepage will need to be changed.

The artifact type pages are modeled after the homepage, they also have tables with 3 columns. More rows can be added to incorporate new content. The easiest way to add more rows to the table is to open the html file in Adobe Dreamweaver. From there, right click on the table, and select the Table menu, and click on Insert Row. To add a new piece of content, select an empty cell, and insert a new picture and word or phrase describing the artifact. The image should be 200 x 200 pixels. Now link both the image and the text to the new artifact page.

To add a new artifact page, start by opening the v_armory_template.html file. Immediately hit Save As and save the file with the desired webpage name in the desired location. It will prompt you to update the links, select Yes. For information on updating this page, refer back to the “The Virtual Armory Survey and Portal” IQP report. After this has been completed, you will be able to insert the content that you generate on this page.

Troubleshooting

When issues occur with your webpages here are some simple checks that can be made

Issue	Possible solution
Images or webpages not displaying	Run the WPI automatic permissions tools on the Virtual armory workspace (http://www.wpi.edu/academics/CCC/Help/Unix/Webdev/webchmod.html)
Links lead to forbidden or missing pages	Check that the code links to the correct page
Certain content will not display on some computers	Make sure all necessary plugins are installed (currently the Virtual Armory uses both flash and quicktime plugins)

The WPI Helpdesk will be able to assist in other issues that may arise during web development.

Appendix M - Spirit of the Katana

Kai He made a video combining paintings, animations and 3D model to show the history of the ultimate sword - the Katana (figure.1). The video was aimed to have an emotional impact on the audience as well as offering a brief history of the Samurai.



Figure 112: Screenshot of the Katana video

Overall I'm pretty satisfied with the quality of the video and hopefully the audience can really appreciate the beauty of the katana through this video.

After the video was completed, It was put on the Virtual Armory website and people will be able visit the page from all around the world (figure.2). A QR code was also attached to the page so that visitors of the Higgins Armory could easily access the page with their smart phones. In addition to the video, Kai also uploaded the pdf version of the 3D models of the Katana he made so that visitors could download them and take a 360 degree look at the Katana at any time, simply with Adobe Reader.

On the next page is a screenshot of the Katana web page.

Katana

Click to watch the legendary story of the Katana



Download 3D pdf of the Katana: [Katana Blade Close-up](#)



Katana (sword), late 1700s-early 1800s

Accession Number: 1860

Region: Japan

Artifact Type: Katana (sword)

Date: late 1700s-early 1800s

Materials: Steel; iron; copper; ray skin; wood; silk; gilding

Weight: 3 lb. 11 oz.

[Return to Asian Weapons](#)

[Return to Swords and Daggers](#)

Figure 113: Screenshot of the Katana web page

Script:

Wielded by the legendary Samurai, the knights of ancient Japan...

The ultimate sword...The Katana...

The secret of the steel rolls like ocean waves along the blade

The hamon, where fire and water meet to forge a sword that cuts in an instant, and endures across the years.

The katana was the soul of the samurai, its steel mirrored his loyalty, honor and faith...
For centuries, the Samurai never put down their blades...

Until at last, guns and cannons came across the seas to challenge the katana to battle...
Fought to the last, the legendary Samurai finally faced their end...

Yet the Katana, beautiful and deadly, still haunts our dreams with the spirit of the samurai of old...

Appendix N: QR Code Template

The diagram below explains the format of the QR sheet in detail.

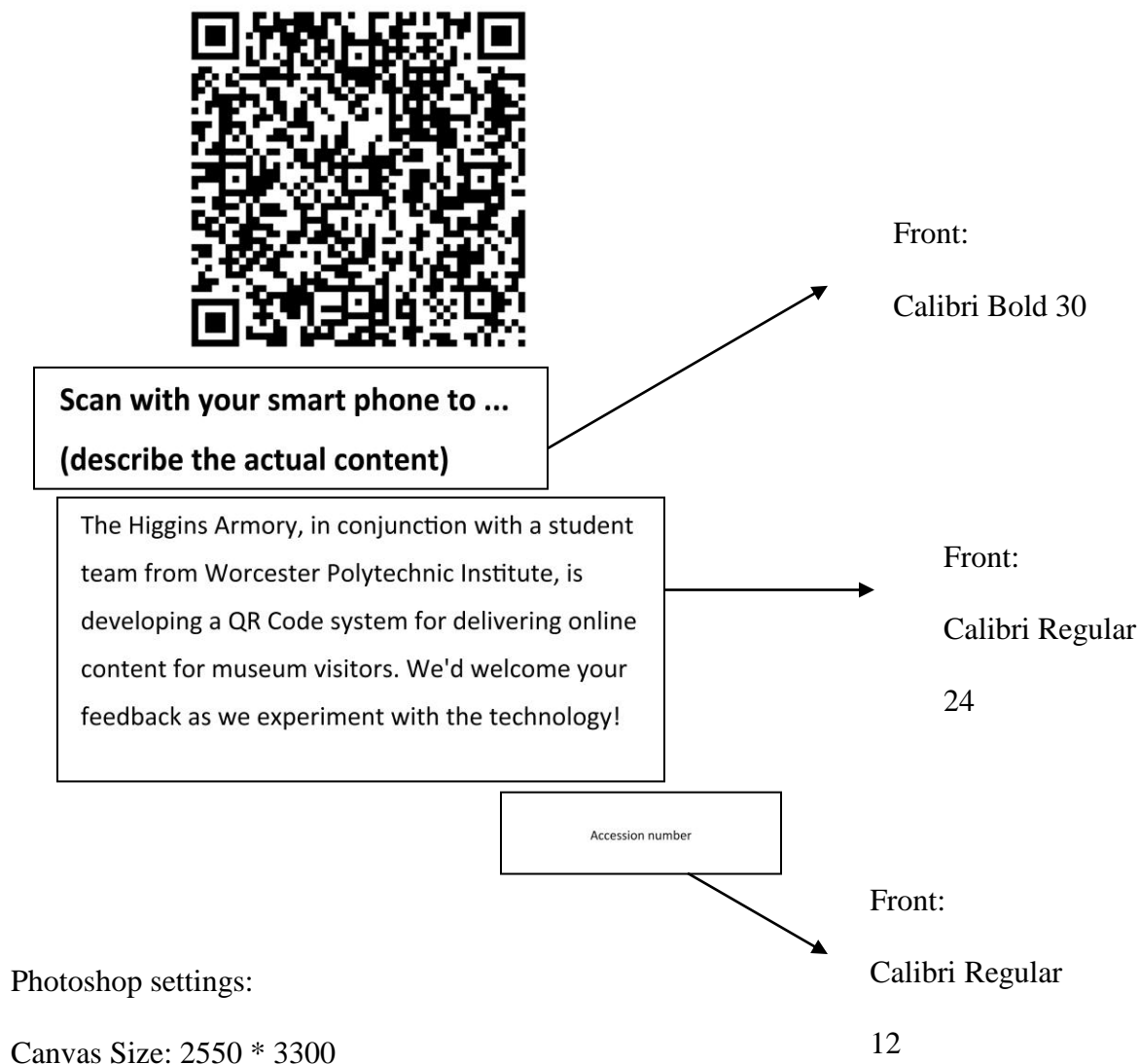

Appendix O: 3D Scan to 3D pdf Workflow

Software you will need:

ScanStudio HD; Zbrush, Autodesk Maya, or other 3D programs; Photoshop CS5 (or above); Adobe Acrobat X Pro (or above).

Detailed Steps:

- Scan the artifact from various angles
- Combine different pieces of the generated 3D segments
- Export model from ScanStudio HD (the software that comes with the NextEngine package)
- Polish the model and perform additional tweaks in other 3D programs like Zbrush, Autodesk Maya, etc. (You will very likely have to do this. Unfortunately the NextEngine 3D Scanner doesn't usually give you a completely finished model right after the scan.)
- Once you have the model finished, export the model as an .obj file with the .mtl file (which connects your model to the texture) and texture file.
- Import the model into Photoshop CS5 (or above). You might want to adjust the lighting a little bit (Screenshot.1).

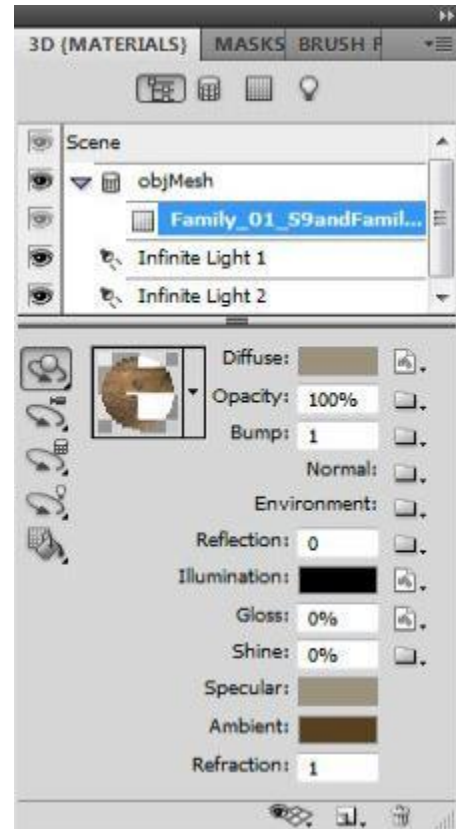

Figure 114: Adjusting lighting in Photoshop.

- Tip: if your model shows up with no texture. Make sure your .obj, .mtl and the texture file are all in the same folder.
- Once you are happy with the model in Photoshop, go to the 3D menu and export the model as a .u3d file.
- Create a new pdf in Adobe Acrobat X Pro. Import the .u3d file. Check "Show Advanced Option" to change background color, default lighting etc. (Screenshot.2)

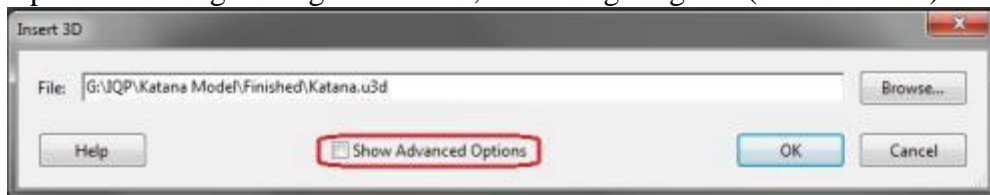

Figure 115: Insert 3D

- Save the pdf file and you're done!

Appendix P – Generating QR Codes

A standard QR code can contain up to 7089 characters. So short text can be directly encoded in the QR code. Longer text, images, videos and other contents can be linked through use of a URL encoded into the code.

Free online QR code generators:

<http://qrcode.kaywa.com/>

<http://www.qrstuff.com/>

<http://goqr.me/>

<http://zxing.appspot.com/generator/>

Copy the full URL to your web contents to one of those free QR code generators , they should be able to generate the QR code image of you chosen size. Just need to print it out and put it in the place you want visitors to scan with their smartphones.

Appendix Q - Survey Questions

Below are the survey questions that our team came up with. We never implemented them, but it may be useful for future teams to add these to the Virtual Tour.

1. How did you access this content?

- website
- QR code

2. What did you think of the content overall?

- 1
- 2
- 3
- 4
- 5

3. How valuable was the educational value of the content?

- 1
- 2
- 3
- 4
- 5

4. Did you like the content?

- 1
- 2
- 3
- 4
- 5

5. Were there any issues with viewing the content?

- yes
- no

If yes what problems did you have?

6. Do you have any comments about the QR code or the content?

Done

Powered by **SurveyMonkey**
Create your own surveys now!

Figure 116 - The Survey Questions

Bibliography

- Abbot, G. (2005) *Execution: the guillotine, the pendulum, the thousand cuts, the Spanish Donkey, and 66 other Ways of Putting Someone to death*. New York, NY: Martin's Press.
- Ahearn, M. (1989) *The rhetoric of war : training day, the militia, and the military sermon*. New York: Greenwood Press
- Anglo, Sydney. (2000). *Martial Arts of Renaissance Europe*. Yale University Press New Haven and London.
- Anonymous. (2008). *Shah Jahan's dagger fetches \$3.3M*. Prince George Citizen, pp. 37.
- Archer, C. (2003). *World History of Warfare*. University of Nebraska Press.
- Ashdown, Charles Henry. (1967) *European arms & armour*.
- Aylward, J. D. (1946). *The small sword in England; its history, its forms, its makers, and its masters*. London, New York: Hutchinson's Scientific & Technical Publications.
- Basham, A. L. (1975). *A Cultural History of India*. Oxford: Oxford University Press.
- Blair, C. (1962). *European and American Arms, c. 1100-1850*. London: B.T. Batsford.
- Blair, Claude (1959) *European Armour, circa 1066 to circa 1700*. London: Batsford.
- Blair, Claude and Tarassuk, Leonid (1982) *The Complete encyclopedia of arms & weapons*. New York: Simon and Schuster.
- Breiding, Dirk H (2002). *Famous Makers and European Centers of Arms and Armor Production*. New York: The Metropolitan Museum of Art
- Bronkhorst, J. (2007). *Greater Magadha: Studies in the culture of early India*. Leiden: BRILL
- Brown, H. R. (1967) *American Polearms. 1526-1865*. N. Flayderman.
- Burton, Richard F. (1884). *The book of the sword*. London: Chatto and Windus.
- Coe, Michael et al. (1989). *Swords and Hilt Weapons*. New York: Weidenfeld and Nicolson.

- Cynthia P. Duval and Walter J. Karcheski, Jr. (1983) *Medieval and Renaissance of Splendor*
- David Nicolle. (2002). *A companion to medieval arms and armour*. Woodbridge, UK ;
Rochester, NY : Boydell Press
- DeVries, K. (1998). Gunpowder weaponry and the rise of the early modern state. *WAR IN HISTORY*, 5(2), 127-145
- DeVries, K. (2002). *Guns and men in medieval Europe, 1200-1500: Studies in military history and technology*. Aldershot [England]: Ashgate/Variorum.
- DeVries, K. Smith, R. D. (2007). *Medieval weapons: an illustrated history of their impact*. Santa Barbara: ABC-CLIO
- Duffy,A.R. (1974) *European swords and daggers in the tower of London*. London: HMSO
- Edge, D. Paddock, J. M. (1988). *Arms and Armor of the Medieval Knight*. New York: Crescent Books.
- Egerton, Wilbraham and Egerton, Earl. (1968). *Indian and Oriental armour*. Harrisburg: Arms and Armor Press.
- Elgood, R. (2004). *Hindu arms and ritual: arms and armour from India 1400-1865*. Eburon
- Farmington, K. (1996) *Dark justice: a history of punishment and torture*. Smithmark
- Futrell, Alison. (2006). *The Roman Games: a sourcebook*. Malden: Blackwell Pub.
- Glete, Jan. (2000). *Warfare at sea, 1500-1650 maritime conflicts and the transformation of Europe*. London; New York: Routledge.
- Hall, Bert S. (1997). *Weapons and warfare in renaissance Europe: gunpowder, technology, and tactics*. Baltimore and London: Johns Hopkins University Press.
- Kienbusch, C. (1940). A Footnote on New England's Colonial Halberds. *Journal of the American Military Institute*. 4(2), 121-124.

- Köhne, Eckart, Cornelia Ewigleben, & Ralph Jackson. (2000). *Gladiators and Caesars: the Power of Spectacle in Ancient Rome*. Berkeley: University of California.
- Kulke, Hermann, & Rothermund, Dietmar. (1997). *A history of India*. GB: Routledge Ltd.
- Laking, G. F. Sir, Cosson, Charles Alexander, Baron de, & Cripps-Day, F. H., ed. (1920). *A record of European Armour and arms through seven centuries*. London: G. Bell and Sons.
- Latham, J. D. (1970). *Saracen archer: an English version and exposition of a Mameluke work on archery (ca. A.D. 1368)*. London: Holland P.
- Martin, Paul. (1968). *Arms and Armour, from the 9th to the 17th Century*. Rutland, VT: C.E. Tuttle.
- May, William Edward. (1962). *Naval swords and firearms, by W.E. May and A.N. Kennard. Drawings by John Munday*. London: H.M. Stationery Off.
- McIver, K. (2006). Luxury arts of the Renaissance. *Renaissance Quarterly*, 59(2), 556-558.
- Metcalf, Barbara & Metcalf, Thomas. (2002). *A Concise History of India*. Cambridge: Cambridge University Press.
- Mohamed, Bashir. (2008). *The arts of the Muslim knight: the Furusiyya Art Foundation collection*. New York: Rizzolli International Publications
- Monte, Pedro (2011 [1509]). *Compendium on Physical Exercises and the Military Arts*. Transl. Forgeng, Jeffrey L.
- Morby, John E. (2002). *Dynasties of the World: a Chronological and Genealogical Handbook*. Oxford: Oxford University
- Neufeldt, R. W., Coward, H., & Dargyay, E. (1988). *Readings in eastern religions*. North York: Wilfrid Laurier University Press.

- Neuman, G. (1967) *The history of weapons of the American Revolution*. Harper and Row.
- Nicolle, D., & McBride, A. (1993). *Mughul India, 1504-1761*. London: Osprey.
- Norman, A. & Vesey B. (1971). *The Medieval Soldier*. New York: Crowell.
- North, Anthony. (1982). *Introduction to European swords*. Owings Mills, MD: Stemmer House.
- Oakeshott, R. Ewart. (1980). *European weapons and armour: from the Renaissance to the industrial revolution*
- P. G. W. Annis. (1970). *Naval swords: British and American naval edged weapons, 1660-1815*. Harrisburg, PA: Stackpole Books.
- Pant, G. N. (1970). *Studies in Indian weapons and warfare*. New Delhi: Army Educational Stores.
- Pant, G. N. (1978). *Indian arms and armour*. New Delhi: Army Educational Stores.
- Parker, G. (1997). *The military revolution: Military innovation and the rise of the west, 1500-1800*. New York: Cambridge University Press.
- Peterson, H. (2000) *Arms and Armor in Colonial America*. Canada: General publishing company.
- Rawson, Philip S. (1969). *The Indian Sword*. New York: Arco Pub.
- Resnik, J and Curtis, D. (2010). *Representing Justice*, Yale University Press.
- Roberts, K. (2002). *Matchlock Musketeer*. Boleley: Oxford .
- Robinson, H. Russell. (1969). *Japanese Arms & Armor*. New York: Crown Publishers Inc.
- Robinson, Nathan. *Anatomy of Armor: Gothic Armor of the 15th Century*
- Ropp, T. (1959). *War in the modern world*. Durham, N.C: Duke University Press.
- Smiles, Samuel. (1894). *Josiah Wedgwood, F.R.S. his personal history*. Harper & brothers.

- Snook, G. A., & Museum Restoration Service. (1998). *The halberd and other European pole arms, 1300-1650*. Bloomfield, ON: Museum Restoration Service.
- Stone, G.C. (1961) *A Glossary of the Construction Decoration and Use of Arms and Armour*, Jack Brussel, New York.
- Susan Rose. (2002). *Medieval naval warfare, 1000-1500*. Psychology Press.
- Tallett, F., & Ebrary Academic Complete. (1997). *War and society in early modern europe 1495-1715*. New York: Routledge.
- The Wedgwood Museum. Retrieved From <http://www.wedgwoodmuseum.org.uk>
- Turnbull, Stephen R. (1979). *Samurai armies, 1550-1615*. London : Osprey Publishing.
- Turnbull, Stephen R. (1982). *The book of the samurai, the warrior class of Japan*. New York : Arco.
- Turnbull, Stephen R. (2010). *Hatamoto, Samurai Horse and Foot Guards, 1540-1724*. London : Osprey Publishing.
- Vernard, F. (1983). The Wheel Lock, and The Milling Process. *Technology and Culture*. 399.
- Wagner, Eduard, Drobná, Zoroslava & Durdík, Jan. (1958). *Medieval costume, armour, and weapons, 1350-1450*. London: P. Hamlyn
- Waldman, J. (2005). *Hafted weapons in medieval and renaissance Europe: The evolution of European staff weapons between 1200 and 1650*. Leiden: BRILL.
- Walsh, J. E. (2006). *A brief history of India*. New York: Facts on File.
- Warner, Oliver. (1968). *Great sea battles*. Feltham : Spring Books.
- Wilkinson, Frederick. (1967). *Swords and daggers*. London, Melbourne: Ward Lock.
- Williams, A. (1999). The steel of the Negroli. *Metropolitan Museum journal*, 34.

Williams, A. (2003). *The knight and the blast furnace: A history of the metallurgy of armour in the middle ages & the early modern period*. Leiden: Brill.

Wisdom, Stephen. (2001). *Gladiators: 100 BC-AD 200*. Angus McBride Books.

Zelner, K. (2009). *A Rabble in Arms*. NYU press: New york.