

# Algae Biodiesel

---

An Interactive Qualifying Project Report  
submitted to the Faculty of  
WORCESTER POLYTECHNIC INSTITUTE  
in partial fulfillment of the requirements for the  
Degree of Bachelor of Science

**Submitted by:**  
**Lauren D'Elia**  
**Andrew Keyser**  
**Craig Young**  
**Date: October 14, 2010**

Professor Robert W. Thompson, Major Advisor

## Table of Contents

Abstract.....	3
Introduction .....	5
Energy Consumption from Transportation.....	6
Ethanol as a Renewable Resource .....	7
Electric Cars.....	8
Biodiesel.....	9
Algae Biodiesel.....	10
Government Incentive for Algae Biodiesel Research and Involvement .....	12
Companies Making Algae Biodiesel Today .....	13
Microalgae Cultivation.....	16
Open Raceways.....	16
Bioreactors.....	19
Fermentation .....	20
Immobilization .....	21
Algal Biomass Harvest.....	22
Filtration.....	22
Centrifugation .....	22
Flocculation/Flotation.....	22
Oil Extraction from Microalgae.....	24
Transesterification .....	24
Pyrolysis .....	26
Long-chain Hydrocarbons .....	28
Fischer-Tropsch.....	28
The Bets Are On .....	29
Why Pyrolysis?.....	30
Algae by 2020.....	32
Economic Impacts.....	35
The Time is Now.....	39
Appendix .....	42
References .....	44

## Table of Figures

Figure 1: Energy used each day per person by country .....	6
Figure 2: Primary energy consumption by source and sector .....	7
Figure 3: Diagram of natural process in algae that influenced the Direct to Ethanol™ technology .....	14
Figure 4: Schematic of design for the Texas pilot biorefinery .....	14
Figure 5: Synthetic Genomics at work to genetically modify super strains of algae .....	15
Figure 6: Picture of a few of the 11 ponds located in the California’s Imperial Valley .....	16
Figure 7: Raceway design, Patent issued in 2010 .....	17
Figure 8: Blueprint and real-life view of Renewed World Energies bioreactor design.....	20
Figure 9: Diagram of transesterification reaction with methanol as alcohol .....	25
Figure 10: A simple schematic of the pyrolysis process .....	27
Figure 11: Waste water treatment during algae growth .....	33
Figure 12: Dried algal biomass for animal feed. ....	34
Figure 13: Schematic of cost efficient algae biodiesel production from start to finish .....	35

## Table of Tables

Table 1: Comparison of some sources of biodiesel .....	11
Table 2: Comparison of three different additive’s effect on algae flocculation .....	23
Table 3: Comparison of dissolved air flotation and suspended air flotation as means to collect algal biomass .....	24
Table 4: Comparison of algal pyrolysis products to conventionally transportation fuels .....	31
Table 5: A comparison of the differences in product composition produced from the pyrolysis of 6 different species of algae .....	31
Table 6: Sapphire’s Projected Production of fuel in the future .....	38
Table 7: Required land to replace varying percents of transportation sector .....	38

## **Abstract**

With increasing fuel prices, environmental concerns, and a growing transportation sector the United States will need to cut down on petroleum based fuels while investing and researching in various renewable energy sources. This study examined different strains, harvesting, and extraction methods of algae for production of algae biodiesel with a goal of determining the potential impact algae biodiesel can make on the economy, the environment and reducing emissions in the United States.

## Introduction

Currently, the United States is not the only country facing a potential energy crisis but a majority of the World is as well. While there is still some debate as to whether the climate change is directly related to the burning of fossil fuels or not, this does not change the fact that there are cleaner and more efficient energy sources to be harvested. The dependence on non-renewable energy sources is a need for concern that if left untouched will lead to a crisis. With the industrial revolution playing such a large role in the shaping of technology in America it comes as no surprise that the connection to fossil fuels is found in almost every aspect of our society, especially in the transportation sector. To put the United States' scale of energy consumption into perspective, while the US only contains around five percent of the world's population, it is responsible for nearly a quarter of all energy consumption in the world <sup>[1]</sup>. The prices of current energy increasing with demand in all four sectors of our economy; transportation, residential, industrial and commercial; is leading to a potential big problem for the US in the future. The transportation sector demands the most resources from petroleum, but if there were other competitive sources of fuel, prices could be controlled and that, in turn, could help the U.S. economy greatly <sup>[1]</sup>. With the scale of the United States transportation sector and the vast amounts of diesel and gasoline that we use every day, we wanted to see if the renewable energy source algae biodiesel would be able minimize our dependence on crude oil. By looking at the step by step process of the production, extraction, and conversion of algal biomass to transportation fuel, it is possible to take an in depth look into the speculated advantages and potential national impacts that the replacement of fossil fuels with algae biodiesel could have on the transportation, economy, and overall workings of the United States.

### daily energy use

BTUs per Person

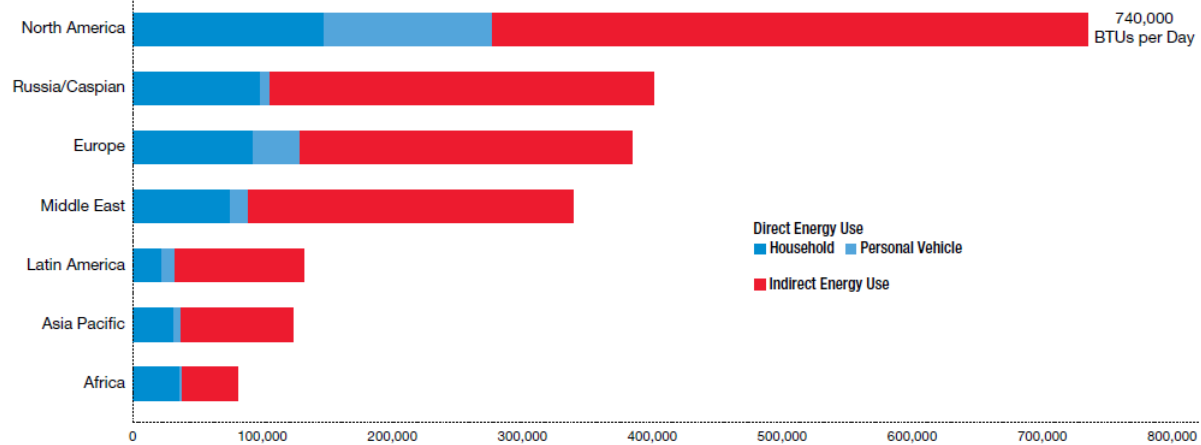

Figure 1: Energy used each day per person by country. <sup>[3]</sup>

### Energy Consumption from Transportation

In 2008, 71% of the 37.1 quadrillion BTUs of the energy used from petroleum went towards transportation <sup>[1]</sup>. While the United States uses 26.1 Quadrillion BTUs of energy from petroleum, only 3% of the total transportation energy use comes from a renewable source <sup>[1]</sup>. This comes out to about 14.71 million barrels of crude oil needed daily to meet the needs of the transportation sector only. Of that, it can be estimated that around 9.76 million barrels of crude oil need to be imported daily in order to fulfill the daily demand of transportation energy <sup>[1]</sup>. The import of crude oil accounts for around 66% of the net crude used in the US. Since 71% of petroleum goes towards transportation, if that demand was replaced with a home grown alternative, the dependence on foreign oil could nearly be eliminated. This would mean less money would be spent importing fuel, keeping more of the US's money in the US. While transportation was the second largest sector for US fuel consumption, only 11% of the total renewable energy produced went towards transportation <sup>[1]</sup>. Obviously there is room to improve these

numbers in order to move away from our dependence on foreign oil and the non-renewable, high environmentally impacting fossil fuels.

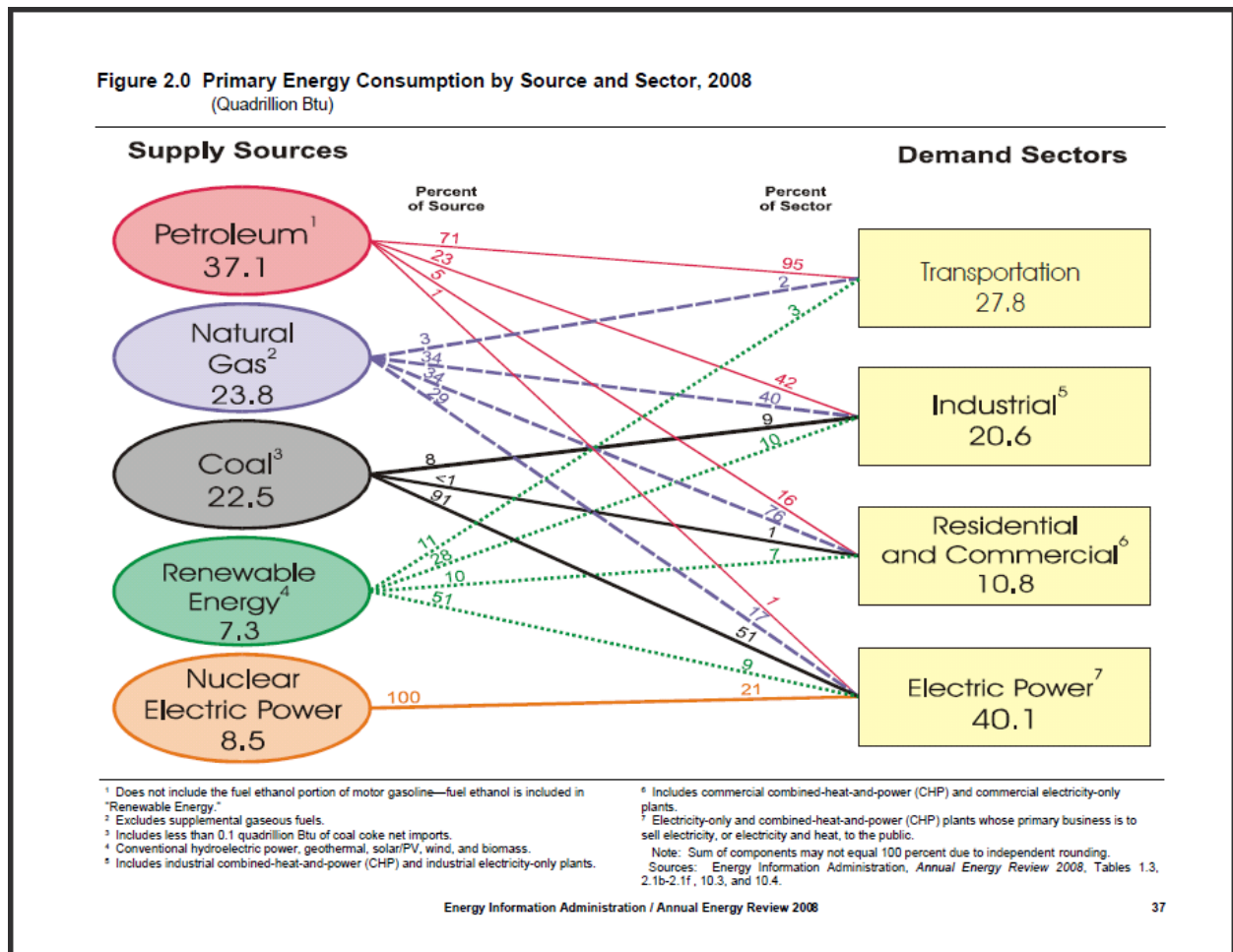

Figure 2: Primary energy consumption by source and sector<sup>[1]</sup>

### Ethanol as a Renewable Resource

Of the 833 trillion BTU's of renewable transportation fuel consumed last year, 793 trillion BTU's came from ethanol consumption<sup>[1]</sup>. Ethanol is produced primarily from corn, and is mixed into gasoline. In the US gasoline-powered vehicle engines must be able to run on 10% ethanol, though modified engines are able to run on 85% or 100% ethanol<sup>[1]</sup>. A major hurdle for many types of energy sources is the idea of energy balance and whether or not the system has a positive energy balance. It has been proposed by many that the conversion of corn to ethanol or biofuel is energy neutral meaning that there

is no gain from the energy put in to obtain the product, but also no loss<sup>[2][4]</sup>. This leaves the current ethanol technology taking in just as much fuel and energy as it puts back out into the market. Other challenges with ethanol fuels include issues such as the ‘food vs. fuel’ debate and environmental concerns leave use and development processes like this on the small scale. Sources of energy that are of interest that can be energy positive would be solar, biochemically or synthetic solar panels, geothermal, wind power, hydroelectric along with a few others shows that we do not need to be solely dependent on fossil fuels to power our lives.

### *Electric Cars*

With transportation emissions accounting for roughly 33 percent of total global emissions, it is important to consider technologies that could help to significantly reduce this impact<sup>[5]</sup>. The electric car is an invention that's sole purpose is to reduce the amount that humans contribute to pollution by eliminating the CO<sub>2</sub> emissions produced by automobile use. While the idea of this type of technology may seem world changing, the concept of electricity and its generation cannot be ignored. In 2007, 34 percent of total emissions and 45 percent of CO<sub>2</sub> emissions came from generating electricity<sup>[5]</sup>. Making electricity involves the burning of fossil fuels, which emit CO<sub>2</sub> as a byproduct<sup>[6]</sup>. This means that even electric cars will have some indirect CO<sub>2</sub> output. The use of electric cars will not only be limited in its effects on emission reduction, but will also change many aspects of the common human lifestyle. Of course cars running on electricity will require rechargeable batteries, which, currently, are not capable of sustaining power for long car trips<sup>[6]</sup>. This means that until the proper battery technology is created, gas stations will have to be replaced with electric plug-in stations—this could have detrimental effects on many businesses, not to mention the economy. Since many people seem to love the idea of domesticating electric vehicles, states like California, Ohio and Michigan are actively opening battery manufacturing plants<sup>[7]</sup>. These new battery plants do help create jobs and stimulate some economies, but better batteries will not eliminate the fact that they must, eventually, be recharged. Indefinitely,



many people may choose to charge their cars at the same time, which can create an even greater need for electricity at peak hours <sup>[6]</sup>. Without any regulations as to when individuals can charge their cars, there may come a time when there is not enough capacity on the electric grid to satisfy all of the domestic needs <sup>[6]</sup>. An event like this could lead to the creation of more power plants, which means increased burning of the already limited fossil fuel supply. Electric cars, in their current technological state are not ready to be put on a widespread market. Current batteries are not consistent with the majority of transportation needs <sup>[7]</sup> and the effects on society would be more harmful than good if these potentially eco-friendly vehicles are introduced prematurely. For now, along with battery exploration, research should continue to be geared toward finding a clean burning source of fuel.

### *Biodiesel*

One major competitor in the new alternative sources of energy to fossil fuels is biodiesel. In 2008, it was estimated that 27,925 trillion BTU's were consumed in the form of transportation fuels, and only 833 trillion BTU's came from a renewable source <sup>[1]</sup>. There is opportunity to make a major impact and fill an important niche in the petroleum industry by utilizing renewable resources to produce transportation fuels. The majority of the renewable fuel used is produced from biomass. Biomass usually consists of plant material or agricultural wastes, and, for transportation purposes, would likely be converted into ethanol or a form of biodiesel. Biodiesel is a source fuel produced from high energy hydrocarbons found in living materials and can be extracted from plant and animal cells through several different processes. The source of the hydrocarbons used for biodiesel is usually either cellulose of plants, or lipids of animals or plants. The technology to convert lipids into biodiesel has been available for over 50 years and is currently in commercial use around the world, and therefore is more likely to be utilized in a larger scale production than cellulosic based fuels <sup>[8]</sup>. Lipids, especially Triacylglycerides (TAGs), are a very abundant source of the high energy hydrocarbons of biodiesel as each TAG is made up

of three long chain fatty acids (FAs) that can be easily removed from the glycerol unit through a process called transesterification<sup>[9]</sup>. Some FAs are better suited for biodiesel than others as they contain low levels of saturation, making them less likely to solidify in cold temperatures. As of right now, there is not enough proper feedstock for conversion to biodiesel to make it an economically profitable source of fuel or make a major effect on the oil market<sup>[11]</sup>. In 2008, 700 Million gallons of Biodiesel were consumed. Used vegetable oil is not abundant in nearly high enough volumes to be able to use it on a nationwide scale<sup>[11]</sup>. High oil producing plants have been considered, but they still do not produce enough lipids to be a viable source as seen in Table 1, and must compete with resources used for food production. By comparison, algae appear to be a more feasible biomass for biodiesel production.

## **Algae Biodiesel**

Algae seem to be a very effective feedstock for biodiesel production. Some algal species have been found to have very high oil contents, ranging up to and sometimes beyond 50% dry weight<sup>[8]</sup>. Algae can be grown on land and in water unsuitable for plant growth. Some species are able to grow in high salinity, effluent, and can be grown in ponds independent of the soil. Because of the high lipid content and growth rates of algae, it is estimated that they can produce between 58,700 and 136,900L/ha annually, and would need to occupy between 2.5-1.1% of the total land area of the US to replace 50% of the total US transportation fuel consumption, as shown in Table 1. These numbers suggest that algae is capable of producing between 10-30 times the amount of oil per year than other high oil producing plants (Table 1). It was estimated that in 2004 that about 140.8 billion gallons of biodiesel would be needed to replace all transportation fuels in the US. Using experimental growth rates and oil production of some algae, almost 15,000 square miles of land would be needed to grow enough algae to produce 140.8 Billion gallons of biodiesel which is comparable to Massachusetts and Delaware combined<sup>[10]</sup>.

Table 1: Comparison of some sources of biodiesel <sup>[8]</sup>

Crop	Oil yield (L/ha)	Land area needed (M ha) <sup>a</sup>	Percent of existing US cropping area <sup>a</sup>
Corn	172	1540	846
Soybean	446	594	326
Canola	1190	223	122
Jatropha	1892	140	77
Coconut	2689	99	54
Oil palm	5950	45	24
Microalgae <sup>b</sup>	136,900	2	1.1
Microalgae <sup>c</sup>	58,700	4.5	2.5

<sup>a</sup>For meeting 50% of all transport fuel needs of the United States.

<sup>b</sup> 70% oil (by wt) in biomass.

<sup>c</sup> 30% oil (by wt) in biomass.

Another advantage of algae as a source of energy is that it has the ability to be coupled to other positive processes. Algae can be used to clean effluent from factories or municipal waste. It has been known for over 40 years that algae can be used as to treat wastewater <sup>[12]</sup>. Algae effectively remove excess nutrients and metals from effluent <sup>[12]</sup>. Also, since algae is grown suspended in liquid culture, excess CO<sub>2</sub> from factories or other processes can be fed to the algae, increasing growth rates. While much of this CO<sub>2</sub> is again released when the oil product from the algae is burned, it does have hopes of reduced carbon emissions since CO<sub>2</sub> gas can be mitigated during algae growth <sup>[8]</sup>.

The species of algae exploited dictates the type of fuel produced, and the process yielding that fuel <sup>[13]</sup>. Different algal species have different characteristics that could make it ideal for producing transportation fuels. The one major difference between algae is the type of high energy product they produce. Many algal strains produce lipids likely as energy storage. For unknown reasons these lipids are often only produced in large quantities when the alga is starved for nitrogen <sup>[8]</sup>. For these species the oils produced must be converted to useable source of energy. Most often lipids are converted to biodiesel via transesterification.

In other algal species, such as *Botryococcus braunii*, long chain hydrocarbons are produced for various known and unknown reasons <sup>[13]</sup>. These long chain hydrocarbons can be refined to a variety of

fuel products through the refining process known as hydrocracking already used in the petroleum industry<sup>[14]</sup>. These hydrocarbons have previously been extracted from the alga using organic solvents such as hexane<sup>[15]</sup>.

Other variations in algal growth stem from species having different growth rates and nutrient tolerances. Some algae can grow in very high salinity, brackish or waste water; low temperatures, and varying luminosity. It is balancing these traits that dictate much of the processes and parameters in which the algae must be grown. For example, an alga that can effectively be grown in waste water can be coupled in a process that produces effluent to use fewer products and lower costs, while helping the environment<sup>[16]</sup>. By comparison, salinity resistant species can be grown in a variety of areas that could not be used for production of other crops, because the soil and water are saline<sup>[17]</sup>. Cold weather species can be used in farms in the colder climates, but these species may not have as high of growth rates or oil production as a species that could be grown somewhere warmer. Also, biodiesel often cannot easily be used in cold climates as it can solidify. Species producing long chain hydrocarbons would likely be the best choice in a cold climate scenario as they can be converted to fuel nearly identical to typical petroleum.

### ***Government Incentive for Algae Biodiesel Research and Involvement***

There are current grants and Congress bills that will provide incentive for private companies to spend time and resources on algae biodiesel research<sup>[8]</sup>. The Department of Energy began a grant program in July 2009 with the allocation to provide \$85 million to a handful of private companies and universities to focus on cutting edge methods of algae biodiesel production and extraction. There are a few bills currently in the 111<sup>th</sup> congress as well. The “Algae-based Renewal Fuel Promotion Act of 2009” was introduced in June 2009 that would make companies involved in algal fuel production eligible for the same tax benefits that cellulosic biofuel industries currently receive. Another bill introduced into the House of Representatives is much like the previous, but includes adding algae to the Clean Air Act’s in

order to give algae more value for researchers to become involved. Finally, the “American Clean Energy and Security Act of 2009” was introduced in order to create GHG emissions restrictions which would increasingly raise the cost of fossil fuel over time and create an urgency to make algae biodiesel a reality.

### *Companies Making Algae Biodiesel Today*

Many companies are currently involved in algae biodiesel research, but according to an article by Public Mechanics, some major players are claiming that they will have large scale algae biodiesel production by the end of the year 2010<sup>[18]</sup>. Among these are Algenol Biofuels, Solix Biofuels, Sapphire Energy, Solazyme, and Seabiotic. Algenol Biofuels uses technology that produces fuel from algae without killing or harvesting the creatures which allows for a shorter turnaround time to make fuel. They claim that they have the potential to produce 1 billion gallons of ethanol per year by 2012 with a gallon costing about 85 cents<sup>[18]</sup>. According to a corporate presentation on the company’s website, their method, know as Direct to Ethanol™ Technology, uses photosynthesis to initiate the natural enzymes found in blue-green algae that convert sugars directly to ethanol (Figure 3)<sup>[19]</sup>. The method involves a marine strain of algae and therefore can use seawater, recycles CO<sub>2</sub> from industrial plants, and can be built on non-arable land that cannot be used for anything else needed for the US economy. Plus, for every 2 gallons of seawater consumed through the process, 1 gallon of fuel is produced along with 1 gallon of freshwater which could in effect help the global clean water crisis though distillation of the ethanol from water would be an added expense for the new company. In 2010, Algenol Biodiesel is teaming up with Dow Chemical to begin construction of a pilot biorefinery (24 acres) in Texas using grant money from the Department of Energy. It will be designed according to the schematic in Figure 4, and they project that the refinery can consume 1.8 tons/day of CO<sub>2</sub> from the industrial plant and produce 100,000 gallons/year of ethanol. However, their future plan is to produce a commercial scale (170,000 acres) plant in the Sonora Desert, Mexico which would produce 1 billion gallons of ethanol per

year, and consume nearly all CO<sub>2</sub> emissions the Puerto Libertad power plant located there (6 million tons).

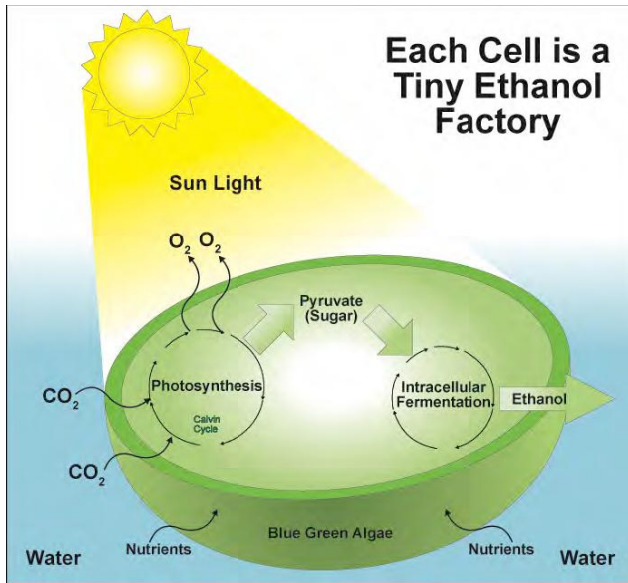

Figure 3: Diagram of natural process in algae that influenced the Direct to Ethanol™ technology <sup>[19]</sup>

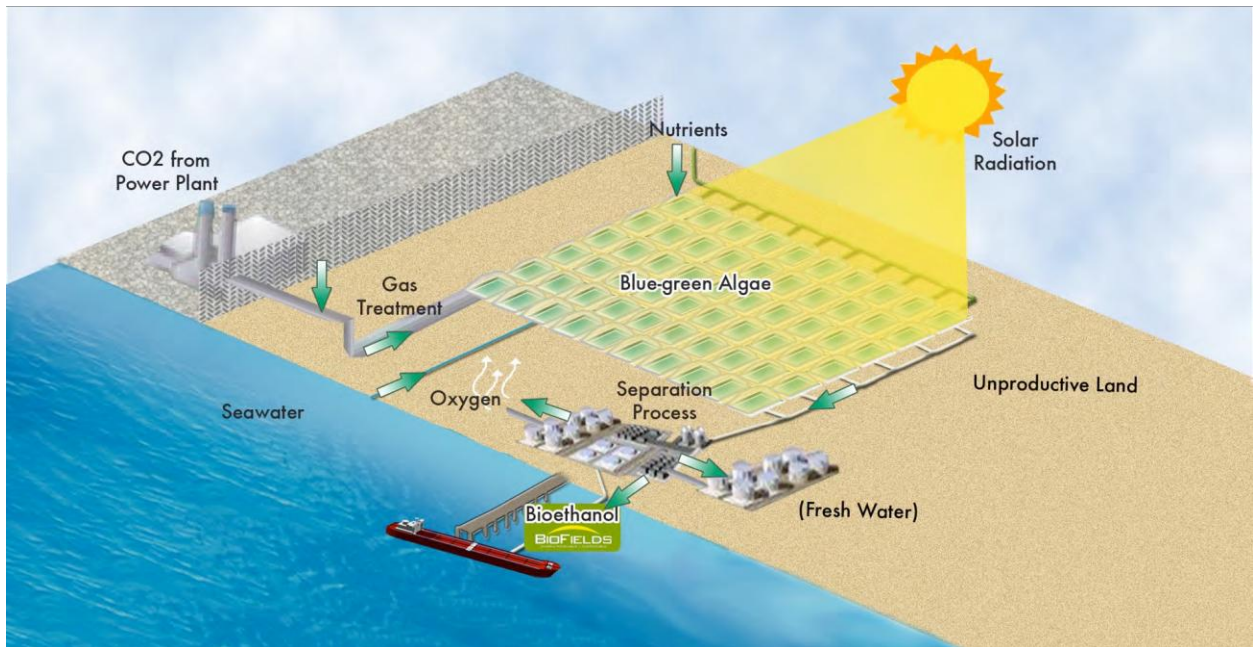

Figure 4: Schematic of design for the Texas pilot biorefinery <sup>[19]</sup>

Solix Biofuels Inc. uses bioreactors to grow algae where their AGS™ technology allows five-times the surface level exposure from sunlight compared to open ponds, and at the moment, extract the oil

from the organisms using chemical solvent such as benzene. However, Solix is collaborating with Los Alamos National Laboratory to use its acoustic focusing technology to concentrate algal cells into a dense mixture, which could then be pressed to extract the oil, making the extraction process more efficient <sup>[18]</sup>. According to the company's website, the company has a demonstration facility in Coyote Gulch, Colorado, which incorporates the AGS™ technology with integrated propagation and extraction facilities <sup>[20]</sup>. The plant recycles waste water generated during coal-bed methane production and CO<sub>2</sub> from an amine plant to grow the algae, therefore, demanding no resources that can be used elsewhere.

Sapphire Energy, Inc. focuses its research on "green crude" which, through their technology, is oil from algae that is highly branched, the same composition of crude oil. According to their company's website, the "green crude" can be processed in existing crude oil refineries, meaning there will be "no additional investment in the \$10 trillion existing energy infrastructure <sup>[21]</sup>." At the refineries, the green crude can be made into the three major distillates- gasoline, diesel, and jet fuel. They plan to produce 1 million gallons annually by 2011, but no projected cost per gallon has been released <sup>[10]</sup>.

Solazyme focuses on genetically engineering algal strains with higher oil content, and use algae to convert biomass directly into oil using fermentation barrels. They claim to be on schedule to produce 20,000 gallons for the Navy by 2010, and bring costs down from 80\$ to 60\$ a barrel in the next few years <sup>[10]</sup>. They also claim that the algae oil and residual biomass can be used in many other applications such as green chemicals, cosmetics, and food for animals.

Seambiotic is the last on the list, and this company was formed in 2003 for the purpose of producing Omega 3 fatty acids from microalgae <sup>[22]</sup>. However, currently, Seambiotic has a dual purpose for its technology since it now focuses on algae biodiesel as well. The plant uses the oldest technology, open ponds, to grow the algae, and has formed a partnership with NASA to optimize growth rates of microalgae, and expected to have a commercial plant by late 2009 but as of 2010 there is no news regarding its completion or status <sup>[18]</sup>.

Another major supporter of the algae biodiesel movement is Exxon Mobil even though not that long ago its CEO, Rex Tillerson, mocked alternative energy by referring to ethanol as “moonshine”<sup>[23]</sup>. In July 2009, the corporation announced that it would invest \$600 million dollars into algal research and development, but they claim it will not be easy, and they do not plan to have a large scale commercial production facility for algae biodiesel for another 5 to 10 years <sup>[23]</sup>. Exxon is currently involved with Synthetic Genomics to genetically engineer strains with higher oil yields to further make algae oil extraction more efficient and algae biodiesel cheaper (Figure 5).

Obviously, algae biodiesel is a possibility that could reduce net carbon dioxide emissions as well as end the fears of fossil fuel reserve dissipation. However, the costs of production must be less than the cost the algae oil itself, and there must be an energy balance or an energy gain in order to make the process efficient.



Figure 5: Synthetic Genomics at work to genetically modify super strains of algae.

## Microalgae Cultivation

### *Open Raceways*

There are not many options for large scale algae farms since algae needs sunlight, nutrients, and carbon dioxide in order to thrive and reproduce. The most primitive algae farmers used large open raceways of liquid medium to grow their algae (Figure 6). Most raceways are designed with a current



that constantly circulates the algae so that all organisms receive enough sunlight. Carbon dioxide is also pumped into the water to keep the algae alive, and nutrients are frequently replenished to support maximum growth. The advantages to raceways are that they are inexpensive, can support a large population of algae, and can use effluent water and CO<sub>2</sub> emissions from local industrial plants. However, open raceways are vulnerable to contamination and it is difficult to find an efficient way to harvest the algae from these large raceways due to the vast area and the constant water flow.



Figure 6: Picture of a few of the 11 ponds located in the California's Imperial Valley, each containing more than 200,000 gallons of water. <sup>[24]</sup>

To address some of the problems that exist with the current design of open raceway algae cultivating systems, a new patent for a raceway was introduced in February 2010 which incorporates some promising innovations (Figure 7) <sup>[25]</sup>. The design uses slanted chutes or "raceways" in order to

promote flow of the liquid medium without wasting energy to create a current in the existing flat raceway design (10a, b, c). These can be open or closed by material that allows light to penetrate into the liquid medium and prevent contamination. The most advantageous part of the design, however, is the inclusion of multiple cyclone precipitators (1a, b) in which the algal biomass can be precipitated and concentrated from the liquid medium as it flows through the system. This allows for an easy way to collect the biomass combining the cultivating and harvesting process into one step. The valves (15a, b) located at the bottom of each precipitator can be automatically or manually operated, and are emptied into a common outlet passageway (12) to collect all algal mass and transfer it to another location for processing. The design is flexible and efficient, and solves some of the drawbacks encountered with algal mass production. It holds promise to sufficiently improve the efficacy and cost of cultivating algae in order to make it more realistic for biodiesel production on a global scale.

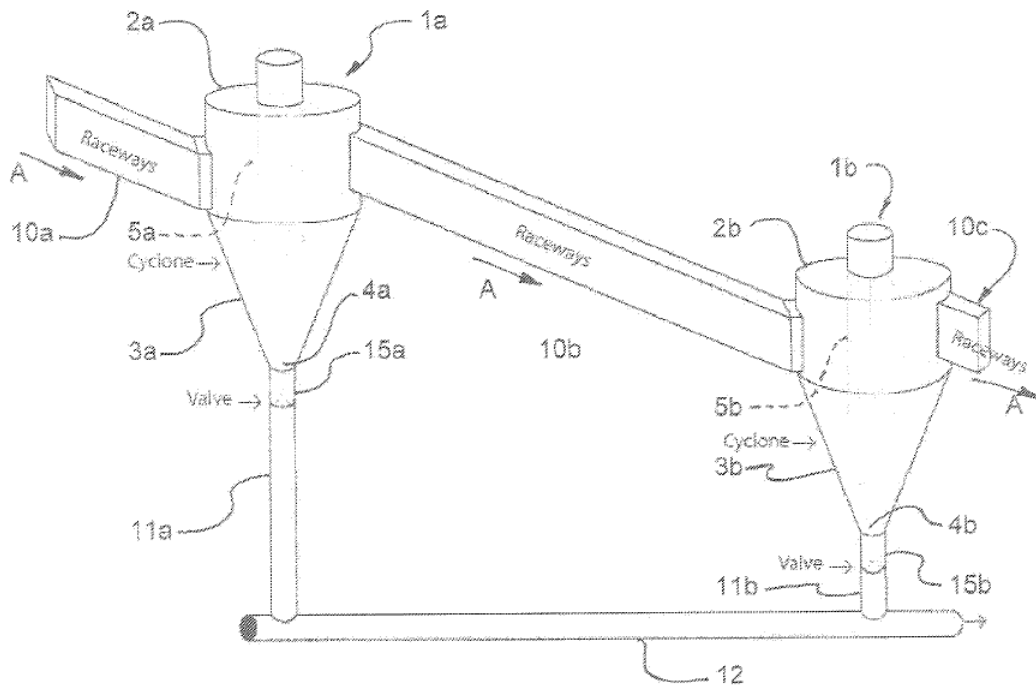

Figure 7: Raceway design, Patent issued in 2010. <sup>[25]</sup>

## *Bioreactors*

Another method for algae cultivation is in photo-bioreactors. These are designed with multiple tall, transparent, closed containers that allow the algae farmers to control all aspects of the environment such as temperature, light, carbon dioxide and nutrient levels, as well as avoid contamination. The bioreactors can be built inside to use artificial light, or outside to use natural sunlight. These bioreactors can also be paired with local industrial plants to use effluent sources. This method of cultivation allows for a high yield of algal mass that can be harvested each day, but they are very expensive to build, and require a complex design to maintain the optimal environment for algae growth. Also, oxygen, excess carbon dioxide, and an abundance of algae can build up in this closed system if it is not filtered out efficiently, as there are no openings for them to be released, which could kill the algae population. Changes in pH and lack of nutrients can also be detrimental to the algae growth cycle thus bioreactors have special monitoring systems for all these environmental factors, and when the levels are unsafe, old media is removed and new media is pumped in.

A promising bioreactor design for 2010 comes from Renewed World Energies located in Georgetown, South Carolina <sup>[27]</sup>. Every aspect of the design was carefully crafted to decrease cost and increase yield of algal mass (Figure 8). This bioreactor contains vertical “ponds” that are spaced out to allow maximal sunlight absorption by each unit (Figure 8). The technology facilitates algae farm expansion by adding units through quick-connect piping headers. The system is fully automated which makes the cultivating process hands-free, and the design is also wireless which avoids wiring from each unit to the main controls which is very cost efficient. Back-flushing systems are used to remove algae that adhere to the sides of the ponds to promote highest yield during the algal mass harvest as well as avoiding the cost of expensive mechanical wipers to serve the same purpose. Furthermore, the liquid medium is mixed by impeller pumps to avoid shear that could damage cell structure. The design allows for a commercial scale production of algae biomass for a third of the cost of some smaller scale models.

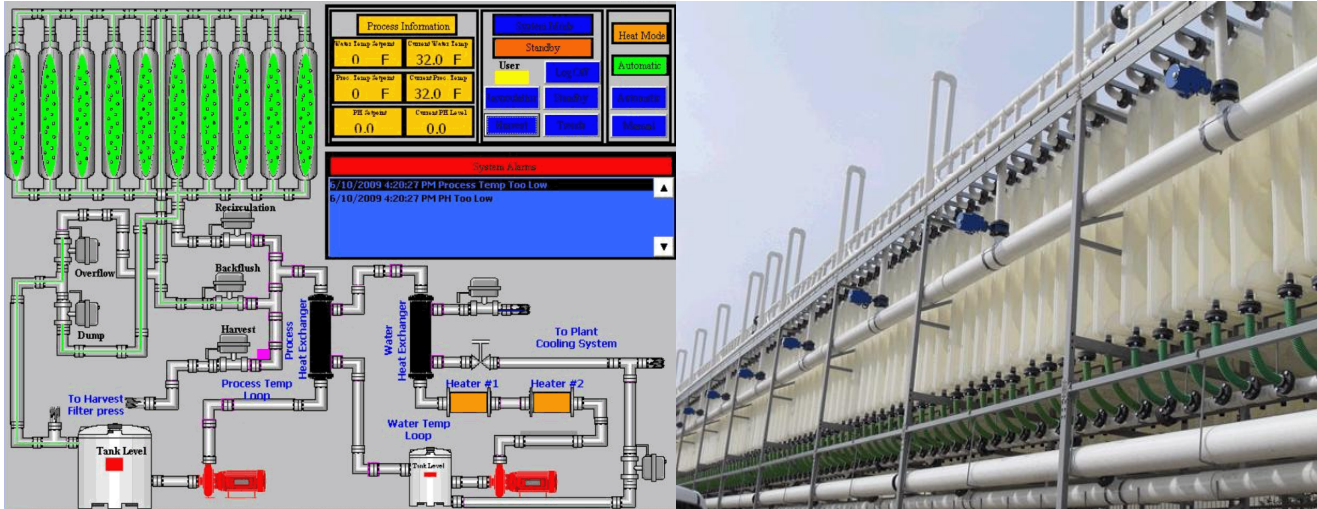

Figure 8: Blueprint and real-life view of Renewed World Energies bioreactor design.<sup>[27]</sup>

## Fermentation

Fermentation grows algae in sunlight-independent vats by feeding them sugar. The method offers the most control over the growth of the algae population, and would allow the cultivation of algae anywhere on Earth. The appropriate environment such as temperature and pressure can be easily maintained. In this method, the algal biomass produces ethanol. However, fermentation is more expensive than the other cultivation methods. What's more, it is not an efficient use of algae since ethanol is commercially used as a gasoline additive for public transportation uses although some racecars can run on pure ethanol, and it will not solve the world's dependence on gasoline reserves which are steadily dissipating. Hence, for the most part companies have phased out the idea of fermentation, but some companies such as Solazyme, which is a company discussed in the introduction, still invests energy and resources into this method.

Other algal species have also shown increased growth rates when grown in a medium containing exogenous carbon sources. Species such as *Botryococcus braunii* and *Chlorella* sp. have shown to decrease doubling times and increase hydrocarbon production in carbon rich media<sup>[28]</sup>. This may be advantageous when considering using effluent as the base media for culturing. Depending on the source

of effluent or stage of treatment there may be some available carbon the algae could utilize for growth. Having a carbon source in the media does however drastically increase the chances of contamination in the culture. Many bacteria are limited in their ability to grow in typical algal medium such as BBM or Chu-13 because there is no carbon source in the media. BBM and Chu-13 are aqueous based media containing necessary trace nutrients, most notably nitrogen and phosphorus. These and other typical algal media are made up of the necessary nutrients algae need to grow and photosynthesize, dissolved in water and sterilized<sup>[30]</sup>. Healthy cultures of algae in a designed medium can outcompete several bacteria in a carbon depleted media, but would likely not fare as well in a contaminated sucrose or other sugar medium. Any culture grown in media containing sugars would need to be in a sterile bioreactor of some design in an attempt to avoid contamination.

### **Immobilization**

An immobilized cell is defined as a living cell that, by natural or artificial means, is prevented from moving independently from its original location to all parts of an aqueous phase of a system<sup>[31]</sup>. Laboratory experiments have shown that immobilization of several microalgae and cyanobacteria can greatly increase their growth and product yields<sup>[28][12]</sup>. Immobilization has the prospects to greatly increase the viability of algal biodiesel through simplification and increased efficiency and feedstock. Algal species of interest for hydrocarbon production such as *Botryococcus braunii* and *Chlorella* sp. have been shown to grow faster and produce more hydrocarbons and TAG when immobilized on various matrices and beads<sup>[12]</sup>. This is likely because they are able to make better use of the supplied nutrients through increased availability. Immobilization can reduce damaging shear forces caused from the liquid flow in a bioreactor. Also, immobilized algae could make the process of harvesting the algae and extracting hydrocarbons even simpler, further driving down the costs of production<sup>[28][12]</sup>. While immobilization has a possible role to play in the future of algal exploitation, the scaling up to a large scale process may be met with many challenges in practice<sup>[28]</sup>.

## Algal Biomass Harvest

### *Filtration*

Since algae must be grown in water, there are limited separation methods that are efficient in removing algal cells from the liquid medium. Each method has its drawbacks as well. One technique is filtration in which the liquid medium is filtered by vacuum force through a porous membrane while collecting the algal biomass. Filtration is very efficient in concentrating the low density microalgae, but it is costly and time consuming. The entire volume of liquid medium must be passed through the filter, and for a commercial scale algae farm, that is a massive volume of liquid. The process is also very tedious since the filtration must be carefully monitored and the algal biomass must be scraped off at intervals to avoid clogging the filter <sup>[29]</sup>.

### *Centrifugation*

Centrifuges are expensive pieces of machinery and are, therefore, out of the question for small scale algae entrepreneurs. However, for commercial production, they are feasible since the process could separate the algal biomass from the full volume of liquid medium in a single step hence increasing the efficiency of the harvest. Nevertheless, the amount of energy needed to power such a colossal centrifuge is immense, and as the algae cells are very fragile, the force applied to the algae during centrifugation must be just right to concentrate the mass but not burst the cells which would release the valuable components found inside the algae into the liquid <sup>[29]</sup>.

### *Flocculation/Flotation*

The method of flocculation is a low cost advancement that could be used in combination with filtration to increase its efficiency. Flocculation is the means by which algae cells congregate and form a mass by the addition of a chemical or organic substance. Careful considerations must be made when picking a substance to induce flocculation, however, since some of the substances can contaminate the

final product. In this case, another costly step would have to be taken to purify the algal biomass.

Studies done by Lee et al show that the addition of organic carbon substances, such as acetate, glucose, or glycerine, induce significant flocculation and increase recovery efficiency of algal biomass as seen in Table 2<sup>[30]</sup>. These additives did not affect the lipid content of the algae cells, are relatively low cost, and induce flocculation in a reliable, predictable way.

Flotation uses air to bring the algae population to the surface of the liquid medium. Dissolved air flotation uses a compressor to supersaturate the liquid with air, and then moves the medium into a pressurized chamber where the air precipitates as tiny bubbles adhering to algae cells to bring them to the surface. This process was assumed to be the best until studies by Wiley et al showed that suspended air flotation is just as efficient in bringing the algal population to the surface of the liquid<sup>[32]</sup>. Suspended air flotation uses surfactants to create tiny bubbles making the process less expensive with less mechanical components, and use less energy than dissolved air flotation. If flocculation and flotation is combined, the algae biomass can be skimmed or collected easily off the top of the liquid media, not affecting the cultivating process and the liquid media can then be reused to reduce the cost of nutrient and water demands. Flocculation and flotation are very promising methods that should be further invested in order to make algae biodiesel more efficient, and cost effective.

Table 2: Comparison of three different additive's effect on algae flocculation.<sup>[30]</sup>

Substrate	Substrate concentration (c)	0.1 g L <sup>-1</sup>		0.5 g L <sup>-1</sup>	
		Mixing time (t)	6 h	24 h	6 h
Acetate	Recovery efficiency (%)	52 (51–53)	88 (75–96)	52 (50–53)	90 (81–95)
	Concentration factor	149 (146–151)	240 (215–264)	133 (106–150)	100 (89–106)
Glucose	Recovery efficiency (%)	53 (44–70)	90 (83–96)	48 (35–60)	93 (89–97)
	Concentration factor	167 (146–182)	236 (232–239)	181 (141–242)	109 (89–121)
Glycerine	Recovery efficiency (%)	45 (36–54)	94 (91–96)	50 (38–61)	93 (93–97)
	Concentration factor	179 (143–216)	204 (192–228)	171 (152–210)	131 (100–185)

Table 3: Comparison of dissolved air flotation and suspended air flotation as means to collect algal biomass. <sup>[32]</sup>

Variable	DAF 2:1 ratio			SAF 120:1 ratio			P
	Mean	SE	n	Mean	SE	n	
Percent capture	84.9	0.81	30	83.4	0.69	12	0.166
Raw sample total suspended solids (mg/L)	110	2.8	3	114	3.1	3	0.318

## Oil Extraction from Microalgae

### *Transesterification*

Although the technique of transesterification has been around for over a century, it has only been recently used as an extraction method for obtaining fuel from algae oil. It is also the common reaction for production of biodiesel. Transesterification is the reaction between an ester (TAG) and an alcohol (methanol) to form a different ester (methyl esters) and alcohol (glycerol) in the presence of a catalyst, usually sodium ethanolate for algae oil production when Clixoo runs the reaction which will be discussed later <sup>[46]</sup>. When using algae for the source of oil it contains a percentage of triglycerides depending on the strain which is an ester comprised of free fatty acids and glycerol, and the alcohol used is usually ethanol although methanol can be used just as effectively <sup>[46]</sup>. Methanol has some advantages over ethanol such as less steric resistance; however the United States imports a large percentage of its methanol leading some companies to favor using ethanol <sup>[47]</sup>. A general overview of the reaction can be seen in Figure 9 <sup>[33]</sup>. In the presence of the catalyst, the alcohol is deprotonated which forms a strong nucleophile, which allows it to react with the triglyceride to form three new methyl esters (fuel) and glycerol (byproduct). The glycerol will be on bottom with the biodiesel or fuel on top. The glycerol can be removed and used for a variety of products being left with the biodiesel for fuel <sup>[33]</sup>. One draw back of this method compared to higher temperature reaction methods is that the reactants must be free of water because it will prevent the reaction from even occurring. If water is present then



the triglycerides hydrolyze and will form the salts of the fatty acids and transesterification doesn't take place.

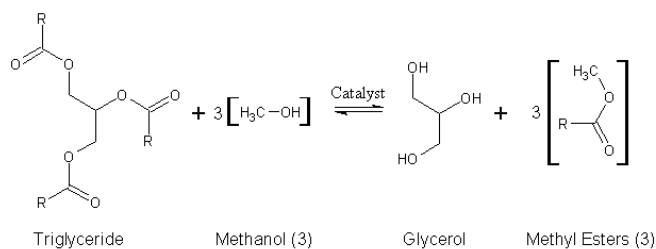

Figure 9: Diagram of transesterification reaction with methanol as alcohol used [33].

There are some companies that do use transesterification of algae oil to produce biodiesel rather than using waste vegetable oil stocks from restaurants which might be considered a more conventional way of producing biodiesel. Clixoo is one company with a subdivision called Oilgae which runs this procedure by using ethanol as the alcohol and sodium ethanolate as their catalyst. They produce the sodium ethanolate by reacting ethanol and sodium. From using the reaction mechanism described above, the ethanol reacts with the algae oil or triglycerides to produce biodiesel, glycerol, and sodium ethanolate (catalyst). After the reaction takes place some form of separation needs to be done with the goal of separating the glycerol from the biodiesel with some examples being simple distillation or other wash and extraction methods. Oilgae takes the transesterification product and adds ether and salt water in a process known as liquid-liquid extraction to further divide the layers into a mixture of ether and biodiesel on bottom which was original on top after the reaction, and the glycerol is now on top. The biodiesel layer is then separated or distilled off and by using gentle heat they are able to boil off the ether and are left with a finished biodiesel product ready to be used as fuel [46].

Now in order to get the oil to run the transesterification reaction some use a process known as the hexane solvent method. By using a mechanical style press called an expeller press the algae can essentially be squeezed and the oil can be harvested with a yield of up to seventy five percent. In

combination with this, the solvent hexane can be used to further extract the oil with a yield of up to ninety five percent. This is all based on the maximum percent of lipids that a certain strain can produce in the first place. However, many opt out of this second step because when chemicals are involved not only does security go up, chemical costs and treatment of waste become factors which all cost money in the long run. These yields mentioned would be excellent ones at that with more typical yields being only slightly lower. There are other methods that some companies have researched into, such as ultrasonic assisted extraction method but with many of these methods there is still a lot of research to be done to see which are not only the most economically feasible but also which achieve the best yields. One of the biggest problems currently with these methods is when scaling up a production. This is mostly seen with the expeller press method which works well on small scale but when applied to large scale it is hard to get that amount of algae dry enough to run through the press. The algae must be dry enough for the friction of the mechanical press to rupture the cell walls to release the oil. Because of these problems some have looked into using a centrifuge which can work well on large scale but this also has some disadvantages as described earlier.

### *Pyrolysis*

Though it has not yet been determined whether the process of algae pyrolysis can be used for economically beneficial oil production, the process has been under study for several years and is in the R&D phases of commercial large scale development with several pilot facilities already in use and even more under construction<sup>[36]</sup>. Pyrolysis is a promising technological tool because it deals with breaking chemical bonds in organic materials to create liquid fuel; since most organic materials have chemical bonds that can be broken producing high energy products there is immense potential for mass amounts of fuel to be made. The process of pyrolysis can be better understood by referring to Figure 10. First a biomass, most generally feedstock, is placed in a chamber and heated in the absence of oxygen. In the absence of oxygen, the heat is used to break the chemical bonds by vaporizing many constituents of the

## Biomass Liquefaction via Pyrolysis

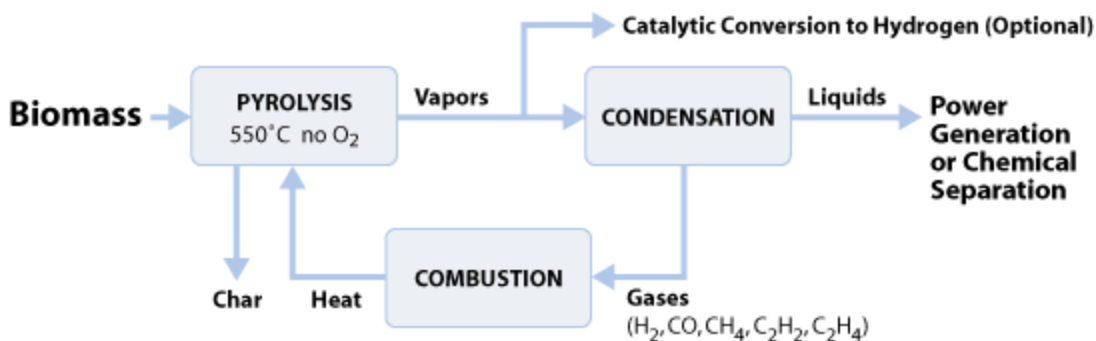

Figure 10: A simple schematic of the pyrolysis process <sup>[1]</sup>

biomass. Once vaporized the products can be cooled to form a liquid—this liquid can be used for fuel <sup>[36]</sup>. By passing the vaporized fuel over a catalyst a highly uniform product can be obtained <sup>[35]</sup>. Catalysts that have been used in pyrolysis are usually shape specific zeolites, because of their ability to promote a particular length or the cyclization of hydrocarbons <sup>[35]</sup>. Once the process is complete there are 3 major products produced: oil, char, and gas. The char is the result of material that cannot be vaporized (mostly salts and ions), the char is known to be a viable fertilizer, so it will not be wasted and the gas is usually a mixture of different combustible gases with varying levels of carbon. This gas can be burned to heat the gasification process, and CO<sub>2</sub> can be fed back to the algae helping it to grow faster, thus mitigating CO<sub>2</sub> and increasing biomass.

Pyrolysis of biomass has been explored and implemented in recent years. With several companies already invested in the production of bio-oils from the pyrolysis of waste plant matter, it is very possible that these factories could also take on algal feedstock for conversion without many adjustments to the system—the only difference is the temperatures and pressures at which each variable produces highest yields <sup>[37][38]</sup>. Algae pyrolysis has many advantages, such as the ability to recover fuel without first extracting lipids or hydrocarbons from the algae, ideally increased yields over transesterification, and more uniform production. Consequently, the collaboration of different pyrolysis possibilities could mean higher bio-diesel fuel yields in the somewhat near future.

### *Long-chain Hydrocarbons*

As mentioned earlier, some species of algae produce hydrocarbons rather than lipids and TAG's. This difference in feedstock can result in a difference in conversion of the product, and the characteristics of the product. The long chain hydrocarbons found in the intracellular space of the algae *Botryococcus braunii* (also known as botryocenes) are very similar in composition to crude oil<sup>[39]</sup>. The extracted hydrocarbons can therefore be converted to fuel with hydrocracking, already being done at oil refineries. This is advantageous in more than one way; first, the technology and infrastructure is readily available in many parts of the world. Algae can be grown and hydrocarbons extracted, then sold to a refiner as the same basic product as crude oil. It can contribute to more than just fuel, but also the other useful byproducts of refining. Crude oil is refined to many everyday consumer products, and so can botryocenes. It has been shown that the hydrocarbons in *Botryococcus braunii* can be converted by catalytic hydrocracking to 67% petroleum gasoline, 15% jet fuel, and 15% diesel fuel<sup>[39]</sup>. The ability to make petro fuel and not just diesel makes a hydrocarbon feedstock more viable in more areas of the world. Biodiesel has the unfortunate downfall of solidifying at low temperatures, making it nearly impossible to rely on in colder climates and during winter. Gasoline however can be used nearly all over the world at all climates as it is a liquid at much lower temperatures.

### *Fischer-Tropsch*

One way to extract and convert an algal feedstock is the Fischer-Tropsch process. Companies such as Clearfuels and the Solena Group are currently in the demonstration phases of their F-T processes to convert organic waste to fuels<sup>[37][38]</sup>. Clearfuels gasifies cellulosic waste into a syngas which is converted into biodiesel at the nearby Rentech Product Demonstration Unit which converts natural gas into biodiesel<sup>[37]</sup>. Overall, this process is very similar to pyrolysis; in fact the differences are sometimes hard to identify. A F-T process uses a stream of super heated hydrogen gas passed through the feedstock to produce a syngas of relatively small combustible gases, and some longer hydrocarbon

products, especially if used with a catalyst<sup>[38]</sup>. The main difference between how Clearfuels plans to obtain fuel and a pyrolysis process is that they do not allow the produced syngas to liquefy forming fuel immediately after conversion<sup>[37]</sup>. Also, since Clearfuels does not need to directly produce diesel they do not need to overly concern themselves with obtaining a highly uniform product. This removes the necessity for a catalyst in the initial gasification of the biomass. Solena's plasma technology may be of interest for algae, since it can be rapidly heated<sup>[38]</sup>. Less energy may be spent reaching the correct temperatures if the reactor is not continuously fed, as may be the case with algae if it is not possible to produce ample amounts of biomass at a continuous rate to economically justify.

## **The Future of Algae Biodiesel**

### *The Bets Are On*

Presently, the year 2010 seems as though it will contain the most algal farming and oil extraction innovations thus far, and the public will finally see the functionality of algae biodiesel. Many companies are already beginning their algae farming and biodiesel plants, each with a different, proprietary method, meaning that by the end of 2010 it will be easier to predict if algae biodiesel has the potential to replace fossil fuels entirely, which methods are best, and the cost and energy input requirements.

Collectively, it seems that bioreactors are the best choice for algae cultivation. These apparatuses are beneficial because they shield the algae mass from any contaminants, allow for complete control over the environment such as temperature, light, carbon dioxide levels, etc. to promote optimal growth, and contain filters to remove build up of waste during algae growth unlike open raceways. Another benefit of bioreactors, adding to the feasibility of algae biodiesel, is that they allow for algae growth inside without natural sunlight giving more flexibility and prospect as to where algae farms can be located. Although bioreactors are expensive, on a large scale they would be very cost efficient since the process promotes rapid algae growth and high algal mass yield. Also, companies

would save money on workers since the process would be totally automated and monitored by computers. A very proficient design would include the bioreactor with precipitators incorporated, as seen in the previously discussed patent, to allow for quick and easy algal mass collection. These precipitators would empty into a heated chamber containing a conveyor belt that dries the mass as it transfers the algae to the oil extraction processor. Pyrolysis appears to have the most potential to create a means to extract oil from algae that is both cost efficient and time effective.

### *Why Pyrolysis?*

Recent laboratory studies of the pyrolysis of an algal feedstock have had positive results; researchers have found that high energy fuels and combustible gases can be produced by the pyrolysis of both algal lipids and full cell algae<sup>[40]</sup>. In comparison to other feedstocks, such as wood, the pyrolysis product from an algal feedstock is superior (Table 4)<sup>[40]</sup>. The higher rate of growth and photosynthesis of algae, coupled with increased yield and heating value of produced biofuel support algae as the ideal feedstock for the fabrication of renewable fuel (Table 4). Current companies such as Clearfuels<sup>tm</sup> are looking to have a profitable pyrolysis facility may want to consider investing in maximizing algae growth in order to increase their production<sup>[37][43]</sup>.

The product is variable depending on the intercellular composition of the particular species of algae grown (Table 5). The overall pyrolysis process must be optimized along with the algal feedstock in order to have an economical product while likely attempting to minimize the amount of char and gas, although these products could be recycle in other sectors or in the pyrolysis process<sup>[40]</sup>.

Table 4: Comparison of algal pyrolysis products to conventionally transportation fuels. <sup>[40]</sup>

Comparison of typical properties of fossil oil and bio-oils from fast pyrolysis of wood and microalgae

Properties	Typical value		Fossil oil
	Bio-oils		
	Wood	Microalgae	
C	56.4%	61.52%	83.0–87.0%
H	6.2%	8.50%	10.0–14.0%
O	37.3%	20.19%	0.05–1.5%
N	0.1%	9.79%	0.01–0.7%
S	n.d. <sup>a</sup>	n.d.	0.05–5.0%
Density	1.2 kg l <sup>-1</sup>	1.16 kg l <sup>-1</sup>	0.75–1.0 kg l <sup>-1</sup>
Viscosity (Pa s)	0.04–0.20 (at 40 °C)	0.10 (at 40 °C)	2–1000 (depends on temperature, density and its contents etc.)
Heating value	21 MJ kg <sup>-1</sup>	29 MJ kg <sup>-1</sup>	42 MJ kg <sup>-1</sup>
Stability	Not as stable as fossil fuels	Not as stable as fossil fuels, but more stable than the bio-oil from wood	

<sup>a</sup> n.d.: Not determined.

Table 5: A comparison of the differences in product composition produced from the pyrolysis of 6 different species of algae. <sup>[41]</sup>

The percentage of char, gas and liquid products evolved from slow pyrolysis of microalgae at 500 °C.

Species	Char (%)	Gas (%)	Liquid (%)
<i>T. chui</i>	37	20	43
<i>C. vulgaris</i>	34	25	41
<i>C. like</i>	37	22	41
<i>C. muelleri</i>	53	14	33
<i>D. tertiolecta</i>	63	13	24
<i>Synechococcus</i>	44	18	38

As mentioned earlier a catalyst can be used to obtain a more uniform and specified fuel, but a second gasification step could also be performed for similar results. When the distillate from a pyrolysis process is passed through a second reactor at similar temperatures and shape specific catalyst the amount of aromatic hydrocarbons can be greatly increased <sup>[42]</sup>. The second reactor increases the value of the fuel by giving it a higher heating value and producing a more uniform product. Also, by separating the process into two similar reactors allows for lower temperatures to be used without increasing the

amount of char and coke <sup>[42]</sup>. Coke is a dried solid product that is produced during pyrolysis and is mostly made up of inorganic salts <sup>[42]</sup>. Since less coke is produced, it may be a long term incentive to use a second reactor in order to avoid the coking of the catalyst. Catalysts in a pyrolysis process will undoubtedly be coated with coke as it is repeatedly used. As the catalyst is covered with coke it will begin to lose the properties that make it useful for fuel production and will need to be replaced, which can be a very expensive process and many catalysts also are expensive. The second reactor will however increase the total amount of energy used for conversion and the area needed for the facility. Anyone considering constructing a pyrolysis plant would need to carefully attempt to determine if a higher quality fuel and other advantages can economically justify the use of a second reactor.

One of the most promising aspects of algal pyrolysis is the relative ease to use recycled and unwanted products in the process. The CO<sub>2</sub> produced from the burning fuels to heat the reaction chamber can be mitigated by the algae through photosynthesis. The char collected can be reused as a fertilizer for crops, possibly producing more biomass if local agricultural wastes are also used as feedstock. The gas product can be burned in order to heat the feedstock for pyrolysis, with the possibility of enough energy to make the gasification of algae via pyrolysis a self sustaining process <sup>[41]</sup>. The current and future R&D on pyrolysis will eventually lead to further efficiency as new ways to obtain useful products at higher yields with less energy input will undoubtedly be discovered. Gasified organic products have huge potential for manipulation and exploitation.

### *Algae by 2020*

Obviously, algae can help solve the problems when fossil fuels finally run out, as well as reduce carbon dioxide emissions by using effluent sources from power plants, but there are even more applications for algae oil and the residual biomass. Algae farms can be paired with waste water facilities to further minimize costs and increase profits, as the process by which algae grows has been proven to remove bacteria and other organic compounds from water (Figure 11) <sup>[44]</sup>. What if algae could be used



as a “filter” to clean dirty water? The United States could solve the global clean water crisis by giving third world countries an inexpensive culture of algae. Furthermore, the biomass that is left after the oil extraction can be used for many other things. The dried algal mass which is high in protein can be used as animal feed or human food additives (Figure 12). Algae naturally produces other chemicals that can be useful such as phycobiliproteins which can be used as natural pigments in cosmetics and food coloring, marine oils used for omega fatty 3 oil supplements, and finally, chemicals that have been shown to lower cholesterol and stimulate the immune system<sup>[45]</sup>. Algae farming is a multi-faceted production, and all these other things can help make algae biodiesel plants a reality since there could be five products for one single process, increasing overall profits.

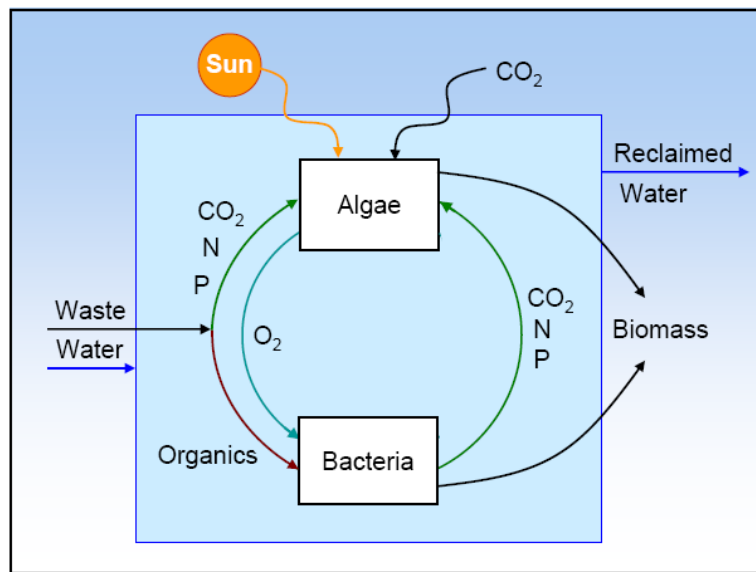

Figure 11: Waste water treatment during algae growth. <sup>[44]</sup>



Figure 12: Dried algal biomass for animal feed. <sup>[45]</sup>

In conclusion, due to the insurmountable evidence previously discussed, there should be much more private and government incentive to make large-scale algae production a reality as it holds much promise to improve the economy and the environment, including the multitude of useful products it can put on the market. The most efficient setup for algae biodiesel production from start to finish can be seen in Figure 13. The water used as the growing medium for the algae is pumped from a local waste water plant into the bioreactor. The algae grow to be harvested, dried, and the resulting biomass is transferred to the pyrolysis facility. During the oil extraction process, combustible gases are produced that can be recycled to power the pyrolysis system as well as carbon dioxide that can be added to increase algae growth in the bioreactor. The end products are biodiesel, char, treated waste water, and the beginning materials for various other products discussed previously. Moreover, the fact that the processes use a menagerie of effluent sources makes the particular setup very energy efficient as a result lowering costs on top of increasing profits due to the vast array of products produced from the single operation. If companies focus on systems that use recycled sources to grow algae, large-scale algae biodiesel production can become a reality sooner than expected.

The solution to the problems holding back algae biodiesel is easy; it does not require the collaboration of scientists to create an innovative and expensive design to grow algae and extract its oil. All pieces are there, but they have to be placed in the right order to complete the puzzle.

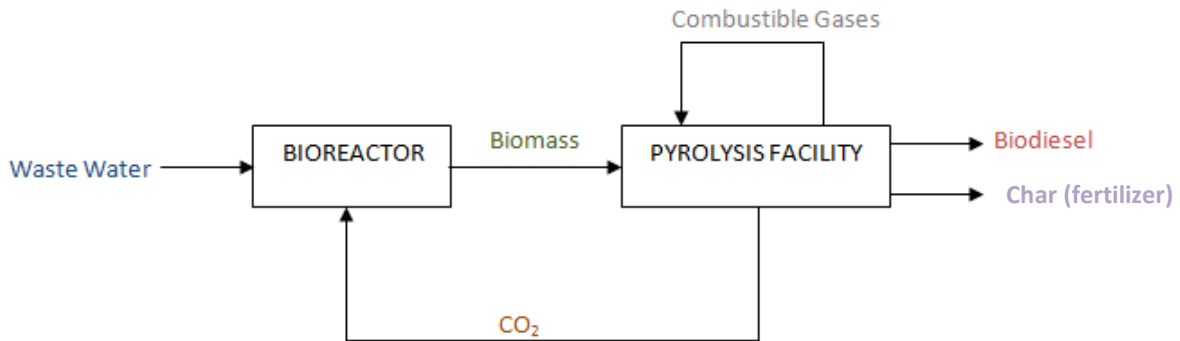

Figure 13: Schematic of cost efficient algae biodiesel production from start to finish.

## Economic Impacts

Aside from the benefits of the actual fuel, algae biodiesel could help our economy in more than one way. One of the problems that a lot of the companies mentioned earlier have struggled with is what procedures to use once they scale up their production. Processes that are easy to achieve in the lab can be disastrous once large scale production is in the works such as a particular harvesting technique that works well with small quantities of algae. However, there are some techniques that have not seen much attention because of the scale required to make it efficient such as a centrifuge. In order for algae biodiesel to make an impact on the amount of petroleum based fuel the United States uses, there will need to be algae harvesting and conversion to fuel on a large scale. Some existing plants that already use crude oil could potentially go straight to using algae instead with the technique of pyrolysis or hydrotreating described earlier. Also, the left over biomass from the algae can be used by many of these plants. However, with new designs being conceived for different ways to cultivate the algae such as bioreactors and batch processes there will likely be a demand for production plants to be constructed, meaning a creation of jobs for not only engineers but also maintenance workers. Another factor is if the

algae is farmed indoors the amount of energy and expenses to maintain the facility. These costs will all detract from the potential energy gain from algae biodiesel. When the production requires more energy to produce the fuel than the amount of energy the consumers will get from the fuel, the process becomes energy negative and therefore not efficient. From the companies we have researched into, a completely automated process seems somewhat off in the future also meaning more managerial and common everyday jobs to maintain the plants (Appendix A). When these companies build their production facilities it requires help from other businesses to assist in the design and construction of not only the physical buildings but also the hardware and equipment to maintain the flow of production. As seen in the pharmaceutical batch processes for production of medicine, there is a lot of hardware and software to monitor the flow of production and algae cultivation will most likely follow this trend. The company will want to know how efficiently their process and bioreactors are running and with monitoring their equipment they can develop models to track trends to improve their methods of cultivation and or fuel production. Most of the companies are in the early stages of development or do not have their full scale plants up and running. Being that there are a lot of unknowns about scaling up the production of microalgae because it is a new industry, many companies have pilot plants for small scale production such as Solazyme<sup>[19]</sup> and Sapphire Energy<sup>[22]</sup>. Due to the fact that these companies are on the forefront of algae biodiesel technology and production, they are the best models to use in order to gauge the overall impact if algae biodiesel replaced crude oil in America. For example, Solazyme has already produced 1500 gallons of jet fuel for the Navy to do testing on its safety and performance<sup>[10]</sup>. Solazyme is a large company that focuses not only on algae for oil production, but also is focused on the use of algae oil and biomass in cosmetics, and other applications previously mentioned. Therefore, the size and employee capacity of the Solazyme plant is not one that is helpful to speculate the large impact of algae farms. Sapphire Energy, on the other hand, is focused much more closely on oil production.

Sapphire Energy currently has a 100-acre field Research and Development facility in New Mexico in which they grow algae in open ponds using non-potable sea water. In a phone interview with VP of Corporate Affairs, Mr. Tim Zenk, a better understanding of potential impact Sapphire Energy can make on the transportation sector of the United States was established. A full transcript of the interview can be seen in Appendix A. They plan to construct a 300-acre Integrated Algal Bio-Refinery by the end of 2010 in which, as efficiency increases, they estimate to make 100 million gallons of crude oil by 2018, which can then be put in to the refinery on the premises (Table 6). The “green crude” produced by Sapphire’s algae biodiesel technologies creates a light sweet crude oil which can be processed in existing refineries, giving flexibility to where algae farms can be built and reducing the overall land use. Currently Sapphire is able to reach an efficiency of 3000 gallons per acre per year. In terms of the United States transportation sector, 26 quadrillion BTUs are consumed per year which equates to 200 billion gallons per year or 13 million bbl/day of crude while the DOE projects the number to be 13.6 million bbl/day. Sapphire claims that with 7 million acres of algae farms they would be able to replace 15 percent of the US transportation sector needs (Table 7). To replace 50 percent it would require 23 million acres which is comparable to the size of Indiana, although they would be located all over the country and not just in one area. Sapphire uses open ponds which are the least expensive growth method but is the most land demanding. Therefore, the amount of land Sapphire needs to replace a certain percent of US transportation fuel might be higher than if they used vertical bioreactors<sup>[27]</sup>. To put it into perspective, the 148 existing refineries in the United States is currently occupying 400,000 acres, but on average they can produce 2 billion gallons per year each. Considering the demand for oil will likely increase in the following years, the projected scale of necessary algae farms is lower than what might actually be needed. As time goes on and companies learn about the challenges of dealing with microalgae on a large scale, they will be able to produce the fuel more efficiently, which could result in a fewer amount of algae farms leading to the previous predictions being more accurate.

Table 6: Sapphire’s Projected Production of fuel in the future.

Year	Sapphire's Projected Production	
	(bbl/day)	(gallons/year)
by 2010	65	1 million
by 2018	6523	100 million
by 2025	65231	1 billion

Table 7: Required land to replace varying percents of transportation sector.

Transportation Sector Replaced	US Trans	Land for Algae
(%)	(bbl/day)	(acres)
15%	2 million	7 million
50%	6.8 million	23 million
90%	12 million	42 million

As the demand for growing algae outdoors increases more and more jobs will arise and existing farmers could also produce crops for the new market. Certain microalgae strains favor different combinations of nutrients leading to those strains growing better outdoors compared to a controlled environment in a batch process. There are many potential job creations for not only designing microalgae farms, but also the construction and maintenance of these facilities. Tim Zenk predicts that the construction of Sapphire Energy’s 300 acre facility will create 700 jobs total and 40-50 full time employees upon completion. The positions will include everything from unskilled workers to engineers and scientists (Appendix A). With potential research of genetically enhancing certain strains to better produce the components you want whether that be long hydrocarbons or lipids the biotech and biochemistry fields will be used in algae farming. Also, the ability to better understand why certain strains prefer certain conditions considering algae grow in a wide variety of climates is important. Companies have to invest a lot of time and money into selecting the optimum strain for their style of

production. Once these companies have more time invested and solve some of these problems is when they will be able to lower production costs thus allowing for a cheaper product. Similar to how pharmaceutical companies must invest a lot of time and money into drug research to see a return on their efforts once large scale production is underway.

The automotive industry would also benefit from algae biodiesel becoming a forerunner in America's renewable biofuels because it does not require extensive modifications to their existing designs of diesel engines. Companies that are adopting electric cars are going to need to invest a lot of money because it will require a lot of research into new designs of engines and ways people fuel their automobiles. Therefore, these companies would need to replace the entire automotive industry. With algae biodiesel, however, the car companies can spend their efforts and research on making current designs more efficient and long lasting since algae oil can fuel existing engines.

With politics and government playing an increasing role when it comes to the environment with cap and trade bills, companies and power plants might be able to divert some of their CO<sub>2</sub> emissions to algae farms considering one of the needed nutrients for algae is CO<sub>2</sub>. In Sapphire's production of one gallon of algae oil 13 to 14 kg of CO<sub>2</sub> is consumed <sup>[22]</sup>. While CO<sub>2</sub> is also released when the fuel is burned the algae consume 70 percent of these emissions, resulting in only 30 percent being released into the environment as compared to fossil fuels. Sapphire plans to mitigate CO<sub>2</sub> from factories and power plants to help create an environment in which algae thrive and remove excess CO<sub>2</sub>. This might also play a role in deciding what parts of the country these new facilities will be built in among other factors.

## **The Time is Now**

According to an article published in the Independent Newspaper in 2007, all major oil companies claim that there is enough fossil fuel to last for at least another 40 years including BP's Statistical Review of World Energy. "However, scientists led by the London-based Oil Depletion Analysis

Centre, say that global production of oil is set to peak in the next four years before entering a steepening decline which will have massive consequences for the world economy and the way that we live our lives <sup>[47]</sup>.” Therefore, the government should increase incentives, and venture capitalists should have much more urgency for their investments in research for alternative fuel sources. From all the evidence previously presented, algae biodiesel has the greatest potential to input biofuel where the non-renewable fuels are beginning to lack. Sapphire Energy is an important company that should receive much more incentive from the government, as well as companies like Solazyme who are on the forefront of algae biodiesel innovation. Sapphire Energy’s process of oil extraction converts the algae into “green crude” that can be processed in existing refineries. This will save the companies trying to get involved in algae biodiesel time and money since the algae oil can be integrated into the existing oil and fuel infrastructure. It will also allow for the new algae farms to be added as the need increases for more oil. Most other alternative fuel sources, such as corn or soy, would require far more land than is available in the United States to make an impact on the American fuel demand, and would also require land that is used for food stocks. Algae can use non-arable land and non-potable water eliminating the food vs. fuel conflict. There are multiple deserts in the Southwest region of the United States which falls into this category of land, which are mostly uninhabited, full of sunshine and relatively hot climate year round creating an environment in which algae thrive. Tim Zenk mentioned that Sapphire’s Research and Development facility is located in the desert of New Mexico where they use underground aquifers to supply the open ponds (Appendix A). The largest desert in America is the Great Basin Desert which encompasses most of Nevada and parts of California and Utah, totaling 120 million acres. If there are underground aquifers located in all the desert areas, there is surely enough arid land available to support the amount of algae farms needed to replace the United States dependence on fossil fuels. The process to grow algae also uses recycled carbon dioxide to increase the growth rate of the algae population as well as balance out the emissions released into the environment. With the possibility of



CO<sub>2</sub> credits and tax cuts for renewable resources, the subsidies will provide the funds to help companies get started because the initial investment for an algae farm will be high. However, once these companies establish themselves they must be efficient enough to make a profit because subsidies will not last forever. There is also potential for algae oil and its biomass to impact other sectors of the economy, such as cosmetics and pharmaceuticals. If more companies and private investors follow in the footsteps of companies like Solazyme and Sapphire Energy, the potential and impact of algae biodiesel will be seen in the daily lives of Americans in a few years. There is no question that the fossil fuel will run out, and as the supplies diminish the price will continue to increase as well as the conflict of which countries claim the last reserves of oil. Companies and investors that become involved in algae biodiesel now will surely see a large return in the near future.

## Appendix:

### Appendix A:

Transcript from phone interview with Tim Zenk, VP of Corporate Affairs, Sapphire Energy  
October 4<sup>th</sup> 2010

1. We had a question about some of your projected production rates. In 2018, Sapphire Energy plans on producing 100 million gallons per year of diesel and jet fuel. We were wondering if the 100 million gallons were projected to be produced from your 300 acre facility currently being built, or are further expansions necessary? Or are the 1 million gallons in 2015 from that facility? Also, is that 1 million gallons of green crude, or is that 1 million gallons of each product?

**Tim:** The 300 acre facility is expected to produce 1 million gallons of green crude per year. From here we will be able to demonstrate the complete process from biology to fuel on a large scale. The composition of the green crude is a light sweet category of oil which is comparable to the current fossil fuels.

2. We were also curious how many employees are estimated to be working full time at the 300 acre facility? What sort of shifts and responsibilities may some the employees have there?

**Tim:** The construction of the facility provides the opportunity for many jobs, about 700 jobs total. There will be 40-50 full time employees once the facility is completed. The positions will range from unskilled workers up to scientists and engineers.

3. For the saline water in the open ponds, are you using a local source? Ocean water? Or a proprietary mix/source? Does the salinity help prevent contamination by local algae and other microorganisms?

**Tim:** Well, we are located in New Mexico where there are underground aquifers of brackish water which is non-potable; therefore, the valuable resource of fresh water is reserved. As the water evaporates, the salinity levels can get very high so the algae are engineered to adapt to the high salinity environment.

4. The projected yields are in given in gallons of diesel and jet fuel, are those the two main refining products of your Green Crude or are there a percent for gasoline as well?

**Tim:** The demand and pay off is highest for jet fuel and diesel, although gasoline can be made from the green crude as well. Our company will be able to adjust to the fluxes in the market for these three distillates. A barrel of algae oil is 98% refinable.

5. In the video on your website it was mentioned that 50 million acres would be needed for Sapphire to replace 100% of the current petroleum usage in the US, is the area of the refineries needed to process the green crude included in that land area?

**Tim:** That's not a number that I am familiar with using. I usually start with projections of replacing 15% of the current U.S. usage, which would require 7 million acres to achieve such an impact. To put this in perspective if corn ethanol fuel was used, it would require 90 million acres of land to replace the same 15% percent. We measure it by the gallon per acre per year, and our company is currently at 3000 gallons/acre/year. Co-location with large CO<sub>2</sub> emitters is an option for the algae farms. Sapphire will transport the green crude to refiners in any manner that makes the most sense economically.

6. Do you have a projected cost of production/gallon of product for either 2015 or 2018?

**Tim:** Before our company goes commercial, it must be as efficient as the crude industry. With current costs, we will be able to achieve 75\$ to 80\$ for a barrel of algae oil. The ultra deep oil that is being tapped into now goes for 80\$ a barrel.

Miscellaneous Information:

-Sapphire Energy was awarded 104.5 million dollar. A \$50 million Stimulus grant from the USDOE and a \$54.5 loan guarantee from USDA. Sapphire Energy will match the federal money with \$35 million of this to build their 300 acre facility in three stages.

-Sapphire's three reasons to use algae:

- 1) Algae are one of the most photosynthetically efficient plant sources available.
- 2) Sapphire made the decision to use non-potable water in order to save the valuable resource of fresh water and not cut into agricultural land.
- 3) Algae oil is a drop in fuel replacement. Sapphire Energy has already produce gasoline, diesel and jet fuel. We have driven a gasoline powered car across the United States on algae derived gasoline and participated in a test flight of algae derived jet fuel with Boeing and Continental Airlines. Continental flew an 737-800 around Houston for 2.5 hours on fuels we made for the test flight.

-The 300 acre facility will fix 15 metric tons of CO<sub>2</sub>/day.

## References

- [1] U.S.DOE, EIA, 2008. Energy Information Administration. Annual Energy Review 2008 (Washington, DC) <<http://www.eia.doe.gov/emeu/aer/pdf/aer.pdf>>
- [2] Hammerschlag, R. 2006. Ethanol's energy return on investment: a survey of the literature 1990–present. *Environmental Science & Technology* 40, 1744–1750.
- [3] ExxonMobil, 2009. The Outlook for Energy: A View to 2030, <[http://www.exxonmobil.com/corporate/files/news\\_pub\\_eo\\_2009.pdf](http://www.exxonmobil.com/corporate/files/news_pub_eo_2009.pdf)>
- [4] Tickell, J. 2000. From the Fryer to the Fuel Tank, third ed. Tickell Energy Consultants, Covington, LA, p. 144.
- [5] US Environmental Protection Agency. “Climate Change” Last updated on Tuesday, February 16, 2010. Accessed 9/25/10 <<http://www.epa.gov/climatechange/fq/emissions.html#q5>>
- [6] Perujo, Adolfo and Ciuffo, Biagio. The introduction of electric vehicles in the private fleet: Potential impact on the electric supply system and on the environment. A case study for the Province of Milan, Italy. *Energy Policy* 38 (2010) 4549–4561
- [7] Plautz, Jason. States See Rebirth in Auto Battery Manufacturing. New York Times. Energy and Environment. July 12<sup>th</sup>, 2010. Accessed 9/25/10 <<http://www.nytimes.com/gwire/2010/07/12/12greenwire-states-see-rebirth-in-auto-battery-manufacturi-12034.html?pagewanted=2>>
- [8] Christi, Yasurf. Biodiesel from Microalgae. 2007. *Biotechnology Advances* 25, 294-306
- [9] General biodiesel. Biodiesel Now. 5/12/2010 <[http://www.biodieselnow.com/general\\_biodiesel\\_21/default.aspx](http://www.biodieselnow.com/general_biodiesel_21/default.aspx)>
- [10] Vasudevan, Palligarnai T.; Briggs, Michael. Biodiesel production—current state of the art and challenges. *J Ind Microbiol Biotechnol* (2008) 35:421–430 DOI 10.1007/s10295-008-0312-2
- [11] Biodiesel Basics. “Biodiesel, America’s First Advanced Biofuel” National Biodiesel Board 2010. 5/12/2010 <[http://biodiesel.org/resources/biodiesel\\_basics/](http://biodiesel.org/resources/biodiesel_basics/)>
- [12] de-Bashan, Luz E.; Bashan, Yoav Immobilized Microalgae for Removing Pollutants: Review of Practical Aspects. *Bioresource Technology* 101 (2010) 1611–1627
- [13] Griffiths, Melinda J.; Harrison, Susan T. L.. Lipid productivity as a key characteristic for choosing algal species for biodiesel production. *J Appl Phycol* (2009) 21:493–507 DOI 10.1007/s10811-008-9392-7
- [14] Hilén, W. Hydrocracking of the Oils of *Botryococcus braunii* to Transportation Fuels.

- Biotechnology & Bioengineering. 1982, 24(1) 193
- [15] Frenz, J. Hydrocarbon Recovery and Biocompatibility of Solvents for Extraction of Cultures of *Botryococcus braunii*. *Biotechnology & Bioengineering*. 1989, 34(6) 775
- [16] Orpez, Rafael. Growth of the Microalga *Botryococcus braunii* in Secondarily Treated Sewage. *Desalination* 246 (2009) 625–630
- [17] Ranga Rao, A. Effect of salinity on growth of green alga *Botryococcus braunii* and its constituents. *Bioresource Technology* 98 (2007) 560–564
- [18] Duvall, Mark N., Fraker, Russell N. “Algae-Based Biofuels Attract Incentives and Investments” *Beveridge & Diamond, P.C.* September 14, 2009.
- [19] “5 Companies Making Fuel from Algae Now” *Popular Mechanics*. Jeremy Jacquot. October 13, 2009. January 10, 2010. <<http://www.popularmechanics.com/science/research/4333722.html>>
- [20] “Algenol Biodiesel: Harnessing the Sun to Fuel the World™” *Algenol Biodiesel*. September 2009. February 23, 2010 <<http://www.algenolbiofuels.com/Algenol%20101%20Sept%202009.pdf>>
- [21] “Solix: Algae to Energy” *Solix Biofuels Inc.* 2009. University of Colorado. February 23, 2010. <<http://www.solixbiofuels.com/content/technology>>
- [22] “Sapphire Energy, Inc.” *Sapphire Energy, Inc.* 2010. February 23, 2010. <<http://www.sapphireenergy.com/green-crude/>>
- [23] “Seambiotic” *Seambiotic*. 2008. February 23, 2010. <<http://www.seambiotic.com/home/vision/>>
- [24] “Exxon to Invest Millions to Make Fuel from Algae” *New York Times*. Jad Mouawad. July 13, 2009. February 2, 2010. <[http://www.nytimes.com/2009/07/14/business/energy-environment/14fuel.html?pagewanted=1&\\_r=1](http://www.nytimes.com/2009/07/14/business/energy-environment/14fuel.html?pagewanted=1&_r=1)>
- [25] “Algae Farm” University of California San Diego. April 2, 2010. <<http://algae.ucsd.edu/algae-farm.shtml>>
- [26] Hatcher, Patrick G.; Stubbins, Aron; Salmon, Elodie. “Raceways for Cultivating Algae.” Patent US 2010/0031561 A1. Feb. 11, 2010.
- [27] “A Look Inside Renewed World Energies’ Algae Bioreactor” *Knovel Corporation*. 2009. April 9, 2010. <<http://engineeringcases.knovelblogs.com/2010/01/26/a-look-inside-renewed-world-energies-algae-bioreactor/>>

- [28] Banerjee, Anirban; Sharma, Rohit; Chisti, Yusuf; and Banerjee, U. C. *Botryococcus braunii: A Renewable Source of Hydrocarbons and Other Chemicals*. *Critical Reviews in Biotechnology*, 22(3):245–279 (2002)
- [29] “Fermentation or photosynthesis: The debate in algae fuel.” *CBS Interactive*. Kanellos, Michael. January 28, 2008. April 10, 2010. <[http://news.cnet.com/8301-11128\\_3-9859455-54.html](http://news.cnet.com/8301-11128_3-9859455-54.html)>
- [30] Li, Yanqun; Horsman, Mark; Wu, Nan; Lan, Christopher Q.; Dubois-Calero, Nathalie. “Biofuels from Microalgae.” *American Chemical Society and American Institute of Chemical Engineers*. March 12, 2008.
- [31] Tampion and Tampion, 1989. Immobilized cells; principles and applications *Journal of Chemical Technology & Biotechnology* 45;1;77
- [32] Lee, Andrew K.; Lewis, David M.; Ashman, Peter J. “Microbial flocculation, a potentially low-cost harvesting technique for marine microalgae for the production of biodiesel.” *J Appl Phycol*. (2009). **21**: 559-567.
- [33] Wiley, Patrick E.; Brenneman, Kristine J.; Jacobson, Arne E. “Improved Algal Harvesting Using Suspended Air Flotation.” *Water Environment Research*. July 2009. **81.7**: 702-708.
- [34] Voet, Voet, Pratt. (2008). Fundamentals of Biochemistry: Life at the Molecular Level, 3<sup>rd</sup> Edition. John Wiley & Sons Inc.
- [35] Milne, Thomas A.; Evans, Robert J. and Nagle, Nicholas. Biomass Catalytic conversion of microalgae and vegetable oils to premium gasoline, with shape-selective zeolites. Volume 21, Issue 3, 1990, Pages 219-232
- [36] M. Ringer, V. Putsche, and J. Scahill. Large-Scale Pyrolysis Oil Production: A Technology Assessment and Economic Analysis. *Technical Report NREL/TP-510-37779* November 2006
- [37] Clearfuels Company page , <http://www.clearfuels.com/>>
- [38] Solena Group Company page < <http://www.solenagroup.com/>>
- [39] Tran, N.H., Bartlett, J.R., Kannangara, G.S.K., Milev, A.S., Volk, H., Wilson, M.A.. Catalytic upgrading of biorefinery oil from micro-algae. *Fuel* 89 (2010) 265–274
- [40] Miao, Xiaoling; Wu, Qingyu; Yang, Changyan. Fast Pyrolysis of Microalgae to Produce Renewable Fuels. *J. Ana.l Appl. Pyrolysis*. 2004 855-863
- [41] Grierson, Scott; Strezov, Vladimir; Ellem, Gary; Mcgregor, Ross; Herbertson. Thermal Characterization of Microalgae Under Slow Pyrolysis Conditions. *J. Anal. Appl Pyrolysis*. 2005 118-123

- [42] Tran, N.H., Bartlett, J.R., Kannangara, G.S.K., Milev, A.S., Wilson, M.A. Catalytic Upgrading of Biorefinery Oil from Micro-algae. *Fuel* 2010, 89, 265-274
- [43] Landesman, Lois, Ph.D. "Alternative Uses for Algae Produced for Photosynthetic CO<sub>2</sub> Mitigation". May 9, 2010.  
<<http://www.wri.nrcce.wvu.edu/conferences/2008/WRRRI/pdf/presentations/Landesman.pdf>>
- [44] Lundquist, Tryg J. Ph.D. "Production of Algae in Conjunction with Wastewater Treatment". California Polytechnic State University. May 9, 2010.  
<<http://www.nrel.gov/biomass/pdfs/lundquist.pdf>>
- [45] "Oilgae" *Oilgae* 2010. March 16, 2010.  
< <http://www.oilgae.com/algae/oil/biod/tra/tra.html/>>
- [46] "Dewitt and Company Inc." *Dewitt and Company Inc. 2010. May 15, 2010.*  
<<http://www.methanol.org/pdf/DeWittStudyV2.pdf>>
- [47] Howden, Daniel. "World oil supplies are set to run out faster than expected, warn scientists". *Independent*. June 14, 2007. September 27, 2010.  
<<http://www.independent.co.uk/news/science/world-oil-supplies-are-set-to-run-out-faster-than-expected-warn-scientists-453068.html>>