

Flood Mitigation of Macomber's Way in Marshfield, Massachusetts

A Major Qualifying Project

Submitted to the faculty of
Worcester Polytechnic Institute

In partial fulfillment of the Requirements for the
Degree of Bachelor of Science

Submitted by

Samuel Bartlett

Allison Roche

Brendan Stitt

Dated April 26, 2012

Professor Paul Mathisen, Co-Advisor

Professor Suzanne LePage, Co-Advisor

Abstract

Tidal flows in the English Salt Marsh flood over Macomber's Way daily, creating dangerous driving conditions. Two culverts allow flow to pass through the causeway, which exacerbates scour of marsh banks and vegetation. A design to mitigate erosion and flooding was developed through analysis of water elevations and culvert flowrates throughout a tidal cycle. The recommended design includes a road maintenance plan, the replacement of an existing culvert with a concrete box culvert, and future consideration of a third culvert.

Capstone Design Criteria

The Accreditation Board for Engineering and Technology (ABET) criteria requires a capstone design project to consider most of the following realistic constraints: economic, environmental, sustainability, constructability, ethical, health and safety, social, and political. The goal of this project is to design a culvert system that will restore estuarine flow circulation and reduce roadway flooding, allowing for safe access to a residential island. Relevant constraints were considered in the final design and a summary is provided in this section.

Economic: Cost drives most engineering decisions, including the design chosen for this project. The scope of this project considered economic constraints, and completed a cost-analysis for each design option as a part of determining the final design choice. The major cost associated with the design solution would be the construction of the culvert(s). The maintenance costs will be minor in comparison. Cost is an important consideration because a flood-mitigating design will save money on repairing water damage to homes and cars; residents will still prefer a design that requires minimal upfront spending, since the Town of Marshfield is not responsible for paying for roadwork on Macomber's Way.

Environmental: This project directly involves a marsh environment. Estuary ecosystems support an array of wildlife and plants. During the research phase, field work was minimally invasive and did not disrupt habitats or natural flow dynamics. The implications of the final design, if implemented, would temporarily disrupt the area during construction but the purpose of the project and the design is to ultimately improve the conditions of eroding marsh banks and enable vegetation to grow where scour currently exists. Construction work will be temporary, but the structures will be designed to support future environmental improvement. The culvert was designed to allow increased volumes of flow to restore more natural, less restricted, tidal flows and allow the marsh to drain more easily during ebb current conditions.

Constructability: Extensive background research supports the constructability of the culvert. Flow conditions in the marsh were monitored and then fitted to appropriate culvert sizes and styles. Several providers were found that make and sell culverts of the desired material, shape, and size specified in the design. Considerable research was involved in the design process, including the analysis of current best practices, types of materials used to withstand natural erosion or shoaling, and building with minimal ecological impact. Alternative designs were also drafted and considered, and the final decision was ultimately a feasible and buildable option for the site.

Health and safety: The current state of Macomber's Way presents safety risks during high tide when the causeway becomes flooded and impassible. This design attempts to lessen the extent of the flooding in residential areas, therefore reducing health and safety risks. Existing conditions could pose accessibility issues of the island for emergency vehicles. A design that

mitigates the flooding on the causeway to any degree is an improvement to the safety of Trouant's Island residents.

Social: Social implications of this project involved accessing privately owned land for field work. The implementation of the design would also require approval of residents since the Town of Marshfield does not control Macomber's Way and the existing culverts. Zoning laws must also be considered to ensure that the culvert meets any aesthetic or otherwise limiting statutes.

Political: The background research of the site required contact with state and municipal agencies including the Town of Marshfield Conservation Commission, Town of Marshfield Assessor, Commonwealth of Massachusetts Division of Fisheries and Wildlife, and Massachusetts Office of Coastal Zone Management. Alterations to the marsh would require approval of the Town of Marshfield Conservation Commission, the Massachusetts Division of Fisheries and Wildlife, and the Town of Marshfield Planning Commission, as well as the residents of Trouant's Island who have ultimate control of the culverts in the causeway.

Authorship

1. Introduction	All
2. Background	All
2.1. Formation of a Salt Marsh	SB
2.2. Tides	AR
2.3. Longshore Drift and Coastal Changes	AR
2.4. Sea-Level Rise in Estuaries	AR
2.5. Salt Marsh Ecology and Economy	SB
2.6. Marsh Studies	AR
2.7. Marshfield History	SB
2.8. Site Description	BS & AR
2.9. Culverts	SB
3. Methodology	All
3.1. Project Scoping Activities	AR
3.2. Field Monitoring Events	AR
3.3. Describe Existing Conditions	AR& SB
3.4. Conceptualize Design Options	All
3.5. Develop Final Design	BS
4. Results and Discussion	All
4.1. Existing Conditions	AR & SB
4.2. Identification of Design Options	SB & BS
4.3. Evaluation of Design Options	SB & BS
5. Conclusions and Recommendations	All
5.1. Culvert 2 Design	BS & AR
5.2. Design Summary	AR

Together the three members of the project team performed all of the field and laboratory work. The team collectively developed the project overview including the problem statement and goal statement, the abstract, and the capstone design statement. Each team member was involved in editing the report.

Acknowledgments

We would like to thank our project advisors, Professor Paul Mathisen and Professor Suzanne LePage for their help throughout the year. Also, a special thanks go to Jay Wennemer of the Town of Marshfield Conservation Commission and Jim Tarbox of Tarbox Construction for sharing their expertise and knowledge of the site with us, and for always responding to our questions. Lastly, we would like to acknowledge Don Pellegrino, and thank him for his help with laboratory procedures.

Table of Contents

1. Introduction.....	1
1.1 Overview	1
1.2 Problem Statement	2
1.3 Goal Statement	2
1.4 Overall Approach.....	2
2. Background.....	3
2.1 Formation of a Salt Marsh.....	4
2.1.1 Carving and Melting	5
2.1.2 A New Marsh is Formed.....	5
2.2 Tides	6
2.3 Longshore Drift and Coastal Changes	8
2.4 Sea-Level Rise in Estuaries.....	10
2.5 Salt Marsh Ecology and Economy	13
2.5.1 Regulations on Marsh Development.....	13
2.6 Marsh Studies.....	14
2.7 Marshfield History	15
2.7.1 The Salt Marsh Resource	16
2.7.2 The New Inlet	16
2.7.3 Residential Development	17
2.7.4 Causeway Development.....	17
2.8 Site Description	18
2.9 Culverts	20
2.9.1 Problems with Culverts.....	20
2.9.2 Culvert Hydraulics: Classifying Flow Types.....	20
3. Methodology	23
3.1 Project Scoping Activities.....	23
3.1.1 Contacting Local Stakeholders	23
3.1.2 Site Reconnaissance Visits	24
3.2 Field Monitoring Events.....	25
3.2.1 Measuring tidal elevations	25
3.2.2 Velocity Measurements	27
3.2.3 Examining Culvert and Channel Conditions	29
3.3 Describe Existing Conditions.....	30
3.3.1 Normalize Depth Data	31
3.3.2 Determine Flowrates.....	34
3.3.3 Determine Tidal Volume	46
3.3.4 Soil Grain Size Analysis	47
3.4 Conceptualize Design Options.....	48
3.5 Develop Final Design.....	49

3.5.1	Loading Rate	50
3.5.2	Design Flow Rate.....	51
3.5.3	Selecting design size	51
3.5.4	Maximum allowable headwater	55
4.	Results and Discussion	56
4.1	Existing Conditions	56
4.1.1	Culvert Characteristics.....	56
4.1.2	Soil Grain Size Analysis	57
4.1.3	Tides and Flooding	57
4.1.4	Storm Tides.....	60
4.1.5	Depth Data	62
4.1.6	Flowrates.....	66
4.1.7	Volumes	72
4.2	Identification of Conceptual Design Options.....	74
4.2.1	General Regulatory Considerations	74
4.2.2	Installation of Additional Culvert.....	75
4.2.3	Removing culverts	76
4.2.4	Replacing Existing Culvert.....	76
4.2.5	Raise the road.....	76
4.2.6	Build a bridge.....	76
4.2.7	Energy Dissipaters	77
4.2.8	Increased Road Maintenance	77
4.3	Evaluation of Design Options	77
4.3.1	Installation of Additional Culvert.....	78
4.3.2	Removing Culverts	79
4.3.3	Replace Existing Culvert	79
4.3.4	Elevate Road	80
4.3.5	Build a Bridge.....	80
4.3.6	Energy Dissipaters	81
4.3.7	Road Improvement and Increased Maintenance.....	81
5.	Conclusions and Recommendations	84
5.1	Culvert 2 Design.....	84
5.1.1	Materials	85
5.1.2	Loading rate	86
5.1.3	Backfill.....	87
5.1.4	Hydraulic Design and Sizing	88
5.1.5	Cost Analysis	89
5.1.6	Design Standards	89
5.2	Design Summary	90
5.2.1	Road Maintenance	90

5.2.2	Culvert 2 Replacement.....	90
5.2.3	Future Consideration of Third Culvert	90
6.	Works Cited	91
7.	Appendix.....	95
7.1	Project Proposal.....	95
7.2	Order of Conditions.....	110
7.3	Soil Grain Data.....	111
7.4	Depth Data.....	112
7.5	Flowrates	131
7.6	Volumes through Culvert.....	140
7.7	Weir Flow: Road Overtopping.....	143
7.8	Design Calculations.....	145
7.9	Nomograph.....	149

Table of Figures

Figure 1: Map of English Salt Marsh and Macomber’s Way (Source: Google Maps, 2011).....	1
Figure 2: Flooding of Macomber’s Way on September 16, 2011 (Photo source: Brendan Stitt, 2011)	2
Figure 3: Map of English Salt Marsh (adapted from Google Maps, 2012)	3
Figure 4: Ice Age glaciers in North America (Emergence of People in North America, 2002).....	5
Figure 5: Marsh Zones by Vegetation (Carlisle, Donovan, Hicks, Kooken, Smith, & Wilbur, 2002)	6
Figure 6: Velocity over a Tidal Cycle and Null Points (US Army Corps of Engineers, 1991).....	7
Figure 7: Longshore Drift Diagram (Zivkovic Geophysical Investigations, LLC, 2011)	9
Figure 8: Shoreline Change from 1952 to 2001 (Massachusetts Office of Coastal Zone Management, 2005)	10
Figure 9: Diagram of the Bruun Rule showing translation of the beach with sea-level rise	12
Figure 10: The New Inlet and Trouant’s Island, relative to the old inlet further south	16
Figure 11: Tidal Flows through New Inlet	18
Figure 12: Location of Culverts in Macomber’s Way	19
Figure 13: Classification of culvert flow (Bodhaine, 1988)	21
Figure 14: Flooding along the sides of Macomber’s Way (Photo source: Brendan Stitt, November 11, 2011)	25
Figure 15: Sample Locations for Deployment of Depth Probes at Culvert 2	26
Figure 16: Gurley Water Current Meter (Gurley Precision Instruments, 2004).....	28
Figure 17: Macomber’s Way at low tide, October 2010 (Photo source: Chris Bernstein).....	30
Figure 18: Flow chart of depth data normalizing procedure.....	32
Figure 19: Energy and Hydraulic Grade Lines in Culvert Flow (FishXing, 2010)	37
Figure 20: Barnacle cover of Culvert 2 (Stitt, 2011)	38
Figure 21: Circular Culvert Geometry (LMNO Engineering, Research, and Software, Ltd., 2000)	39
Figure 22: Type 4 Flow Diagram (Bodhaine, 1988).....	40
Figure 23: Water flowing over the roadway (Stitt, 2011).....	42
Figure 24: Broad-crested weir (adapted from Sturm, 2009).....	43
Figure 25: Energy Grade Line through culvert (Singh, 2007).....	45
Figure 26: Trapezoidal Rule of Approximate Integration (Weisstein, 2012).....	46
Figure 27: Hjulstrom Curve (courtesy of MIT OpenCourseWare)	48
Figure 28: Nomograph for Box Culverts with Inlet Control	53
Figure 29: Culvert 2 Profile & Relative Elevations.....	56
Figure 30: Linear Regression Relating Tide Height to Road Flooding	60
Figure 31: Storm Surge and Storm Tide Example (National Oceanic and Atmospheric Administration, 2012)	61
Figure 32: Depth Data for 11/30-12/1	63
Figure 33: Depth Data for 12/12-12/13	64

Figure 34: A) Depths Over a Tidal Cycle, and B) Flowrates Over a Tidal Cycle (11/30)	67
Figure 35: A) Depths Over a Tidal Cycle, and B) Flowrates Over a Tidal Cycle (12/12)	69
Figure 36: Culvert Performance Curve (Mohtar, 2001)	70
Figure 37: Weir Flow Diagram.....	72
Figure 38: Potential Location for 3rd Culvert (adapted from Google Maps, 2012).....	75
Figure 39: Uneven flooding conditions near Stone Blocks (Stitt, 2011).....	82
Figure 40: Three-sided box culvert (Shaw Precast Solutions, 2012).....	85
Figure 41: Load Capacities for Various Culvert Sizes (Kistner Concrete Products, Inc., 2004) .	87
Figure 42: Order of Conditions for the Site SE 42-516.....	110
Figure 43: Inlet Control Nomograph	149

1. Introduction

1.1 Overview

The English Salt Marsh in Marshfield, Massachusetts is part of an estuary at the intersection of the North River and South River with the Atlantic Ocean. Estuaries are dynamic ecosystems, sources of income, and often are highly populated areas. However, these valuable coastal zones are vulnerable to degradation and flooding. Flooding is aggravated when the tidal cycle is disrupted through natural or artificial means. Natural flow alterations can be caused by dramatic storm events, erosion, embankment slump, shoaling, and influence by local or invasive species. Artificial flow obstruction is the result of the implementation of man-made structures in the marsh such as dams, weirs, or culverts.

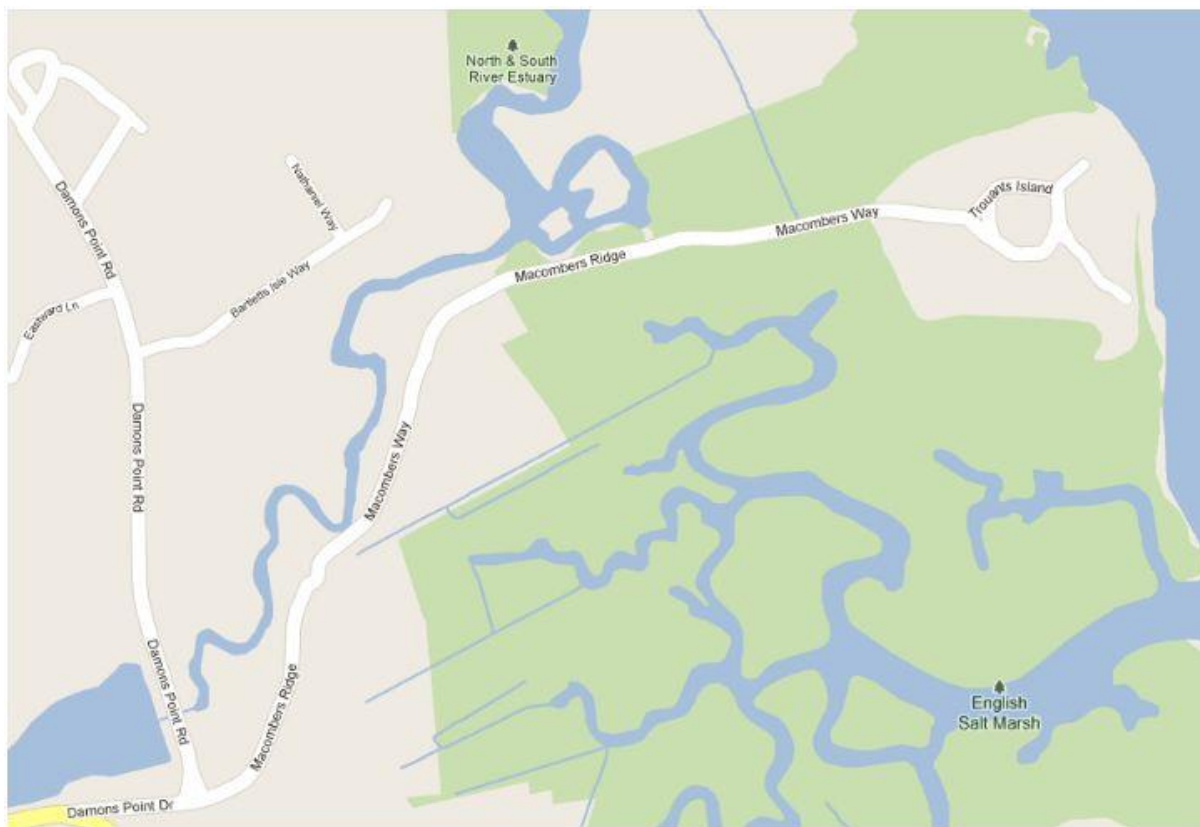

Figure 1: Map of English Salt Marsh and Macomber's Way (Source: Google Maps, 2011)

Macomber's Way is a man-made causeway that spans part of the English Salt Marsh and provides access to Trouant's Island (Figure 1). The causeway becomes submerged twice daily during high tides, restricting safe access to and from the island. Although this flooding is inevitable based on the elevation of the causeway compared to average high tide levels, a combination of natural and artificial flow obstructions in and around the causeway also contribute to scouring, erosion, and damage to properties and vehicles.

1.2 Problem Statement

The two culverts along Macomber's Way constrict the natural ebb and flow of the tides, causing a backup of water on the north side of the causeway, which increases the submergence of the roadway (see Figure 2) and exacerbates local embankment scour and sedimentation.



Figure 2: Flooding of Macomber's Way on September 16, 2011 (Photo source: Brendan Stitt, 2011)

1.3 Goal Statement

The goal of this project was to create a cost-effective design that a) protects the natural environment from degradation due to scour and erosion and b) mitigates flooding by maximizing the capability of hydraulic structures to divert flows from the roadway.

1.4 Overall Approach

Extensive background research was involved in this project, in areas such as coastal zone management and flood controls, estuarine processes and the effect of man-made flow obstructions, as well as culvert design and implementation in natural waterways. The conditions of the roadway and culverts were assessed during field monitoring events. Water surface elevations at one of the culverts were monitored over a tidal cycle and flowrates were determined through calculation, the results of which are presented in Chapter 4. Through the analysis of field data combined with the application of theory presented in literature, a final design was developed to mitigate local erosion and flooding along Macomber's Way.

2. Background

Estuaries are coastal wetlands that receive water inputs from both rivers and the ocean. These dynamic ecosystems serve as transitional zones between freshwater and saltwater environments, where the conditions change based on influences of freshwater flow, sediment, and ocean tides. These influences, in addition to natural or man-made flow alterations, make these valuable coastal zones vulnerable to degradation and flooding.

The English Salt Marsh in Marshfield, Massachusetts is an example of such an estuary. This coastal marsh receives tidal flow from the Atlantic Ocean via New Inlet, in addition to flow from the North River and South River. Flooding has been apparent in and around this marsh in recent years, specifically along Macomber's Way, the man-made causeway that provides access to Trouant's Island across the marsh. Trouant's Island and Macomber's Way are both labeled on the map in Figure 3.



Figure 3: Map of English Salt Marsh (adapted from Google Maps, 2012)

The gravel roadway is subject to flooding twice per day around high tide, and more extreme flooding during storm conditions. Two culverts allow the passage of some flow through the

causeway, but the road inevitably becomes flooded due to its elevation. The elevation of the road is regulated by the Massachusetts Department of Environmental Protection (DEP) and must not exceed the elevation of the marsh grass. This maximum road elevation is lower than the average high tide water level, so flooding is an inevitable occurrence without a regulatory change. Although the two culverts do allow some flow to enter and drain from the marsh, they also cause problems such as local flooding and scour of the marsh banks. When insufficient flow passes through the culverts, the water levels at the inlet can rise up to and over the roadway prematurely, before the rest of the marsh is flooded to the same degree. Also, high velocity flows at the outlet and the back-up of water at the inlet cause erosion and scour along the channel banks, degrading the natural marsh environment.

This Background chapter will provide a literature review discussing coastal development, estuarine processes, man-made flow restrictions and hydraulics, and the overarching legislature that limits the alteration of wetlands like the one in question. Extensive background research was involved in the development of the project methodology and the final design, due to the dynamic and non-ideal characteristics of the study site and the complexity of estuarine systems in general. The key topics are addressed here, as well as a more detailed history of the marsh itself.

2.1 Formation of a Salt Marsh

A salt marsh is a type of estuary located in coastal intertidal zones that are remnants of the glacial carving that occurred during the Ice Age, about 20,000 years ago. The English Salt Marsh in Marshfield, Massachusetts was most likely formed by the Laurentide Glacier, which covered most of Canada and the upper continental United States, as shown in Figure 4. Massachusetts was located relatively close to the edge of this glacier (Teal & Teal, 1983).



Figure 4: Ice Age glaciers in North America (Emergence of People in North America, 2002)

2.1.1 Carving and Melting

As the Laurentide Glacier slowly drifted over North America, it scoured the land beneath it, pulverizing stones and bulldozing earth. The deep trenches cut by the glacier eventually became the lakes and hills that currently exist there. While moving, the glacier collected dust and debris on its surface. Over time this became a thick layer of soil and some plants managed to live in the temporary terrain that had formed.

Eventually the glacier stopped its advance and began melting. The meltwater carved streamlets in the glacier that began collapsing the temporary terrain. The meltwater also carried rock flour from the pulverized boulders and some plant seeds that had grown atop the glacier. This created a very fertile soil, which then was transported to the shore. The melting glacier also caused the sea level to rise, engulfing the fertile soil in sea water (Teal & Teal, 1983).

2.1.2 A New Marsh is Formed

When the Laurentide Glacier receded, a flooded river valley appeared by the Northeast coast of what is now the United States, specifically the New England area. This valley became cut off from its freshwater source by glacial debris and became connected to the ocean due to sea level

rise. The new formation attracted migrating sea birds, which carried with them the seeds from the southern marshes. Soon intertidal plants began growing, particularly the *Spartina* species of sea grasses. The tidal currents caused mud and soil to become trapped in the root structures of the *Spartinas* while some soil remained loose and continued to wash out to sea. This action eventually formed grassy peat banks from the mud-packed *Spartina* with canals of flowing water running between them (Teal & Teal, 1983). Marsh environments with their peat banks and mixture of saline and freshwater inputs make them host to a unique ecosystem of intertidal plant and animal species.

The New England salt marshes of the present day exist in sheltered coastal areas in which fine sediments can settle and accumulate without exposure to extreme wind or waves. These conditions also allow plants to take root securely. A typical salt marsh is composed of three major sections: the low marsh, high marsh, and marsh border. The low marsh is exposed during low tide but flooded during every high tide. The high marsh is flooded only during higher-than-average tides, creating pools of standing water (Carlisle, Donovan, Hicks, Kookan, Smith, & Wilbur, 2002). The soil is mostly saturated. The marsh border floods only at extreme astronomical tides, when the sun, moon and Earth’s are aligned so their gravitational forces reinforce each other, or during major storms (US Army Corps of Engineers, 1991). Figure 5 shows the typical vegetation in each part of a salt marsh.

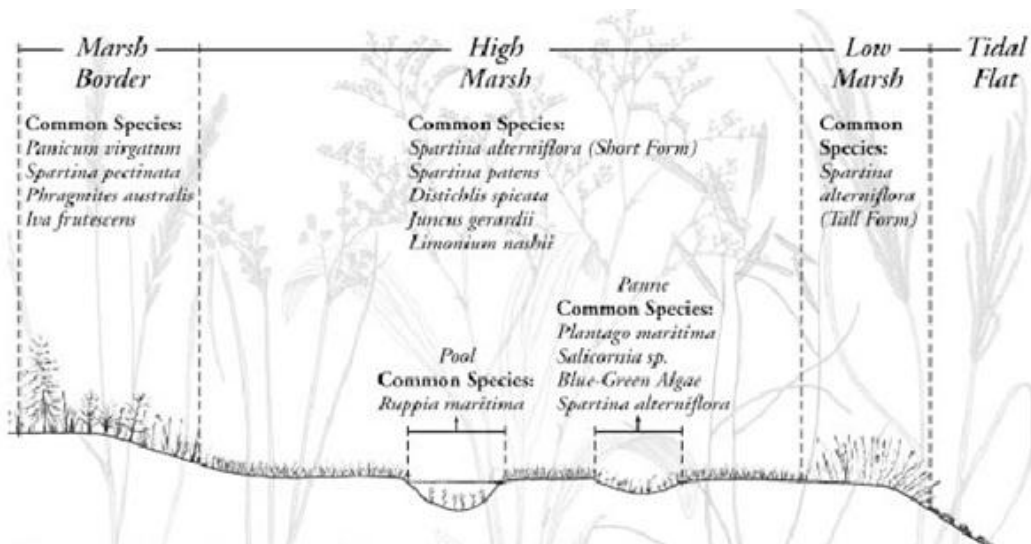

Figure 5: Marsh Zones by Vegetation (Carlisle, Donovan, Hicks, Kookan, Smith, & Wilbur, 2002)

2.2 Tides

The conditions in an estuary such as the English Salt Marsh vary greatly in the short-term due to the influence of ocean tides. The basic tide is defined as “the cyclic rise and fall of the water surface as the result of tide-generating forces” (US Army Corps of Engineers, 1991). The tide-generating forces that result in tidal variation are the gravitational forces of the moon, sun, and

Earth. This rise and fall of the seawater surface results in an influx of seawater into an estuary followed by a period of draining during which water flows out toward the coast. The English Salt Marsh receives tidal flow from the Atlantic Ocean. East coast waters, including this estuary, exhibit a basic semidiurnal (twice per day) tidal cycle, each lasting 12.42 hours. Each tidal cycle includes a high tide at peak water level, and a low tide at minimum water level. The period during which water level rises is known as flood current. Ebb current occurs as the water level recedes after high tide.

The point at which there is no net flow in either direction is the null point, signifying the end of a period of flood or ebb current. A null point exists at each high tide and low tide, the time at which the flow is momentarily still before changing direction.

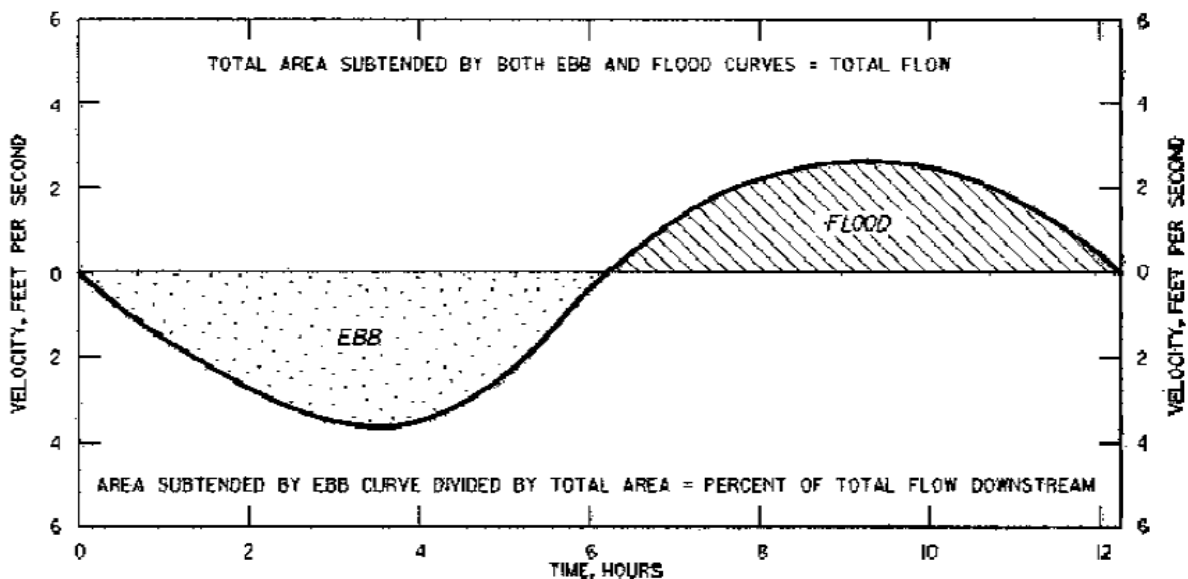

Figure 6: Velocity over a Tidal Cycle and Null Points (US Army Corps of Engineers, 1991)

Figure 6 shows the velocity of tidal flow over time, letting flood current be considered positive and ebb current negative. Null points are shown when the velocity line crosses zero. Also, the area under the curve is the total flow, or the tidal prism. The tidal prism of an estuary is the volume of water that flows into or out of the estuary during a flood current or ebb current, between null points. For the English Salt Marsh and other shallow coastal bodies, the tidal prism varies daily based on the tidal range between high and low tide levels. Although tides are a cyclic and repetitive occurrence, the water levels and the times at which they occur vary. Since the moon, sun, and Earth are not in identical orbits and rotations, the tide-generating forces they create are not consistent over time.

The tides are created by gravitational forces from both the sun and moon on the Earth. Based on Newton's law of universal gravitation (Equation 1), the magnitude of gravitational force between

two bodies is proportional to the product of their masses, and inversely proportional to the square of the distance between them.

Equation 1

$$F = G * \frac{m_1 * m_2}{r^2}$$

Where:

G = gravitational constant

m = mass of object

r = distance between centers of mass

Even though the sun is more massive than the moon, its far greater distance from the Earth results in a smaller gravitational force. Therefore, the moon has more of an effect on the fluctuation of the Earth's ocean tides. The sun's affect is apparent in the difference between daytime and nighttime high tide levels, while the orbit of the moon ultimately dictates the daily tidal ranges.

The moon revolves around the Earth once each lunar month, or 29.5 days. This makes a moon-based day, or tidal day, 24 hours and 50 minutes. Therefore each (solar) day, the tides are 50 minutes later than in the previous day. Twice a month (every 14.3 days) the moon, sun, and Earth align resulting in higher-than-normal tides, or spring tides. Alternatively, neap tides are the lower-than-normal tides that occur twice a month when the moon and sun are at right angles to the Earth. Spring tides occur at full moon and new moon phases, while neap tides occur at quarter moon phases.

In creating a design, the best approach is generally to consider extreme tidal conditions instead of average conditions. If culverts are designed to accommodate spring tides, neap tide conditions will also be handled appropriately, since they are calmer by definition. If neap tide conditions are used as the design parameters, spring tides would likely exceed the capacity of the design. Other conditions to consider are storm tides and surge tides, as well as sea-level rise which will be discussed in later sections of this report in Section 2.4.

2.3 Longshore Drift and Coastal Changes

As mentioned previously, coastal zones are vulnerable to both erosion and flooding, and special care must be taken in developing these areas. Forces applied along the coast by wave action can cause significant erosion and contribute to the consistent movement of coastal sediment and land. The longshore sediment system is the predominant driving force affecting coastal sediment transport, and the gain or loss of land at certain coastal locations (Marsh, 2010). Longshore currents run parallel to the coastline. As wave action erodes away coastal sediment, it is carried along by longshore currents and deposited at another location. This phenomenon is known as longshore drift, and is common in coastal areas. Certain parts of the coast may "lose" land to the

erosion from waves, while other parts “gain” land through the deposition of that sediment. Figure 7 shows the movement of sediment by longshore drift.

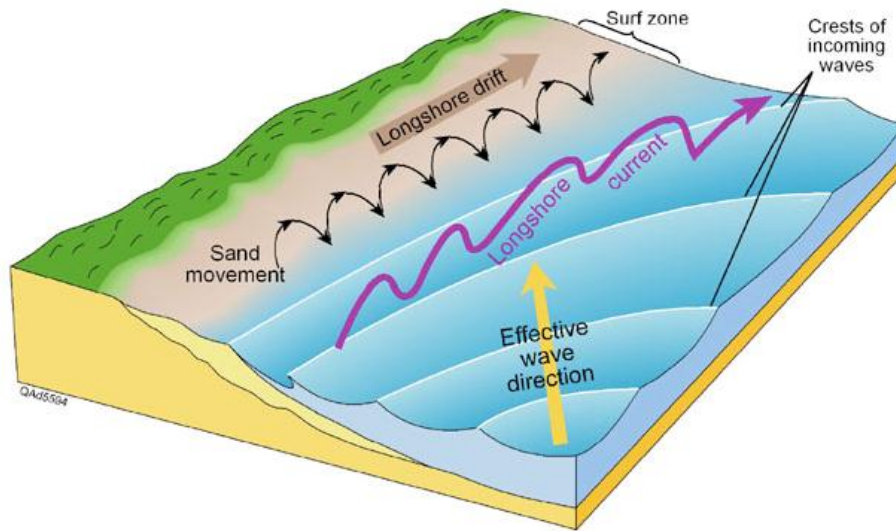

Figure 7: Longshore Drift Diagram (Zivkovic Geophysical Investigations, LLC, 2011)

A longshore drift system is apparent along Humarock, the coastal area adjacent to the English Salt Marsh. Figure 8 is a map created by the Massachusetts Office of Coastal Zone Management (CZM) that shows shoreline changes over time (Massachusetts Office of Coastal Zone Management, 2005). The yellow, orange, and red lines represent the loss or erosion of up to five (5) feet per year while the green and blue lines represent accretion of up to five feet per year of shoreline. According to the figure, the coastline on either side of the New Inlet has experienced significant change since 1952, including coastal loss along the outer banks nearest the ocean and deposition along the inner edge of the inlet by Trouant’s Island.

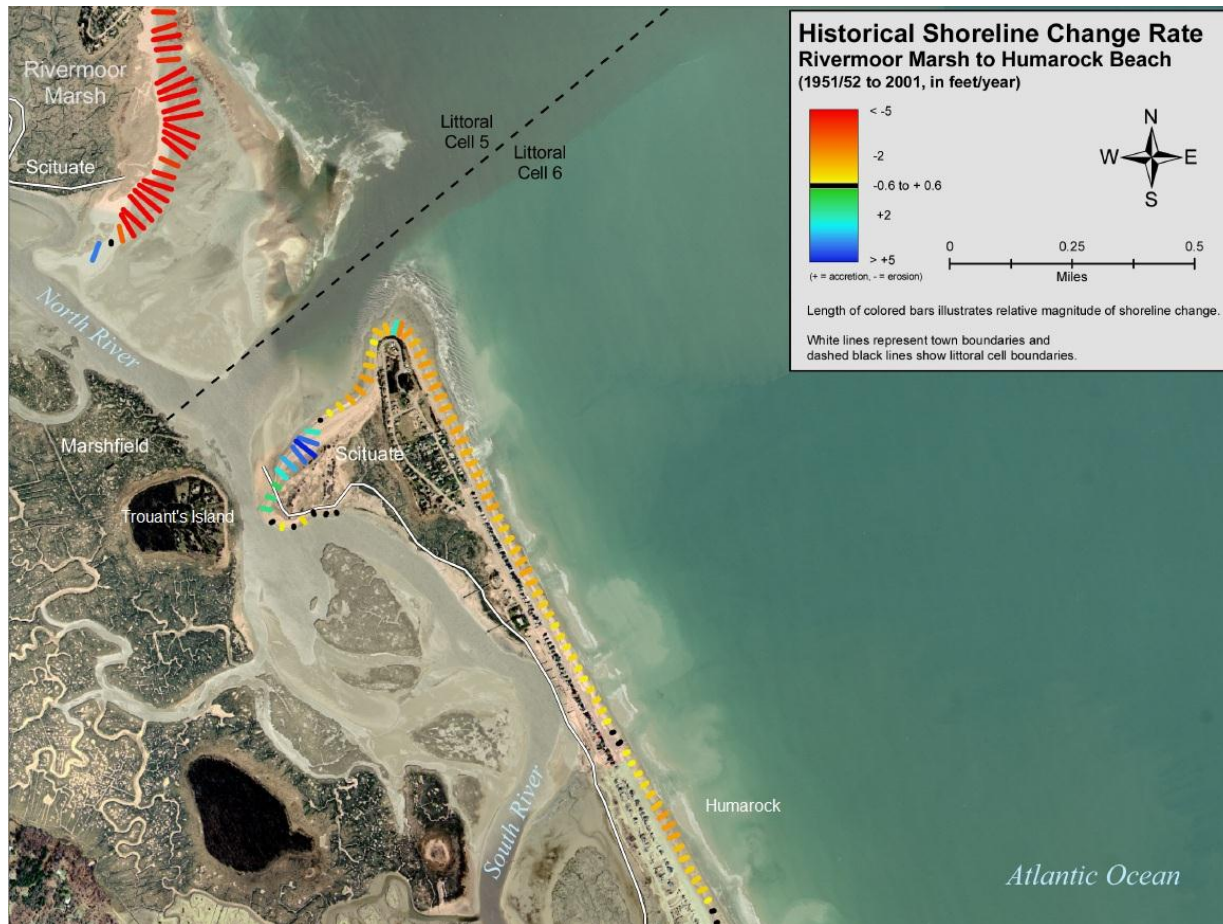

Figure 8: Shoreline Change from 1952 to 2001 (Massachusetts Office of Coastal Zone Management, 2005)

Based on the loss of land along Humarock coastline (denoted by the yellow and orange lines) and a gain nearer New Inlet (blue and green lines), it can be assumed that a longshore current exists there. Sediment is eroded from the coast, transported northerly by the current, and deposited on the inner banks of New Inlet. This deposition of land restricts the flow through the inlet toward the South River, causing increased volumes to re-route around the other side of Trouant’s Island and toward Macomber’s Way. There is also significant erosion on the northern banks of New Inlet (denoted by red lines) with coastal loss up to five feet per year. There is a sizable sand bar visible on this side of the inlet, likely due to the deposition of that sediment. Such large sediment depositions can alter and redirect the flow during tidal exchange through the inlet.

2.4 Sea-Level Rise in Estuaries

Erosion and deposition do not only occur along the shoreline in direct contact with wave action; there are significant sedimentary processes within estuaries as well. The geomorphology of an estuary or salt marsh involves the cyclical movement of coastal sediment through accretion and submersion. Sediment is moved up into the visible portion of the land through accretion, and back underwater through submersion, repeatedly. Coastal morphology evolves in response to

applied energy, such as tidal forces. The natural movement of an estuary is three-dimensional; it builds vertically through accretion to keep pace with sea-level rise, and transgresses in a generally landward direction (Bruun, 1988). Without human or other outside interference, an estuary maintains itself at an energy equilibrium, a state in which the vertical and landward movements are in balance with the applied energy and rate of sea-level rise. In the case that marsh accretion cannot keep pace with sea-level rise, the equilibrium will shift. This shift may involve changes in the frequency of marsh flooding and the land area affected, flow regime, salinity levels, soil saturation, and vegetation growth.

Evidence of relative sea-level rise exists in coastal areas around the world. The phrase “apparent sea-level rise” refers to the “rise in the ocean surface when compared to a stable landmark” (US Army Corps of Engineers, 1991) as the result of the ocean water itself rising, the coastal land sinking, or a combination of both. Sea-level rise is a natural phenomenon caused by tectonic plate activity and the behavior of coastal sediment as it is eroded over time, but rapid climate change does expedite the process. The global warming effect of increased greenhouse gases in the atmosphere increases the volume of existing seawater through thermal expansion, and by introducing additional flow into the seas as snow and ice melts at accelerated rates (Pethick, 2001).

Sea-level rise can result in the transgression of an estuary, or the movement of the body landwards. When sea-level rises relative to the land, the shoreline moves toward higher ground, resulting in flooding of the outermost land. The Bruun Rule of erosion relates the erosion and translational movement of a coastal zone to sea-level rise. Figure 9 is a basic diagram of the Bruun Rule as it is applied to a coastal zone. When the estuary receives deeper water and increased wave action from the open sea, eroded sediment is moved landward toward the inner estuary, resulting in a “roll-over” transgression of the water body (Bruun, 1988).

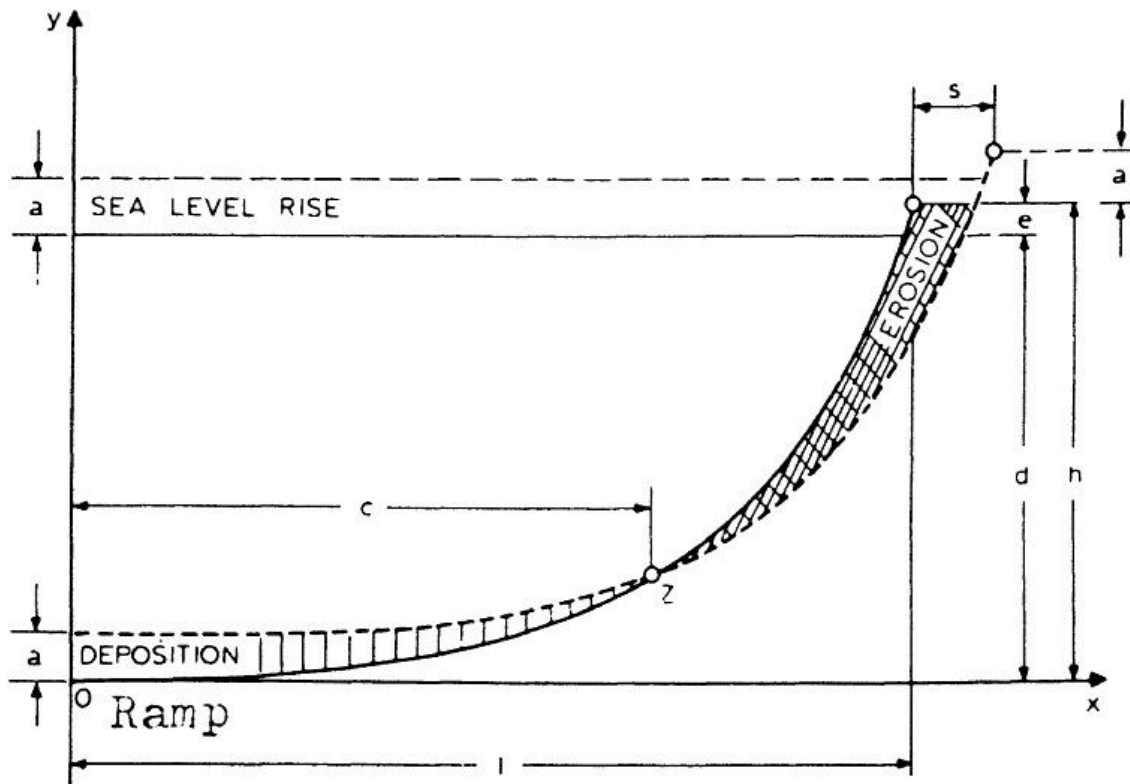

Figure 9: Diagram of the Bruun Rule showing translation of the beach with sea-level rise

As water depth increases, larger waves propagate from the open sea and erode sediment from the outer estuary. Sediment is then deposited on the inner estuary, raising the salt marsh surface. As the outer zone continues to be eroded away and is lost from sight underwater, the area of the inner estuary increases with the sediment deposits. According to a regime model developed by Bruun, as sea-level in a given cross-section increases, the increased bed shear stress widens the channel, thus slowing the water velocity and then decreasing the shear stress and erosion rates. This effectively widens the estuary mouth and translates the wetland landward. If viewed from a static outlook (with a stationary control volume), this process is seen as the loss of coastal land as it becomes submerged underwater permanently. But, if a dynamic viewpoint is taken, the estuary system maintains its form and simply shifts inland; the same estuary exists after shifting to a new placement. If this transgression is impeded by man-made physical barriers such as flood embankments or other structures, “coastal squeeze” occurs and loss of the ecosystem may result (Pethick, 2001). Alternatively, if the transgression of an estuary was not impeded and was allowed in a populated coastal area, it would require the sacrificing of coastal properties and roadways as they became flooded. Considering the high real estate value of ocean-view properties, this outcome seems much less likely than the occurrence of coastal squeeze.

2.5 Salt Marsh Ecology and Economy

Salt marshes play a critical role in the protection and support of fisheries and marine habitats. Marsh soil tends to have a high organic content. As sediment is transported by tidal flows within the marsh, the rich soil is carried throughout the estuary, which supports the local ecosystem and contributes to the local food web. Salt marshes are also home to a wide range of plants, typically reed grasses of the genus *Spartina* and *Phragmites*. These certain plants thrive in highly saline areas and can even remove pollutants from the soil, including some heavy metals. The roots and rhizomes of the marsh vegetation are very densely packed and bind the loose marsh soil together to form the sturdy marsh banks. This thick peat within the marsh is critical in keeping the fresh and saline water separated within the groundwater (Department of Environmental Protection, 2009).

2.5.1 Regulations on Marsh Development

Salt marshes are highly protected areas, and their development or alteration is very limited if not prohibited. The Wetlands Protection Act (WPA) from Chapter 131 subsection 40 of the Massachusetts General Laws (MGL) outlines the strict regulations surrounding development within a salt marsh setting. The WPA states that:

“No person shall remove, fill, dredge or alter any bank, riverfront area, fresh water wetland, coastal wetland, beach, dune, flat, marsh, meadow or swamp bordering on the ocean or on any estuary, creek, river, stream, pond, or lake, or any land under said waters or any land subject to tidal action, coastal storm flowage, or flooding, other than in the course of maintaining, repairing or replacing, but not substantially changing or enlarging, an existing and lawfully located structure or facility used in the service of the public and used to provide electric, gas, water, telephone, telegraph and other telecommunication services, without filing written notice of his intention to so remove, fill, dredge or alter, including such plans as may be necessary to describe such proposed activity and its effect on the environment and without receiving and complying with an order of conditions and provided all appeal periods have elapsed (Wetlands Protection Act, 1997).”

The WPA states that any development is prohibited within a marsh if it would negatively affect the growth, composition, and distribution of salt marsh vegetation; the tidal flow and water elevations; or the presence and depth of peat. Also the issuing authority, usually the local conservation commission, presumes that every area of the marsh is critical to the above three criteria. However the developer may sway this decision by providing appropriate evidence that the area in question does not significantly contribute to these criteria and that development of the area would not interrupt these processes (Department of Environmental Protection, 2009).

Any developer planning to work in a marsh setting must first propose their plan by submitting a written notice to the local conservation commission or issuing authority, in this case the Town of Marshfield Conservation Commission. The notice is then given to Department of Environmental

Protection (DEP) to be reviewed. Within 21 days of receiving the notice, the local conservation commission or issuing authority will hold a public hearing to determine whether the area in question is significant to the natural processes of the marsh (Wetlands Protection Act, 1997).

The Massachusetts Office of Coastal Zone Management's Policy Guide also outlines wetland regulations in regard to developing within a wetland zone. This guide emphasizes the need to protect salt marshes in order to preserve the unique habitat and the wildlife that thrives there. The Coastal Hazard Policy #2 states:

"Ensure that construction in water bodies and contiguous land areas will minimize interference with water circulation and sediment transport. Flood or erosion control projects must demonstrate no significant adverse effects on the project site or adjacent or downcoast areas" (Massachusetts Office of Coastal Zone Management, 2011)

While a slightly more concise than the Wetlands Protection Act, the Coastal Zone Management Policy Guide intends to protect Massachusetts's wetlands and preserve them as a resource.

2.6 Marsh Studies

Since estuaries are such valuable and dynamic ecosystems, they can also be interesting study sites for research projects, which often involve sampling or other field monitoring activities. The collection and analysis of field monitoring data can provide invaluable information during a wetland assessment, but data can be worthless without a clearly defined purpose. Therefore the first major step in performing a wetland assessment (or any monitoring event) is the planning phase, during which the management concerns and objectives must be identified (Springate-Baginski, Allen, & Darwall, 2009). This preparation phase also includes conducting extensive background research and literature review as well as contacting any related government entities or local groups. Once the monitoring plan has been designed, the second phase is to conduct the field assessment. Finally, analysis of data, presentation of results, and policy engagement with local stakeholders are necessary to complete the process (Springate-Baginski, Allen, & Darwall, 2009).

Depending on the overall goal of the monitoring event, different parameters are appropriate or necessary to monitor. The Massachusetts Office of Coastal Zone Management (CZM) is a part of the Executive Office of Energy and Environmental Affairs organized to "balance the impacts of human activity with the protection of coastal and marine resources" (Massachusetts Office of Coastal Zone Management, 2011). CZM lists tidal hydrology, salinity, plants, invertebrates, fish, and birds as options for field monitoring of a salt marsh ecosystem (Carlisle, Donovan, Hicks, Kookan, Smith, & Wilbur, 2002). Although monitoring tidal hydrology over a tidal cycle is time-consuming, tidal restrictions are easily observed and documented. However, numerical data does require more precise methods but is still a relatively low-effort task with the use of proper equipment.

Marsh studies can involve comparative strategies including a before-after or reference site-study-site comparison, which compare the state of the site before and after a stressor is added or removed, or compare the site with a stressor to a similar site without that stressor (Carlisle, Donovan, Hicks, Kooken, Smith, & Wilbur, 2002). These comparisons are useful to validate data and to show the importance or applicability of an issue by isolating its effects in the marsh. Common study areas include salt marshes with tidal restrictions, regional reference sites, and salt marshes affected by pollution or land use. Once the purpose and the parameters are decided upon, an evaluation area must be chosen. The size and location of the area must be considered in order to achieve a representative sample, without exceeding reasonable expectations for the physical limitations of a group of a certain size. A salt marsh can span hundreds of acres, much too expansive to sample in a day without a large crew. Other interferences may arise during sampling, including groundwater seepage or improperly timed samples according to the tides. Many considerations must be made while sampling such a dynamic environment (Carlisle, Donovan, Hicks, Kooken, Smith, & Wilbur, 2002).

The Army Corps of Engineers' *Tidal Hydraulics Engineer Manual* defines six basic parameters of field data for a hydrodynamic analysis. These parameters are: tide heights, currents, suspended solids, salinity, bed stresses, and elevation (US Army Corps of Engineers, 1991). Generally, these parameters require more expertise and equipment than the previously mentioned parameters for an ecological study. These hydrodynamic parameters are more relatable to flooding concerns, which means they would relate to this project. Tide heights and currents are field parameters that can be observed easily, but measuring these with accuracy can pose a challenge. Another area of concern for a hydrodynamic survey is the length of time it should take. Long-term surveys can span anywhere from months to years long, and more often result in useful information since most erosion processes or estuary changes occur relatively slowly over time. However, short-term surveys can also produce usable data and are in most cases easier to complete. Short term, or intensive, surveys should last 13 or 25 hours, which would cover the entirety of either one or two semidiurnal tidal cycles (US Army Corps of Engineers, 1991). The specific applications of these field monitoring strategies are discussed in detail in the Methodology chapter of the report.

2.7 Marshfield History

The general formation of New England salt marshes has been discussed already, but this section will present a more specific background on the study site including the historical uses of the marsh and the problems with it today. The known history of the site begins in 1632, when Marshfield was established by Governor Edward Winslow as one of the first pilgrim towns in colonial Massachusetts. What is now a highly developed beach town was initially used as a place to herd the cattle that were needed to support the Plymouth Plantation.

2.7.1 The Salt Marsh Resource

The English Salt Marsh provided wide-open spaces and abundance of nutritious marsh grass, making it an ideal location for local farmers to herd their cattle. In fact, the salt grass became the primary diet for the cows, which led to a small industry that supplied farmers in other areas with hay. Canals were dug into the banks of the marsh so workers could use boats to traverse the marsh and collect the salt grass. In addition to feeding livestock, the salt grass served as a fertilizer for crops at local farms. Layering the grass atop the soil imparts nutrients to the underlying seeds.

The marsh was surrounded by the North River and the South River, which connected with the ocean via an inlet by Rexhame Beach. The rivers were a mix of fresh and salt water, which allowed for diverse marine life to thrive. Local fishermen began using the marshes, canals, and the rivers to feed the growing fishing industry in Marshfield. Herring, perch, and eels were the primary fish that were caught and sold. There was also an abundance of mussel beds and clam beds, which were harvested and sold.

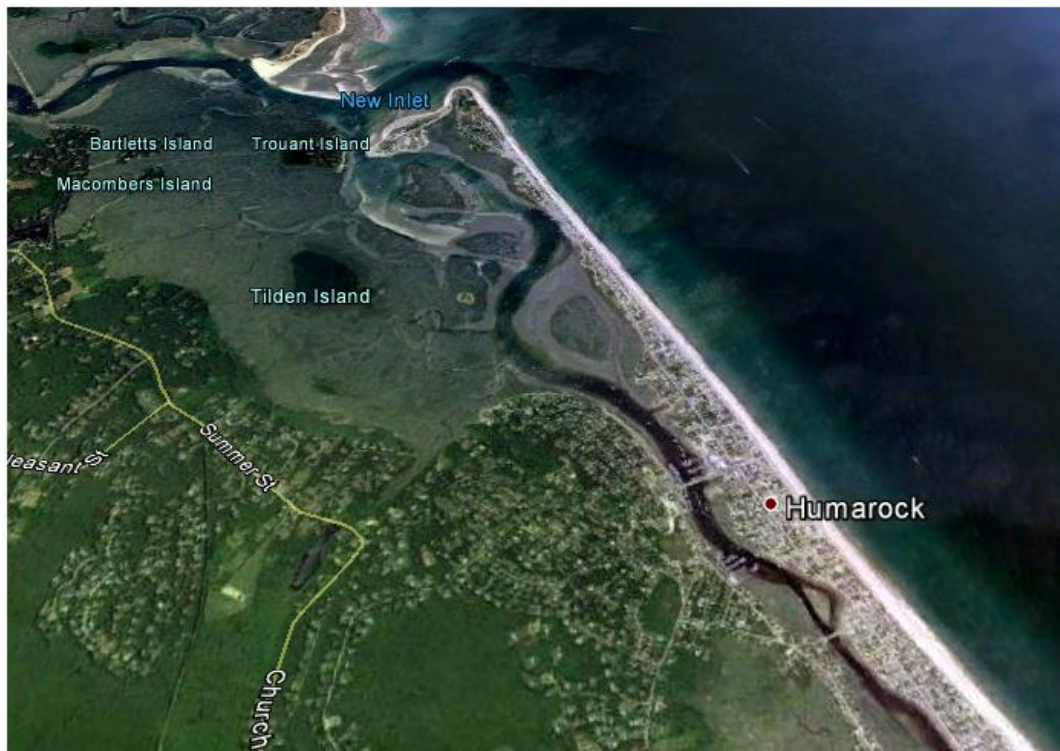

Figure 10: The New Inlet and Trouant's Island, relative to the old inlet further south

2.7.2 The New Inlet

Historically, the North and South Rivers met with the Atlantic Ocean at Rexhame Beach, but in 1898 a powerful storm broke through a sand bar at the coast and created the New Inlet (see Figure 10). The former inlet has since filled in with sediment as land mass, and the New Inlet has remained the primary source of ocean contact for the North and South Rivers for over 100 years,

since the storm. This shifting inlet caused a massive change in the marsh, as the source of tidal flow was now further north. The New Inlet was also much wider than the previous inlet, which caused a larger volume of water to enter the marsh resulting in daily floods during peak tide. This flooding still continues today (Richards, 1901).

2.7.3 Residential Development

In more recent years, The English Salt Marsh has become somewhat developed residentially. The marsh contains many small “islands” within it, three of which are now residential: Trouant’s Island, Macomber’s Ridge, and Bartlett’s Island. Trouant’s Island is the largest island in the marsh. It is accessible via Macomber’s Way, the man-made causeway equipped with culverts that stretches 1840 feet across the salt marsh, and is the focus of this project. Along Macomber’s Way is another residential island, Macomber’s Ridge. Bartlett’s Isle is the most developed island and closest to the shore. It is accessible via a paved roadway that has one large culvert, which allows the tide to ebb and flow unrestricted. Macomber’s Way is much longer than the causeway to Bartlett’s Isle resulting in a greater tidal obstruction.

2.7.4 Causeway Development

On March 7, 1803, a grant of easement in the deed of George Little to Church C. Trouant was recorded which mentioned “a way to the above mentioned island, and is aboute (sic) thirty-eight rods in length and one and one-half rods in width (Book 95, 1803). This is the first known citation of the construction of the causeway. Trouant’s Island, like the rest of the marsh, was used for livestock farming from Marshfield’s founding into the 1800’s. In the early 1900’s, Dr. Emery bought the island as a place for his extended family to vacation. Eventually, activity on the island decreased, and so did the level of upkeep and maintenance of the roadway. This is considered the time at which the low points along the road’s surface began to develop. In the years since, the ownership and responsibility for the maintenance of the road has come under much debate. The road now operates under the DEP’s Superseding Order of Conditions SE 42-516 (Appendix 7.2). An Order of Conditions is a list of regulations that have been applied to the site usually from the DEP or another issuing authority. This order of conditions places constraints on the design of the road, preventing the road from exceeding the height of the marsh banks. This is important in maintaining healthy flow patterns and preventing violent erosion of the road. The road is currently at an allowable height, as per the DEP regulation. The allowable height is low enough so water can flow over the roadway to the other side, which limits the restriction of tidal flow but also creates a less safe driving environment for residents of the island.

The installation of three culverts in the causeway was authorized in 1978 and construction was completed the next year. In 1999, the middle culvert, formerly a 24-inch metal pipe, was removed and replaced with the current 36-inch plastic culvert. The third culvert, which was located closest to Trouant’s Island, was found to be crushed and was therefore removed that same year after authorization from the DEP. The third culvert was never replaced.

2.8 Site Description

As previously mentioned, the English Salt Marsh acts as the transitional zone between the North and South Rivers and the Atlantic Ocean. This tidal salt marsh experiences flooding during high tide, but a network of canal systems is exposed during low tide. Macomber's Way allows access across the marsh to Trouant's Island from Damon's Point Road but is impassable during high tide, when the incoming seawater spills over the causeway. Seawater flows into the estuary through New Inlet, which was established in 1898 during a powerful storm that broke open the existing sandbar (see Section 2.7.2). As the flood tide passes through New Inlet, it flows bi-directionally: either south around Trouant's Island toward the South River, or north around Trouant's Island toward the North River and Macomber's Way. Due to sediment deposition on the southern side of New Inlet (as described in Section 2.3), flow is restricted and more is forced up toward the North, creating a greater load flowing over the north side of Macomber's Way during flood tide. The red lines in Figure 11 show the two directions of the tidal flow through New Inlet.

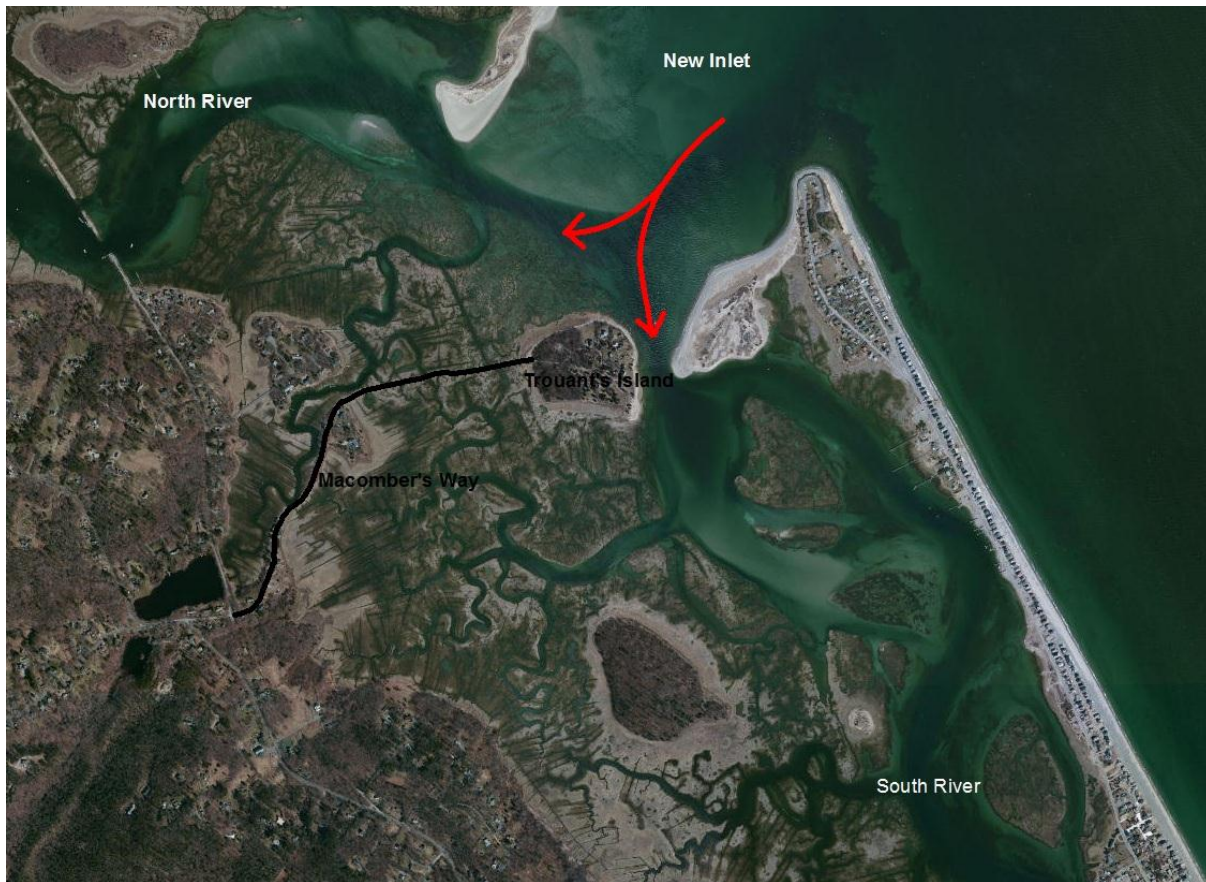

Figure 11: Tidal Flows through New Inlet

Some of the flow that takes the northern route around Trouant's Island continues to flow toward Macomber's Way and through the two culverts in the roadway. The culverts eventually receive flow greater than their capacity, creating uneven water levels with a back-up of water behind the

inlet and high velocity flows at the outlet. The flow obstruction by the road and the velocity alterations by the culverts cause scour and loss of marsh banks and vegetation in the surrounding areas. The locations of Culvert 1 and Culvert 2 are shown in Figure 12, as well as the former location of Culvert 3, before it collapsed and was removed.



Figure 12: Location of Culverts in Macomber's Way

More flow passes through Culvert 2 than Culvert 1, mostly based on their locations in the road. Tidal flows enter the estuary from the North-East direction (through New Inlet and around Trouant's Island). Water flows across the marsh in the North to South direction, first filling in the more Eastern sections of the roadway toward Trouant's Island (near former Culvert 3 location). The first signs of flooding over the roadway as high tide approaches are seen on the section of road nearest Trouant's Island. Later, the roadway near Culvert 2 floods, sometimes followed by Culvert 1, depending on the tide heights. Culvert 2 is also larger than Culvert 1, so it would channel more flow based on size alone, even without considering the actual conditions as tidal flow approaches the roadway along its entire length. Some basic characteristics of Culvert 1 and Culvert 2 are presented in Table 1.

Table 1: Culvert Characteristics

Culvert	1	2
Material	Corrugated metal	Corrugated plastic
Diameter	2 feet	3 feet
Length	28 feet	28 feet

Both culverts are circular pipes that protrude from the edge of the causeway by 1-2 feet on each side. Both culverts have major channels on either side that act as inputs or outputs, depending on the tide conditions. Further background on the use of culverts and the hydraulic analysis used with them is presented in Section 2.9.

2.9 Culverts

Culverts are an example of human-made devices that can alter flow and can disrupt natural patterns if not designed properly, as is the case at Macomber's Way. A culvert is a tool used to channel water, often implemented when a roadway or bridge is built over a water body, so that water can still flow underneath the structure. The culverts in Macomber's Way allow the Northern and Southern halves of the marsh to equalize its water levels over a tidal cycle, as flow passes from higher to lower elevations across the marsh. According to the Town of Marshfield Conservation Commission, these culverts do not function properly, preventing the marsh from equalizing fast enough, and thus resulting in increased flooding over the causeway (Wennemer, 2011).

2.9.1 Problems with Culverts

Culverts can be very effective tools for channeling water underneath roadways, but many issues can arise without the proper design. Local scour is a term used to describe the erosion that is caused at the outlet of a culvert when the flow velocity is too great. High velocity is caused by small cross-sectional area, since volumetric flow is the product of fluid velocity times the cross-sectional area. When water exits a culvert at high velocity, it easily washes the soft soils away from the area around the outlet, creating enormous scour holes. These scour holes destroy the grassy and muddy banks of the marsh and further augment the negative impact that man-made development can have on the marsh. Such marsh scour has been observed along Macomber's Way at the sites of both culverts (Wennemer, 2011).

2.9.2 Culvert Hydraulics: Classifying Flow Types

Culvert hydraulics can be very complicated and classifying culvert flows can be very challenging. The United States Geological Survey (USGS) classifies culvert flow by six (6) major flow types. The classification of these flow types (Type 1 through 6) is dependent on the headwater and tailwater depths, which are the water elevations at the culvert outlet and inlet, respectively. The flow regime, such as tranquil or turbulent flow, also affects the flow type (Bodhaine, 1988).

A crucial concept in hydraulics is the critical depth of flow. Critical depth is the depth of water at which energy is a minimum. Subcritical flow occurs when the flow depth is greater than the critical depth, meaning the velocity is less than the critical velocity. Subcritical flow is a slow flow that is affected by conditions downstream. Supercritical flow occurs at a flow depth less than the critical depth, and is considered a fast flow that is impacted by upstream conditions. Supercritical velocity is greater than the critical velocity. Changes within the culvert surface can

cause hydraulic jumps, areas where flow changes from supercritical to subcritical, or vice versa (Bodhaine, 1988).

Type 1, Type 2, and Type 3 flow occur when the culvert is not fully submerged (see Figure 13). An unsubmerged culvert that experiences critical depth at the inlet is classified as Type 1 flow. Type 2 flow is characterized by critical depth at the outlet. The culvert is fully open to the air in Type 1 and 2 flows, which is known as open channel flow. Type 3 flow typically occurs when the culvert inlet is near submerged and the outlet is not, meaning that the headwater depth is greater than the tailwater depth. As shown in Figure 13, there is a head loss at the entrance during Type 3 flow. This means there is a drop in the water surface elevation between the headwater level and the depth in the culvert itself. In fact, the diagram shows this entrance loss in Type 1 and Type 2 flows as well.

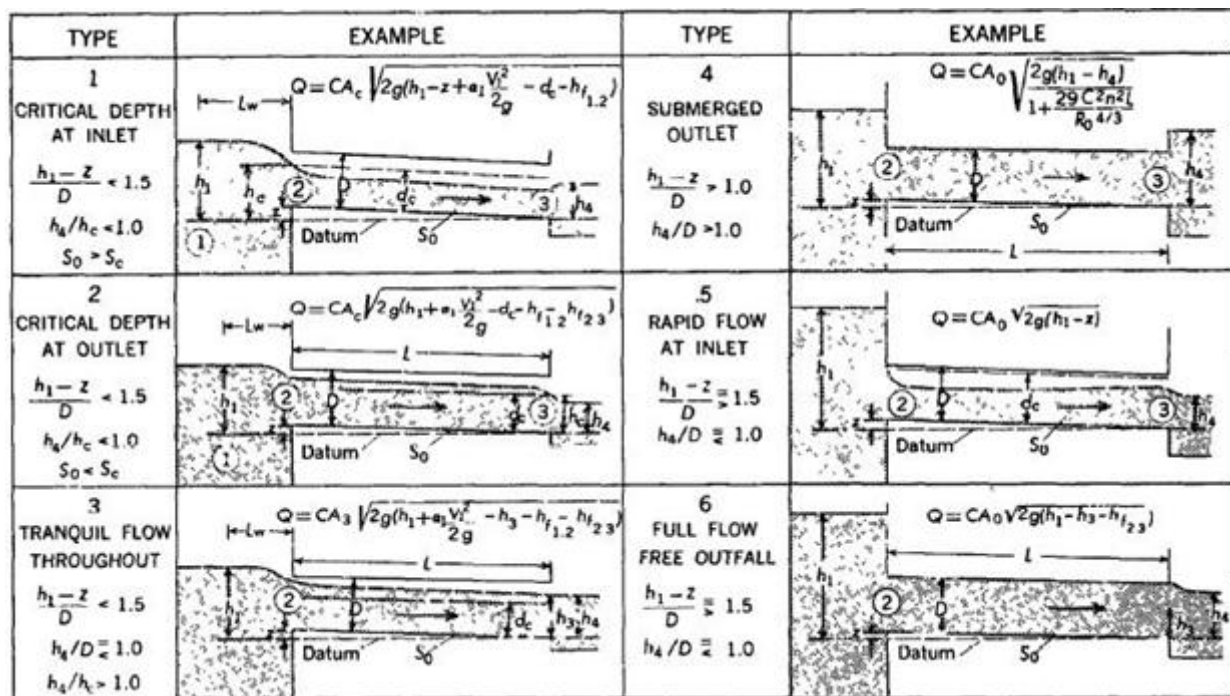

Figure 13: Classification of culvert flow (Bodhaine, 1988)

Type 4 flow occurs when the culvert is submerged by both headwater and tailwater. During this flow type, the culvert acts as a pressurized pipe connecting two reservoirs. Type 5 and Type 6 flows are both characterized by a high head condition, meaning the headwater is very high and exerts high pressure on the flow through the culvert. Both involve a free outfall at the outlet, and no tailwater depth that builds up over the culvert. During Type 5 flow, the inlet is fully submerged with high head but the outlet is not submerged. The water level decreases as the flow moves through the culvert, which leaves the outlet open to the air. Type 6 flow occurs when there is a high headwater and both the inlet and outlet are submerged. There is no back-up of flow at the outlet though, so a tailwater depth does not occur. The pipe flows full from the inlet to the outlet, then exits the pipe as a free outfall similarly to Type 5 flow (Bodhaine, 1988).

In all culvert flow types and in fluid flow in general, the driving force is the hydraulic gradient. The hydraulic gradient is represented simply as the quantity $(\frac{\Delta h}{L})$, or the change in water elevation over the length of the channel or pipe. This is also known as the hydraulic grade line during culvert flow, and can be represented as the difference between the headwater and tailwater depths over the pipe length. In a setting where the flow of water is irregular, such as a marsh with flow that changes with the tides, all six of these flow types can occur, as well as non-uniform conditions that may be even more challenging to characterize. While this non-uniformity can complicate the act of modeling the culvert flow, it is still possible through assumptions and approximations (Bodhaine, 1988). To model the discharge for the culverts in Macomber's Way, several different flow types were used to represent the conditions during the different tidal stages. Significant assumptions were made in determining the flowrates, and are described in detail in the Methodology chapter.

3. Methodology

The methodology for this project involved five major phases. The phases were completed chronologically, each one a necessary step in designing a safer, less environmentally destructive culvert system for Macomber's Way. The project phases were:

1. Project scoping activities
2. Field monitoring events
3. Describe existing conditions
4. Conceptualize design options
5. Develop final design

3.1 Project Scoping Activities

This project began as a general investigation of flooding in and around the English Salt Marsh. In order to fit more appropriately within the WPI curriculum and ABET standards, the scope of the project was narrowed to focus on an alternative design for the existing culverts in Macomber's Way. The purpose of the project scoping phase was to develop a more specifically defined project goal, and to plan the remaining methodology necessary to achieve said goal. Tasks associated with the scoping phase included identifying and contacting local stakeholders, seeking relevant literature, and visiting the English Salt Marsh to identify specifics about the flooding problems. This phase began in August 2011 and was completed before the submission of the project proposal in October.

3.1.1 Contacting Local Stakeholders

Contact with local stakeholders was initiated and maintained by the project team with the purpose of acquiring background information on the site. The Town of Marshfield Conservation Commission provided the project team with a brief history of the formation of the marsh and the New Inlet, identified the bylaws pertaining to development of a marsh area, and recommended additional groups and individuals to contact for more information. Many of the emails and phone calls to various organizations were made with the intention of acquiring data from any previous monitoring events, especially pertaining to the depths of water in the marsh or flowrates of water entering the estuary. The North and South Rivers Watershed Association (NSRWA) had conducted several water sampling events along the North River, but unfortunately did not have data pertaining to depths or flowrates that could be used in this project. Additional government agencies were contacted during this phase such as the Federal Emergency Management Agency (FEMA) and the Massachusetts Office of Coastal Zone Management (CZM) in order to acquire flood management information and coastal development regulations.

Based on firsthand observations of the site and the recommendations of relevant stakeholders, the decision was made to focus the project on Macomber's Way. At first, it was unclear whose jurisdiction the causeway was under, but this confusion was resolved through contact with the Town of Marshfield Assessor, the Commonwealth of Massachusetts Division of Fisheries and

Wildlife (DFW), and the residents of Trouant's Island. The marsh is owned by the DFW, while ownership of Macomber's Ridge itself, and the responsibility for its maintenance, belong to the Island residents as an easement. In recent years, all construction and road maintenance has been conducted under the supervision of Jim Tarbox, owner of Tarbox Construction and resident of Trouant's Island. Mr. Tarbox showed interest in the project and served as a source of extensive background information on the history of the causeway as well as details of the design and construction of the existing culverts. His opinion as a resident was also useful since the implications of the causeway design would be felt most directly by the Trouant's Island residents.

3.1.2 Site Reconnaissance Visits

Although contact was made with several informative and helpful agencies and individuals, the most important part of the project scoping work was travelling to the site and observing it first-hand. These first few visits served as site reconnaissance. The project team observed and photographed the conditions of various parts of the marsh, with the goal in mind to identify specific target areas at which to address the general flooding issue on a smaller scale. The first site visit took place on September 4th, 2011 during low tide. During this field event, the project team was accompanied by Seaview Avenue resident Mr. Richard Dubois on an investigatory hike across the southern part of the English Salt Marsh near Pine Island and around the perimeter of Tilden Island. Vegetation growth patterns of potentially invasive species were noted, as well as the general moisture and "mucky" consistency of the soil.

Based on the recommendation of Jay Wennemer, the Town of Marshfield Conservation Commissioner, the second site visit on September 16th focused on observing Macomber's Way, specifically the marsh bank conditions near the culverts and the flooding that occurs on the road during high tide. The team witnessed the incoming tidal flows overcome the roadway (Figure 14), and evidence of erosion was apparent near the inlets and outlets of the culverts, and at other locations along the causeway. The causeway became submerged, creating dangerous driving conditions, which prompted the team to shift the project focus onto redesigning a safer, less environmentally destructive design for the culverts in Macomber's Way. Specifying the project scope enabled the project team to develop further methodology for monitoring events.



Figure 14: Flooding along the sides of Macomber’s Way (Photo source: Brendan Stitt, November 11, 2011)

3.2 Field Monitoring Events

Once the scope and goal of the project were specified, the team visited the site five times between November and December 2011 to collect field data for further analysis. The main purpose for the field investigations was to assess the flow dynamics along the causeway during different tidal conditions both qualitatively, and quantitatively. Quantitative data were recorded during each monitoring event using two water quality meters (a Hydrolab MS5 and an In-Situ, Inc. Level-Troll 500), surveying equipment, and a velocity meter. Data collection in the field focused on water depths in the channels on both the North and South sides of Culvert 2, and the flooding of that section of the road. Qualitative observations were recorded during each visit regarding erosion and flow characteristics along the entire causeway. All equipment used in the field and laboratory was provided by the WPI Department of Civil and Environmental Engineering.

3.2.1 Measuring tidal elevations

A large majority of the field data collected during monitoring events consisted of tidal elevations on the North and South sides of Macomber’s Way as well as on top of the road during high tide conditions. Tide charts were consulted before each site visit to determine the expected tidal range for the monitoring period and for later comparison of the expected and resulting tidal

depths. These tide predictions were viewed online through the United States Department of Commerce National Oceanic and Atmospheric Administration (NOAA) tides and currents webpage (National Oceanic and Atmospheric Administration, 2005). Depth readings were recorded using the Hydrolab and In-Situ Level-Troll (“the Troll”) depth meters as well as manually by the project team members. During each monitoring event, the two depth meters were deployed in the main channels on opposite sides of Culvert 2. The Hydrolab was placed eight to ten feet from the South edge of the culvert and the Troll was placed about ten to twenty feet out on the North side, as shown in Figure 15. Since the depth readings are based on pressure, the probes were not placed directly in front of the culvert inlet or outlet to avoid interference due to added pressure of water current on the probes. The sample locations were in the channels, where flow was calmer.



Figure 15: Sample Locations for Deployment of Depth Probes at Culvert 2

The Hydrolab MS5 is a multi-parameter water quality sonde with several probes that measure temperature, pH, dissolved oxygen, salinity, conductivity, turbidity, pressure, and depth. During this project, Hydras3 LT software was used to program the sonde to measure temperature,

salinity, pressure, and depth. The In-Situ Level-Troll 500 is a more specialized tool that only measures temperature, pressure and depth. The Troll was programmed using Win Situ 5 software. Before each monitoring event, both meters were pre-programmed using the aforementioned computer software to take periodic readings over a specified time span at a designated time interval. Monitoring events took place on November 11, November 15, November 26-27, November 30-December 1, and December 12-13, 2011. Depth data is available in the Appendix (Section 7.4). During the November 11th visit, the project team tested the planned methodology for programming and deploying the equipment and collected two hours of data during ebb conditions while the road was flooded. On November 15th, data was collected for seven hours, encompassing one half of a tidal cycle (one low tide and one high tide). During the last three monitoring events, the depth meters were deployed, left in position overnight, and retrieved the following day, after collecting depth readings every ten minutes for 27 to 33 hours. This procedure yielded more complete data sets, each spanning over two full tidal cycles. This enabled the comparison of daytime and nighttime conditions. However, there was one incomplete set of data; much of the South side depth data for November 26-27 was missing due to a programming error in the sample time settings. As a check for the depths recorded by the meters, the project team periodically measured depths during monitoring events with the use of a yardstick or leveling rod.

Elevation surveys were conducted on December 4th and 12th to provide relative elevations of points along the causeway as well as in the main channels. Although a known benchmark elevation was not used, the channel depths were reported against the road height, treating the middle of the road as a local benchmark by which to compare relative elevations in the channels. Since each channel bottom has a different elevation, using relative depths instead of the raw depth readings enabled more accurate comparison of the depths on the North and South sides of the causeway, and on top of the roadway, over time. Elevation surveys were conducted using a Pentax AL-M5C theodolite and leveling rod. On December 4th, the project team performed an elevation survey along the middle of the causeway, traversing the 1840 feet between Macomber's Ridge and Trouant's Island. The leveling rod was then brought into the two main channels at Culvert 2 to sight the elevations of each probe location. The elevation readings were then re-calculated using the middle of the road over Culvert 2 as a benchmark, resulting in depths of each channel at the sample locations. During field monitoring work on December 12th, a similar elevation survey was conducted to determine the probe elevations on that day, since the probes were not placed in the exact same location during each sampling event. The channels further down the road nearest Trouant's Island (at former Culvert 3 location) were also surveyed.

3.2.2 Velocity Measurements

Although the reported flowrate results were determined through calculation based on the depth data, velocity measurements were also taken in the field to serve as a basis for comparison. Readings were taken using a Gurley Water Current Meter (model number 625D) at the culvert inlet and outlet during varying flow conditions. The velocity meter consists of conical cups that

revolve around a vertical axis along with the water current (see Figure 16). The meter attaches to a wading rod with a stand on the bottom for stability. The height of the meter on the rod is adjustable to accommodate different water depths. To measure the velocity of the culvert flow, the height was adjusted appropriately and the rod was placed into the water, perpendicular to the direction of flow with the meter's stabilizing fin facing in the direction of flow. The speed of revolution as the moving parts spin with the flowing water is proportional to the velocity (Rantz, 1983). A cable connects the meter to a data logger where the velocity is displayed in feet per second.



Figure 16: Gurley Water Current Meter (Gurley Precision Instruments, 2004)

Velocity measurements at the culvert inlet and outlet were taken several times throughout the field monitoring phase. On November 15th, readings were taken when the depth in the culvert was 2 feet. According to the U.S. Geological Survey method, when a channel depth is 2.5 feet or less, a reading at 0.6 depth is used as the average velocity (Rantz, 1983). The 0.6 depth is defined as the depth 60% down into the water from the surface, or 40% of the depth up from the channel bottom. For example, for water depth in the culvert of 2 feet, the 0.6 depth is 1.2 feet from the surface. So, the current meter was set on the wading rod at 0.8 feet from the bottom. These readings were taken during flood current, so the North edge was acting as the inlet and the South edge as the outlet. On December 12th, more velocity measurements were taken when the culvert was about half full, two-thirds full, and 90% full. According to literature, maximum culvert discharge occurs when the flow reaches 93% of its maximum depth (Chow, 1959). The USGS method also recommends that at depths over 2.5 feet, the velocity should be reported as the average of the 0.2 depth and the 0.8 depth. So, for the 90% full culvert (2.7 feet), two readings were taken at 2.2 feet and 0.5 feet.

Velocity measurements were also taken on top of the road on December 12th during flood current conditions just before high tide, and ebb current conditions just after high tide. These measurements were to be used toward approximating the amount of flow that floods over the roadway, part of the tidal prism calculation. As mentioned in the Background, the tidal prism is

a measure the volume flowing into and out of an estuary during a tidal cycle. Flows in the New Inlet were not measured, so the overall tidal prism was not known, but these measurements enabled the team to determine the effective “tidal prism” passing over the roadway, using that portion of the marsh as the control volume. For these on-road velocity measurements, the current meter was placed just above the base of the wading rod in order to read the velocity of the shallow depths flowing over the road. These measurements were expected to result in an approximation of flow. Their purpose was to provide an estimation of the flows overtopping the road, to compare to the calculated flows through the culvert.

3.2.3 Examining Culvert and Channel Conditions

During each site visit, observations were recorded in a field notebook including descriptions of flow patterns and bank erosion, velocity or depth measurements taken on-site, and any other relevant qualitative notes regarding site conditions. During the team’s first field monitoring event on November 11th, the two culverts in the causeway were examined. During low tide when the culvert inlets and outlets were accessible, the two circular culverts were measured in length and diameter with measuring tape. The measurements agreed with those later given by Mr. Tarbox as part of the extensive background information he provided about the causeway construction. In addition to the size and material of each culvert, other pertinent observations were recorded such as barnacle cover, blockages of the inlet or outlet, and signs of local erosion or scour.

Continuing to work toward approximating the tidal prism and defining the control volume to use for calculation, some channel depths and widths were measured. Team members donned hip waders, walked through the mud, and stretched a tape measure across the major channels that acted as inputs (or outputs) for Culvert 2. Some channel depths were measured with a tape measure against the edge of banks while some were more accurately measured using surveying equipment as described in Section 3.2.1. A major concern regarding the conditions of the entire marsh is erosion of the banks, which was observed from within the channels and from the roadway during each field visit. During the initial site visit, the waterways in and around the salt marsh had been muddy and murky. The presence of gullies, embankment scour at the inlets and outlets, and soil deposits in low areas were noted, and would remain areas of concern throughout the entire monitoring phase. Figure 17 shows a view of Macomber’s Way and the marsh near Culvert 2.



Figure 17: Macomber's Way at low tide, October 2010 (Photo source: Chris Bernstein)

Shoaling is the process of sediment deposition in an estuary that leads to the buildup of sandbars. This, in addition to the deposition of other eroded materials, can restrict and alter the flow through channels and culverts. The buildup of eroded material can also increase the effective bed height of the channels. This results in shallower channels with less capacity to hold water and therefore can become flooded more frequently with less flow. Erosion can be assessed through visual, physical, chemical and biological means. This project relied on visual and physical assessments, lacking the technology for other more advanced methods of analysis. Marsh conditions were observed and recorded during each field monitoring event. Specific attention was placed on the channels and banks nearest the culvert inlets and outlets, where scour is most likely to occur. The presence of gravel from the roadway that had been deposited in the channels was noted during observation. Any changes or alterations that had occurred between sampling events were also noted.

3.3 Describe Existing Conditions

Describing existing conditions of a study site provides a basis by which to compare the expected results of a new design. The goal of any design is to make improvements to mitigate existing problems; therefore the existing problems must be identified and quantified as clearly as possible. Involved in Phase 3 of the project methodology was extracting and analyzing the Hydrolab and Troll depth data and determining the flowrates through calculation. Culvert 2 was

the focus of the majority of data collection and analysis because it was brought to the attention of the project team as the major problem with Macomber's Way. Higher flows cross under the causeway through Culvert 2, and more flooding and erosion is apparent there than at Culvert 1.

Data analysis for such a unique and dynamic study site was work-intensive. First, the depth data from the two locations were normalized to the road height. Data were adjusted when necessary based on field measurement checks and other observations made by the project team. Then the flowrates were determined based on the flow type at individual time segments during the monitoring period. A soil grain size analysis was also completed using a sample of marsh bank soil. The methods used in calculation are described in this section. The results of these calculations and their implications on the design are explained in Chapter 5. The raw data and calculation work is available in the Appendix.

3.3.1 Normalize Depth Data

The first step in data analysis was to normalize the depth data. Raw data extracted from the depth meters were adjusted based on salinity, measured depths, and known elevations. Normalizing the depth data involved several steps, the sequence of which depending on the known and unknown parameters for that particular sampling event, such as the probe elevations or the times of road overtopping. Figure 18 shows the process of preparing the depth data to be used in flowrate calculation.

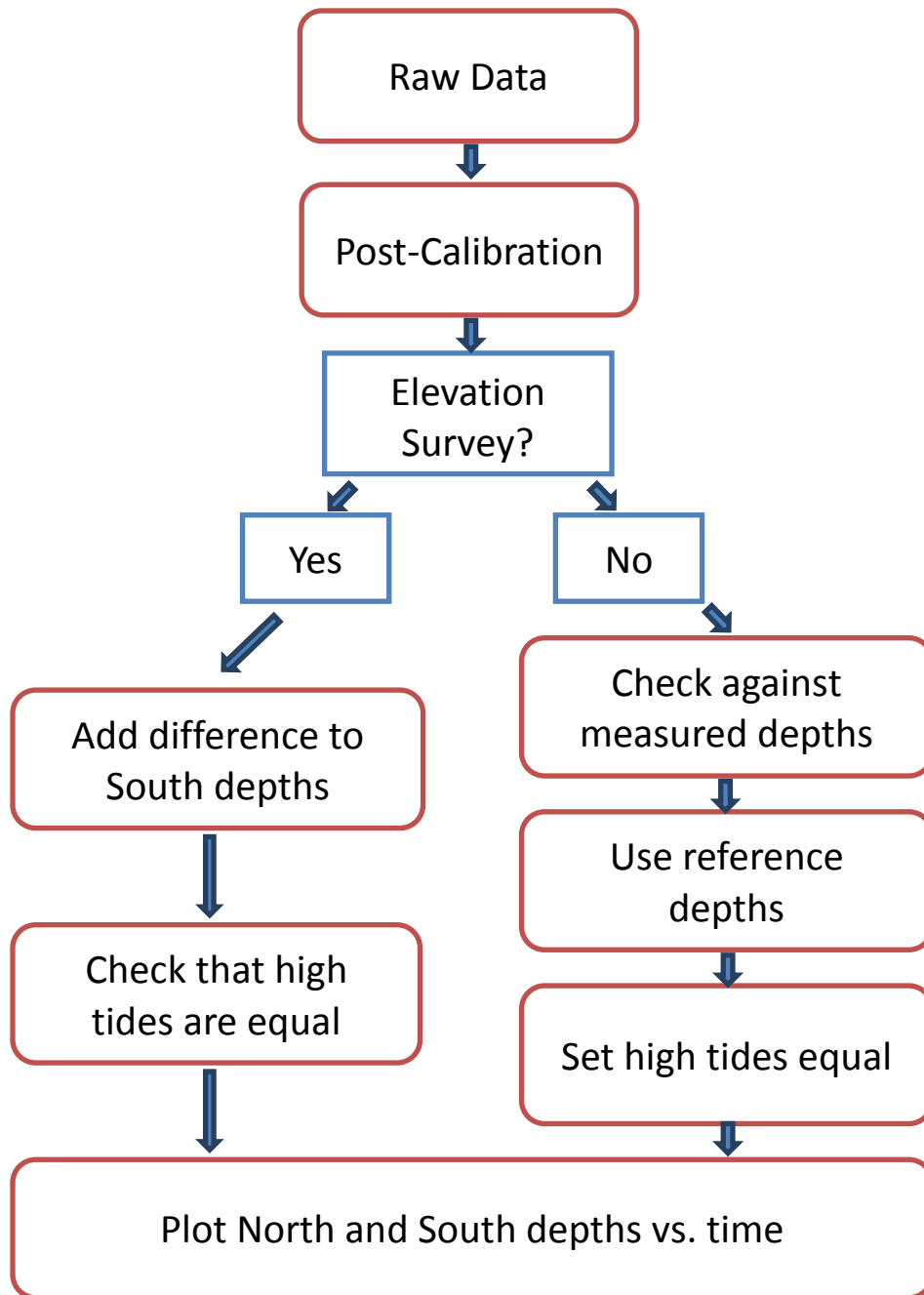

Figure 18: Flow chart of depth data normalizing procedure

The first step after extracting the raw data from the meters was post-calibration based on the zero depth reading. If the data did not reflect a 0.0 feet depth reading when the meter was on dry land, the difference from zero was subtracted as a correction factor from the entire data set. For the November 11th and 15th monitoring, the Hydrolab was calibrated to be used upright, but was then deployed lying flat on its side, resulting in readings of 1.0 foot for zero depth. For these data sets, the South depths were lowered by a 1.0 foot factor based on the readings at a 0 depth. The next post-calibration data adjustments made were to account for salinity. The probes

determine the water depth based on hydrostatic pressure, a product of fluid height and specific weight (Houghtalen, Hwang, & Akan, 2010). The equation for hydrostatic pressure is shown in Equation 2.

Equation 2

$$P = h * \rho * g = h * \gamma$$

Where:

h = water height

ρ = fluid density

γ = specific weight

For the November 11th and 15th monitoring events, the Troll had been programmed to monitor in saline water with a given specific gravity of 1.012 as compared to freshwater. Since the Hydrolab does not have such a setting and always reads as if it is submerged in freshwater, the brackish depths from the Troll were post-calculated as freshwater depths to match the Hydrolab data. Then, both sets were converted to saltwater depths based on an average salinity reading of 30 parts per thousand (ppt). The ultimate effect of salinity on the density and hydrostatic pressure is minimal, but the conversions were carried through for each data set for the sake of continuity. Equation 3 shows the conversion factors of a brackish water depth, saltwater depth, and freshwater depth.

Equation 3

$$h_{freshwater} = h_{brackish} * \frac{\gamma_{brackish}}{\gamma_{freshwater}} = h_{saltwater} * \frac{\gamma_{saltwater}}{\gamma_{freshwater}}$$

Once the post-calibration steps were complete, the following steps were dependent on whether an elevation survey was conducted on the sampling day, as depicted in Figure 18. Since the North and South channels are not the same depth, the two probes were never deployed at equal elevations and required some calculation to be normalized to each other for comparison and flowrate determination. If the elevations of the sample locations were surveyed, this adjustment was made through a simple subtraction. However, the process became more complicated if elevations were not known. On December 12th, the elevations were known. On the other days, the elevations were back-calculated by making other inferences based on the available data.

Without elevation data, the most useful site observation notes were depth measurements taken by hand, and the times of certain depth-related benchmark occurrences. For example, the elevation of the middle of the road, both edges of the road, and both ends of the culvert were known relative to each other based on elevation surveys. So, if it was recorded at a specific time that the water level was at one of these local benchmarks, the probe elevation could be back-calculated based on the known elevations and the recorded depth at that time. Field observations and depth measurements were considered trusted data and were used to check the accuracy of probe

readings. It was important to have more than one source of data to ensure the legitimacy of the results. Once the depth data values were normalized and in agreement with field observation, the depths on each side of the road were graphed. Depths were plotted on the y-axis in feet with time on the x-axis. The time scale was set so that the zero time value was at low tide. Using this time scale enabled the comparison between conditions on different days, since the tidal cycles do not coincide with the time on various days.

3.3.2 Determine Flowrates

Some culverts can be modeled using one flowrate (Q) equation, but the conditions at this site continually change according to the cyclic pattern of the tides, creating the need for several different models. No single discharge equation was adequate to model the entire range of conditions, and instead several flow models were applied while time-stepping through the data over a tidal cycle. Once the depth data were normalized and plotted against time beginning with time = 0 at low tide, the flow conditions were separated into the following eight categories:

1. Low tide (no flow in culvert)
2. Flood current open channel flow
3. Flood current submerged culvert
4. Flood current submerged culvert with road overtopping
5. High tide (no flow)
6. Ebb current submerged culvert with road overtopping
7. Ebb current submerged culvert
8. Ebb current open channel flow

These eight flow categories occur during each tidal cycle, beginning at low tide. This section describes the applicable flowrate equations for each of the eight categories. Not only do the conditions at the study site change over time between these eight categories, but the conditions within each category are also not ideal. Flows in coastal and estuarine waters tend to be unsteady and non-uniform since “the flow is driven by periodic tidal action” (Ettema, 2000). So, much of the calculations presented in this section resulted in only approximate results, due to the non-ideal conditions of the site, and the assumptions made by each model. Nonetheless, the most accurate calculations possible were made given the available resources, personnel, and timeframe. The relevant hydraulic models and equations used to determine the flowrates during each flow category are presented in this section.

Low Tide: Low tide conditions were considered to include the entire time at which no flow actively passed through the culvert, not just the exact moment of “low tide”. Low tide conditions as a flow category encompass the entire time between the moment ebb current flow toward the ocean ceases and flood current flows enter the culvert again. Low tide conditions involve no culvert flow, but do occupy a significant amount of time during a tidal cycle (up to around four hours).

Flood current open channel flow: Open channel flow conditions were applied as soon as flow entered the culvert in the North to South direction, and lasted until the culvert became submerged. Depth continually increases in the culvert during this period of time, until the water level exceeds the top of the culvert. Often during open channel flow, Manning's Equation would be applied to determine the velocity, and thus the flowrate, of the water. The Manning equation is shown in Equation 4.

Equation 4

$$Q = v * A = A * \frac{1.49}{n} * R^{2/3} * S^{1/2}$$

Where:

A = cross-sectional area (ft²)

n = roughness coefficient

R = hydraulic radius (ft) = area/ wetted perimeter

S = slope (ft/ft)

However, the Manning equation assumes steady and uniform flow, which is not the case at this site. Under unsteady flow conditions, there is typically a head loss and a drop in water surface level through the channel (or culvert), which is not taken into account with the Manning equation. Instead, the discharge of a partially full culvert could be determined by using a variation of the Energy Equation, once the conditions were classified as Type 1, 2, or 3 flow as shown in Figure 13 (Bodhaine, 1988) and described in Section 2.9.2. The Type 1, 2, and 3 flow classification requires a known velocity, and a known critical depth. Since the flow in Culvert 2 is unsteady and always changing (in this case, increasing during flood current) and the velocity was unknown at most sample times, these equations were not usable. Without classifying the flow as Type 1, 2, or 3, a more generic application of the Energy Equation was used. This method applied an energy balance between location 1 (culvert inlet) and location 2 (culvert outlet) based on the Bernoulli principle and Continuity Equation (Nave, 2012). A basic energy balance assumes no net loss (or gain) of energy between locations 1 and 2, and accounts for head losses through the channel. The basic energy balance is shown in Equation 5.

Equation 5

$$E_1 = E_2 + h_L$$

Where:

E₁ = total energy at location 1

E₂ = total energy at location 2

h_L = head loss

For open channel flow through Culvert 2, the head loss component of the energy balance included energy losses at the pipe entrance (h_e) as well as losses due to friction throughout the entire length of the pipe (h_f). The complete energy balance is shown in Equation 6.

Equation 6

$$y_1 + z_1 + \frac{V_1^2}{2g} = y_2 + z_2 + \frac{V_2^2}{2g} + h_e + h_f$$

Where:

- y_1 = water depth in culvert at inlet
- y_2 = water depth in culvert at outlet
- z_1 = elevation of inlet
- z_2 = elevation of outlet

The entrance loss and friction loss components are shown in Equation 7 and Equation 8, respectively.

Equation 7

$$h_e = K_e * \frac{V^2}{2g}$$

Where:

- h_e = entrance loss
- K_e = entrance loss coefficient (0.5 for projecting, square-edged pipe)

Equation 8

$$h_f = 29 * \frac{n^2 * L}{R_h^{\frac{4}{3}}} * \frac{V^2}{2g}$$

Where:

- L = length of pipe
- n = Manning coefficient
- R_h = hydraulic radius

As previously stated, since flow considerations were not normally uniform, the Manning equation was expected to yield invalid results for the discharge. As such, the energy balance was to be considered the preferable method. However, the assumptions behind the energy balance method weren't always true either, so this approach was also likely invalid in certain cases. Therefore, both methods were used in order to check comparative accuracy. Both calculations were made for all the depth data and the most logical results that provided a reasonable flow variation in time were reported, with consideration to the flowrates at later sample times and the

velocity readings taken in the field. In some cases, the Manning Equation did not seem to produce an excessively large or small flowrate, so the results were deemed relevant. In other cases, the energy balance yielded the seemingly proper result. The justification for using both models was that in reality, the assumptions behind both models were not fully valid and the flow characteristics observed at the culvert did not match particularly well with either one specifically. So, both approaches were used and the more appropriate result was reported as the flowrate at each given sample time. The Manning equation is meant to be applied to steady flow at a consistent depth (y) throughout the pipe or channel, without major losses. The energy balance method assumes losses and a decrease in the hydraulic grade line and energy grade line, as depicted in Figure 19. Both of these assumptions are flawed for the variety of conditions that exist in this culvert, and neither one of the two approaches was overwhelmingly more applicable than the other overall. Since the major design constraints existed under deeper flows (and not under the considerations for which these two approaches were used, the application of the two approaches was considered to be appropriate for this analysis.

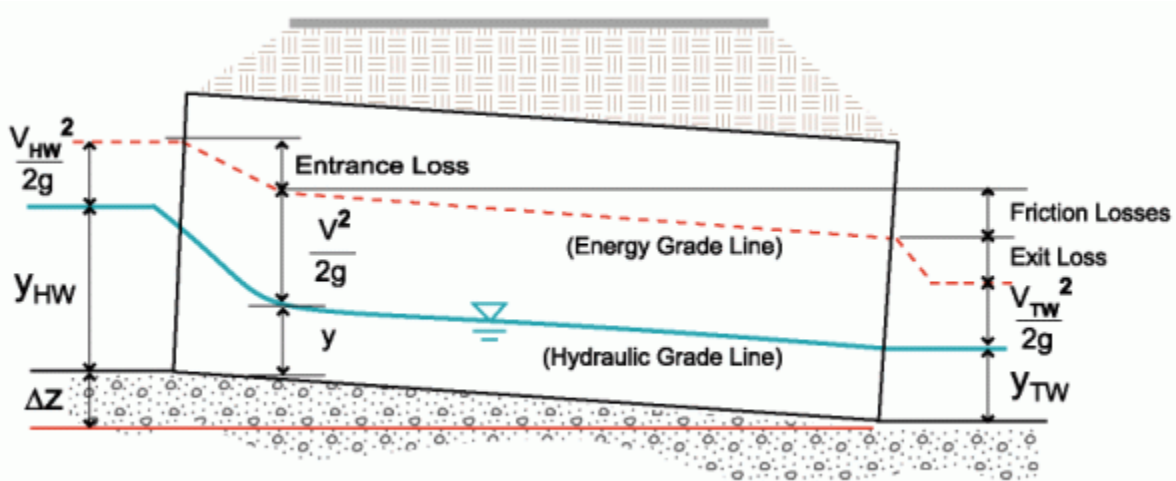

Figure 19: Energy and Hydraulic Grade Lines in Culvert Flow (FishXing, 2010)

Based on observations in the field, the flow does exhibit an entrance loss. A notable decrease in water level by a few inches was observed at the culvert entrance. But, at the outlet, losses were not noticeable. In fact, field measurements showed that the outlet depth was actually higher than the inlet depth, due to the buildup of rocks at the outlet, and the shallower depth in the South channel as compared to the North channel. However, there were limited data collected for depths immediately at the culvert inlet and outlet because the depth meters were deployed in the channels several feet away from the culvert edges (see Figure 15). Thus, it was not known exactly how the water level changed just as it entered or exited the culvert. With no observable head loss or downstream constriction at the outlet, the assumption could be made that uniform flow occurred, but with the noticeable entrance loss and apparent increase in depth at the outlet, neither model could accurately represent the situation. The actual conditions are far from ideal

for both models, thus the most appropriate resulting flowrate between the two was used, based on the judgment of the project team members.

For both the uniform flow and energy balance methods, the Manning's roughness coefficient (n) was involved in the calculations. The Manning's roughness coefficient for a given channel is usually determined using "best engineering judgment" and by consulting one of the many existing tables of commonly used materials and associated n values (Manning's Roughness Coefficient, 2012). For the corrugated polyethylene material of Culvert 2, the n value is within the 0.018 to 0.025 range. Sometimes, as in this case, unforeseen factors can affect the roughness of a man-made channel that would otherwise exhibit relatively uniform conditions. Abundant barnacle growth was apparent on the inside of the pipe, altering the surface roughness (Figure 20).



Figure 20: Barnacle cover of Culvert 2 (Stitt, 2011)

In a similar case involving a concrete channel in Corte Madera Creek built by the United States Army Corps of Engineers, the presence of tubeworms had a drastic effect on the effective surface roughness (U.S. Army Corps of Engineers, 1994). The U.S. Army Engineer Waterways Experiment Station estimated the effective surface roughness (k_s) of the section with tubeworms to be 0.08 ft, whereas the usual value would be 0.007 ft (Copeland & Thomas, 1989). For Culvert 2, the Schultz equation was applied (Equation 9), which relates the barnacle thickness and percent cover of the culvert to an effective surface roughness, k .

Equation 9

$$k = 0.059R_t(\% \text{ Barnacle Fouling})^{1/2}$$

In Equation 9, R_t represents the height of the largest barnacles, which was 1 inch (25.4 mm) in this case. The percent of barnacle fouling, or percent of the culvert covered in barnacles, was estimated to be 90%, proof of which can be seen in Figure 20. Based on this information, the roughness height (k) would be 1.42. The Strickler function (Equation 10) was used to determine the n value by substituting 1.42 for the k_s value (Chow, 1959).

Equation 10

$$n = 0.034k_s^{1/6}$$

The use of the Strickler function resulted in a Manning's n value of 0.036 for Culvert 2. This roughness coefficient is greater than the range given by the literature for corrugated polyethylene (0.018 to 0.025). Barnacle cover of the inner walls of the culvert resulted in a rougher surface, and thus a greater friction effect on the flow of water.

Other calculations involved in determining the flowrate for a partially full culvert included determining the hydraulic radius, which required the cross-sectional area of the flow and the wetted perimeter of the circular culvert. The hydraulic radius, and the circular culvert geometry associated with it, was a necessary calculation used in both methods of determining open channel flowrates. Using circle geometry as described by LMNO Engineering, the area, perimeter, and hydraulic radius were determined based on the water depth (y) and the diameter (d) of the pipe (3 feet). Figure 21 shows the basic circular pipe geometry used in these calculations.

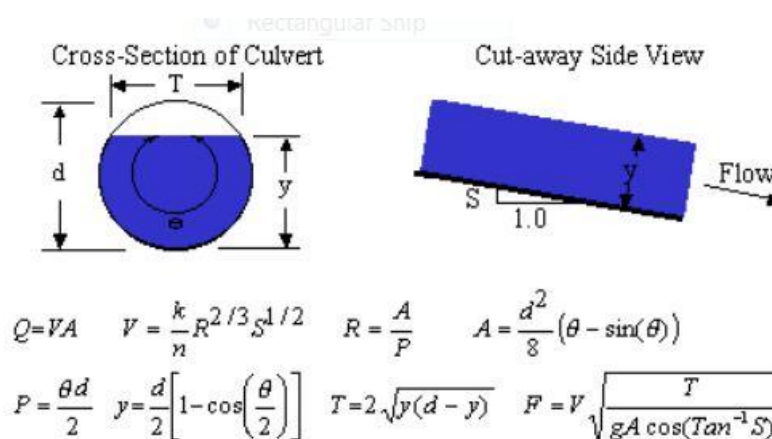

Figure 21: Circular Culvert Geometry (LMNO Engineering, Research, and Software, Ltd., 2000)

A Microsoft Excel spreadsheet was used for the Manning equation-based flowrate calculations. The culvert diameter and slope were set as constants. Depth values were inputted based on the data collected with the Hydrolab and Troll. The values for the angle (θ), the area (A), the water

surface top width (T), and the wetted perimeter (P) were calculated for each sample time using the equations shown in Figure 21. The inlet and outlet depths in the culvert were averaged to determine the y value for the entire length of the culvert, since uniform depth was assumed. The velocity was determined using the Manning equation (Equation 4) for each depth and sample time, and the flowrate was determined by multiplying the velocity and cross-sectional area.

For the energy balance method, separate calculations for y, A, θ , and velocity were completed for the inlet and outlet at each sample time, since they were assumed to have different water elevations. Then the entrance loss and friction loss were determined using an average velocity between the inlet and outlet velocities that were already determined. The formulas were set up in a spreadsheet so that values for Q were tested by trial and error until the net energy balance reached zero. The input Q value was divided by inlet and outlet cross-sectional areas (based on culvert geometry according to the y values) to determine the inlet and outlet velocities, which were used in the energy equation. Once a flowrate that satisfied the energy balance was determined for each sample time, they were compared against the results from the Manning equation and field measurements before the final results were reported.

Flood Current Submerged Culvert: Once the culvert became submerged, different discharge equations were applied. During submerged conditions, Culvert 2 exhibited characteristics of Type 4 flow as described by the USGS (Bodhaine, 1988). Type 4 flow occurs when the inlet and outlet are both submerged, resulting in a headwater (h_1) behind the inlet and a tailwater (h_4) beyond the outlet. Although the tidal flow forces the water through the marsh channels and toward Culvert 2, the driving force for the culvert flowrate under submerged conditions is the difference between the water elevations on the North side (headwater) and the South side (tailwater). Figure 22 shows Type 4 Flow.

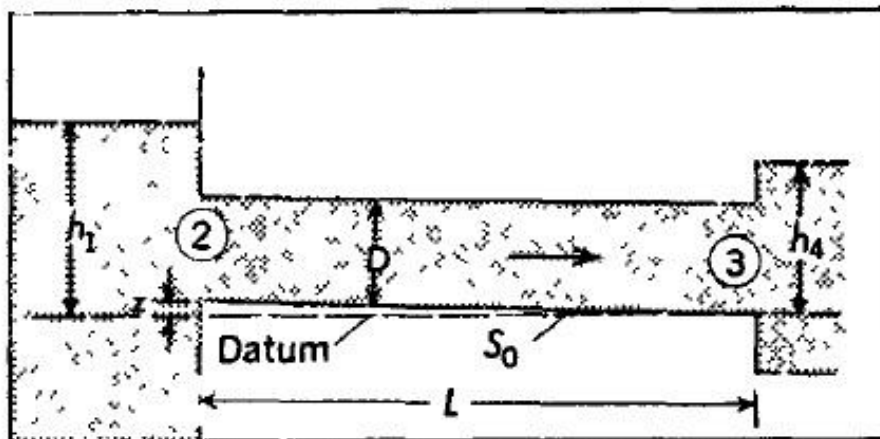

Figure 22: Type 4 Flow Diagram (Bodhaine, 1988)

For Type 4 flow during flood current conditions, h_1 represents the headwater depth in the North channel and h_4 represents the tailwater depth in the South channel. The z value is the elevation difference between the North and South edges of the culvert, which was 0.21 feet. Requirements

of Type 4 flow are that the values of $(h_1 - z)$ and h_2 are each greater than the diameter (D), or in other words that the culvert is submerged and has both a headwater and tailwater depth above the top of the culvert. The headwater level also must be higher than the tailwater. The discharge equation used for submerged culvert conditions is shown in Equation 11 (Bodhaine, 1988).

Equation 11

$$Q = c * A * \sqrt{\frac{2g(h_1 - h_2)}{1 + \frac{29c^2n^2L}{R_0^{4/3}}}}$$

In Equation 11, the variable c represents the discharge coefficient, which for Culvert 2 under Type 4 conditions was 0.88 (Bodhaine, 1988). Hydraulic radius (R_0) for all circular pipes during full-flow is equal one-fourth of the diameter, $(\frac{D}{4})$ which was 1.25 feet for this culvert. The length (L) was 28 feet and the z value was 0.21 feet for all situations; these are physical characteristics of the culvert that do not change based on flow conditions.

Flood Current Submerged Culvert with Road Overtopping: As mentioned in the Background chapter, Macomber’s Way often becomes flooded during high tide conditions. During flood tide, the water levels in North and South channels, and in the marsh as a whole, increase until reaching a maximum at high tide. It was observed that sometime after the culvert became submerged, the headwater depth would exceed the height of the road and flow would begin to overtop the roadway, as shown in Figure 23.



Figure 23: Water flowing over the roadway (Stitt, 2011)

With increasing water levels, the road acted as a broad-crested weir to the water flowing over it between the North channel and the South channel. During these conditions, flowrates were determined for the water passing through the culvert as well as over the road. The total flowrate was determined as the sum of the flow through the culvert and the flow over the roadway as a weir, as shown in Equation 12.

Equation 12

$$Q_{total} = Q_{culvert} + Q_{weir}$$

The same submerged culvert discharge equation was used (Equation 11) for Type 4 flow through the culvert, and the result was added to the flowrate over the road to determine the total flow at that time. Figure 24 shows flow over a broad-crested weir, which is how the flow over the road was modeled.

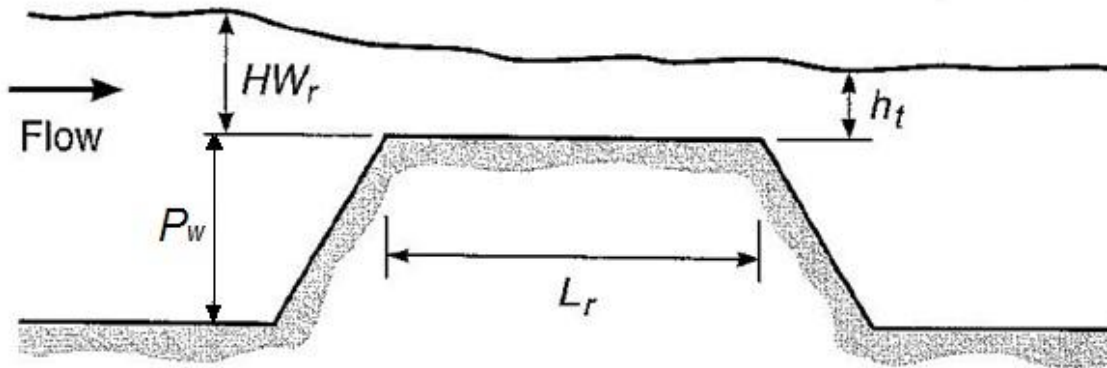

Figure 24: Broad-crested weir (adapted from Sturm, 2009)

To determine the flow overtopping the road, a general weir flow equation was applied (Equation 13).

Equation 13

$$Q = C_{wb} * b * \sqrt{g} * \left(\frac{2}{3}\right)^{\frac{3}{2}} * (HW_r)^{\frac{3}{2}}$$

Where:

C_{wb} = weir discharge coefficient

b = width of weir

HW_r = headwater over the road height

First of all, the effective height of the road (P_w) was determined. In actuality, the roadway is not level; there are large rocks lining both edges to prevent gravel loss from the road as flow passes over. There are also low points along the roadway, at which the first signs of flooding occur. In order to use the weir discharge equation, the effective roadway height was assumed to be the mid-road elevation (as determined through the elevation surveys). This assumption created an overestimate of the flow when considering the high-elevation rocks that retain water off of the road above the mid-road elevation. Alternatively, this same assumption also created an underestimation of the flow when considering the high-velocity streams of overflow that occur at the low points, before the water surface elevation reaches the mid-road benchmark.

Once the road height was set, it was subtracted from the depth readings to determine the HW_r and h_t values. During flood current, the North channel water level was used to determine the HW_r and the South channel water level was used to determine the h_t value. At high tide, a net flow of zero was assumed.

The weir discharge coefficient (C_w) was determined using Equation 14 (Munson, Young, & Okiishi, 2006).

$$C_w = \frac{0.65}{\left(1 + \frac{H}{P_w}\right)^{1/2}}$$

After determining the weir discharge coefficient using Equation 14, the flowrates were determined by using Equation 13 for each set of depth readings. The total flow at each of these times was the sum of the weir flow and culvert flow. Culvert flow was determined using Type 4 flow equations as previously mentioned.

High Tide: The high tide condition at Macomber's Way is a momentary occurrence of no net flow, as the tide changes from flood to ebb current. High tide and low tide are the null points in the estuary, when the net flow is zero. At high tide, there can be up to two or three feet of standing water on the causeway, making it difficult to decipher the edges of the road from the marsh channels and inhibiting drivers from accessing Trouant's Island. During high tide conditions that exceeded the road height by more than a few inches, which occurs during average tidal ranges, the assumption was made that the water elevations were level between the North and South sample sites. Once the water levels overcame the roadway and the larger rocks on the road edges, the entire marsh was considered to have the same water elevation. This assumption made normalizing the North and South channel depth readings possible by setting the high tide readings equal to each other. This also served as a check for the accuracy of elevation readings because if done correctly, the high tide values on either side of the culvert would be equal without adjustment.

An important calculation-related characteristic of high tide is that with the changing of tides, the inlet and outlet values for the culvert switch. As flow shifts from the North-South direction to the South-North direction, the South depths become the inlet conditions and North the outlet. For example, h_1 and h_4 values during Type 4 flow were switched after high tide.

Ebb Current Submerged Culvert with Road Overtopping: After high tide, the current ebbs back toward the coast in a South to North direction over the road and through the culverts. The same weir flow equation was applied to the ebb flow over the road (Equation 13), but with the South channel water levels as HW_r and North as h_t .

Ebb Current Submerged Culvert: The same Type 4 flow equations used for submerged culvert flow during flood tide (see Equation 11) were applied to the ebb current submerged culvert conditions. During ebb flow, the h_1 values are based on the South side depths and the h_4 values are based on the North Side depths. A difference in the ebb flow is that the culvert elevation is higher at the outlet than the inlet, so the z value was treated as -0.21 feet under these conditions.

Ebb Current Open Channel Flow: Once the culvert became unsubmerged, open channel flow conditions occurred in the South to North direction. The Manning equation proved invalid for

ebb conditions due to the inverse slope of the culvert. During ebb current, the water flows through the culvert at an upward 0.0075 (ft/ft) slope. Instead of using the Manning's Equation, a variation of the Energy Equation was used for these conditions. As mentioned in the earlier description of open channel flow, a basic energy balance relies on the fact that there is no net energy loss through the culvert, because head loss is accounted for in the equation. The same energy balance was applied to these ebb flow conditions as were used for flood current flows (see Equation 6). The energy balance incorporated terms that represented the velocity head, pressure head, entrance losses and friction losses. The only difference between the ebb current and flood current open channel flow conditions was the slope. Again, during ebb flow from the South to North, the culvert is sloped upward. Therefore, the z_1 value is less than the z_2 value, which is usually the opposite for most culverts. However, the water surface levels were still higher at the inlet than the outlet, maintaining the appropriate hydraulic gradient and energy gradient, as shown in Figure 25 for a downward-sloping culvert. The same spreadsheet was used to determine the flowrates during ebb and flood current conditions, with only the inlet and outlet values switched. Again, the inlet (South) and outlet (North) water surface levels and culvert elevations were inputted into the energy equation, and the flowrate input was adjusted until the net energy balance reached zero.

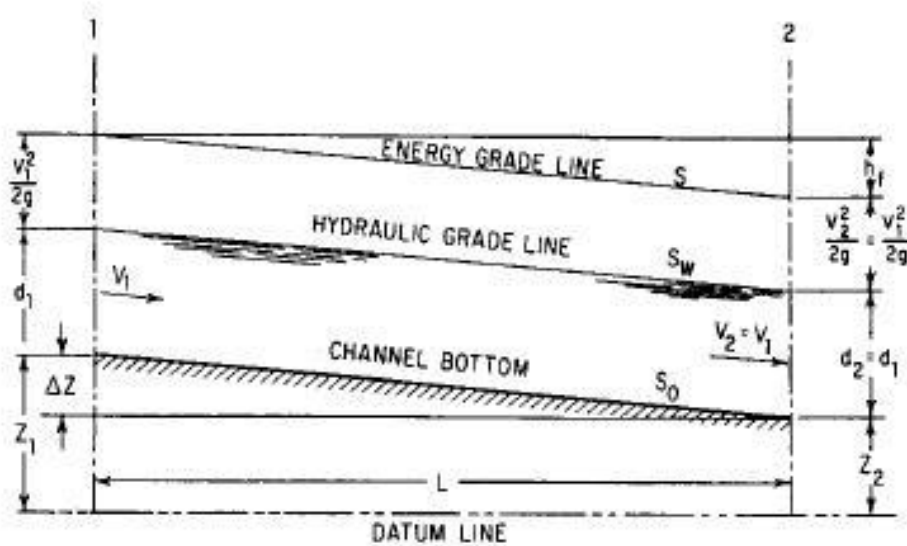

Figure 25: Energy Grade Line through culvert (Singh, 2007)

The water levels inside the culvert and in the channels on each side decreased over time until flow no longer entered the pipe. Once the flow stopped, ebb current conditions at Culvert 2 ended and low tide conditions began, until the flow re-entered from the North side after a tide change. Low tide conditions were applied to the entire period of no flow.

3.3.3 Determine Tidal Volume

To get a sense of the amount of water involved in the tidal exchange through and over the roadway, the flowrates were used to determine volumes of water. The volume is represented by the integral of the flowrate over time, which was determined using the Trapezoidal Rule. The Trapezoidal Rule estimates the area under a curve using trapezoidal areas, connecting each consecutive pair of data points linearly.

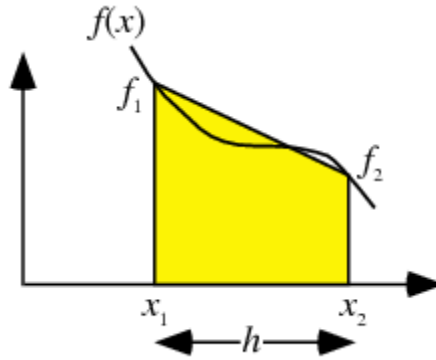

Figure 26: Trapezoidal Rule of Approximate Integration (Weisstein, 2012)

A visual representation of the trapezoidal approximation involved in the numerical integration is provided in Figure 26. The yellow shaded region (trapezoid) represents the approximated area under the curve. The numerical integration is also represented by Equation 15.

Equation 15

$$\int_{x_1}^{x_2} f(x) dx \approx (x_2 - x_1) * \frac{f(x_1) + f(x_2)}{2}$$

Where:

$f(x)$ = flowrate at time “x” (cfs)

$\int_{x_1}^{x_2} f(x)$ = volume passing between times x_1 and x_2 (ft³)

The total volumes were determined through the culvert for both flood and ebb currents, as well as over the roadway during flood and ebb currents. For the road overtopping calculations, the roadway length was assumed as 1500 feet, an approximated cover of the 1840-foot causeway roadway that becomes flooded during average tidal ranges. A total volume calculation was also made using a 10 feet wide control volume of roadway, to represent the section of road above Culvert 2 only, in alignment with the main channels. This calculation was done to provide a comparison between the volume passing through and over the culvert.

To provide some context for these flowrate and volume results, the total volume of the English Salt Marsh was determined. Using ArcGIS, the area of the marsh was approximated. Once the area was determined, a depth of 1 foot of water was assumed over the entire marsh, providing a

volume in ft³. This can be compared to the flowrates calculated for the volumes moving through the culverts and over the road to ensure they are logical.

3.3.4 Soil Grain Size Analysis

A soil grain analysis was performed on a sample of soil from the banks of the marsh. First the sample was kept in an oven at 100°C for three days, enough time to fully desiccate the sample without harming any of the other matter within. A sieve analysis was then performed using the dried soil sample. A series of six sieves with pore sizes of 25, 19, 12.5, 9.5, 4.75, and 3.55 mm were stacked in order of decreasing pore size, with an additional pan at the bottom to catch the solids that passed all the way through. Each sieve was weighed before the sample was placed into the top sieve (largest pore size). The stack of sieves was strapped into a sieving device which shook the sample for ten minutes, allowing the particles to pass downward through the sieves. The soil grains were retained in the various sieves, depending on the particle sizes. Each pan was re-weighed and the difference in weight was equal to the amount of sample retained in that sieve, which was later converted to percent-by-weight. The portion of the sample that had passed through into the bottom pan was then placed in the top of a set of smaller sieves and shaken again. This series of sieves included sizes of 1.19, 0.589, 0.297, 0.150, and 0.075 mm. These sieves were also weighed before and after the sample was placed inside. Based on the weight of soil sample retained in each sieve compared to the total, the percent passing was determined for each sieve. Finally, the effective grain size of the sample was determined. The effective grain size is equal to the grain size that corresponds to a 10% passing rate (Fetter, 1994).

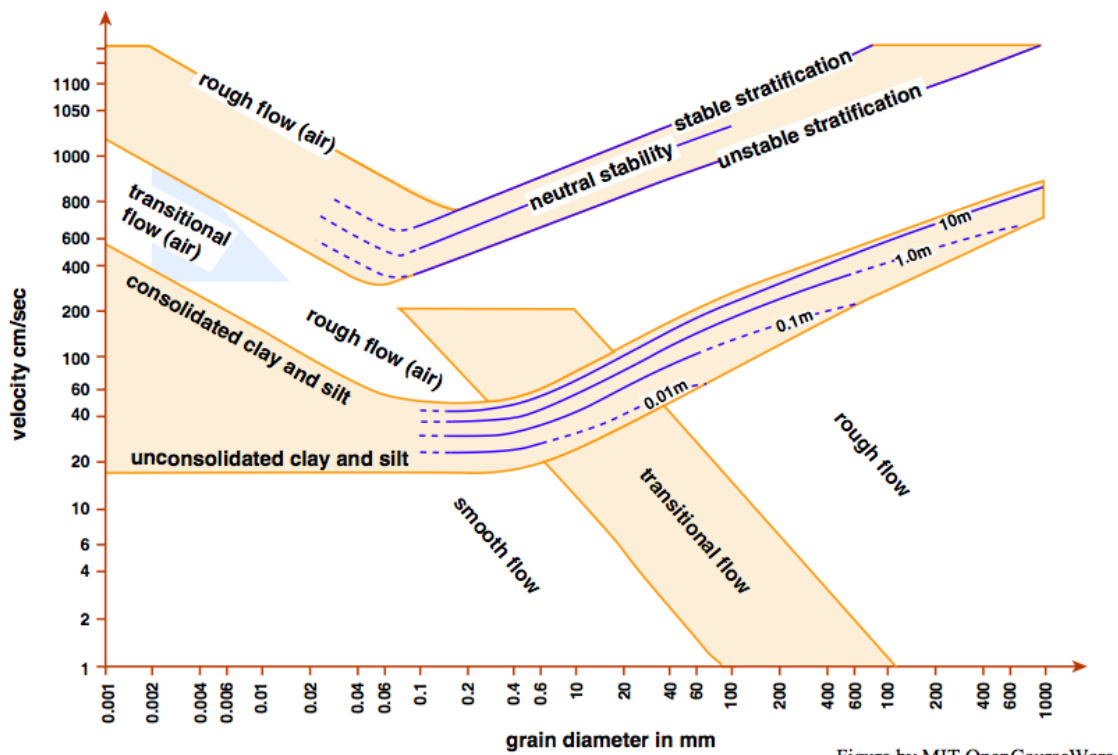

Figure by MIT OpenCourseWare.

Figure 27: Hjulstrom Curve (courtesy of MIT OpenCourseWare)

Further analysis of the soil grain size required the use of the Hjulstrom curve, as shown in Figure 27. The curve was used to find the critical erosion velocity, based on the effective grain size. The curve shows critical erosion velocity, which is the necessary velocity needed to dislodge a particle of a given grain size. The curve also shows velocities at different depths and for consolidated and unconsolidated soils. The critical erosion velocity was an important factor in the design, because a main part of the goal was to mitigate erosion. This means the allowable culvert flow velocity must be maintained at a speed less than the critical erosion velocity. This will minimize erosion and minimize negative impacts from the culverts on the marsh banks.

3.4 Conceptualize Design Options

After all the data were collected and analyzed, and existing conditions were assessed, the design process began. The design choices made during this project were based on the assessment of erosion, flowrates, and overall conditions of the causeway, culverts, and surrounding marsh environment. Several design options were considered as potential solutions to the problem. Through the evaluation and comparison of each option and the use of rankings based on certain criteria, the project team decided on a final design and set of recommendations, which are presented in Chapter 5. The basic procedure for choosing the final design included the following steps:

1. Identify design objectives
2. Identify design constraints
3. Identify conceptual design options
4. Evaluate each option based on the given objectives and constraints
5. Choose the final design concept
6. Develop design specifications

The “final design concept” refers to the basic idea for the final solution, without the design specifications or calculations worked out yet. For this project, the design objectives were to mitigate local erosion and decrease the severity of flooding over the roadway. So, the only design concepts considered were ones that may achieve one or both of these objectives. The design constraints refer to any regulatory, geographical, economical, or other limitations to the design. According to the Accreditation Board for Engineering and Technology (ABET), engineering designs should consider all or most of the following design criteria: economic, environmental, sustainability, constructability, ethical, health and safety, social, and political.

With the project goal in mind, the team developed a list of potential designs that might decrease flooding by preventing water from overflowing the roadway, allowing more water to pass underneath, or diverting flows away from the roadway. Designs that addressed the scour and erosion were also conceptualized. The potential design options were evaluated based on certain design criteria and constraints, and then compared to each other. Each design option was ranked based on the following factors: economic, environmental, constructability, health and safety, social, political, and an overall evaluation. A table was created with the design options listed against each design criterion, and a ranking as determined by the project team. Most of the rankings were qualitative such as “poor”, “fair”, or “good”.

The existing roadway conditions were neither safe nor environmentally sound, both of which constituted parts of the main problem statement. The design options that were characterized as the best overall were considered for the final design. The final phase in the design process was developing the specifications (step 6 in the above list) and is described in detail in the following section (3.5). The methodology only is presented here; the actual design specifications and final recommendations are presented in Chapter 5.

3.5 Develop Final Design

The final phase of the project methodology was to develop the final design based on the benefits and drawbacks of each potential option that was determined in Phase 4. The final design was considered to be the most cost-effective way to mitigate the flooding and erosion issues along Macomber’s Way, within the regulatory and environmental constraints. Once the conceptual design was decided upon, the specifications were determined through further research and calculation. The size, material, design flowrate, and lifespan of the culvert were among the characteristics to consider. The methods that were used during this process are presented here in

this section while the results, discussion, and projected outcomes of the implementation are found in the Final Design chapter (Chapter 5).

The final design included replacing Culvert 2 with a box culvert. The use of culverts as a means of channeling water beneath roadways dates back thousands of years. Unfortunately, many of these culverts were installed without much consideration toward their ability to operate under extreme conditions, such as storms. In cases where the inlet flow to the culvert is greater than the culvert's capacity, water will flow over and around the pipe, or back up and create pools or reservoirs. These occurrences are referred to as insignificant flow. The case of insignificant flow has been seen with the circular culvert present through Macomber's Way. Because the current design is unacceptable, the proper culvert span for the replacement culvert must be selected prior to installation to ensure conveyance of the anticipated water through the box.

3.5.1 Loading Rate

Since culverts are installed under roadways, it is important to determine the critical load of the culvert: the maximum amount of weight that it can support before collapsing. The American Association of State Highway and Transportation Officials (AASHTO) Load and Resistance Factor Design (LRFD) code is the standard code used for determining live loads on culverts. A box culvert under a roadway can function as a bridge and therefore should be designed as such. Although the methods outlined in the AASHTO LRFD code are thorough, Bloomquist and Gutz found them to also be "extremely difficult to apply" and "too conservative" (Bloomquist & Gutz, 2002). In response to these criticisms, a project was undertaken by the University of Florida and the Florida Department of Transportation to come up with a new method of design. The results of that project determined that performing stress calculations through the superposition method provided feasible results, with the extent of assumptions made not substantially exceeding real-life conditions. The majority of cases in the study showed that the maximum moment dictated the design and that equivalent uniformly distributed loads, for the most part, had minimal variation with different culvert spans. This yielded a conservative design equation (Equation 16). The equivalent uniformly distributed load is q , with units of pounds per linear foot, and the depth of fill is z with units in feet.

Equation 16

$$q = \frac{2300}{z}$$

This equation applies to culverts with a span of 6 to 14 feet, but spans outside of this range may produce inaccurate moments. In circumstances where there is fill of 2 feet or less, the effect of the fill to dissipate the live load should be neglected, as stated in the AASHTO specification, and Equation 16 should not be used. Since the culvert trial sizes used in this design were within this range, the load equation remained valid and was used.

3.5.2 Design Flow Rate

The design flowrate is often the defining characteristic of a culvert. A design storm is typically used to determine the peak discharge of stormwater runoff or a river culvert. This incorporates the risk-based approach of a “design return period”. For example, there is a 1% chance of exceedance with what is called the “100-year storm surge”. This means that there is a 1% chance that a storm surge greater than or equal to that magnitude will occur. Commonly used return periods in coastal designs include the 100-year, 50-year, 25-year, or 10-year storms. The choice is made based on a balance of economic, engineering, and safety considerations. The Federal Emergency Management Agency (FEMA) conducted a flood insurance study for Plymouth County, Massachusetts in 2008, which included Marshfield and Scituate, the neighboring areas to the English Salt Marsh. Peak discharge rates for the 10-year, 50-year, 100-year, and 500-year storm events at Damon’s Point Road in Marshfield were provided in this study. Table 2 shows the peak flowrates for design storms at Damon’s Point in Marshfield (Federal Emergency Management Agency, 2008).

Table 2: Peak Discharges During Storm Events

	10-percent annual chance	2-percent annual chance	1-percent annual chance	0.2-percent annual chance
Peak Discharge (cfs)	200	250	270	520

A conservative design was important because of the eleven homes on the island. However, for a small gravel road like Macomber’s Way, a design based on a 100-year storm surge was not necessary. The design of the replacement Culvert 2 was sized to handle a 10-year design storm and the 100-year storm conditions were also applied later for a comparison. Due to the power cable that runs beneath the roadway, the maximum height (or rise) of the culvert was 3 feet. The design called for a box culvert to replace the existing circular pipe culvert (3-foot diameter). Various culvert sizes were tested and considered before the final design was specified. The trial sizes used a 3-foot rise with spans of 3, 4, 5, 6, 7, 8, 9, and 10 feet. The maximum width of the culvert was set at 10 feet to avoid the need to widen pre-existing channels. As previously mentioned, the 10-year storm discharge was used as the design flow for Culvert 2.

3.5.3 Selecting design size

The first method of eliminating some of the trial sizes was using the critical erosion velocity as determined through the sieve analysis of the marsh soil sample. The purpose of conducting the soil grain size analysis was to determine the minimum velocity at which the soil will be eroded. This velocity was set as the maximum allowable velocity for the culvert flow. The maximum flowrate determined based on the data analysis for each sampling event was assumed as the

flowrate, and the velocity was determined using that flowrate with each trial size culvert. The velocity was determined using Equation 17.

Equation 17

$$V = \frac{Q}{A}$$

Where:

V = velocity, ft/s

Q = flow rate, cfs

A = cross-sectional area, ft²

Each trial size was inputted into Equation 17 to determine the resulting velocity under the existing peak flow conditions. The cross-sectional area (A) is the product of the culvert span and rise. Each size that resulted in a velocity greater than the critical erosion velocity was eliminated from the list of possible sizes.

Selecting design size using nomographs

The remaining culvert sizes were examined using the nomograph design method for constant discharge, in order to further narrow down the range of sizes to one final design size. It was determined whether the culvert would be under inlet or outlet control based on the headwater levels determined for each scenario. Whichever of the two resulted in a higher headwater would dominate. The inlet control calculations required the use of a nomograph. Nomographs require a trial-and-error solution, but obtaining the solution is a simple procedure that can provide a reliable design. An inlet-control nomograph was used in this design, as shown in Figure 28. The nomographs were used to determine headwater under inlet control conditions.

The 10-year storm was applied as the design flow (Q) in the following calculations. The peak discharge for the 10-year storm was given as 200 cfs (Federal Emergency Management Agency, 2008). The use of the nomograph resulted in a $\frac{HW}{D}$ value for each input culvert size, where HW stands for headwater depth and D represents the culvert rise. On the nomograph, a straight line was drawn between the D value and $\frac{Q}{B}$ (discharge to width ratio) to then determine the $\frac{HW}{D}$ value. Each culvert span (B) within the remaining size range was used on the nomograph with Q set constant at 200 cfs and D set at 3 feet. The headwater depths for inlet control were determined by multiplying the $\frac{HW}{D}$ by D (3 feet).

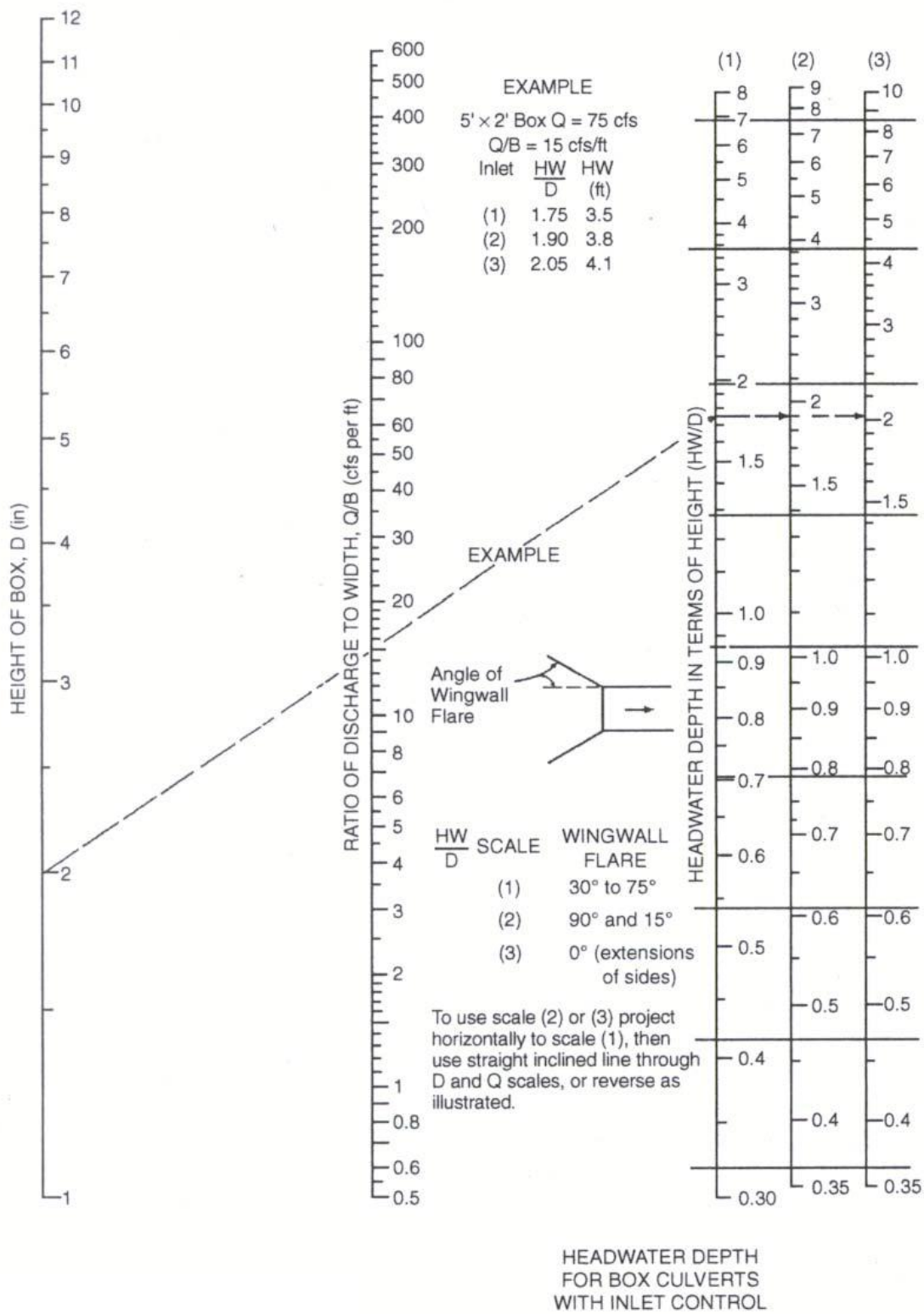

Figure 28: Nomograph for Box Culverts with Inlet Control

Next, the headwater levels were determined assuming outlet control, to complete the comparison and the characterization of the culvert flow. The entrance loss coefficient (K_e) for box culverts with headwalls parallel to the embankment (no wingwalls) and square edged on three edges is 0.5 (Furniss, et al., 2006). The existing slope was used for the design calculations as well: 0.0075, sloping from South to North. The length was also kept at 28 feet. The velocity through the trial culverts was determined using the peak discharge of 200 cfs through the respective areas. Critical depth, d_c , was found using Equation 18.

Equation 18

$$d_c = \sqrt[3]{\frac{q^2}{g}}$$

Where:

q = discharge per ft of width (cfs/ft) = Q/B

g = force of gravity, 32.2 ft/s/s

The headwater for outlet control was then determined Equation 19.

Equation 19

$$HW = H + h_0 - LS$$

Where:

H = energy loss through the culvert at full flow, feet

$h_0 = \frac{1}{2}$ (Critical depth in the culvert + D)

L = length of culvert

S = slope

The energy loss through the culvert at full flow (H) was given by Equation 20.

Equation 20

$$H = (K_e + 29 \frac{n^2 L}{R_h^{\frac{4}{3}}} + 1) \left(\frac{V^2}{2g} \right)$$

Where:

K_e = the entrance loss coefficient

n = Manning's coefficient

R_h = hydraulic radius

V = velocity, ft/s

g = force of gravity, 32.2 ft/s/s

After obtaining headwaters for inlet and outlet-control conditions, the values were compared to see which were higher. The condition with the higher headwater determined the governing design condition.

3.5.4 Maximum allowable headwater

The final defining factor used in determining the culvert size was the maximum allowable headwater. Using the 10-year storm as the design flowrate and either inlet or outlet control based on the calculations described in the previous section, the headwater was determined for each trial size culvert. The allowable headwater depth is given by the elevation of the roadway shoulder line at the low point, less one foot (Alkhrdaji & Nanni, 2001). Based on the road elevation compared to the channel depths, the maximum allowable headwater would be 6.0 feet for this site. Thus the necessary culvert size was the smallest one that resulted in a headwater lower than the maximum (Mohtar, 2001). The resulting size culvert from this calculation was used in the final design as one of the major recommendations.

4. Results and Discussion

Extensive depth data were collected and analyzed, as described in the Methodology chapter. This chapter presents the results of the data analysis and a discussion of their implications regarding the flooding and erosion of the marsh. The existing peak flowrates were used in further analysis and as a parameter in the design phase. A discussion and analysis of the potential design options for the site is provided in this chapter, and the final design is described in detail in Chapter 5.

4.1 Existing Conditions

4.1.1 Culvert Characteristics

The analysis of the depths over time on either side of Culvert 2 was dependent on the accuracy of the elevation surveys completed on December 4th and 12th. Figure 29 shows the culvert profile with the relative elevations of the road edges and culvert edges, all of which served as reference elevations during depth analysis.

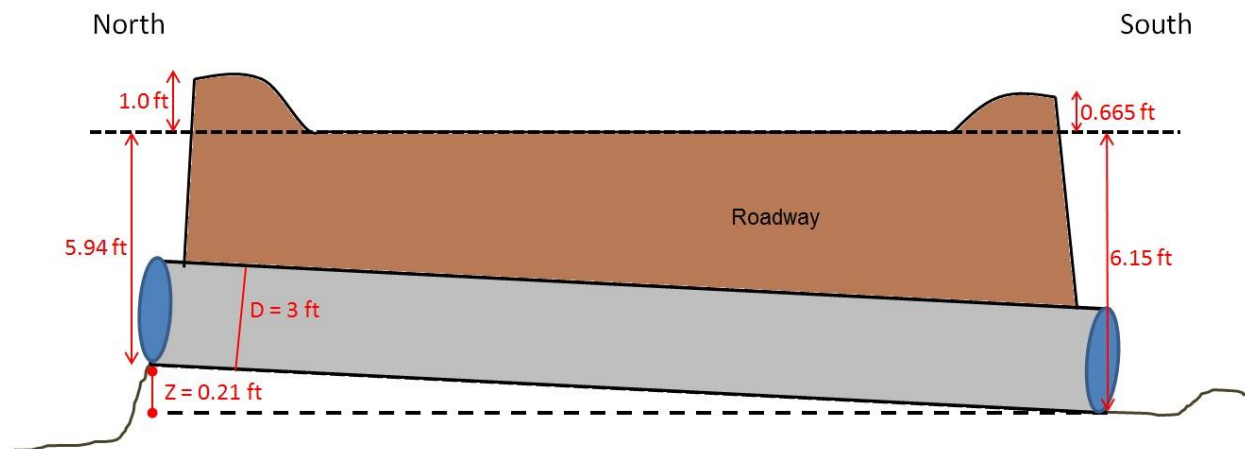

Figure 29: Culvert 2 Profile & Relative Elevations

Based on the elevation surveys completed by the project team, the relative elevations of the roadway above Culvert 2 and the culvert itself were determined, as shown above in Figure 29 and also in Table 3. Although the relative depths in the channels of the two monitoring probes were different during each sampling event, the relative elevations of the culvert and roadway always remained constant as part of the physical site characteristics. These constants were used as reference points during the analysis of each set of depth data. The bottom and top of the culvert, as well as the roadway edges, were used as benchmarks while monitoring the depths of water and analyzing the results. Table 3 presents the relative elevations of these various benchmarks, with the zero elevation set to equal the middle of the roadway above Culvert 2. This means that each elevation is presented relative to the mid-road elevation (0 feet in this table).

Table 3: Relative Elevations of Culvert 2 Reference Locations

Reference Location	Relative Elevation (feet)
Mid-Road	0.0
North road edge	+1.0
South road edge	+0.665
North Top of Culvert (TOC)	-2.94
North Bottom of Culvert (BOC)	-5.94
South TOC	-3.15
South BOC	-6.15

These reference elevations enabled the back-calculating of some surface water elevations, in cases where the depth was not measured by hand as a reference for the probe depth. Also based on the elevation survey, it was determined that the slope of the culvert was 0.0075 (ft/ft), based on the height difference of 0.21 feet over the 28-foot length of pipe. The culvert slopes downward toward the South, and upward toward the North.

4.1.2 Soil Grain Size Analysis









The soil was slightly over-baked before the grain size analysis, causing the soil to accumulate into hard clumps that resisted the sieve process. It was assumed that if this clumping had not occurred, more soil would have passed into the smaller sieves. Therefore using the smallest sieve size for the effective grain size is logical. The effective soil grain size diameter was found to be less than .075mm, the smallest sieve available during laboratory testing. Using the Hjulstrom Curve (Figure 27), the critical erosion velocity was found to be 55 cm/sec, or 1.80 ft/s. As mentioned in Section 3.3.4, the critical erosion velocity is the minimum velocity required to erode soil of the given grain size. Since one objective of the design was to mitigate erosion, specifically the scour at the culvert outlets, the design was sized appropriately so that the velocity during peak flow conditions was maintained under the critical erosion velocity of 1.8 ft/s.

4.1.3 Tides and Flooding

As described in the Methodology Chapter, depth data were recorded during five different monitoring events: November 11th, 15th, 26-27th, November 30th-December 1st, and December 12th-13th. On each of these dates, flooding over the roadway was observed around high tide. The depth of the flooding over the roadway varied each time, based on the daily tidal range and high tide elevation. Since the major tide-generating forces are caused by the gravity of the moon and sun, the daily tidal range and predicted high and low tide levels depend on the lunar phase and

the time of day. As mentioned in the Background section 2.2, spring tides have a larger magnitude than neap tides based on the phase of moon, and daytime high tides are higher than nighttime tides based on the sun. Table 4 shows the predicted high and low tide elevations for the sampling dates and the corresponding moon phases. The tide elevations are reported based on the mean lower low water (MLLW) level.

Table 4: Reported High and Low Tides (US Harbors, 2011)

Date	Moon Phase	Tide	Time of Day	Tide Height (feet)
11/11		Low	05:34	1.0
		High	11:29	9.1
		Low	18:06	0.2
11/15		High	02:04	7.8
		Low	08:16	1.2
		High	14:08	8.9
		Low	20:51	0.3
11/26		Low	05:43	-0.6
		High	11:40	10.9
		Low	18:22	-1.7
11/27		High	00:21	9.3
		Low	06:34	-0.4
		High	12:32	10.6
		Low	19:14	-1.4
11/30		High	03:00	8.6
		Low	09:13	0.2
		High	15:12	9.2
		Low	21:48	0.0
12/1		High	03:54	8.4
		Low	10:08	0.9
		High	16:07	8.6
		Low	22:42	0.4
12/12		High	00:20	8.0
		Low	06:28	0.8
		High	12:22	9.3
		Low	19:02	-0.2
12/13		High	01:00	8.1
		Low	07:10	0.7
		High	13:04	9.3
		Low	19:44	-0.3

The predicted high tide levels presented in Table 5 were used in further analysis by comparing them against the resulted flooding over Macomber’s Way on each of the sample dates. The depth of flooding over the roadway is presented in Table 5, side-by-side with the NOAA predicted high tide levels.

Table 5: Flooding Over Roadway by Predicted Tide Height

Date	Depth Over Road	Reported High Tide
11/15	1.0 feet *	8.9 feet
11/26	2.2 feet	10.9 feet
11/30	0.8 feet	9.2 feet
12/12	0.9 feet	9.3 feet
12/13	1.3 feet	9.3 feet

* Accuracy questionable: meter was moved during sampling

These depths reported were determined based on depth meter readings, and the relative elevations of the meters to the roadway, as explained earlier. The relationship between predicted high tide levels and the resulting depth of flooding over the roadway can be roughly modeled by a linear regression. The correlation was only moderately strong, resulting in an R^2 value of 0.87. On November 15th, the depth readings suddenly decreased at one point during the sampling, likely caused by the movement of the meter due to not being properly secured. For this reason, the depth result on that day is not reported with the same confidence as the others, as mentioned in the footnote under Table 4. However, this data point was still used in the calculation of the linear regression due to the small amount of data points that could be used. Despite the fact that the trend line is an approximation of the flooding depths based on tidal conditions, there is still a clear correlation apparent. The values from Table 5 are plotted in Figure 30 with the resulting linear regression.

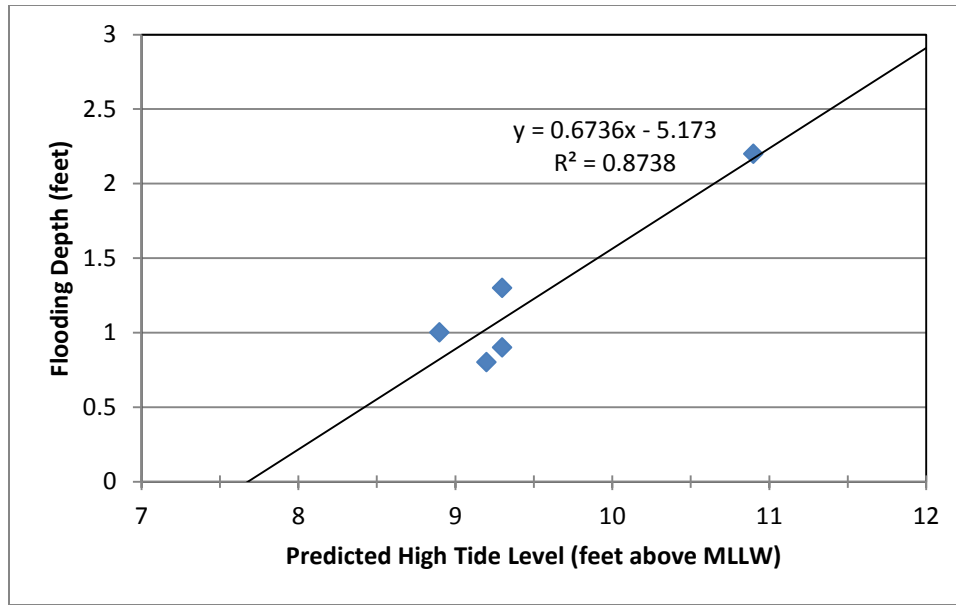

Figure 30: Linear Regression Relating Tide Height to Road Flooding

In the equation presented in Figure 30, the “y” represents the depth of flooding over the road (in feet) and “x” represents the reported high tide water elevation (in feet above MLLW).

4.1.4 Storm Tides

Coastal zones like the English Salt Marsh are vulnerable to degradation due to both human impact and storms. Perhaps the most destructive type of event that can threaten coastal areas and development is the storm surge. According to the National Weather Service, a storm surge is an “abnormal rise of water generated by a storm, over and above the predicted astronomical tides” (National Oceanic and Atmospheric Administration, 2012). Hurricanes and other major storm events often create these surges. A storm tide refers to the rise in water level due to the combination of the surge and the regular astronomical tide. Since Macomber’s Way floods due to the average daily tides alone, a storm tide could pose a major threat to the residences of Trouant’s Island and the other neighborhoods abutting the marsh. Figure 31 shows an example of the effect of storm surge on a coastal zone.

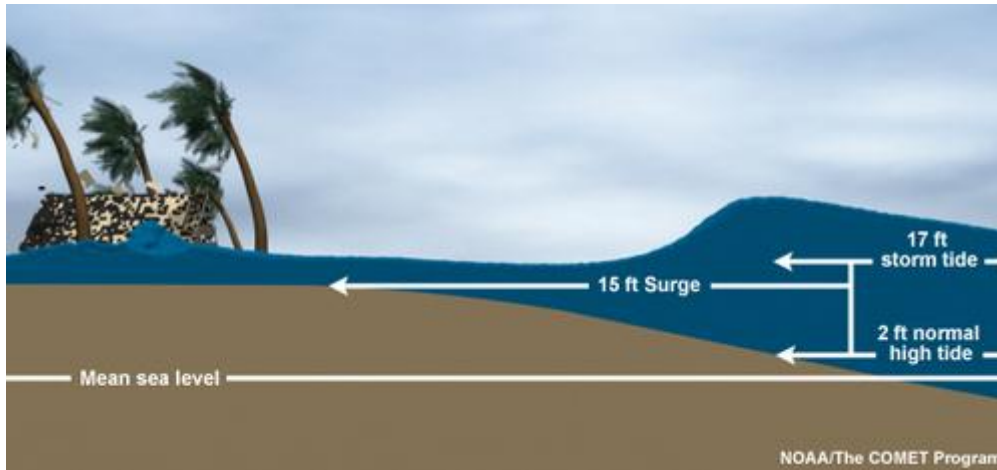

Figure 31: Storm Surge and Storm Tide Example (National Oceanic and Atmospheric Administration, 2012)

The stillwater elevations for storm tides at Damon’s Point were reported in the 2008 FEMA flood insurance study (Federal Emergency Management Agency, 2008). These tides were reported based on NAVD88 elevations, which were converted to MLLW elevations and plugged into the linear flooding regression (Figure 30). By using the regression, severe flooding on Macomber’s Way was predicted for storm tides. The results are presented in Table 6.

Table 6: Storm Tides & Resulting Flood Depths

Design Storm	Stillwater elevation (from MLLW)	Resulting Flood Depth
10-year	13.8 feet	4.1 feet
50-year	14.7 feet	4.7 feet
100-year	15.0 feet	4.9 feet
500-year	15.9 feet	5.5 feet

The results for storm tides were extrapolated using the relationship between the observed flooding and predicted tides for those days. The tides used to develop the regression were all within a range of 3 feet. The storm tide elevations were 3 to 5 feet above the range from the sample days, so the storm tide depths are an approximation. Nonetheless, flooding of 4 to 5 feet resulting from the extrapolation, which would cause very dangerous conditions not only on the roadway but likely on the island itself.

4.1.5 Depth Data

As described in the Methodology, two depth meters were deployed on either side of Culvert 2 on five different sample days. Two of these sample days were used in further analysis and to determine the flowrates through the culvert. The two sampling events that will be discussed in this section are November 30th-December 1st and December 12th-13th. These two data sets were the most complete, each one spanning over two full tidal cycles. During these events, the depth meters were left on-site overnight for extended sampling. For the analysis of the depth data, the water surface elevations in the North and South channels were plotted with respect to the North probe elevation as the zero elevation. Figure 32 shows the water levels for the 11/30-12/1 sampling event and Figure 33 shows the 12/12-12/13 event.

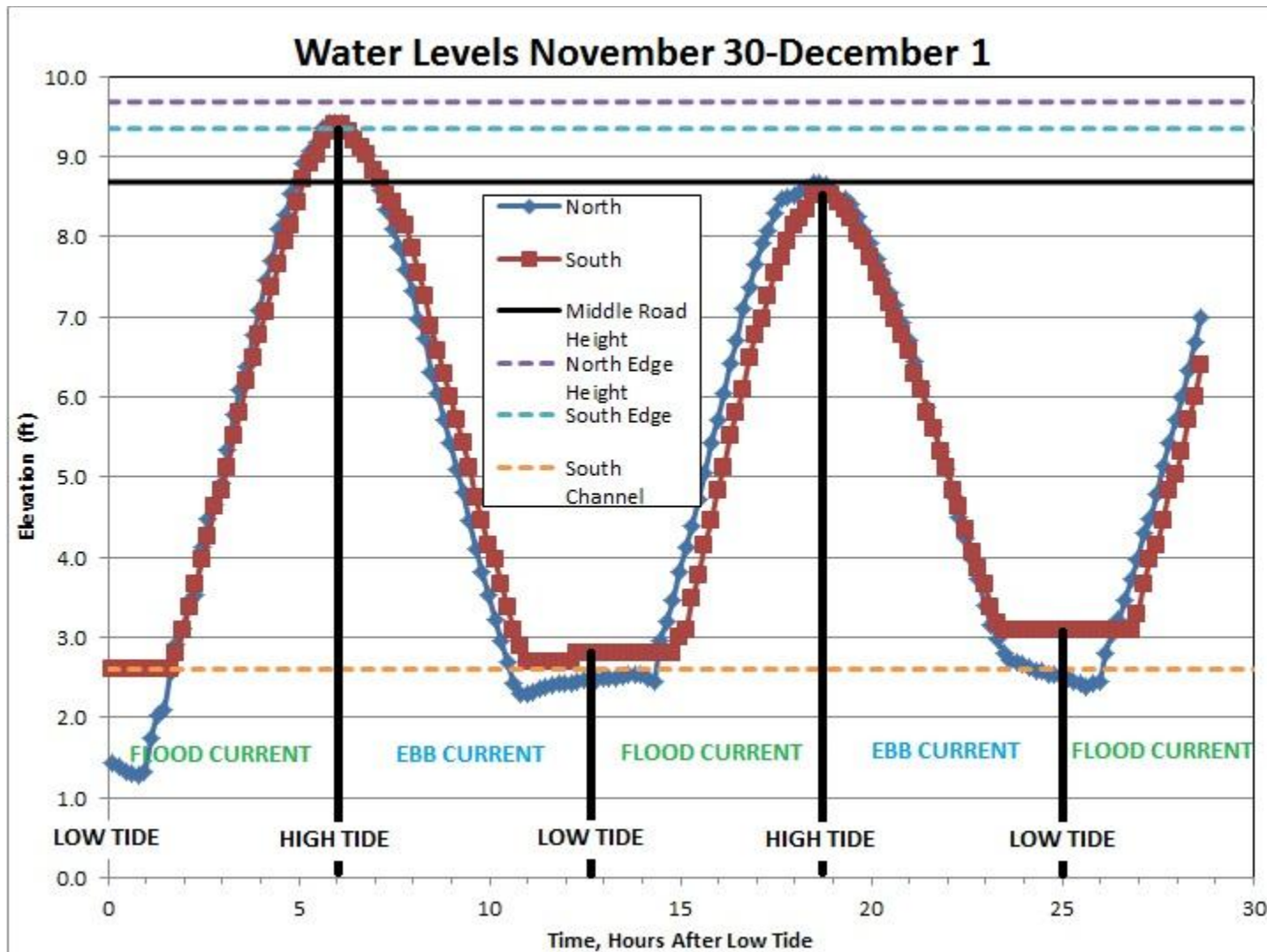

Figure 32: Depth Data for 11/30-12/1

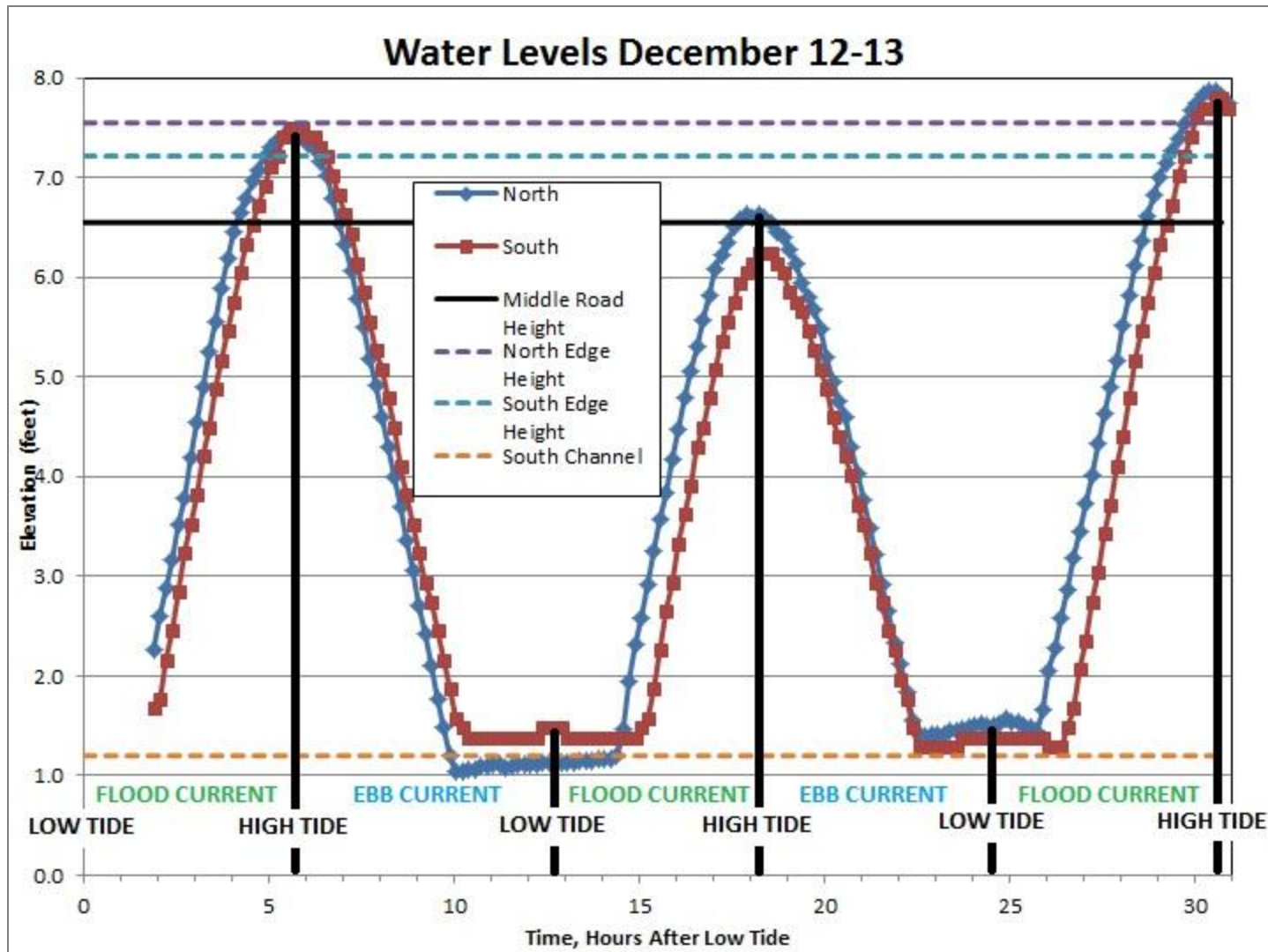

Figure 33: Depth Data for 12/12-12/13

In both Figure 32 and Figure 33, the water surface elevations over time are plotted based on the North channel meter location as the zero elevation mark. As previously mentioned, the meters were not placed at the same elevation each sample day, since the channels are not level and the sample locations varied somewhat each day. This is the reason for the significant difference in depths (8 feet depth to 12 feet) between the two days graphed. Both timescales (x-axes) are the same, plotting time in hours elapsed, beginning with time = zero at low tide. This enabled the comparison between data from different days, since high and low tide do not occur at the same time each day. On both plots, the red lines represent the South channel water surface elevation and the blue lines represent the North. The relative elevations of the mid-road, North road edge, and South road edge are plotted as reference elevations (horizontal lines). Also, the South channel bottom is plotted (orange line) to explain the disparity between the North and South side depths around low tide. The depths on the North side continue to decrease while approaching low tide, while the South line levels off. The line levels off because the depth was zero over this span of time; on the graphs the South channel bottom is not at the zero elevation because the North channel (the zero elevation) is deeper.

It is important to note that at the high tide and low tide marks (black vertical lines) the direction of flow changes over. During flood current, the water flows North to South. During ebb current, the water flows South to North. On both graphs, it is apparent that during flood current, the water levels are higher on the North side than the South side. Alternatively, the water levels on the South side are higher than the North side during ebb current. The conclusion made here is that the inlet channel always has a higher water surface elevation than the outlet channel, except during road overtopping. In fact, the high tide water levels were used as a check for the accuracy of the depth readings, because when the roadway and marsh banks become completely submerged, all of the water is level at one uniform elevation. So, the high tide readings were set to equal each other in order to determine the difference in channel depths. When the elevations of each meter were known based on surveying, the resulting water levels were checked at high tide and did yield the same result. However, when the flow does not overtop the roadway, the high tide levels are not equal between the North and South sides of the culvert. This is apparent with the nighttime high tide peaks, around time = 18 hours. On December 12th, there is a difference of 0.4 feet at the second high tide peak.

The point at which the water surface elevations exceed the black horizontal lines that represent the road elevation signifies the time that water begins to overtop the roadway. The maximum depth of flooded water was determined by subtracting the mid-road height from the high tide water elevation. The flooding depth was 0.8 feet on November 30th and 0.9 feet on December 12th during 9.2-foot and 9.3-foot high tides, respectively. Based on these two graphs, the roadway was flooded for up to three hours per tidal cycle (1.5 hours before and after high tide). The depth data were also used to determine the flowrates through the culvert over time.

4.1.6 Flowrates

Each pair of depth readings was used to determine a flowrate for that time. The various discharge equations were presented in the Methodology (Section 3.3.2). The data were separated into the eight flow categories based on field notes and reference elevations such as the top of the culvert and roadway height. The eight flow categories used in analysis were:

1. Low tide (no flow in culvert)
2. Flood current open channel flow
3. Flood current submerged culvert
4. Flood current submerged culvert with road overtopping
5. High tide (no flow)
6. Ebb current submerged culvert with road overtopping
7. Ebb current submerged culvert
8. Ebb current open channel flow

For the flowrate analysis, only one tidal cycle was plotted for each day. Each of these tidal cycles were then separated into eight the segments. These categories are labeled on the depth and flowrate graphs in Figure 34 and Figure 35 (orange numbers 1-8).

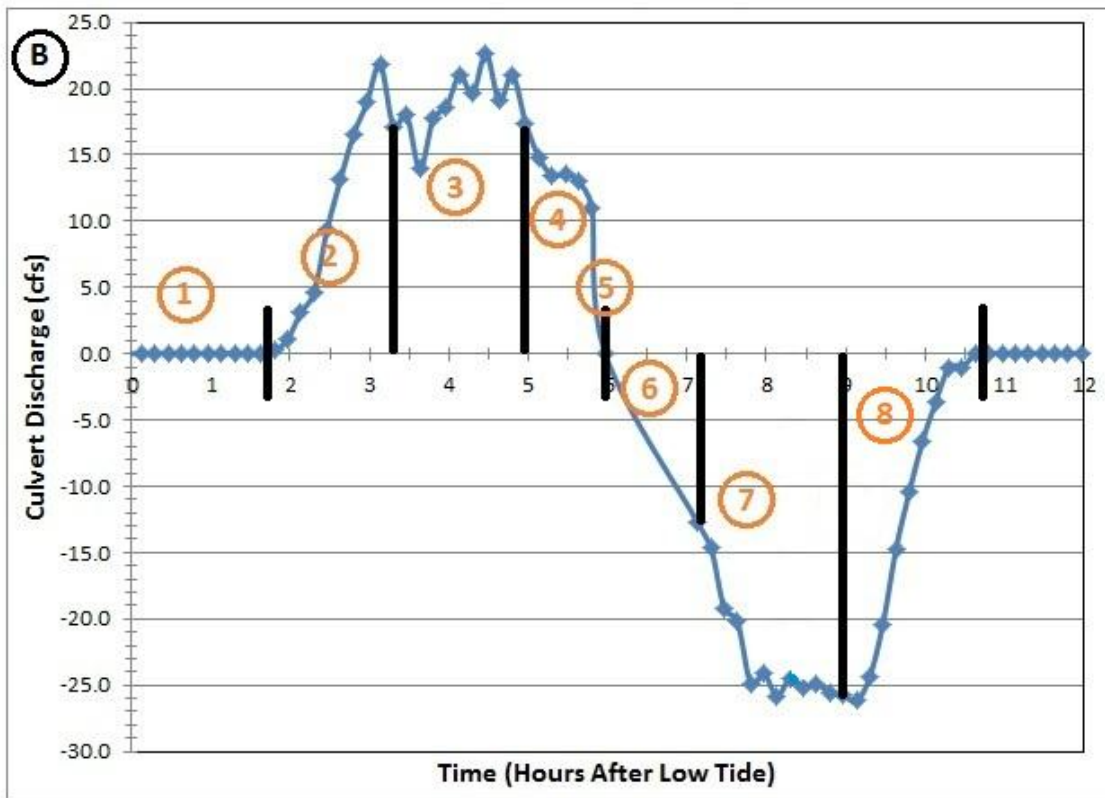
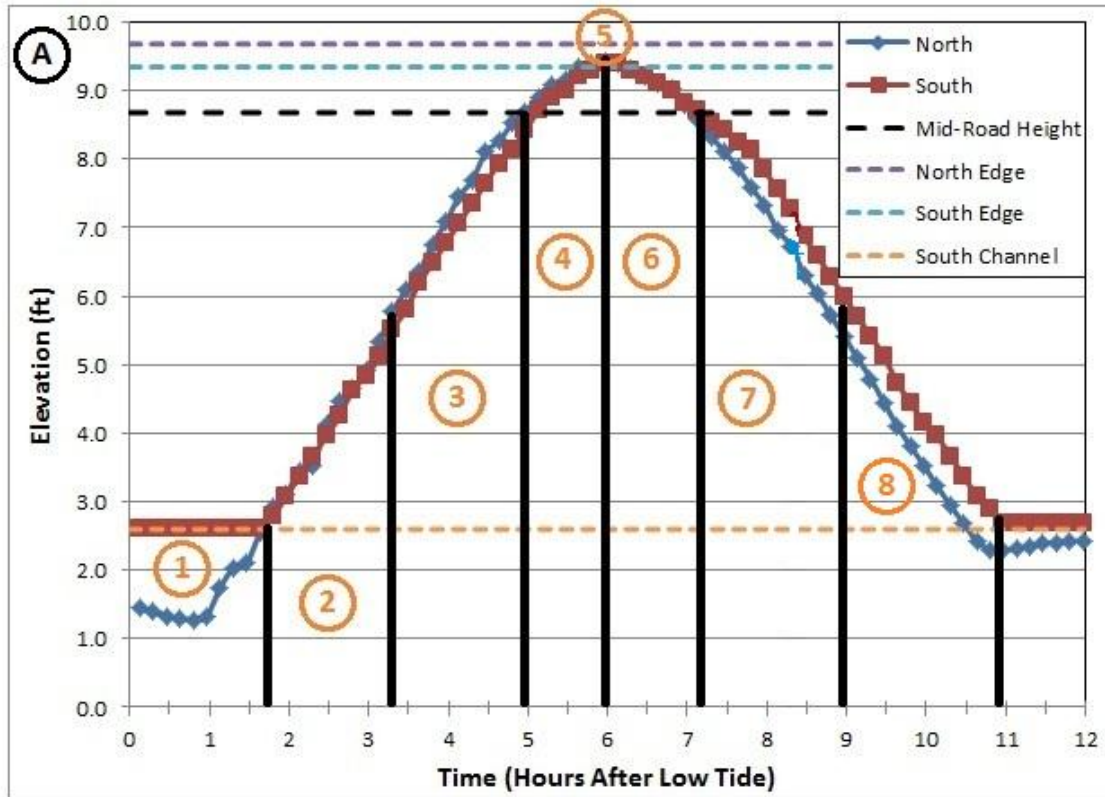

Figure 34: A) Depths Over a Tidal Cycle, and B) Flowrates Over a Tidal Cycle (11/30)

These figures show the correlation between the depths and flowrates over time. At high tide (category 5), the depth graph peaks while the discharge crosses the x-axis at $Q=0$. The North to South flow direction (flood current) was considered the positive direction while South to North flow (ebb current) was considered the negative direction. High tide and low tide were considered to have no flow, so the discharge curve crosses zero at these points. High tide (5) is only a momentary condition; as the tides change, the flow changes direction. This assumption was based on the case of a particle in one direction of motion; when the particle reverses direction, there is a moment of zero velocity as the velocity curve passes from the positive to negative direction.

On November 30th, the peak flowrate in the positive direction was 22.7 cfs, which occurred during submerged conditions (3). The second-highest peak during flood current occurred under open channel flow conditions (2), just before the culvert became submerged. This flowrate was 21.8 cfs. But, the actual peak flow for this date occurred during ebb current, just after the culvert became unsubmerged and entered open channel flow (8). This peak flow was 26.2 cfs in the negative direction.

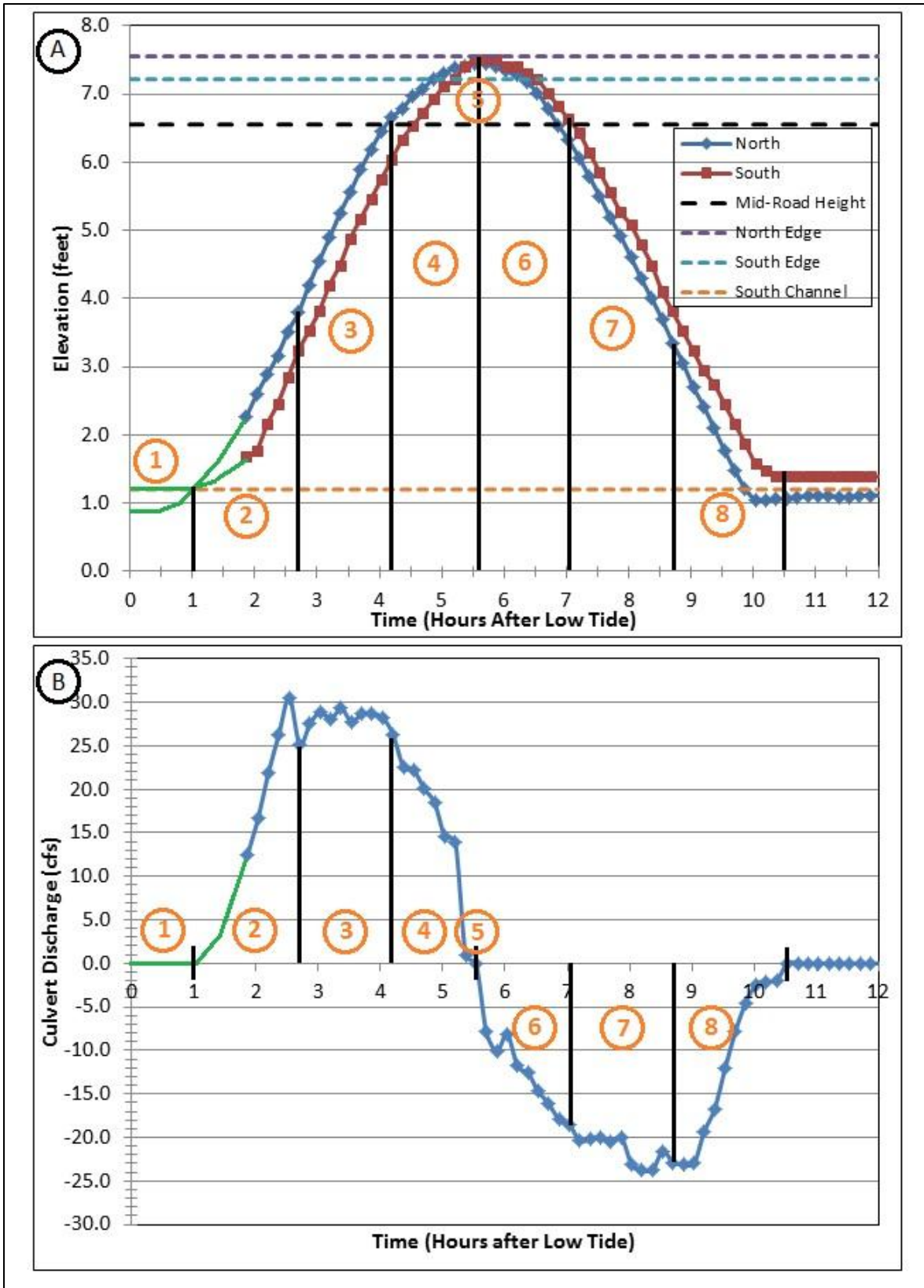

Figure 35: A) Depths Over a Tidal Cycle, and B) Flowrates Over a Tidal Cycle (12/12)

Figure 35- B shows the flowrates that were determined based on the depths over time (Figure 35- A). On December 12th, the peak discharge of 30.5 cfs occurred during open channel flow (2) just before the culvert became submerged. The flowrate remained high and stable within the 25-30 cfs range during submerged conditions. The peak discharge of Culvert 2 on December 12th agrees with the literature regarding culvert performance. Peak discharge is expected when a culvert is 93% full (Chow, 1959). This means that the highest flowrate (and therefore velocity) occurs during open channel flow, at very near-full flow. Figure 36 shows a culvert performance curve of discharge vs. headwater elevation.

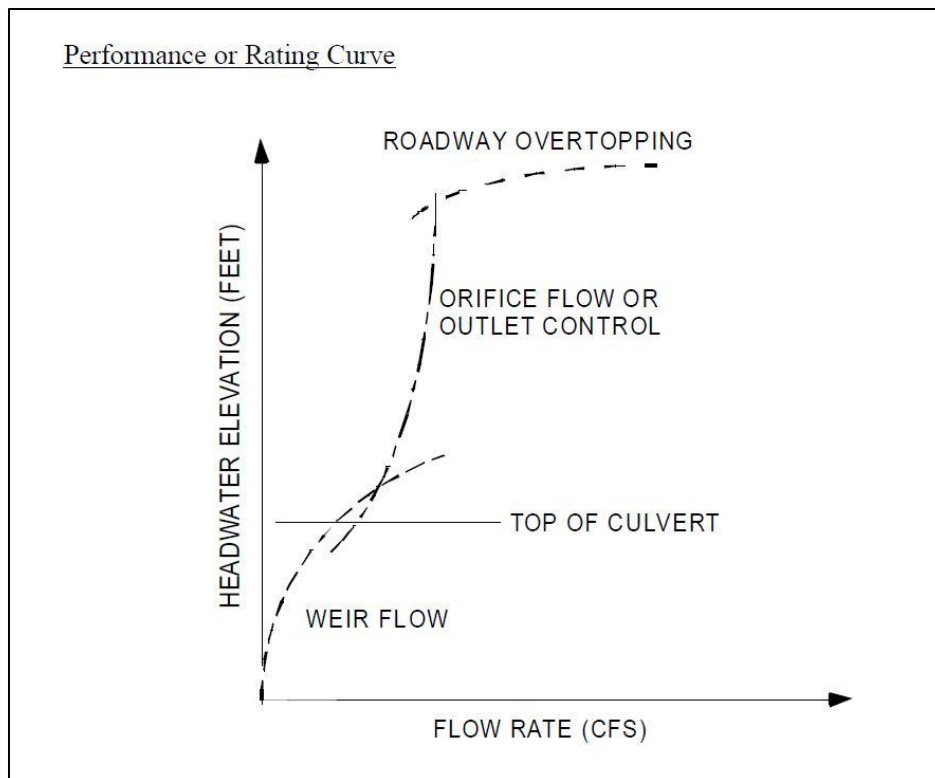

Figure 36: Culvert Performance Curve (Mohtar, 2001)

The performance curve plots discharge in cfs on the x-axis against headwater elevation on the y-axis. “Weir flow” on the curve is synonymous with what is referred to as “open channel flow” in this report. According to the curve, as the headwater reaches the culvert height, the weir flow (open channel flow) discharge is greater than orifice flow (submerged conditions). Once the culvert becomes fully submerged, the orifice flow remains within a small range; the curve does not extend farther to the right (greater flowrate) than the open channel flow curve. Finally, higher flows are reached when road overtopping occurs. Discharge rates during road overtopping were also determined for Culvert 2 on November 30th and December 12th.

Regardless of whether the flow was under open channel or submerged conditions, the driving force for the flow was the hydraulic gradient. The hydraulic gradient is defined as the quantity

$(\frac{\Delta h}{L})$, or the slope of the hydraulic grade line. This driving force is essentially based on gravity, and the nature of water to flow downstream, or down gradient. The conclusion made based on the effect of the hydraulic gradient on the flowrate was that higher flowrates occurred when there was the greatest difference between the inlet and outlet channel water surface levels. For example, the peak flowrate on December 12th of 30.5 cfs occurred with a water surface level difference (Δh) of 0.7 feet. It was determined that there was no specific correlation between tide height or tidal range and the flowrate, but only between the hydraulic gradient and flowrate. The hydraulic gradient is observable on the depth graphs (Figure 34A and Figure 35A) based on the amount of visible space between the data points for depth in the North and South channels at a given time.

In order to decrease the velocity of the flow through the culvert and therefore decrease the scour of the marsh banks and vegetation, the hydraulic gradient must be decreased. The water surface elevation was often a result of a premature backup of flow in the inlet channel, due to insufficient capacity of the culvert. The project team concluded that allowing more flow through the culvert could prevent or at least delay this backup, thus decreasing the high head difference and the flow velocity pushing through the culvert.

Road Overtopping

The methods for applying broad-crested weir flow equations to the water passing over the roadway were explained in detail in Section 3.3.2. In these calculations, the water flowing across the entire roadway during flooding conditions was considered, as well as a smaller control volume 10 feet wide, to represent the section of the road contiguous with the channels at Culvert 2, as if the channels remained intact and flowed directly over the road without overflowing and dispersing water laterally.

For the entire roadway, a width of 1500 feet was assumed. The causeway is 1840 feet long, but not all of it floods during each tidal cycle. An average high tide is about 9 feet, which results in up to 1 foot of flooding over the roadway at Culvert 2. Only during above-average high tides does the section of roadway nearest Macomber's Island (toward Culvert 1) become flooded. During flooding conditions, lower sections of the roadway experience deeper floodwater, while higher sections experience shallower water levels flooding over. All of these variations were simplified in order to apply the weir flow equation. A uniform water surface elevation was assumed along the roadway on the North side and on the South side. The mid-road elevation above Culvert 2 was used as the entire roadway elevation.

Using 1500 feet as the width of the weir, the peak flowrate determined was 1800 cfs with a headwater of 0.74 feet on November 30th. On December 12th the maximum flowrate was 2700 cfs with a headwater of 0.91 feet. The major factor affecting the weir flowrate was the headwater depth, or HW_r as shown in Figure 37.

The flow was also determined considering a 10-foot wide control volume of road. This control volume was chosen based on the approximate width of the channels on either side of Culvert 2. The purpose of doing this calculation was to be able to compare the flows going through Culvert 2 and directly over the culvert within the same approximate channel width. This control volume assumed the channels continued flowing straight over the roadway instead of underneath, and ignored the rest of the flow along the entire length of the road. The maximum flowrate determined through these means was 17 cfs, more comparable to the flows through the pipe.

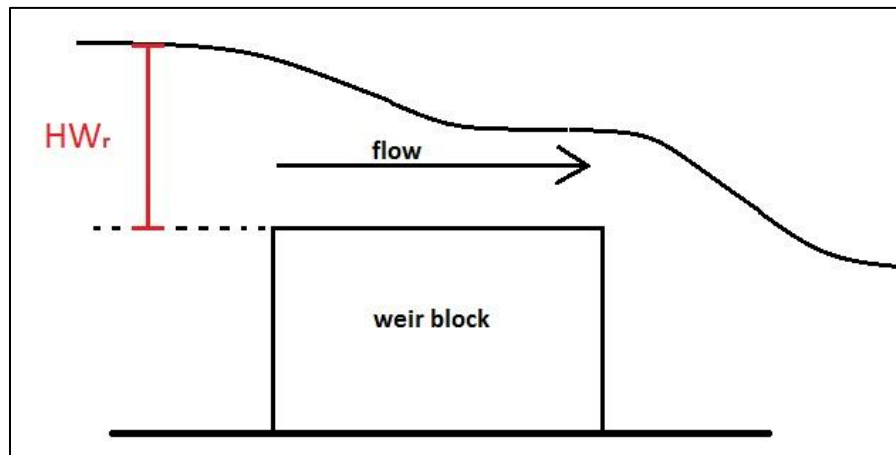

Figure 37: Weir Flow Diagram

4.1.7 Volumes

The final step in the analysis of existing conditions was determining the total volumes flowing through the culverts and over the roadway. By definition, a flowrate is the volume passing through a space over time. Therefore volume is simply the integral of the flowrate. So, the numerical integration of the flowrates over time was completed in order to determine the volumes passing through or over Macomber's Way. The trapezoidal rule was used to approximate the numerical integration by determining the area under the flowrate curve between each set of consecutive data points, and determining the sum. The total volumes for flood current and ebb current were both determined, and compared. For November 30th, it was determined that 220,000 ft³ (5.0 acre-ft) passed through the culvert into the marsh during flood current and 250,000 ft³ (5.7 acre-ft) exited the marsh through the culvert during ebb current. On December 12th, the flood volume was 300,000 ft³ (6.9 acre-ft) and the ebb volume was 270,000 ft³ (6.2 acre-ft).

The volume passing over the 10-foot wide control volume section of roadway was 22,000 ft³ (0.45 acre-ft) flood and 24,000 ft³ (0.54 acre-ft) ebb on November 30th and 40,000 ft³ (0.9 acre-ft) flood and 58,000 ft³ (1.3 acre-ft) ebb on December 12th. For the entire road (assumed 1500 feet length) the volume passing was 3.2 million ft³ (74 acre-ft) flood and 3.6 million ft³ (83 acre-ft) ebb on November 30th, and 6.1 million ft³ (140 acre-ft) flood and 9.2 million ft³ (212 acre-ft) ebb on December 12th.

The tidal prism is defined as the volume fluctuation in an estuary between low tide and high tide, or the total volume entering or exiting the estuary during a tidal cycle. An estimation of this is provided in Equation 21.

Equation 21

$$\textit{Prism Volume} = H * A$$

Where:

H = average tidal range

A = area of basin

The average tidal range for Damon’s Point on the five days sampled was 8.9 feet. Using ArcGIS, the area of the marsh was determined to be 765 acres. Using Equation 21, the tidal prism for the English Salt Marsh is approximately 6800 acre-ft.

Table 7: Summary of Volume Results

Date:		November 30 th		December 12 th	
Volume through culvert	Flood	220,000 ft ³	5.0 acre-ft	300,000 ft ³	6.9 acre-ft
	Ebb	250,000 ft ³	5.7 acre-ft	270,000 ft ³	6.2 acre-ft
10-foot control volume over road	Flood	22,000 ft ³	0.45 acre-ft	40,000 ft ³	0.9 acre-ft
	Ebb	24,000 ft ³	0.54 acre-ft	58,000 ft ³	1.3 acre-ft
Volume over road	Flood	3.2 million ft ³	74 acre-ft	6.1 million ft ³	140 acre-ft
	Ebb	3.6 million ft ³	83 acre-ft	9.2 million ft ³	212 acre-ft
Volume entering per tidal cycle	Flood	3.4 million ft ³	79 acre-ft	6.4 million ft ³	147 acre-ft
	Ebb	3.9 million ft ³	88 acre-ft	9.5 million ft ³	217 acre-ft
Tidal prism of marsh		297 million ft ³			
		6800 acre-ft			

The total volume entering per tidal cycle is the sum of the volume through the culvert and over the entire roadway. The volume results vary greatly between the two days. The two days of data resulted in differing flowrates, which was the basis for the volume calculation. Again, the flowrate calculations were dependent on the hydraulic gradient as determined by the depth readings on either side of the culvert. It must be taken into consideration that when the influx of water overflows the banks and a basin becomes flooded, the general tidal prism models are no longer valid (United States Department of Transportation Federal Highway Division, 2011). The English Salt Marsh becomes flooded twice per day, so the tidal prism estimation is not to be considered completely accurate. It does still serve for an approximate comparison between the size of the marsh and the amount of water entering through or over Macomber’s Way.

The tidal prism for the English Salt Marsh would be a complex calculation to make, considering the two river inputs as well as the tidal flow through New Inlet. Flowrates through the inlet or

the North and South Rivers were not involved in this scope of this project. It is not certain exactly how the tidal water enters and exits the marsh due to the many possible routes of flow.

4.2 Identification of Conceptual Design Options

There are many different conceivable design choices with the potential to solve flooding and erosion problems. However, the final design must not only satisfy the project goal, but also must fit within the site-specific constraints as well as the Accreditation Board for Engineering and Technology (ABET) design criteria. The final design choice was deemed the most cost-effective and feasible solution to the flooding and erosion along Macomber's Way and near the culverts. During the design process, several methods of solving this problem were explored, evaluated, and eventually eliminated until the final design was decided upon. The project goal was twofold: to protect and conserve the natural environment while solving a safety problem for Trouant's Island residents. The final design must be a solution that creates a delicate balance between the two sometimes contrasting ideas. The following design options are discussed in this section:

- Install additional culverts in the road
- Remove Culverts
- Replace Existing Culverts
- Elevate the level of the road
- Build a bridge where the causeway is located
- Install Energy Dissipaters
- Increase Road Maintenance

The design options are discussed in this section and each one is evaluated in Section 4.3.

Through a process of elimination based on cost, regulatory compliance, and applicability to the project goal, the list of design options was narrowed down to the final design. The final recommendations and design specifications are presented in Chapter 5. Before discussing each design option in detail, an overview of the regulatory considerations for the site is presented in Section 4.2.1. Sections 4.2.2 through 4.2.8 provide background information on each design option.

4.2.1 General Regulatory Considerations

There are many laws governing construction in a salt marsh, and every regulation must be considered in order to meet the standards of culvert installation within the Department of Environmental Protection and other agencies' protocols. These guidelines, such as the Wetlands Protection Act, are discussed in the Background Chapter of this report (Section 2.5.1). Aside from complying with the strict regulations that apply to marsh environments, any proposed changes would also need the approval of the Trouant's Island residents, who have ultimate control over any project that alters the causeway. The residents of the island will be affected by any degree of construction and this could create issues. During previous maintenance efforts on the culverts, homeowners complained that the construction made the causeway inaccessible,

keeping people from their homes (Tarbox, 2012). Whichever design is chosen must be implemented carefully and with consent of the residents.

4.2.2 Installation of Additional Culvert

The first design option was to install a third culvert. Additional culverts would allow an increased amount of flow to pass through the road. The purpose of a third culvert would be to channel more water under the roadway, thus preventing it from flowing over the roadway. One major consideration in designing a third culvert is that it must connect to existing channels, since the Wetlands Protection Act prohibits the alteration of the natural marsh environment. With this in mind, the project team considered the best location for a third culvert to be on the eastern portion of the road, near Trouant's Island. It has been observed that this section of Macomber's Way is the first area of the road to begin flooding before each high tide. The design would link channel A with channel B (shown in Figure 38) relieving the backup of water at the second culvert that is caused by the incoming tide.

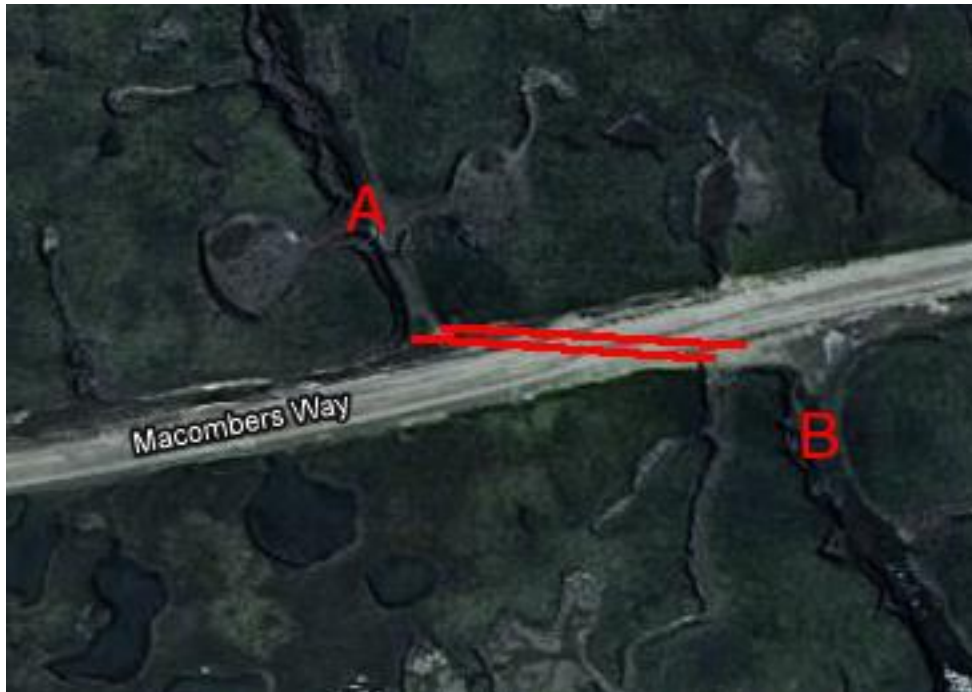

Figure 38: Potential Location for 3rd Culvert (adapted from Google Maps, 2012)

However, this solution also has the potential to create problems for the marsh. It would in fact allow more flow through the road which could delay or prevent some overtopping flow, but increased flow through the road could result in increased scour and widening of the marsh channels. Minimal data were collected at the location for this new proposed culvert. This means most of the analysis is based on qualitative data and observation. In the past, the causeway used a similar culvert design in the same location. This culvert undermined the structure of the road, which led to the collapse of the culvert (Tarbox, 2012).

4.2.3 Removing culverts

Removing the culverts was another option that had been identified by one of the residents of the island. The culverts have been the primary cause of the increasing scour and the widening of the channels, so removing the culverts would hopefully eliminate the problems they are causing.

However, removing the culverts can be potentially dangerous for the marsh as the drastic change could cause more erosion and bank scour. The construction would also be very time-consuming. Once the culverts are removed, the voids left from the culverts would need to be filled in so residents can still safely use the roadway. Removing the culverts would likely cause the tidal flows to flood over the roadway sooner and at increased volumes than with the existing culverts.

4.2.4 Replacing Existing Culvert

Another solution is to replace one or both of the culverts. The second culvert was determined to be the cause of the most damage to the channels, so replacing it with an appropriate alternative culvert design could simultaneously make the road safer while reducing the scour on the surrounding channels.

The new culvert would need to allow a high volume to pass through while keeping the velocity below the critical erosion velocity for the marsh. This will reduce scour on the surrounding channels while maintaining the structure and safety of the road.

However, the culvert may prove to create more issues for the marsh than solutions. As previously mentioned, when the second culvert was replaced in 1999, the new culvert allowed higher volumes to pass through, which widened the channels and increased the scour potential of the flows. The culvert design must factor in the protection of the marsh as well as the safety of the island residents.

4.2.5 Raise the road

One of the main issues with Macomber's Way is the flooding, which could be mitigated by raising the height of the road. Since the road is frequently covered in 6 to 12 inches of water on average, an obvious solution would be to raise the height of the entire roadway by adding to the material on the road surface.

4.2.6 Build a bridge

A bridge would provide safe travel to and from the island, as the risk of getting caught in a flood would be essentially eliminated. However, during construction periods, the causeway would be potentially unusable, which would prevent or limit access to homes for residents and could be very dangerous if anyone attempted to use the road. The potential for bridge collapse is also a major safety concern. The erosive action of flowing water, high rates of discharge, and the movement of ice can be adversely affected by bridges and cause environmental damage, flooding, great expense in loss of property and even loss of human life in the most extreme cases.

Building a bridge would greatly decrease the travel time to and from the island and would be a safer means of travel. The construction would be long and arduous, however, and islanders would likely not want to be hindered by it. The residents also may not approve of the construction of a bridge, as it would change the aesthetics of the salt marsh and area.

All statutory requirements would need to be met and approvals would have to be obtained from any jurisdictional authorities such as the DEP before beginning construction.

4.2.7 Energy Dissipaters

Relative to the other options, implementing energy dissipation is inexpensive. Large rocks can be used to create hydraulic jumps, and large gravel and small stones can be used for riprap. The cost of energy dissipaters can vary greatly, due to the many different kinds available and the variety of materials used to construct them.

Adding energy dissipaters would decrease the velocity of the water and scour potential. Energy dissipaters can be placed in any of the channels or the culvert outlets. Installing energy dissipaters can be quite simple or complex, depending on the number and type of dissipaters used.

4.2.8 Increased Road Maintenance

The last potential solution for Macomber's Way would be to leave the culverts alone and simply focus on keeping the causeway safe and maintained. Currently the road is in a state of disrepair as a side channel leading to the second culvert has been compromising the integrity of the road. The channel is slowly eroding the banks of the roadway, which is causing portions of the road to slump into the open channel.

It has been observed that the road floods unevenly, flooding first at the area outside of Trouant's Island and in a few other spots. This initial rush of water over the road is highly violent, and the erosion caused is exacerbated because it is in such a concentrated area. A larger area would reduce the velocity of the overland flow. Therefore, by making the road elevation as even as possible, the violent overland flow would harm the roadway less because it would overtop the road uniformly along its entire length. Keep in mind, the causeway is not allowed to be at an elevation above that of the marsh banks, so care must be taken when leveling the roadway.

4.3 Evaluation of Design Options

Based on the ABET criteria and their applicability at this site, each design was ranked based on how well it fit within the following constraints: economic, environmental, health and safety, social, and political. Finally, an overall rating was given to each option. Table 8 outlines the results of this process.

Table 8: Design Options Evaluation

	Economic (Cost)	Environment	Constructability	Health and Safety	Social	Political	Overall
Additional Culvert	Medium	Good	Moderate	Safe	Good	Good	Good
Removing Culverts	Medium	Bad	Moderate	Not Safe	Poor	Poor	Bad
Replace Existing Culvert	Medium	Good	Moderate	Safe	Good	Good	Good
Elevate Road	Low	Good	Easy	Not Safe	Very Poor	Very Poor	Bad
Build a Bridge	High	Bad	Difficult	Safe	Very Poor	Very Poor	Bad
Energy Dissipaters	Low	Good	Easy	Safe	Good	Moderate	Good
Road Maintenance	Low	Good	Easy	Safe	Good	Good	Good

4.3.1 Installation of Additional Culvert

The installation of culverts could relieve the flows going into the channel that flows adjacent to the North side of the road near the second culvert and delay flooding down the road, making transport across the road safer. An additional culvert is not guaranteed to mitigate the flooding of the causeway or the erosion of the marsh, though. In some cases, allowing additional flow to pass through results in more flow than desired toward the culvert. When Culvert 2 was changed from a 2-foot to a 3-foot diameter culvert, the increased capacity resulted in a massive increase in flows toward that area, which eroded and widened the nearby channels. Significant research is necessary before designing a culvert, because the proper size must be chosen to allow enough, and not too much, flow through the road.

The culvert would be a concrete box culvert with a height of 2 feet and a width of 3 feet and a length of 65 feet. While concrete is vulnerable to corrosion from the high salinity water, salt-tolerant concrete can be used and the internal reinforcement bars can be epoxy coated to further protect from salt corrosion (Ammann, Hoey, Lang, & Linvill, 1999). In order to properly connect the adjacent channels, the new culvert would need to be angled which does not comply with the standards set forth by the Department of Transportation, but may be the solution for this site. The culvert could be placed perpendicular to the causeway, but this would not direct flow from the primary channels, which would require new channels to be opened. Concrete box culverts can be manufactured with angled joints and mitered ends, which would help the tidal flows through the angled culvert.

The installation for this culvert would be more difficult than the typical culvert installation as 65 feet of the road needs to be excavated. Also the length of the culvert may prove to structurally

compromise the causeway. The construction period would cause problems for the residents and for the construction company installing the culvert. Since the marsh becomes flooded twice daily, a long installation period means more complications caused by rising tides. Of course, a study must be performed at the site of the proposed culvert, monitoring the depths and flowrates in a similar manner to how the conditions at Culvert 2 were monitored during this project. The existing conditions of the channels there will dictate the design; the culvert would be angled as shown in Figure 38 to accommodate the natural marsh channels that already exist.

4.3.2 Removing Culverts

While the culverts are causing the issues for the causeway, removing them would create even more issues for the road. For about 2/3 of the tidal cycle, the water elevation is below the road height. With no culverts in the road, there would be a severe backup of water on the northern side of the marsh. This would cause violent overtopping of the causeway, resulting in erosion and increased damage to the road surface and the cars driving across it.

This plan would be especially damaging to the estuary ecosystem because the natural tidal flow would be completely interrupted. This would increase the amount of stagnant pools in the marsh and harm the local wildlife with the rapid change in flow conditions.

4.3.3 Replace Existing Culvert

The second culvert should be replaced with a box shaped culvert, because they are the best design for this type of situation.

Box culverts are practical and cost-effective. They are easy to install, as they are normally pre-cast or modular, decreasing overall costs. Box culverts have high load-bearing capacities and function similarly to bridges without having the need for decks or joints at the road surface.

Metal culvert materials are inexpensive and the costs can be further reduced as the diameter is increased (Weilding, 2012). As such, a steel or aluminized box culvert would be one of the best options economically. However, if the culvert is installed in a road that experiences significant overtopping, the metal culvert is at high risk of collapsing. A proper galvanized culvert decreases this risk, but it may be wise to use alternative materials to ensure the long life of the new culvert.

In the past, concrete culverts have failed when placed into a tidal setting, but salt-tolerant concrete can be used and the internal reinforcement bars can be epoxy-coated to further protect the culvert from salt corrosion. The overall strength and life expectancy of concrete culverts makes concrete the ideal material for this situation.

One of the benefits of box culverts is that they can be designed with three sides, which allows for the culvert to have a natural channel bottom. The natural bottom can help restore natural tidal flow while allowing the culvert dimensions to adjust when tidal flow changes. Box culverts also generally have a wide span and a low rise. A wide span will help to further restore the natural

tidal cycle and will allow the water to flow unrestricted. The low rise is also an advantage because the road has an electrical cable 2 feet beneath its surface.

The modular nature of box culverts also decreases the amount of time needed for installation, as well as the necessity for delays or detours while the culvert is installed in the roadway. As with any construction along the causeway, paying proper attention to the tides will be necessary. The layout options are flexible, and long clear spans allow for the crossing of sensitive areas with minimal or no impact.

4.3.4 Elevate Road

The cost of raising the roadway could be great indeed, because it would require trucking out a large quantity of gravel in order to raise the roadway, as well as needing equipment to grade and level the road. The time necessary to grade and level the road would also be an issue of concern as work could only be performed during periods of lower tide and any gravel added could be washed by natural high tide.

Currently, a good portion of the tidal cycle occurs when the water is above the road height and a large volume of water enters the marsh by flowing over the road. Raising the roadway would block tidal flows into the marsh, increase the backup of water on the North side of the culvert, and increase the volume of water being pushed through the culverts. This would lead to increased scour and erosion in the channels surrounding the culverts. The gravel on the roadway would also be washed away by naturally occurring flow over the top of the road, contributing to sediment deposition and raising the channel bed height.

The biggest reason that raising the roadway is not a viable solution is that the DEP's Order of Conditions for the site does not allow elevating the roadway above the level of the marsh banks. Without significant revisions to their regulations or going through a lengthy appeals process, raising the roadway could never be a feasible option (Order of Conditions, MA DEP).

4.3.5 Build a Bridge

Building a bridge is a fairly logical solution for Macomber's Way, but there are a lot of implications for undertaking such a project. The large amount of construction necessary to build a bridge along the length of the causeway would be very expensive, especially since the town does not fund maintenance of the road. However, the economic benefit of shortening the travel time between the two islands and eliminating potential water damage to cars cannot be denied.

Building a bridge would be the best environmental option, as it does not alter the natural flow regime in the marsh channels. A bridge also would not contribute to scour and would be safe for travel if it were elevated properly above the marsh. Fish migration would also not be hindered by a bridge because the streambed is not disturbed and the natural flow velocities should maintain a level that does not disturb the fish. However, constructing the bridge would be very harmful to the marsh. The change resulting from the removal of the causeway to make space for the bridge would disrupt the tidal flow of the marsh. The flows would eventually equalize to the new

conditions resulting from the bridge installation. At that point the bridge would be very safe and wouldn't harm the marsh, but the damage and disruption caused by the bridge installation outweighs the future benefits of the bridge.

There are many design constraints to consider when building a bridge, such as: location and alignment, height and waterway opening, road approaches, and pier and abutment details. If construction procedures cause partial blockage of the waterway, the consequences of high flows or ice runs during the construction period may be extremely damaging to the marsh. Provisions will need to be made to remove the current structures in the causeway. Attention must also be paid to scour and insuring that the bridge supports will be able to withstand it. The time and equipment necessary to construct, as with the other options, are also a matter of concern. Because large construction vehicles would be necessary, accessing the roadway could be problematic. Construction would also have to occur during low tide periods only for the safety of the workers and machinery.

4.3.6 Energy Dissipaters

Although there are countless options for types and materials of energy dissipaters, not all types can be used in the bidirectional culverts of the roadway. The installation of any dissipaters could affect fish migration or the channel characteristics depending on the installation process.

Energy dissipaters would have minimal impact in terms of health and safety, although implementing them may improve the flow along the road and thereby increase the safety of travel across the road.

The installation of energy dissipaters could be as simple as placing rocks to create natural hydraulic jumps or as complex as constructing and setting up impact energy dissipaters with splash guards, baffles and deflectors. Depending on the type of energy dissipaters chosen and the time it takes to install them, the residents of the island could be upset about construction and hampering their ability to travel across the roadway.

As with any construction or modification to the area, all statutory requirements would need to be met and approvals would have to be obtained from any jurisdictional authorities such as the DEP prior to starting.

4.3.7 Road Improvement and Increased Maintenance

Increased road maintenance is a very logical and easily implemented design solution. By creating uniform conditions along the edge of the roadway, the overtopping of the road will be less violent and will erode the surrounding marsh banks less than before. The less violent overtopping would also create safer conditions for drivers, as the velocity of the water over the roadway would decrease.

The blocks shown in Figure 39 act as hydraulic jumps to reduce the intensity of the flow moving over the road surface. However, these blocks are only present at certain sections of the road.

Most sections use large stones to fulfill the same need as the stone blocks, but the large stones are not as efficient in controlling flow as the blocks are. The stones may slow the flow of water, but the water also flows between and around the stones, which can increase velocity and erosion. Adding these stone blocks to the entire northern side of the causeway will increase stability, which may reduce the impact of that erosive side channel. It will also establish uniformity to the northern side of the road that will help control the overtopping of the road. While it is true that the road must be pitched to some degree in order to facilitate runoff of water, this does not mean that uniformity of the roadway needs to be sacrificed (Order of Conditions 2011).



Figure 39: Uneven flooding conditions near Stone Blocks (Stitt, 2011)

The proposed additions to the road are very cheap compared to the other potential designs in this section. This road maintenance project would also be easy to implement as the construction would be a quick process and would not bother the residents. This program can also be combined with any of the other design solutions to create a bundled plan with a greater rate of success.

There aren't many disadvantages to the road maintenance plan. One issue would be the frequency of the maintenance. If the road is being worked on frequently, this may interfere with the travel of residents as they use the roadway. If the road is not carefully maintained there may be potential for the roadway to slump into a side channel during repairs. It must be a priority for the workers maintaining the road to ensure a uniform elevation while preserving the structural integrity.

Regulatory Considerations for Culvert Options

Culverts are one of the most cost-effective options, but there are a wide range of sizes and shapes of culverts that can be implemented depending on the situation. The numerous different types of materials that can be used: steel, plastic, stone, etc. must also be taken into consideration.

Typically, in a salt marsh setting, only steel and plastic culverts should be considered as concrete and stone culverts are subject to erosion and corrosion from the high salinity of the water.

However, culverts can be chemically treated to resist corrosion and the rebar inside the concrete can also be coated with an epoxy that will prevent oxidation and corrosion. Construction costs could be high depending on the type and number of culverts installed and the difficulty of installation. They can also be considered inexpensive if designed and installed properly and in suitable locations.

Most culverts inherently cause significant alteration or loss of sections of the natural channel bed. With more culverts, more flow volume is allowed to pass through the causeway, which can significantly widen the channels in the marsh (Tarbox, 2012). This channel widening can cause damage to the marsh and can undermine the stability of Macomber's Way. Culverts can also hinder fish migrations in cases where the water level in the culvert is too shallow or the flow is too turbulent. In order to be successful, a culvert must be capable of resisting erosion without creating adverse effects on the local wildlife and the channels upstream or downstream of it.

The location of the culvert is one of the key design specifications. According to the State of Wisconsin Department of Transportation:

“The culvert location should be selected so the culvert passes the expected discharge with as little interruption as practical. Where water is confined in a channel, the culvert should be located at or near the point where the channel reaches the project and as much in line with the channel as possible. Where other considerations indicate a less desirable location, the roadbed and special ditch must be protected against turbulence generated by the change in direction of flow” (Wisconsin Department of Transportation, 2010).

Since the causeway becomes submerged during high tide, the culverts can only be constructed during periods of low tide and most likely in the months of dryer, warmer weather. With past culvert installations, two backhoes had to be placed on either side of the installation site while two dump trucks transported soil away from the site (Tarbox, 2012). The size of the culverts, materials used, and possible necessity of large construction equipment such as a backhoe are more potential hindrances to constructability.

5. Conclusions and Recommendations

The final design was developed based on the analysis of existing conditions and the evaluation of the design options as described in Section 4.3. Ultimately, the conclusion was made that the flooding of Macomber's Way cannot be prevented without raising the roadway above the maximum allowable height, or excavating the causeway and replacing it with a bridge. Both of these options would violate the regulations posed by the DEP Order of Conditions for the roadway and the Wetlands Protection Act. The bridge would also be the most expensive solution, likely the exceeding feasible budget for Trouant's Island. So, the solutions that fit within the regulatory constraints of the site while having the best potential to decrease flooding while mitigating local erosion was chosen. The final recommendation includes three steps:

- 1. Replace Culvert 2 with a concrete box culvert**
- 2. Implement a road maintenance plan**
- 3. Consider future installation of a third culvert**

The design specifications of the replacement culvert are provided in this chapter, as well as details on the road maintenance plan. It is recommended that the Culvert 2 replacement and increased road maintenance begin right away. Before the third culvert is installed, the project team recommends that the effects of the new box culvert (Culvert 2) be monitored and assessed, to ensure that an additional culvert would be a worthwhile endeavor. Installing an additional culvert would increase the cost to Island Residents and increase the amount of time the marsh environment is disrupted during construction. For these reasons, an evaluation of Culvert 2 after installation will be important in order to justify the construction and expense associated with an additional culvert. Further detail is provided regarding the projected third culvert design, as well as the design for Culvert 2 and the road maintenance, in the later sections of this chapter.

5.1 Culvert 2 Design

The conclusion was made that replacing Culvert 2 would be one of the best design solutions based on the projected effects and cost, but the specifications required further research and calculation. The two culverts in Macomber's Way currently are corrugated metal or plastic pipe culverts. Noting how ineffective the pipe culverts are and weighing the other options, it has been decided that box culverts would be the best replacement.

A main difference between box culverts and circular culverts is that box culverts can provide a large cross-sectional area without needed a high clearance. These culverts have an arch or a rectangular shape, which allows for more variety in sizing than the more limiting circular shape of a pipe. Due to their ability to provide larger areas for flow, box culverts can allow full tidal flow in some cases. This in turn can lead to a more saline environment, promoting the growth of native species instead of invasive species such as phragmites which thrive in less saline environments. Box culverts are one of the most cost-effective options because they can be pre-cast or modular, allowing for decreased construction time and costs. The flexibility in design

options allows for culverts that fit within the right-of-way. Box culverts can also accommodate a curve or skew as needed. Box culverts may also be three-sided, which allows the natural channel bed to be maintained at the crossing. Unlike pipes and corrugated steel assemblies, box culverts can be designed to carry vertical load without the relieving effect of side pressure. By comparison with arched or circular sections no flow area is lost through either excessive spacing apart or curved profiles. In designing the replacement box culvert, the material to be used, the loading rate on the culvert, the backfill requirements, and the size of the culvert have all been analyzed.

5.1.1 Materials

In choosing which material to use, there are certain things to consider, such as: cost, span, discharge, climate, and regulatory constraints. When it comes to three-sided box culverts (Figure 40) or arch culverts, two main materials are used: metal and concrete.

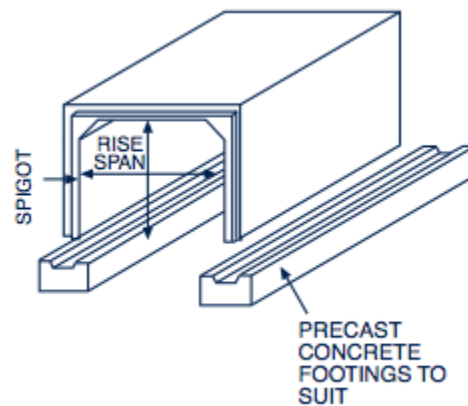

Figure 40: Three-sided box culvert (Shaw Precast Solutions, 2012)

Pre-cast metal box culverts are durable and cost-effective, with a modular design that allows for quick installation. This in turn means decreased overall costs, delays, and detours associated with construction. The ability to put them in place quickly means that backfilling operations can begin in a matter of hours (CONTECH Engineered Solutions, 2012). Steel is the most recycled material in the world, and these culverts can be built with up to 80% recycled content (Bendo, 2007). Metal is susceptible to corrosion however, and can fail dramatically if there is any road overtopping (Porior Engineering, LLC, 2010) or may collapse if not properly coated (Weilding, 2012). This is a major concern for a culvert in Macomber’s Way, which would become submerged very often.

Concrete has high durability under the majority of environmental conditions, higher resistance to corrosion and damage from debris, greater hydraulic efficiency and generally longer life spans (New York Department of Transportation, 1996). Concrete can be more cost effective than metal and is preferred at sites with overtopping risks, like this one. Concrete is ideal under a roadway

because there is no minimum cover requirement in most cases. The strength of pre-cast concrete gradually increases over time, boosting its longevity and endurance. The load-carrying capacity of pre-cast concrete is derived from its own structural qualities and does not rely on the strength or quality of the surrounding backfill materials (American Concrete Industries, Inc., 2011). Pre-cast concrete is nontoxic, environmentally safe and made from all-natural materials (American Concrete Industries, Inc., 2011). This is a key feature in the fragile salt marsh ecosystem. The largest disadvantage of pre-cast concrete is that it can potentially be worn away unless salt tolerant concrete and epoxy treated reinforcement bars are used, creating an increase in cost. Box culverts of this type have been used to replace outdated circular culverts in Little River Salt Marsh in North Hampton and Hampton, NH (Ammann, Hoey, Lang, & Linvill, 1999), restoring many acres of salt marsh and relieving flooding to nearby homes.

Given that the Macomber's Ridge causeway is subject to overtopping, using a metal box culvert is not a safe option. Pre-cast concrete box culverts have many advantages, and have been used in application in other salt marshes, making them the logical choice. A further analysis for the concrete box culvert will be provided in this chapter, including the specification of the size.

5.1.2 Loading rate

The culvert sizes that remain options for the final design after eliminating those with velocity greater than the critical erosion velocity all have a span within the range of 6 to 14 feet, so Equation 16 was valid to use to determine the loading rate on the causeway. Due to the power cable that runs through and along the causeway, the depth of fill will be 3 feet in all cases. This results in a load of about 767 plf. Pre-cast concrete box culverts are manufactured according to design specifications according based on the requirements of the project, and a culvert with an 8-foot span and 4-foot rise can support a load of 2800 plf (Kistner Concrete Products, Inc., 2004). Holding that the weight per linear foot increases linearly by 200 plf as the rise increases by 1-foot (see

Figure 41), the load that an 8' x 3' culvert can support is 2600 plf, which is significantly greater than the estimated load of 767 plf.



Weight Index For Available Box Culvert Sizes

Weight Per Linear Foot For Available Box Culvert Sizes

Span	Rise												
	4'	5'	6'	7'	8'	9'	10'	11'	12'	W	T	B	H
6'	2056	2231	2406							7"	7"	7"	7"
7'	2600	2800	3000	3200						8"	8"	8"	8"
8'	2800	3000	3200	3400	3600					8"	8"	8"	8"
9'	3431	3656	3881	4106	4331	4556				9"	9"	9"	9"
10'	4125	4375	4625	4875	5125	5375	5625			10"	10"	10"	10"
11'	4881	5156	5431	5706	5981	6256	6531	6806		11"	11"	11"	11"
12'	5700	6000	6300	6600	6900	7200	7500	7800	8100	12"	12"	12"	12"
13'	6000	6300	6600	6900	7200	7500	7800	8100	8400	12"	12"	12"	12"
14'	6300	6600	6900	7200	7500	7800	8100	8400	8700	12"	12"	12"	12"
15'	6600	6900	7200	7500	7800	8100	8400	8700	9000	12"	12"	12"	12"
16'	6900	7200	7500	7800	8100	8400	8700	9000	9300	12"	12"	12"	12"
17'	7200	7500	7800	8100	8400	8700	9000	9300	9600	12"	12"	12"	12"
18'	7500	7800	8100	8400	8700	9000	9300	9600	9900	12"	12"	12"	12"
19'	7800	8100	8400	8700	9000	9300	9600	9900	10200	12"	12"	12"	12"
20'	8100	8400	8700	9000	9300	9600	9900	10200	10500	12"	12"	12"	12"
21'	8400	8700	9000	9300	9600	9900	10200	10500	10800	12"	14"	14"	12"
22'	8700	9000	9300	9600	9900	10200	10500	10800	11100	12"	14"	14"	12"
23'	9000	9300	9600	9900	10200	10500	10800	11100	11400	12"	14"	14"	12"
24'	9300	9600	9900	10200	10500	10800	11100	11400	11700	12"	14"	14"	12"

Box Culvert sections are manufactured to specifications according to specific project requirements.
 Weights are for estimating purposes only due to variations of wall, top, base, and haunch dimensions according to specific project requirements.
 Actual weights cannot be determined until final drawings are approved.
 Weights (pounds per foot) in above red area denote less than standard 7'6" sections
 note: Manufacturer Restriction- Max Piece Weight 30 ton

Figure 41: Load Capacities for Various Culvert Sizes (Kistner Concrete Products, Inc., 2004)

5.1.3 Backfill

The material currently used to backfill the roadway is a combination of 3"-5" riprap, 1-1/2" Crusher Run, 3/4" Crusher Run and 3/4" stone (Tarbox, 2012). As this mix has been approved by the DEP, it will continue to be used in the new design. The riprap will be applied in areas where there is strong cross current from incoming or ebbing tidal activity, such as at the channels that run perpendicular to the causeway. Crusher Run is a mixed grade of mostly small crushed stone in a matrix of crushed limestone powder. The 1-1/2" (in which the largest stone is 1-1/2" and the rest is composed of the finer bits from the crushing operation) Crusher Run will be placed at areas with strong ebb tides to resist the vacuum effect created by the tide. The 3/4" Crusher Run will be placed on top of the culvert. It contains many fines and allows for easy crowning of the road bed by a grader. The stone is clean and crushed. Using crushed stone over natural stone is very important. With crushed stone, the angular and jagged edges of the stone locks in and binds together better than the smooth edges of natural stone. The stone is laid to top dress the graded 3/4" Crusher Run after it has been densely packed. After evenly spreading a thin layer of the stone across the road, a large vibratory drum roller is used to dense pack the stone. This method is used to prevent the finer particles from being washed off the road by rapid cross currents.

5.1.4 Hydraulic Design and Sizing

Utilizing the peak observed flow rate of 30.5 cfs, the velocity was determined by dividing this value by the respective trial areas. The results of the basic calculations (see Table 9) show that any box culvert with a width less than 6 feet will produce a velocity greater than the critical erosion velocity, and therefore will not be considered in the final design.

Table 9: Velocity at Design Q for Trial Sizes

Trial Sizes	Area	Velocity with Q = 30.5 cfs
3' x 3'	9 ft ²	3.39 ft/s
4' x 3'	12 ft ²	2.54 ft/s
5' x 3'	15 ft ²	2.03 ft/s
6' x 3'	18 ft ²	1.69 ft/s
7' x 3'	21 ft ²	1.45 ft/s
8' x 3'	24 ft ²	1.27 ft/s
9' x 3'	27 ft ²	1.13 ft/s
10' x 3'	30 ft ²	1.02 ft/s

A nomograph was then used to determine the headwater for each size culvert. The results were higher when assuming inlet control, thus making inlet control the governing design condition moving forward. The nomograph with the lines drawn out for each culvert size is presented in the Appendix Section 7.9.

The next step in determining the culvert size was to set the minimum allowable headwater equal to the road height. For this procedure, a maximum allowable headwater of 6 feet was used. The 10-year storm conditions were applied as the design flow, which was 200 cfs. The 8-foot, 9-foot, and 10-foot span culverts all had headwater less than 6 feet. The recommended practice is to design for the smallest culvert that meets the design requirements, since smaller means less material necessary and therefore less cost. Based on the 10-year storm flowrate conditions, the 8 feet by 3 feet culvert was the resulting design choice, with a headwater of 5.64 feet. This culvert

yielded a 1.27 ft/s velocity under the existing peak discharge of 30.5 cfs, which is a small velocity and under the critical erosion velocity.

Although the 10-by-3-foot culvert was found to have a maximum headwater depth of 4.2-feet for the 10-year storm and 5.25-feet for the 100-year storm (270 cfs), designing for the 100-year storm was not necessary. Both of these values are in fact lower than the maximum which was set at 6 feet of headwater, but the 10-year storm was chosen as the design parameter and the 8-foot culvert was the apparent choice. The exit velocity of the 8 by 3 culvert under design flow conditions would be 8.33 ft/s. This velocity is relatively high, so riprap and armoring should be placed along the length of the culvert bottom, along with energy dissipaters at the entrances and exits, to mitigate the effects of bank degradation.

5.1.5 Cost Analysis

Though the 8-foot by 3-foot culvert is the least expensive size that can be used while still maintaining the design standards, concrete box culverts, especially at a non-standard size such as this, are still costly. Pricing from August 2010 puts the cost per foot of an eight foot span at \$450 per linear foot (The New England Environmental Finance Center, 2010). With a 27-foot long culvert, this puts the cost at \$12,600. The Financial Impact Assessment tool and data provided by the New England Environmental Finance Center were used in determining the combined cost of traffic control, erosion control, riprap, excavation/removal of the existing pipe, footings, structural backfill, mobilization, and miscellaneous cleanup at about \$12, 500 (The New England Environmental Finance Center, 2010). This puts the cost of the project at \$25, 100, though this price is an estimate. The setting of the causeway could vary the construction costs by up to 50% due to there being no need for paving, a lesser lane width than standard roadways, a very low traffic count and the presence of the underground utility cable that could be in conflict with excavation/construction. Also, as the owner of Tarbox Construction, LLC, the company that installed the culverts currently in use, is a resident of Trouant's Island, it is possible that the construction could be completed at reduced cost.

5.1.6 Design Standards

Nine standards are taken from the DEP's stormwater management policy to be used in a form to assist in Conservation Commission review of management plans. The form encourages meeting not only water management standards, but engineering standards as well. Under the Massachusetts DEP Bureau of Resource Protection – Wetlands Stormwater Management Policy (March 1997), the peak discharge rate cannot exceed the pre-development rates (Nyman, March 2002). This standard does not apply to this site, however, as it is subject to tidal flows. The design has accounted for erosion control; emphasizing prevention of erosion, controlling the sediments, and providing stability to the soil during the necessary construction. The control will be provided through means of a three-sided box culvert with an open bottom and rip-rap, in addition to backfilling the causeway with materials that are more resistant to erosion, leveling the causeway, and replacing the granite blocks that line the length of the causeway. If the design is proposed and brought before the Conservation Commission, the road maintenance plan will be

expanded to include the parties responsible for the ownership and maintenance of the roadway (the residents of Trouant's Island), a schedule for maintenance and inspection of the culverts and road, and the necessary access and maintenance easements.

5.2 Design Summary

5.2.1 Road Maintenance

The first and most simple recommendation was to improve the road maintenance along the entire causeway. This would entail maintaining a uniform elevation at the maximum allowable height. Keeping the roadway as high as possible will allow less water to overcome it. Unfortunately, the maximum elevation is relatively low and it only takes an average high tide to flood over it. But, maintaining a level elevation will prevent the violent flows that stream across the low points, carrying away gravel from the roadway and into the marsh channels. A level roadway, along with the implementation of additional stone blocks along the edges of the roadway, will protect both the road and the marsh from degradation and erosion as water flows over.

5.2.2 Culvert 2 Replacement

In summary, it is recommended to replace Culvert 2 with a 3-sided concrete box culvert. The culvert should be 28 feet long with a 3-foot rise and 8-foot span, with a slope of 0.0075 downward toward the North, to enable easier draining of the marsh during ebb tide. The 3-sided design incorporates a natural channel bottom, emulating a more natural flow regime than the existing circular culvert, which acts like a pressurized pipe once submerged. Concrete is recommended over metal because it can withstand becoming submerged daily, and can resist corrosion by saline water.

5.2.3 Future Consideration of Third Culvert

The project team recommends that a third culvert be installed in the future, if the replacement Culvert 2 proves to be effective at mitigating local erosion and flooding. If in fact the conditions improve after the replacement of Culvert 2, the conclusion can be made that box culverts are the right design choice for this road. Considering the excess cost and disruption to the environment and residents during construction, it is recommended to wait until the effects of the first box culvert are monitored and evaluated before launching the final phases of the project. Installing Culvert 3 will be a greater endeavor than replacing Culvert 2, due to its larger size and more difficult angle. It is part of the difficulty in designing for this site; alterations may not be made to the marsh environment and the culvert must be designed to fit within the existing channels. The third culvert would also be a 3-sided concrete box culvert, because box culverts can incorporate angled ends to accommodate the desired shape. The culvert would be 65 feet long. Further study on the specific location would be necessary before determining the cross-sectional area, but the maximum rise would be 2 feet.

6. Works Cited

- Book 95, 2887 (Plymouth County Registry of Deeds March 7, 1803).
- Wetlands Protection Act, Mass. Gen. Laws ch. 131 Subsection 40 (1997 йил February).
- Emergence of People in North America*. (2002, November 25). Retrieved from Idaho State University Idaho Museum of Natural History.
- Manning's Roughness Coefficient*. (2012). Retrieved from The Engineering ToolBox: http://www.engineeringtoolbox.com/mannings-roughness-d_799.html
- Alkhrdaji, T., & Nanni, A. (2001). *Construction and Long-Term Monitoring of a Concrete Box Culvert Bridge Reinforced with GFRP Bars*. Rolla: University of Missouri - Rolla.
- American Concrete Industries, Inc. (2011). *Precast Concrete Box Culverts by ACI*. Retrieved from American Concrete Industries, Inc. of Auburn and Bangor, Maine.
- Ammann, A. P., Hoey, S., Lang, G. J., & Linvill, B. (1999). *Plan and Environmental Assessment Little River Salt Marsh Restoration North Hampton and Hampton, New Hampshire*. Durham: USDA - Natural Resources Conservation Service.
- Bendo, Y. (2007). Steel is the most recycled material on earth. *Journal of Commerce*.
- Bloomquist, D. G., & Gutz, A. J. (2002). *Evaluation of Precast Box Culvert Systems: Design Live Loads on Box Culverts*. Tallahassee: Florida Department of Transportation.
- Bodhaine, G. L. (1988). Measurement of Peak Discharge At Culverts By Indirect Methods. In *Techniques of Water-Resources Investigations of the United States Geological Survey* (p. 2). Denver: United States Government Printing Office.
- Bruun, P. (1988). The Bruun Rule of Erosion by Sea-Level Rise: A Discussion on Large-Scale Two- and Three-Dimensional Usages. *Journal of Coastal Research*, 627-648.
- Carlisle, B., Donovan, A., Hicks, A., Kooken, V., Smith, J., & Wilbur, A. (2002). *A Volunteer's Handbook for Monitoring New England Salt Marshes*. Boston, MA: Massachusetts Office of Coastal Zone Management.
- Chanson, H. (2000). Introducing Originality and Innovation in Engineering Teaching: the Hydraulic Design of Culverts. *European Journal of Engineering Education*, 377-391.
- Chow, V. T. (1959). *Open Channel Hydraulics*. New York: McGraw-Hill.
- CONTECH Engineered Solutions. (2012). *Aluminum Box Culverts*.
- Copeland, R. R., & Thomas, W. A. (1989). *Corte Madera Creek Numerical Sedimentation Study*. Vicksburg: US Army Engineer Waterways Experiment Station.

- Department of Environmental Protection. (2009). Section 10.32 Salt Marshes. In *310 CMR 10.00: WETLANDS PROTECTION* (pp. 69 - 70).
- Ettema, R. (2000). *Hydraulic Modeling: Concepts and Practice*. American Society of Civil Engineers.
- Federal Emergency Management Agency. (2008). *Flood Insurance Study: Plymouth County, Massachusetts*.
- Fetter, C. W. (1994). *Applied Hydrogeology*. Upper Saddle River: Prentice-Hall.
- FishXing. (2010, December). *Culvert Hydraulic Calculations Overview*. Retrieved March 22, 2012, from FishXing Version 3:
http://www.fsl.orst.edu/geowater/FX3/help/4_Calculations/Culvert_Hydraulic_Calculations_Overview.htm
- Furniss, M., Love, M., Firor, S., Moynan, K., Llanos, A., Guntle, J., et al. (2006). *Entrance Loss Coefficient*. Retrieved from Oregon State University Forestry Sciences Laboratory.
- Gurley Precision Instruments. (2004). *Water Current Meters*. Retrieved March 24, 2012, from <http://www.gpi-hydro.com/>
- Houghtalen, R., Hwang, N., & Akan, A. (2010). *Fundamentals of Hydraulic Engineering Systems*. Upper Saddle River, NJ: Pearson Education, Inc.
- Kistner Concrete Products, Inc. (2004, July 2). *Weight Index For Available Box Culvert Sizes*. Retrieved from Box Culverts.
- LMNO Engineering, Research, and Software, Ltd. (2000 йил 13-July). *Circular Culvert using Manning Equation*. Retrieved 2011 йил 15-December from LNMO Engineering:
<http://www.lmnoeng.com/CircularCulvert.htm>
- LMNO Engineering, Research, and Software, Ltd. (2000 йил 13-July). *Circular Culvert using Manning Equation*. Retrieved 2011 йил 15-December from LNMO Engineering:
<http://www.lmnoeng.com/CircularCulvert.htm>
- Marsh, W. (2010). *Landscape Planning*. Hoboken, NJ: John Wiley & Sons.
- Massachusetts Office of Coastal Zone Management. (2005, December). *Historical Shoreline Change Rate*. Retrieved October 1, 2011, from South Shore Coastal Hazards Characterization Atlas- Tile IV:
http://www.mass.gov/czm/hazards/ss_atlas/pdf/6/tile6b.pdf
- Massachusetts Office of Coastal Zone Management. (2011, September). *Mission Statement*. Retrieved October 7, 2011, from <http://www.mass.gov/czm/>

- Massachusetts Office of Coastal Zone Management. (2011). *Policy Guide*. Boston: National Oceanic and Atmospheric Administration.
- Mohtar, R. H. (2001, June 27). *Culverts and Bridges*. Retrieved from University of Purdue ABE 527: Computer Models in Environmental & Natural Resources.
- Munson, B., Young, D., & Okiishi, T. (2006). *Fundamentals of Fluid Mechanics*. Hoboken, NJ: John Wiley & Sons.
- National Oceanic and Atmospheric Administration. (2005, March 10). *2011 NOAA Tide Predictions: Damons Point, North River*. Retrieved November 10, 2011, from Tides & Currents:
http://tidesandcurrents.noaa.gov/get_predictions.shtml?year=2011&stn=2113+Boston&seastn=Damons+Point,+North+River&thh=%2B0&thm=20&tlh=%2B0&tlm=36&hh=*0.89&hl=*0.89&footnote=
- National Oceanic and Atmospheric Administration. (2012, March 15). *Storm Surge Overview*. Retrieved March 25, 2012, from National Hurricane Center:
<http://www.nhc.noaa.gov/ssurge/>
- Nave, C. R. (2012). *Bernoulli Equation*. Retrieved March 23, 2012, from HyperPhysics:
<http://hyperphysics.phy-astr.gsu.edu/hbase/pber.html#beq>
- New York Department of Transportation. (1996). *Highway Design Manual*.
- Nyman, D. (March 2002). *Hydrology Handbook for Conservation Commissioners*. Boston: DEP Wetlands Program.
- Pethick, J. (2001). Coastal management and sea-level rise. *Catena*, 307-322.
- Prior Engineering, LLC. (2010). *Stream Simulation at Road Crossings Design Manual*. North Bend.
- Rantz, S. (1983). Volume 1: Measurement of Stage and Discharge. In U. G. Survey, *Measurement and Computation of Streamflow* (pp. 79-183). Washington, DC: US Geological Survey.
- Richards, L. S. (1901). *History of Marshfield*. Plymouth: The Memorial Press.
- Shaw Precast Solutions. (2012, March 2). *Box Culverts*. Retrieved from Shaw Precast Solutions.
- Singh, K. (2007). *Open Channel Flow*. Retrieved 2012 йил 8-February from Civil Engineering Portal: <http://www.engineeringcivil.com/open-channel-flow.html>
- Springate-Baginski, O., Allen, D., & Darwall, W. R. (2009). *An Integrated Wetland Assessment Toolkit: A guide to good practice*. Gland, Switzerland: IUCN.

- Sturm, T. (2009). *Open Channel Hydraulics*. McGraw-Hill.
- Tarbox, J. (2012, February 2). Owner of Tarbox Construction, LLC. (B. Stitt, Interviewer)
- Teal, J., & Teal, M. (1983). *Life and Death of a Salt Marsh*. New York: Ballantine Books.
- The New England Environmental Finance Center. (2010). *A Financial Assessment of LD 1725: Stream Crossings*. Portland: Edmund S. Muskie School of Public Service University of Southern Maine .
- U.S. Army Corps of Engineers. (1994). *Engineering and Design: Hydraulic Design of Flood Control Channels*. Washington, D.C.: U.S. Army Corps of Engineers.
- United States Department of Transportation Federal Highway Division. (2011, April 7). *Tidal Hydrology, Hydraulics, and Scour at Bridges*. Retrieved February 10, 2012, from Hydraulics Engineering:
<http://www.fhwa.dot.gov/engineering/hydraulics/hydrology/hec25c3.cfm>
- US Army Corps of Engineers. (1991 йил 15-March). Tidal Hydraulics. *Engineer Manual 1110-2-1607*. Washington, DC: Department of the Army.
- US Harbors. (2011). *Damons Point, North River Tide Charts*. Retrieved 2011 йил 10-November from US Harbors: Massachusetts Harbors: <http://ma.us harbors.com/monthly-tides/Massachusetts-Boston%20Harbor,South%20Shore/North%20River>
- Weilding, B. (2012). *Steel & Metal Culvert Pipe Are Less Expensive*. From Culvert Pipes.
- Weisstein, E. (2012). *Trapezoidal Rule*. Retrieved 2012 йил 12-April from Mathworld--A Wolfram Web Resource: <http://mathworld.wolfram.com/TrapezoidalRule.html>
- Wennemer, J. (2011 йил September). Town of Marshfield Conservation Comissioner. (S. Bartlett, Interviewer)
- Wisconsin Department of Transportation. (2010). *FACILITIES DEVELOPMENT MANUAL*. Wisconsin Department of Transportation.
- Zivkovic Geophysical Investigations, LLC. (2011, August 29). *Normal Coastal Processes*. Retrieved March 13, 2012, from Zivkovic Geophysical Investigations:
http://zivkovicgeophysical.blogspot.com/2011_08_01_archive.html

7. Appendix

7.1 Project Proposal

A Proposal to Design a Culvert System for Flood Mitigation of Macomber's Way in Marshfield, Massachusetts

A Major Qualifying Project submitted to the faculty of Worcester Polytechnic Institute in partial requirements for the Degree of Bachelor of Science

By Samuel Bartlett, Allison Roche, and Brendan Stitt

Dated October 10, 2011

1. Introduction

1.1 Overview

The English Salt Marsh in Marshfield, Massachusetts is part of an estuary at the intersection of the North River, South River, and Atlantic Ocean. Estuaries are dynamic ecosystems, sources of income, and often are highly populated areas, but these valuable coastal zones are vulnerable to degradation and flooding. Flooding is aggravated when the tidal cycle is disrupted through natural or artificial means. Natural flow obstruction can be caused by dramatic storm events, erosion, embankment slump, shoaling, and influence by local species. Artificial flow obstruction usually occurs because of man-made structures in the marsh, such as dams, weirs, and culverts.

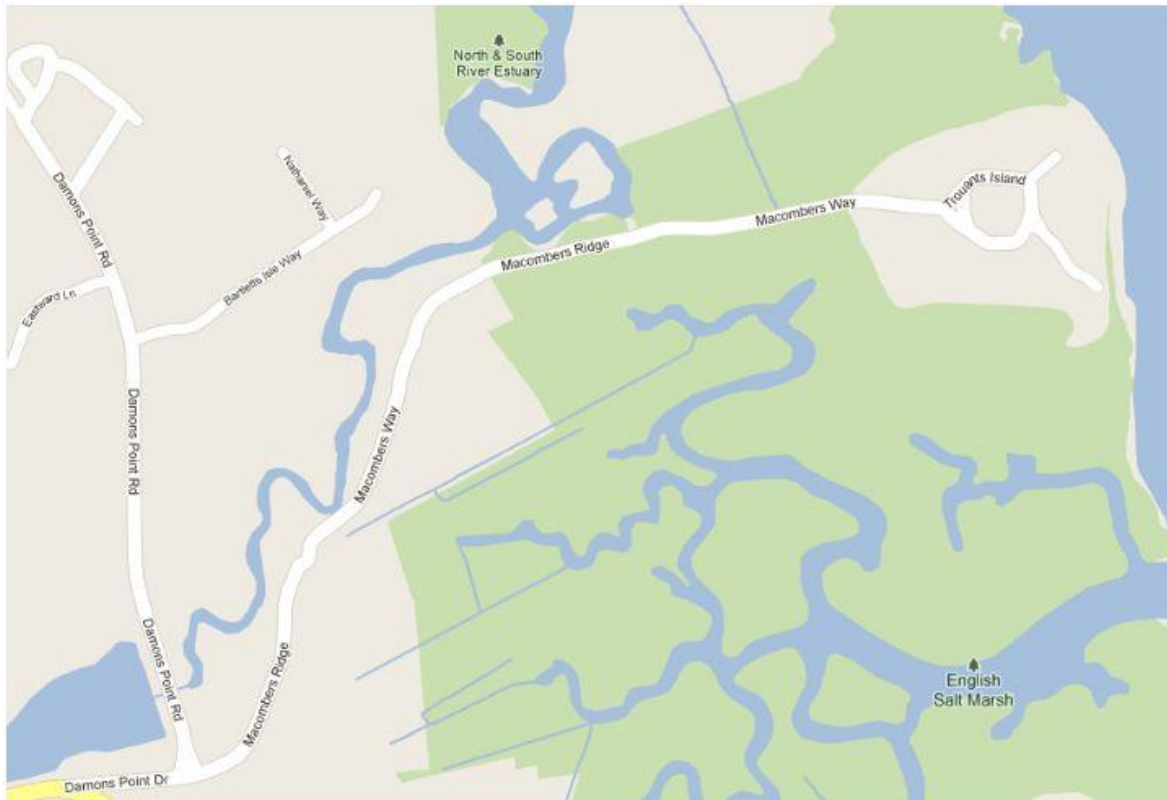

Figure 42. Map of the English Salt Marsh and Macomber's Way in Marshfield (Source: Google Maps, 2011)

Macomber's Way is a man-made causeway that spans part of the marsh and provides access to Trouant's Island (Figure 1). The causeway becomes submerged twice daily during high tides, restricting safe access to and from the island. Although this flooding is inevitable based on the elevation of the causeway and average high tide levels, a combination of natural and artificial flow obstructions in and around the causeway also contribute to scouring, erosion, and damage to properties and vehicles.

1.2 Problem Statement

The three culverts along Macomber's Way constrict the natural ebb and flow of the tides, causing a backup of water on the north side of the causeway, which submerges the roadway (see Figure 2) and exacerbates local embankment scour and sedimentation.



Figure 43. Flooding of Macomber's Way on September 16, 2011 (Photo source: Brendan Stitt)

1.3 Goal Statement

The goal of this project is to design an engineering alternative to the culverts within Macomber's Way that will minimize the impacts of flooding and erosion on the causeway and the adjacent marsh.

2. Background

2.1 Site Description

The North and South Rivers Estuary and English Salt Marsh are located in Marshfield, Massachusetts where the Atlantic Ocean meets the North River and South River. This tidal salt marsh experiences flooding during high tide, while a network of canal systems is exposed during low tide. Macomber's Way ("the causeway") allows access across the marsh to Trouant's Island from Damon's Point Road but is impassable during high tide, when the incoming seawater spills over the causeway. Seawater flows into the estuary through New Inlet, which was established in 1898 during a powerful storm that broke open the existing sandbar. As the flood tide passes through New Inlet, it flows one of two ways: either south around Trouant's Island toward the South River, or north around Trouant's Island toward the North River and Macomber's Way (see Figure 3). Due to sediment deposition on the southern side of New Inlet, flow is restricted and more is forced up toward the North, creating a greater load flowing over the North side of Macomber's Way during flood tide. The three existing culverts in the causeway receive flow greater than their capacity, creating uneven water levels, high velocity at the outlet, and loss of marsh bank and vegetation in the surrounding area.

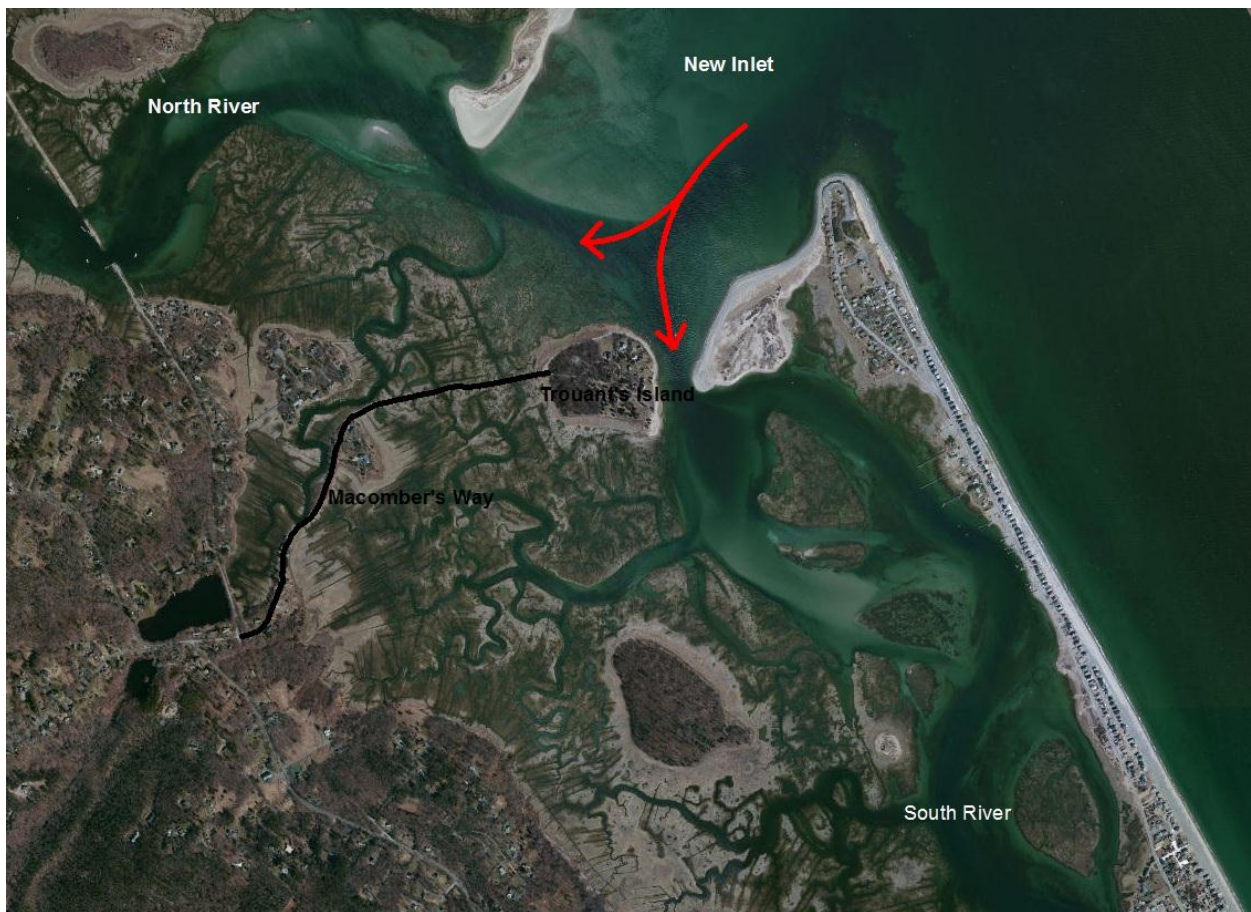

Figure 44. Tidal flows enter through New Inlet and flows bidirectionally into the marsh. Red arrows show the two directions of flow around Trouant's Island

2.2 Marsh studies

The collection and analysis of field monitoring data can provide invaluable information during a wetland assessment. But, data can be worthless without a clearly defined purpose. Therefore the first major step in performing a wetland assessment is the planning phase, during which the management concerns and objectives must be identified (Springate-Baginski, Allen and Darwall, 2009). This preparation phase also includes conducting extensive background research and

literature review as well as contacting any related government entities or local groups. Once the monitoring plan has been designed, the second phase is to conduct the field assessment. Finally, analysis of data, presentation of results, and policy engagement with local stakeholders are necessary to complete the process (Springate-Baginski, et al., 2009).

Depending on the overall goal of the monitoring event, different parameters are appropriate or necessary to monitor. Massachusetts Office of Coastal Zone Management, a part of the Executive Office of Energy and Environmental Affairs organized to balance the impacts of human activity with the protection of coastal and marine resources, lists tidal hydrology, salinity, plants, invertebrates, fish, and birds as options for field monitoring of a salt marsh ecosystem (Carlisle, Donovan, Hicks, Kooken, Smith and Wilbur, 2002). Although monitoring tidal hydrology over a tidal cycle is time-consuming, tidal restrictions are easily observed and documented. However, numerical data does require more precise methods but is still a relatively low-effort task with the proper equipment.

Marsh studies can involve comparative strategies including a before-after or reference site- study-site comparison, which compare the state of the site before and after a stressor is added or removed, or compare the site with a stressor to a similar site without that stressor (Carlisle, et al., 2002). These comparisons are useful to validate data and to show the importance or applicability of an issue by isolating its effects in the marsh. Common study areas include salt marshes with tidal restrictions, regional reference sites, and salt marshes affected by pollution or land use. Once purpose and the parameters are decided upon, an evaluation area must be chosen. The size and location of the area must be considered in order to achieve a representative sample, without exceeding reasonable expectations for the physical limitations of a group of a certain size. A salt marsh can span hundreds of acres, much too expansive to sample in a day especially without a large crew. Other interferences may arise due to groundwater seepage or samples improperly timed by the tides. Many considerations must be made while sampling such a dynamic environment (Carlisle, et al., 2002).

The Army Corps of Engineers' *Tidal Hydraulics Engineer Manual* defines six basic parameters of field data for a hydrodynamic analysis. The parameters are: tide heights, currents, suspended solids, salinity, bed stresses, and elevation (US Army Corps of Engineers, 2001). Generally, these parameters require more expertise and equipment than the previously mentioned parameters for an ecological study. Flooding concerns are more related to these hydrodynamic parameters. Tide heights and currents are field parameters that can be observed easily, but measuring these with accuracy can pose a challenge. Another area of concern is the length of a hydrodynamic survey. Long-term surveys can span anywhere from months to years long, and more often result in useful information since most erosion processes or estuary changes occur relatively slowly over time. However, short term surveys can also produce usable data and are in most cases easier to complete. Short term, or intensive, surveys should occur over 13 or 25 hours, which covers one or two semidiurnal tidal cycles (US Army Corps of Engineers, 2001).

3. Capstone Design

The Accreditation Board for Engineering and Technology (ABET) criteria requires a capstone design project to consider most of the following realistic constraints: economic, environmental, sustainability, constructability, ethical, health and safety, social, and political. The goal of this project is to design a culvert system that directly impacts the conditions of an estuary as well as a residential area. Relevant constraints will be considered and are addressed in this section.

Economic: The scope of this project will consider economic constraints, and complete a cost-analysis for each design alternative as a part of determining the final design choice. The major cost associated with the design solution will be the construction of the culvert(s) or other structures. The maintenance costs will be minor in comparison. Cost is an important consideration because although a flood-mitigating design will save money on repairing water damage to homes and cars, residents will still prefer a design that requires minimal spending.

Environmental: This project directly involves a marsh environment. Estuary ecosystems support an array of wildlife and plants. Field work will be minimally invasive and will not disrupt habitats or natural flow dynamics. A nest of sandpipers was observed near the culvert on Macomber's Way, so special care will be taken to not disturb or disrupt the habitat of this species. The implications of the final design, if implemented, will temporarily disrupt the area during construction but the purpose of the project is to improve the conditions of eroding banks and enable vegetation to grow where scour currently exists. Construction work will be temporary, but these designed structures will support future environmental improvement.

Constructability: Background research will support the constructability of the culvert. Flow conditions in the marsh will be monitored and fitted to appropriate culvert standards that already exist. Considerable research will be involved in the design process, including the analysis of current best practices, types of materials used to withstand natural erosion or shoaling, and building with minimal ecological impact. Alternative designs will be drafted and considered, and the final decision will be something buildable for the site.

Health and safety: The current state of Macomber's Way presents safety risks during high tide when the causeway becomes flooded and impassible. The design will attempt to lessen the extent of the flooding in residential areas, therefore reducing health and safety risks.

Social: Social implications of this project involve accessing privately owned land for field work. The implementation of the design would also require approval of residents since the Town of Marshfield does not control Macomber's Way and the existing culverts. Zoning laws must also be considered to ensure that the culvert meets any aesthetic or otherwise limiting statutes.

Political: The background research of the site required contact with state and municipal agencies including the Town of Marshfield Conservation Commission, Town of Marshfield Assessor, Commonwealth of Massachusetts Division of Fisheries and Wildlife, and Massachusetts Office of Coastal Zone Management. Alterations to the marsh would require approval of the Massachusetts Division of Fisheries and Wildlife and the Town of Marshfield Planning Commission, as well as the residents of Trouant's Island who have ultimate control of the culverts in the causeway.

4. Methodology

The methodology involved in this project will include five phases. Each of these phases build upon each other and are necessary in order to achieve the goal of designing a culvert system for Macomber's Way that will alleviate erosion of the marsh banks and reduce flooding nearby. The project phases are:

- Project scoping activities
- Field monitoring events
- Describe existing conditions
- Conceptualize design options
- Develop final design

A timeline of tasks to be completed during A Term, B Term, and C Term is available in Appendix B.

4.1 Project scoping activities

Phase one of the project methodology will involve identifying and contacting local stakeholders, seeking relevant literature, and visiting the English Salt Marsh to identify specifics about the flooding problems. All of these tasks serve as project scoping activities, which are necessary before more specific, purpose-driven field measurements will be taken. This scoping phase began at the start of the project, before the submission of the formal proposal, as the scope of work must be refined in order to define the project goal and plan for further methodology. Appendix B shows the time frame during which these tasks will be completed.

4.1.1 Contacting Local Stakeholders

Contact with local stakeholders will be initiated and maintained by the project team to acquire background information on the site, any past or current monitoring of the marsh, flood control measures that have been implemented, and ownership of relevant land parcels. The Town of Marshfield Conservation Commission will serve as a source of historic background on the marsh as well as information regarding conservation efforts either through applicable bylaws or by volunteer organizations. The North and South Rivers Watershed Association will be contacted in an attempt to attain any existing data from previous monitoring events. Other government agencies including the Federal Emergency Management Agency (FEMA) and the Massachusetts Office of Coastal Zone Management (CZM) will become sources of mapping tools to show flood zones and coastline changes over time through Geographic Information Systems (GIS). The Commonwealth of Massachusetts Division of Fisheries and Wildlife owns the undeveloped marsh areas, and will be contacted by the project team. The residents of Trouant's Island who own and maintain Macomber's Way and the culverts will be identified through the Town of Marshfield Assessor. The cooperation of these residents will enable the project team to perform frequent monitoring of the marsh, specifically along the causeway. Island residents are those most effected by this flooding and will likely have the most knowledge of the design and maintenance of the existing culverts in the causeway.

4.1.2 Site Reconnaissance Visits

Site reconnaissance visits were made by the project team on September 4th and September 16th, 2011. The purpose of these visits was to observe and photograph existing conditions of the marsh and locate specific areas of concern, since a design for an entire estuary is beyond the feasible scope for this project. During the first visit, which took place during low tide, the project team explored the southern part of the English Salt Marsh, including the perimeter of Tilden Island. During the second visit, Macomber's Way was observed during high tide and ebb tide. The causeway became submerged (see Figure 4), and erosion was apparent on both sides of the three culverts. The project scope then became directed at designing an alternative to the existing culverts in the causeway.

4.2 Collecting Field Data

4.2.1 On-site monitoring



Figure 45. Flooding along the sides of Macomber's Way (Photo source: Brendan Stitt, September 16, 2011)

Building upon the two preliminary site visits conducted in September, several more field surveys will be conducted to monitor any changes in the properties of the channels running adjacent to the causeway, whether due to erosion or tidal stages. More photographs of the area will be taken as evidence and will be marked with date, time, and tidal stage. The location of the photographs will be linked to coordinates determined by a handheld Global Positioning System (GPS) to ensure that the same location is monitored on each subsequent trip. Tide gauges will be placed along Macomber's Way and monitored throughout a complete tidal cycle to determine changes in volume of flow entering and exiting the estuary. Any significant alterations in topography of the area will also be recorded. The depths of the channels on either side of the causeway and of the flooding on the road will be determined as well. These measurements and other quantitative data will be compared to the limited set of historical data that has been found.

4.2.2 Measuring tidal elevations

In order to measure the tidal elevations, gauges must be installed along the causeway. The gauges could be long, flat wooden sticks with secured measuring tape along its entire length. The tape would be graduated in increments of one inch, and range from zero inches up to the length of the stick (for example sixty inches for a five foot stick). Tide charts will be consulted ahead of time to determine the expected tidal range for the period of time that readings will be taken. Each of the gauges will be referenced to a particular landmark. The same reference point would be used when moving the

gauges, which would allow for all of the gauges to be on the same scale and for the data collected over the 6.2 hour tidal cycle to be at a single reference elevation.

The gauges will be installed at strategic lengths along the causeway to allow for an acceptable representation of the tidal changes that occur daily. The measurements will be taken at regular intervals and recorded. Measurements will also be referenced to the causeway and the elevation of the causeway relative to sea level will be determined as well. The elevation and location of the gauges will be determined by GPS or referenced to established benchmarks. The tidal elevations will be recorded for approximately one half of a tidal cycle, accounting for both high and low tides. The tide gauges will be repositioned as necessary to compensate for tidal variations by re-referencing them to the previously established benchmarks. The field books will be reworked and updated to reflect actual elevations after adjustments in the field, relative to these benchmarks. Time will be recorded and then calculated as time elapsed rather than time at the instance of the measurement. A plot of the tidal surface variations over time will then be constructed for review.

4.2.3 Field Flow Measurement

Measuring the flow rates into and out of the estuary will be crucial in determining what changes must be made to the culverts to decrease flooding. First, a tag line will be stretched across the channel to get the width of the channel and of the section being measured. After that, more locations for measurement will be determined. These will be defined in terms of lengths measured along the tag line from a reference point on the bank. At each measurement location, a single velocity and depth measurement will be taken. The velocity will be taken at a depth of 1/5, 3/5, or 4/5 of the overall depth, providing a close approximation of the depth-averaged velocities according to United States Geological Survey guidelines. The depth measurement will be used to determine an area for each interval. The velocities and cross-sectional areas for each section will be measured and used to determine the flow rates, which will then be summed to get the overall flow rate. As the measurements will be taken during a tidal period, with constantly changing stages, the velocity and area used to determine the flow rate will not remain constant. Variations will therefore exist due to these changing parameters.

4.2.4 Examining erosion

The wearing away of the walls of the culverts and channels through the natural process of erosion is another concern. Shoaling, the process of sediment deposition in an estuary that leads to the buildup of sandbars, and deposition of other eroded materials can change the flow through channels and culverts. The buildup of eroded material can also increase the bed height of the channels, allowing flooding to more readily occur by filling drainage channels. Erosion can be measured through visual, physical, chemical and biological means. This project will focus on the former two. Comparisons of aerial photographs taken over time and observations made during site visits will serve as visual means of measurement (see Figure 6) and examining any changes in channel depth over time will serve as a physical quantifier. Signs of erosion have already been observed on the first two site visits. The waterways in and around the salt marsh have been muddy and murky, gullies could be seen, embankment scour was noticeable at the inlets and outlets, and soil deposits were present in low areas (see Figure 5).



Figure 46. Erosion of the second culvert on the North side of Macomber's Way (Photo source: Brendan Stitt, September 16, 2011)



Figure 47. Macomber's Way at low tide, October 2010 (Photo source: Chris Bernstein)

4.3 Describe Existing Conditions

4.3.1 Classify Existing Culverts

After all the field monitoring data has been collected, it will be analysed to determine the conditions under which the culverts exist. It is important to first classify the existing culverts by shape, material, size, and flow regime in order to properly design a new culvert. Size and shape are important because these parameters dictate the flowrate of the culvert and the possible flow regimes. Classifying the flow regimes in the culvert is also an important step, as the new design must be functional under each flow regime. Since we are working in a tidal setting, the flow regimes vary greatly throughout the day, which means the new design must maintain functionality regardless of the time of day. Another key factor in culvert design is the material used. Different materials have different roughness coefficients which influence the flow through the barrel. Some materials are prone to erosion and corrosion so the material for the new design must be able to handle the impact of the sediments and debris passing through the culvert.

4.4 Conceptualize Design Options

When redesigning a culvert, we must first decide what needs to be changed from the original design. The three culverts along Macomber's Way do not allow enough water to pass through which leads to the flooding of the causeway. The high exit velocities from the culvert outlets that scour the embankments are a result of small cross-sectional areas in the existing culverts. Both of these issues can be fixed by increasing the flowrate through the culverts. Scour can also be fixed by adding erosion resistant rip-rap or by installing concrete aprons at the inlet and outlet of the culvert. A crucial task will be to investigate the different design solutions and choose the one that best suits the issues at this site.

4.4.1 Design Considerations

The next step in the design process is to define the limitations to our design and what characteristics to consider. Typically a culvert has a defined inlet and a defined outlet, so the culvert may be designed to best fit the conditions at the site. The culverts at Macomber's Way must channel water in both directions because of the ebb and flow of the tides. This poses a major challenge to design because each end of the culvert must act as a functional inlet and outlet. Water will need to travel in both directions, which eliminates the option of creating specialized inlets or outlets to control flow. Another limitation to the design is the local substrate. The banks of the causeway are comprised of the same saturated mud that makes up the rest of the marsh. This is a poor material for building upon and would prevent construction of concrete inlets and outlets, which could aid in protecting the embankments from erosion.

There are many different types of culverts that will be considered when designing this culvert system. The shape of the culvert is very important as it dictates how water will move through the culvert and how much volume will be channeled. Depending on the space available under the roadway, changing the shape of the culvert may allow for a higher volume of water to travel through the culvert. The team will also consider different possibilities for building materials because different materials resist the corrosive and erosive nature of the channeled water better than others. Also, the different materials have different roughness coefficients, which affects the flow and the lifespan of the culvert barrel. Culverts can also be designed with different inlets and outlets, which can ease the flow through the culvert and decrease erosion and sedimentation.

4.4.2 Designing for Local Conditions

The next step is to analyze the local conditions of the site. One of the most important things to measure is the cross-sectional area of the causeway. This will show how much space there is to build in which is important to know when considering the size and shape of the culvert. Then the team will classify the flow regimes in the existing culvert, which is important because the new culvert

must be capable of handling the various types of flows that pass through it over the course of the day. A tidal setting means our culverts will be dealing with multiple flow regimes during a single day. Culverts must also be designed to handle the local peak flow, the maximum flow the culvert will typically experience. Also the culvert can be designed to handle flows associated with storm events. This can be a small event, such as a 10-year storm, or a high volume event like a 100-year storm. The local weather of the site dictates which storm volume the culvert will be designed to handle.

4.5 Develop Final Design

Creating the final culvert design is a balancing act. The team must design a culvert that functions properly during all possible flow regimes while still accommodating the peak flows and the storm flows. After completing various possible designs, the design which best suits the needs of the town of Marshfield and balances both cost and efficiency will be analyzed using the Culvert Design Form from the U.S. Department of Transportation (Figure 7, Appendix A). This is a method of analyzing culvert efficiency.

5. Works Cited

Carlisle, B. K., Donovan, A. M., Hicks, A. L., Kooken, V. S., Smith, J. P., & Wilbur, A. R. (2002). *A Volunteer's handbook for monitoring new england salt marshes*. Boston, MA: Coastal Zone Managment.

Norman, J. M., Houghtalen, R. J., & Johnston, W. J. (May 2005). *U.S. Department of Transportation, Federal Highway Administration: Hydraulic Design Series Number 5: Hydraulic Design of Highway Culverts*. Denver: Publication No. FHWA-NHI-01-020.

Springate-Baginski, O., Allen, D., & Darwall, W. R. T. (2009). *An integrated wetland assessment toolkit*. Cambridge, UK: International Union for Conservation of Nature and Natural Resources.

US Army Corps of Engineers. (1991). *Tidal hydraulics engineer manual* No. EM 1110-2-1607). Washington, DC: Department of the Army.

Appendix A

PROJECT : _____		STATION : _____		CULVERT DESIGN FORM																																																																																																							
SHEET _____ OF _____		DESIGNER / DATE : _____ / _____		REVIEWER / DATE : _____ / _____																																																																																																							
<p style="text-align: center;">HYDROLOGICAL DATA</p> <p>SEE ADDL. SHEETS:</p> <input type="checkbox"/> METHOD: _____ <input type="checkbox"/> DRAINAGE AREA: _____ <input type="checkbox"/> STREAM SLOPE: _____ <input type="checkbox"/> CHANNEL SHAPE: _____ <input type="checkbox"/> ROUTING: _____ <input type="checkbox"/> OTHER: _____ <p style="text-align: center;">DESIGN FLOWS/TAIWATER</p> <table style="width:100%; border-collapse: collapse;"> <tr> <td style="width:33%; border-bottom: 1px solid black;">R. I. (YEARS)</td> <td style="width:33%; border-bottom: 1px solid black;">FLOW (cfs)</td> <td style="width:33%; border-bottom: 1px solid black;">TW (ft)</td> </tr> <tr> <td style="border-bottom: 1px solid black;"> </td> <td style="border-bottom: 1px solid black;"> </td> <td style="border-bottom: 1px solid black;"> </td> </tr> </table>		R. I. (YEARS)	FLOW (cfs)	TW (ft)				<p style="text-align: right;">ROADWAY ELEVATION : _____ (ft)</p>  <p style="text-align: right;"> $S = S_0 - \text{FALL} / L_g$ $S =$ _____ $L_g =$ _____ </p>																																																																																																			
R. I. (YEARS)	FLOW (cfs)	TW (ft)																																																																																																									
<p>CULVERT DESCRIPTION:</p> MATERIAL - SHAPE - SIZE - ENTRANCE		<p>TOTAL FLOW PER BARREL</p> Q (cfs)		<p style="text-align: center;">HEADWATER CALCULATIONS</p> <table border="1" style="width:100%; border-collapse: collapse; text-align: center;"> <thead> <tr> <th colspan="4">INLET CONTROL</th> <th colspan="8">OUTLET CONTROL</th> <th rowspan="2">CONTROL HEADWATER ELEVATION</th> <th rowspan="2">OUTLET VELOCITY</th> <th rowspan="2">COMMENTS</th> </tr> <tr> <th>HW₁/D (2)</th> <th>HW₁ (3)</th> <th>FALL (5)</th> <th>EL_{st} (4)</th> <th>TW (6)</th> <th>d_c</th> <th>$\frac{d_c + D}{2}$</th> <th>h₀ (g)</th> <th>h_e</th> <th>H (7)</th> <th>EL_{ho} (8)</th> </tr> </thead> <tbody> <tr><td> </td><td> </td><td> </td><td> </td><td> </td><td> </td><td> </td><td> </td><td> </td><td> </td><td> </td><td> </td><td> </td><td> </td></tr> <tr><td> </td><td> </td><td> </td><td> </td><td> </td><td> </td><td> </td><td> </td><td> </td><td> </td><td> </td><td> </td><td> </td><td> </td></tr> <tr><td> </td><td> </td><td> </td><td> </td><td> </td><td> </td><td> </td><td> </td><td> </td><td> </td><td> </td><td> </td><td> </td><td> </td></tr> <tr><td> </td><td> </td><td> </td><td> </td><td> </td><td> </td><td> </td><td> </td><td> </td><td> </td><td> </td><td> </td><td> </td><td> </td></tr> <tr><td> </td><td> </td><td> </td><td> </td><td> </td><td> </td><td> </td><td> </td><td> </td><td> </td><td> </td><td> </td><td> </td><td> </td></tr> </tbody> </table>								INLET CONTROL				OUTLET CONTROL								CONTROL HEADWATER ELEVATION	OUTLET VELOCITY	COMMENTS	HW ₁ /D (2)	HW ₁ (3)	FALL (5)	EL _{st} (4)	TW (6)	d _c	$\frac{d_c + D}{2}$	h ₀ (g)	h _e	H (7)	EL _{ho} (8)																																																																						
INLET CONTROL				OUTLET CONTROL								CONTROL HEADWATER ELEVATION	OUTLET VELOCITY	COMMENTS																																																																																													
HW ₁ /D (2)	HW ₁ (3)	FALL (5)	EL _{st} (4)	TW (6)	d _c	$\frac{d_c + D}{2}$	h ₀ (g)	h _e	H (7)	EL _{ho} (8)																																																																																																	
<p>TECHNICAL FOOTNOTES:</p> (1) USE Q/NB FOR BOX CULVERTS (2) HW ₁ /D + HW ₁ /D OR HW ₁ /D FROM DESIGN CHARTS (3) FALL = HW ₁ - (EL _{hd} - EL _{st}); FALL IS ZERO FOR CULVERTS ON GRADE		(4) EL _{st} = HW ₁ + EL ₁ (INVERT OF INLET CONTROL SECTION) (5) TW BASED ON DOWN STREAM CONTROL OR FLOW DEPTH IN CHANNEL.		(6) h ₀ = TW or (d _c + D)/2 (WHICHEVER IS GREATER) (7) $H = \left[1 + K_e + (K_u n^2 L) / R^{1.33} \right] v^2 / 2g$ WHERE K _e = 19.63 (29 IN ENGLISH UNITS) (8) EL _{ho} = EL _o + H + h ₀																																																																																																							
<p>SUBSCRIPT DEFINITIONS:</p> d. APPROXIMATE f. CULVERT FACE nd. DESIGN HEADWATER ni. HEADWATER IN INLET CONTROL no. HEADWATER IN OUTLET CONTROL i. INLET CONTROL SECTION o. OUTLET st. STREAMBED AT CULVERT FACE tw. TAIL-WATER		<p>COMMENTS / DISCUSSION:</p>				<p>CULVERT BARREL SELECTED:</p> SIZE: _____ SHAPE: _____ MATERIAL: _____ n _____ ENTRANCE: _____																																																																																																					

Figure 48. Culvert Design Form (Norman, Houghtalen, & Johnston, May 2005)

Appendix B

Project schedule: tasks to accomplish by weeks of each term

Task ↓ Week →	A Term							B Term							C Term							Corresponding Phases	
	1	2	3	4	5	6	7	1	2	3	4	5	6	7	1	2	3	4	5	6	7		
Contact local stakeholders	█	█	█	█	█			█	█														Phase 1 and 3
Preliminary site visits		█	█																				Phase 1, 2 and 3
Proposal writing			█	█	█	█	█																Phase 1
Field monitoring								█	█	█	█												Phase 2
Data analysis										█	█	█	█	█									Phase 3 and 4
Literature Review	█	█	█		█	█	█	█	█	█	█	█	█	█									Phase 1, 4, and 5
Evaluate Conceptual design alternatives														█	█	█	█	█	█				Phase 4
Design solution														█	█	█	█	█					Phase 4 and 5
Final report writing																		█	█	█	█	█	Phase 5

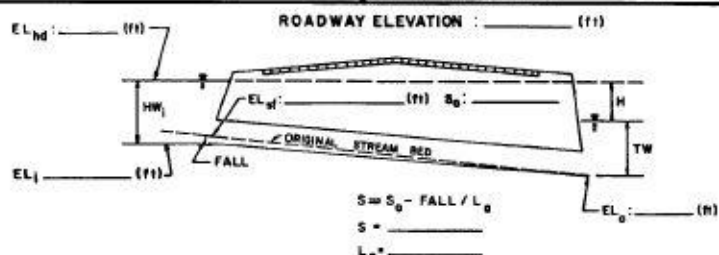
Key:

- Yet to be completed
- Already completed

7.2 Order of Conditions

Superseding Order of Conditions for Ram Island Condominium Trust - File No. SE 42-516

Special Conditions continued:

5. The above-referenced plan is to be followed except as noted below. Note #1 on the front page of the above-referenced plan is not an authorized condition for the placement of additional riprap. Maintenance of structures allowed by this Order is permitted. Maintenance shall be limited to repair and replacement of the structures authorized by this Order, in the manner authorized herein. Replacement of riprap outside of those ten areas and three culvert locations shown on the above-referenced plans and/or replacement of riprap with rubble blocks is prohibited without express written authorization amending this Order.
6. Destruction of salt marsh is prohibited. Prior to construction, adequate measures shall be employed to identify and protect salt marsh from alteration due to construction activities. Areas 5, 7, 8 & 9 as shown on the above-referenced plan indicate the placement of rubble block within salt marsh. No destruction of salt marsh is authorized by this Order. Therefore, Areas 5, 7, 8 & 9 shall be constructed outside the salt marsh shown on the plan.
7. Placement of material for roadway resurfacing shall conform to the following standards:
 - a. The surface material of the roadway shall be of 1 1/2" washed, crushed stone to minimize washoff during high tide.
 - b. Placement of crushed stone for roadway resurfacing is limited to the filling of potholes, never causing the surface of the roadway to rise above the level of the marsh floor. Resurfacing of the roadway beyond the filling of potholes may be allowed as maintenance, provided that the following procedures are followed: written notification shall be provided to the Marshfield Conservation Commission and the Department at least two weeks prior to resurfacing. Said written notification shall specify the quantity (volume) of material to be used for resurfacing, and the length of roadway to be resurfaced. Resurfacing of the roadway shall never cause the surface of the roadway to rise above the level of the marsh floor. Resurfacing may proceed on schedule as stated in said notification, unless the Department notifies the applicant prior to the date that resurfacing is to occur, that an on-site inspection shall be required.
 - c. Because the Department recognizes the need for the roadway to be pitched and/or crowned to promote runoff of water collected on the roadway surface, the requirement that the roadway surface never rise above the level of the marsh floor, shall mean never rising above the higher side of the marsh floor.
 - d. Removal of crushed stone from the marsh surface shall occur by manual means only as necessary. Removal of crushed stone from the marsh surface by mechanical means is prohibited. The removal of crushed stone from the marsh surface and the creeks shall occur prior to any other work authorized by this Order.

5-5B
Figure 49: Order of Conditions for the Site SE 42-516

7.3 Soil Grain Data

Sieve Analysis											
Pan	Initial Mass (grams)	Sieved Mass (g)	Mass of Contents (g)	% of Total Mass	% Mass Passing		% of Total Mass (without gravel)	% Mass Passing			
25 mm	1356.0	1356.0	0.0	0.00	100.00		0.00				
19 mm	1383.0	1395.5	12.5	3.56	96.44		0.00				
12.5 mm	1323.0	1424.0	101.0	28.73	67.71		0.00				
9.5 mm	1321.5	1358.0	36.5	10.38	57.33	0.00	0.00	100.00			
4.75 mm	1260.0	1291.5	31.5	8.96	48.36	31.5	15.63	84.37			
3.55 mm	1235.5	1277.0	41.5	11.81	36.56	41.5	20.60	63.77			
Bottom Pan	1072.5	1201.0	128.5	36.56			63.77				
		Sample Mass	351.5	201.5							
Pan	Initial Mass (grams)	Sieved Mass (g)	Mass of Contents (g)	% of Total Mass	% Mass Passing	Mass of Contents (g)	% of Total Mass (without gravel)		% of Total Mass (small sieves only)	% mass passing	
1.19 mm	521.5	547.5	26.0	7.40	29.16	26.0	12.90	50.87			
.589 mm	576.0	599.5	23.5	6.69	22.48	23.5	11.66	39.21	1.19 mm	20.23	79.76653696
.297 mm	385.0	401.0	16.0	4.55	17.92	16.0	7.94	31.27	.589 mm	18.29	61.47859922
.150 mm	306.0	320.5	14.5	4.13	13.80	14.5	7.20	24.07	.297 mm	12.45	49.02723735
.075 mm	751.5	764.5	13.0	3.70	10.10	13.0	6.45	17.62	.150 mm	11.28	37.74319066
Bottom Pan	378.0	413.5	35.5	10.10		35.5	17.62	0.00	.075 mm	10.12	27.62645914
			128.5	100		201.5	100.00		Bottom Pan	27.63	0

7.4 Depth Data

November 11, 2011

Instruments:		Tides:			height
North	Troll	low	11-Nov	5:34	1
South	Hydrolab	high	11-Nov	11:29	9.1
		low	11-Nov	18:06	0.2
Date	Time	North	South	notes	
11-Nov	13:15	6.1		flooded	
11-Nov	13:20	5.9	5.3	capacity?	
11-Nov	13:25	5.8	5.2		
11-Nov	13:30	5.6	5.1		
11-Nov	13:35	5.4	5.0		
11-Nov	13:40	5.2	4.9		
11-Nov	13:45	5.1	4.7		
11-Nov	13:50	5.0	4.5		
11-Nov	13:55		4.3		
11-Nov	14:00	5.0	4.1		
11-Nov	14:05	4.8	4.0		
11-Nov	14:10	4.6	3.8		
11-Nov	14:15	4.5	3.7		
11-Nov	14:20	4.4	3.5		
11-Nov	14:25	4.2	3.3		
11-Nov	14:30	4.0	3.2		
11-Nov	14:35	3.9	3.0		
11-Nov	14:40	3.7	2.9		
11-Nov	14:45	3.5	2.7		
11-Nov	14:50	3.4	2.6	N unsubmerged	
11-Nov	14:55	3.2	2.4	TOC S	

November 15, 2011

					height	
			low	8:16	1.2	
Instruments:			high	14:08	8.9	
North	Troll		low	20:51	0.3	
South	Hydrolab					
					+2.19	
Time	T from Low	North	South	Notes	South from N	North
10:05	109	3.2	0.9		3.1	3.2
10:10	114	3.4	0.9		3.1	3.4
10:15	119	3.4	1.1		3.3	3.4
10:20	124	3.5	1.2		3.4	3.5
10:25	129	3.6	1.4	2 ft in culvert	3.5	3.6
10:30	134	3.5	1.5		3.6	3.5
10:35	139	3.6	1.6		3.7	3.6
10:40	144	3.8	1.7		3.9	3.8
10:45	149	4.1	1.8		4.0	4.1
10:50	154	4.2	2.0		4.2	4.2
10:55	159	4.4	2.1	TOC S	4.3	4.4
11:00	164	4.5	2.3	TOC N	4.5	4.5
11:05	169	4.7	2.5		4.7	4.7
11:10	174	4.8	2.6		4.8	4.8
11:15	179	5.0	2.8		5.0	5.0
11:20	184	5.1	2.9		5.1	5.1
11:25	189	5.2	3.1		5.3	5.2
11:30	194	5.3	3.3		5.5	5.3
11:35	199	5.7	3.4		5.6	5.7
11:40	204	5.9	3.5		5.7	5.9
11:45	209	6.0	3.7		5.9	6.0
11:50	214	6.2	3.8		6.0	6.2
11:55	219	6.3	3.9		6.1	6.3
12:00	224	6.5	4.1		6.3	6.5
12:05	229	6.8	4.3		6.5	6.8
12:10	234	6.9	4.4		6.6	6.9
12:15	239	7.0	4.5		6.7	7.0
12:20	244	7.1	4.7		6.9	7.1
12:25	249	7.1	4.8		6.9	7.1
12:30	254	7.3	4.9		7.0	7.3
12:35	259	7.5	5.0		7.1	7.5
12:40	264	7.6	5.0		7.2	7.6
12:45	269	7.8	5.1		7.3	7.8
12:50	274	8.0	5.2		7.4	8.0
12:55	279	8.1	5.3		7.5	8.1

13:00	284	8.2	5.4		7.6	8.2
13:05	289	8.3	5.5		7.7	8.3
13:10	294	8.4	5.6		7.8	8.4
13:15	299	8.4	5.7		7.9	8.4
13:20	304	8.5	5.7		7.9	8.5
13:25	309	8.5	5.8		8.0	8.5
13:30	314	8.6	5.9		8.1	8.6
13:35	319	8.7	5.9		8.1	8.7
13:40	324	8.7	6.0		8.2	8.7
13:45	329	8.7	6.0		8.2	8.7
13:50	334	7.5	6.1		8.3	7.5
13:55	339	7.3	6.1		8.3	7.3
14:00	344	7.5	6.1		8.3	7.5
14:05	349	7.5	6.1		8.3	7.5
14:10	354	7.5	6.1		8.3	7.5
14:15	359	7.4	6.1		8.3	7.4
14:20	364	7.4	6.0		8.2	7.4
14:25	369	7.2	5.9		8.1	7.2
14:30	374	7.2	5.9		8.1	7.2
14:35	379	7.1	5.8		8.0	7.1
14:40	384	7.0	5.8		8.0	7.0
14:45	389	7.0	5.7		7.9	7.0
14:50	394	6.8	5.6		7.8	6.8
14:55	399	6.7	5.6		7.8	6.7
15:00	404	6.6	5.5		7.7	6.6
15:05	409	6.4	5.4	stop overflow	7.6	6.4
15:10	414	6.2	5.3		7.5	6.2

November 26-27, 2011

				+ 2.34	
time	N reading	S reading	Notes	Fixed S	difference
9:40	8.332	5.15	N over road edge	7.49	0.846
9:50	8.669	5.73		8.07	0.601
10:00	8.968	6.12		8.46	0.512
10:10	9.201	6.50		8.84	0.356
10:20	9.454	6.89		9.23	0.221
10:30	9.759	7.28		9.62	0.138
10:40	10.054	7.57		9.91	0.141
10:50	10.272	7.86		10.20	0.068
11:00	10.454	8.06		10.40	0.056
11:10	10.588	8.25		10.59	-0.005
11:20	10.699	8.35		10.69	0.009
11:30	10.762	8.45		10.79	-0.025
11:40	10.790	8.45		10.79	0.003
11:50	10.755	8.45		10.79	-0.032
12:00	10.615	8.35		10.69	-0.074
12:10	10.472	8.16		10.50	-0.024
12:20	10.277	7.96		10.30	-0.024
12:30	10.045	7.77		10.11	-0.062
12:40	9.799	7.57		9.91	-0.114
12:50	9.547	7.28		9.62	-0.074
13:00	9.304	7.09		9.43	-0.124
13:10	9.059				
13:20	8.776				
13:30	8.461				
13:40	8.044				
13:50	7.467				
14:00	6.854				
14:10	6.308				
14:20	5.902				
14:30	5.575				
14:40	5.082				
14:50	4.643				
15:00	4.044				
15:10	3.739				
15:20	3.301				
15:30	2.965				
15:40	2.613				
15:50	2.334				
16:00	2.195				
16:10	2.157				

16:20	2.085				
16:30	2.043				
16:40	2.049				
16:50	2.048				
17:00	2.065				
17:10	2.089				
17:20	2.070				
17:30	2.072				
17:40	2.121				
17:50	2.155				
18:00	2.190				
18:10	2.218				
18:20	2.237				
18:30	2.256				
18:40	2.259				
18:50	2.286				
19:00	2.320				
19:10	2.342				
19:20	2.379				
19:30	2.381				
19:40	2.361				
19:50	2.389				
20:00	2.416				
20:10	2.420				
20:20	2.446				
20:30	2.472				
20:40	3.078				
20:50	3.575				
21:00	4.016				
21:10	4.476				
21:20	4.986				
21:30	5.432				
21:40	5.833				
21:50	6.333				
22:00	6.819				
22:10	7.240				
22:20	7.685				
22:30	8.046				
22:40	8.358				
22:50	8.541				
23:00	8.744				
23:10	8.857				
23:20	9.065				
23:30	9.215				

23:40	9.373				
23:50	9.510				
0:00	9.598				
0:10	9.665				
0:20	9.667				
0:30	9.658				
0:40	9.593				
0:50	9.474				
1:00	9.312				
1:10	9.119				
1:20	8.909				
1:30	8.728				
1:40	8.514				
1:50	8.276				
2:00	7.965				
2:10	7.702				
2:20	7.366				
2:30	7.065				
2:40	6.721				
2:50	6.400				
3:00	6.016				
3:10	5.705				
3:20	5.323				
3:30	4.948				
3:40	4.656				
3:50	4.191				
4:00	3.914				
4:10	3.507				
4:20	3.173				
4:30	2.929				
4:40	2.756				
4:50	2.720				
5:00	2.718				
5:10	2.774				
5:20	2.772				
5:30	2.766				
5:40	2.759				
5:50	2.808				
6:00	2.823				
6:10	2.884				
6:20	2.848				
6:30	2.846				
6:40	2.861				
6:50	2.896				

7:00	2.871				
7:10	2.885				
7:20	2.844				
7:30	2.816				
7:40	2.772				
7:50	2.714				
8:00	2.614				
8:10	3.032				
8:20	3.408				
8:30	3.669				
8:40	4.124				
8:50	4.519				
9:00	4.912				
9:10	5.306				
9:20	5.610				
9:30	6.037				
9:40	6.547				
9:50	6.953				
10:00	7.369				
10:10	7.771				
10:20	8.157				
10:30	8.496				
10:40	8.864				
10:50	9.183				
11:00	9.470				
11:10	9.744				
11:20	10.018				
11:30	10.260				
11:40	10.479				
11:50	10.665				
12:00	10.819				
12:10	10.914				
12:20	10.995				
12:30	11.017				
12:40	10.965				
12:50	10.890				

November 30-December 1

Important Depths								
BOC N	2.74		BOC S			2.53		
TOC N	5.74		TOC S			5.53		
mid road	8.68		mid road			8.68		
N road edge	9.68		S road edge			9.345		
Time	Mins	hours	N	S		N depth	S depth from N probe	head difference
8:50	0	-0.36667	1.54	0		1.5	2.6	-1.1
9:00	5	-0.2	1.47	0		1.5	2.6	-1.1
9:10	10	-0.03333	1.49	0		1.5	2.6	-1.1
9:20	15	0.133333	1.44	0		1.4	2.6	-1.2
9:30	20	0.3	1.40	0		1.4	2.6	-1.2
9:40	25	0.466667	1.33	0		1.3	2.6	-1.3
9:50	30	0.633333	1.29	0		1.3	2.6	-1.3
10:00	35	0.8	1.28	0		1.3	2.6	-1.3
10:10	40	0.966667	1.33	0		1.3	2.6	-1.3
10:20	45	1.133333	1.74	0		1.7	2.6	-0.9
10:30	50	1.3	2.04	0		2.0	2.6	-0.6
10:40	55	1.466667	2.10	0		2.1	2.6	-0.5
10:50	60	1.633333	2.55	0		2.6	2.6	0.0
11:00	65	1.8	2.92	0.19	start flow to South	2.9	2.8	0.1
11:10	70	1.966667	3.12	0.49		3.1	3.1	0.0
11:20	75	2.133333	3.46	0.78		3.5	3.4	0.1
11:30	80	2.3	3.52	1.07		3.5	3.7	-0.1
11:40	85	2.466667	4.13	1.36		4.1	4.0	0.2
11:50	90	2.633333	4.47	1.65		4.5	4.3	0.2
12:00	95	2.8	4.66	2.04		4.7	4.6	0.0
12:10	100	2.966667	4.91	2.23		4.9	4.8	0.1
12:20	105	3.133333	5.34	2.52		5.3	5.1	0.2
12:30	110	3.3	5.77	2.91	TOC S	5.8	5.5	0.3
12:40	115	3.466667	6.09	3.20		6.1	5.8	0.3
12:50	120	3.633333	6.36	3.59		6.4	6.2	0.2
13:00	125	3.8	6.76	3.88		6.8	6.5	0.3
13:10	130	3.966667	7.08	4.17		7.1	6.8	0.3
13:20	135	4.133333	7.45	4.47		7.5	7.1	0.4
13:30	140	4.3	7.70	4.76		7.7	7.4	0.3
13:40	145	4.466667	8.10	5.05		8.1	7.6	0.5
13:50	150	4.633333	8.26	5.34		8.3	7.9	0.3
14:00	155	4.8	8.52	5.53		8.5	8.1	0.4
14:10	160	4.966667	8.69	5.83		8.7	8.4	0.3

14:20	165	5.133333	8.91	6.12		8.9	8.7	0.2
14:30	170	5.3	9.07	6.31		9.1	8.9	0.2
14:40	175	5.466667	9.17	6.41		9.2	9.0	0.2
14:50	180	5.633333	9.35	6.60		9.4	9.2	0.1
15:00	185	5.8	9.41	6.70		9.4	9.3	0.1
15:10	190	5.966667	9.42	6.80		9.4	9.4	0.0
15:20	195	6.133333	9.41	6.80		9.4	9.4	0.0
15:30	200	6.3	9.32	6.70		9.3	9.3	0.0
15:40	205	6.466667	9.20	6.60		9.2	9.2	0.0
15:50	210	6.633333	9.11	6.50		9.1	9.1	0.0
16:00	215	6.8	9.02	6.41		9.0	9.0	0.0
16:10	220	6.966667	8.80	6.21		8.8	8.8	0.0
16:20	225	7.133333	8.57	6.12		8.6	8.7	-0.1
16:30	230	7.3	8.33	5.92		8.3	8.5	-0.2
16:40	235	7.466667	8.10	5.83		8.1	8.4	-0.3
16:50	240	7.633333	7.87	5.63		7.9	8.2	-0.4
17:00	245	7.8	7.59	5.53		7.6	8.1	-0.5
17:10	250	7.966667	7.33	5.24		7.3	7.8	-0.5
17:20	255	8.133333	6.96	4.95		7.0	7.6	-0.6
17:30	260	8.3	6.73	4.66		6.7	7.3	-0.5
17:40	265	8.466667	6.31	4.27		6.3	6.9	-0.6
17:50	270	8.633333	6.03	3.98		6.0	6.6	-0.5
18:00	275	8.8	5.72	3.69		5.7	6.3	-0.6
18:10	280	8.966667	5.41	3.40		5.4	6.0	-0.6
18:20	285	9.133333	5.10	3.11		5.1	5.7	-0.6
18:30	290	9.3	4.80	2.82		4.8	5.4	-0.6
18:40	295	9.466667	4.45	2.52		4.4	5.1	-0.7
18:50	300	9.633333	4.10	2.14		4.1	4.7	-0.6
19:00	305	9.8	3.81	1.84		3.8	4.4	-0.6
19:10	310	9.966667	3.53	1.55		3.5	4.2	-0.6
19:20	315	10.13333	3.23	1.36		3.2	4.0	-0.7
19:30	320	10.3	2.95	1.07		2.9	3.7	-0.7
19:40	325	10.46667	2.68	0.78		2.7	3.4	-0.7
19:50	330	10.63333	2.43	0.49		2.4	3.1	-0.7
20:00	335	10.8	2.30	0.29		2.3	2.9	-0.6
20:10	340	10.96667	2.29	0.10		2.3	2.7	-0.4
20:20	345	11.13333	2.31	0.10		2.3	2.7	-0.4
20:30	350	11.3	2.35	0.10		2.4	2.7	-0.3
20:40	355	11.46667	2.39	0.10		2.4	2.7	-0.3
20:50	360	11.63333	2.40	0.10		2.4	2.7	-0.3
21:00	365	11.8	2.42	0.10		2.4	2.7	-0.3
21:10	370	11.96667	2.43	0.10		2.4	2.7	-0.3
21:20	375	12.13333	2.43	0.10		2.4	2.7	-0.3
21:30	380	12.3	2.44	0.19		2.4	2.8	-0.4

21:40	385	12.46667	2.46	0.19		2.5	2.8	-0.3
21:50	390	12.63333	2.46	0.19		2.5	2.8	-0.3
22:00	395	12.8	2.46	0.19		2.5	2.8	-0.3
22:10	400	12.96667	2.49	0.19		2.5	2.8	-0.3
22:20	405	13.13333	2.48	0.19		2.5	2.8	-0.3
22:30	410	13.3	2.50	0.19		2.5	2.8	-0.3
22:40	415	13.46667	2.50	0.19		2.5	2.8	-0.3
22:50	420	13.63333	2.52	0.19		2.5	2.8	-0.3
23:00	425	13.8	2.53	0.19		2.5	2.8	-0.3
23:10	430	13.96667	2.53	0.19		2.5	2.8	-0.3
23:20	435	14.13333	2.50	0.19		2.5	2.8	-0.3
23:30	440	14.3	2.44	0.19		2.4	2.8	-0.4
23:40	445	14.46667	2.94	0.19		2.9	2.8	0.2
23:50	450	14.63333	3.20	0.19		3.2	2.8	0.4
0:00	455	14.8	3.47	0.19		3.5	2.8	0.7
0:10	460	14.96667	3.82	0.39		3.8	3.0	0.8
0:20	465	15.13333	4.12	0.49		4.1	3.1	1.0
0:30	470	15.3	4.39	0.87		4.4	3.5	0.9
0:40	475	15.46667	4.72	1.17		4.7	3.8	1.0
0:50	480	15.63333	5.05	1.55		5.0	4.2	0.9
1:00	485	15.8	5.42	1.84		5.4	4.4	1.0
1:10	490	15.96667	5.72	2.23		5.7	4.8	0.9
1:20	495	16.13333	6.04	2.52		6.0	5.1	0.9
1:30	500	16.3	6.42	2.91		6.4	5.5	0.9
1:40	505	16.46667	6.70	3.20		6.7	5.8	0.9
1:50	510	16.63333	7.11	3.50		7.1	6.1	1.0
2:00	515	16.8	7.37	3.88		7.4	6.5	0.9
2:10	520	16.96667	7.65	4.17		7.7	6.8	0.9
2:20	525	17.13333	7.91	4.37		7.9	7.0	0.9
2:30	530	17.3	8.07	4.66		8.1	7.3	0.8
2:40	535	17.46667	8.30	4.95		8.3	7.6	0.7
2:50	540	17.63333	8.47	5.15		8.5	7.7	0.7
3:00	545	17.8	8.50	5.34		8.5	7.9	0.6
3:10	550	17.96667	8.50	5.53		8.5	8.1	0.4
3:20	555	18.13333	8.55	5.63		8.5	8.2	0.3
3:30	560	18.3	8.60	5.73		8.6	8.3	0.3
3:40	565	18.46667	8.66	5.92		8.7	8.5	0.1
3:50	570	18.63333	8.66	5.92		8.7	8.5	0.1
4:00	575	18.8	8.64	5.92		8.6	8.5	0.1
4:10	580	18.96667	8.55	5.92		8.5	8.5	0.0
4:20	585	19.13333	8.48	5.83		8.5	8.4	0.1
4:30	590	19.3	8.47	5.73		8.5	8.3	0.1
4:40	595	19.46667	8.40	5.63		8.4	8.2	0.2
4:50	600	19.63333	8.24	5.44		8.2	8.0	0.2

5:00	605	19.8	8.08	5.34		8.1	7.9	0.1
5:10	610	19.96667	7.92	5.15		7.9	7.7	0.2
5:20	615	20.13333	7.72	4.95		7.7	7.6	0.2
5:30	620	20.3	7.53	4.76		7.5	7.4	0.2
5:40	625	20.46667	7.30	4.56		7.3	7.2	0.1
5:50	630	20.63333	7.14	4.37		7.1	7.0	0.2
6:00	635	20.8	6.93	4.17		6.9	6.8	0.2
6:10	640	20.96667	6.70	3.98		6.7	6.6	0.1
6:20	645	21.13333	6.44	3.69		6.4	6.3	0.1
6:30	650	21.3	6.13	3.50		6.1	6.1	0.0
6:40	655	21.46667	5.86	3.20		5.9	5.8	0.1
6:50	660	21.63333	5.63	3.01		5.6	5.6	0.0
7:00	665	21.8	5.31	2.72		5.3	5.3	0.0
7:10	670	21.96667	5.10	2.52		5.1	5.1	0.0
7:20	675	22.13333	4.77	2.23		4.8	4.8	-0.1
7:30	680	22.3	4.50	2.04		4.5	4.6	-0.1
7:40	685	22.46667	4.23	1.75		4.2	4.3	-0.1
7:50	690	22.63333	3.97	1.46		4.0	4.1	-0.1
8:00	695	22.8	3.72	1.26		3.7	3.9	-0.1
8:10	700	22.96667	3.40	1.07		3.4	3.7	-0.3
8:20	705	23.13333	3.15	0.78		3.2	3.4	-0.2
8:30	710	23.3	2.98	0.58		3.0	3.2	-0.2
8:40	715	23.46667	2.80	0.49		2.8	3.1	-0.3
8:50	720	23.63333	2.72	0.49		2.7	3.1	-0.4
9:00	725	23.8	2.70	0.49		2.7	3.1	-0.4
9:10	730	23.96667	2.66	0.49		2.7	3.1	-0.4
9:20	735	24.13333	2.62	0.49		2.6	3.1	-0.5
9:30	740	24.3	2.58	0.49		2.6	3.1	-0.5
9:40	745	24.46667	2.57	0.49		2.6	3.1	-0.5
9:50	750	24.63333	2.52	0.49		2.5	3.1	-0.6
10:00	755	24.8	2.54	0.49		2.5	3.1	-0.5
10:10	760	24.96667	2.51	0.49		2.5	3.1	-0.6
10:20	765	25.13333	2.48	0.49		2.5	3.1	-0.6
10:30	770	25.3	2.45	0.49		2.4	3.1	-0.6
10:40	775	25.46667	2.42	0.49		2.4	3.1	-0.7
10:50	780	25.63333	2.37	0.49		2.4	3.1	-0.7
11:00	785	25.8	2.42	0.49		2.4	3.1	-0.7
11:10	790	25.96667	2.44	0.49		2.4	3.1	-0.6
11:20	795	26.13333	2.81	0.49		2.8	3.1	-0.3
11:30	800	26.3	3.05	0.49		3.1	3.1	0.0
11:40	805	26.46667	3.21	0.49		3.2	3.1	0.1
11:50	810	26.63333	3.45	0.49		3.5	3.1	0.4
12:00	815	26.8	3.72	0.49		3.7	3.1	0.6
12:10	820	26.96667	3.98	0.68		4.0	3.3	0.7

12:20	825	27.13333	4.29	1.07		4.3	3.7	0.6
12:30	830	27.3	4.48	1.36		4.5	4.0	0.5
12:40	835	27.46667	4.78	1.55		4.8	4.2	0.6
12:50	840	27.63333	5.14	1.84		5.1	4.4	0.7
13:00	845	27.8	5.42	2.23		5.4	4.8	0.6
13:10	850	27.96667	5.72	2.43		5.7	5.0	0.7
13:20	855	28.13333	5.99	2.72		6.0	5.3	0.7
13:30	860	28.3	6.33	3.11		6.3	5.7	0.6
13:40	865	28.46667	6.69	3.40		6.7	6.0	0.7
13:50	870	28.63333	6.99	3.79		7.0	6.4	0.6

December 12-13, 2011

- The S probe is 1.2 feet higher than N probe, so readings are adjusted to +1.2 so they are level on the graph
- Flow starts in culvert 113 min after low tide

elevations		From N Probe	Tides:			height			
N probe	10.7	0	low	12-Dec	6:28	0.8	TOC N	3.61	
middle road	4.15	6.55	high	12-Dec	12:22	9.3	TOC S	2.2	3.4
N road edge	3.15	7.55	low	12-Dec	19:02	-0.2			
S road edge	3.485	7.215	high	13-Dec	1:00	8.1			
S probe	9.5	1.2	low	13-Dec	7:10	0.7			
			high	13-Dec	13:04	9.3			

Time	Minutes	minutes after LOW	hours	North Reading	South Reading	South observed	S culvert	north observed	N culvert	North Adjustment	South Adjustment	South	North	North Final	South Final
8:15			0				flow start	2.37	flow start						
8:20	0	112	1.866666667	2.57	0.8							0.5	2.6	2.3	1.7
8:30	10	122	2.033333333	2.90	0.9							0.6	2.9	2.6	1.8
8:40	20	132	2.2	3.18	1.3	0.8	1.53	3.10	1.35		-0.3	1.0	3.2	2.9	2.2
8:50	30	142	2.366666667	3.46	1.6							1.3	3.5	3.2	2.5
9:00	40	152	2.533333333	3.82	1.9	1.6					-0.3	1.6	3.8	3.5	2.8
9:10	50	162	2.7	4.09	2.3							2.0	4.1	3.8	3.2
9:20	60	172	2.866666667	4.49	2.6							2.3	4.5	4.2	3.5
9:30	70	182	3.033333333	4.85	2.9							2.6	4.8	4.5	3.8
9:40	80	192	3.2	5.19	3.3		full		full - head			3.0	5.2	4.9	4.2
9:50	90	202	3.366666667	5.55	3.6							3.3	5.5	5.2	4.5
10:00	100	212	3.533333333	5.86	4.0							3.7	5.9	5.6	4.9
10:10	110	222	3.7	6.20	4.3							4.0	6.2	5.9	5.2
10:20	120	232	3.866666667	6.49	4.6							4.3	6.5	6.2	5.5

10:30	130	242	4.033333333	6.76	4.9							4.6	6.8	6.5	5.8
10:40	140	252	4.2	6.96	5.1							4.8	7.0	6.7	6.0
10:50	150	262	4.366666667	7.09	5.4							5.1	7.1	6.8	6.3
11:00	160	272	4.533333333	7.27	5.6			starts to reach top				5.3	7.3	7.0	6.5
11:10	170	282	4.7	7.38	5.8			0.2 over rd				5.5	7.4	7.1	6.7
11:20	180	292	4.866666667	7.52	6.0		at S edge	at N edge				5.7	7.5	7.2	6.9
11:30	190	302	5.033333333	7.60	6.2							5.9	7.6	7.3	7.1
11:40	200	312	5.2	7.68	6.3							6.0	7.7	7.4	7.2
11:50	210	322	5.366666667	7.71	6.5							6.2	7.7	7.4	7.4
12:00	220	332	5.533333333	7.76	6.6					-0.3		6.3	7.8	7.5	7.5
12:10	230	342	5.7	7.74	6.6							6.3	7.7	7.4	7.5
12:20	240	352	5.866666667	7.71	6.6							6.3	7.7	7.4	7.5
12:30	250	362	6.033333333	7.65	6.5							6.2	7.6	7.3	7.4
12:40	260	372	6.2	7.58	6.5							6.2	7.6	7.3	7.4
12:50	270	382	6.366666667	7.47	6.4							6.1	7.5	7.2	7.3
13:00	280	392	6.533333333	7.32	6.3							6.0	7.3	7.0	7.2
13:10	290	402	6.7	7.09	6.1							5.8	7.1	6.8	7.0
13:20	300	412	6.866666667	6.84	5.9							5.6	6.8	6.5	6.8
13:30	310	422	7.033333333	6.63	5.7							5.4	6.6	6.3	6.6
13:40	320	432	7.2	6.37	5.5							5.2	6.4	6.1	6.4
13:50	330	442	7.366666667	6.08	5.2							4.9	6.1	5.8	6.1
14:00	340	452	7.533333333	5.80	5.0							4.7	5.8	5.5	5.9
14:10	350	462	7.7	5.49	4.7							4.4	5.5	5.2	5.6
14:20	360	472	7.866666667	5.22	4.4							4.1	5.2	4.9	5.3
14:30	370	482	8.033333333	4.90	4.2							3.9	4.9	4.6	5.1
14:40	380	492	8.2	4.59	3.9							3.6	4.6	4.3	4.8
14:50	390	502	8.366666667	4.30	3.6							3.3	4.3	4.0	4.5
15:00	400	512	8.533333333	3.99	3.2							2.9	4.0	3.7	4.1
15:10	410	522	8.7	3.65	2.9							2.6	3.7	3.4	3.8

15:20	420	532	8.866666667	3.35	2.6							2.3	3.4	3.1	3.5
15:30	430	542	9.033333333	3.00	2.3							2.0	3.0	2.7	3.2
15:40	440	552	9.2	2.72	2.0							1.7	2.7	2.4	2.9
15:50	450	562	9.366666667	2.40	1.8							1.5	2.4	2.1	2.7
16:00	460	572	9.533333333	2.07	1.6							1.3	2.1	1.8	2.5
16:10	470	582	9.7	1.78	1.3							1.0	1.8	1.5	2.2
16:20	480	592	9.866666667	1.51	1.0							0.7	1.5	1.2	1.9
16:30	490	602	10.03333333	1.34	0.7							0.4	1.3	1.0	1.6
16:40	500	612	10.2	1.34	0.6							0.3	1.3	1.0	1.5
16:50	510	622	10.36666667	1.36	0.5							0.2	1.4	1.1	1.4
17:00	520	632	10.53333333	1.36	0.5							0.2	1.4	1.1	1.4
17:10	530	642	10.7	1.39	0.5							0.2	1.4	1.1	1.4
17:20	540	652	10.86666667	1.40	0.5							0.2	1.4	1.1	1.4
17:30	550	662	11.03333333	1.41	0.5							0.2	1.4	1.1	1.4
17:40	560	672	11.2	1.41	0.5							0.2	1.4	1.1	1.4
17:50	570	682	11.36666667	1.39	0.5							0.2	1.4	1.1	1.4
18:00	580	692	11.53333333	1.39	0.5							0.2	1.4	1.1	1.4
18:10	590	702	11.7	1.41	0.5							0.2	1.4	1.1	1.4
18:20	600	712	11.86666667	1.41	0.5							0.2	1.4	1.1	1.4
18:30	610	722	12.03333333	1.42	0.5							0.2	1.4	1.1	1.4
18:40	620	732	12.2	1.41	0.5							0.2	1.4	1.1	1.4
18:50	630	742	12.36666667	1.43	0.6							0.3	1.4	1.1	1.5
19:00	640	752	12.53333333	1.42	0.6							0.3	1.4	1.1	1.5
19:10	650	762	12.7	1.43	0.6							0.3	1.4	1.1	1.5
19:20	660	772	12.86666667	1.43	0.6							0.3	1.4	1.1	1.5
19:30	670	782	13.03333333	1.43	0.5							0.2	1.4	1.1	1.4
19:40	680	792	13.2	1.43	0.5							0.2	1.4	1.1	1.4
19:50	690	802	13.36666667	1.44	0.5							0.2	1.4	1.1	1.4
20:00	700	812	13.53333333	1.44	0.5							0.2	1.4	1.1	1.4
20:10	710	822	13.7	1.45	0.5							0.2	1.5	1.2	1.4
20:20	720	832	13.86666667	1.47	0.5							0.2	1.5	1.2	1.4

20:30	730	842	14.03333333	1.46	0.5							0.2	1.5	1.2	1.4
20:40	740	852	14.2	1.46	0.5							0.2	1.5	1.2	1.4
20:50	750	862	14.36666667	1.50	0.5							0.2	1.5	1.2	1.4
21:00	760	872	14.53333333	1.76	0.5							0.2	1.8	1.5	1.4
21:10	770	882	14.7	2.24	0.5							0.2	2.2	1.9	1.4
21:20	780	892	14.86666667	2.61	0.5							0.2	2.6	2.3	1.4
21:30	790	902	15.03333333	2.89	0.6							0.3	2.9	2.6	1.5
21:40	800	912	15.2	3.22	0.7							0.4	3.2	2.9	1.6
21:50	810	922	15.36666667	3.55	1.0							0.7	3.6	3.3	1.9
22:00	820	932	15.53333333	3.87	1.4							1.1	3.9	3.6	2.3
22:10	830	942	15.7	4.13	1.7							1.4	4.1	3.8	2.6
22:20	840	952	15.86666667	4.48	2.0							1.7	4.5	4.2	2.9
22:30	850	962	16.03333333	4.77	2.4							2.1	4.8	4.5	3.3
22:40	860	972	16.2	5.09	2.7							2.4	5.1	4.8	3.6
22:50	870	982	16.36666667	5.36	3.0							2.7	5.4	5.1	3.9
23:00	880	992	16.53333333	5.60	3.4							3.1	5.6	5.3	4.3
23:10	890	1002	16.7	5.87	3.6							3.3	5.9	5.6	4.5
23:20	900	1012	16.86666667	6.12	3.9							3.6	6.1	5.8	4.8
23:30	910	1022	17.03333333	6.39	4.2							3.9	6.4	6.1	5.1
23:40	920	1032	17.2	6.52	4.5							4.2	6.5	6.2	5.4
23:50	930	1042	17.36666667	6.66	4.7							4.4	6.7	6.4	5.6
0:00	940	1052	17.53333333	6.80	4.9							4.6	6.8	6.5	5.8
0:10	950	1062	17.7	6.87	5.0							4.7	6.9	6.6	5.9
0:20	960	1072	17.86666667	6.92	5.1							4.8	6.9	6.6	6.0
0:30	970	1082	18.03333333	6.90	5.2							4.9	6.9	6.6	6.1
0:40	980	1092	18.2	6.94	5.3							5.0	6.9	6.6	6.2
0:50	990	1102	18.36666667	6.90	5.3							5.0	6.9	6.6	6.2
1:00	1000	1112	18.53333333	6.84	5.3							5.0	6.8	6.5	6.2
1:10	1010	1122	18.7	6.76	5.2							4.9	6.8	6.5	6.1
1:20	1020	1132	18.86666667	6.70	5.1							4.8	6.7	6.4	6.0
1:30	1030	1142	19.03333333	6.58	5.0							4.7	6.6	6.3	5.9

1:40	1040	1152	19.2	6.43	4.9							4.6	6.4	6.1	5.8
1:50	1050	1162	19.36666667	6.25	4.8							4.5	6.2	5.9	5.7
2:00	1060	1172	19.53333333	6.10	4.6							4.3	6.1	5.8	5.5
2:10	1070	1182	19.7	5.97	4.4							4.1	6.0	5.7	5.3
2:20	1080	1192	19.86666667	5.78	4.2							3.9	5.8	5.5	5.1
2:30	1090	1202	20.03333333	5.50	4.0							3.7	5.5	5.2	4.9
2:40	1100	1212	20.2	5.26	3.7							3.4	5.3	5.0	4.6
2:50	1110	1222	20.36666667	5.05	3.5							3.2	5.1	4.8	4.4
3:00	1120	1232	20.53333333	4.90	3.3							3.0	4.9	4.6	4.2
3:10	1130	1242	20.7	4.59	3.1							2.8	4.6	4.3	4.0
3:20	1140	1252	20.86666667	4.33	2.8							2.5	4.3	4.0	3.7
3:30	1150	1262	21.03333333	4.07	2.6							2.3	4.1	3.8	3.5
3:40	1160	1272	21.2	3.79	2.3							2.0	3.8	3.5	3.2
3:50	1170	1282	21.36666667	3.52	2.0							1.7	3.5	3.2	2.9
4:00	1180	1292	21.53333333	3.21	1.8							1.5	3.2	2.9	2.7
4:10	1190	1302	21.7	2.94	1.6							1.3	2.9	2.6	2.5
4:20	1200	1312	21.86666667	2.64	1.4							1.1	2.6	2.3	2.3
4:30	1210	1322	22.03333333	2.43	1.1							0.8	2.4	2.1	2.0
4:40	1220	1332	22.2	2.13	0.9							0.6	2.1	1.8	1.8
4:50	1230	1342	22.36666667	1.86	0.6							0.3	1.9	1.6	1.5
5:00	1240	1352	22.53333333	1.72	0.4							0.1	1.7	1.4	1.3
5:10	1250	1362	22.7	1.69	0.4							0.1	1.7	1.4	1.3
5:20	1260	1372	22.86666667	1.72	0.4							0.1	1.7	1.4	1.3
5:30	1270	1382	23.03333333	1.71	0.4							0.1	1.7	1.4	1.3
5:40	1280	1392	23.2	1.72	0.4							0.1	1.7	1.4	1.3
5:50	1290	1402	23.36666667	1.74	0.4							0.1	1.7	1.4	1.3
6:00	1300	1412	23.53333333	1.75	0.4							0.1	1.8	1.5	1.3
6:10	1310	1422	23.7	1.77	0.5							0.2	1.8	1.5	1.4
6:20	1320	1432	23.86666667	1.78	0.5							0.2	1.8	1.5	1.4
6:30	1330	1442	24.03333333	1.79	0.5							0.2	1.8	1.5	1.4
6:40	1340	1452	24.2	1.81	0.5							0.2	1.8	1.5	1.4

6:50	1350	1462	24.36666667	1.80	0.5							0.2	1.8	1.5	1.4
7:00	1360	1472	24.53333333	1.80	0.5							0.2	1.8	1.5	1.4
7:10	1370	1482	24.7	1.81	0.5							0.2	1.8	1.5	1.4
7:20	1380	1492	24.86666667	1.86	0.5							0.2	1.9	1.6	1.4
7:30	1390	1502	25.03333333	1.84	0.5							0.2	1.8	1.5	1.4
7:40	1400	1512	25.2	1.84	0.5							0.2	1.8	1.5	1.4
7:50	1410	1522	25.36666667	1.80	0.5							0.2	1.8	1.5	1.4
8:00	1420	1532	25.53333333	1.79	0.5							0.2	1.8	1.5	1.4
8:10	1430	1542	25.7	1.75	0.5							0.2	1.8	1.5	1.4
8:20	1440	1552	25.86666667	1.97	0.5							0.2	2.0	1.7	1.4
8:30	1450	1562	26.03333333	2.35	0.4							0.1	2.4	2.1	1.3
8:40	1460	1572	26.2	2.58	0.4							0.1	2.6	2.3	1.3
8:50	1470	1582	26.36666667	2.88	0.4							0.1	2.9	2.6	1.3
9:00	1480	1592	26.53333333	3.17	0.6							0.3	3.2	2.9	1.5
9:10	1490	1602	26.7	3.48	0.8							0.5	3.5	3.2	1.7
9:20	1500	1612	26.86666667	3.75	1.2							0.9	3.7	3.4	2.1
9:30	1510	1622	27.03333333	4.03	1.5							1.2	4.0	3.7	2.4
9:40	1520	1632	27.2	4.31	1.8							1.5	4.3	4.0	2.7
9:50	1530	1642	27.36666667	4.63	2.1							1.8	4.6	4.3	3.0
10:00	1540	1652	27.53333333	4.93	2.5							2.2	4.9	4.6	3.4
10:10	1550	1662	27.7	5.20	2.8							2.5	5.2	4.9	3.7
10:20	1560	1672	27.86666667	5.47	3.2							2.9	5.5	5.2	4.1
10:30	1570	1682	28.03333333	5.83	3.5							3.2	5.8	5.5	4.4
10:40	1580	1692	28.2	6.11	3.9							3.6	6.1	5.8	4.8
10:50	1590	1702	28.36666667	6.42	4.3							4.0	6.4	6.1	5.2
11:00	1600	1712	28.53333333	6.66	4.6							4.3	6.7	6.4	5.5
11:10	1610	1722	28.7	6.92	4.9							4.6	6.9	6.6	5.8
11:20	1620	1732	28.86666667	7.12	5.1							4.8	7.1	6.8	6.0
11:30	1630	1742	29.03333333	7.31	5.4							5.1	7.3	7.0	6.3
11:40	1640	1752	29.2	7.45	5.6							5.3	7.5	7.2	6.5
11:50	1650	1762	29.36666667	7.56	5.8							5.5	7.6	7.3	6.7

12:00	1660	1772	29.53333333	7.70	6.1							5.8	7.7	7.4	7.0
12:10	1670	1782	29.7	7.84	6.3							6.0	7.8	7.5	7.2
12:20	1680	1792	29.86666667	7.97	6.5							6.2	8.0	7.7	7.4
12:30	1690	1802	30.03333333	8.05	6.7							6.4	8.1	7.8	7.6
12:40	1700	1812	30.2	8.14	6.8							6.5	8.1	7.8	7.7
12:50	1710	1822	30.36666667	8.17	6.8							6.5	8.2	7.9	7.7
13:00	1720	1832	30.53333333	8.17	6.9							6.6	8.2	7.9	7.8
13:10	1730	1842	30.7	8.12	6.9							6.6	8.1	7.8	7.8
13:20	1740	1852	30.86666667	8.05	6.8							6.5	8.1	7.8	7.7

7.5 Flowrates

November 30-December 1

TIDES		height	
low	30-Nov	9:12	0.5
high	30-Nov	15:11	9.1
low	30-Nov	21:48	0
high	1-Dec	3:54	8.4
low	1-Dec	10:08	0.9
high	1-Dec	16:07	8.6

Important Depths			
BOC N	2.74	BOC S	2.53
TOC N	5.74	TOC S	5.53
mid road	8.68	mid road	8.68
N road edge	9.68	S road edge	9.345

L	28
z	0.21
D	3
n	0.036
C	0.88
g	32.2
S up	0.0075
S down	-0.0075

hours		S	N depth	S depth from N probe	N-BOCN	S-BOCS	y	h1	h4	h1-h4	h1 / h4	h4/D	h1-z/D	2g(h1-h4)	1-2y/d	theta	A	P	R	V	Q MANNINGS	Q energy	Q TYPE 4	Q EBB
-0.37		0	1.5	2.6	-1.2	0.1															0.0			
-0.20		0	1.5	2.6	-1.3	0.1															0.0			
-0.03	LOW 910	0	1.5	2.6	-1.2	0.1															0.0			
0.13		0	1.4	2.6	-1.3	0.1															0.0			
0.30		0	1.4	2.6	-1.3	0.1															0.0			
0.47		0	1.3	2.6	-1.4	0.1															0.0			
0.63		0	1.3	2.6	-1.5	0.1															0.0			
0.80		0	1.3	2.6	-1.5	0.1															0.0			
0.97		0	1.3	2.6	-1.4	0.1															0.0			
1.13		0	1.7	2.6	-1.0	0.1															0.0			
1.30		0	2.0	2.6	-0.7	0.1															0.0			
1.47		0	2.1	2.6	-0.6	0.1															0.0			
1.63		0	2.6	2.6	-0.2	0.1															0.0			
1.80	start flow	0.19	2.9	2.8	0.2	0.3	0.2								0.85	1.10	0.23	1.65	0.14	0.97	0.2			

1.97		0.49	3.1	3.1	0.4	0.6	0.5								0.69	1.62	0.70	2.43	0.29	1.56	1.1			
2.13		0.78	3.5	3.4	0.7	0.8	0.8								0.48	2.14	1.47	3.22	0.46	2.12	3.1			
2.30		1.07	3.5	3.7	0.8	1.1	1.0								0.36	2.40	1.94	3.60	0.54	2.38	4.6			
2.47		1.36	4.1	4.0	1.4	1.4	1.4								0.06	3.02	3.26	4.53	0.72	2.88	9.4			
2.63		1.65	4.5	4.3	1.7	1.7	1.7								-0.15	3.44	4.21	5.16	0.81	3.13	13.1			
2.80		2.04	4.7	4.6	1.9	2.1	2.0								-0.34	3.84	5.05	5.76	0.88	3.28	16.6			
2.97		2.23	4.9	4.8	2.2	2.3	2.2								-0.49	4.17	5.65	6.25	0.90	3.35	18.9			
3.13		2.52	5.3	5.1	2.6	2.6	2.6								-0.73	4.79	6.51	7.18	0.91	3.36	21.8			
3.30	TOC S & TOC N	2.91	5.8	5.5	3.0	3.0	3.0	3.2	3.0	0.3	1.1	0.99	1.01	16.66										17.1
3.47		3.20	6.1	5.8	3.3	3.3	3.3	3.6	3.3	0.3	1.1	1.09	1.12	18.41										18.0
3.63		3.59	6.4	6.2	3.6	3.7	3.6	3.8	3.7	0.2	1.0	1.22	1.21	10.99										13.9
3.80		3.88	6.8	6.5	4.0	4.0	4.0	4.2	4.0	0.3	1.1	1.32	1.34	17.86										17.7
3.97		4.17	7.1	6.8	4.3	4.2	4.3	4.6	4.2	0.3	1.1	1.41	1.45	19.66										18.6
4.13		4.47	7.5	7.1	4.7	4.5	4.6	4.9	4.5	0.4	1.1	1.51	1.57	25.01										21.0
4.30		4.76	7.7	7.4	5.0	4.8	4.9	5.2	4.8	0.3	1.1	1.61	1.65	21.88										19.6
4.47		5.05	8.1	7.6	5.4	5.1	5.2	5.6	5.1	0.5	1.1	1.71	1.79	29.13										22.7
4.63		5.34	8.3	7.9	5.5	5.4	5.5	5.7	5.4	0.3	1.1	1.80	1.84	20.63										19.1
4.80		5.53	8.5	8.1	5.8	5.6	5.7	6.0	5.6	0.4	1.1	1.87	1.93	25.08										21.0
4.97		5.83	8.7	8.4	6.0	5.9	5.9	6.2	5.9	0.3	1.0	1.97	1.98	17.20										17.4
5.13		6.12	8.9	8.7	6.2	6.2	6.2	6.4	6.2	0.2	1.0	2.06	2.06	12.43										14.8
5.30		6.31	9.1	8.9	6.3	6.4	6.4	6.5	6.4	0.2	1.0	2.13	2.11	10.30										13.5
5.47		6.41	9.2	9.0	6.4	6.5	6.5	6.6	6.5	0.2	1.0	2.16	2.14	10.44										13.6
5.63		6.60	9.4	9.2	6.6	6.7	6.6	6.8	6.7	0.1	1.0	2.22	2.20	9.58										13.0
5.80		6.70	9.4	9.3	6.7	6.8	6.7	6.9	6.8	0.1	1.0	2.26	2.22	6.93										11.1
5.97	HIGH TIDE	6.80	9.4	9.4	6.7	6.9	6.8	6.9	6.9	0.0	1.0	2.29	2.23	1.25										4.7
6.13		6.80	9.4	9.4	6.7	6.9	6.8	6.9	6.9	0.0	1.0	2.29	2.22	-0.81										#NUM!
6.30	EBB!	6.70	9.3	9.3	6.6	6.8	6.7	6.8	6.8	0.0	1.0	2.26	2.19	-1.43										#NUM!
6.47		6.60	9.2	9.2	6.5	6.7	6.6	6.7	6.7	0.0	1.0	2.22	2.15	0.04										0.8
6.63		6.50	9.1	9.1	6.4	6.6	6.5	6.6	6.6	0.0	1.0	2.19	2.12	-0.39										#NUM!
6.80		6.41	9.0	9.0	6.3	6.5	6.4	6.5	6.5	0.0	1.0	2.16	2.09	-0.76										#NUM!
6.97		6.21	8.8	8.8	6.1	6.3	6.2	6.3	6.3	0.0	1.0	2.09	2.02	1.10										4.4

7.13		6.12	8.6	8.7	5.8	6.2	6.0	6.2	6.0	0.1	1.0	2.01	1.99	9.21													12.7			
7.30		5.92	8.3	8.5	5.6	6.0	5.8	6.0	5.8	0.2	1.0	1.93	1.93	12.08														14.6		
7.47		5.83	8.1	8.4	5.4	5.9	5.6	5.9	5.6	0.3	1.1	1.86	1.90	20.89														19.2		
7.63		5.63	7.9	8.2	5.1	5.7	5.4	5.7	5.3	0.4	1.1	1.78	1.83	23.06														20.2		
7.80		5.53	7.6	8.1	4.8	5.6	5.2	5.6	5.1	0.5	1.1	1.69	1.80	35.10														24.9		
7.97		5.24	7.3	7.8	4.6	5.3	5.0	5.3	4.8	0.5	1.1	1.60	1.70	33.04														24.1		
8.13		4.95	7.0	7.6	4.2	5.0	4.6	5.0	4.4	0.6	1.1	1.48	1.60	37.82														25.8		
8.30	TYPE 4	4.66	6.7	7.3	4.0	4.7	4.4	4.7	4.2	0.5	1.1	1.40	1.51	33.94														24.5		
8.47		4.27	6.3	6.9	3.6	4.3	4.0	4.3	3.8	0.6	1.1	1.26	1.38	35.88														25.1		
8.63		3.98	6.0	6.6	3.3	4.1	3.7	4.1	3.5	0.5	1.2	1.17	1.28	35.35														25.0		
8.80	TOC N	3.69	5.7	6.3	3.0	3.8	3.4	3.8	3.2	0.6	1.2	1.06	1.18	36.96														25.5		
8.97		3.40	5.4	6.0	2.7	3.5	3.1	3.5	2.9	0.6	1.2	0.96	1.09	37.63														25.8		
9.13	OPEN CHAN NEL EBB	3.11	5.1	5.7	2.4	3.2	2.8	3.2	2.6	0.6	1.2	0.86	0.99	38.93														26.2		
9.30	TOC S	2.82	4.8	5.4	2.1	2.9	2.5	2.9	2.3	0.6	1.3	0.76	0.89	39.92															24.4	
9.47		2.52	4.4	5.1	1.7	2.6	2.2	2.6	1.9	0.7	1.4	0.64	0.79	43.43															20.4	
9.63		2.14	4.1	4.7	1.4	2.2	1.8	2.2	1.6	0.6	1.4			40.63															14.7	
9.80		1.84	3.8	4.4	1.1	1.9	1.5	1.9	1.3	0.6	1.5			40.67															10.4	
9.97		1.55	3.5	4.2	0.8	1.6	1.2	1.6	1.0	0.6	1.6			40.13															6.6	
10.13		1.36	3.2	4.0	0.5	1.4	1.0	1.4	0.7	0.7	2.0			47.12															3.6	
10.30		1.07	2.9	3.7	0.2	1.1	0.7	1.1	0.4	0.7	2.7			46.33															1	
10.47		0.78	2.7	3.4	-0.1	0.8	0.4	0.8	0.1	0.7	5.7			44.97															1	
10.63		0.49	2.4	3.1	-0.3	0.6	0.1	0.6	-0.1	0.7	-5.4			42.41																
10.80	LOW TIDE COND	0.29	2.3	2.9	-0.4	0.4	0.0	0.4	-0.2					0.00															0.0	
10.97		0.10	2.3	2.7	-0.4	0.2	-0.1	0.2	-0.2					0.00															0.0	
11.13		0.10	2.3	2.7	-0.4	0.2	-0.1	0.2	-0.2					0.00															0.0	
11.30		0.10	2.4	2.7	-0.4	0.2	-0.1	0.2	-0.2					0.00															0.0	
11.47		0.10	2.4	2.7	-0.4	0.2	-0.1	0.2	-0.1					0.00															0.0	
11.63		0.10	2.4	2.7	-0.3	0.2	-0.1							0.00															0.0	
11.80		0.10	2.4	2.7	-0.3	0.2	-0.1							0.00															0.0	
11.97		0.10	2.4	2.7	-0.3	0.2	-0.1							0.00															0.0	

12.13		0.10	2.4	2.7	-0.3	0.2	-0.1								0.00									0.0		
12.30		0.19	2.4	2.8	-0.3	0.3	0.0								0.00										0.0	
12.47		0.19	2.5	2.8	-0.3	0.3	0.0								0.00										0.0	
12.63	LOW	0.19	2.5	2.8	-0.3	0.3	0.0								0										0.0	

Open Channel:

Time	Hours	N	S	y1	y2	y avg	A1	theta1	R1	P1	V1	A2	theta2	R2	P2	V2	A	R	P	theta	V	Vavg	hc	hf	Q MANNING	Q ENERGY
11:00	1.80	2.92	2.79	0.18	0.26	0.22	0.17	0.99	0.12	1.48	1.16	0.30	1.20	0.17	1.79	0.67	0.23	0.14	1.65	1.10	0.97	0.91	0.01	0.18	0.2	0.1
11:10	1.97	3.12	3.09	0.38	0.56	0.47	0.52	1.46	0.24	2.18	0.77	0.91	1.79	0.34	2.68	0.44	0.70	0.29	2.43	1.62	1.56	0.60	0.00	0.03	1.1	0.4
11:20	2.13	3.46	3.38	0.72	0.85	0.78	1.30	2.05	0.42	3.07	1.46	1.65	2.25	0.49	3.37	1.15	1.47	0.46	3.22	2.14	2.12	1.30	0.01	0.08	3.1	1.9
11:30	2.30	3.52	3.67	0.78	1.14	0.96											1.94	0.54	3.60	2.40	2.38	#####			4.6	
11:40	2.47	4.13	3.96	1.39	1.43	1.41	3.20	2.99	0.71	4.49	2.34	3.32	3.05	0.73	4.57	2.26	3.26	0.72	4.53	3.02	2.88	2.30	0.04	0.13	9.4	7.5
11:50	2.63	4.47	4.25	1.73	1.72	1.72	4.22	3.45	0.82	5.17	2.72	4.19	3.44	0.81	5.15	2.74	4.21	0.81	5.16	3.44	3.13	2.73	0.06	0.16	13.1	11.5
12:00	2.80	4.66	4.64	1.92	2.11	2.01	4.78	3.71	0.86	5.56	0.96	5.31	3.98	0.89	5.97	0.87	5.05	0.88	5.76	3.84	3.28	0.91	0.01	0.02	16.6	4.6
12:10	2.97	4.91	4.83	2.17	2.30	2.24	5.48	4.07	0.90	6.10	1.86	5.82	4.27	0.91	6.40	1.75	5.65	0.90	6.25	4.17	3.35	1.81	0.03	0.06	18.9	10.2
12:20	3.13	5.34	5.12	2.60	2.59	2.60	6.51	4.79	0.91	7.18	2.90	6.49	4.77	0.91	7.15	2.91	6.51	0.91	7.18	4.79	3.36	2.91	0.07	0.16	21.8	18.9

Energy Equation Spreadsheet Example:

APPROXIMATE FLOW CALCULATOR FOR CULVERT WITH INVERSE SLOPE													
		Input parameters								Output			
			adjust			Want to adjust input Q until E1 matches E2							
Flowrate	trial/error	Q	11.5			E1	4.58523	DIFFERENCE	0.00018				
Width		B				E2	4.5854			input - EACH CALC			
Length		L	28							input - DAILY			
Mannings n		n	0.036							output - adjust Q until two values match			
water surf elev. 1		WS1	4.47	changes for each flowrate calculation									
water surf elev. 2		WS2	4.25	changes for each flowrate calculation									
bottom elevation 1		z1	2.74					conservation of energy equation $E1 = E2 + hf + h_e$ L = length $E1 = y1 + z1 + (v^2)/(2g)$ $E2 = y2 + z2 + (v^2)/(2g)$ $WS1 = y1 + z1$ $WS2 = y2 + z2$ $hf = 29(n^2)L/(Rh^4/3) * (v^2)/2g$					
bottom elevation 2		z2	2.53										
Avg energy gradient		Sebar	0.05827	for calculations (should be positive)									
Avg energy gradient		Sebarrea	-0.05827	energy slope (should be negative)									
bottom channel slope		So	0.0075	bottom slope (should be positive)									
Froude Number 1		Fr1	0.36498	Fr1 - ok if less than 1									
Froude Number 2		Fr2	0.36863	Fr2 - ok if less than 1									
		z1	2.74			z2	2.53						
		y1	1.73			y2	1.72						
		WS1	4.47			WS2	4.25						
		R1	0.81589			R2	0.81334						
		A1	4.22158			A2	4.19192						
		V1	2.7241			V2	2.74337						
		Se1	0.05794			Se2	0.0586						
		V1^2/(2g)	0.11523			V2^2/(2g)	0.11686						
		E1	4.58523			E2	4.5854						
		Fr1	0.36498			Fr2	0.36863						
		1-(2y/d)	-0.15333			1-(2y/d)	-0.14667						
		theta	3.44947			theta	3.43599						
		P	5.17421			P	5.15398						
				average:		Rh	0.81461						
						V	2.73374						
		Ke	0.5			v2/2g	0.11605						
		he	0.05802			hf	0.16052						
		INLET					OUTLET						
RESULTS:	Y	A	THETA	R	P	V	A2	theta2	R2	P2	V2	he	hf
INLET	1.73	4.22158	3.44947	0.81589	5.174210841	2.7241	4.19192	3.435987954	0.81334	5.15398	2.7433744	0.05802	0.16052
OUTLET	1.72												

December 12-13, 2011

hours	OBSERVED	S	N depth	S depth from N probe	N-BOCN	S-BOCS	y	h1	h4	h1-h4	h4/D	2g(h1-h4)	1-2y/d	theta	A	P	R	V	Equation Q	Q TYPE 4	Q OPEN EBB
1.87		0.5	2.3	1.7	1.7	1.3	1.47	1.9	1.3	0.59	0.43	38.14	0.02	3.10	3.44	4.65	0.74	2.93	12.5	0.0	
2.03		0.6	2.6	1.8	2.0	1.4	1.68	2.2	1.4	0.83	0.46	53.21	-0.12	3.38	4.08	5.08	0.80	3.10	16.7	0.0	
2.20		1.0	2.9	2.2	2.3	1.8	2.02	2.5	1.8	0.72	0.59	46.21	-0.34	3.84	5.05	5.77	0.88	3.28	21.9	0.0	
2.37		1.3	3.2	2.5	2.6	2.1	2.30	2.8	2.1	0.71	0.68	45.71	-0.54	4.27	5.82	6.41	0.91	3.36	26.3	0.0	
2.53		1.6	3.5	2.8	2.9	2.4	2.67	3.1	2.4	0.68	0.81	43.52	-0.78	4.94	6.65	7.41	0.90	3.34	30.5	0.0	
2.70		2.0	3.8	3.2	3.2	2.8	3.00	3.4	2.8	0.56	0.94	36.01	-1.00						0.0	25.2	
2.87		2.3	4.2	3.5	3.6	3.1	3.35	3.8	3.1	0.67	1.04	43.02	-1.23						0.0	27.5	
3.03		2.6	4.5	3.8	3.9	3.4	3.68	4.1	3.4	0.74	1.14	47.39	-1.45						0.0	28.9	
3.20	935 full	3.0	4.9	4.2	4.3	3.8	4.04	4.5	3.8	0.69	1.27	44.64	-1.70						0.0	28.0	
3.37		3.3	5.2	4.5	4.6	4.1	4.37	4.8	4.1	0.76	1.36	48.71	-1.91						0.0	29.3	
3.53		3.7	5.6	4.9	4.9	4.5	4.71	5.2	4.5	0.68	1.49	43.70	-2.14						0.0	27.8	
3.70		4.0	5.9	5.2	5.3	4.8	5.03	5.5	4.8	0.72	1.59	46.64	-2.35						0.0	28.7	
3.87		4.3	6.2	5.5	5.6	5.1	5.32	5.8	5.1	0.72	1.69	46.58	-2.55						0.0	28.6	
4.03		4.6	6.5	5.8	5.8	5.4	5.60	6.1	5.4	0.70	1.78	45.14	-2.73						0.0	28.2	
4.20	over rd?	4.8	6.7	6.0	6.0	5.6	5.85	6.3	5.6	0.61	1.88	39.27	-2.90						0.0	26.3	
4.37		5.1	6.8	6.3	6.2	5.9	6.06	6.39	5.9	0.45	1.98	29.01	-3.04						0.0	22.6	
4.53	over rd?	5.3	7.0	6.5	6.4	6.1	6.24	6.6	6.1	0.43	2.04	27.95	-3.16						0.0	22.2	
4.70		5.5	7.1	6.7	6.5	6.3	6.40	6.7	6.3	0.36	2.11	22.88	-3.27						0.0	20.1	
4.87		5.7	7.2	6.9	6.6	6.5	6.56	6.8	6.5	0.30	2.17	19.32	-3.38						0.0	18.5	
5.03		5.9	7.3	7.1	6.7	6.7	6.70	6.9	6.7	0.19	2.24	12.07	-3.47						0.0	14.6	
5.20		6.0	7.4	7.2	6.8	6.8	6.79	7.0	6.8	0.17	2.27	11.07	-3.53						0.0	14.0	
5.37		6.2	7.4	7.4	6.8	7.0	6.90	7.0	7.0	0.00	2.33	0.06	-3.60						0.0	1.0	
5.53	HIGH TIDE	6.3	7.5	7.5	6.8	7.1	6.97	7.1	7.1	-0.05	2.37	-3.00	-3.65						0.0	0.0	
5.70	EBB, switch h1 &4	6.3	7.4	7.5	6.8	7.1	6.97	7.1	7.0	0.06	2.35	3.56	-3.64						0.0	7.9	
5.87	S to N	6.3	7.4	7.5	6.8	7.1	6.95	7.1	7.0	0.09	2.34	5.75	-3.63						0.0	10.1	
6.03		6.2	7.3	7.4	6.7	7.0	6.87	7.0	6.9	0.06	2.32	3.81	-3.58						0.0	8.2	

6.20		6.2	7.3	7.4	6.7	7.0	6.84	7.0	6.9	0.12	2.29	7.88	-3.56					0.0	11.8	
6.37		6.1	7.2	7.3	6.6	6.9	6.73	6.9	6.8	0.14	2.26	9.00	-3.49					0.0	12.6	
6.53		6.0	7.0	7.2	6.4	6.8	6.61	6.8	6.6	0.19	2.21	12.25	-3.41					0.0	14.7	
6.70		5.8	6.8	7.0	6.2	6.6	6.40	6.6	6.4	0.23	2.13	14.76	-3.26					0.0	16.1	
6.87		5.6	6.5	6.8	5.9	6.4	6.18	6.4	6.1	0.28	2.05	18.26	-3.12					0.0	17.9	
7.03		5.4	6.3	6.6	5.7	6.2	5.97	6.2	5.9	0.30	1.98	19.51	-2.98					0.0	18.5	
7.20		5.2	6.1	6.4	5.5	6.0	5.75	6.0	5.7	0.37	1.89	23.63	-2.83					0.0	20.4	
7.37		4.9	5.8	6.1	5.2	5.7	5.46	5.7	5.4	0.36	1.79	23.07	-2.64					0.0	20.2	
7.53		4.7	5.5	5.9	4.9	5.5	5.17	5.5	5.1	0.35	1.70	22.76	-2.45					0.0	20.0	
7.70		4.4	5.2	5.6	4.6	5.2	4.87	5.2	4.8	0.37	1.60	24.01	-2.25					0.0	20.6	
7.87		4.1	4.9	5.3	4.3	4.9	4.59	4.9	4.5	0.35	1.51	22.76	-2.06					0.0	20.0	
8.03		3.9	4.6	5.1	4.0	4.7	4.33	4.7	4.2	0.47	1.40	30.26	-1.89					0.0	23.1	
8.20		3.6	4.3	4.8	3.7	4.4	4.03	4.4	3.9	0.50	1.30	31.89	-1.69					0.0	23.7	
8.37		3.3	4.0	4.5	3.4	4.1	3.74	4.1	3.6	0.50	1.20	31.89	-1.49					0.0	23.7	
8.53		2.9	3.7	4.1	3.1	3.7	3.39	3.7	3.3	0.41	1.10	26.51	-1.26					0.0	21.6	
8.70		2.6	3.4	3.8	2.7	3.4	3.08	3.4	3.0	0.46	0.98	29.64	-1.05					0.0	22.9	
8.87		2.3	3.1	3.5	2.4	3.1	2.78	3.1	2.7	0.47	0.88	30.26	-0.85	5.19	6.84	10.26	0.67	2.74		23.1
9.03		2.0	2.7	3.2	2.1	2.8	2.46	2.8	2.3	0.53	0.77	34.14	-0.64	4.53	6.20	9.31	0.67	2.74		23.0
9.20		1.7	2.4	2.9	1.8	2.5	2.17	2.5	2.0	0.52	0.67	33.51	-0.45	4.07	5.49	8.23	0.67	2.74		19.3
9.37		1.5	2.1	2.7	1.5	2.3	1.92	2.3	1.7	0.65	0.57	41.58	-0.28	3.70	4.77	7.15	0.67	2.74		16.7
9.53		1.3	1.8	2.5	1.2	2.1	1.61	2.1	1.4	0.68	0.46	44.08	-0.07	3.28	3.85	5.78	0.67	2.74		12.1
9.70		1.0	1.5	2.2	0.9	1.8	1.31	1.8	1.1	0.69	0.36	44.14	0.12	2.89	2.98	4.47	0.67	2.74		7.8
9.87		0.7	1.2	1.9	0.6	1.5	1.03	1.5	0.8	0.66	0.27	42.70	0.31	2.51	2.16	3.24	0.67	2.74		4.5
10.03		0.4	1.0	1.6	0.4	1.2	0.81	1.2	0.6	0.53	0.21	34.45	0.46	2.18	1.53	2.30	0.67	2.74		2.4
10.20		0.3	1.0	1.5	0.4	1.1	0.76	1.1	0.6	0.44	0.21	28.51	0.50	2.10	1.40	2.10	0.67	2.74		2.1
10.37		0.2	1.1	1.4	0.4	1.0	0.72			0	0	0.00	0.52	2.04	1.29	1.94	0.67	2.74	0.0	1.9
10.53		0.2	1.1	1.4	0.5	1.0	0.72			0	0	0.00	0.52	2.05	1.30	1.96	0.67	2.74	0.0	
10.70		0.2	1.1	1.4	0.5	1.0	0.73			0	0	0.00	0.51	2.07	1.34	2.00	0.67	2.74	0.0	
10.87		0.2	1.1	1.4	0.5	1.0	0.74			0	0	0.00	0.51	2.07	1.35	2.02	0.67	2.74	0.0	
11.03		0.2	1.1	1.4	0.5	1.0	0.74			0	0	0.00	0.51	2.08	1.36	2.04	0.67	2.74	0.0	
11.20		0.2	1.1	1.4	0.5	1.0	0.74			0	0	0.00	0.50	2.08	1.36	2.05	0.67	2.74	0.0	
11.37		0.2	1.1	1.4	0.5	1.0	0.73			0	0	0.00	0.51	2.06	1.33	2.00	0.67	2.74	0.0	

11.53		0.2	1.1	1.4	0.5	1.0	0.73			0	0	0.00	0.51	2.07	1.34	2.00	0.67	2.74		0.0	
11.70		0.2	1.1	1.4	0.5	1.0	0.74			0	0	0.00	0.51	2.08	1.36	2.04	0.67	2.74		0.0	
11.87		0.2	1.1	1.4	0.5	1.0	0.75			0	0	0.00	0.50	2.09	1.37	2.05	0.67	2.74		0.0	
12.03		0.2	1.1	1.4	0.5	1.0	0.75			0	0	0.00	0.50	2.09	1.37	2.06	0.67	2.74		0.0	
12.20		0.2	1.1	1.4	0.5	1.0	0.75			0	0	0.00	0.50	2.09	1.37	2.05	0.67	2.74		0.0	
12.37		0.3	1.1	1.5	0.5	1.1	0.80			0	0	0.00	0.46	2.18	1.52	2.28	0.67	2.74		0.0	
12.53	LOW TIDE	0.3	1.1	1.5	0.5	1.1	0.80			0	0	0.00	0.47	2.17	1.51	2.26	0.67	2.74		0.0	

12/12 Open Channel Flow:

Time	Hours	N	S	y1	y2	y avg	A1	theta1	R1	P1	V1	A2	theta2	R2	P2	V2	A	R	P	theta	V	Vavg	he	hf	Q MANNING	Q ENERGY	
8:20	1.87	2.27	1.68	1.66	1.28	1.47	4.01	3.36	0.80	5.03	3.11	2.88	2.85	0.67	4.27	4.35	3.44	0.74	4.65	3.10	2.93	3.73	0.11	0.34	10.1	12.5	
8:30	2.03	2.60	1.77	1.99	1.37	1.68	4.98	3.81	0.87	5.71	3.35	3.14	2.97	0.71	4.45	5.31	4.08	0.80	5.08	3.38	3.10	4.33	0.15	0.42	12.6	16.7	
8:40	2.20	2.88	2.16	2.27	1.76	2.02	5.74	4.22	0.91	6.33	3.82	4.31	3.49	0.82	5.24	5.08	5.05	0.88	5.77	3.84	3.28	4.45	0.15	0.39	16.6	21.9	
8:50	2.37	3.16	2.45	2.55	2.05	2.30	6.40	4.69	0.91	7.04	4.11	5.15	3.89	0.88	5.84	5.11	5.82	0.91	6.41	4.27	3.36	4.61	0.16	0.40	19.6	26.3	
9:00	2.53	3.52	2.84	2.91	2.44	2.67	7.01	5.59	0.84	8.38	4.35	6.16	4.50	0.91	6.74	4.95	6.65	0.90	7.41	4.94	3.34	4.65	0.17	0.42	22.2	30.5	
9:10	2.70	3.79	3.23	3.18	2.83	3.00						6.91	5.32	0.87	7.98		#### #	#### #	#### #	#### #	#### #					#NUM!	
8:00	25.53	1.49	1.39	0.88	0.99	0.93	1.73	2.29	0.50	3.43	1.68	2.03	2.45	0.55	3.67	1.43	1.88	0.53	3.55	2.37	2.34	1.55	0.02	0.09	4.4	2.9	
8:10	25.70	1.45	1.39	0.84	0.99	0.91	1.62	2.23	0.48	3.35	1.36	2.03	2.45	0.55	3.67	1.08	1.82	0.52	3.51	2.34	2.31	1.22	0.01	0.06	4.2	2.2	
8:20	25.87	1.67	1.39	1.06	0.99	1.02	2.29	2.57	0.59	3.86	2.40	2.03	2.45	0.55	3.67	2.70	2.12	0.57	3.74	2.49	2.46	2.55	0.05	0.22	5.2	5.5	
8:30	26.03	2.05	1.29	1.44	0.89	1.16	3.35	3.06	0.73	4.59	2.47	1.76	2.30	0.51	3.46	4.73	2.54	0.63	4.04	2.69	2.63	3.60	0.10	0.40	6.7	8.3	
8:40	26.20	2.28	1.29	1.67	0.89	1.28	4.04	3.37	0.80	5.05	2.45	1.76	2.30	0.51	3.46	5.64	2.88	0.67	4.27	2.85	2.76	4.04	0.13	0.47	7.9	9.9	
8:50	26.37	2.58	1.29	1.97	0.89	1.43	4.92	3.78	0.87	5.67	2.36	1.76	2.30	0.51	3.46	6.61	3.33	0.73	4.57	3.05	2.90	4.48	0.16	0.54	9.6	11.6	
9:00	26.53	2.87	1.48	2.26	1.08	1.67	5.71	4.20	0.91	6.31	2.82	2.32	2.59	0.60	3.88	6.94	4.04	0.80	5.05	3.37	3.09	4.88	0.18	0.57	12.5	16.1	
9:10	26.70	3.18	1.68	2.57	1.28	1.92	6.45	4.73	0.91	7.10	3.26	2.88	2.85	0.67	4.27	7.30	4.79	0.86	5.57	3.72	3.24	5.28	0.22	0.62	15.5	21.0	
9:20	26.87	3.45	2.07	2.84	1.67	2.25	6.92	5.35	0.86	8.03	4.09	4.04	3.37	0.80	5.05	7.00	5.69	0.91	6.29	4.19	3.35	5.54	0.24	0.64	19.1	28.3	
9:30	27.03	3.73	2.36	3.12	1.96	2.54						4.89	3.76	0.87	5.65		6.38	0.91	7.00	4.67	3.37	#### #			21.5		
9:40	27.20	4.01	2.74	3.40	2.34	2.87						5.92	4.33	0.91	6.50		6.96	0.85	8.17	5.45	3.22	#### #			22.4		
9:50	27.37	4.33	3.04	3.72	2.64	3.18						6.59	4.87	0.90	7.30		#### #	#### #	#### #	#### #	#### #	#### #			#NUM!		

7.6 Volumes through Culvert

November 30

Time	Flow	d (hours)	d (sec)	Volume FT^3	Volume acre-ft
1.63	0.0				
1.80	0.2	0.166667	600	68.2	0.00
1.97	1.1	0.166667	600	395.2	0.01
2.13	3.1	0.166667	600	1262.0	0.03
2.30	4.6	0.166667	600	2321.3	0.05
2.47	9.4	0.166667	600	4204.8	0.10
2.63	13.1	0.166667	600	6762.3	0.16
2.80	16.6	0.166667	600	8913.3	0.20
2.97	18.9	0.166667	600	10647.4	0.24
3.13	21.8	0.166667	600	12229.4	0.28
3.30	17.1	0.166667	600	11691.7	0.27
3.47	18.0	0.166667	600	10542.9	0.24
3.63	13.9	0.166667	600	9576.6	0.22
3.80	17.7	0.166667	600	9495.2	0.22
3.97	18.6	0.166667	600	10905.1	0.25
4.13	21.0	0.166667	600	11882.0	0.27
4.30	19.6	0.166667	600	12189.0	0.28
4.47	22.7	0.166667	600	12688.0	0.29
4.63	19.1	0.166667	600	12516.1	0.29
4.80	21.0	0.166667	600	12025.5	0.28
4.97	17.4	0.166667	600	11529.6	0.26
5.13	14.8	0.166667	600	9663.2	0.22
5.30	13.5	0.166667	600	8482.0	0.19
5.47	13.6	0.166667	600	8111.2	0.19
5.63	13.0	0.166667	600	7966.6	0.18
5.80	11.1	0.166667	600	7213.3	0.17
5.97	0.0	0.166667	600	3315.8	0.08
culvert only		FLOOD TOTAL		216597.8	5.0
5.97	0.0	5.966667		0.0	0.00
7.13	12.7	1.166667	4200	26750.5	0.61
7.30	14.6	0.166667	600	8198.3	0.19
7.47	19.2	0.166667	600	10132.0	0.23
7.63	20.2	0.166667	600	11802.7	0.27
7.80	24.9	0.166667	600	13507.7	0.31
7.97	24.1	0.166667	600	14699.0	0.34
8.13	25.8	0.166667	600	14983.5	0.34

8.30	24.5	0.166667	600	15080.7	0.35
8.47	25.1	0.166667	600	14879.2	0.34
8.63	25.0	0.166667	600	15030.2	0.35
8.80	25.5	0.166667	600	15143.1	0.35
8.97	25.8	0.166667	600	15381.4	0.35
9.13	26.2	0.166667	600	15582.6	0.36
9.30	24.4	0.166667	600	15177.5	0.35
9.47	20.4	0.166667	600	13440.0	0.31
9.63	14.7	0.166667	600	10530.0	0.24
9.80	10.4	0.166667	600	7530.0	0.17
9.97	6.6	0.166667	600	5100.0	0.12
10.13	3.6	0.166667	600	3060.0	0.07
10.30	1.0	0.166667	600	1380.0	0.03
10.47	1.0	0.166667	600	600.0	0.01
10.63	0.0	0.166667	600	300.0	0.01
culvert only		FLOOD TOTAL		248288.2	5.7

December 12

Time	Flow	d (hours)	d (sec)	Volume FT^3	Volume acre-ft
1.67	0.0				
1.87	12.5	0.200	720.000	4500.0	0.10
2.03	16.7	0.167	600.000	8760.0	0.20
2.20	21.9	0.167	600.000	11580.0	0.27
2.37	26.3	0.167	600.000	14460.0	0.33
2.53	30.5	0.167	600.000	17040.0	0.39
2.70	25.2	0.167	600.000	16707.2	0.38
2.87	27.5	0.167	600.000	15816.5	0.36
3.03	28.9	0.167	600.000	16928.6	0.39
3.20	28.0	0.167	600.000	17083.2	0.39
3.37	29.3	0.167	600.000	17202.5	0.39
3.53	27.8	0.167	600.000	17113.7	0.39
3.70	28.7	0.167	600.000	16925.5	0.39
3.87	28.6	0.167	600.000	17195.1	0.39
4.03	28.2	0.167	600.000	17055.6	0.39
4.20	26.3	0.167	600.000	16351.9	0.38
4.37	22.6	0.167	600.000	14673.8	0.34
4.53	22.2	0.167	600.000	13440.2	0.31
4.70	20.1	0.167	600.000	12681.5	0.29
4.87	18.5	0.167	600.000	11559.2	0.27
5.03	14.6	0.167	600.000	9915.1	0.23
5.20	14.0	0.167	600.000	8580.0	0.20

5.37	1.0	0.167	600.000	4500.0	0.10
5.53	0.0	0.167	600.000	300.0	0.01
culvert only		FLOOD TOTAL		300370	6.90
5.53	0.0				
5.70	7.9	0.167	600	2370.0	0.05
5.87	10.1	0.167	600	5400.0	0.12
6.03	8.2	0.167	600	5490.0	0.13
6.20	11.8	0.167	600	6000.0	0.14
6.37	12.6	0.167	600	7320.0	0.17
6.53	14.7	0.167	600	8188.4	0.19
6.70	16.1	0.167	600	9245.7	0.21
6.87	17.9	0.167	600	10218.1	0.23
7.03	18.5	0.167	600	10942.7	0.25
7.20	20.4	0.167	600	11684.0	0.27
7.37	20.2	0.167	600	12170.7	0.28
7.53	20.0	0.167	600	12056.3	0.28
7.70	20.6	0.167	600	12178.0	0.28
7.87	20.0	0.167	600	12178.0	0.28
8.03	23.1	0.167	600	12935.0	0.30
8.20	23.7	0.167	600	14038.5	0.32
8.37	23.7	0.167	600	14222.1	0.33
8.53	21.6	0.167	600	13594.9	0.31
8.70	22.9	0.167	600	13339.3	0.31
8.87	23.1	0.167	600	13782.9	0.32
9.03	23.0	0.167	600	13827.4	0.32
9.20	19.3	0.167	600	12690.0	0.29
9.37	16.7	0.167	600	10800.0	0.25
9.53	12.1	0.167	600	8640.0	0.20
9.70	7.8	0.167	600	5970.0	0.14
9.87	4.5	0.167	600	3690.0	0.08
10.03	2.4	0.167	600	2070.0	0.05
10.20	2.1	0.167	600	1350.0	0.03
10.37	1.9	0.167	600	1200.0	0.03
10.53	0.0	0.167	600	570.0	0.01
CULVERT ONLY		EBB TOTAL		268162	6.16

7.7 Weir Flow: Road Overtopping

December 12

Time	North	South	North over road	South over road	HWr North	HW south	Cwb	X*H ^(1.5)	Q (cfs)
10:30	6.46	5.75	-0.09	-0.80	-0.09		0.655		0.000
10:40	6.66	6.05	0.11	-0.50	0.11		0.645	158.342	102.104
10:50	6.79	6.34	0.24	-0.21	0.24		0.639	535.636	342.021
11:00	6.97	6.53	0.42	-0.02	0.42		0.630	1238.384	780.598
11:10	7.08	6.73	0.53	0.18	0.53		0.625	1789.931	1119.015
11:20	7.22	6.92	0.67	0.37	0.67		0.619	2536.603	1570.491
11:30	7.30	7.11	0.75	0.56	0.75		0.616	3013.988	1855.604
11:40	7.38	7.21	0.83	0.66	0.83		0.612	3518.052	2153.941
11:50	7.41	7.40	0.86	0.85	0.86		0.611	3666.777	2241.464
12:00	7.46	7.50	0.91	0.95	0.91	0.95	0.609	3989.554	0.000
12:10	7.44	7.50	0.89	0.95		0.95	0.650	4288.371	2787.441
12:20	7.41	7.50	0.86	0.95		0.95	0.650	4301.525	2795.991
12:30	7.35	7.40	0.80	0.85		0.85	0.650	3660.540	2379.351
12:40	7.28	7.40	0.73	0.85		0.85	0.650	3660.540	2379.351
12:50	7.17	7.31	0.62	0.76		0.76	0.650	3054.994	1985.746
13:00	7.02	7.21	0.47	0.66		0.66	0.650	2487.100	1616.615
13:10	6.79	7.02	0.24	0.47		0.47	0.650	1475.676	959.190
13:20	6.54	6.82	-0.01	0.27		0.27	0.650	658.189	427.823
13:30	6.33	6.63	-0.22	0.08		0.08	0.650	101.192	65.775
									0.000

road height	Width (b)	$b(g)^{1/2}$		
6.55	1500	8508.319458		
Pw	Gravity	$X=b(g)^{.5}(2/3)^{(1.5)}$		
6.55	32.174	4631.342498		$Q=Cw*L*(HW)^{(3/2)}$
10 min in secs		Acre-Ft		
600		0.000022957		

November 30

November 30

Time	North	South	North over road	South over road	HWr North	HW south	Cwb	X*H ^(1.5)	Q (cfs)
14:10	8.69	8.43	0.01	-0.25	0.01		0.649	0.043	0.028
14:20	8.91	8.72	0.23	0.04	0.23		0.639	3.395	2.169
14:30	9.07	8.91	0.39	0.23	0.39		0.631	7.539	4.761
14:40	9.17	9.01	0.49	0.33	0.49		0.627	10.587	6.638
14:50	9.35	9.20	0.67	0.52	0.67		0.619	16.959	10.499
15:00	9.41	9.30	0.73	0.62	0.73		0.617	19.127	11.795
15:10	9.42	9.40	0.74	0.72	0.74	0.72	0.616	19.477	0.000
15:20	9.41	9.40	0.73	0.72		0.72	0.650	0.000	0.000
15:30	9.32	9.30	0.64	0.62		0.62	0.650	0.000	0.000
15:40	9.20	9.20	0.52	0.52		0.52	0.650	0.000	0.000
15:50	9.11	9.10	0.43	0.42		0.42	0.650	8.550	5.558
16:00	9.02	9.01	0.34	0.33		0.33	0.650	5.794	3.766
16:10	8.80	8.81	0.12	0.13		0.13	0.650	1.508	0.980
16:20	8.57	8.72	-0.11	0.04		0.04	0.650	0.215	0.140
		road height	Width (b)	$b(g)^{1/2}$					
		8.68	10	56.72212972					
		Pw	Gravity	$X=b(g)^{.5(2/3)^{(1.5)}$					
		8.68	32.174	30.87561665		$Q=Cw*L*(HW)^{(3/2)}$			
		10 min in secs		Acre-Ft					
		600		0.000022957					

7.8 Design Calculations

For submerged inlet conditions

Flow, Q, cfs	Area, ft ²	Culvert height, b, ft
30.5	9	3
30.5	12	3
30.5	15	3
30.5	18	3
30.5	21	3
30.5	24	3
30.5	27	3
30.5	30	3
30.5	7.07	3
Force of gravity, g, ft/s/s	Cd	Headwater, HW, feet
32.2	0.61	1.586266391
32.2	0.61	1.564699793
32.2	0.61	1.551759834
32.2	0.61	1.543133195
32.2	0.61	1.53697131
32.2	0.61	1.532349896
32.2	0.61	1.528755464
32.2	0.61	1.525879917
32.2	0.61	1.609815773

For unsubmerged inlet conditions

Cw	B, width of culvert, ft	Headwater, HW, feet
3	3	2.256168613
3	4	1.862426156
3	5	1.604990207
3	6	1.421297164
3	7	1.282489141
3	8	1.173254959
3	9	1.084652738
3	10	1.011080473

For outlet control

Height of culvert, h	Hydraulic radius for full flow	Manning's n
3	1	0.0185
3	1.2	0.0185
3	1.363636364	0.0185
3	1.5	0.0185
3	1.615384615	0.0185
3	1.714285714	0.0185
3	1.8	0.0185
3	1.875	0.0185

Velocity (with Q = 30.5 cfs)
3.388888889
2.541666667
2.033333333
1.694444444
1.452380952
1.270833333
1.12962963
1.016666667
4.314002829

Culvert height, D, ft	Culvert width, B, ft
3	6
3	7
3	8
3	9
3	10
Area, ft ²	Peak discharge for 10-year storm, cfs
18	200
	Peak discharge for 100-year storm, cfs
21	270
24	
27	
30	
Ratio of discharge to width, Q/B, cfs/ft (Q = 30, max. from field)	Headwater depth in terms of height, HW/D (Q = 30)
5	0.52
4.285714286	0.47
3.75	0.44
3.333333333	0.4
3	0.38

Headwater, H, feet (Inlet Control, Q = 30)	Headwater depth in terms of height, HW/D (10-year storm)
1.56	2.7
1.41	2.2
1.32	1.88
1.2	1.6
1.14	1.4
Ratio of discharge to width, Q/B, cfs/ft (10-year storm)	Headwater, HW, feet (Inlet Control) (10-year storm)
33.33333333	8.1
28.57142857	6.6
25	5.64
22.22222222	4.8
20	4.2

Ke, entrance loss coefficient, for square edged on three edges	Force of gravity, g, ft/s/s
0.5	32.2
0.5	32.2
0.5	32.2
0.5	32.2
0.5	32.2
Slope, S	Length, L, feet
-0.0075	28
-0.0075	28
-0.0075	28
-0.0075	28
-0.0075	28
Velocity, V, ft/s	Discharge per foot of width, q, cfs/ft
11.11111111	33.33333333
9.523809524	28.57142857
8.333333333	25
7.407407407	22.22222222
6.666666667	20
Critical Depth, dc	1/2 (Critical Depth in Culvert + D)
3.255621238	3.127810619
2.937667779	2.96883389
2.68745612	2.84372806
2.484504	2.742252
2.315979477	2.657989738
Hydraulic Radius, Rh	Energy loss through culvert at full flow, H, feet
1.5	3.185816689
1.615384615	2.319152819
1.714285714	1.763557814

1.8	1.386159699
1.875	1.118149173
HW (Outlet control)	Headwater depth in terms of height, HW/D (100-year storm)
6.523627308	4
5.497986708	3.1
4.817285873	2.6
4.338411699	2.27
3.986138911	1.75
Ratio of discharge to width, Q/B, cfs/ft (100-year storm)	Outlet exit velocity, V, ft/s
45	15
38.57142857	12.85714286
33.75	11.25
30	10
27	9
Headwater, HW, feet (Inlet Control) (100-year storm)	
12	
9.3	
7.8	
6.81	
5.25	

7.9 Nomograph

HEADWATER DEPTH FOR BOX CULVERTS WITH INLET CONTROL

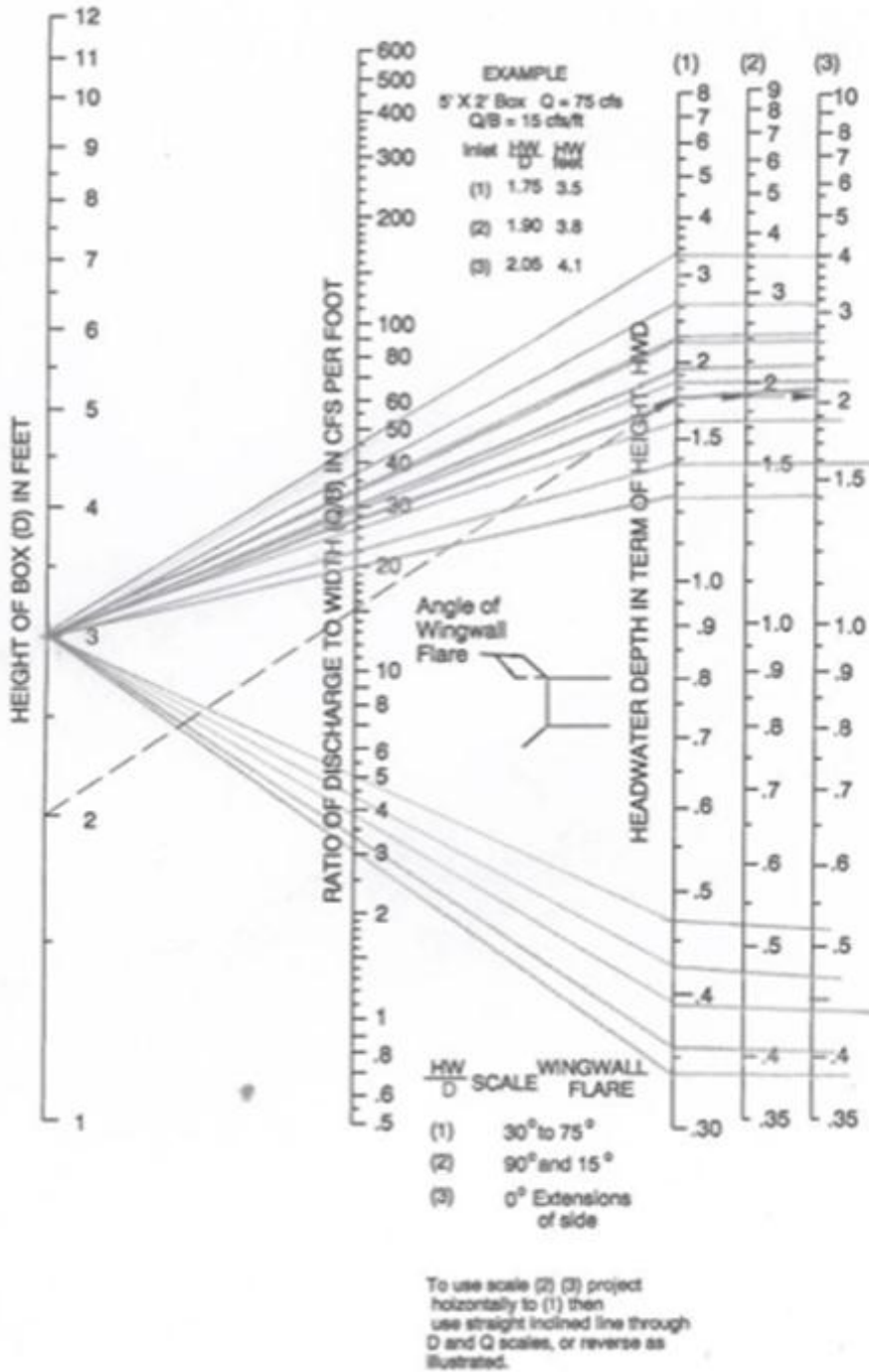

Figure 50: Inlet Control Nomograph