



# WPI

## Improving Visitor Evaluation at the British Postal Museum & Archive

Angela Conklin

George Benda

Nysa Casha

Shuyang Sun



June 27, 2014

THE BRITISH  
POSTAL  
MUSEUM  
& ARCHIVE

Improving Visitor Evaluation at the British Postal Museum & Archive

An Interactive Qualifying Project Report

Submitted to the Faculty

of the

WORCESTER POLYTECHNIC INSTITUTE

In partial fulfillment of the requirements for the

Degree of Bachelor of Science

By

---

Angela Conklin

---

George Benda

---

Nysa Casha

---

Shuyang Sun

Date: June 27, 2014

---

Hannah Clipson, Sponsor Liaison

---

Dominique Gardner, Sponsor Liaison

---

Prof. Ingrid Shockey, Advisor

---

Prof. Carolina Ruiz, Co-Advisor

This report represents the work of one or more WPI undergraduate students submitted to the faculty as evidence of completion of a degree requirement. WPI routinely publishes these reports on its web site without editorial or peer review

## **Abstract**

This project was conducted with the British Postal Museum and Archive (BPMA) in order to improve their methods of visitor experience evaluation. We evaluated the BPMA's past data, conducted research, interviewed staff and visitors, edited surveys, developed creative writing/drawing activities, and used social media to promote exhibitions. Through these methods we were able to identify the present visitors' demographics, evaluate visitor engagement, and collect visitor feedback on their experiences. Ultimately, we made recommendations to our sponsors on how to improve their exhibitions and their visitor engagement evaluation methods.

# Executive Summary

## Introduction

The British Postal Museum and Archive (BPMA), is an organization based in London, England founded in 2004 as a charitable trust. The organization strives to share British postal history and promote communication amongst its visitors by providing a meaningful experience through fun and educational exhibitions. Through paper surveys and online discussion groups pertaining to exhibition experience, the BPMA has made many efforts to discover visitors' specific enjoyments and preferences. They developed temporary exhibitions and interactive sites that entice visitors to their many locations. While visitor motivation, engagement, and retained knowledge are high priorities for the organization, the BPMA lacks up-to-date, statistically robust, and in-depth data on these aspects of the visitors' experience. The goal of this project was to improve the visitor experience evaluation process at the BPMA.

## Literature Review

We synthesized relevant articles and assembled best practices for museum evaluation strategies. We investigated the BPMA's mission in order to identify which survey parameters best fit their purpose. In addition, we prepared the structural components of the exhibition under study, the Last Post Exhibit. We researched site description, best practices in survey design and methods of analysis. Case Studies deemed successful, suggested that the focus of these surveys revolve around (1) demographic profiling; (2) visitor motivation; (3) visitor experience and ways of engagement; and (4) visitor response/takeaway.

In our research, we found that the museums were not just tourist sites, but places where local residents could relax and spend time with family and friends. The literature review debunked our predictions and enabled us to reconsider the relevance of certain questions. We aimed to keep visitor "exploration" categorization, visitor motivation, visitor experience, and ultimate visitor takeaway in mind. The most important element in survey creation entailed keeping the museum's goals and visions at the forefront of our methodology.

## Methodology

The goal of our project was to improve the process of evaluating visitor experience for exhibitions provided by the British Postal Museum and Archive (BPMA). To meet our goal, we followed these objectives:

1. Evaluating the BPMA's current survey and other baseline strategies used to measure visitor engagement.
2. Understanding and identifying site-specific needs, constraints and parameters of museums and their exhibitions.
3. Designing and testing tools that measure visitor experience.
4. Determining an effective tool (device or software system) for data entry and analysis.

The key to our project was not only to find best practices for evaluation, but to also create innovative ways of evaluating visitors. We constructed a list of designs, which we determined all held potential to provide informative feedback. We developed a creative writing/drawing center at the end of each exhibition. We utilized Twitter and Facebook by posting quotes of people we interviewed, and submissions from our creative writing/drawing activities.

## **Results**

The data we gathered determined which methods of visitor evaluation produced the most informative conclusions at each site. Although the sample size of the data was small making these conclusions not statistically significant, we were still able to gain some insight from them.

### ***Objective 1: Evaluating the BPMA's current survey and their baseline strategies.***

In our review of the BPMA's paper survey, there were some questions we thought needed to be reworked or changed. In looking at the past survey, we found confusing statements, an uncomfortable mix of free response and multiple-choice questions, and a lack of site-specific questions.

### ***Objective 2: Determine site-specific needs, constraints and parameters.***

We observed and visited well-known museums in London to see what was and was not working for them. By evaluating popular museums, this research enabled us to identify the onsite needs of BPMA exhibitions. The more engaged the visitor, the more likely he or she was to share feedback. The Natural History museum had a plethora of interactive games, videos, auditory telephones, and three-dimensional displays. The Victoria and Albert Museum was primarily a visual experience. The visitors seemed to enjoy wandering and looking at a variety of historic displays. The Science Museum was a bit different from the aforementioned two museums. It had beautiful models and displays. The Science museum was interesting and exciting, but not as popular and captivating as the other two museums.

The Postal Maps Event, a BPMA pay upon entry presentation, was our first opportunity to take note of visitors' reactions to present information, and to our evaluation methods. At this event, which focused on the evolution of London postal codes, fifteen people attended and enjoyed both the provided refreshments and the displayed maps of London postal districts.

The Last Post exhibition, featured in Mansfield, was our first opportunity to evaluate visitors in an exhibition setting. The exhibition, consisting of eight panels, was located at the entrance to a children's museum. At this site we found that visitors did not want to take electronic surveys nor did they enjoy being quizzed on the material. These findings allowed us to play to our strengths at the Last Post Exhibition at Coalbrookdale where we primarily used observations and surveys to gather data.

### ***Objective 3: Designing and testing tools that measure the visitor experience.***

We developed a quiz and a creative writing/drawing activity to see if visitors were absorbing the information provided by the exhibition. Although we were not able to test these methods on many visitors due to our small sample size, we were able to gather some valuable information. At events that were not an appropriate setting for an activity, surveys were used to measure visitor experience.

At the one event and two exhibitions we attended, we found that the visitors, who participated, enjoyed the presented information. Interviews with staff were informative since they spend every day onsite and see firsthand how visitors react to the material. Based on the data gathered from our prototype survey, we found that paper surveys were preferred to electronic ones, and that children at the site did enjoy our creative writing/drawing activity. The tweets that were posted received six retweets and four people favored them. The sample size

gathered was small, but the data collected was helpful in determining which tools could be popular and informative.

***Objective 4: Determining an effective tool for data entry and analysis.***

At the Museum and Heritage show we were introduced to a wide variety of products and methods that could be a great asset to the growth of any museum. We specifically were looking for interactive activities the BPMA could use to increase visitor interaction with their sites and devices to use for visitor evaluation to make collecting data more efficient. We created a spreadsheet, which depicted each device we thought would meet our organization's needs. The sheet included company name, product purpose, cost, and duration of effective use. The products were grouped by type pertaining to computer devices, guided tours, and visitor aid.

**Discussion**

***Visitor Engagement***

Visitor engagement is the varying level of involvement one has with an exhibition. Visitors, who pass by a display without looking at it, will be less likely to take part in exhibition evaluation methods. By creating visually enticing displays and interactive activities, people are more likely to participate in our evaluation methods. In places like Coalbrookdale, where the exhibition had its own room 54 visitors had elected to take past surveys, and were very willing to take the ones we presented to them.

***Visitor demographics***

The data showed us that the majority of visitors are adults. Those who filled out paper survey liked the format and specified that they would not prefer an electronic survey. In order to gain data it would be advisable to continue using evaluation methods that the visitors respond well to.

***Visitor Feedback***

The visitors we interviewed and surveyed allowed us to conclude a few things about what visitors generally thought about the exhibitions and events. In looking at the survey and interview results from the event and exhibitions, we inferred the following: visitors generally enjoyed the event and gave an overall high rating. We recognized that the sample was too small to reach any statistically significant conclusion. What we can say about the exhibitions is that placement and layout are very important. Visitor's enjoyed reading small amounts of text and looking at pictures and displays. Most visitors also did not know that the exhibition was produced by the British Postal Museum and Archive.

**Recommendation**

***Evaluation Methods***

The recommendations made in this section are based on interviews, data collection from surveys, interactive activities, and observations completed during this project. In future surveys and interviews, we recommend asking straightforward questions. The survey should have a balance of open-ended and multiple-choice questions. We recommend that when interviews take place, they should be semi-standardized. We found that by having a conversation rather than

asking formal questions, made people feel more at ease. We tested this anecdotally by asking formal questions to some staff members and then having conversations with others. We gained more useful feedback during conversations.

### ***Software Options***

There are many different software options that we determined could be useful and exciting for the visitors to use. We encourage the use of an iPad paired with Survey Monkey to see how much attention it receives as compared with the paper survey. Due to a lack of resources, we were unable to compare these two alternative methods. Unfortunately, there are very few devices that can simply transfer data from the paper survey to a database. If the BPMA were to use mobile apps on phones or digital surveys, data could be input immediately. The display that we think can engage the most people was the FAB (Family Activity Based). It is a family activity set up so that children and parents can take games, audios, or visuals with them as they explore an exhibition.

### ***Additional Recommendations***

The location and orientation of the exhibition is key when attracting attention. The exhibition in Mansfield, primarily a children's museum, seemed too tall and complex for children to read. About 30 children came to the museum during the time we were there and only two attempted to look at the material presented.

The more attention an exhibition gains, the more opportunities staff will have for evaluation. Therefore we recommend changing the layout of the Mansfield site, which will result in more visitors taking part in the evaluation methods. We recommend that the BPMA takes into account the room/space and demographic of visitors when setting up an exhibition. Larger text, additional pictures, or a spreading out the display would have attracted more attention. We determined this after observing visitors who had come specifically to see the exhibition walked right passed it many times before having a staff member direct them towards the display.

### **Conclusion**

Unfortunately, we were unable to evaluate a substantial amount of visitors, but the research we gathered, and the evaluations we conducted can still be used and seen as informative. In the first stage of this project we thought implementing technological ways to collect data would be the most popular, yet we learned that site-specific needs were based on the desires of our visitors. In determining the best practice for evaluating visitors, we also suggest the BPMA focus on what the visitors enjoy. Therefore, new innovated methods are always good to test; however, if they are not popular among visitors, we suggest that they are not used. Observations are the most informative way of evaluating. We found that by seeing our visitors engaged and reading body language, we could determine what they enjoyed and preferred than some of the vague comments left on a survey.

Overall, the project was a success in suggesting progressive changes for the BPMA. After analyzing the strengths and weaknesses of the current surveys, we established recommendations for the most feasible approaches for the BPMA. Unfortunately, we were unable to evaluate a substantial amount of visitors to make concrete conclusions, but the research we gathered and the evaluations we conducted can still be used and seen as informative. In the first stage of this project we thought implementing technological ways to collect and analyze data would be the most efficient, yet we learned that site-specific needs were based on the desires of our visitors

who favored paper surveys. In determining the best practice for evaluating visitors, we also suggest the BPMA focus on what the visitors enjoy. Therefore, new innovated methods are always good to test. Observations are the most informative way of evaluating. We found that by reading body language and viewing the visitors as engaged, we could determine what they enjoyed and preferred compared to the vague comments left on a survey. We also found that speaking to staff members who work every day at exhibitions can share insightful information that can be used to improve exhibitions further.

The information we gathered not only benefits the BPMA, but will in turn assist other museums that face similar challenges with visitor feedback. The data helps organizations develop a baseline of information, which they can build upon. It also provides evaluators with tested surveys and activities. The significant amount of information this project provides can benefit the BPMA and similar organizations towards determining the best practices for evaluating visitor engagement. Each innovation in evaluating and improving visitor evaluation helps the BPMA maintain its position as one of London's great tourist attraction.



## **Acknowledgments**

We would like to thank our advisors, Professor Shockey and Professor Ruiz. We could not have produced such a finished project without their comments and suggestions over the past few months. We would like to thank Hannah Clipson and Dominique Gardner, our sponsors, for providing us the opportunity to do this project, helping us along the way, and always encouraging us. It was a great experience that allowed us to travel all over England visiting popular museums, attending events, working at exhibitions, and seeing the foundation for the future creation of the Mail Rail interactive exhibition. We hope all the data we collected and analyzed was helpful to this organization and wish them luck in achieving their future goals.

## **Authorship**

This report has been carried out and written equally by the four listed authors.

# Table of Contents

Abstract .....	iii
Executive Summary .....	iv
Acknowledgments.....	ix
Authorship.....	x
List of Figures .....	xiii
List of Tables .....	xiv
Chapter 1: Introduction .....	1
Chapter 2: Literature Review.....	3
2.1 Site Description.....	3
2.2 Best Practices in Survey Design.....	5
Profiling visitor demographics .....	6
Visitor incentive and motivations.....	8
Visitor experience and manner of engagement .....	9
Knowledge acquisition (visitor takeaway) .....	13
2.3 Methods of Analysis.....	13
2.4 Summary .....	14
Chapter 3: Methodology .....	15
3.1 Objective 1: Evaluating the BPMA’s current survey and their baseline strategies .....	15
3.2 Objective 2: Site-specific needs, constraints and parameters of museums and their exhibitions. ....	17
3.3 Objective 3: Designing and testing tools that measure the visitor experience.....	19
3.4 Objective 4: Determining an effective tool for data entry and analysis.....	20
3.5 Data Management and Timeline .....	21
Chapter 4: Results and Discussion.....	22
4.1 Results .....	22
Objective 2: Determine site-specific needs, constraints and parameters of museums and their exhibitions. ....	30
Objective 3: Designing and testing tools that measure the visitor experience. ....	35
Objective 4: Determining an effective tool for data entry and analysis. ....	42
4.2 Discussion .....	42
Visitor Engagement.....	42

Visitor Preference .....	45
Visitor Feedback.....	45
Chapter 5: Recommendations and Conclusion.....	46
5.1 Recommendations .....	46
Evaluation Methods.....	46
Software Options .....	47
Additional Recommendations .....	49
5.2 Conclusion.....	49
Bibliography .....	51
Appendices.....	56
Appendix A: 2013 BPMA Last Post Exhibit Evaluation Form .....	56
Appendix B: Newly Designed Postal Maps Event Survey .....	57
Appendix C: Newly Designed Survey for Last Post Exhibition in Mansfield.....	58
Appendix D: Interview Questions for Staff at the Last Post Exhibition in Mansfield .....	59
Appendix E: Visitor Interview Questions for the Last Post Exhibition in Mansfield .....	60
Appendix F: Plans for Evaluation at the Last Post Exhibition in Mansfield .....	61
Appendix G: Instructions for Creative Writing/Drawing .....	63
Appendix H: Survey Types .....	64
Appendix I: Potential Products Information Spreadsheet .....	65
Appendix J: The List of Panels at the Last Post Exhibition in Mansfield .....	70

## List of Figures

Figure 1. Postal letters written by soldiers in WWI (BPMA, 2014) .....	5
Figure 2. Duration of verbal exchange (Clinckemaille et al., 2010) .....	11
Figure 3. BPMA Twitter account .....	12
Figure 4. BPMA account on Facebook. ....	12
Figure 5. Pie charts depicting results from Ironbridge Gorge Museums Surveys.....	23
Figure 6. Original survey .....	27
Figure 7. Survey with planned changes .....	28
Figure 8. Edited survey.....	29
Figure 9. Layout of Last Post exhibition in Mansfield .....	32
Figure 10. Pictures of Last Post exhibition in Mansfield .....	33
Figure 11. Panoramic picture of a corner of the layout.....	34
Figure 12. A corner of the layout in Telford Central .....	34
Figure 13. Map of the Last Post exhibition in Telford Central .....	34
Figure 14. Survey results from the Postal Maps event .....	36
Figure 15. BPMA Twitter feed.....	38
Figure 16. Results from the Last Post exhibition in Mansfield .....	40
Figure 17. Results from the Last Post exhibition in Telford Central .....	41
Figure 18. Display with no attention in the Birds exhibition .....	43
Figure 19. iPad with Survey Monkey(Survey Monkey, 2014) .....	47
Figure 20. Family Activity Base (National Portrait Gallery, 2014).....	48

## List of Tables

Table 1. Project timeline .....	21
Table 2. Survey goals, strengths, & flaws .....	25
Table 3. Prototype options for visitor and exhibition evaluation.....	38

## Chapter 1: Introduction

The British Postal Museum and Archive (BPMA), is an organization based in London, England founded in 2004 as a charitable trust. The organization aims to share its postal history and promote communication amongst its visitors by providing a meaningful experience through fun and educational exhibitions. The BPMA strives to attract, educate, and entertain individuals interested in British history and the role of postal communications throughout the centuries. In order to satisfy visitors' needs, the organization has developed changing and innovative exhibitions, events, and tours.

Recent years have seen an increased use of the Internet, and consequently people have become less inclined to visit museums and archives to learn about history and gather information. The BPMA, along with many museums around the world, competes with the Internet to entice visitors to leave the confinement of their homes to gain knowledge through exhibitions. In efforts to captivate a broad audience, the organization uses social media sites, including Twitter and Facebook to inform enthusiasts about events. Through these social media sites, the BPMA gathers some visitor feedback through comments, observations, and descriptions of a visit. In addition to using social media, the organization created a website with information and teasers to attract the public to its exhibitions. Although their efforts are great, the BPMA is not collecting optimal feedback from visitors; they seek more effective ways of improving visitor engagement in their exhibitions around London.

Through paper surveys and online discussion groups pertaining to exhibition experience, the BPMA has made many efforts to discover visitors' specific enjoyments and preferences. They have developed temporary exhibitions and interactive sites that entice visitors to their many locations. These were all significant and beneficial adaptations the museum implemented with efforts to make the visitor's experience enjoyable. Nevertheless, they believe that there is always room for improvement. While visitor motivation, engagement, and retained knowledge are high priorities for the organization, the BPMA lacks up-to-date, statistically robust, and in-depth data on these aspects of the visitor's experience. This prevented a thorough understanding of visitors and the improvement of their exhibitions in the most effective way.

The goal of this project was to improve the visitor experience evaluation process at the BPMA. Our goal was achieved through four objectives. First, we evaluated the survey and

baseline strategies that the BPMA was using to assess visitor engagement. Second, we identified best practices in evaluating visitor behavior and engagement. Third, we designed and tested prototype tools, which measured visitor experience. Finally, we determined which devices and software tools for data entry and analysis would save time and ensure consistency. Ultimately, we made recommendations to the BPMA, based on what we determined were the most efficient methods of improving the visitor experience evaluation process.



## **Chapter 2: Literature Review**

In this chapter, we synthesized relevant articles, and assembled best practices for museum evaluation strategies. The most recent literature associated with our topic includes a set of case studies that suggests an array of survey solutions. First we investigated the BPMA's mission in order to identify which survey parameters best fit their purpose.

Our research concerning survey design and the analysis of the resulting data, conveyed knowledge about survey tactics, which contributed valid information for the BPMA and the Last Post Exhibition processes. We broke down these two objectives (survey design and analysis) by evaluating our research, methods of data collection, and media in which surveys are conducted (online or paper, interview based, multiple choice, or open-ended). Case Studies, deemed successful, suggested that the focus of these surveys revolve around (1) demographic profiling; (2) visitor motivation; (3) visitor experience and ways of engagement; and (4) visitor response/takeaway. Many of the studies that we found included multiple approaches using the above four themes. As such, we evaluated each dimension. In order to paint a more in depth picture of our project, we will begin with a description of the organization with whom we worked.

### **2.1 Site Description**

The British Postal Museum and Archive's mission is to educate visitors about the history of the British Post Office: how it came to be and the way in which it served its country. The museum's values include access, sharing, excellence, preservation, and learning (BPMA, 2014). The founders wanted to share their knowledge, preserve history, make the organization's information accessible, and create a pleasant environment for attendees to spend time. Their vision is to foster an appreciation of British history by viewing history through the lens of evolving means of communication.

In keeping with their mission, the BPMA offers rotating temporary exhibitions and events that include outreach, discussions, and tours, all of which are complemented by information easily accessed on their website. For example, the Last Post Exhibition rotates through four host museums: Mansfield Museum, The Guildford Museum, The Charville Library,

and the Brading Roman Villa. By having an assortment of sites, the BPMA promotes diversity in viewer attendance and experience; visitors who commonly come to these museums are able to view different exhibitions rather than revisiting fixed exhibitions. The BPMA's exhibitions are not only family-friendly, but also offer interactive displays that include educational games. They purposely pose questions for visitor discussion in order to better engage their visitors' critical thinking. In doing so, the BPMA encourages the idea that communication is not only illustrated by the exhibitions, but also takes place within the museums halls.

Our task was to evaluate visitor response to the Last Post Exhibition, which detailed the Post Office's role during World War One. The exhibition was scheduled to run from April 5<sup>th</sup>, 2014 through December 13<sup>th</sup>, 2014 and was curated by the BPMA and the Churchill Museum and Cabinet War Rooms; a location that contains the "wartime bunker that sheltered Churchill and his government during the Blitz (the German air raids conducted on Britain in 1940-1941)" (BPMA, 2014; IWK, 2014). Each exhibition had a corresponding online component that allowed visitors to view detailed history of "Front Line Communication, Primary Source Articles regarding the postal surface, censor stamp, home front and delivering mail to a world at war" prior to or in lieu of visiting the exhibition (BPMA, 2014). The BPMA thus promoted accessibility to information and free engagement.

The entirety of the exhibition was based around the idea of viewing World War One through the lens of communication. The BPMA wanted visitors to use the museum as a way of stepping outside the current situation and understanding the past, namely war time interaction between people hundreds of miles from one another. They hoped that their visitors would gain a deeper understanding of the information, and that the material spurred discussion at the exhibition. The BPMA's purpose is to develop visitor engagement in its exhibitions; visitor feedback is crucial in optimizing a visitor's engagement and experience.

The information provided by the BPMA website followed their mission of encouraging education beyond the museum's physical establishment. The museum locales, however, provided the primary source materials for visitors viewing text and illustrations of post stamps, postcards, and letters between soldiers and loved ones. The exhibition had images and displays of postal letters written by British soldiers during World War One (see Figure 1). The museum also displayed telegrams between the government and military leaders, and communication

technology used between 1914-1918, such as antique telephones, typewriters, and Morse code keys.



Figure 1. Postal letters written by soldiers in WWI (BPMA, 2014)

## 2.2 Best Practices in Survey Design

To best understand how to assess visitor engagement, we evaluated the construction of surveys used in other museums. We examined methods of survey design and implementation and discovered multiple reference points for creating surveys. We classified components of each study into the following categories: survey design, demographic profiling, motivation for visit, visitor experience, types of visitor engagement, knowledge acquisition (visitor takeaway), and best methods of data analysis.

A report titled “Writing Good Survey Questions” from the University of California, San Diego, discussed ways in which questions can be phrased (in either vague or helpful ways) for the intended audience. They believe that the best questionnaire can be created only if the designer “establish[es] goals, develop[s] questions and response[s], pilot[s] test questions, and re-evaluate[s] each question” (UCSD, 2013). A survey should accomplish the following with questions that should be specific, concrete, and avoid double negatives; survey authors should also avoid leading questions (UCSD, 2013). The aim of a study is not to confuse and frustrate the respondents since surveys are optional.

Researchers also offered other advice addressing ambiguity. They suggested that if survey creators desired specifications of how many times someone visited a museum, a question should ask for a specific number (UCSD, 2013). They stress that is important to avoid asking

questions in which the test subjects do not have access to information required to answer (i.e., questions must be straightforward, unambiguous and linked to the exhibition under observation). The authors also recommended no option that allows visitors to skip the question or fill in a blank answer. Visitors should have the option of rating experiences on a balance scale giving choices of poor, fair, good or excellent (Barlow, 2010).

Related to the UCSD study, the University of Arts in London released a document about effective survey methods. This study evaluated both open-ended and structured questions. By doing this, they gave weight to both methodologies. They argued that the most effective surveys consider visitors' attitudes towards the subject matter and anticipate a reaction of the subjects (Barlow, 2010; UCSD, 2013). This information leads the researchers toward making changes to suit their audience. The comparative advantage of creating a survey versus making "uninformed" changes to an organization saves time and resources. A strong design yields a survey with testable hypotheses that suggest common aims for improving specific elements of visitor experience.

### **Profiling visitor demographics**

Throughout our review of the academic literature, we assessed a wide range of strategies for categorizing demographics of visitor/survey participants. Demographical questions include age, gender, nationality, income, education, and distance traveled, to name a few. This enables the organization to see what audience was attracted to their displays, and to identify the groups who were not interested in the presented information. In evaluating this information, organizations can determine ways to appeal to the demographic groups underrepresented in the museum-going populace.

The San Francisco MOMA was the subject of a report titled "Design Thinking for Visitor Engagement" in which visitor demographics were addressed. They argued for visitor assessment by stating that the main problem in addressing the demographic as "museum visitors" was that it generalized the museum's audience. Instead, the population should be broken down into smaller subcategories. Through categorization, the SFMOMA identified each group's goals and objectives for visiting the museum. They divided the visitor population into the following categories: "young professionals, parents with children, adults, and out of town visitors" (SFMOMA, 2013). These stratifications enabled the SFMOMA to research these groups

thoroughly and glean specific insights about their motivation for visiting the museum. We evaluated their findings in greater depth in the “Knowledge Acquisition (Visitor Takeaway)” section of this document.

Similarly, in a survey method study directed by the Wisconsin Historical Society, visitors were classified by “age, gender, education level, distances traveled, life stage, and alone or with family and friends” (SFMOMA, 2013). They took the concepts from the SFMOMA study a step further by addressing the question of who does not visit their organization (SFMOMA, 2013).

In “Identity and the Museum Visitor Experience” by J.H. Falk, additional research provided depth to the previous sources. Specifically, he looked at different ways that multiple studies had quantified visitor profiles. It not only assessed “what time of day, what day of the week, and what time of year” visitors typically visited museums, but it also analyzed “visitor frequency and social arrangement” (Falk, 2009, p.28). He concluded that the most consistent group of individuals that visits museums was “better educated, more affluent, and held better paying jobs than the average citizen” (Falk, 2009, p.28). Falk further identified a case study performed by the Smithsonian that stated “visitors to Art and History Museums tended to be older than the average (between the ages of 20-44)” and in general, museum-goers tended to be within the ages of 30 to 50 (Falk, 2009, p.29).

Although he listed ways in which demographics have been useful in studies, he argued that such information can be insignificant when attempting to correlate reasons behind motivations to visit the museums. Falk states that all demographic data yielded a false explanation because such data of gender, age, wealth, ethnicity and education does not give insight into how visitors *related* to the subject matter and structure of the exhibitions (Falk, 2009, p.30-31). Of demographic observations, the most vital information that can be gathered concerns visitor frequency and social arrangement (Falk, 2009, p.32). In doing so, Falk argued that insight can be harvested in a more productive way by addressing visitor motivation; an idea that can help museums target specific desires of individuals. Demographic research was important to the BPMA because it gave us an idea of who their visitor population was and how to identify those who are underrepresented. However, we were cautious in creating any sort of correlation and in formulating a heavily demographically based survey.

## Visitor incentive and motivations

As Falk and the SFMOMA suggest, the primary reason for looking at demographics was to identify visitor motivation for spending time at museums. The SFMOMA categorized visitors into groups that detailed a specific emotional or physical need in visiting museums. As an example, the SFMOMA created the following demographic and motivational relationships: young professionals came to museums to seek “inspiration for their own professional work,” parents with children came to share an educational experience with their children, adults came because they viewed the museum as a “sanctuary,” and finally the out-of-town visitors came because it “fit their itinerary” (SFMOMA, 2013). The SFMOMA’s appeal to emotional motivations of their visitors “guide[ed] teams towards testable solutions that [met] the real, emotional needs of individuals, as opposed to basing design decisions on demographic-related assumptions” (SFMOMA, 2013). Visitors were grouped and organized according to their emotional maturity rather than by relatively superficial demographic associations. In doing so, the SFMOMA argued that changes could be implemented in the very design of their exhibitions to please target populations.

In the visitor survey created by National Services Te Paerangi, a group that worked in conjunction with museums and galleries in New Zealand to set up programs with the intention of entertaining visitors, specific questions were asked to identify visitor motivation. Such questions included: “Was there anything in particular you planned to see before you arrived?” and “Is there any particular reason you did not visit a specific exhibition?” (NSTP, 2012). By keeping track of the reasons given by attendees who planned out museum visits, we determined what specifically motivated visitors to engage with the BPMA and similar institutions.

In looking at a case study conducted by the Seattle Art Museum, two clear motivations were identified: “Coming to a special exhibition was the most frequently cited reason for coming to the museum (26%)” and “the next most common reason... was to spend time with friends and family (11%)” (PPR, 2002). As the percentages suggested, the reasons featured do not make up for the majority of the visiting population, but in creating our survey, motivation was a focus. The Seattle Art Museum had just scratched the surface of motivation in their case study, but having such questions as focal points helped them understand *why* visitors attended their exhibitions. Similar to the SFMOMA survey creation suggestions, a team of WPI students working at the British Museum classified motivation into four categories: social, intellectual,

emotional or spiritual (Clinckemaillie et al., 2010, pp.1, 8). By identifying the ways in which a specific experience could appeal to those four categories, exhibition design could better match visitor expectations.

In agreement with these ideas, the Henry Art Gallery case study asked students why they visited museums. They found the most prevalent reasons why visitors came to the Henry Art Gallery were “out of curiosity (41%),” “to see a specific exhibition (40%),” and as “part of a class or tour (24%)” (Bailey, et al., 2013, p.7). The Henry Art Gallery study took our previous case studies a step further by categorizing museum visits as leisure time. It found that the six most relevant reasons to visit included “being with visitors, doing something worthwhile, feeling comfortable or at ease in one’s surroundings, having a challenge of new experiences, having an opportunity to learn, and participating actively” (Bailey, et al., 2013, p.6). By acknowledging that museums provide a leisurely environment for visitors, the Henry Art Gallery focused on the notion of “enjoyment” as a key motivation. They were able to create exhibitions that catered to a combination of the six motivations to reinforce a specific sort of museum *environment*. In summation, we return to Falk’s idea (supported by the WPI student led report at the British Museum) of organizing the space, design, architecture, and visitors programs of an exhibition around such factors that affect the cultural, personal and physical desires of the visitors (Clinckemaillie et al., 2010). The BPMA could identify and create new ways of attracting visitors by looking through the lens of past and current studies on visitor motivation.

### **Visitor experience and manner of engagement**

Following directly from the idea of motivation for visiting a museum or gallery comes the notion of visitor experience, engagement and ways of engagement. The two sections are closely tied as the first capitalized on the expected visit while the following evaluated the actual visit. Visitors engaged with exhibitions in two separate arenas as demonstrated by the BPMA: the physical museum site and the online exhibitions. While both were experienced separately, they also complemented one another and aided visitor’s potential wealth of knowledge. Below we detail onsite visitor engagement with actual exhibitions.

In a report on the British Museum, a team of Worcester Polytechnic Institute (WPI) students evaluated visitor experience by first identifying the different ways visitors could and then did engage with the exhibitions. Falk, along with the WPI study, concurred that visitors

could be classified as “browsers, followers, searchers, and researchers” and that browsers made up 68.4% - 73% of viewers (Clinckemaillie et al., 2010, p. 32; Falk, 2009, p. 219). They argued that visitors with different motivations for museum visitations tended to have different “depths of engagement,” meaning they could absorb the information presented through “orientation, exploration, discovery or immersion” (Falk, 2009, p.190; Clinckemaillie et al., 2010). These groups each were constructed of individuals who were willing to only dedicate a certain amount of time to viewing any particular exhibition (Falk, 2013, p.219). The students found that 40% of visitors view exhibitions on an orientation level (quick glances not stopping to often), 37% on an exploratory level (stopping for short periods of time to learn information but “not long enough to acquire considerable sources”) and the remaining 23% engaged in discovery and immersion (stopping for long periods of time taking in considerable amounts of knowledge) (Clinckemaillie et al., 2010, p.33). Falk also used this breakdown and noted that the majority of visitors are explorers. He went on to evaluate how explorers wanted to experience the museum.

Falk depicted an “explorer” as someone who prefers exhibitions “rich in detail and information that allow them to exercise their mind,” rather than being “spoon-fed the information” (Falk, 2009, p. 219). Explorers want displays to be clear and exciting so they can “determine if it is something they might be interested in,” (Falk, 2009, p. 218). This suggested that visitors wanted to be trusted and that they saw exhibitions as a way in which they can exercise critical thinking skills. Hanna Cho, the Curator of Engagement and Dialogue of the Museum of Vancouver, agreed with the idea that visitor engagement was about “knowledge driven exploration” (Museum Ideas, 2014). Information such as this affected the very design and emphasis on exhibitions from text to illustrations.

In 2009, the Museum of Vancouver began leading “provocative conversations” about their city’s “past, present and future” (Museum Ideas, 2014). Visitors were not passive objects but interacted within the museum itself in discussions. Cho added to Falk’s idea that visitors are mostly explorers. To meet stimulation needs, the Museum of Vancouver created an environment that fostered learning, communication and the culmination of ideas.

Cho’s desire to discover the type of experience visitors looked for in visiting museums tied to the way visitors liked to be treated and their desire for absorbing the presented information. Museums took into account that discussing prevalent ideas brought visitors together and created a productive and encouraging environment within which their learning was



furthered. Through research and survey studies, the Henry Art Gallery found that in order to entertain and attract visitors, the museum needed to be a “hub where visitors [felt] they [could] come often and stay for extended periods of time” (Bailey et al., 2013, p. 5). In order to determine what visitors liked, they contemplated the following questions: do visitors like interaction? , How much do visitors interact? and, Why do they come? (Bailey et al., 2013, p. 7). Their studies showed that 81% of the visitors felt comfortable at the museum (Bailey et al., 2013, pp. 7-8). Figure 2 below, demonstrates that visitors desired to talk to staff even if it was only for a short time and that those involved in open discussions were more likely to discuss art (or the exhibitions presented):

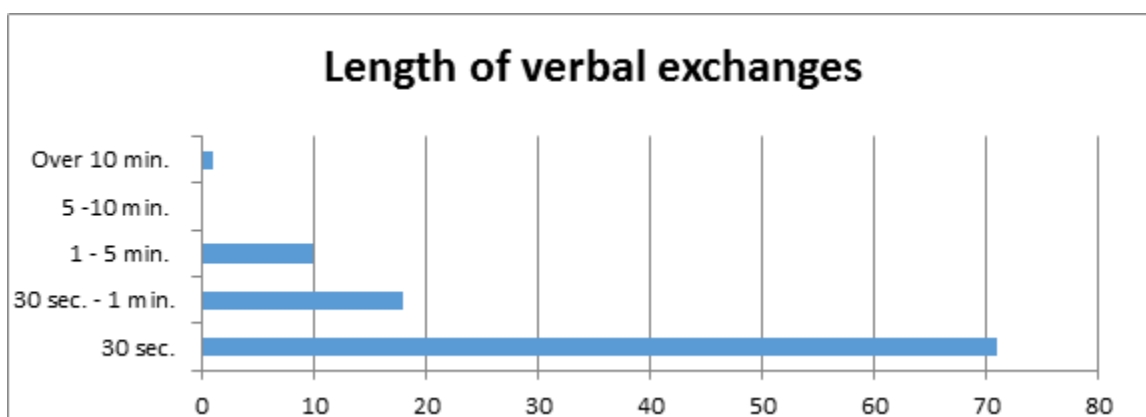

Figure 2. Duration of verbal exchange (Clinkemaille et al., 2010)

In 2010, the Interpretation Preference study conducted by the *Conner Prairie Interactive History Park* located in Indiana, collected 40,000 surveys and found the type of experience visitors preferred: tours, traveling around on their own, or interacting with staff (Museum Audience Incite, 2010). It was determined that at history museums, 60% of visitors would rather look at the exhibitions on their own, and 59% of that same 60% enjoyed talking to staff for brief moments (Museum Audience Incite, 2010). The 59% who were not on tours liked to ask occasional questions that strengthened their understanding of the provided information, (Museum Audience Incite, 2010). From these studies, we noted that the observed visitors enjoyed being in a welcoming environment where communication was encouraged rather than environments where silence was enforced.

The idea of collecting all this information was to gauge visitors’ responses to museum exhibitions. Researcher Elena Villaespesa wrote a paper about Museum’s Social Media Stream

illustrating that surveys were not the only way to get feedback on visitor experience and engagement in presented material (2013). Villaespesa showed social media did not just give information to the populous, but could also be helpful for the museum in gaining knowledge about its attendees. In looking at technological methods to retrieve and gain data, the Seattle Art Museum used a method that “consisted of coding qualitative survey responses and electronically scanning quantitative survey responses” (PPR, 2002, p.11). The BPMA looked into using such methods as social media and technology in gaining information faster and more efficiently about their visitors. Villaespesa stated that a “museum’s presence on social media platforms comes not only from its own online activity, but also from everyday visitors who share content about the museum, express their opinions and experiences, and post photos taken during their visit on platforms like Instagram, Facebook, or Twitter,” (see Figure 3 and Figure 4) (Villaespesa, 2013).



Figure 3. BPMA Twitter account



Figure 4. BPMA account on Facebook.

This sort of engagement has a positive impact in keeping museums up to date with the social sphere that the Internet has created.

### **Knowledge acquisition (visitor takeaway)**

Finally, some surveys asked visitors what they ultimately gained from their museum experience. Having looked at the data from the Museum Audience Incite, we determined that visitors who typically go to museums reported that they enjoyed their experience. One aspect of museum output was education and making sure the viewer population enjoyed their time spent. In support of this idea, the Seattle Art Museum discovered that 97% of their visitors felt the museum to be an inviting place to come and spend time with their families (PPR, 2002). Similarly, in an example taken from a visitor evaluation, 91% of the surveyed population came to learn about a particular artist and found the experience educational (PPR, 2002).

These studies suggested that visitors typically come to museums for a welcoming atmosphere and a learning experience. Those who visit museums frequently intend to enjoy themselves and learn something new. These findings suggested that surveys should determine if the museum visitors were enjoying their experience and perhaps learned more than what they came to see.

### **2.3 Methods of Analysis**

In collecting this information, we noted multiple ways of analyzing data statistically or by identifying general patterns. The Seattle Art Museum analyzed their data using SPSS (Statistical Package for the Social Sciences) which took their data and calculated “frequencies, percentages, means, and medians, as well as exploratory analysis techniques” (PPR, 2002, p.11). Dr. Barlow’s at the University of Wisconsin LA Cross evaluation, called the Effective Survey Design and Analysis, stated, that “Web surveys typically [were] able to download data into a spreadsheet or word processing files” making the process of analysis easier while “(paper, telephone) [surveys] need to be hand entered or transcribed” (Barlow, 2010, p.10). Organizations that desire to make generalizations of the survey data used the paper or telephone approach. Organizations that sought statistical analysis of survey data had a quicker response if they used web-based surveys. Dr. Barlow also suggested that since it is “inconvenient” for visitors to take surveys, having a survey online made it an on-the-go experience and allowed visitors to fill out the survey at their convenience (Barlow, 2010).

## 2.4 Summary

In our research, we found that a reliance on demographic-heavy questions is not as fruitful as we first thought. Instead of using characterization of the populace to classify visitors, the literature suggested positive results were derived from placing visitors into categories such as browsers, followers, searchers and researchers. It was interesting to find that though visitors preferred to explore museum exhibitions by themselves, they desired communication with the staff. In addition, it was also intriguing to read that museums were not just tourist sites, but places where locals could relax and spend valuable time with family and friends. The literature review enabled us to reconsider the relevance of certain questions. In moving forward, we aimed to keep visitor “exploration” categorization, visitor motivation, visitor experience, and ultimate visitor takeaway in mind. The most important element in survey creation entailed keeping the museum’s goals and visions at the forefront of our methodology. Understanding visitor motivation and what the museum desires to acquire from their visit was key when suggesting ways to facilitate change.

## Chapter 3: Methodology

The goal of our project was to improve the process of evaluating visitor experience for exhibitions provided by the British Postal Museum and Archive (BPMA). To meet our goal, we followed these objectives:

1. Evaluating the BPMA's current survey and other baseline strategies used to measure visitor engagement.
2. Understanding and identifying site-specific needs, constraints and parameters of museums and their exhibitions.
3. Designing and testing tools that measure visitor experience.
4. Determining an effective tool (device or software system) for data entry and analysis.

To meet each objective, we used strategies that included onsite research, visitor interactions, and interviews with visitors and staff members. Our design is summarized below.

### 3.1 Objective 1: Evaluating the BPMA's current survey and their baseline strategies

In efforts to improve visitor experience evaluation at the BPMA, we examined research reports and case studies that identified best practices in visitor evaluation. Upon our arriving in London we turned our focus to information that was unavailable in the United States. This included assessing the BPMA's existing survey format, conducting interviews with the BPMA's staff, participating as if we were visitors in their original survey, and visiting the Natural History, Victoria and Albert, and Science museums in London to research the most effective interactive displays.

With BPMA's existing survey, we noted each survey question's goal and attempted to identify flaws and strengths. In Qualitative Research Methods, Berg and Lune furthermore suggest analyzing the old data in depth in order to identify if past lines of questioning worked (Berg & Lune, 2012, p. 307). From analyzing data, we determined a constructive way to build on pre-existing information.

Drawing from our preliminary research, a study at the University of California San Diego (UCSD) determined that surveys with open-ended and specifically-targeted questions gave the

researcher the most relevant and necessary information (UCSD, 2013). Using best practices derived from our literature review we began looking at the BPMA's baseline survey and created a balance of multiple choice and open-ended questions. The original BPMA surveys and subsequent can be found in Appendices A-C.

To make sure we were collecting the right type of information ensuring the analyzed results had meaning, we checked the surveys we collected to determine if they were filled out properly. SurveyPro, a web based interface for creating surveys, gave us key ways to remove outliers from data and for teams to make sure results were clear. SurveyPro's research suggested that the "response should be discarded if the respondent did not complete enough of the survey to be meaningful" (SurveyPro, 2013). It also stated, that if visitors filled in the "other" option, the analyzers categorized that information so that the "other" responses [would not be] overstated and the correct response would be understated" (SurveyPro, 2013). As some studies suggested, it was often better to leave out the "other" option.

To make certain our data was relevant, we took all of the above cautions into account and filtered through our gathered data with specific parameters for identifying "outliers;" outliers lead us in the wrong direction when analyzing observations. The surveys needed a balance between straight-forward and open-ended questions. One method of ridding a survey of all outliers would be to create a questionnaire that consisted of only multiple-choice questions; however, this option advised by our research was believed not to give us diversified constructive feedback. Therefore a survey should have clear questions, and should be looked over by the constructors with extreme care once it has been filled out.

In addition, we interviewed key BPMA staff that worked on visitor evaluations. These interviews were designed to give us insight into what the BPMA expected to achieve, and understand information on current exhibition and event evaluation methods. Semi-standardized meant that our interactions were structured, but were adjusted to follow the flow of conversation (Berg & Lune, 2012, p.109). We prepared an interview guide in order to specify questions or objectives (Berg & Lune, 2012, p.109). This informal interview structure was designed to enable us, and the participants, to feel at ease (Berg & Lune, 2012, p.109). The interview guide can be found in Appendix D.

In addition to staff interviews, our own participation in the survey, and analysis of survey questions, we also asked visitors to comment on their survey experience as a whole. We would

stand near the exhibition, introduce ourselves as researchers of visitor engagement and ask if they would mind to answering a few questions about the exhibition. Reactions to the evaluation methods were as important as the questions themselves. If people were eager to give their feedback, we would note that the environment we created was encouraging for discussion. If people did not want to give feedback we made a note that they were either busy, did not want to interact with us or that they were not interested in the exhibition.

Creating new surveys and interviewing staff gave us helpful data on what the norm is at exhibitions, and how research on evaluating visitor experience has been conducted to this point. This foundation allowed us to have a better grasp on what we needed to do in order to achieve our goal.

### **3.2 Objective 2: Site-specific needs, constraints and parameters of museums and their exhibitions.**

In order to create the best evaluation tool, we assessed the exhibition, gauged levels of visitor activity, and ensured the production of useful data. In creating surveys and interviews, we used our research to eliminate questions that were not in sync with our goal of increasing visitor engagement. Specifically, existing questions such as “Have you worked for Royal Mail?” were deemed unnecessary since people tend to share this fact elsewhere (see Appendix A).

Attending and observing exhibitions and events gave us immediate feedback. In visiting the Natural History, Victorian and Albert and the Science museums in London, we evaluated their interactive displays and visible visitor evaluation methods. We took pictures of interactive displays that the visitors seemed to enjoy. We noted which museums had more interactive displays. We noted which museums kept our interest, why and how we could use this information to make the BPMA exhibitions more exciting. We also made note of any interactive activities that both our team and these renowned museums were using.

By evaluating the BPMA’s and other museums interactive displays, we were able to see how other museums engaged and evaluated visitors, and then use this information to aid the BPMA. A Postal Maps event during week-one was the first opportunity we had to survey and interview visitors. It gave us a foundation for how we would approach future events. Appendix B has the Postal Maps survey we created and used at this event. In week three, we attended the Last

Post Exhibition in Mansfield, England. After analyzing the survey results from the Postal Maps event, we designed a new survey called Last Post Exhibition in Mansfield Survey (see appendix C). At the Last Post exhibition in Mansfield, we also observed visitors' movement through the exhibition, counted how many visitors attended the exhibition, quizzed visitors on displayed information, and handed out the Last Post Exhibition in Mansfield new surveys. We interviewed staff and visitors, posted visitor quotes on Twitter and set up a creative writing/drawing booth.

Site-specific surveys, quiz questions based on exhibition displays, and interviews gave us a variety of ways to engage the visitors. In creating our oral quizzes we first went over all the information that would be displayed at the exhibition. Our oral quiz was composed of simple questions, which showed us visitor comprehension of exhibition displays. We planned to ask one question per visitor, with the promise of a candy prize to encourage participation regardless of a correct answer. Our questions were either broad or detail-specific to information the visitor had just read or observed. If visitors commonly answered the broad question correctly we knew that the basic information had been understood. If the visitors did not want to be quizzed or preferred to pass on the questions we would infer that this method was not popular nor would it give us substantial information.

In the Henry Art Gallery study in 2013, experts observed how often and how long visitors spoke with staff in order to determine how much people were apt to communicate during a visit (Bailey, et al., 2013). The interview questions we asked the staff, however, focused on what they normally observed. Such questions included, which days of the week were busier (please see Appendix D for the interview questions). In interviews with visitors we asked the survey questions more in depth. Questions included what the visitor learned from their time at the exhibition (see Appendix E for visitor interview questions).

We spent two days at the BPMA's Last Post exhibition in Mansfield. Appendix F details the evaluation method each team member conducted. Tasks were divided between group members and rotated every hour at the exhibition. From the information gathered at previous sites, we had insight into which methods of evaluation were and were not working. These data allowed us to better prepare for our attendance at the Last Post Exhibition at Coalbrookdale in week five.

After attending the exhibition at Coalbrookdale, we drew a floor plan of the exhibition. Previous experience showed us which member gained the most results in specific tasks.



Therefore, while onsite we played to our strengths. The information gathered from all of the exhibitions and events would lead us to making recommendations to our sponsor on which of the methods were efficient, favored, and provided the most robust data.

### **3.3 Objective 3: Designing and testing tools that measure the visitor experience**

The key to our project was not only to find best practice for evaluation, but also to compose innovative ways of evaluating visitors. Although we still incorporated the common method of survey distribution and analysis, we wanted to explore different options. We tested such things as quizzing visitors, and developed a creative writing/drawing center at the end of each exhibition. We also utilized Twitter and Facebook by posting quotes of people we interviewed, and submissions from our creative writing/drawing activities.

At the end of each exhibition we had a table with paper and pens where visitors could write a short creative piece or illustrate a drawing. This activity suggested visitors draw or write something pertaining to the exhibition, meaning that the author could travel back in time or draw an artifact displayed that they enjoyed. The written piece was instructed to be between one and two sentences. The short length allowed us to post the piece on Twitter, since Twitter limits submission length to 140 characters. See Appendix G for the instructions, which were posted on site. The instructions informed the visitor that their written piece or drawing would be published with their first name credited. We went through the box of submissions and chose the responses that we thought best represented the material displayed at the exhibition. The BPMA encouraged us to use their Twitter and Facebook accounts to motivate visitors to participate in this activity and submit original works to the creative writing/drawing center.

In determining the best methods for analyzing the data, we listed the pros and cons of several approaches. According to Maxwell, paper surveys are easy to distribute, but are time consuming to transfer the information into a digital format for further examination (2013). Paper surveys can be scanned or placed in automotive classifier or grading machine to easily upload the paper forms onto a server, but that would require specific guidelines for the visitor to follow in order for the scanner to read the forms accurately. The most recommended method of conducting a survey is to complete a survey online or via a telephone application (Maxwell, 2013, p.192-193). Online survey data was immediately inputted into our database, and was

analyzed easily and timely. However, with technology, there is always the possibility of running into malfunctioning devices, server crash, or poor Internet connections and cost of Wi-Fi. Despite malfunctioning technology, these methods allow visitors to take the survey at their own leisure, convenience or “on the go”. These options, and their pros and cons, are attached in Appendix H. This allowed us to decide which practice was most effective.

By interviewing, observing, researching, and interacting with those surrounding us at the BPMA and other museums, we were able to develop and test an array of prototypes. Each prototype generated separate data, which we compared on a large scale in order to distinguish between which activities gauged a positive reaction and which provided substantial relevant data.

### **3.4 Objective 4: Determining an effective tool for data entry and analysis**

In order to analyze data more efficiently we researched devices and created a spreadsheet with relevant information. We visited the Science, Victoria and Albert, and the Natural History Museums in London to see what they used as innovative interactive activities in addition to data processors. We also attended the Museum and Heritage Show, which presented many different tools museums could utilize. The trade show provided a range of things from gift shop wares to display cases. In attending the event we took note of useful products and began further research. We researched interactive displays, devices to take surveys on, software to analyze survey results, and other interesting tools the BPMA could use. This spreadsheet can be found in Appendix I. We detailed the names of the device, the company that created it, device ability, cost and duration of effective use. The spreadsheet included devices such as iPads, interactive kiosks, self-guided tour devices, and mobile applications. This spreadsheet allowed us to decide which devices were promising, and which best fit the BPMA’s needs and budget. This research was conducted throughout the duration of the project. As we continued to evaluate methods at exhibitions and events, necessary devices became apparent.

### 3.5 Data Management and Timeline

We conducted our study at BPMA exhibitions from May 12th to June 27th. During this time we stored all research, prototype surveys, and data on password-protected computers. After analyzing our data and determining the needs and desires of our visitors, we proposed adjustments that the BPMA could make to improve the visitor experience evaluation process. The data was destroyed upon completion of the project.

The following chart depicts the timeline that we followed to meet our objectives.

Timeline	Week 1	Week 2	Week 3	Week 4	Week 5	Week 6	Week 7
	5/11-5/17	5/18-5/24	5/25-5/31	6/01-6/07	6/08-6/14	6/15-6/21	6/22-6/28
Visit Museums							
Visit BPMA Exhibitions							
BPMA Events							
Data Analysis							
Revise Survey							
Interview Visitors							
Survey Visitors							
Research Software							
Set up Interactive Displays							
Build Prototype							
Final Analysis and Conclusion							

Table 1. Project timeline

## **Chapter 4: Results and Discussion**

The information provided in this section presents and discusses the results of the research that we conducted in London from May 12, 2014 to June 27, 2014 while working with the British Postal Museum and Archive (BPMA). The data gathered was collected in order to determine which methods of visitor evaluation produced the most informative conclusions at each site. The sites we evaluated were the Postal Maps Event at BPMA Phoenix Place, the Last Post Exhibition in Mansfield, and the Last Post Exhibition at Coalbrookdale. We also attended the Museum and Heritage show, which prompted our research into product information for our sponsors. This chapter is divided in two sections: the results section, which presents our findings; and the discussion section, which provides analysis of our results.

### **4.1 Results**

This section presents our results organized by the project objectives described in Chapter 3.

#### **Objective 1: Evaluating the BPMA's current survey and their baseline strategies.**

In looking at the BPMA's paper survey, there were some aspects that needed to be reworked or changed. We collected and analyzed 54 of the BPMA's completed past surveys from the Last Post Exhibition. Visitors were given the options: Very poor (1), Poor (2), Average (3), Good (4), and Very Good (5), to provide their overall rating of the exhibition. Of the 54 responses we found that the majority from our small sample rated the exhibition as Very good (5). The majority, 89%, filled out their ethnicity as British White. The majority, 63%, also circled yes, that they had learned something from the exhibition, but less than ten people wrote what they had learned. The age of the individuals visiting the event was a mixture that showed the exhibition was appealing to all age groups, with a majority being adults. See Figure 5 for a pie chart depiction of our results.

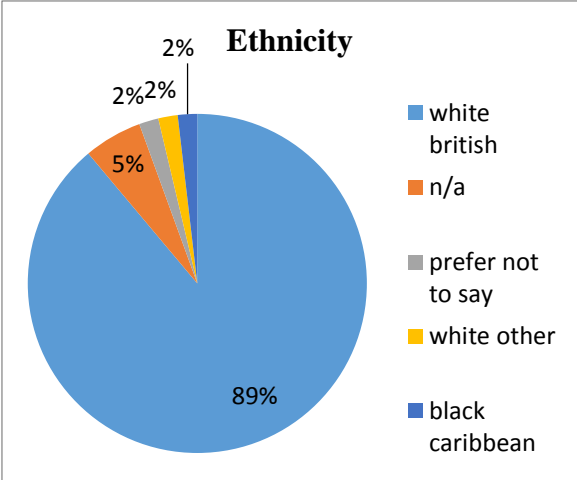
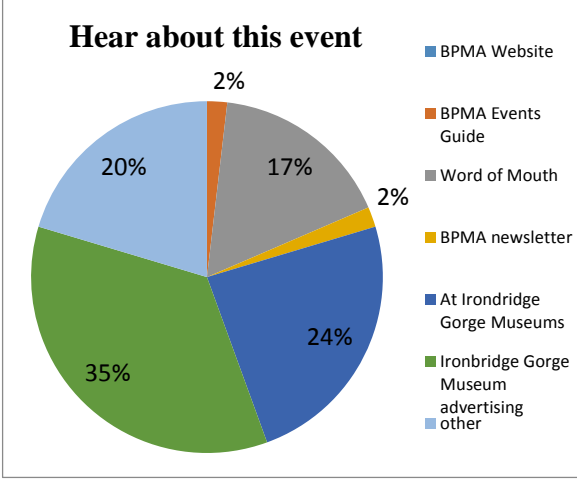
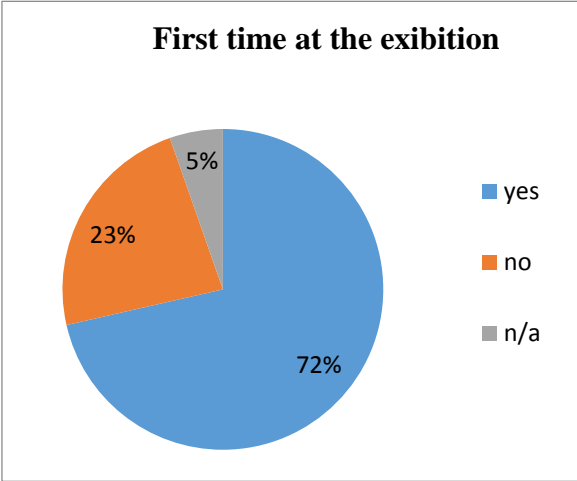
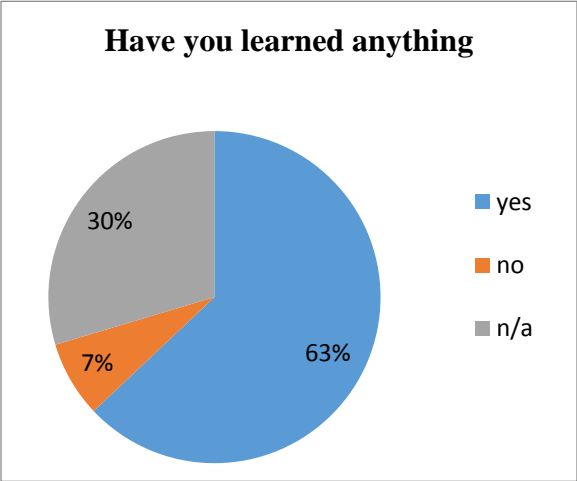
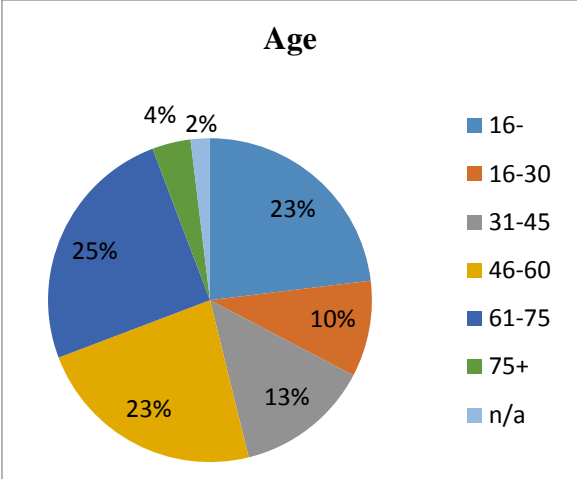
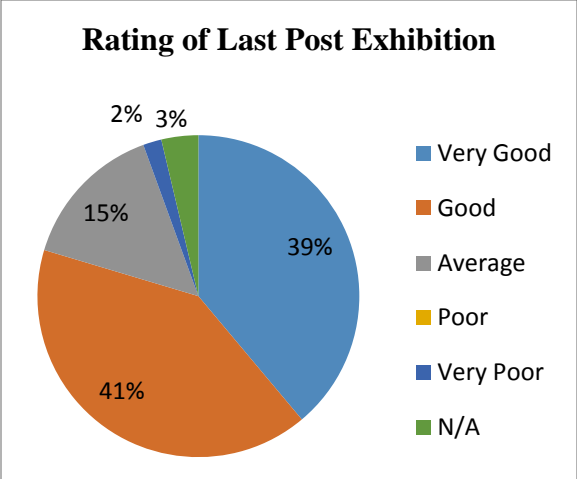

Figure 5. Pie charts depicting results from Ironbridge Gorge Museums Surveys

In looking at these results and using our knowledge from past research we changed some of the questions of the survey. We created a chart, see Table 2 below, which depicts each survey question’s goal and attempted to identify flaws and strengths. We created a balance between open-ended and multiple-choice questions. Firstly, we changed the question asking for ethnicity from multiple-choice to free response. This was done to make people more comfortable and to not leave anyone out of the questions. Selecting the “Other” option when one’s ethnicity is not listed in the multiple-choice can make people uncomfortable. At our events we have received more specific answers, which helped us understand our demographic, which is primarily White British.

<b>Question (original vs. improved)</b>	<b>Goal</b>	<b>Strength</b>	<b>Flaw</b>
What did you enjoy most about it?	To see what was most enticing to visitors	Gives good feedback on what should be emphasized in the exhibition	Does not specify “exhibition” in the question
<i>How to better this question...</i>			
What did you enjoy most about <b>this exhibition</b> ?	To see what is most enticing to visitors	Gives good feedback on what should be emphasized in the exhibition	None. Changed the question to specify the exhibition.
Can you suggest any improvements?	To see what people wanted changed to better their visit	Gives good feedback on what should be different for a better overall experience	None. <b>No need to change this question.</b>
Have you learnt anything new today? (Asked visitor to then circle ‘yes/no’, and then prompted “please tell us more”)	What information provided was new to most people	Shows what information visitors are finding interesting	The ‘yes/no’ option steers the visitor away from elaborating on “Please tell us more.” It would be better to take that option out and leave the question as an open ended question.
<i>How to better this question...</i>			
Have you learnt anything new today?	What information provided was new to most people	Shows what information visitors are finding interesting	Removing the ‘yes/no’ option allows people to go right into what they learned. People will be more inclined to write something if this is left as an open-ended question.
What made you decide	To discover why	This question was removed: proved irrelevant, this	

to come in today?	people chose to come	question was usually answered by “how they heard about the event”	
Is this your first time to a BPMA exhibition? ‘yes/no’	To discover is people are regular visitors	General question that provides straight-forward information. No need for change.	
Do you work for Royal Mail?	To see if employees are interested in the history of the post office	Proved irrelevant: if people worked for the Royal Mail they mentioned it earlier. Question was removed	
How did you hear about this event? (7 options to circle) *see appendices A, B, and C	Where people are getting the information from	Very important to see where people are hearing about the exhibits. Shows which outlets need to be emphasized and which ones are working best.	None. No change to the question
Please help us comply with equal opportunities monitoring by circling your ethnicity: (several ethnicities were then provided)	Which demographic is attracted to the museum; locals or people from other countries as well	Gives good insight to who is attracted to the exhibition	Supplying the visitor with a slew of ethnicities to choose from is not the best practice. It is possible that their ethnicity was not included in the choices, making them to feel left out or not answer the question at all.
<i>How to better this question...</i>			
Please help us comply with equal opportunities monitoring by circling your ethnicity:  *no options given; visitor has to fill in their ethnicity	Which demographic is attracted to the museum; locals or people from other countries as well	Gives good insight to who is attracted to the exhibition	None. Changed the question to leave it open ended.
<p>The following multiple choice questions were added to surveys to gain more insight to a visitor’s needs. They were given the “yes/no” option:</p> <p>Did you come with the intention to see this specific exhibition?  Would you prefer an electronic survey?  Would you feel comfortable if we shared your comments?  <b>PERMISSION:</b> May we use your comments from this form in our reports or publications?</p>			

Table 2. Survey goals, strengths, & flaws

Next, we took away the possibility for people to circle yes or no in the question: “Did you learn anything?” By making this question open-ended, it encouraged people to give us a written response; they could share what they learned rather than circling “yes” indicating that something was learned. We also added site-specific questions to our new event and exhibition surveys. For the Postal Maps events, we added three questions including “Did you like the overall setup of the event?” “Were the refreshments satisfactory?” and “Was the provided information understandable?” Our sponsors were interested in how people liked the setup, therefore it was important to include these site-specific questions. For the exhibition survey we added questions such as, “Did you come with the intention to see this specific exhibition?” “Would you prefer an electronic survey?” and “Would you feel comfortable if we shared your comments?”. These questions allowed us to determine why people had come and what kind of survey they would prefer to take. These questions help us improve future evaluations and yield specific information our sponsors were looking for. Please see figures 6, 7, and 8 as they depict the original survey, our edits to the past survey, and the new survey we created.



## Last Post: Remembering the First World War, by the British Postal Museum & Archive (BPMA), at Coalbrookdale Gallery

We like to ensure that our exhibitions are enjoyable and interesting. By filling out this questionnaire you will help us achieve this. If you have further comments, please note them on the back of this form.

Please rate Last Post on a scale of 1 (very poor) to 5 (very good)

1 (Poor)	2	3	4	5 (Excellent)
----------	---	---	---	---------------

What did you enjoy most about it?	Can you suggest any improvements?

Have you learnt anything new today?	yes	no
-------------------------------------	-----	----

Please tell us more

What made you decide to come today?

Is this your first time viewing a BPMA exhibition?	yes	no
--	-----	----

Do you work for Royal Mail?	Yes	No	Previously
-----------------------------	-----	----	------------

How did you hear about this event?			
BPMA website	BPMA Events Guide	Word of mouth	Other (Please specify)
BPMA newsletter	At Ironbridge Gorge Museums	Ironbridge Gorge Museum advertising	

Please tell us which age range you are in:				
16-30	31-45	46-60	61-75	75+

Please help us comply with equal opportunities monitoring by circling your ethnicity:						
White British	White Other	Other ethnic group	Black Caribbean	Indian	Bangladeshi	Mixed
White Irish	Pakistani	Black African	Black Other	Chinese	Asian Other	Prefer not to say

If you would like to join our mailing list, please leave your name and address here. This information will be detached from the rest of the form.

Name: .....

Address: .....

Email address: .....

The information you provide on this form will be used to improve our future events and in reporting on our events programme. We may use comments (but not names) for publicity purposes.

Would you like to be contacted about comments made?  Yes  No

Figure 6. Original survey

need new title: **Helpful Feedback**

Give us your feedback

THE BRITISH  
POSTAL  
MUSEUM  
& ARCHIVE

### What do you think?

**EVENT & DATE:** → will be <sup>typed</sup> written in for each event/exhibition  
take out

We like to ensure that our events are enjoyable and interesting. By filling out this questionnaire you will help us achieve this. If you have further comments, please note them on the back of this form.

\*note everything remains confidential

Please rate today's event on a scale of 1 (poor) to 5 (excellent)				
1	2	3	4	5
very poor	poor	Average	good	very good

write options

What did you enjoy most about it? Keep as is	Can you suggest any improvements? Keep as is
---	---

Need to shift & compress to make room for additional questions

Have you learnt anything new today?	yes	no
Please tell us more leave as open ended w/ no yes/no option		

take out options & leave blank

Would you recommend BPMA events to a friend? (circle)	Yes	No
---	-----	----

Is this your first time at a BPMA event? (circle)	Yes	No
---	-----	----

Do you work for Royal Mail? (circle)	Yes	No	Previously
--------------------------------------	-----	----	------------

How did you hear about this event?			
BPMA website	BPMA Events Guide	Word of mouth	Other (Please specify)
BPMA newsletter	at another event	Search room poster	

Please tell us which age range you are in: please circle your age range:						
16-25	26-34	35-44	45-54	55-64	65+	

Please help us comply with equal opportunities monitoring by circling your ethnicity:							
White British	White Other	Other ethnic group	Black Caribbean	Indian	Bangladeshi	Mixed	
White Irish	Pakistani	Black African	Black Other	Chinese	Asian Other	Prefer not to say	

take out options & leave blank for visitor to fill in

Make space here for 3 questions

If you would like to join our mailing list, please leave your name and address here. This information will be detached from the rest of the form.

Name: .....  
Address: .....

All get length

move here

Email address: .....

compress and move below

The information you provide on this form will be used to improve our future events and in reporting on our events programme. We may use comments (but not names) for publicity purposes.

Would you like to be contacted about comments made? Y/N

Need to add

1. Do you like the setup
2. Refreshments
3. Was information understandable

If you have comments, please note them on the back.



Figure 7. Survey with planned changes

## Helpful Feedback Form

Last Post Exhibition: Telford Central 12/6/2014

We like to ensure that our exhibitions are enjoyable and interesting. By completing this simple questionnaire, you will help us improve.  
**Everything remains Confidential**

Please rate today's exhibition on a scale of 1 (very poor) to 5 (excellent)				
1 Very Poor	2 Poor	3 Average	4 Good	5 Very Good

What did you enjoy most about this exhibition?	Can you suggest any improvements?

Have you learnt anything from today's Exhibition? Please tell us more

Would you recommend <u>British Postal Museum &amp; Archive</u> exhibitions to a friend?	Yes	No

Is this your first time to a <u>British Postal Museum &amp; Archive</u> exhibition?	Yes	No

How did you hear about this exhibition?			
BPMA website	BPMA Events Guide	Word of mouth	Other (Please specify)
BPMA newsletter	Walking by	Search room poster	

Please circle your age range:					
16-25	26-34	35-44	45-54	55-64	65+

Please help us comply with equal opportunities monitoring by sharing your ethnic background:

Did you come with the intention to see this specific exhibition?	Yes	No
Would you prefer an electronic survey?	Yes	No
Would you feel comfortable if we shared your comments?	Yes	No
PERMISSION: May we use your comments from this form in our reports or publications?	Yes	No

-----  
If you would like to join our mailing list, please provide your name and address here. The information will be detached from the form above.

Name:.....

Email Address:.....

Address:.....  
.....

The information you provide on this form will be used to improve our future events and in reporting on our exhibitions programme. We may use comments (but not names) for publicity purposes

**If there is any other comments, please note them on the back.**

Figure 8. Edited survey

We then took out the question asking if visitors had worked for the Royal Mail in the past. Research done by the BPMA showed us that if a visitor had worked for the Royal Mail they would write it as a comment or share that fact with the staff.

At sites we also interviewed staff member of the BPMA and those working at their exhibitions. We interviewed both Hannah Clipson and Dominique Gardner to see what they had inferred from onsite research, and see what they thought of our changes to the survey. They told us that although the exhibitions generally cater to adults, children do attend them on field trips, and with their families. They explained that the sites do not have staff whom work for the BPMA which makes it more difficult to have expensive electronic devices at the sites for visitors to interact with or take surveys on. They went on to explain that surveys are present at all sites but are not being passed out by staff which makes it more difficult to gain data.

The staff we interviewed at exhibitions was able to give us invaluable data. At the Mansfield exhibition the staff said that the museum has a lot of student tours during the week, but most visitors tend to come on weekends with their family. Having found that no visitors had filled out past surveys, the staff did say that many people missed the exhibition due to its placement. At the Coalbrookdale Last Post the staff said that the busiest days were Mondays and Thursdays. They said that the visitors generally really liked the exhibition but that some complained that the lighting was poor and made it difficult to read the displays.

In seeing if people were interested in giving us feedback, we found that since 54 people had filled out the old survey, people were eager to tell the museum their thoughts. At Mansfield we had to ask all those who passed by to fill out the survey. Although many complied without complaint, no visitors filled out the survey of their own accord meaning all were asked by us to take the time to fill it out. This could mean that they were in a rush, or had not noticed the surveys. If visitors see the questionnaires and have somewhere to sit down and fill them out, visitors tended to be more eager to discuss their feelings with us on the exhibition. All this information was vital for us to make our recommendations.

## **Objective 2: Determine site-specific needs, constraints and parameters of museums and their exhibitions.**

In looking at the site-specific needs, we observed and visited well-known museums in London to see what was and was not working for them. The more engaged the visitor, the more

likely he or she was to share feedback. More feedback yields more data, which allowed us to draw conclusions and further understand the visitors.

Near the South Kensington Underground station in London, are the Natural History Museum, The Victoria and Albert Museum, and the Science Museum. All with free admission, we visited each with the intent to observe and understand a successful exhibition. The Natural History Museum had a variety of interactive games, videos, auditory telephones and three-dimensional displays. The museum provided a welcoming environment where people of all ages could visit and enjoy. The dinosaur exhibition was very popular considering the area being so crowded. The exhibition was set up as a maze and included a different game, movie or modeled display at every turn. The museum also had a minerals room, which was not visited as much. There were no interactive displays in this section and the emptiness of the room made it clear that looking at different stones was not of great interest to most visitors. In another section of the museum, paper and pencils were provided where visitors could draw their favorite mammal. After completing the drawing, they were asked to submit their artwork into a drop box for the chance to have their picture featured next to the activity. Staff members were then able to post 25 new pictures each week that had been submitted from visitors in the week previous. The pictures showcased work from people of all ages. We had previously thought of using a method similar to this at the BPMA's exhibitions, and see this used at another museum reaffirmed our belief that it would be a good idea.

The Victoria and Albert Museum was primarily a visual experience. The displays were very eye catching and emphasized an array of treasures. Although this museum lacked interactive displays, the visitors all seemed to enjoy wandering to look at the variety of historic displays. This museum also had two pay-upon-entry exhibitions. One showcased wedding dresses throughout the ages, and the second pertained to the history of Italian fashion. These exhibitions were very popular, and because one had to pay to see them, the visitors who attended were very engaged and excited by the exhibition.

The Science Museum was quite a bit different from the aforementioned two museums. It had beautiful models and displays, including the history of watches, the structure of rockets, and old-fashioned technology. It had age variant interactive displays. This meant that one area was primarily for young children where they could crawl on the floor or put together puzzles, and

another area was intended for adults, where they could interact with computer games. The museum was interesting and exciting but not as popular or captivating as the other two museums.

The Postal Maps Event, a BPMA pay upon entry presentation, was our first opportunity to take note of visitors' reactions to present information, and to our evaluation methods. At this event, which focused on the evolution of London postal codes, fifteen people attended and enjoyed both the provided refreshments, and the displayed maps of London postal districts.

The Last Post exhibition, featured in Mansfield, was our first opportunity to evaluate visitors in an exhibition setting. The exhibition consisted of eight panels that were located in the entrance to a children's museum. We drew a map of the layout of the exhibition, which can be viewed in Figure 9.

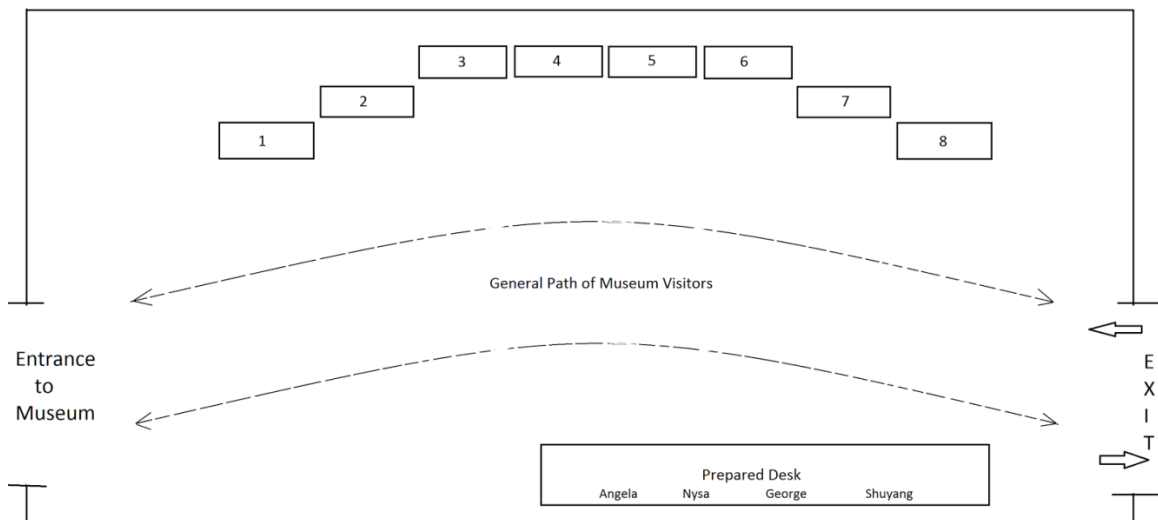

Figure 9. Layout of Last Post exhibition in Mansfield

We also took photographs of the display, which can be viewed in Figures 10.



*Figure 10. Pictures of Last Post exhibition in Mansfield*

Here we found that visitors did not want to take electronic surveys nor did they enjoy being quizzed on the material. These findings allowed us to improve our methods at the Last Post Exhibition at Coalbrookdale. We primarily used observations and surveys to gather data. The past findings also allowed us to take into consideration the layout of an event and see how the visitors reacted to it. If they enjoyed it, the visitors tended to want to participate in our evaluation methods.

The Last Post Exhibition located at Coalbrookdale was in a large room and had many visual displays and beautiful posters filling all the space. Everyone who came into the room knew it was an exhibition (unlike the Mansfield set up), and progressed to read the majority of the information. We drew a map of the layout of the exhibition, which can be viewed in Figure 11. Pictures of the exhibition can be viewed in Figures 12 and 13.

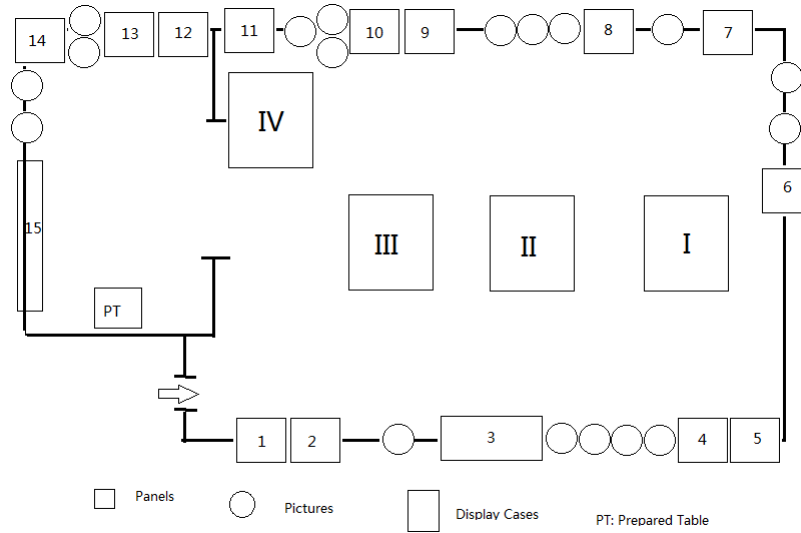

Figure 12. Map of the Last Post exhibition in Telford Central



Figure 13. Panoramic picture of a corner of the layout



Figure 11. A corner of the layout in Telford Central



### **Objective 3: Designing and testing tools that measure the visitor experience.**

At the Postal Maps event we were only able to use surveys and interviews for evaluation due to its set up. Our evaluation methods consisted of an optional survey and visitor interviews. Please keep in mind that our sample size was very small so all presented results may not reflect the feeling of all people who visit exhibition or take part in events. Of the fifteen who attended, ten filled out our evaluation sheet titled “Helpful Feedback Form”. This evaluation sheet can be viewed in Appendix B.

The survey consisted of both multiple choice and open-ended questions. We present here the results of the multiple-choice questions. The first question asked the evaluator to rate the event. Overall, they were given the options: Very poor, Poor, Average, Good, and Very good (see Figure 14, below). We found that six people rated the event as very good, three as good and one said it was average. We found that 10/10 of the visitors who took the survey would recommend the event to others. The event was the first BPMA event for six of the guests, while four had attended BPMA events in the past. Our results informed us that people heard about the event from a variety of sources including: four from word of mouth, two from the BPMA website, one from the newsletter, one from the BPMA event guide, one from another event, and one from the BPMA’s Twitter account.

We used open-ended questions to determine the demographic data for the visitor group. Five visitors wrote that they were White British, one wrote that they were Greek, one wrote that they were mixed, and three visitors did not write anything. The open-ended questions also asked the visitors what they enjoyed most about the exhibition, what they learned from the event, and any improvements they could suggest. Although we received a lot of unique answers, we found that the majority enjoyed the event because it taught them about history. The majority suggested that more information be provided.

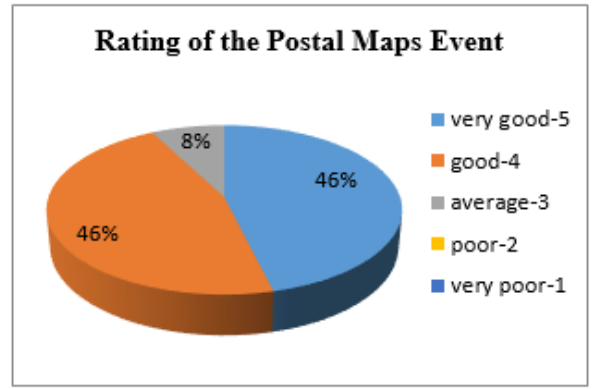
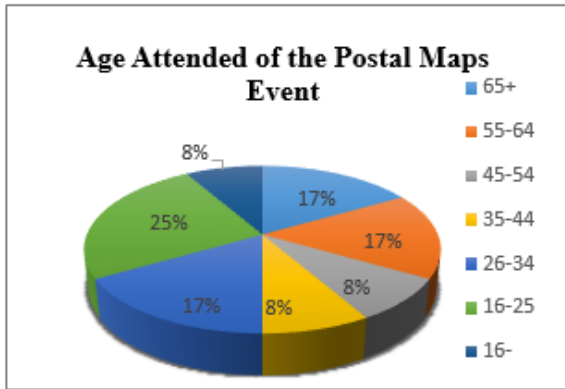
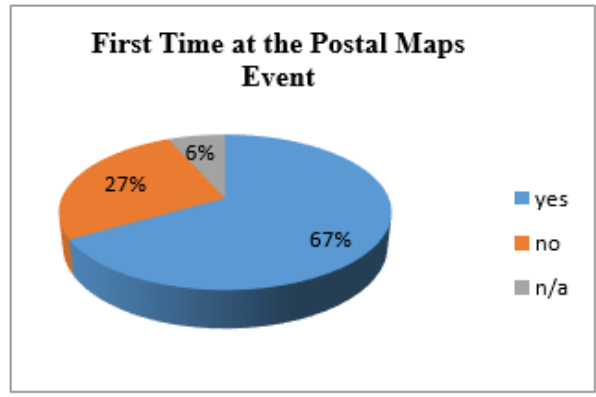
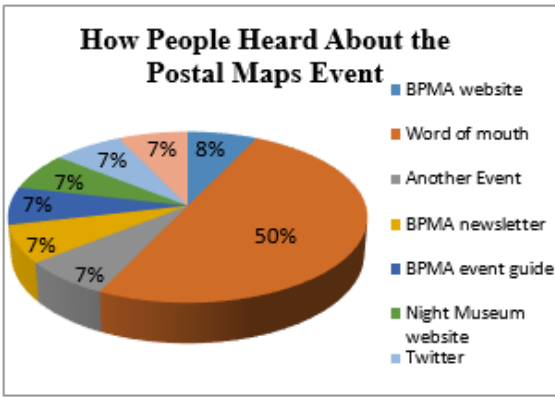

Figure 14. Survey results from the Postal Maps event

At the Last Post Exhibition in Mansfield we were able to test a few different evaluation methods. These included surveying visitors, interviewing staff and visitors, encouraging visitors to participate in our quiz and creative writing/drawing exercise, and the use of social media. Table 3 depicts all our methods how and why we tested them. Of the ten people we tried to quiz none wanted to participate in our quiz. This information showed that visitors did not like to be tested.

<b>Prototype</b>	<b>Quiz</b>	<b>Creative Writing/Drawing</b>	<b>Staff Interviews</b>	<b>Surveys</b>	<b>Observations</b>
<b>What it did</b>	Our oral quiz was composed of simple questions, which showed us visitor comprehension of exhibition displays.	This activity suggested visitors draw or write something pertaining to the exhibition	Helping us to get inside of current BPMA situations.	Evaluating visitors through multiple choices and open-ended questions.	Helping us to observe visitor behaviors so that we can process evaluating of the exhibition.
<b>Why</b>	To understand if visitors are interested in the exhibition or not.	We wanted to see people's interest in participating in the exhibition, and it gave us insight into what stood out to them because the author could travel back in time or draw an artifact displayed that they enjoyed.	Staff who worked on the exhibitions and visitor evaluations had lots of information of BPMA baseline strategies.	Surveys were the most efficient way to evaluate visitors' experience. It allowed visitors to share their opinions more easily. For the sponsors, they can ask the site specific questions on it to satisfy their desire information from visitors.	Observations were easy to track visitors and understand their behavior. Since some people do not like to take a survey or interview, it was better for evaluators to make observations and still can obtain information.

<p><b>How you tested it</b></p>	<p>We asked one question per visitor, with the promise of a candy prize to encourage participation regardless of a correct answer.</p>	<p>At the end of each exhibition we had a table with paper and pens where visitors could write a short creative piece or illustrate a drawing</p>	<p>We used semi-standardized interview to follow the flow of the conversation.</p>	<p>We passed by evaluation forms at the end of the exhibitions. Also, we put some surveys on the desk to let visitors feel free to fill them out.</p>	<p>We made one observation sheet and did observations and tracked visitor as they moved around the exhibition.</p>
---------------------------------	--	---	--	---	--

Table 3. Prototype options for visitor and exhibition evaluation

The social media director of the BPMA gave us access to the Twitter feed for the day; we were able to tweet three times throughout the experience. The tweets posted can be viewed in Figure 15 below. The tweets that were posted received six re-tweets and four people favored them. In looking at our evaluation methods, of the twenty six people who looked at our exhibition, ten took our survey, two children took part in the creative drawing activity, no one participated in our quiz or interview questions, and we interviewed four staff members.



Figure 15. BPMA Twitter feed

The ten people who filled out our survey gave us the following information. Five people said the exhibition was very good, two said it was good, and three said it was average. Out of the ten people who provided feedback, seven said they would recommend the exhibition to a friend, two people chose not to answer, and one person said they would not recommend the exhibition. Six of the ten people responded that they were visiting a BPMA event for the first time, while one person had attended a BPMA event in the past. Three people chose not to answer, meaning that they either did not like the question and maybe it should not be on the survey. Seven people found out about the exhibition because they walked upon it, one person heard about it from word of mouth, one person saw it on the Mansfield Museums website, and one person elected not to answer. All visitors who filled out the survey were adults. Two people had come to the museum with the intent to see the BPMA's exhibition, but eight people had seen it by walking by the exhibition while they were visiting the Mansfield Museum. Five people said they preferred to take the paper survey instead of a hypothetical electronic survey, and five people chose not to answer the question. The primary ethnicity of the people was White British, but five respondents chose not to provide their ethnicity. Figure 16 provides a graphical depiction of these data. Figure 17 reflects the small sample of results we gained from attending the exhibition at Coalbrookdale.

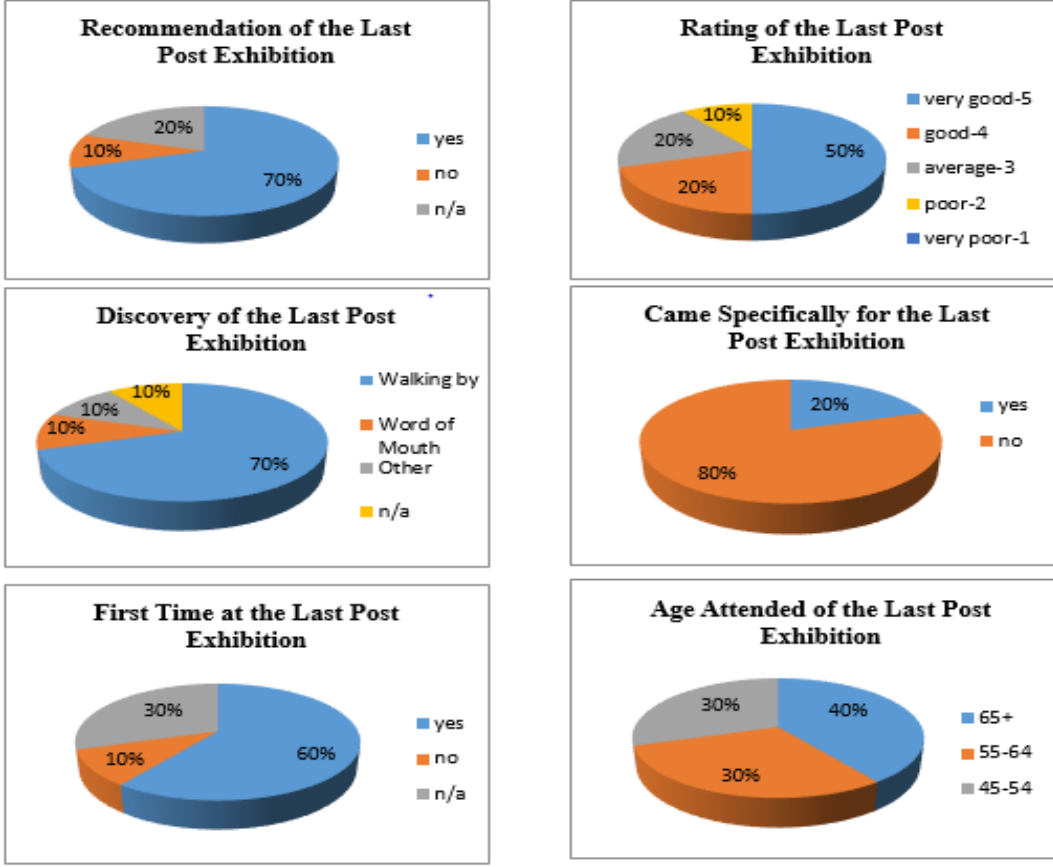

Figure 16 . Results from the Last Post exhibition in Mansfield

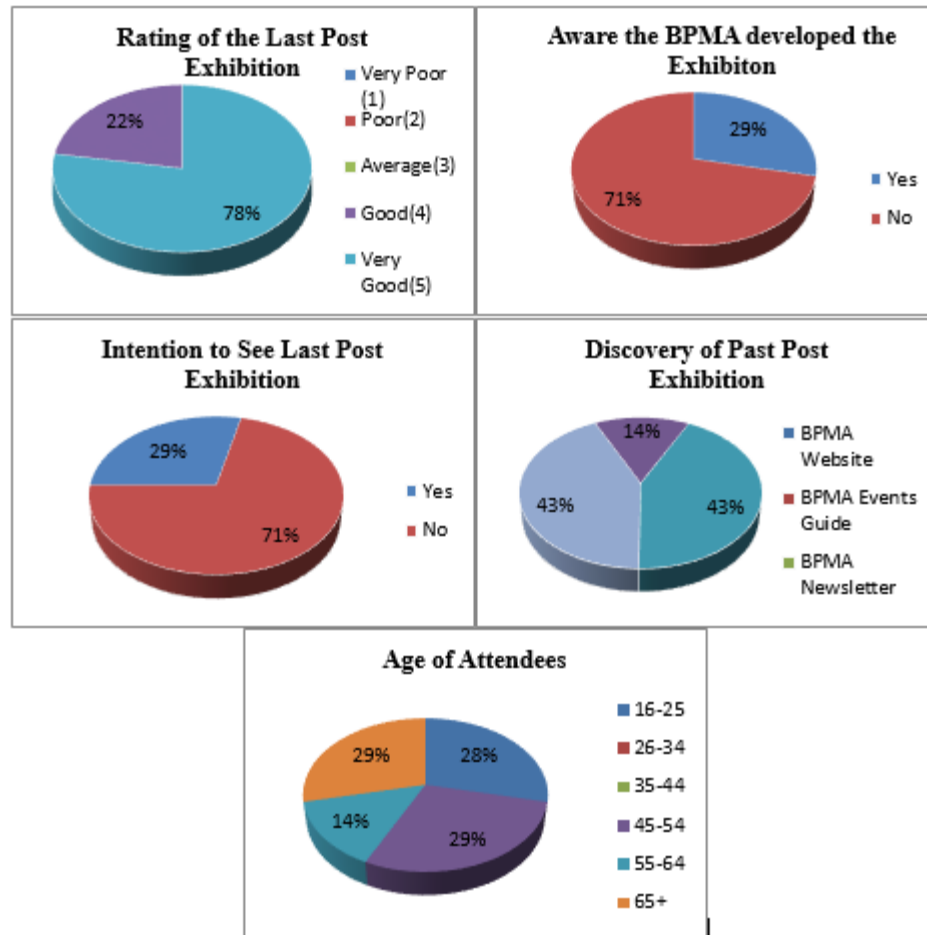

Figure 17. Results from the Last Post exhibition in Telford Central

In the open-ended questions we found several interesting answers. Respondents said that they enjoyed the event because it allowed them to learn about the war. They also appreciated that the information was clear and concise. Several visitors said they learned about the Pigeon Post and postal operations during World War I from the material the BPMA provided from their panels. In suggesting improvements, respondents commonly said that they wanted more interactive displays and information.

Of the sample we were able to gather, the majority found the exhibition to be “Very good,” on a scale of “Very poor to Very good.” Those who we observed looked primarily at the fourth and fifth panels within the exhibition, which meant they may have been the most interesting, or visually appealing. Some would recommend it to a friend, but very few people had come there in order to see the BPMA’s exhibition specifically. All this information was key in

determining the best evaluation methods to use by looking at how much data and relevant information we were able to obtain through each method.

#### **Objective 4: Determining an effective tool for data entry and analysis.**

At the Museum and Heritage show we were introduced to a wide variety of products and methods that could be a great asset to the growth of any museum. We compiled an assortment of information on applications, interactive displays, software and other potentially useful technology for the BPMA. We created a spreadsheet, which depicts each device, company name, product purpose, cost, and duration of effective use. The table in Appendix I details a list of potential Products the British Postal Museum and Archive could utilize in their future exhibitions. The products are grouped by their type pertaining to computer science, guided tours, and visitor aid. Depending on what exactly the BPMA would like to use, the price for each product may vary. In general, most products have variable options for applications that will change the price. In attending this event it was clear to us that museums are moving towards a technical era, due to the majority of vendors presenting advanced software tools and digital interactive displays. As a team we suggest the museum invest in iPad with Survey Monkey on it, and a FAB (Family Activity Based) display which gets family and friends involved with group oriented activities as they travel around the exhibition. Both can be formatted to meet the museums specific needs, and are more interactive ways of evaluating visitors' engagement.

## **4.2 Discussion**

### **Visitor Engagement**

Visitor engagement is the varying level of involvement one has with an exhibition. Visitors who pass by a display without looking at it will be less likely to take part in exhibition evaluation methods. By creating visually enticing displays and interactive activities, people are more likely to engage with the exhibition and later on give their feedback. We attended other museums to see what visitors generally found interesting, what innovative interactive activities museums had, and what hindered visitors' experience. This information enabled us to evaluate the engagement of visitors at BPMA events and exhibitions.



Upon visiting these museums, we took note of which had the most interactive displays and creative ways to engage visitors. We found that the Natural History Museum was captivating and exciting; it encouraged persons of all ages to explore and learn new things. It utilized our method of the creative writing/drawing center on a larger scale. This encouraged us to keep moving forward with our original idea of evaluating visitors by encouraging them to use their imagination and submit a creative piece to illustrate their experience. In addition, we noted how some exhibitions received more attention. Displays that featured many birds had little standing space, which diminished the number of active viewers at any given time. During the time the photo in Figure 18 was taken, the room was filled with people admiring the other displays of bird species in the hall. The auditory exhibitions in the museum were also as active.

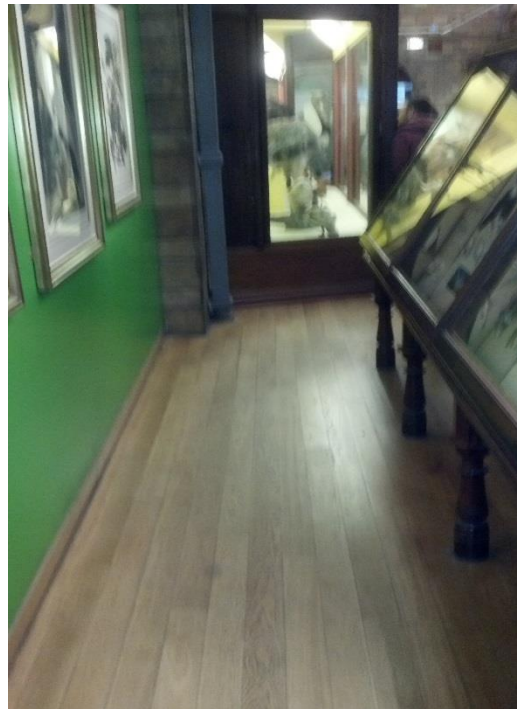

*Figure 18. Display with no attention in the Birds exhibition*

The Victoria and Albert Museum helped us understand that interactive displays were not the only thing that can captivate a visitor. It is also about the placement of information and the visuals provided on site. If it appears exciting and holds not only beauty but also hints of history, people seem more likely to spend a minute to read and evaluate a display. Some displays labels with fine print, which can be illegible to some with poor eyesight, can be a hindrance for a

museum. To help, the Victoria and Albert Museum has supplied a binder titled “Large Print Labels” at the beginning of most exhibitions. So, it was noted that text should be quite legible with a large font in either a separate binder or on the labels themselves. In accordance with what we found in our literature review, when visitors have to pay to see an exhibition, they are very interested in it and will actively engage with the displays. Pay for exhibitions are great places to evaluate visitors, but have the drawback of only attracting a small amount of people. We recommend using both pay upon entry and free exhibitions to gain a larger sample size of visitors and then gain more diverse responses to evaluations.

The Science Museum had both interactive and visually captivating displays, yet it was not as popular as the previous two museums. This taught us about presentation and the significance of how information is displayed. It also taught us that targeting specific ages can be helpful, but it does not necessarily get everyone involved.

At the Postal Maps event, the BPMA was trying a new setup in an effort to promote casual discussion and create a relaxed environment. They also offered refreshments for the first time. In asking ‘yes or no’ questions about the layout, we found that visitors appreciated the refreshments and liked the orientation of the room. One visitor I have lived in for 40 years,” (Postal Maps survey, respondent 8). This feedback was meaningful and helped us realize that the event was informative and appreciated.

Visitors expressed that they liked the surveys and enjoyed talking to us. In looking at how people found out about the event, it was exciting to see that Twitter was used in addition to the BPMA’s newsletters and website. Finding this information was important to suggest that the BPMA utilize social media to their advantage.

The comments from the surveys suggested that people enjoyed learning about their nation, and found the information presented exciting and engaging. The majority of visitors said that they would have wanted more in-depth discussion and information to be provided during the event.

We observed that the Last Post Exhibition in Mansfield was unappealing to children because not many of them cared to read the information that was displayed too high. The Last Post Exhibition at Coalbrookdale had a very well structured layout and proved a sizable amount of intriguing displays of information, which was greatly enjoyed by the visitors. Due to their

positive experience in the exhibition, almost everyone who attended was willing to fill out a survey for our research, which gave us valuable data.

### **Visitor Preference**

The data showed us that our exhibitions and events are primarily appealing to adults. This information changed our perspective on using electronic surveys. The adults we evaluated preferred paper to electronic surveys. This information also told us that younger children, and teens were not viewing the displays.

### **Visitor Feedback**

The visitors we interviewed and surveyed allowed us to conclude a few things about what visitors generally thought about the exhibitions and events. This information is very important to make sure that the questions we are asking are yielding useful results. In looking at the survey and interview results from the Postal Maps Event, we inferred the following: Six of the ten rated the event as “Very good.” By allowing people to write their ethnicity in as an open-ended question, we found that they were more comfortable in providing an answer.

Analyzing the data that we collected at the Last Post Exhibition in Mansfield, we found that the sample was too small to reach any statistically significant conclusion. Overall, the exhibition was helpful in teaching people about the past postal services. The good ratings indicate that the event was useful for those who attended. Due to the writing on the panels being too tall and complex, children who came to the museum were not interested in the material.

Data suggests that the paper survey seemed to be more appealing than the electronic survey since everyone who answered the questions “Would you prefer an electronic survey?” answered no. Due to resource constraints we were unable to present both options on site but we recommend that in the future both options are presented.

We found that the information the BPMA provided was appealing and interesting to its viewers. Observations gave us the best information and the quizzes deemed unpopular because people did not like being tested on at they read for enjoyment. All of this information helped us better prepare for our evaluation at the Coalbrookdale Last Post Exhibition. The Coalbrookdale Exhibition was beautifully oriented and was much more appreciated by the visitors than the exhibition at Mansfield.

## **Chapter 5: Recommendations and Conclusion**

As the effort for improving visitor engagement at the British Postal Museum and Archive (BPMA) continues, we have focused on investigating methods to evaluate this engagement. Founded upon the results of this project, we formulated various recommendations that can help the BPMA use the evaluation methods that we have created, and continue gaining and analyzing data more effectively. Furthermore, based on feedback from museum visitors and staff, we have developed suggestions that could improve visitor engagement at the BPMA.

### **5.1 Recommendations**

#### **Evaluation Methods**

The recommendations made in this section are based on interviews, data collection from surveys, interactive activities, and observations completed during this project. In future surveys and interviews, we recommend asking straightforward questions. The survey should have a balance of open-ended and multiple-choice. Open-ended questions should be asked when an opinion is desired; this leaves room for the respondents to elaborate and express themselves and not be restricted by a list of predetermined answers. Multiple-choice questions should be asked when specific data is needed to be interpreted quickly. For instance, if one wants to know the visitor liked the setup, a “yes or no” question gives a sufficient answer. If one wants to know why a visitor liked a setup, an open-ended question will better fit that need. Open-ended and multiple-choice questions are equally valued when conducting an interview or survey.

We recommend that when interviews take place, they should be semi-standardized. We found that by having a conversation rather than asking formal questions, respondents were more comfortable and likely to express themselves thoroughly and honestly. This also applies to quizzes. Originally, we created questions based on the material but opted to have discussions for three main reasons:

- a) Visitors were not interested in being quizzed.
- b) Discussions about the material enabled visitors to share more about their experience.
- c) Discussions engaged the visitors intellectually.

We had found that the current attracted demographic is primarily 45+, therefore we suggest continuing the use of Twitter and the interactive writing/drawing activity because it reaches out to other demographics. Posting on Twitter was a great way to reach out to the public in this technical era seeing that we did get positive responses.

We recommend that the BPMA continue using paper surveys. However, as the program grows and people of all ages become involved, it would be beneficial to have both paper and electronic surveys available. If an increasing number of people take the electronic survey, data collection becomes more efficient. By trying different visitor engagement evaluation methods we found what did and did not work. We suggest that the BPMA continues to use these methods and adapt as they discover what best suits them and their visitors in the future.

### Software Options

There are many different software options that we thought could be useful and exciting for the visitors to use. We encourage the use of an iPad paired with Survey Monkey to see how much attention it receives in comparison with the paper survey. Please see Figure 19 to see a picture of survey monkey on an iPad and Figure 20, the FAB display case. (See Appendix I for pricing and availability).

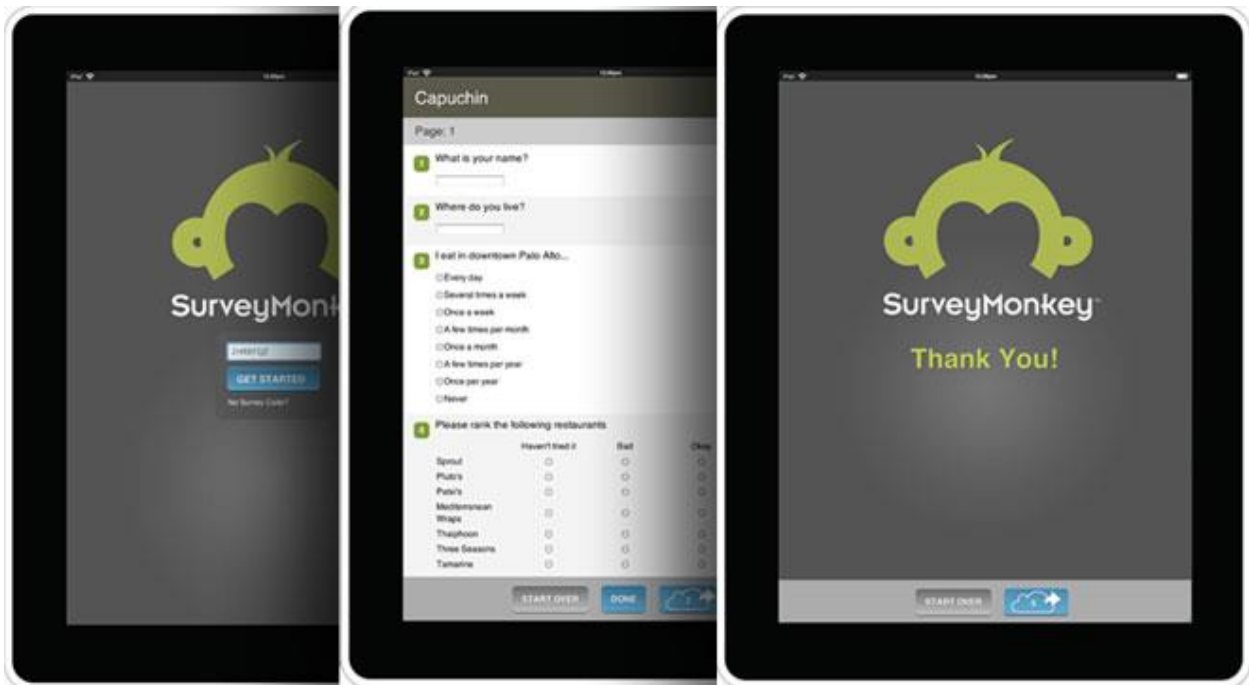

Figure 19. iPad with Survey Monkey(Survey Monkey, 2014)



*Figure 20. Family Activity Base (National Portrait Gallery, 2014)*

Unfortunately, there are very few devices that can simply transfer data from the paper survey to a database. Since the survey is composed of free-response and multiple-choice questions, the task is difficult. Using a device for this purpose is not recommended because:

- a) Free response questions cannot be evaluated.
- b) Specific paper and formatting is needed for the machine to read a survey.
- c) Answers can be unreadable to machines if visitors do not comply with the directions.
- c) Machines are costly.
- d) Machines will soon be outdated with rapidly changing technology.

However, based on these findings, we have developed a solution to remedy this obstacle by providing other software options.

If the BPMA were to use apps on mobile phones or digital surveys, data could be input immediately. We ultimately recommend that the BPMA choose the device or software that best suits their demographic. At the moment paper surveys are the preferred medium by the majority

of visitors we surveyed. For analyzing paper surveys, we encourage staff to continue inputting data into Microsoft Excel to analyze using pie charts and graphs.

The display that we think can engage the most people was the FAB (Family Activity Based). It is a family activity set up where children and parents can take games, audios, or visuals with them as they explore and exhibition. ExploreApp is another really exciting app we recommend to the BPMA. It is a mobile app which visitors pay to use to gain information on the exhibition, play interactive games, and links them to social media sites relevant to the information.

### **Additional Recommendations**

The exhibition in Mansfield, primarily a children's museum, seemed too tall and complex for children to read. It was located in an entrance, which resulted in many visitors walking past. We recommend that the BPMA takes into account the room/space and demographic of visitors when setting up an exhibition. Larger text, additional pictures, or a spread out display may have attracted more attention. A multipurpose room is not ideal; it confuses the visitors. But if a multipurpose room is the only space available, the display should be presented in such a way that cannot be ignored or overlooked.

The small samples we collected helped us analyze the basic data and conclude primary results. However, if we want to have a deeper level of evaluation, sufficient samples will be an essential factor. To help the BPMA attract more respondents in the future, we encourage staff to use larger displays, and visuals to attract visitors' attention. Furthermore, if surveys are colorful, have pictures on them, or have something to do with the presented material such as they look like postcards, visitors may be more eager to answer presented questions. These suggestions may encourage and produce more visitor feedback for staff to evaluate.

## **5.2 Conclusions**

The research we performed, and the different evaluations we conducted gave us some useful information though our sample size was small. Our studies enabled us to see what visitor engagement evaluation methods were or were not working. In the first stage of this project we

thought that implementing technological ways to collect data would be the most popular, but what we learned was that site-specific needs were based on the desires of our visitors.

When determining how to formulate an efficient survey, we went through several trial and error attempts. The information gathered from these step-by-step exercises allowed us to produce a survey, which can be used as a guideline to evaluate visitor engagement. The questions we asked provided us with the most useful information and we believe its format will be helpful for others in the future.

Moreover, we observed how the layout of an event or exhibition was important in captivating visitors' attention. The demographic of a specific location was vital; the activities offered and evaluation methods implemented should appeal to the present visitor population. Further research can build upon the information we have gathered. They can create age specific games at sites to see which engages the most visitors. Other groups can try both paper and electronic surveys if the materials are available. This will allow them to determine which survey method is most popular in practice.

After analyzing the strengths and weaknesses of the current surveys, we established recommendations for the most feasible approaches for the BPMA. Unfortunately, we were unable to evaluate a substantial amount of visitors to make concrete conclusions, but the research we gathered and the evaluations we conducted can still be used and seen as informative. In the first stage of this project we thought implementing technological ways to collect and analyze data would be the most efficient, yet we learned that site-specific needs were based on the desires of our visitors who favored paper surveys. In determining the best practice for evaluating visitors, we also suggest the BPMA focus on what the visitors enjoy. We concluded that observations are the most informative way of evaluating. We found that by reading body language and viewing the visitors as engaged, we could determine what they enjoyed and preferred compared to the vague comments left on a survey. We also found that speaking to staff members who work every day at exhibitions can share insightful information that can be used to improve exhibitions further.

The information that we gathered not only benefits the BPMA, but also has the potential to in turn assist other museums that face similar challenges with visitor feedback. The data can help organizations develop a baseline of information, which they can build upon, and determine the best practices for evaluating visitor engagement



## Bibliography

Antenna International (n.d.). *Antenna International*. Retrieved May 20, 2014, from <http://www.antennainternational.com/>

Apple Inc. (n.d.). The Official Apple Store (United Kingdom) Retrieved May 21, 2014, from <http://store.apple.com/uk>

ATS Heritage (n.d.). ATS Heritage. Retrieved May 21, 2014, from <http://www.ats-heritage.co.uk/>

Barlow, P. (2010). Effective Survey Design and Analysis [PDF document]. Retrieved April 5, 2014, from University of Wisconsin LA Cross website: <http://www.uwlax.edu/catl/Presentations/T4TW/Effective%20Survey%20Design%20and%20Analysis+Worksheet%20-%20June%202010.pdf>

Beseda, M., Bailey, E., Braden, A., Bond, M., Lenahan, C., & Petrie, K. (2013). Exploring Spaces: Evaluating Visitor Experiences at the Henry Art Gallery: Evaluations: Informal Science. Retrieved from Informal Science website: <http://informalscience.org/evaluation/ic-000-000-008-319>

Berg, B. L., & Lune, H. (2012). *Qualitative research methods for the social sciences* (8th ed.). Boston: Pearson.

Bubp, K. (2010, May 19). Museum Audience Insight: Interpretation Preferences: How 40,000 museum-goers prefer to experience museums [Web log post]. Retrieved from [http://reachadvisors.typepad.com/museum\\_audience\\_insight/2010/05/interpretation-preferences-how-40000-museumgoers-prefer-to-experience-museums.html](http://reachadvisors.typepad.com/museum_audience_insight/2010/05/interpretation-preferences-how-40000-museumgoers-prefer-to-experience-museums.html)

Clinckemaillie, F., Lybarger, A., & Peterson, D. (2010, June 25). Evaluating Visitor Experience in the Department of Coins and Medals at the British Museum. Retrieved March 30, 2014, from [http://www.wpi.edu/Pubs/E-project/Available/E-project-062510-031135/unrestricted/IQP\\_FINAL\\_PAPER\\_British\\_Museum.pdf](http://www.wpi.edu/Pubs/E-project/Available/E-project-062510-031135/unrestricted/IQP_FINAL_PAPER_British_Museum.pdf)

Dash Information Systems Ltd (n.d.). *Touch Screen Kiosks, Memorial Software, Dash Information Systems*. Retrieved May 21, 2014, from <http://www.dashinfosystems.co.uk/>

Data Preparation, Interpretation and Analysis. (n.d.). Retrieved April 6, 2014, from <http://www.esurveyspro.com/article-data-preparation-interpretation-and-analysis.aspx>

Delius digital (n.d.). *delius digital*. Retrieved May 20, 2014, from <http://www.delius-digital.de/en/home.html>

Designing a more engaging visitor experience - PARC, a Xerox company. (n.d.). Retrieved April 11, 2014, from <https://www.parc.com/services/case-studies/2484/designing-a-more-engaging-visitor-experience.html>

Digitick Group (n.d.). *Digitick Group | The next generation ticketing system*. Retrieved May 21, 2014, from <http://www.digitick.net/?lang=en>

DiscoveryPEN (n.d.). *Home | DiscoveryPEN*. Retrieved May 21, 2014, from <http://www.discoverypen.co.uk/>

Espro Acoustiguide Group (n.d.). *Audio Tour - Audio Guide - Acoustiguide*. Retrieved May 21, 2014, from <http://www.acoustiguide.com/>

Explore App (n.d.). *Explore App | Mobile Apps for Tourist Attractions*  
*Explore App | Mobile Apps for Tourist Attractions*. Retrieved May 21, 2014, from <http://exploreapp.co.uk/>

Extensis (n.d.). *Digital Asset Management Systems for Collections Management | Digital Asset Management | Extensis*. Retrieved May 21, 2014, from <http://www.extensis.com/digital-asset-management/digital-asset-management-systems-for-collections-management/>

Falk, J. H. (2009). Identity and the museum visitor experience. Retrieved from [http://books.google.com/books?id=Ar7NNZ5hgdsC&pg=PA215&lpq=PA215&dq=constitutes+engaging+visitor+experience&source=bl&ots=SHKO0g8FKj&sig=52mF\\_b2c2DDxMPRG0IMvpCr3yME&hl=en&sa=X&ei=fTJIU8\\_GM8q\\_0gGE34DwAg&ved=0CFYQ6AEwBg#v=onepage&q=constitutes%20engaging%20visitor%20experience&f=false](http://books.google.com/books?id=Ar7NNZ5hgdsC&pg=PA215&lpq=PA215&dq=constitutes+engaging+visitor+experience&source=bl&ots=SHKO0g8FKj&sig=52mF_b2c2DDxMPRG0IMvpCr3yME&hl=en&sa=X&ei=fTJIU8_GM8q_0gGE34DwAg&ved=0CFYQ6AEwBg#v=onepage&q=constitutes%20engaging%20visitor%20experience&f=false)

Gemmell, W. (2008, April 17). Why Do People Take Surveys? Retrieved April 13, 2014, from <http://ezinearticles.com/?Why-Do-Visitors-Take-Surveys?&id=2548507>

In Hand Guides Ltd (n.d.). *Smart Audio Devices*. Retrieved May 21, 2014, from [www.inhandguides.com/](http://www.inhandguides.com/)

Maxwell, J. A. (2013). *Qualitative research design: an interactive approach* (3rd ed.). Thousand Oaks, Calif.: SAGE Publications.

Morgan, K. (2013, November 14). Are People Completing Surveys on Mobile Devices? | SurveyMonkey Blog. Retrieved April 12, 2014, from <https://www.surveymonkey.com/blog/en/blog/2013/11/14/surveys-mobile-devices/>

Morgan, K. (2013, June 24). When Are People Most Likely Taking Your Survey? | SurveyMonkey Blog. Retrieved April 12, 2014, from <https://www.surveymonkey.com/blog/en/blog/2013/06/24/response-rates-over-time/>

Museum Identity Ltd - high-quality conferences, study days, publications, for professionals. (n.d.). Retrieved April 9, 2014, from <http://www.museum-id.com/idea-detail.asp?id=395>

National Portrait Gallery (2014). *National Portrait Gallery - Family Activity Base*. Retrieved June 17, 2014, from <http://www.npg.org.uk/learning/families/family-activity-base.php>

Paragon (n.d.). *Paragon Creative*. Retrieved May 22, 2014, from <http://www.paragon-creative.co.uk/>

Prodir S.A. (n.d.). *United Kingdom - Prodir*. Retrieved May 21, 2014, from <http://www.prodir.com/en-us/corporate/contacts/united-kingdom>

Raye, J. (2009, October 10). *The Visitor Viewpoint*. Retrieved April 2, 2014, from <https://www.wisconsinhistory.org/localhistory/pdfs/2009-FallPresentations/Visitor-Viewpoint.pdf>

Seattle Art Museum (2002, February). *Audience Research: Surveys*. Retrieved April 5, 2014, from <https://www.seattleartmuseum.org/community/pdf/MemberVisitorSurvey2001.pdf>

Silvers, D. M., Rogers, M., & Wilson, M. (2013, April 20). *Design Thinking for Visitor Engagement: Tackling One Museum's Big Challenge through Human-centered Design | MW2013: Museums and the Web 2013*. Retrieved April 6, 2014, from <http://mw2013.museumsandtheweb.com/paper/design-thinking/>

Smith, S. (2012, April 19). *Why do Visitors Participate as Respondents in a Survey? | Qualtrics*. Retrieved April 11, 2014, from <http://www.qualtrics.com/blog/why-do-visitors-participate-as-respondents-in-a-survey/>

Survey Monkey (n.d.). *SurveyMonkey Plans and Pricing*. Retrieved May 21, 2014, from [https://www.surveymonkey.com/pricing/?ut\\_source=direct\\_to\\_pro](https://www.surveymonkey.com/pricing/?ut_source=direct_to_pro)

Survey Monkey Blog (2011, September 21). *The SurveyMonkey Hackathon!* | *SurveyMonkey Blog*. Retrieved June 18, 2014, from <https://www.surveymonkey.com/blog/en/blog/2011/09/21/the-surveymonkey-hackathon/>

TableDabble Inc. (n.d.). *Mobile & Offline Survey App*. Retrieved May 21, 2014, from [http://www.quicktapsurvey.com/?gclid=CjgKEAjwnfGbBRDlxoHrl6uikyESJAD-nzCFirgp\\_JTpmuIoABbXREjU\\_xE7QFCnqFRerQcaXYXUjvD\\_BwE](http://www.quicktapsurvey.com/?gclid=CjgKEAjwnfGbBRDlxoHrl6uikyESJAD-nzCFirgp_JTpmuIoABbXREjU_xE7QFCnqFRerQcaXYXUjvD_BwE)

Usborne Publishing (n.d.). *Children's Books from Usborne Publishing*. Retrieved May 21, 2014, from <http://www.usborne.com/>

Vernon Systems Ltd (n.d.). *Vernon Systems - Collections Management Software for Museums, Galleries and other Cultural Heritage Sites*. Retrieved May 21, 2014, from <http://www.vernonsystems.com/>

Villaespesa, E. (2013, April 20). Diving into the Museum's Social Media Stream. Analysis of the Visitor Experience in 140 Characters. | MW2013: Museums and the Web 2013. Retrieved April 6, 2014, from <http://mw2013.museumsandtheweb.com/paper/diving-into-the-museums-social-media-stream/>

Webnebulus Ltd (n.d.). *Info-Point*. Retrieved May 21, 2014, from <http://www.info-point.eu/>

Writing Good Survey Questions. (n.d.). Retrieved from UCSD Student Research and Information website: [http://blink.ucsd.edu/\\_files/sponsor-tab/vcsa/Writing-Good-Survey-Questions-2013-02-21-Handouts.pdf](http://blink.ucsd.edu/_files/sponsor-tab/vcsa/Writing-Good-Survey-Questions-2013-02-21-Handouts.pdf)

# Appendices

## Appendix A: 2013 BPMA Last Post Exhibit Evaluation Form

### Last Post: Remembering the First World War, by the British Postal Museum & Archive (BPMA), at Coalbrookdale Gallery

We like to ensure that our exhibitions are enjoyable and interesting. By filling out this questionnaire you will help us achieve this. If you have further comments, please note them on the back of this form.

Please rate Last Post on a scale of 1 (very poor) to 5 (very good)				
1 (Poor)	2	3	4	5 (Excellent)

What did you enjoy most about it?	Can you suggest any improvements?

Have you learnt anything new today?	yes	no
Please tell us more		

What made you decide to come today?

Is this your first time viewing a BPMA exhibition?	yes	no	
Do you work for Royal Mail?	Yes	No	Previously

How did you hear about this event?			
BPMA website	BPMA Events Guide	Word of mouth	Other (Please specify)
BPMA newsletter	At Ironbridge Gorge Museums	Ironbridge Gorge Museum advertising	

Please tell us which age range you are in:				
16-30	31-45	46-60	61-75	75+

Please help us comply with equal opportunities monitoring by circling your ethnicity:						
White British	White Other	Other ethnic group	Black Caribbean	Indian	Bangladeshi	Mixed
White Irish	Pakistani	Black African	Black Other	Chinese	Asian Other	Prefer not to say

If you would like to join our mailing list, please leave your name and address here. This information will be detached from the rest of the form.

Name:.....  
 Address:.....  
 .....

Email address:.....

The information you provide on this form will be used to improve our future events and in reporting on our events programme. We may use comments (but not names) for publicity purposes.

Would you like to be contacted about comments made? Y/N

## Appendix B: Newly Designed Postal Maps Event Survey

### Helpful Feedback Form

Postal Maps, 15/5/2014

We like to ensure that our events are enjoyable and interesting. By completing this simple questionnaire, you will help us improve.  
**Everything remains confidential**

Please rate today's event: (Circle)				
1 Very poor	2 Poor	3 Average	4 Good	5 Very good

What did you enjoy most about this event?	Can you suggest any improvements?

Have you learnt anything from today's event?

Would you recommend BPMA events to a friend? (Circle)	Yes	No

Is this your first time to a BPMA event? (Circle)	Yes	No

Do you work for Royal Mail? (Circle)	Yes	No	Previously

How did you hear about this event? (Circle)			
BPMA website	BPMA events guide	Word of mouth	Other (please specify)
BPMA newsletter	Another event	Search room poster	

Please circle your age range:					
16-25	26-34	35-44	45-54	55-64	65+

Please help us comply with equal opportunities monitoring by sharing your ethnic background:

Did you like the overall setup of the event?	Yes	No
Were the refreshments satisfactory?	Yes	No
Was the provided information understandable?	Yes	No

If you would like to join our mailing list, please provide your name and address here. The information will be detached from the form above.

Name: \_\_\_\_\_

Email Address: \_\_\_\_\_

Address: \_\_\_\_\_

\_\_\_\_\_

\_\_\_\_\_

The information you provide on this form will be used to improve our future events and in reporting on our events programme. We may use comments (but not names) for publicity purposes.

If you have other comments, please note them on the back.

# Appendix C: Newly Designed Survey for Last Post Exhibition in Mansfield



## Helpful Feedback Form

Last Post Exhibition: Mansfield 30/5/2014 -- 31/5/2014

We like to ensure that our exhibitions are enjoyable and interesting. By completing this simple questionnaire, you will help us improve.  
**Everything remains Confidential**

Please rate today's exhibition on a scale of 1 (very poor) to 5 (excellent)				
1 Very Poor	2 Poor	3 Average	4 Good	5 Very Good

What did you enjoy most about this exhibition?	Can you suggest any improvements?

Have you learnt anything from today's Exhibition?
Please tell us more  

Would you recommend BPMA exhibitions to a friend?(Circle)	Yes	No
---	-----	----

Is this your first time to a BPMA exhibition? (Circle)	Yes	No
--	-----	----

How did you hear about this exhibition? (Circle)			
BPMA website	BPMA Events Guide	Word of mouth	Other (Please specify)
BPMA newsletter	Walking by	Search room poster	

Please circle your age range:					
16-25	26-34	35-44	45-54	55-64	65+

Please help us comply with equal opportunities monitoring by sharing your ethnic background:

Did you come with the intention to see this specific exhibition?	Yes	No
Would you prefer an electronic survey?	Yes	No
Would you feel comfortable if we shared your comments?	Yes	No

If you would like to join our mailing list, please provide your name and address here. The information will be detached from the form above.

Name:.....

Email Address:.....

Address:.....  
 .....

The information you provide on this form will be used to improve our future events and in reporting on our exhibitions programme. We may use comments (but not names) for publicity purposes

If there is any other comments, please note them on the back.



## **Appendix D: Interview Questions for Staff at the Last Post Exhibition in Mansfield**

### **Staff Interviews:**

1. How long have worked at this exhibition?
2. Roughly can you estimate how many visitors normally visit the exhibition on the weekend and on weekdays?
3. What are the most popular days for visitors to come here?
4. How long do visitors normally spend at the exhibition?
5. Who are your primarily visitors?
6. How long to visitors normally spend in the exhibition?

## **Appendix E: Visitor Interview Questions for the Last Post Exhibition in Mansfield**

1. What were the reasons behind your visit today?
2. Did you come with the intention to see this specific exhibition?
3. What is something that stood out to you?
4. Do you prefer reading the information or glancing at the visual aids?
5. Did you learn any interesting new knowledge today?

## **Appendix F: Plans for Evaluation at the Last Post Exhibition in Mansfield**

### May 30<sup>th</sup>: First Day on Site

Upon arriving at site, our team will split up, taking different tasks in order to optimize efficiency.

- Shuyang and George will draw a map of the exhibition.
- Nysa and Angela will set up a table at the end of the exhibition where paper and pens will be provided. Instruction will be provided at the table. They will be clearly written and large enough for the visitors understand, see appendix E. The table will also include a drop box for creative writing submissions and drawings.
- Nysa will then interview staff members. The interview questions are in appendix F.
- Angela will then progress to interviewing arriving visitors, see appendix G. She will be moving around the exhibition casually, wearing a name tag, and only approaching people who appear eager to share their opinion of the site with her.
- George will be moving throughout the exhibition observing visitors. He will be noting how long people stay at certain displays, people's reactions to the exhibition, and noting on our map of the exhibition what people are primarily looking at.
- Nysa will be standing at certain displays quizzing visitors on information they just learned, seeing if they are absorbing the information presented. We will create these questions on site after we have experienced the exhibition ourselves and noted what we believe stuck and what didn't.
- Shuyang will be passing out surveys to visitors at the end of the exhibition. See appendix H for the survey we plan on using on site. She will also be taking note of the amount of people in the exhibition so we can determine how many people are taking our survey versus how many people are actually present.

### May 31<sup>st</sup>: Second day on site

This day will be conducted similarly to our first day on site except we will no longer need to draw a layout of the site nor will we be interviewing staff.

- Nysa will be moving around the exhibition interviewing visitors.
- Angela will be quizzing visitors at different displays
- George will be handing out surveys and counting the amount of people who walked through the exhibition.
- Shuyang will be observing visitor's interaction and interests in the exhibition.
- We will switch roles every hour to two hours.

**Appendix G: Instructions for Creative Writing/Drawing**

We would like you to share your thoughts!

Please submit a 1-2 sentence creative writing piece or picture that explains something you have learned.

Set yourself back in time, draw a picture of you as a postal man, or just share something you thought was awesome!

Submit for the chance to have your piece be posted on the BPMA Twitter feed or Facebook page.

First name and surname initial: \_\_\_\_\_ Age: \_\_\_\_\_

First name and surname initial: \_\_\_\_\_ Age: \_\_\_\_\_

## Appendix H: Survey Types

Survey Distribution Types	Pros	Cons
Paper Surveys	People must fill it out at the site.	People in a rush do not want to fill it out.
	Data is collected immediately on hard copy.	Paper surveys are not environmentally-friendly.
		The survey data takes additional time to store on a database.
		Paper surveys can be easily lost or destroyed.
Machines used to scan paper surveys	Data can be immediately input for analysis.	Machines cost money to acquire and maintain.
	Surveys can still be distributed using paper.	Machines can run into technical problems.
		Machines cannot evaluate written comments.
		Machines that use paper surveys are not green.
Online Survey	People can take it at the museum or later on.	People may neglect to take it later.
	Online surveys make it easy to download data onto databases.	Technology may malfunction. Computers can crash, data can be lost or not recorded.
	Survey information is accessible right away.	Museums may need to spend money on equipment, iPads, or computers for visitors to take surveys.
	The data can be readily analyzed.	The museum needs reliable internet access if using online surveys.
	Online surveys are environmentally-friendly.	Visitors must be able to use technology like computers and cell phones.
	People may spend more time taking the surveys at home.	
	Online surveys have little to no distribution costs.	
	Online surveys can be taken by a larger population.	
	Online surveys can require all or some specific questions to be answered.	

## Appendix I: Potential Products Information Spreadsheet

Appendix I contains a list of different devices the BPMA can invest in to meet their needs.

Category	Name	Company	Device Function	Cost	Duration
Interactive Displays	iTouch Multimedia Guide/App	ATS Heritage	Multimedia guide which aids with museum self-guided tours.	Contact: 023 9259 5000	3-4 years before it becomes outdated
	XP-IRIS 2	Antenna International	Comprehensive Mobile Guide	www.antennainternational.com	3-4 years before it becomes outdated
	ExploreApp	ExploreApp	Mobile app tailored to the exhibition. If the user pays more they gain access to more information. Includes directions to sites, social media connections, and interactive games.	Connect: 0161 660 6756	3-4 years before it becomes outdated
Devices to Take Surveys	iPad	Apple	Online surveys can be implemented on these devices. When visitors take the survey, data is immediately inputted onto a server.	Shop at amazon: starting rate is 202 pounds	3-4 years before it becomes outdated

	Apollo Curve	Dash Information Systems	Kiosk has electronic survey/informational panel.	2,499 pounds	3-4 years before it becomes outdated
	Guides, apps and creative services	Acoustiguide	Offer customizable apps for smartphones that can be used for self-guided tours and visitor feedback. Apps are in all different languages and can be accessed on all different types of smart phones including androids and iphones.	Questions: <a href="http://www.acoustiguide.com/contact-us">http://www.acoustiguide.com/contact-us</a>	Must be updated as technology progresses.
Software to Analyze Survey Results	eHive	Vernon Systems	The device helps catalogue, organize and share a collection of data in a simple and secure way.	sign up at <a href="http://www.ehive.com">www.ehive.com</a>	permanent (may need updates which are provided by the company)
	Quick Tap Survey	QuickTapSurvey	This software creates, collects, and analyzes survey data.	Free for the first survey. Different account types <a href="http://quicktapsurvey.com">quicktapsurvey.com</a>	permanent (may need updates which are provided by the company)



	Vernon CMS	Vernon Systems	Collection management software for museums, galleries, and heritage sites.	connect: +64 9 815 5599 or email info@vernonsystems.com	permanent (may need updates which are provided by the company)
	Extensis	Extensis	Digital asset management software.	Check out: www.extensis.com/heritage	permanent (may need updates which are provided by the company)
Other	Discovery Pen	Discovery PEN	Aiding blind and partially sighted visitors through audio	999 pounds per kit	permanent (may need updates which are provided by the company)
	Digi Tick	Digitick group	Web-based ticketing system	Check out: www.digitick.net	permanent (may need updates which are provided by the company)
	Info-Point	Webnebulus Ltd	WiFi like information provider to connected devices so we can quickly input data and take online surveys.	1,550 pounds	3-4 years before it becomes outdated
	Book	Usborne Publishing	Sells children's books encourage children to interact at exhibitions.	Contact: 01865 883731 or order online	If taken care of can last for an indefinite amount of time.

	Appealing display cases	Paragon Creative	(FAB) Family Activity Based Portal which gives visitors activities to do on their own as they see the museum.	contact: mark@paragon-creative.co.uk	3-4 years before it becomes outdated
	Large amount of customizable pens	Prodir	Swiss made pens for survey completion.	500 pen order minimum ~410 pounds	Given to guests

Survey Monkey				
	Basic	Select	Gold*	Platinum
Price	Free	24 per month	299 per year	799 per year
Number of Questions	10 questions per survey	Unlimited questions	Unlimited questions	Unlimited questions
Usability	Easy-to-use web-based survey tool	Custom survey design and URLs	Custom redirect after survey is completed	Complete brand control with research. net
Other Information	31 survey templates	51 survey templates	51 survey templates	51 survey templates
	15 types of questions	15 types of questions	15 types of questions	15 types of questions
	All languages supported	All languages supported	All languages supported	All languages supported
		Custom URL	Custom URL	Custom URL
		Multiple custom reports	Multiple custom reports	Multiple custom reports
			Text analysis	Text Analysis

\*Most Important

## **Appendix J: The List of Panels at the Last Post Exhibition in Mansfield**

Names of the Panels:

1. LAST POST: REMEMBERING THE FIRST WORLD WAR
2. A letter
3. Delivering mail to world at war
4. Front line communications
5. The Post Office joins up
6. The censor's stamp
7. The Post Office's home front
8. The postal service is forced to change