

Project Number: AHH-0105

DESIGN AND DEVELOPMENT OF A TRANSHUMERAL
PROSTHETIC MOUNTING SYSTEM

A Major Qualifying Project
Submitted to the Faculty
Of the

WORCESTER POLYTECHNIC INSTITUTE

in partial fulfillment of the requirements for the
Degrees of Bachelor of Science
in ¹Mechanical Engineering
and ²Biomedical Engineering

by

Michael Bertini¹

Zachary Dominguez¹

Joshua Morin¹

Elizabeth Palumbo²

Date: April 27, 2006

Approved:

Professor Allen H. Hoffman, Major Advisor

Keywords

1. Prosthesis
2. Mounting System
3. Biomechanical Devices

Professor Holly K. Ault, Co-Advisor

ABSTRACT

For those with amputations, prostheses are important tools which are needed to perform many activities of daily living. Ideally, a prosthesis enables the user to perform activities with the same freedom as a physically able person. For those with trans-humeral amputations, however, effective prosthesis use is often hindered by the complexity of the glenohumeral joint. Current methods of prosthesis attachment for those with trans-humeral amputations severely limit load bearing capability. The goal of this project was to design, analyze, manufacture, and test a device that increases current axial and torsional load bearing capability without limiting the range of motion in the shoulder.

The design incorporates a harness system which distributes the loads over the user's torso, an exoskeletal shoulder joint which mimics the range of motion in the shoulder, and an interface which links the prosthesis to the device. Analysis confirms that the device can withstand axial loads of up to 70 pounds and torsional loads of up to 12 foot-pounds applied at the terminal end of the prosthesis. These loads can be applied throughout a range of motion which includes 116 degrees of horizontal adduction/abduction and 75 degrees of vertical adduction/abduction. While these limits do not reach actual maximums attainable by able-bodied individuals, they do allow for the successful execution of activities of daily living.

TABLE OF CONTENTS

| | |
|---|-----------|
| ABSTRACT | i |
| TABLE OF CONTENTS | ii |
| LIST OF FIGURES | vi |
| LIST OF TABLES | ix |
| INTRODUCTION | 1 |
| I. BACKGROUND | 3 |
| <i>1.1 Anatomical Terms and Definitions</i> | 3 |
| <i>1.2 Shoulder Joint Movement</i> | 6 |
| <i>1.3 Shoulder Musculature</i> | 8 |
| <i>1.4 Activities of Daily Living</i> | 12 |
| <i>1.5 Prosthetics</i> | 15 |
| 1.5.1 Passive Prosthetic Systems..... | 16 |
| 1.5.2 Active Prosthetic Systems..... | 17 |
| 1.5.2.1 Body-Powered | 17 |
| 1.5.2.2 Myoelectric..... | 18 |
| <i>1.6 Problems with Existing Technology</i> | 21 |
| <i>1.7 Prospective Users of the Shoulder Mount Device</i> | 22 |
| 1.7.1 Upper-limb Amputations..... | 22 |
| 1.7.2 Limb Difference..... | 23 |
| <i>1.8 Analogous Technology</i> | 23 |
| 1.8.1 Harnessing Systems | 23 |
| 1.8.1.1 Upper-Extremity Prostheses Harnesses..... | 24 |
| 1.8.1.2 Shoulder Orthoses..... | 25 |
| 1.8.1.3 Backpacks..... | 26 |
| 1.8.1.4 Baby Carriers..... | 28 |
| 1.8.2 Joint Exploration..... | 29 |
| 1.8.2.1 Space & Deep Sea Suits..... | 29 |
| 1.8.2.2 Joystick Configurations..... | 30 |
| <i>1.9 Identification of Functions</i> | 30 |
| II. GOAL STATEMENT | 33 |
| III. DESIGN SPECIFICATIONS | 34 |
| 3.1 Selection Matrix | 38 |
| 3.2 Matrix Organization..... | 38 |
| IV. DESIGN SELECTION | 42 |
| 4.1 Design Concepts | 42 |
| 4.1.1 Exoskeletal Shoulder Joint | 43 |
| I - Gimbal Joint | 43 |
| II - L-Bracket Pin Joint..... | 44 |

| | |
|--|-----------|
| III - Ferromagnetic Shoulder Sheath | 44 |
| IV - Locking Bar | 45 |
| V - Locking Cam Rings | 45 |
| VI - Modified One-Track Gimbal Joint | 46 |
| 4.1.2 Harness/ Strapping System | 47 |
| 1 - Backpack-style | 47 |
| 2 – Shoulder Plate with Waist-belt | 47 |
| 3 – Double-Nine | 48 |
| 4 - Double armpit | 48 |
| 5 - Double-X Yoke | 49 |
| 6 - Vest | 50 |
| 7 - Corset | 50 |
| 8 - Double Armpit with Torso Belt | 51 |
| 9 –Harness with Torso Belt | 51 |
| 4.1.3 Prosthesis/Arm Interface | 52 |
| (A) – Concentric Cylinders | 52 |
| (B) – Rotational Bearing | 52 |
| 4.2 <i>Use of Matrix selection charts</i> | 53 |
| 4.2.1 Design Rating | 53 |
| 4.2.2 Determining Preliminary Design | 55 |
| 4.3 <i>Preliminary Design</i> | 55 |
| 4.4 <i>Alternative Design</i> | 56 |
| V. ANALYSIS AND EVOLUTION OF DESIGN | 60 |
| 5.1 <i>Free Body Diagrams</i> | 60 |
| 5.1.1 Position 1 | 60 |
| 5.1.2 Position 2 | 60 |
| 5.1.3 Position 3 | 60 |
| 5.1.4 Position 4 | 61 |
| 5.1.5 Summary of Findings | 61 |
| 5.1.6 Harness Evolution | 63 |
| 5.2 <i>ANSYS</i> | 64 |
| 5.2.1 Preliminary Analysis | 65 |
| 5.2.2 Final Design Analysis | 66 |
| 5.2.3 Critical Load | 66 |
| 5.2.4 General Model Setup | 66 |
| 5.2.5 Element Type | 66 |
| 5.2.6 Material Properties | 67 |
| 5.2.7 Meshing | 67 |
| 5.2.8 Boundary Conditions | 67 |
| 5.2.9 Load Application | 67 |
| 5.2.10 Results of FEA | 68 |
| 5.3 <i>Design for Manufacture/Assembly (DFM/DFA)</i> | 69 |
| 5.3.1 Arm Guide Screws to Arm Guide Cap | 69 |
| 5.3.2 Bearing Simplification | 70 |
| 5.4 <i>Anthropometric Data Analysis</i> | 71 |
| 5.5 <i>Sensitivity Study</i> | 73 |
| 5.6 <i>Fastener Analysis</i> | 79 |
| 5.6.1 Thread Pullout Analysis | 79 |
| 5.6.2 Shear Pullout Analysis | 81 |
| 5.7 <i>Brake Analysis</i> | 82 |

| | |
|---|------------|
| 5.8 Pressure Analysis..... | 83 |
| 5.8.1 Determining Harness Length..... | 84 |
| 5.8.2 Free Body Diagram Calculations..... | 85 |
| 5.8.3 Side Thermoplastic Analysis..... | 86 |
| 5.8.4 Major Pressure Points..... | 87 |
| 5.8.5 Pressure on Thermoplastics..... | 87 |
| 5.8.6 Side Thermoplastic Pressure..... | 88 |
| 5.8.7 Addition of Foam Padding..... | 91 |
| VI. FINAL DESIGN..... | 93 |
| 6.1 Arm Guide Assembly..... | 93 |
| 6.2 Track Assembly..... | 95 |
| 6.3 Harness Assembly..... | 97 |
| 6.3.1 Horizontal System (1)..... | 98 |
| 6.3.2 Diagonal System (2)..... | 99 |
| 6.3.3 Alpha System (3)..... | 99 |
| 6.4 Total Assembly..... | 99 |
| VII. MANUFACTURING..... | 101 |
| 7.1 Budget..... | 101 |
| 7.2 Machining..... | 102 |
| 7.3 Harness..... | 102 |
| 7.3.1 Manufacturing of Thermoplastics..... | 103 |
| 7.3.2 Manufacturing of Strapping..... | 106 |
| 7.3.2.1 Point A: Side-Release Buckle..... | 106 |
| 7.3.2.2 Point B: Method of Attachment to Thermoplastic..... | 106 |
| 7.3.2.3 Point C: Connection of Alpha Strap to Diagonal Strap..... | 107 |
| 7.3.2.4 Point D: Connection of Right-side Thermoplastic (R) to the Alpha Strap..... | 108 |
| VIII. PROTOTYPE TESTING PROCEDURES..... | 109 |
| 8.1 Construction of Mock-Prosthesis..... | 109 |
| 8.2 Range of Motion Assessment..... | 110 |
| 8.3 Axial testing..... | 110 |
| 8.4 Torsional Testing..... | 111 |
| IX. RESULTS AND DISCUSSION..... | 112 |
| 9.1 Range of Motion Assessment Results..... | 112 |
| 9.1.1 Preliminary RoM Assessment..... | 112 |
| 9.1.3 Range of Motion..... | 114 |
| 9.2 Axial Testing Results..... | 117 |
| 9.3 Torsional Testing Results..... | 118 |
| X. CONCLUSIONS..... | 119 |
| XI. RECOMMENDATIONS..... | 122 |
| 11.1 Standardization of Harness..... | 122 |
| 11.2 Sliding Alpha Harness..... | 123 |

| | |
|---|------------|
| 11.3 Improved Braking Capacity..... | 123 |
| 11.3.1 Gear Brake..... | 123 |
| 11.3.2 Pin Brake..... | 124 |
| 11.4 Weight Savings..... | 125 |
| 11.5 Controlling Degrees of Freedom..... | 126 |
| 11.6 Enhancing Applicability | 127 |
| References..... | 128 |
| Appendix A- Trip Report to Hanger Orthopedic Group..... | 131 |
| Appendix B – Free Body Diagrams..... | 134 |
| Appendix C – Mechanical Drawings..... | 154 |
| Appendix D – Anthropometric Data Analysis..... | 163 |
| Appendix E – Graphical FEA Results..... | 167 |
| Appendix F – Thread Pullout Analysis | 171 |
| Appendix G – Shear Pullout Analysis | 174 |
| Appendix H – Brake Analysis | 176 |
| Appendix I – Range of Motion Test Procedures | 177 |
| Appendix J – Axial Load Carrying Test Procedure..... | 182 |
| Appendix K – Torsional Load Carrying Test Procedure..... | 185 |
| Appendix L - Manufacturing Plans for Mock-Prostheses | 190 |
| Appendix M – Completed Selection Matrices..... | 191 |

LIST OF FIGURES

| | |
|--|----|
| Figure 1 - Three Major Planes..... | 3 |
| Figure 2 – Thorax..... | 4 |
| Figure 3 - Global Coordinate System..... | 5 |
| Figure 4 - Local Coordinate System (°)..... | 6 |
| Figure 5 - Ball and Socket Joint..... | 7 |
| Figure 6 – Angular Movements about the Shoulder ©"Range of Movement (RoM)", 1997..... | 8 |
| Figure 7 - Muscles that move the Pectoral Girdle..... | 9 |
| Figure 8 - Muscles that Move the Humerus © Tortora and Grabowski (2003) | 10 |
| Figure 9 - Muscles that move the Humerus (posterior view) © Tortora and Grabowski, 2003 | 10 |
| Figure 10 – Definition of Shoulder (left) and Elbow (right) Axes ©Murray and Johnson, 2003 | 14 |
| Figure 11 - Locations of Upper Arm Amputations ©Tortora and Grabowski, 2003..... | 15 |
| Figure 12 - Back view of cable and harness | 17 |
| Figure 13 - Example of a Myoelectric Upper Limb Prosthesis..... | 19 |
| Figure 14 - Myoelectric Prosthesis | 20 |
| Figure 15 - Figure of Eight Harness | 24 |
| Figure 16 - Kelty™ Illusion Backpack | 27 |
| Figure 17 - Over The Shoulder Baby Holder - Sling Style ©Amazon.com | 28 |
| Figure 18 - Conventional Joystick Design..... | 30 |
| Figure 19 - Design Selection Matrix | 40 |
| Figure 20- Performance Sub-categories..... | 41 |
| Figure 21- Conventional Analog Joystick Design (c) 2002 HowStuffWorks.com | 43 |
| Figure 22- Joystick Design/ Gimbal Joint | 43 |
| Figure 23- L-bracket Pin Joint Aligned with the Body | 44 |
| Figure 24- Ferromagnetic Sheath | 44 |
| Figure 25- Locking Bar | 45 |
| Figure 26- Locking Rings | 46 |
| Figure 27- Modified Gimbal Joint..... | 46 |
| Figure 28- - Backpack-style Harness; Side and Back Views..... | 47 |
| Figure 29- - Solid Shoulder Plate affixed to Asymmetrical Strapping..... | 48 |
| Figure 30- Front and Back View of the Double-Nine Harness | 48 |
| Figure 31- L-shaped Rigid Support with Under-armpit Harness..... | 49 |
| Figure 32- Front and Back View of Yoke Design..... | 49 |
| Figure 33- Isolated Yoke Design Back View (left) and Top View (right)..... | 50 |
| Figure 34- Jacket/Vest Harness | 50 |
| Figure 35- Corset Harness © www.durrettoandp.com..... | 51 |
| Figure 36- Double Armpit Harness with Torso Belt..... | 51 |
| Figure 37 - Harness with Torso Belt | 51 |
| Figure 38- Concentric Cylinder Sketch | 52 |
| Figure 39 – Rotational Bearing | 53 |
| Figure 40- Completed Matrix..... | 54 |
| Figure 41 - Isometric View of Selected Preliminary Design..... | 56 |
| Figure 42 - Removal of Tracks, Posts, and Triangular Supports | 57 |
| Figure 43 - Design Concept (neutral position) | 57 |
| Figure 44 - Design Concept (range of motion) | 58 |
| Figure 45 - Design Concept - Torque Resistant..... | 58 |
| Figure 46 - Original Harness Failure to Counter Moment..... | 61 |
| Figure 47 - Pressure Points on Body..... | 62 |
| Figure 48 - Original Harness..... | 63 |
| Figure 49 - Revised Harness 1 | 63 |
| Figure 50 - Revised Harness 2 | 64 |
| Figure 51 - Revised Harness 3..... | 64 |
| Figure 52 - Preliminary Track Design | 65 |
| Figure 53 - Redesign of Track..... | 66 |

| | |
|---|-----|
| Figure 54 - Arm Guide Screws..... | 69 |
| Figure 55 - Arm Guide Cap..... | 70 |
| Figure 56 - Original Bearing..... | 70 |
| Figure 57 - Revised Bearing 1..... | 71 |
| Figure 58 - Volume Interference..... | 74 |
| Figure 59 - Forward Flexion..... | 74 |
| Figure 60 - Elbow Flexion..... | 74 |
| Figure 61 - Triangle Geometry..... | 75 |
| Figure 62 - Device Orientation..... | 76 |
| Figure 63 - Study 1 Results..... | 76 |
| Figure 64 - Study 2 Results..... | 78 |
| Figure 65 - Study 3 Results..... | 79 |
| Figure 66 - Shear Pullout Locations 1..... | 81 |
| Figure 67 - Shear Pullout Locations 2..... | 82 |
| Figure 68 - Bearing Brake Assembly..... | 83 |
| Figure 69- Free Body Analysis of Strapping System..... | 85 |
| Figure 70- Formation of Side Thermoplastic..... | 86 |
| Figure 71- Computation of Thermoplastic Dimensions..... | 88 |
| Figure 72- Forces Acting on Side Thermoplastic..... | 89 |
| Figure 73- Computation of Maximum Pressure in System..... | 90 |
| Figure 74 - Allowable Pressure vs. Time under Bony Prominences ©1976..... | 91 |
| Figure 75 - Arm Guide Assembly (Proximal View)..... | 93 |
| Figure 76 - Arm Guide Assembly (Distal View)..... | 94 |
| Figure 77 - Arm Guide..... | 94 |
| Figure 78 - Bearing Brake Knob & Bearing Brake..... | 95 |
| Figure 79 - Bearing..... | 95 |
| Figure 80 - Arm Guide Cap..... | 95 |
| Figure 81 - Track Assembly..... | 96 |
| Figure 82 - Track..... | 96 |
| Figure 83 - Track Post..... | 96 |
| Figure 84 - Front Support & Rear Support..... | 97 |
| Figure 85- Complete Harness Assembly..... | 97 |
| Figure 86- Harness..... | 97 |
| Figure 87- Side Thermoplastic..... | 98 |
| Figure 88- Front and Back Views of Harness Assembly..... | 98 |
| Figure 89 - Total Assembly, Pro-E..... | 100 |
| Figure 90 – Total Assembly, Actual..... | 100 |
| Figure 91- Front and Back view of "Sliding Alpha Harness" System..... | 102 |
| Figure 92 - Front and Side view of Harness..... | 103 |
| Figure 93- Unbend Function in ProE..... | 104 |
| Figure 94- Thermoplastic Worksheet..... | 105 |
| Figure 95- Four Critical Points in Manufacturing..... | 106 |
| Figure 96 - Diagram of Buckle..... | 106 |
| Figure 97 - Attachment to Harness..... | 107 |
| Figure 98 - Attachment to Side Thermoplastic..... | 107 |
| Figure 99 - Alpha Harness Design..... | 108 |
| Figure 100 - Normal, rested position of device on body..... | 115 |
| Figure 101 - Positioned to "Carry a Box"..... | 115 |
| Figure 102 - Positioned to "Lift an Object" to the front of the body..... | 115 |
| Figure 103 - Pulling open a door..... | 116 |
| Figure 104 - ADL: Eating..... | 116 |
| Figure 105 - ADL: Hygiene (Wiping one's mouth)..... | 116 |
| Figure 106 - Axial Load Test at -45°..... | 117 |
| Figure 107 - Universal Harness..... | 123 |
| Figure 108 - Gear Brake..... | 124 |
| Figure 109 - Gear Brake Assembly..... | 124 |

| | |
|---|-----|
| <i>Figure 110 - Pin Brake</i> | 125 |
| <i>Figure 111 - Pin Brake Assembly</i> | 125 |
| <i>Figure 112 – Orientation of the device on the paper</i> | 180 |
| <i>Figure 113 – Motion for the Arm Interface</i> | 180 |
| <i>Figure 114 - PVC and Bolt, Zero and Ninety Degree Measures</i> | 182 |
| <i>Figure 115 - Reference marks on Arm Guide & Brake Knob</i> | 186 |
| <i>Figure 116 - Quarter-Revolution Reference Marks</i> | 186 |
| <i>Figure 117 - Additional Reference Marks</i> | 187 |
| <i>Figure 118 - Torsional Test Set-Up, Front View</i> | 188 |
| <i>Figure 119 - Torsional Set-Up, Side View</i> | 188 |

LIST OF TABLES

| | |
|--|-----|
| <i>Table 1 - Seven Muscles of Pectoral Girdle ©Tortora & Grabowski (2003)</i> | 9 |
| <i>Table 2 - Muscles Involved in the Movement of the Humerus</i> | 12 |
| <i>Table 3 - Upper Limb Activities ©Murray and Johnson, 2003</i> | 13 |
| <i>Table 4 - Maximum Measures for Elbow and Shoulder and Tasks as Presented in Table 3</i> | 14 |
| <i>Table 5 - Shoulder Orthoses</i> | 26 |
| <i>Table 6- Backpack Technology</i> | 27 |
| <i>Table 7 - Identification of Functions</i> | 32 |
| <i>Table 8 - Maximum Forces on the Body</i> | 62 |
| <i>Table 9 - Deflection Summary</i> | 68 |
| <i>Table 10 - Study 1 Summary</i> | 75 |
| <i>Table 11 - Study 2 Summary</i> | 77 |
| <i>Table 12 - Study 3 Summary</i> | 78 |
| <i>Table 13 - Screw Summary</i> | 80 |
| <i>Table 14 - Comfort Survey for Strapping</i> | 84 |
| <i>Table 15 - Project Budget</i> | 101 |
| <i>Table 16 - Slope of trapezius muscle</i> | 104 |
| <i>Table 17 - RoM Comparison Between Human and Computer</i> | 113 |
| <i>Table 18 – Average RoM Measures</i> | 114 |
| <i>Table 19 – Average Decrease in Reported Motions</i> | 114 |
| <i>Table 20 - Model Range of Motion and Respective Joint Angles</i> | 178 |

INTRODUCTION

There are a number of circumstances that can lead to the loss of normal arm function. The loss can be neurological, muscular, or skeletal and the severity can affect how well individuals perform activities of daily living. In some cases an individual will adapt to their environment and learn to perform routine tasks with the use of one arm but in a modified way.

However, in cases where the arm is no longer intact, an individual may try to regain functionality of the lost limb by the use of a prosthetic device. Prosthetic devices vary greatly in how they function and how they attach to the residual limb. Cosmetic prostheses are aesthetically pleasing but offer limited functionality. In contrast, functional prostheses perform very well under a specific set of operating conditions.

The function of the prosthesis in many ways dictates how it is attached to the user's body. For example, the purpose of the cosmetic prosthesis is to mimic the appearance of a natural arm. Because this prosthesis does not need to perform like a natural arm, it does not need to handle the loads typically experienced by the arm. Therefore, friction fit sockliners which hold the prosthesis against the user's residual limb are a common method of attachment for this application. With this arrangement, range of motion in the shoulder is preserved, but high load bearing conditions are not possible.

Functional prostheses, which are tailored for a specific set of tasks, often require more than a friction sockliner to handle large loads. In cases where high loads are encountered by a prosthesis, the preferred method of attachment is strapping. While this method is generally able to provide adequate support under high loads with the arm in a few positions, this method can severely restrict range of motion in the shoulder.

The purpose of this Major Qualifying Project was to design, develop, and test a device that would allow for the attachment of a prosthesis and provide stability under increased loads, while not hindering the user's range of motion. For this project we are considering the user's range of motion to be the set of movements that are required to perform Activities of Daily Living (ADLs).

The standard steps of design were followed in this project. The first phase was the conceptualization phase where ideas of possible solutions to the problem were generated. Next the designs were evaluated and modified resulting in the selection of one final

design. This final design was modeled using 3-D CAD software and analyzed for performance. An optimized design was manufactured, assembled, and tested to see how well the functions met our original goals. The results were then analyzed and discussed leading to recommendations for further refinement of the prototype.

I. BACKGROUND

To design for a prospective Shoulder Mount device, an exploration into the anatomy of a healthy functioning joint is needed. From these deductions as to the properties and responsibilities of each muscle and anatomical joint function can be understood and relayed into conceptual design ideas, translating the inside functions outside of the body. Current technology used to address upper-extremity amputations and amelioration of limb loss will provide a stable background from which to develop theory into design.

1.1 Anatomical Terms and Definitions

In designing a shoulder mount for upper-arm prosthesis users, the foundation upon which the mount will be located must be examined. Before exploring the body parts that will constitute this foundation, it is necessary to prepare the groundwork by outlining some of the terms and conventions which will be referenced throughout the paper.

The body can be divided by its three major planes (Figure 1). The frontal plane (1) is a vertical plane dividing the body between front and back. The sagittal plane (2) is also a vertical plane, but differentiates between the left and right sides of the body. The transverse plane (3) runs horizontally and separates the top half of the body from the bottom.

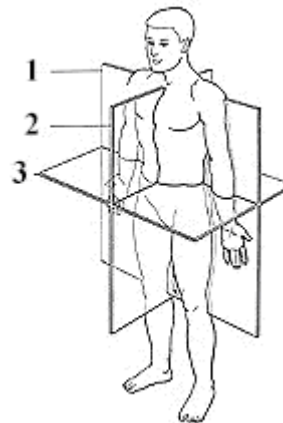

Figure 1 - Three Major Planes

©e-radiography.net

There are several anatomical terms that are used to describe the location of one aspect or part of the body in relation to another. Along the frontal plane, if something is relatively located towards the front of the body then it is referred to as *anterior*, as opposed to something relatively located towards the rear, which is referred to as *posterior*. The top half of the transverse plane is identified as *superior*, and anything that is below is identified as *inferior*. Something that is closer to the midline of the body, referenced by the sagittal plane, is known as *medial*, and anything closer to the sides of the body is known as *lateral*. One more important reference that is not associated with a direction along a major axis is the reference along a limb. Anything closer to the main trunk of the body is labeled as *proximal* and anything toward the end of the extremity is labeled as *distal* (Tortora & Grabowski, 2003). This basic set of nomenclature will be referred to throughout this paper.

The design of a Shoulder Mount will mainly be focused on the thorax (Figure 2), which is the middle region of the body bordered by the head at the top and the abdomen on the bottom and the humeroscapular or glenohumeral joint, which is more commonly known as the shoulder joint. The thorax, better known as the chest, is partially structured from beneath with the ribs. Connecting the ribs in the back is the spinal column, and in the front is the sternum. The main focus on the body will be the upper outside corner of the thorax- the pectoral girdle, commonly known as the shoulder. There are two bones that that make up the pectoral girdle, the clavicle and the scapula. A third bone, the upper arm bone called the humerus, articulates with the scapula to form the shoulder joint.

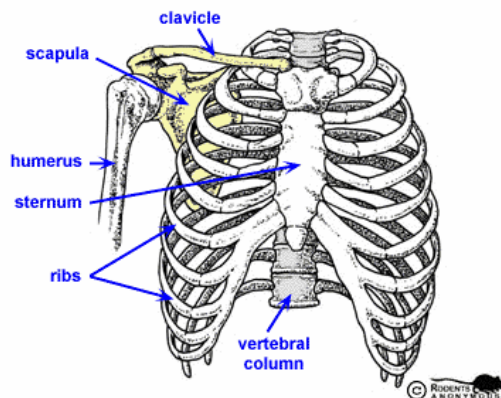

Figure 2 – Thorax

©Marymount School, 2005

The following global coordinate systems will be used to reference all work in this document (Figure 3). The Y-axis is vertical, perpendicular to transverse plane, the X-axis is perpendicular to the sagittal plane of the body, and lastly, the Z-axis extends forward and is perpendicular to the frontal plane of the body. The origin of this coordinate system passes through the shoulder's axis of rotation (i.e. the axis about which the humerus rotates relative to the body). The global coordinate system is fixed relative to the body and is independent of movement of the humerus.

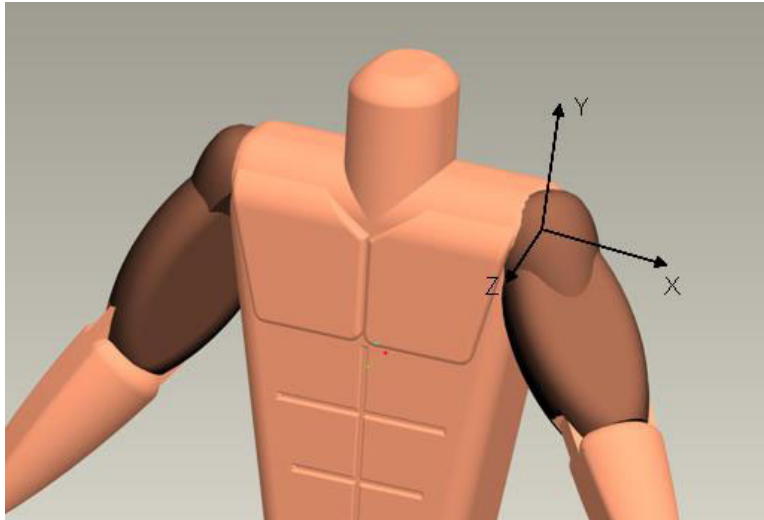

Figure 3 - Global Coordinate System

A local coordinate system was generated for analysis of four functional positions identified that a prospective prosthesis user may encounter in everyday life, shown in Figure 4. This local coordinate system shares the same Y-axis as the global coordinate system, however the X and Z-axes are rotated 50° about the Y-axis (in Figure 3) as X' and Z' , respectively. This local coordinate system is a fixed coordinate system relative to the body (i.e. movement of the humerus does not affect the orientation of the axes).

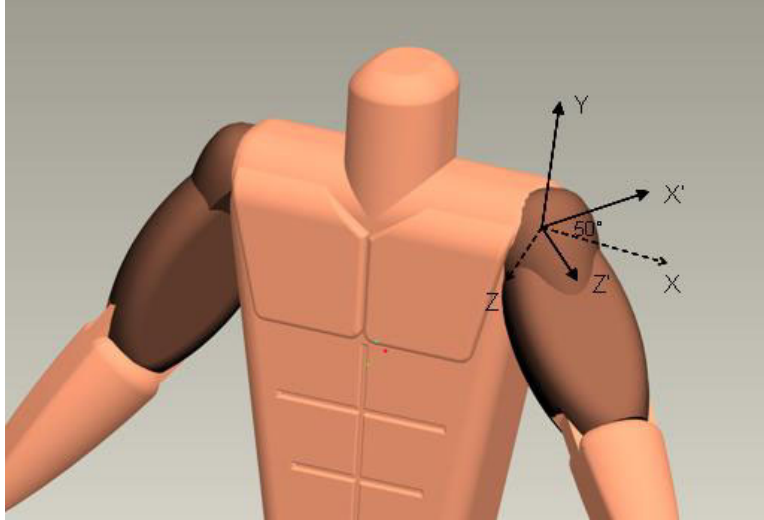

Figure 4 - Local Coordinate System (')

1.2 Shoulder Joint Movement

Joints in the body are divided into functional groups, where the shoulder joint is a diarthrosis, or a moveable joint. All moveable joints in the body are also synovial joints, meaning a cavity exists between the articulating surfaces. This cavity contains a synovial membrane that encapsulates synovial fluid which lubricates the joints.

The shoulder can also be defined by its geometry, where it is a ball and socket joint (Figure 5). The ball-and-socket joint model is used to represent articulations with three rotational degrees of freedom. The degrees of freedom, or the set of independent displacements that specify the position of the body, in an anatomical joint are dependent upon two factors, the shape of the articular surface and the number of ligaments. In the shoulder joint there are three degrees of freedom- pitch, yaw, and roll, which allows for rotation about all three major axes (Dowling, 2000). Pitch, yaw, and roll can be described as moving up and down (flexion/extension), moving left and right (abduction/adduction), and titling side to side- a rolling motion from the shoulder (internal/external rotation), respectively.

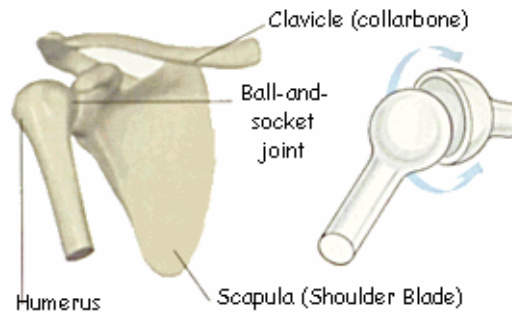

Figure 5 - Ball and Socket Joint

© Marymount School, 2005

The three degrees of freedom enabled by the shoulder joint gives rise to the ability to perform particular movements associated with everyday life. Specifically, there are three groups of angular movements that are associated with the shoulder joint. The first group of movements is flexion and extension. Flexion occurs when the arm moves up and away from the frontal plane, while extension mimics the motion only in the opposite direction, bringing the arm back down to the side of the body or in line with the frontal plane; during extension the angle between the articulating bones is increasing. These movements could also be thought of as rotation about the y -axis. Putting these motions in continuous sequence will give the motion of circumduction. The action of hyperextension occurs when the arm is pushed back towards the posterior side of the body further than normal extension.

The second group of movements is abduction and adduction. Abduction is defined as lateral movement away from the midline of the body, while adduction is just the opposite- medial movement towards the midline of the body or bringing the arm closer to the side of the body. This movement can simply be thought of as rotation about the x -axis.

The third group of movements is internal and external rotation. Internal medial rotation is classified as rotary movement around the longitudinal axis of the bone toward the center of the body; turning the upper arm inward, while external medial rotation is classified as rotary movement around the longitudinal axis of the bone away from the center of the body; turning the upper arm outward. This movement is relative to the scapula and could be thought of as rotation about the z -axis (Biryukova, 2000)(Figure 6). According to Ozkaya (1999), “for every 15 degrees of shoulder abduction, 10 degrees

occurs at the glenohumeral joint and 5 degrees occurs at the scapulothoracic joint; for 180 degrees of shoulder abduction, 120 degrees occurs at the glenohumeral joint and 60 degrees occurs at the scapulothoracic joint.”

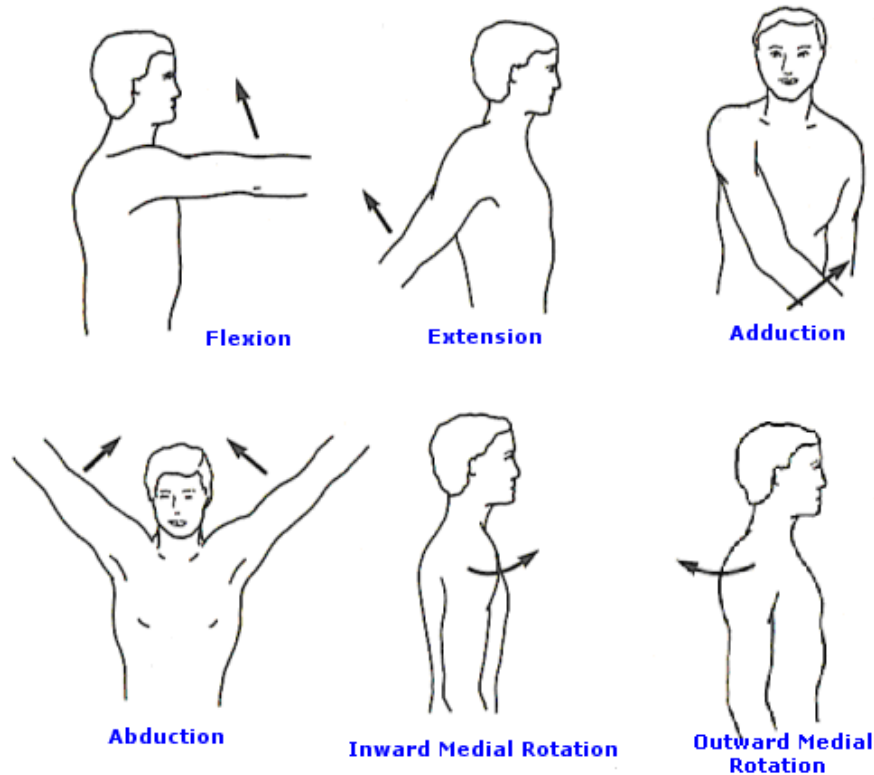

Figure 6 – Angular Movements about the Shoulder
 ©”Range of Movement (RoM)”, 1997

1.3 Shoulder Musculature

The complicated movements that can be achieved by the shoulder are not only a result of the four distinct articulations that take place at the shoulder but also by the muscles that are present and required to move a trans-humeral amputee’s arm in the individual’s three degrees of freedom. These muscles serve not only to directly apply a force to a certain body member to induce motion, but also to stabilize the joints and associated bones. There exist two main muscles groups affecting the humeral movement. The first group consists of seven muscles that move the pectoral girdle (Figure 7). The second group consists of nine muscles that move the humerus (Figure 8 and Figure 9). The muscles from each group are listed in Table 1.

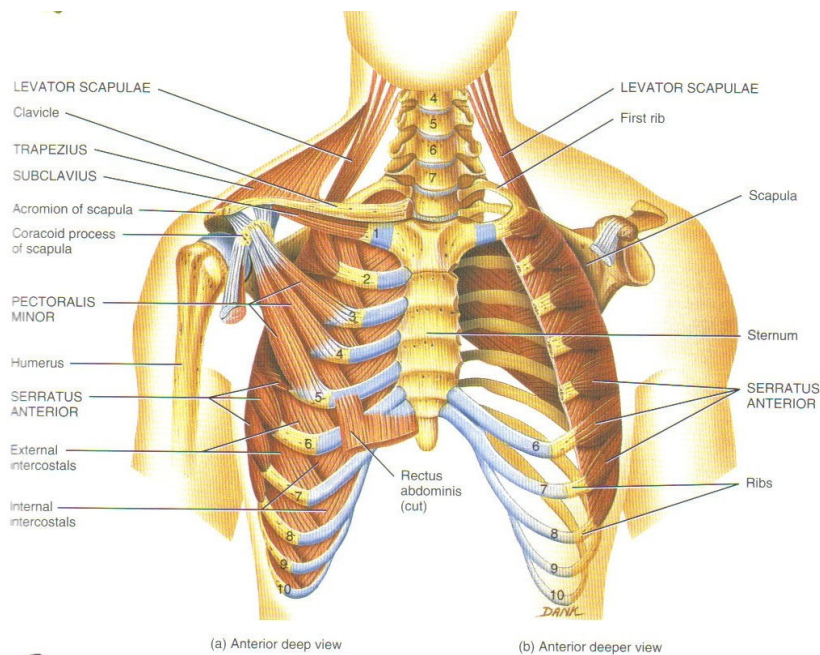

Figure 7 - Muscles that move the Pectoral Girdle

©Tortora and Grabowski, 2003

Table 1 - Seven Muscles of Pectoral Girdle

©Tortora & Grabowski (2003)

| # | Muscle | Function |
|---|-------------------|---|
| 1 | Subclavius | Move clavicle anteriorly, stabilize pectoral girdle |
| 2 | Pectoralis Minor | Abduct scapula and rotates downward |
| 3 | Serratus anterior | Abducts scapula and rotates upward |
| 4 | Trapezius | Elevate, rotate, and stabilize scapula |
| 5 | Levator scapulae | Elevates scapula and rotates downward |
| 6 | Rhomboid major | Elevates, adducts and stabilizes scapula |
| 7 | Rhomboid minor | Elevates, adducts and stabilizes scapula |

The muscles that move the pectoral girdle function to stabilize the scapula so that it can function as a steady origin for most of the muscles that move the humerus. Scapular movements typically accompany humeral movements in the same direction and thus these muscles move the scapula to increase range of motion of the humerus. For example, during abduction, the scapula follows the humerus by rotating upward. The scapula also moves laterally and medially, as when pushing or pulling an object.

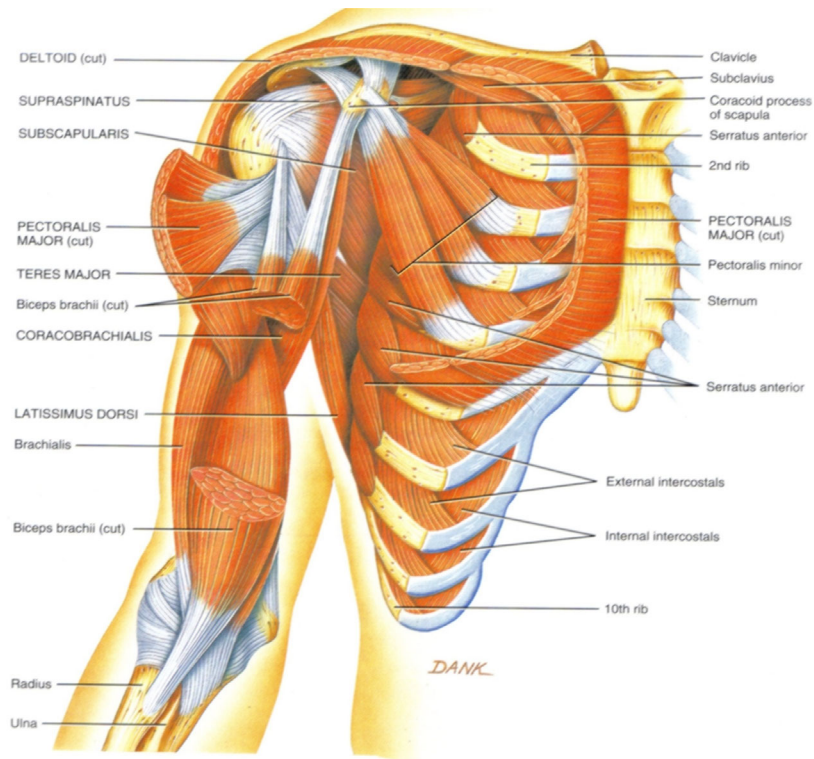

Figure 8 - Muscles that Move the Humerus
 © Tortora and Grabowski (2003)

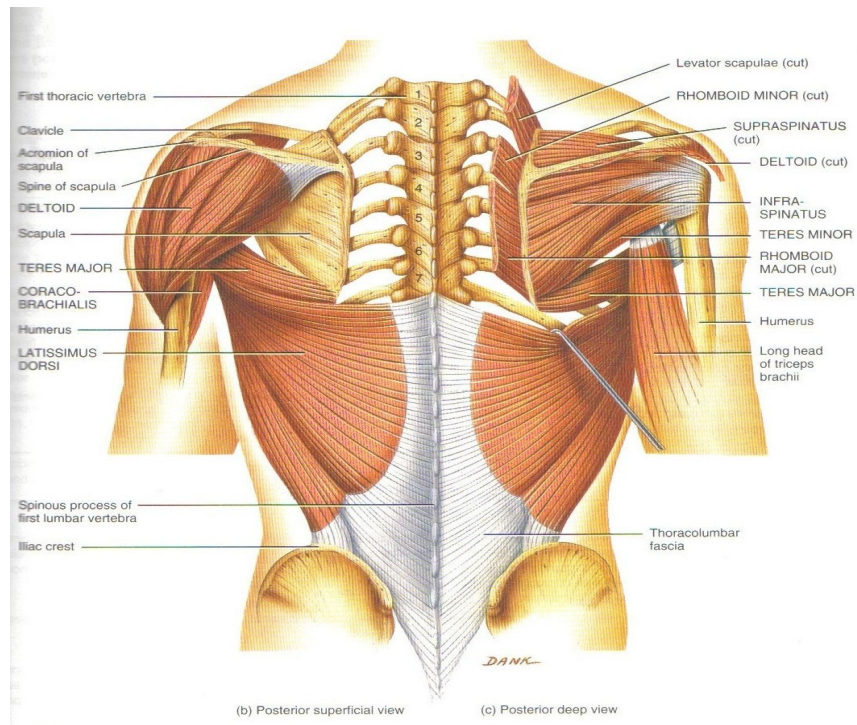

Figure 9 - Muscles that move the Humerus (posterior view)
 © Tortora and Grabowski, 2003

Of the nine muscles that cross the shoulder joint, all except the *pectoralis major* and *latissimus dorsi* originate on the scapula and are referred to as axial muscles. The remaining seven muscles arise from the scapula. Among the scapular muscles, the *deltoid* is a thick, powerful shoulder muscle that covers the shoulder joint and is involved in moving the arm. The *deltoid* can be divided into three main components: lateral, anterior, and posterior. Beneath the *deltoid* are the remaining muscles, such as the *subscapularis*, *supraspinatus*, and *infraspinatus*. The *teres major* and *minor* are lower in the body than these three. Lastly, is the *coracobrachialis*, which runs from the scapula to the humerus, near the shoulder.

Table 2 - Muscles Involved in the Movement of the Humerus

| Muscle | Origin | Insertion | Action |
|------------------|---|--|---|
| Pectoralis major | Clavicle, sternum, and costal cartilages of second to sixth rib | Greater tubercle of humerus | As a whole, adducts and medially rotated arm; clavicular head alone flexes arm; and sternocostal head alone extends arm at shoulder joint |
| Latissimus dorsi | Spines of inferior six thoracic vertebrae, lumbar vertebrae, crests of sacrum and ilium | Intertubercular sulcus of humerus | Extends, adducts, and medially rotates arm at shoulder joint; draws inferiorly and posteriorly |
| Deltoid | Acromial extremity of clavicle (anterior fibers), acromion of scapula (lateral fibers), and spine of scapula (posterior fibers) | Deltoid tuberosity of humerus | Lateral fibers abduct arm at shoulder joint; anterior fibers flex and medially rotate arm at shoulder joint; posterior fibers extend and laterally rotate arm at shoulder joint |
| Subscapularis | Subscapular fossa of scapula | Lesser tubercle of humerus | Medially rotates arm at shoulder joint |
| Supraspinatus | Supraspinous fossa of scapula | Greater tubercle of humerus | Assists deltoid muscle in abducting arm at shoulder joint |
| Infraspinatus | Infraspinous fossa of scapula | Greater tubercle of humerus | Laterally rotates and adducts arm at shoulder joint |
| Teres Major | Inferior angle of scapula | Intertubercular sulcus of humerus | Extends arm at shoulder joint and assists in adduction and medial rotation of arm at shoulder joint |
| Teres Minor | Inferior lateral border of scapula | Greater tubercle of humerus | Laterally rotates, extends, and adducts at shoulder joint |
| Coracobrachialis | Coracoid process of scapula | Middle of medial surface of shaft of humerus | Flexes and adducts arm at shoulder joint |

1.4 Activities of Daily Living

The four complex articulations give rise to a very large range of motion, which according to Kaufman, exceeds a hemisphere (2001). The upper arm has a total of seven degrees of freedom; three in the shoulder, two in the elbow and two in the wrist. The three in the shoulder are rotation about the *x*, *y*, and *z*-axes. However, as a result of the wide range of motion, the shoulder is an unstable joint and is susceptible to injury.

While there is a considerable amount of information pertaining to kinematics of the lower limbs, this is not the case for upper limbs. This may be in part due to the fact that the loss of a lower limb is more critical than the loss of an upper limb. However it is still advantageous to have an idea of the forces and moments that are experienced in the upper arm during various activities. In a study conducted by Murray and Johnson (2003), a database of upper limb kinematics and kinetics of the shoulder and elbow was constructed using ten unimpaired male subjects performing ten different tasks of every day living using his right arm. According to the National Center for Health Statistics (2004), activities of daily living are activities requiring low-force for execution “related to personal care and include bathing or showering, dressing, getting in or out of bed or a chair, using the toilet, and eating”. Some tasks associated with each of the categories included reaching to the back and side of head, drinking from a mug, and raising a block to head height. Table 3 presents the activity and the specific facet of daily living the task qualifies into, as presented by the authors.

Table 3 - Upper Limb Activities
©Murray and Johnson, 2003

| Activity | Area of Use |
|--------------------------------------|--------------------|
| 1. Reach to opposite axilla (armpit) | Hygiene |
| 2. Reach to opposite side of neck | Hygiene |
| 3. Reach to side and back of head | Hygiene |
| 4. Eat with hand to mouth | Feeding |
| 5. Eat with a spoon | Feeding |
| 6. Drink from a mug | Feeding |
| 7. Answer telephone | Everyday object |
| 8. Brush left side of head | Hygiene |
| 9. Raise block to shoulder height | Everyday object |
| 10. Raise block to head height | Everyday object |

All activities were performed by males with a mean age of 34.3 (SD ±11) years, situated in a seated position to isolate upper limb movement from that of the trunk. To ensure consistency throughout each trial and between subjects, ten repetitions of each activity were performed, divided into two sets of five. Analysis was based on the middle repetition of the second set of five to ensure the motions would naturally mimic those motions of the everyday; one datum point per subject per activity. Analysis occurs about the anatomical axes presented in Figure 10. It must be noted that the axis orientation used

for this study is slightly different than the one outlined at the beginning of this section. In this case the positive $-x$ direction is to the person's right, the positive $-y$ direction is forward, and the positive $-z$ direction is up.

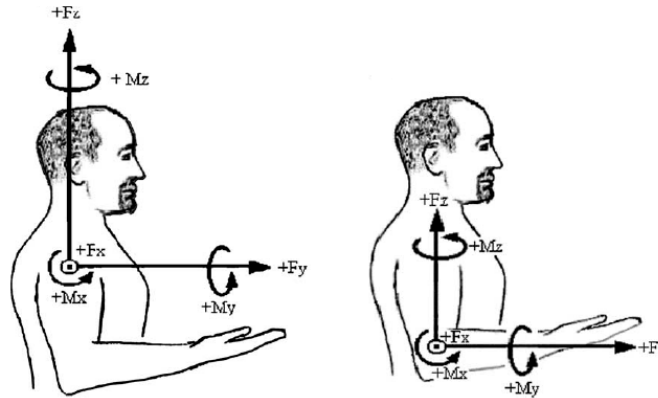

Figure 10 – Definition of Shoulder (left) and Elbow (right) Axes
©Murray and Johnson, 2003

The degree at which a user can perform the activities of daily living generally defines his/her functional capacity. Table 4 presents the maximum and minimum angles of the shoulder for the correlating tasks presented in Table 3. It is noted that elbow range of motion is not dependent upon humeral angles, Murray and Johnson (2003).

Table 4 - Maximum Measures for Elbow and Shoulder and Tasks as Presented in Table 3

| Angle | Task | Angle (°) | SD |
|----------------------------|------|-----------|------|
| Shoulder Flexion | 10 | 111.9 | 7.4 |
| Shoulder Extension | 10 | 14.7 | 7.6 |
| Shoulder Abduction | 10 | 39.7 | 6.9 |
| Shoulder Adduction | 2 | -20.1 | 9.2 |
| Shoulder Internal Rotation | 1 | 85.9 | 11.7 |
| Shoulder External Rotation | 10 | 18.7 | 7.8 |
| Elbow Flexion | 3 | 164.8 | 8.0 |
| Elbow Extention | 10 | 15.6 | 6.6 |
| Elbow Pronation | 3 | 65.3 | 8.2 |
| Elbow Supination | 2 | -53.7 | 12.6 |

The data collected by Murray and Johnson was representative of persons with two fully-functioning upper-limbs. For persons with an amputation on either limb, the degree at which he/she can perform activities of daily living is limited, depending on the selected

treatment for the amputation, if any. Various levels of amputation include: transcarpal (through the hand), wrist disarticulation (at the wrist), transradial (through the forearm), elbow disarticulation (at the elbow), transhumeral (through the humerus), shoulder disarticulation (at the shoulder), and forequarter (above the shoulder, removing the scapula and clavicle), all requiring different recovery therapy and prosthetic solutions (Toren, 2004). Figure 11 outlines the regions of possible upper-arm amputations, denoted by numbers one through three. As can be visually observed, specific muscles are affected at different amputation locations. The design of a Shoulder Mount will focus on transhumeral amputations.

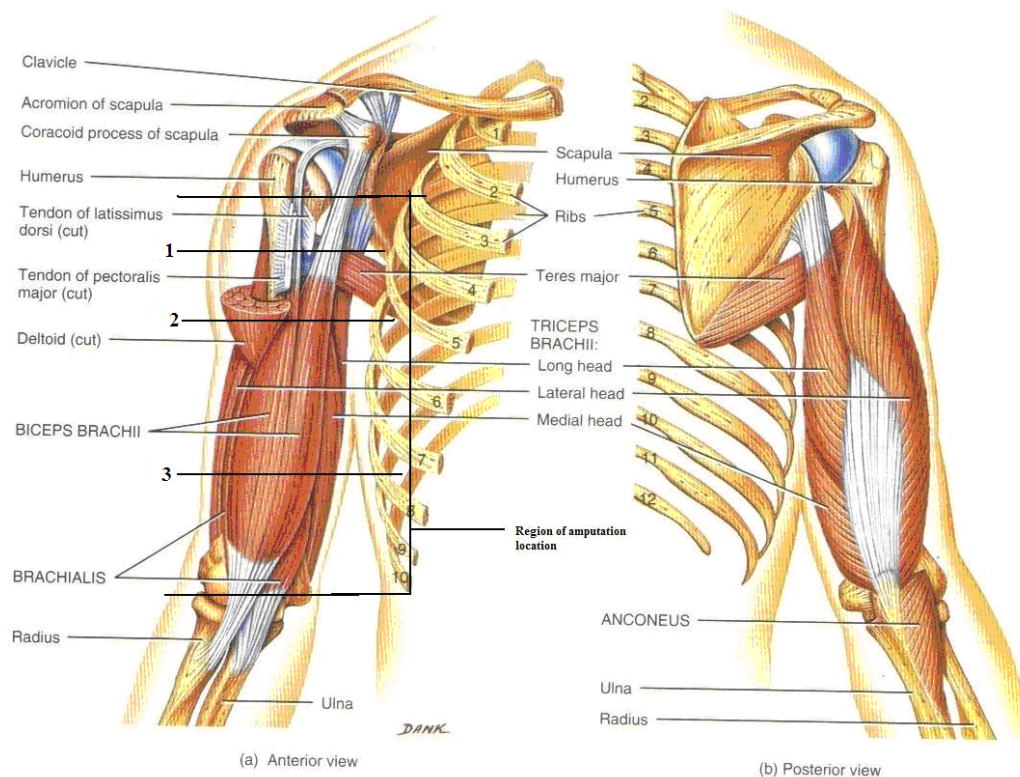

Figure 11 - Locations of Upper Arm Amputations
 ©Tortora and Grabowski, 2003

1.5 Prosthetics

For upper-arm amputees, the use of a prosthetic device can enable users to perform activities of daily living with ease comparable to a fully functioning limb. A prosthetic device is a custom designed and/or fitted anatomical device applied externally to the human body as it is intended to restore congenital and/or acquired neuromuscular and musculoskeletal dysfunctions of the human body associated with the complete or

partial absence of a limb (Orthotics & Prosthetics Rehabilitation Centre, 2000). A prosthetic device must meet both the mechanical and functional requirements essential to carry out activities of daily living as well as satisfying basic user requirements (ie. being comfortable, easy to put on and remove (don and doff), lightweight, durable and aesthetically pleasing). However, the overall success or compliance of a user's prosthesis ultimately relies on the motivation of the individual, as the sense of stigma often associated with disfigurement can develop as a socio-physiological and economic handicap ("Orthopaedic Surgery: Upper Limb Prosthetic Centre", 2005). Proper fitting of a prosthetic device can relieve a person of psychological stress associated with physical loss and protect a sensitive and painful stump while encouraging normal use of the limb ("Orthopaedic Surgery: Upper Limb Prosthetic Centre", 2005).

For each varying degree of amputation, a prosthetic device is custom fit to the individual depending on the residual limb size and length and activity level of the user. Prostheses can be divided into two general categories, passive and active. The passive prosthesis serves as an option for upper extremity patients who do not require precise hand control or grasp, and seek a cosmetically pleasing prosthesis; on the other hand, active prostheses such as myoelectric devices and body-powered designs dominate the market, allowing for functional grip and movement.

1.5.1 Passive Prosthetic Systems

A passive prosthesis provides a restoration of body symmetry, tending to remove the conspicuous nature of an injury or limb loss. A prosthetic limb adds weight to the human torso, balancing out the spine for better alignment and further offering protection to the residual limb. These types of prostheses can be designed very simply or can be dramatic life-like restorations. The passive prostheses, while restoring anatomical shape, may also have minimal function that enables the prosthetically restored limb to accomplish tasks more effectively but does not enable the limb or body to actively articulate or maneuver. For example, a prosthetic hand may have an open-close function, where one gross body movement will close the hand, it will forever remain tightly closed until another gross body movement activates the release. Our design goal will focus on a full range of function and motion, thereby eliminating further passive system consideration.

1.5.2 Active Prosthetic Systems

Active prosthetic systems are categorized into two functional systems: body-powered and a more complex myoelectric design.

1.5.2.1 Body-Powered

Body-powered prosthetic systems are a more simplistic option for the trans-humeral amputee. They are the most durable prostheses on the market, requiring gross limb movement for operation, and provide high sensory feedback. Users must have the required strength and range of motion necessary to effectively operate a body-powered prosthetic device, whereas functional limitations in strength and range of motion may prohibit a person's ability to use a body-powered design. Primary movements with the use of an upper-limb body-powered prosthesis are glenohumeral flexion and bicipital abduction (Lansang, 2001). Body-powered prostheses are connected to the body through a series of cables and harnesses (Figure 12).

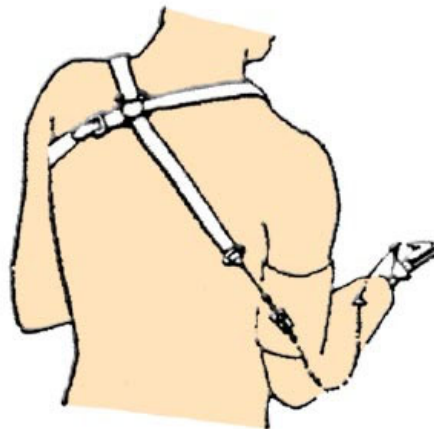

Figure 12 - Back view of cable and harness

©National Amputee Center

The harness is worn around the opposite arm and across the back with a cable attached to the harness and terminal device (hooks, hands, etc.) (Sheck & Siress, 2005). The cable and harness system of a body-powered device is operated by using back and shoulder muscles and movements. When the cable is pulled it either opens or closes the hand or hook. Harnessing is very specific to the individual and what works for one amputee may not be adequate for another. The system can be adapted to accommodate a

wide range of activities of daily living and activities outside of the “norm” (example, a specific harness used for skiing, fishing, etc).

With this said the harness and cable system can be both the best and worst aspect of a body-powered system. While the user gains valuable proprioception (sensory awareness) through the pressure felt in the harness system during operation of the prosthesis, the same pressure may create discomfort and contribute to long-term nerve compression and repetitive stress problems (Farnsworth, 2004). Users with full functional ability in the opposing arm tend to want to eliminate the need for a harness whereas users missing both arms are less affected by the impositions of the cable as the harness is attached to the opposite prosthesis rather than the opposite arm.

The most common users of body-powered prostheses are those that have worn the type of device for a long period time, such as war veterans; newer, more advanced technology may not have been initially provided at the time of the first prosthetic fitting. Body-powered designs attract other users because of specific activities that might preclude the use of other types of systems, including operating the prosthesis in damp or wet environments or for very heavy-duty applications where more refined myoelectric designs would not be suitable due to the sophisticated material selection. Primary limitations in body-powered prostheses include limited functional grip strength, restrictive harnessing, and poor cosmesis (the outer, aesthetic covering of a prosthesis) in comparison to the more advanced myoelectric designs.

1.5.2.2 Myoelectric

The myoelectric prosthetic system (Figure 13), or prosthesis controlled by the electrical impulses created by muscle tissue (myoelectricity), serves as a sophisticated prosthesis option for patients with traumatic or congenital absence of the forearm and hand.

The operation of electric motor-driven hands, wrist, and elbows in myoelectric prostheses function by transmitting electrical activity that the surface electrodes on the residual limb muscles detect to the electric motor. A myoelectric signal, also referred to as a motor action potential, is an electrical impulse that produces internal muscle fiber contractions, most often used in reference to skeletal muscles that control voluntary movements. Myoelectric signals have frequencies ranging from a few hertz to about 300

Hz, and voltages ranging from approximately 10 microvolts to 1 millivolt (Morin, 1990). Surface electrodes embedded in the prosthesis socket make contact with the skin and detect and amplify muscle action potentials from voluntarily contracting muscle in the residual limb. The amplified electrical signal activates an electric motor to provide a function (ie. terminal device operation, wrist rotation, elbow flexion). The newest electronic control systems perform multiple functions, and allow for sequential operation of elbow motion, wrist rotation and hand motions (Ritchie, 2005).



Figure 13 - Example of a Myoelectric Upper Limb Prostheses

© Brown University Division of Biology and Medicine

There are two types of myoelectric units (Figure 14): (1) the 2-site/2-function device, which has separate electrodes for flexion and extension and (2) the 1-site/2-function device, which has one electrode for both flexion and extension. The patient uses muscle contractions of different strengths to differentiate between flexion and extension. For example, a strong contraction opens the device, and a weak contraction closes it.



Figure 14 - Myoelectric Prosthesis
©Active Living Magazine, 2004

The myoelectric device is appropriate for both above-the-elbow and below-the-elbow amputees, and for both unilateral and bilateral amputees. Myoelectric prostheses have a stronger pinch force, better grip, are more flexible and easier to use than conventional hooks, while displaying enhanced cosmesis (Aetna, 2005).

Myoelectric prosthetic systems utilize the natural action of remaining muscles, dramatically reducing and even eliminating the need for a cable and harness system. Rather, these devices employ other suspension options, such as direct-suction suspension for transhumeral amputations and supracondylar suspension for transradial amputations; silicone suspension sleeves are the newest addition to suspension (Salam, 1994). To date, myoelectric prosthetics are the most common type of externally-powered systems, operated by the user's contraction of residual muscle (Ritchie, 2005). The internal operating system eliminates the necessity of gross body movements for operation.

While the myoelectric design allows for interchangeable terminal devices allowing for a variety of gripping options, the most significant disadvantages of the system are total cost, and overall weight; however, since externally powered prostheses are self-contained, they eliminate harnessing and activation cables (as described in the subsequent section) and are thus more cosmetically acceptable to the new amputee. The user must have sufficient muscle strength and control to operate the prosthesis as well as

adequate tolerance to support the additional weight of the myoelectric components (Farnsworth, 2004).

1.6 Problems with Existing Technology

Body-powered prostheses are attached to the body via an internal suction system, where suspension is provided by means of negative pressure or a vacuum in the socket. This is achieved by forcing air out of the socket through a one-way valve when donning and using the prosthesis. Vacuum and suction applications are ideal for transhumeral amputations (direct-suction suspension) and for transradial amputations (supracondylar suspension). Above-elbow design variations that distribute some of the added loading of external-power prostheses are much tighter and require the patient to pull into the socket. A custom-designed sock is wrapped over the limb and pulled through a hole in the socket. The socket is made smaller than the residual limb so that the limb shape and the limb tissue will compress and hold the prosthesis on (Stark, 2006). While the suction method provides a sound fit between the residual limb and the prosthesis, it does not compensate for higher-force activities a user might encounter. Consultation with prosthetist Tim Curran at Hanger Orthopedic Group, Inc. referenced that there is essentially no limit on load bearing post-amputation compared to pre-amputation (

Appendix A- Trip Report). If an amputee requires a prosthesis that supports axial loads of 100 pounds because that is what they used to carry before the amputation, there are harnessing systems available that will enable that. However, the actual prosthesis often limits the maximum loads. For example, Mr. Curran can design a harness system that can withstand loads of 100 pounds. However, the amputee cannot use a certain myoelectric prosthesis because the elbow joint is only rated for 40 pounds. Therefore, the amputee must lose some of the overall functionality associated with a myoelectric prosthesis in exchange for a prosthesis designed specifically for carrying heavy loads. A system that could incorporate compensation for great axial load bearing in both a harnessing system and the prosthesis would be ideal.

Other significant factors to consider when designing a proposed Shoulder Mount would be in avoiding the many nerves in the armpit and surrounding the shoulder. The heat in the armpit can cause problems with skin irritation, rash, and sweating. In general, the greater the area over which the load is distributed, the less pressure the user feels. Bony protrusions (clavicle, ribs, etc) must be avoided in order to avoid possible fractures or discomfort. Bones may become more or less prominent, muscles change shape, and skin bunches. Lastly, full range of motion must be enabled.

1.7 Prospective Users of the Shoulder Mount Device

Overall, between 1988 and 1996, there was an average of 133,735 hospital discharges for amputation per year, including both upper and lower-limb amputations. Rates of trauma-related and cancer-related amputations have both declined by approximately half over the past 20 years, while the incidence of congenital (condition present at birth) limb deficiency has remained stable over the past 30 years (National Center for Health Statistics, 2004).

1.7.1 Upper-limb Amputations

In 2004, the National Center for Health Statistics reported that there were approximately 1.6 million people living with limb loss in the United States. That statistic translates to an estimated one out of every 200 people in the U.S. has had an amputation. For upper-limb amputees, the majority of new amputations occur due to trauma-related injuries, which accounted for 68.6 percent of the new amputations during the study

period, 1988-1996. Males were at a significantly higher risk for trauma-related amputations than females. However, for both males and females, risk of traumatic amputations increased steadily with age, reaching its highest level among people age 85 or older. Incidence of congenital limb deficiency has seen little or no change. Rates of congenital limb anomalies among newborns were at 26 per 100,000 live births, relatively unchanged over the study period. Upper-limb deficiencies accounted for 58.5 percent of newborn, congenital limb anomalies.

1.7.2 Limb Difference

Limb difference is a congenital disorder has not been scientifically proven to be the result of a genetic condition. It is hypothesized that genetic mutations in an unborn child's genes may cause limb absence or deformations. Additionally, a mother's use of drugs during pregnancy may increase the chances of limb difference in a newborn ("Information Center – Limb Loss Frequently Asked Questions," 2005). Now illegal in the United States, the drug thalidomide was a sedative drug prescribed to women suffering morning sickness. It was later discovered that the use of this drug often resulted in birth defects, including limb difference (Thalidomide Victims Association of Canada, 2003). Because prosthesis users include children born with congenital disorders, we must be sure that our design meets the specific needs of young people, yielding a true 'universal' application.

1.8 Analogous Technology

In addition to examining current technology in the field of prosthetics, it is also helpful to investigate designs in other fields that perform similar functions. An improvement upon the current state of prostheses attachment and joint movement is needed in order to design an improved technology.

1.8.1 Harnessing Systems

The control cable and harness system work together to provide two main objectives: (1) to suspend the socket on the residual limb and (2) to transmit force from the body movements to the prosthesis for operation of body-powered components. In doing so, the harness must be adjusted to the user's form, distribute the load, and be stable in all normal positions. This must be done with minimal interference of the

components and minimal control complexity. The control movements used must be independent of one another and be operable by relatively inconspicuous body motion. The harness must also be easy to don and doff so the client can put it on and take it off with minimal help (Stark, 2006).

In general, harness systems that distribute loads on the human body try to concentrate the load as close to the body center of gravity as possible. This positioning results in the lowest energy cost for the user. The more a load deviates from the body center of gravity, the more the user must compensate by either changing his/her gait pattern or engaging different muscles (Knapik et al. 1996). Harness systems that attach loads to the body (e.g. backpacks and baby carriers) seek to solve these problems associated with load carrying.

1.8.1.1 Upper-Extremity Prostheses Harnesses

Three types of harnesses are existent for attachment of the upper-limb prostheses, the figure of eight, cross chest strap, and figure of nine. The figure of eight is the standard type of prosthesis attachment comprised of an axilla loop, which serves as the anchor, a cable attachment strap, and a suspension strap (Figure 15).

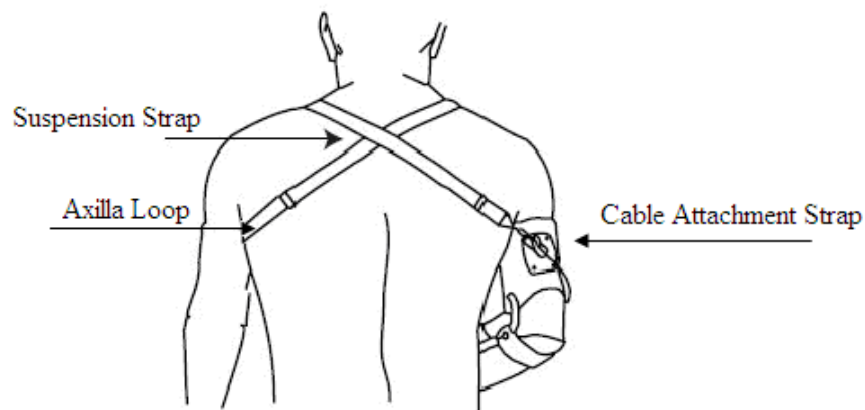

Figure 15 - Figure of Eight Harness



The Figure of nine harness is ideal for light-duty lifting. It is the same design as the figure of eight, minus the suspension strap. It is used with body-powered below the elbow prosthesis. Lastly, the cross chest strap is manufactured for heavy-duty applications and is comprised of a cross chest strap and shoulder saddle. Farmers are typically the main users for this type of harness (Stark, 2005).

1.8.1.2 Shoulder Orthoses

While a prosthesis is a device designed to replace, as much as possible, the function or appearance of a missing limb or body part, an orthosis is an externally applied device designed to supplement or augment the function of an existing limb or body part and restore or improve functional and structural characteristics of the musculoskeletal and nervous systems. Upper extremity orthoses are used frequently by users who suffer from musculoskeletal problems resulting from trauma, sports, and work-related injuries and by patients who have had neurological problems, such as stroke, traumatic brain injury, multiple sclerosis, cerebral palsy, spinal cord injury, and peripheral nerve injury, as well as varying degrees of arthritis.

An effective orthosis is intended to increase range of motion, to immobilize an extremity to help promote tissue healing, to apply traction either to correct or prevent contractures (the stiffening of joints), to assist in providing enhanced function, to serve as an attachment for assistive devices, to help correct deformities, and/or to block unwanted movement of a joint (Lansang, 2006). Table 5 provides a list of generalized shoulder orthoses attachments, purposes and advantages.

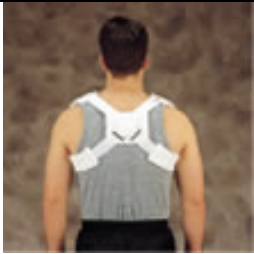
Table 5 - Shoulder Orthoses

| Name of Orthosis | Main Function/ Purpose | Additional Advantages | Diagram |
|-------------------------|---|--|--|
| Clavicle Strap | -offers support for clavicle fractures and postural dysfunction -Figure-8 design restrains abduction and allows for tissue healing and bone remodeling | -adjustable fit due to canvas straps with hook and loop closures |  |
| Shoulder Orthosis | -offers greater support for clavicle fractures and postural dysfunction | -provides alignment of the glenohumeral joint for functional healing of shoulder ligaments |  |
| Shoulder Immobilizer | -keeps glenohumeral joint from susceptible injury following rotator cuff surgery -Utilizes Figure-8 design | -retains the glenohumeral joint in an internally rotated position |  |

1.8.1.3 Backpacks

A backpack is a familiar technology that is used to support loads on the body. Each backpack manufacturer aims to ease the burden of carrying heavy loads by generating different modes of distributing the load, suspending the load, and relieving user discomfort. The main features on a back pack are the material, sternum strap, waistbelt or hipbelt, top risers or load lifters, hip stabilizers, compression straps, shoulder harnesses, pack length adjustability, and suspension system (Table 6)(Figure 16). Most of the materials used on backpacks are geared toward breathability, durability, and protection from environmental elements.

Table 6- Backpack Technology

| Feature | Goal | Key Aspects of Feature |
|-------------------------|---|---|
| Sternum straps | to connect the shoulder harnesses across the user's chest | -adjusts both horizontally (to tighten or loosen the strap) as well as vertically (to optimize chest positioning) -maximizes stability of the pack across the shoulders while maintaining shoulder mobility |
| Waist/Hip-belts | for supporting heavier loads | -keep the pack steady on the user's hips and minimize shifting while moving -assume much of the pack's weight when fitted properly by transferring the load from the shoulders to the more stable hips -can be gender-specific |
| Top risers/load lifters | to lift or lower the load via adjustment straps | -transfer load onto the muscles of the back on ascents, and then redistribute the load to the hips for stability and comfort during normal use -eliminates excess strain on the shoulder muscles by pulling the shoulder down and back |
| Shoulder harness | to bear the load | -thermoformed ergonomic design that mimics the curves of the body |
| Suspension system | to give the pack structure | -balances the load between the user's hips, keeping the pelvis even during use |

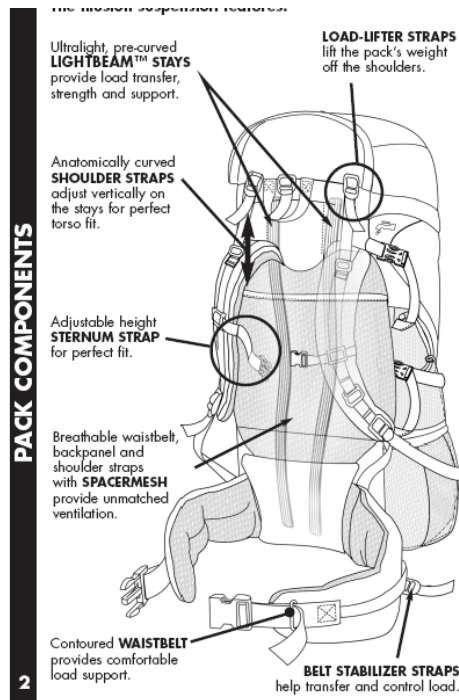

Figure 16 - Kelty™ Illusion Backpack

1.8.1.4 Baby Carriers

The aforementioned backpack designs were designed with versatility in mind; accommodating large, heavy loads, as well as smaller, lighter loads. Baby carriers, however, have only one main function – to carry similarly sized and shaped babies. Therefore, while backpacks are complex designs for carrying a wide variety of items, baby carriers remain relatively simple in design.

Backpack-based baby carriers use a double shoulder support along with a lower back belt. They can be worn either on the front or back of the user and the child can be either inward or outward facing, supporting up to 26 pounds. (“Snugli City Sport Soft Carrier,” 2005).

Sling based carriers are essentially lengths of fabric that are tied off, with an O-ring used to shape the material, Figure 17. Babies are carried on the front of the body in a hammock shaped section of fabric. Typically, babies are placed horizontally, or at a slight angle, similar to the position a mother might cradle a child. The O-ring gathers material together near the head of the baby to narrow the length of fabric that is slung over the user’s shoulder. Weight is distributed over one shoulder and the back. The wider the fabric, the larger the area over which the baby’s weight is distributed (Baby Slings Over the Shoulder Baby Holder,” 2000).



Figure 17 - Over The Shoulder Baby Holder - Sling Style
©Amazon.com

Baby carriers lack the technological complexity of backpacks and offer a wide variety of cosmetic appearance. Slings look more like an article of clothing, and are less

noticeable than most backpacks. The market for slings is similar to the market for body mounting devices in that people covet more inconspicuous designs.

1.8.2 Joint Exploration

To enable full range of motion in the proposed Shoulder Mount, various joints used in everyday products were explored for enhanced design development.

1.8.2.1 Space & Deep Sea Suits

The human body is accustomed to being on Earth where there is a standard atmospheric pressure. However, when venturing into the absence of pressure in space, or down to the depths of the sea where significant pressure change occurs, it is necessary to simulate an environment in which a human can function in the normal range of motion. To attain this artificial environment, special suits, generally termed “pressure suits” have been developed. Some joints that mimic range of motion in the body can be found in the neck, shoulders, elbows, wrists, waist, thighs, and ankles of the pressure suits.

There are three different types of diving suits that withstand high pressure: hard-shell, mixed, and skin tight (“Scuba Diving”, 2006). Hard-shell units, similar to suits of armor, act as an exoskeleton, with external joints. These are typically older suits or deep water, where the “helmet” portion has extra room for the neck to rotate and head to move, the shoulder portions are concentric cylinders that can rotate, and knee and elbow joints are simple hinge joints. Skin tight suits apply a particular pressure to the body that act like a second skin while supporting joint movement. These suits are made of more modern materials that stretch, while remaining waterproof. The purpose of these suits is to protect the body, while accommodating the user’s full range of motion. The user cannot obtain a greater range of motion than his/her normal, but the devices do not greatly inhibit the range of motion.

Space suits are typically “baggy”, which means that the suit functions to regulate pressure but fits largely on the user and is soft material that allows for flexing of joints. It is analogous to wearing an oversized one-piece suit with a helmet (“Space Suit”, 2006).

One of the key aspects of these suits with respect to joint movement is simplicity; the fewer devices involved in joint movement, the less chance there is for failure or

inhibiting the range of motion. These devices can be donned, covering the entire body, without inhibiting the normal range of motion of the user.

1.8.2.2 Joystick Configurations

The design of an analogue joystick design allows for motion in two axes, the x -axis, left to right, and the y -axis, up and down. In the standard joystick design, Figure 18, the handle moves a narrow rod that sits in two slotted shafts that rotate. Tilting the stick forward and backward pivots the ‘ Y -axis’ shaft from side to side. Tilting it left to right pivots the ‘ X -axis’ shaft. When one moves the stick diagonally, it pivots both shafts.

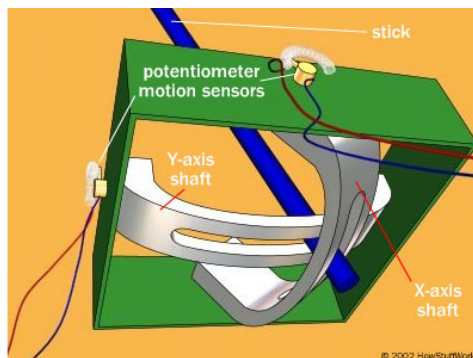

Figure 18 - Conventional Joystick Design

©2002 HowStuffWorks.com

Joystick configurations allow for two degrees of freedom, whereas the glenohumeral joint allows for three. To fully mimic the shoulder joint in the development of a proposed Shoulder Mount, a third degree of freedom would need to be integrated. This could be achieved by adding a rotational degree of freedom about the joystick’s axis.

Investigating the technology of everyday objects provides an insight to the appearance and functions of both harnessing systems and joints. Incorporating this existing technology in a Shoulder Mount will allow for enhanced improvements and the ability to replicate anatomical features *ex vivo*.

1.9 Identification of Functions

For a universal Shoulder Mount to be considered “successful”, that is, to fully meet the expectations of a proposed user, the device must provide distribution of both applied loads and the forces from the device itself across the body. Current prostheses designs can almost fully restore a user’s natural range of motion, but are limited in their

ability to carry high loads. Harnessing systems for upper-arm prosthesis attachment can be manufactured to withstand higher axial and/or torsional loads. However, the combined use of a harnessing system with a prosthesis can restrict the user's full range of motion.

The proposed Shoulder Mount device should incorporate three primary functions:

1. improve the tensile load carrying capacity (forces acting along the axis of the humerus)
2. improve the torsional load carrying capacity (moments acting about the humeral axis)
3. maintain range of motion (RoM) necessary for performing activities of daily living (ADLs)

Current prostheses and attachment devices (e.g. vacuum suction, strapping, etc.) do not satisfy all three of the outlined functions.

Common activities that a transhumeral prosthesis user may encounter on a daily basis are referenced in Table 7. The second column describes the primary function (1, 2, or 3) that the device must be able to perform in order to complete the task. The third column describes the position of the shoulder, humerus, and/or arm during the task.

Table 7 - Identification of Functions

| Activity | Function(s) Needed | Arm Position |
|--|---------------------------|---|
| Lifting a 60 lb suitcase | 1 | Forearm is in line with humerus pointing toward ground, arm lies in frontal plane, parallel to mid-sagittal plane |
| Carrying a 40 lb box | 1 | Elbow bent to 90°, forearm parallel to ground, humerus lies in frontal plane, humerus parallel to sagittal plane. |
| Pulling a door open | 1 | Forearm parallel to ground, humerus makes some angle (theta) with the horizontal, arm is parallel to the sagittal plane. |
| Eating/grooming | 3 | Shoulder abducted (both vertically and horizontally) and flexed so that distal end of prosthesis can be manipulated around the user's head. |
| Reaching a high shelf (above the head) | 3 | Shoulder vertically abducted and/or flexed through a range of motion that brings the user's hand above the head. |
| Holding a glass in front of your mouth (2 lbs) | 2 | Elbow bent at some angle (theta), arm abducted and parallel to ground, forearm parallel to frontal plane |

Note: Function 3 (range of motion) is necessary in all of the above activities; however, for those activities where function 3 is not the predominant function utilized, it was not included in the chart.

II. GOAL STATEMENT

The goal of this project was to design, analyze, manufacture, and test a wearable device that will serve as a secure mount for a prosthesis worn by a trans-humeral amputee. The device must enable a range of motion in the shoulder that does not inhibit activities of daily living. Through the prosthesis and thus the device, the user should be able to apply 60 pounds of force acting axially on the humerus and 25 foot-pounds of torque acting torsionally on the humerus. These loading conditions are independent of arm orientation and position.

III. DESIGN SPECIFICATIONS

The primary functions of the proposed Shoulder Mount device were further defined into specific and measurable quantities, categorized into six design specifications: (1) Performance, (2) Safety, (3) User Friendliness, (4) Reliability, (5) Cost, and (6) Production. In each category, task specifications were presented in “must/ should/ could” statements; that is, what the device *must* be accountable for, what the device *should* incorporate, and what the device *could* possess. The choice of the preliminary design, as well as the continued success of the final device is determined by the degree to which the design specifications are fulfilled.

(1) Performance

The device must fulfill functional requirements

The important factors associated with the performance of the device considered for evaluation include the accommodation of various types of prostheses, effect of device on required work to function, stability of the device, range of motion, load distribution of the device on the body, load capacity, and the ability to perform activities of daily living.

○ ***Interface with Existing Prostheses***

- Device must accommodate the use of the following assistive devices:
 - Prostheses
 - Passive
 - Active

○ ***Effect on Required Work***

- Device must weigh less than 10.0 pounds
 - Device should weigh less than 8.0 pounds
- Device should not “bind” at any location, causing movements to require extra force

○ ***Stability***

- Device must remain stable on the user’s body while holding 10 pound weight in full range of motion in the shoulder joint (static stability)

- ***Range of Motion***
 - Device must not impede the user's "normal" range of motion
 - Shoulder joint should rotate at user's full range of motion
 - Device should enable shoulder flexion up to user's current range of motion
 - Device should enable shoulder abduction up to user's current range of motion
- ***Load Distribution***
 - Device must not have point loads higher than 300 mm Hg (Reswick and Rogers, 1976)
 - Device should distribute weight of itself and prosthesis over large area of body
 - Minimize force by maximizing the area to decrease pressure, taking into account the area of the supporting material (straps & shoulder piece).
 - Device must distribute forces to prevent pressure sores or discomfort
 - The center of mass of the device should be as proximal to the centerline of the body as possible to decrease moment about shoulder joint
- ***Activities of Daily Living***
 - Device must not inhibit range of motion as to prevent activities of daily living from being performed
- ***Load Capacity***
 - The device must withstand 60 pounds applied axially
 - The device must withstand 30 ft-lb of torque about any axis

(2) Safety

The device must not harm the user.

Two safety factors considered are the sharp edges and pinch points of the device. These points must be minimized to maximize safety. Additionally, locations of high forces, where pressure sores can form, must be evaluated as a measure of safety.

- *Edges*
 - Device must not puncture skin
 - Device should have no edge that may tear clothing
- *Minimize Pinch Points*
 - Device should not have any pinch points that could harm the user during movement
- *Minimize Pressure sores*
 - Pressure on the skin must not exceed pressures of 300 mm Hg

(3) User Friendliness

The device must accommodate the needs of a wide-range of users.

Adjustability of the device to the various sizes of humans is key in making the device nearly universal to 5th-95th percentile adults. Additionally, aspects such as don/doff ease, limiting irritability to skin, enabling ease of storage, and enhanced aesthetics contribute to the user-friendliness of the device.

- *Adjustability*
 - Device must accommodate males and females from 5th-95th percentiles
 - Device could be worn by persons with total arm diameter from 5th – 95th percentile adults
 - Torso components of the device must accommodate 5th – 95th percentile adults
- *Don/Doff Ease*
 - Device should be “easy” to don/doff by user
 - User should be able to be don/doff device in under 2 minutes.
 - Device could be donned/doffed with no outside aid
- *Non-irritating to Skin*
 - The components that contact the skin must not be abrasive or inhibit rash or irritation
 - Material that contacts the skin should be breathable to minimize moisture buildup

- *Aesthetics*

- The device should be slim fitting and not significantly increase the person's frame size.
 - The appearance of the device could be customizable so that it would be indistinguishable from the user's clothes or skin.
- Device components should not create noise during operation

(4) Reliability

The device should have a competitive lifetime to other products in the market.

If the device does not withstand repetitive use, then purchasing the device becomes less desirable. Therefore, factors such as overall lifetime, shock resistance, and the ability to clean the device should be examined.

- *Fatigue Resistance*

- The device must have a lifetime of 2-3 years to be cost-effective for consumers.
 - The device should have a minimum lifetime of 12-24 months under normal daily use conditions

- *Shock Resistant*

- Device must be made of a durable material

- *Washable*

- Device could be washable

- *Sweat and Performance*

- Sweating must not affect performance of the device

(5) Cost

The device must have a competitive cost relative to comparable devices on the market.

The cost of the materials, manufacturing, and maintenance of the device should all lie within reasonable current prices for attachment systems. The cost of materials and manufacturing should not fall above \$800, as outlined in the WPI MQP Budget.

- *Materials*

- The total device materials should cost less than \$400
- ***Manufacture***
 - The device could be manufactured for under \$400
- ***Maintenance***
 - Materials to maintain device should be under \$100/year
 - Any scheduled maintenance should be able to be provided by a practicing prosthetist.
 - Components of the device must be detachable as to allow for selective maintenance on the parts.

(6) Production

The device must be manufactured and reproducible with reasonable time and effort so that it is marketable

With clear drawings, simplified parts, and assembly procedures, the reproducibility of the device can be examined.

- ***Ease of Manufacture and Assembly***
 - Device must use simple and existing parts to improve ease of manufacture

3.1 Selection Matrix

The task specifications are the criteria that any design idea must fulfill in order to have success and to ultimately achieve the goal statement. To determine how well each concept will live up to these specifications, a scientific approach was needed. Thus, a selection (design) matrix was created. The selection matrix functions as a means to mathematically compute: (1) the degree to which the design specifications are fulfilled by each design and (2) the weight of each design idea compared to the other designs.

3.2 Matrix Organization

A system was setup such that the summation of the major Task Spec Categories adds to one: (Performance weight + Safety weight+ User Friendliness weight + Reliability weight + Cost weight + Production weight =1). This method weighs the value of each category relative to others. Performance (0.3) and safety (0.2) were chosen as the top two categories because they are the most essential specifications to create a

successfully working and usable device. The device must function and not harm the user; otherwise, the design is not practical. User friendliness and reliability were weighted in the middle (each 0.15), as these are not the most crucial concerns to the success of the device, but are important if the device was to go on the market. Cost and production had the lowest weights, as these were not the main focus of the project—they were secondary issues.

Within these Task Spec Categories are sub-categories. These sub-categories were taken directly from the setup of the initial Task Specifications. As they were created, a pattern formed whereby natural sub-categories were created under the categories. This provides for better organization and clarity.

Figure 19 provides an example of how the weights are setup in a matrix (Category weights in bold font).

| Categories | Weight | Design 1 | | Design 2 | |
|---------------------------------------|-------------|----------|----------|----------|----------|
| | | Score | Wtd. Sc. | Score | Wtd. Sc. |
| Performance | 0.3 | | | | |
| Interface with existing pros/orth | 0.1 | | | | |
| Effect on Required Work | 0.075 | | | | |
| Stability (+) | 0.2 | | | | |
| Range of motion (+) | 0.15 | | | | |
| Load Distribution (+) | 0.2 | | | | |
| Facilitate activities of daily living | 0.075 | | | | |
| Load Capacity (+) | 0.2 | | | | |
| Sub-Total: | 1 | | | | |
| Safety | 0.2 | | | | |
| No sharp edges (-) | 0.5 | | | | |
| Minimize pinch points (-) | 0.5 | | | | |
| Sub-Total: | 1 | | | | |
| User Friendliness | 0.15 | | | | |
| Don/Doff Ease (+) | 0.2 | | | | |
| Ease of storage | 0.05 | | | | |
| Ease of Maintenance (-) | 0.1 | | | | |
| Adjustability (+) | 0.2 | | | | |
| Breathability (+) | 0.15 | | | | |
| Non-irritating to skin (+) | 0.15 | | | | |
| Aesthetics (+) | 0.15 | | | | |
| Sub-Total: | 1 | | | | |
| Reliability | 0.15 | | | | |
| Shock Resistant (+) | 0.4 | | | | |
| Washable (+) | 0.1 | | | | |
| Sweat and Performance | 0.2 | | | | |
| Fatigue Resistance (+) | 0.3 | | | | |
| Sub-Total: | 1 | | | | |
| Cost | 0.05 | | | | |
| Materials (-) | 0.4 | | | | |
| Manufacture (-) | 0.4 | | | | |
| Maintenance costs (-) | 0.2 | | | | |
| Sub-Total: | 1 | | | | |
| Production | 0.15 | | | | |
| Ease of Manufacture (+) | 0.5 | | | | |
| Ease of Assembly (+) | 0.5 | | | | |
| Sub-Total: | 1 | | | | |
| TOTAL | 1 | | | | |

Figure 19 - Design Selection Matrix

Within each category, the weight of the sub-categories was also determined. For example, under the Performance Category, “Stability”, “Load Distribution”, and “Load Capacity” were rated the highest. This means they are the most important aspects of the

device within this category, and contain the most important task specifications to consider. The weight of these sub-categories all add up to one, as displayed in Figure 20:

| Performance | 0.3 |
|---------------------------------------|------------|
| Interface with existing pros/orth | 0.1 |
| Effect on Required Work | 0.075 |
| Stability (+) | 0.2 |
| Range of motion (+) | 0.15 |
| Load Distribution (+) | 0.2 |
| Facilitate activities of daily living | 0.075 |
| Load Capacity (+) | 0.2 |
| Sub-Total: | 1 |

Figure 20- Performance Sub-categories

IV. DESIGN SELECTION

With the goal statement and task specifications in mind, research and conception of probable solutions was undertaken. The combination of background research and brainstorming led to the development of design concepts. These potential solutions were drawn and discussed, entered into the selection matrices by each group member, then compared as a group. This process is detailed below:

4.1 Design Concepts

After some preliminary brainstorming, it was determined that any design concept could be divided into three main components: (1) Exoskeletal shoulder joint, (2) Harness/Strapping system, and (3) Device/Prosthesis interface. These three categories were chosen from a preliminary brainstorming session, as they were determined to be three reoccurring design components during brainstorming sessions. In fact, many design ideas came as one complete “solution” to the problem, yet the design components had to be separated to give each component fair and appropriate consideration. Thus, the parameters of each design idea category were outlined. These are the functions of the three components:

(1) Exoskeletal Shoulder Joint: The shoulder joint component mimics the glenohumeral joint movement without using an internal ball and socket, while allowing the humerus to move throughout the user’s normal range of motion. The shoulder joint component would further serve as a transitional sub-assembly between the harness and the device/prosthesis interface.

(2) Harness/Strapping system: The purpose of the harnessing system is to act as a mounting system for the shoulder joint, as well as enabling greater pressure distribution resulting from the weight and usage of the device.

(3) Device/Prosthesis interface: The arm interface serves as the connection point between the residual limb, prosthesis and/or orthosis, and the attachment mounting device. This should not inhibit the natural movement of the residual arm.

Thus, the three categories were established and the design concepts were put into the appropriate category. The design concepts were as follows, each with a description and a picture.

4.1.1 Exoskeletal Shoulder Joint

I - Gimbal Joint

Modeled after a conventional analog joystick design, the gimbal joint allows for motion in two axes, the x-axis, left to right, and the y-axis, up and down. When the stick is moved diagonally, it pivots both axes. Adapting this concept to be translated to the human body, the user would serve as the 'stick' in Figure 21, extending his/her arm through the device.

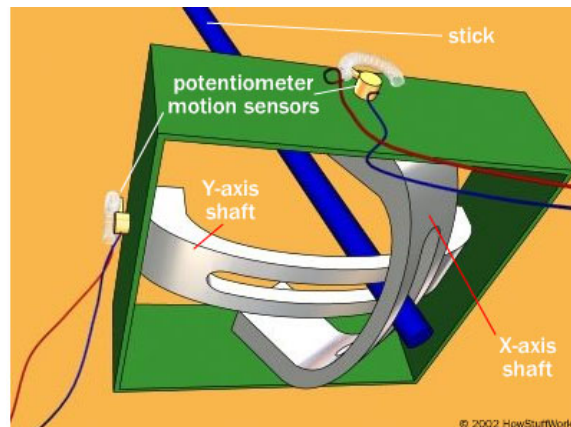

Figure 21- Conventional Analog Joystick Design (c) 2002 HowStuffWorks.com

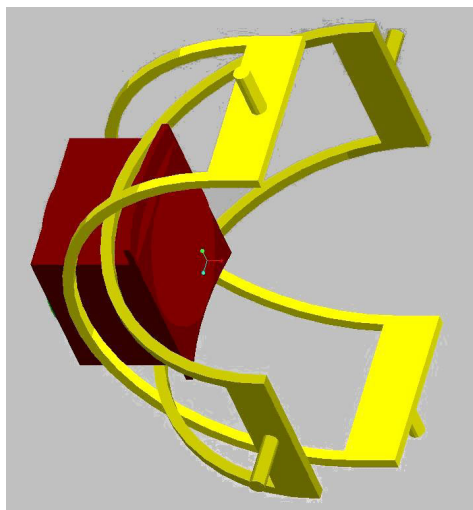

Figure 22- Joystick Design/ Gimbal Joint

The same motions required to power the conventional analog joystick would be performed by the user, allowing for multi-range motion. The yellow gimbal arms (Figure 22) encompass the users shoulder joint and are attached to a platform harness. Each axis is free to rotate independently of one another.

II - L-Bracket Pin Joint

This design is comprised of two pieces: an L-shaped piece and a straight piece. The proximal hole of the L-bracket pivots as a pin joint about the x-axis (Figure 23) and the straight piece would rotate about a pin joint lined up with the z-axis. The straight piece can be extended down the residual arm to connect to an arm-interface.

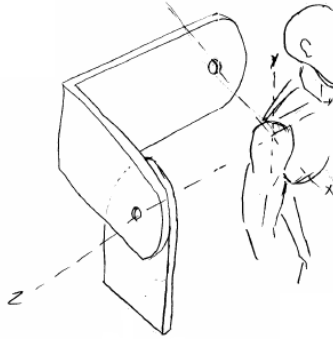

Figure 23- L-bracket Pin Joint Aligned with the Body

III - Ferromagnetic Shoulder Sheath

An alternative to a designing a purely biomechanical solution, is to incorporate another source of force, such as magnetic force. A ferromagnetic sheath, or enveloping structure, could sit on the shoulder (Figure 24). It would be composed of pliable tubes filled with ferromagnetic liquid. The liquid exhibits the ability to exist in two states, liquid and solid. When in a liquid state, the sheath would not inhibit movement in the shoulder. However, when the user wanted the shoulder to lock in position, a power supply that can be manually turned on/off will solidify the liquid and freeze movement in the shoulder. One end of the sheath is attached to the harness from above and the other piece is attached to an arm interface.

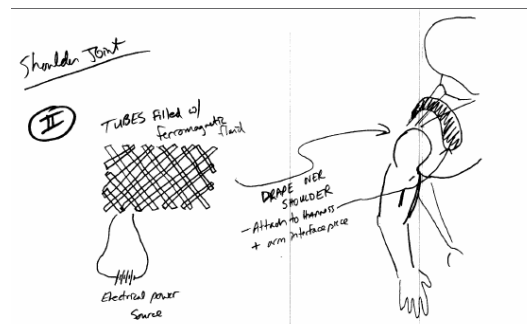

Figure 24- Ferromagnetic Sheath

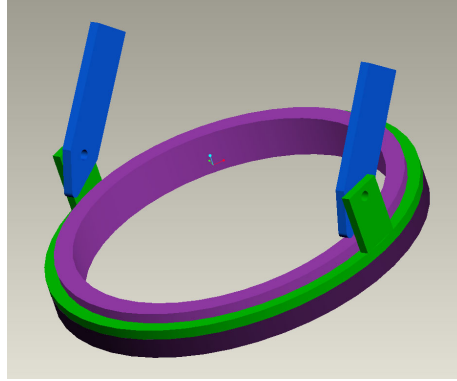

Figure 26- Locking Rings

VI - Modified One-Track Gimbal Joint

A simplified version of the gimbal joint was constructed in an effort to diminish additional and unnecessary material weight created by the first gimbal design. Figure 27 represents a version where one of the gimbal arms has been removed. The degree of freedom of the lost gimbal arm is replaced by a track system that serves to guide the brown “arm guide”, as well as two pin joints at the shoulder connected to a harness. The design is simple and can provide a secure connection to the device/prosthesis interface.

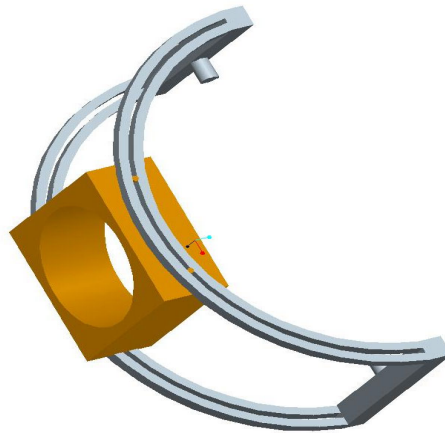

Figure 27- Modified Gimbal Joint

4.1.2 Harness/ Strapping System

1 - Backpack-style

The first harness design utilizes the backpack technology discussed in the Background. Weight distribution of the applied load would be dispersed from the body mount and throughout the user's back. It consists of two main parts: a solid, rigid back plate that is anatomically customized to match the shape of the user's back and a strapping system that straps the plate to the user's torso in the same fashion that a backpack is attached, two shoulder straps and a waist belt, Figure 28.

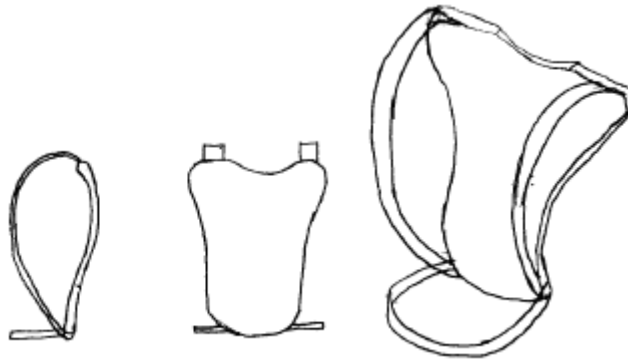

Figure 28- - Backpack-style Harness; Side and Back Views

Due to the composition of the back plate, it will function as a solid platform from which to attach the other pieces of the design.

2 – Shoulder Plate with Waist-belt

This design utilizes a rigid shoulder piece, which would be affixed to the user by a two-strap, front and back, connect that attaches to a waist-belt (Figure 29).

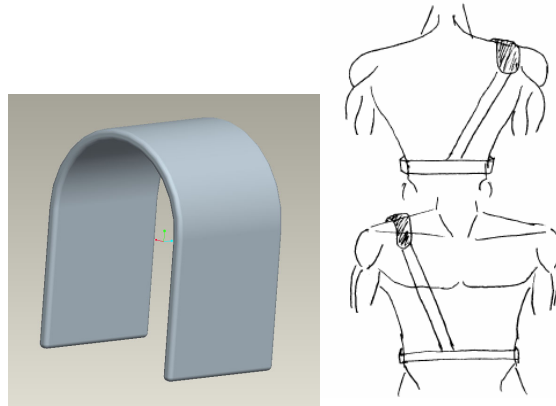

Figure 29- - Solid Shoulder Plate affixed to Asymmetrical Strapping

The diagonal strapping system is designed to translate the load transversely across the body. Backpack technology was incorporated in the application of a waist belt, where the front and back straps would meet. This waist belt would further bear the load that the user would be lifting as to not place excessive pressure on the ribcage.

3 – Double-Nine

The Double-Nine harness utilizes the same rigid piece as Design 2 with a slight modification- an extra L-shaped bend in the piece was added to allow for the connection of a pin joint at the shoulder joint. The attachment of the rigid piece is affixed to the user via two 9-harnesses, Figure 30.

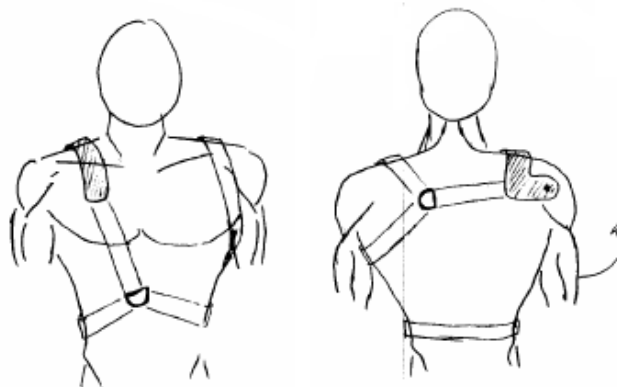

Figure 30- Front and Back View of the Double-Nine Harness

The harness works as a series of loops that the user can easily don and doff. One loop sits around the opposite shoulder from the fixation plate and the other around the waist.

4 - Double armpit

The modified rigid piece from the ‘Double-Nine Harness’ is present with a harnessing system designed to attach underneath the armpits of the user (Figure 31).



Figure 31- L-shaped Rigid Support with Under-armpit Harness

This design eliminates the need for the user having to manipulate the opposing arm through a loop around the shoulder, as in the ‘Double-Nine’. This design would also translate the force of the applied load up higher on the back and chest.

5 - Double-X Yoke

Incorporating both agricultural technology and extending the modified shoulder plate from Design 3, a large solid piece that extends across both shoulders would serve as the platform, Figure 32.

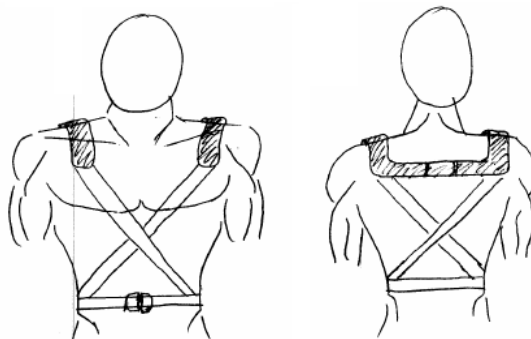

Figure 32- Front and Back View of Yoke Design

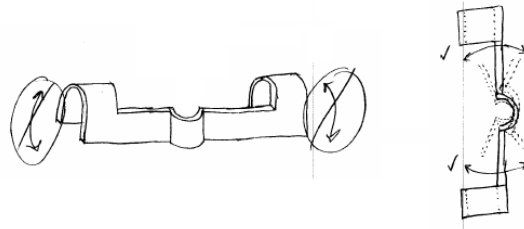

Figure 33- Isolated Yoke Design Back View (left) and Top View (right)

The design of the “yoke”, Figure 33, would increase stability while allowing for one degree of freedom about a vertical axis that extends through the center of the device. The harness is attached to the user via 4 straps that extend down to a waist belt to hold the yoke in place.

6 - Vest

Modeled after the personal floatation device, the Jacket/Vest harness would use a vest design, with which the shoulder axis can be mounted upon. A general overview of what it might look like is shown in Figure 34.

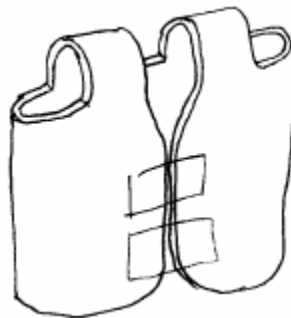

Figure 34- Jacket/Vest Harness

In combination with an inside lined with high friction, possibly silicone layer and assuming the vest could be built to accommodate different chest and waist sizes, the design should provide a stable platform from which to build and attach the other components.

7 - Corset

Orthopedic corsets are worn in certain spinal injuries or deformities, where the spinal orthosis surrounds part or the entire trunk to support and align the vertebral column (“Corset”, 2005). The device is also used in preventing movement following trauma. Due to the form-fitting nature of the corset, it would be able to accommodate a wide range of

users due to unique adjustability all along the torso. The large surface area of the corset would serve as a stable platform from which to apply the other components of the shoulder mount, Figure 35.



Figure 35- Corset Harness © www.durrettsoandp.com

8 - Double Armpit with Torso Belt

The ‘Double Armpit Harness with Torso Belt’ incorporates the ‘Double Armpit’ design, with both the ‘Double-Nine Harness’ and the rigid shoulder plate. The addition to this design is a belt affixed around the user’s torso, which extends horizontally to increase stability. Figure 36



Figure 36- Double Armpit Harness with Torso Belt

9 –Harness with Torso Belt

The L-shaped bracket design (Figure 37) includes plastic shoulder plate that fits over the shoulder and snugly against the side of the body. The strapping includes a horizontal strap that goes around the body. This design is simple, and will provide a stable mounting system for the device.



Figure 37 - Harness with Torso Belt

4.1.3 Prosthesis/Arm Interface

(A) – Concentric Cylinders

The concentric cylinder design involves an inner cylinder, arm strap, and an outer cylinder. To wear this assembly, the user inserts the prosthesis in the inner cylinder, tightens the arm strap inside of the cylinder (Figure 38) so that the prosthesis is tightly fitted in the cylinder. This cylinder screws into the portion of the arm interface that interacts with the movable shoulder joint. Lastly, an outer cylinder is placed on the outside to protect the prosthesis.

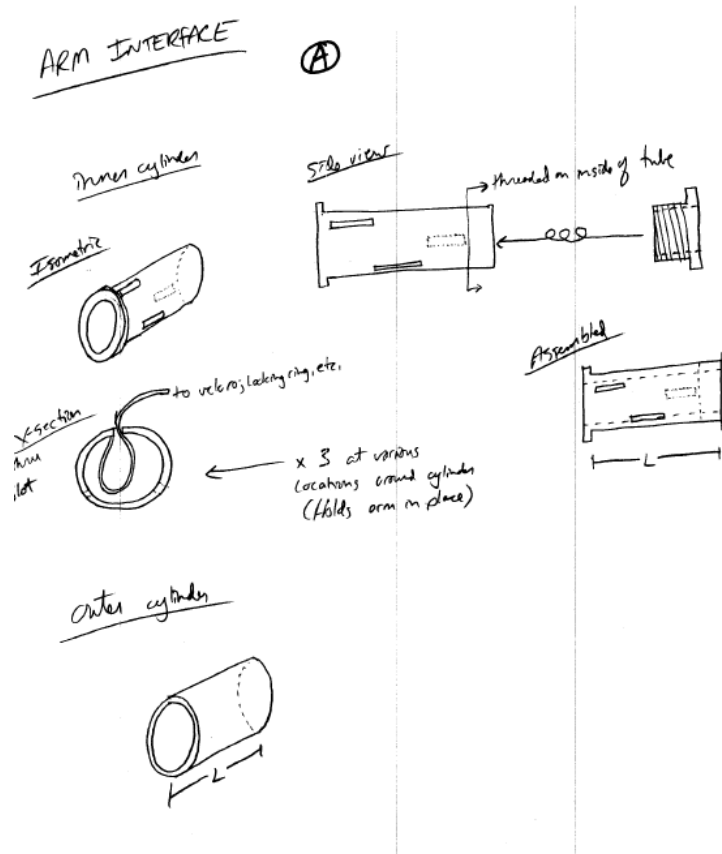

Figure 38- Concentric Cylinder Sketch

(B) – Rotational Bearing

This design (Figure 39) involves a bearing that the prosthesis can be solidly attached to, such that the prosthesis rotates at the same angle as the bearing. It would be manufactured inside of a device connected to the shoulder joint, thus the prosthesis could attach and rotate along with the bearing. The prosthesis would be attached to this piece

via a secure connection, such as thin four brackets or screws. It is a simple design that will interface with many of the proposed exoskeletal shoulder joint design options.

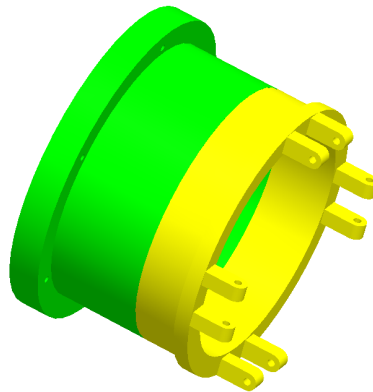

Figure 39 – Rotational Bearing

4.2 Use of Matrix selection charts

4.2.1 Design Rating

With the task specifications established, the selection matrix compiled for weighing, and the design concepts clearly explained, the next step was to enter the designs into the matrix. Three separate matrices, each identical in form, were set up for the three design categories: (1) Exoskeletal shoulder joint, (2) Harness/Strapping system, and (3) Device/Prosthesis interface.

Each group member rated the designs separately, according to the following ranking system ranged from integer values of 1 to 5 (5 being the best):

- 5- Greatly functions in this category (greatly exceeds most task specifications)
- 4- Good function in this category (meets/ exceeds most task specifications)
- 3- Moderate function in this category (meets most task specifications)
- 2- Fair function in this category (meets some task specifications)
- 1- Poor function in category (meets few task specifications)

In order that the designs could be not only weighed, but compared to each other, each design was assigned a Roman numeral, number, or letter. The designs were then placed in the matrix side-by-side (in columns), designated at the top by the appropriate title.

The integer value of 1-5 would go under the score columns. To compute a weighted score, that integer would be multiplied by the weight. These values could be summed and compared. The completed Design Matrices for all team members can be

found in Appendix M – Completed Selection Matrices. An example of completed matrices can be found in Figure 40.

| Shoulder Joint | | | | | | | |
|---------------------------------------|-------------|-------|--------------|-------|---------------|-------|---------------|
| Criteria | Weight | I | | II | | III | |
| | | Score | Wtd. Sc. | Score | Wtd. Sc. | Score | Wtd. Sc. |
| Performance | 0.3 | | | | | | |
| Interface with existing pros/orth | 0.1 | 5 | 0.15 | 3 | 0.09 | 2 | 0.06 |
| Effect on Required Work | 0.075 | 4 | 0.09 | 2 | 0.045 | 1 | 0.0225 |
| Stability (+) | 0.2 | 3 | 0.18 | 5 | 0.3 | 1 | 0.06 |
| Range of motion (+) | 0.15 | 4 | 0.18 | 5 | 0.225 | 1 | 0.045 |
| Load Distrib. (+) | 0.2 | 3 | 0.18 | 2 | 0.12 | 1 | 0.06 |
| Facilitate activities of daily living | 0.075 | 4 | 0.09 | 4 | 0.09 | 2 | 0.045 |
| Load Capacity (+) | 0.2 | 1 | 0.06 | 3 | 0.18 | 2 | 0.12 |
| Sub-Total: | 1 | | 0.93 | | 1.05 | | 0.4125 |
| Safety | 0.2 | | | | | | |
| No sharp edges (-) | 0.5 | 3 | 0.3 | 4 | 0.4 | 2 | 0.2 |
| Minimize pinch points (-) | 0.5 | 2 | 0.2 | 3 | 0.3 | 1 | 0.1 |
| Sub-Total: | 1 | | 0.5 | | 0.7 | | 0.3 |
| Use Friendliness | 0.15 | | | | | | |
| Don/Off Ease (+) | 0.2 | 2 | 0.06 | 2 | 0.06 | 1 | 0.03 |
| Ease of storage | 0.05 | 5 | 0.0375 | 1 | 0.0075 | 2 | 0.015 |
| Ease of Maintenance (-) | 0.1 | 3 | 0.045 | 2 | 0.03 | 2 | 0.03 |
| Adjustability (+) | 0.2 | 3 | 0.09 | 3 | 0.09 | 3 | 0.09 |
| Breathability (+) | 0.15 | 4 | 0.09 | 2 | 0.045 | 3 | 0.0675 |
| Non-irritating to skin (+) | 0.15 | 5 | 0.1125 | 2 | 0.045 | 3 | 0.0675 |
| Aesthetics (+) | 0.15 | 2 | 0.045 | 4 | 0.09 | 1 | 0.0225 |
| Sub-Total: | 1 | | 0.48 | | 0.3675 | | 0.3225 |
| Reliability | 0.15 | | | | | | |
| Shock Resistant (+) | 0.4 | 3 | 0.18 | 1 | 0.06 | 2 | 0.12 |
| Washable (+) | 0.1 | 2 | 0.03 | 1 | 0.015 | 1 | 0.015 |
| Sweat and Performance | 0.2 | 3 | 0.09 | 2 | 0.06 | 3 | 0.09 |
| Fatigue Resistance (+) | 0.3 | 3 | 0.135 | 1 | 0.045 | 2 | 0.09 |
| Sub-Total: | 1 | | 0.435 | | 0.18 | | 0.315 |
| Cost | 0.05 | | | | | | |
| Materials (-) | 0.4 | 3 | 0.1 | 1 | 0.02 | 3 | 0.06 |
| Manufacture (-) | 0.4 | 4 | 0.08 | 1 | 0.02 | 3 | 0.06 |
| Maintenance costs (-) | 0.2 | 4 | 0.04 | 2 | 0.02 | 2 | 0.02 |
| Sub-Total: | 1 | | 0.22 | | 0.06 | | 0.14 |
| Production | 0.15 | | | | | | |
| Ease of Manufacture (+) | 0.5 | 3 | 0.075 | 2 | 0.05 | 3 | 0.075 |
| Ease of Assembly (+) | 0.5 | 2 | 0.05 | 1 | 0.025 | 2 | 0.05 |
| Sub-Total: | 1 | | 0.125 | | 0.075 | | 0.125 |
| TOTAL | 1 | | 2.69 | | 2.4325 | | 1.615 |

| Harness | | | | | | | |
|---------------------------------------|-------------|-------|---------------|-------|---------------|-------|---------------|
| Criteria | Weight | 1 | | 2 | | 3 | |
| | | Score | Wtd. Sc. | Score | Wtd. Sc. | Score | Wtd. Sc. |
| Performance | 0.3 | | | | | | |
| Interface | 0.1 | 4 | 0.12 | 3 | 0.09 | 3 | 0.09 |
| Effect on Required Work | 0.075 | 4 | 0.09 | 3 | 0.0675 | 4 | 0.09 |
| Stability (+) | 0.2 | 4 | 0.24 | 2 | 0.12 | 4 | 0.24 |
| Range of motion (+) | 0.15 | 2 | 0.09 | 5 | 0.225 | 3 | 0.135 |
| Load Distrib. (+) | 0.2 | 4 | 0.24 | 2 | 0.12 | 3 | 0.18 |
| Facilitate activities of daily living | 0.075 | 2 | 0.045 | 2 | 0.045 | 2 | 0.045 |
| Load Capacity (+) | 0.2 | 4 | 0.24 | 2 | 0.12 | 3 | 0.18 |
| Sub-Total: | 1 | | 1.065 | | 0.7875 | | 0.96 |
| Safety | 0.2 | | | | | | |
| No sharp edges (-) | 0.5 | 5 | 0.5 | 5 | 0.5 | 5 | 0.5 |
| Minimize pinch points (-) | 0.5 | 4 | 0.4 | 4 | 0.4 | 3 | 0.3 |
| Sub-Total: | 1 | | 0.9 | | 0.9 | | 0.8 |
| Use Friendliness | 0.15 | | | | | | |
| Don/Off Ease (+) | 0.2 | 4 | 0.12 | 4 | 0.12 | 3 | 0.09 |
| Ease of storage | 0.05 | 4 | 0.03 | 4 | 0.03 | 4 | 0.03 |
| Ease of Maintenance (-) | 0.1 | 5 | 0.075 | 4 | 0.06 | 4 | 0.06 |
| Adjustability (+) | 0.2 | 4 | 0.12 | 4 | 0.12 | 4 | 0.12 |
| Breathability (+) | 0.15 | 3 | 0.0675 | 5 | 0.1125 | 4 | 0.09 |
| Non-irritating to skin (+) | 0.15 | 3 | 0.0675 | 4 | 0.09 | 4 | 0.09 |
| Aesthetics (+) | 0.15 | 1 | 0.0225 | 3 | 0.0675 | 3 | 0.0675 |
| Sub-Total: | 1 | | 0.5025 | | 0.6 | | 0.5475 |
| Reliability | 0.15 | | | | | | |
| Shock Resistant (+) | 0.4 | 3 | 0.18 | 2 | 0.12 | 4 | 0.24 |
| Washable (+) | 0.1 | 5 | 0.075 | 4 | 0.06 | 4 | 0.06 |
| Sweat and Performance | 0.2 | 3 | 0.09 | 4 | 0.12 | 4 | 0.12 |
| Fatigue Resistance (+) | 0.3 | 3 | 0.135 | 4 | 0.18 | 4 | 0.18 |
| Sub-Total: | 1 | | 0.48 | | 0.48 | | 0.6 |
| Cost | 0.05 | | | | | | |
| Materials (-) | 0.4 | 3 | 0.06 | 3 | 0.06 | 3 | 0.06 |
| Manufacture (-) | 0.4 | 3 | 0.06 | 4 | 0.08 | 4 | 0.08 |
| Maintenance costs (-) | 0.2 | 4 | 0.04 | 3 | 0.03 | 3 | 0.03 |
| Sub-Total: | 1 | | 0.16 | | 0.17 | | 0.17 |
| Production | 0.15 | | | | | | |
| Ease of Manufacture (+) | 0.5 | 3 | 0.225 | 3 | 0.225 | 3 | 0.225 |
| Ease of Assembly (+) | 0.5 | 3 | 0.225 | 4 | 0.3 | 4 | 0.3 |
| Sub-Total: | 1 | | 0.45 | | 0.525 | | 0.525 |
| TOTAL | 1 | | 3.5575 | | 3.4625 | | 3.6025 |

Figure 40- Completed Matrix

The important feature of the selection matrices is that they allow for comparing of both Sub-Totals and Totals of design ideas. Not only can the designs be assessed in individual categories, but the category rating of one design can be compared to the category ratings of every other design. For example, a design might have an overall mediocre rating, but performance and safety could be the two highest ratings. Since these two categories are the most crucial; this would be taken into consideration when comparing to a different design with an overall higher rating.

For example: to find the weighed value of the Load Distribution in the Shoulder Joint of Design I, the following procedure is followed. First, one discovers that this category given a value of 3. So 3 is multiplied by 0.2 (the weight of this spec in Performance Category) and then multiplied by 0.3 (the weight of Performance within the

entire Shoulder Joint Categories) will result in a weighted score of 0.18. This value can be compared to the Load Distribution of other Shoulder Joint Design ideas.

4.2.2 Determining Preliminary Design

After filling out all matrices, the team met to compare and contrast the four individual group member's design rankings. To analyze the importance of each member's input, the most poorly ranked 2 or 3 designs for each component were recorded on a separate document. If there were any recurring bottom ranked designs, they were discussed and then eliminated. Next, the top 2 or 3 designs for each member were recorded on a separate document. The top answers were compared to find any recurring design selections. The ideas ranked medially in comparison to the rest of the selections were examined to see if any of the top designs could benefit from the 'pros' of the subsections of the design- to create a hybrid of ideas. Lastly, after more discussion, a top design was chosen in each of the three categories.

4.3 Preliminary Design

The best solution for the shoulder joint and arm interface chosen as the preliminary design was the 'Modified Gimbal Joint' (Figure 27), in combination with the rotating bearing (Figure 39). This design excels over the other designs in terms of load distribution and load capacity. It is rated equally to the original gimbal joint in many categories; however, it provides a simpler solution with greater ease of manufacturing, fewer pinch points, and greater don/doff ease. These two design ideas can work together to mimic the movements of the shoulder joint and securely attach to the prosthesis.

The optimal choice for strapping included the harness with torso belt (Figure 20), which provides a firm foundation (wide harness) and simple strapping. This system would be easy to don/doff and simple to manufacture. A model of the preliminary device is shown in Figure 41.

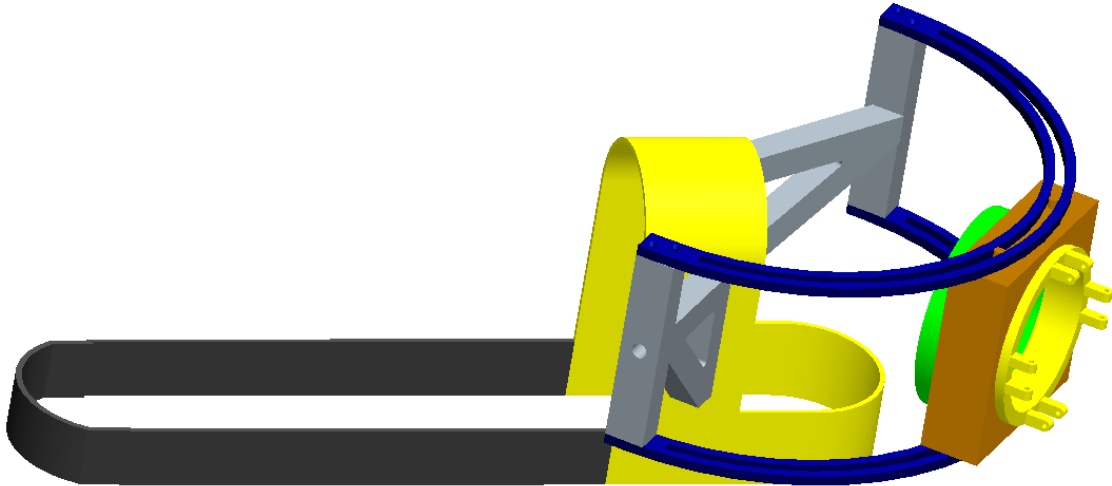

Figure 41 - Isometric View of Selected Preliminary Design

This preliminary design provided a foundation with which to brainstorming new ideas and improvements. When combining the design concepts into the preliminary design, two supporting triangular brackets were added. These were necessary additions upon which the track can be mounted. This preliminary design underwent many changes, as described in the Evolution of Design section, up to the final device, which is described in the Final Design section. However, there was a brief period of time (middle-late stages of project) in which an alternative design was considered.

4.4 Alternative Design

During the development of the preliminary device to the final device, an alternative design idea was conceived that deviated from any past ideas and warranted much consideration. This “Alternative Design” was based off of anatomical concepts involving the human musculature. In essence, the idea utilized biomimicry by replacing the muscles in the shoulder with external cables and pistons simulating co-contraction.

The alternative design incorporated most of the important aspects of the old design (the locking mechanism, the arm interface, the body mount). This design replaced the semicircular track pieces, the posts between the two tracks, the triangular brackets, and the screws that hold the track in place (these objects are marked in bright red in Figure 42). As is shown in the figure below, removing these pieces would significantly reduce the size and weight of the device.

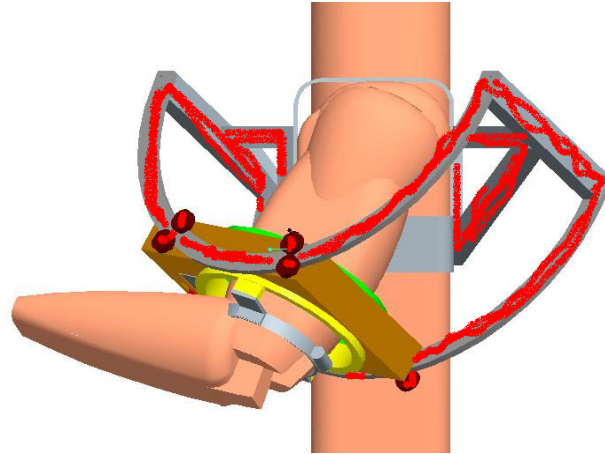

Figure 42 - Removal of Tracks, Posts, and Triangular Supports

This design replaced the bulky semicircular track pieces with lighter chains. One chain would run across the top of the arm interface and another under the bottom (each one replacing a track/bracket). These chains would then be directly attached to a harness. Using geometry, it was determined that for a given width of the arm interface and a given upper arm length, a chain could be attached such that it would hold the arm interface tight to the user's residual limb, but not limit the range of motion (see Figure 43).

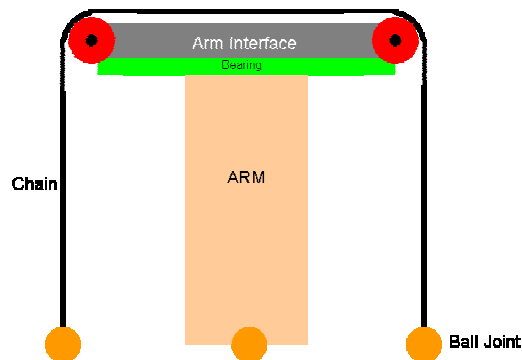

Figure 43 - Design Concept (neutral position)

Figure 44 shows the device with the arm swung to one side. The unique aspect of this design is that the chain remains in tension the entire time, while still allowing a full range of motion. This is similar to how muscles of the shoulder work (co-contraction of opposing muscles holds the arm in certain positions isometrically).

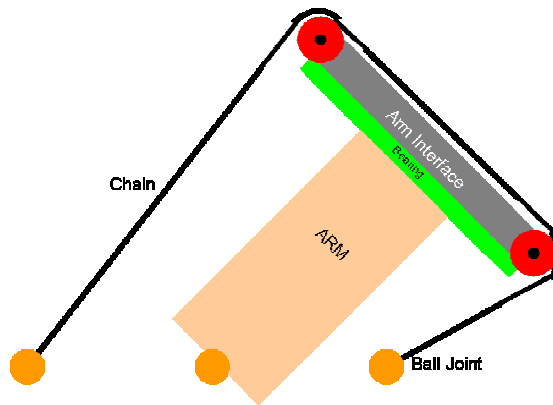

Figure 44 - Design Concept (range of motion)

Therefore, when the device is loaded axially, the chains absorb this loading similar to how muscles absorb external loads. Unfortunately, the device would not resist a moment exerted about the axis running axially down the arm. The chains are not sufficient in resisting this force alone. Therefore, a brainstorming session was held to design ideas of how to resist the torque. One design concept is shown in Figure 45.

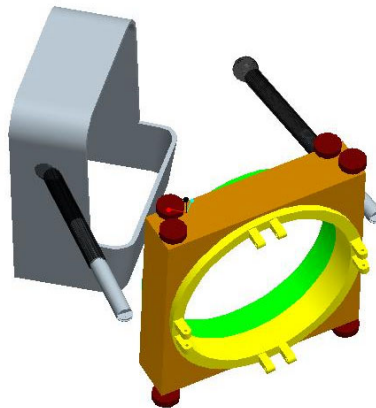

Figure 45 - Design Concept - Torque Resistant

The next revision of this design included two telescoping arms extending from the harness to the arm interface. These arms would not inhibit the function of the chains (not shown on Figure 45) but would prevent the interface from twisting due to external moments. However, with this design, one would need 5 inches of travel on the telescoping pieces and they would need to be compressible to ensure a full range of motion. Adding more links was considered, but with more links, the telescoping piece becomes more and more unstable, and therefore less and less likely to resist moments.

After much deliberation, this idea was finally discarded because no suitable solution for torsional loading could be found. While the innovation of a design that utilizes biological mimicry contains several benefits, the implementation of this kind of mimicry is very difficult given the desired loading conditions.

V. ANALYSIS AND EVOLUTION OF DESIGN

After selecting a preliminary design, we analyzed the design in numerous areas. From the analyses, we then determined in what areas our design could be improved. The design process was a continuous evolution of the device without discrete stages. This section will review each of the analyses performed and the design changes that resulted from each.

5.1 Free Body Diagrams

Based on the three major functions identified earlier in the paper, four critical loading positions were identified. The chosen positions were selected as ones that a user would commonly encounter and that would also develop significant loading on the device. These positions require our device to withstand relatively high axial and torsional loads and also require our device to mimic the range of motion found in the normal shoulder.

5.1.1 Position 1

Position 1 analyzes how forces are distributed over the device while carrying a suitcase/briefcase. In this position, the forearm is in line with the humerus (i.e. arm is straight with no bend in elbow). The arm lies in the frontal plane and makes an angle with the x-axis. An external force is applied at the distal end of the prosthesis and acts in the negative y-axis direction. The free body diagrams of this scenario can be found in Appendix B – Free Body Diagrams.

5.1.2 Position 2

Position 2 simulates how someone might carry a box in front of their body. The forearm is parallel to the z-axis, while the humerus makes an angle with the z-axis. In this position, the arm is parallel to the sagittal plane. The force in this scenario is applied at the distal end of the prosthesis and acts in the negative y-axis direction. The free body diagrams of this scenario can be found in Appendix B – Free Body Diagrams.

5.1.3 Position 3

Position 3 simulates the action of pulling a door open. In this position, the forearm is in line with the humerus (i.e. arm is straight with no bend in elbow) and makes

an angle with the z-axis. Again, the arm is parallel to the sagittal plane. There is a force applied at the distal end of the prosthesis in the positive z'-axis direction. The free body diagrams of this scenario can be found in Appendix B – Free Body Diagrams.

5.1.4 Position 4

Position 4 simulates activities near the face (e.g. eating, drinking, grooming, etc.) or lifting an object to the face. In this position, the elbow is bent to 90°, with the forearm parallel to the ground and the humerus parallel to the positive z-axis. The force is applied at the distal end of the prosthesis in the negative y-direction. The free body diagrams of this scenario can be found in Appendix B – Free Body Diagrams.

5.1.5 Summary of Findings

The analysis of the free body diagrams uncovered three potential problem areas in our device. The first finding led to a redesign of the harness because of how it responded to moments. The second result was used in optimizing pressures on the body. The third result led to a track redesign.

The first important finding was that the selected harness system could not reach static equilibrium in some of the loading conditions. For positions in which a moment existed on the harness that acted about the z-axis, the harness could not counter this couple. Figure 46 shows the missing force as a dotted arrow. A solution to this problem with the harness would entail redesigning the harness to include another strap which exerted a force in the x-direction which would act in concert with the existing straps to create a couple.

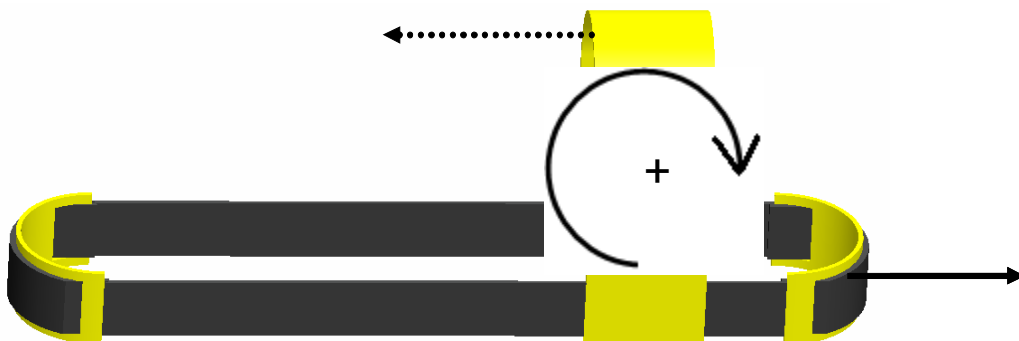

Figure 46 - Original Harness Failure to Counter Moment

The next finding involved determining pressures on the body. By finding the maximum forces that the straps exert on the body, we can determine the pressures at

those locations. Once we determine pressures, we can approximate the comfort. Figure 47 shows the areas where the harness exerts pressure on the body. Left Side and Right Side act on the user's latissimus dorsi and ribcage. Top Body acts on the user's trapezius and collarbone. Front Body acts on the user's chest. Rear Body acts on the user's back.

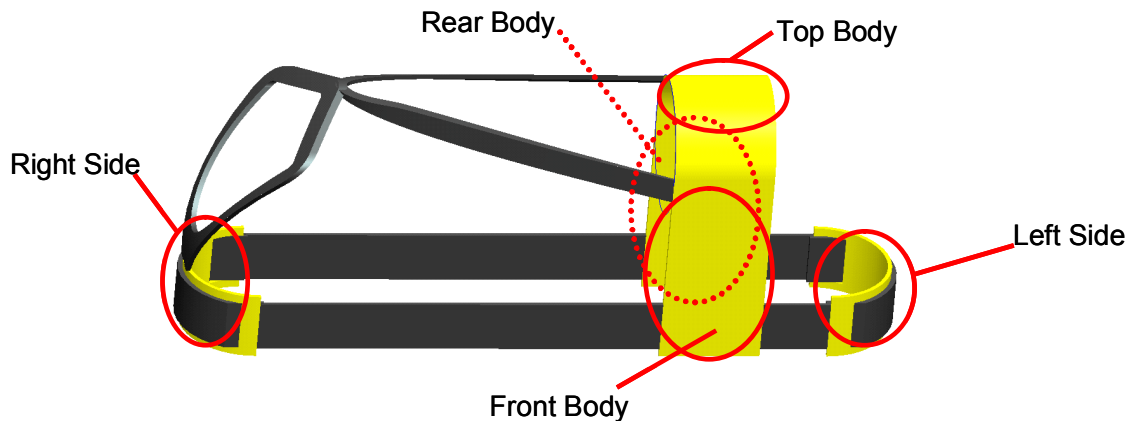

Figure 47 - Pressure Points on Body

Based on the free body diagrams, the maximum forces felt by the body at these positions were determined. See Table 8 for a list of the maximum forces and the positions which create these loads. This data was used for pressure calculations that dictated the size of the thermoplastic pieces.

Table 8 - Maximum Forces on the Body

| Location | Max Force (lbf) | Loading Position |
|------------|-----------------|------------------|
| Right Side | 10.42 | Position 4 |
| Left Side | 57.50 | Position 2 |
| Top Body | 60.00 | Position 1 |
| Front Body | 18.6 | Position 4 |
| Rear Body | 18.6 | Position 4 |

While the free body diagrams aided in understanding the interactions between the harness and the body, it also allowed for analysis of the reaction of the individual components in various loading positions. Because the device will only be exposed to relatively small forces that are encountered during everyday activities, material strength was generally not a factor. However, the track was a potential weak link in the design. Due to the geometry of the semicircular track, stability was a very important issue. Even slight deformation in the track creates significant functional loss. Therefore, Position 4 was identified as the condition in which the track experiences the greatest forces. It was

determined that the track experiences a moment of 19.3 lbf-ft in the worst case loading scenario. This number was used in analyzing the track for deformation during ANSYS analysis. This analysis eventually led to the redesign of the track.

5.1.6 Harness Evolution

The results from these free body diagrams gave us valuable information regarding the range of forces the device would encounter during typical use. More importantly, however, it shed light on a limitation of our harness. Figure 48 shows the original harness we selected.



Figure 48 - Original Harness

This harness utilizes one strap which can be tightened or loosened to accommodate various sized people. However, because the L-shaped piece cannot change shape, this limits the adaptability of this design. The solution was to include a second strap (shown in Figure 49).



Figure 49 - Revised Harness 1

This harness utilizes a second strap which gives the device even more adaptability to fit various sized people. After completing a force analysis for the four positions described above, it became clear that this strapping system was insufficient for

supporting moments applied to the shoulder thermoplastic piece. Figure 50 shows the solution to this problem.

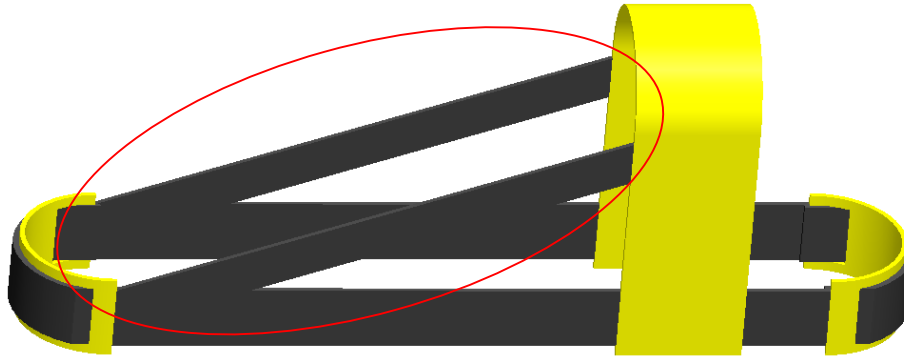

Figure 50 - Revised Harness 2

In this harness, the cross straps counter any moments applied to the shoulder piece. The cross straps also provide additional resistance to any lateral motion of the shoulder piece relative to the body. Despite the functionality of this design, it was noted that the cross straps would be very uncomfortable for female users as the added straps cross the bust line. To remedy this, the harness configuration in Figure 51 was devised.

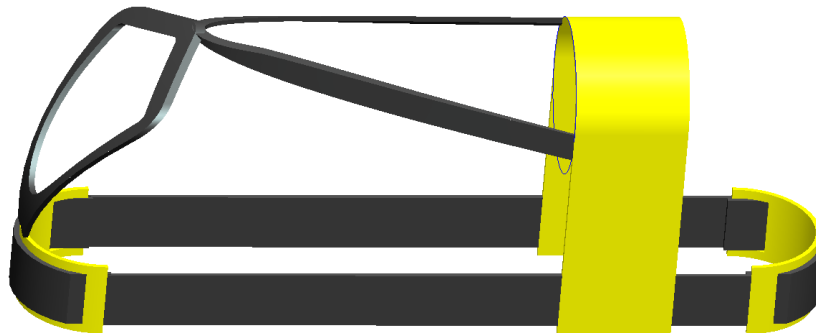

Figure 51 - Revised Harness 3

This harness is described in more detail in the Final Design section of the paper.

5.2 ANSYS

In mechanical design, stresses and deflections experienced by loaded parts are of critical importance. After getting an idea of the loads we expected the device to experience, a three dimensional stress and deflection analysis was performed on select components of our design using ANSYS version 9.0A1.

5.2.1 Preliminary Analysis

From the very early stages of the design, the track was seen as one of the critical components when it came to failure scenarios since it plays a vital role in load transfer. Initially, the track, shown in Figure 52 below, was a slender curved beam supported at both ends with a slot cut in the middle. There was concern as to how the track would behave under a given load and was therefore modeled using FEA.

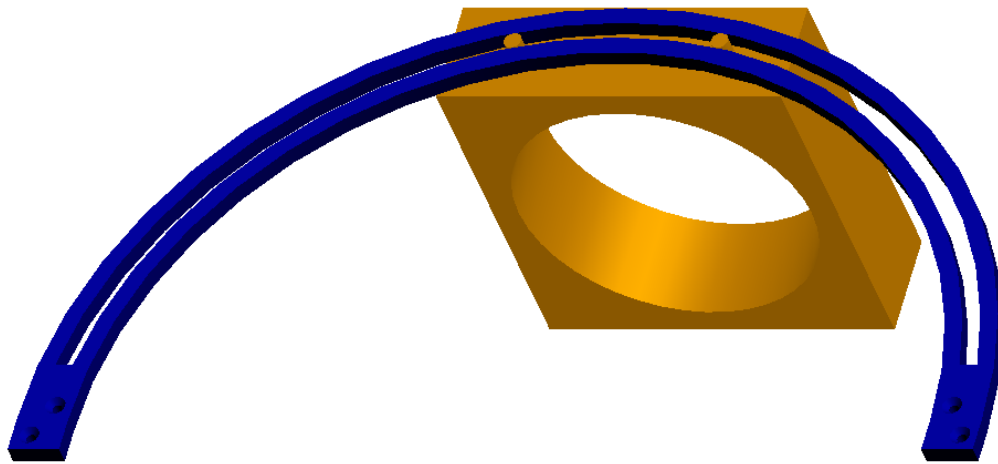

Figure 52 - Preliminary Track Design

The results from running the model of the preliminary design suggested that the track would not be suitable. The first evidence of this was the deflections that were observed under the loading conditions. Under axial loading of the device the slot in the center of the track was seen to enlarge thereby creating a loose fit with the arm guide. While we were not sure at this point what an acceptable deflection would be, intuitively they seemed too large. Of more significance was the stress profile induced by the applied load. In several places, especially where the track was anchored and the corners of the slot, the stresses in the material were high, coming very close to, and in some cases exceeding the yield strength of the material. The result of the preliminary analysis was to redesign the geometry of the track, adding material to make it stiffer so as to reduce the deflections and decrease the magnitude of stresses experienced. The redesign of the track can be seen below in Figure 53.

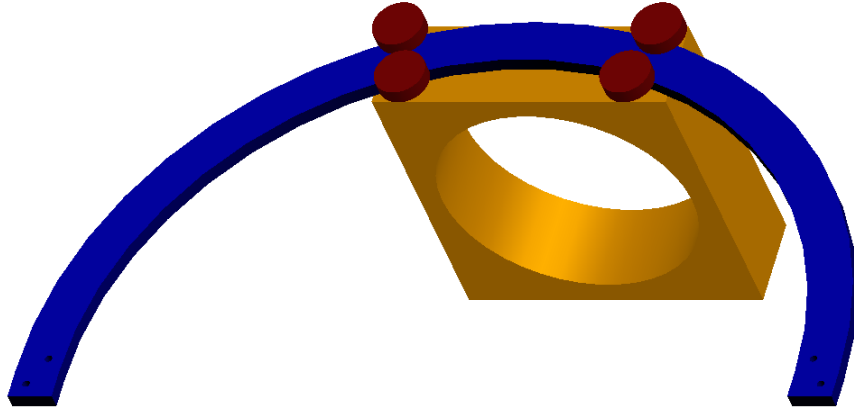

Figure 53 - Redesign of Track

5.2.2 Final Design Analysis

Before manufacture it was necessary to ensure that our selected track design was capable of withstanding the loads that would be applied to it. The second set of analyses was more thorough as we had a better idea of the conditions the track would experience.

5.2.3 Critical Load

From research we decided that the most detrimental scenario would be the one in which the track was torsionally loaded. By applying a torque to the arm guide which rides between the two tracks, it could be imagined that the resulting deflection in the track would take the shape of an “S”. Intuitively, deformation such as this would cause binding between the tracks and the arm guide, resulting in the inability to move through the desired motion.

5.2.4 General Model Setup

The modeling described below was performed in the structural component of the software package. The first step was to import the solid models from ProEngineer. In order to do this, the parts from ProEngineer first needed to be saved in the .IGES file format. Once this had been completed the parts were easily imported into ANSYS.

5.2.5 Element Type

One of the most critical steps in the finite element modeling process was choosing the appropriate element type. Due to lack of extensive experience with this modeling process, the question as to which element type would be appropriate was deferred to

Professor Wei Han, a Finite Element Methods professor at WPI. Her suggestions lead to the decision to use the SOLID 8 NODE 185 element.

5.2.6 Material Properties

Next was the specification of the material properties to be used in the model. For our purpose the material was assumed to be of the linear, elastic, isotropic type. While this is the simplest type of material model, it is also an appropriate one for our case. There are two components to the definition of the material model; the specification of the Elastic Modulus and the Poisson's Ratio of the material. Part of the investigation in this modeling stage was to determine whether to use Aluminum or Delrin. For reference, see the material data sheets from ("Delrin", 2005)

5.2.7 Meshing

The next step was to mesh the model with the chosen elements. Choosing the element size is another critical point in the Finite Element Method. There are two ways to specify the number of elements in a model. The one chosen for this analysis was to specify the edge length of each element. For this model the element edge length was chosen to be 0.1 inches, which was one of the finer meshes possible for this model. Choosing this value yielded a total of 33821 elements.

5.2.8 Boundary Conditions

The next step in setting up the model was to define the boundary conditions. This is one of the most critical parts of the modeling process because it is difficult to accurately describe what is happening at a boundary. In our assembly we are affixing each side of the track to a post using two screws. The holes in the track through which the screws would pass were used to specify the boundary conditions. To set the boundary conditions a structural displacement constraint was placed on the inside area of the screw holes. To imitate the tracks being screwed down to the posts, the displacement was set to 0 in the X, Y, and Z directions.

5.2.9 Load Application

The last step to setting up the model was the placement of the loads. The load that we were most concerned about was the torsional load applied to the humerus about

its own longitudinal axis. From Free Body Diagram analyses the resulting torque was found to be 25 ft.-lbs. A couple was used to model the torque. The forces of the couple were placed on individual nodes in the model. The nodes were selected using their coordinates. The coordinates were determined from an estimate of the point of interaction between the arm guide and the track. The distance between these two points is 5 inches. The placement of the couple was determined by the position in which we suspected the worst deflections to occur. This was decided to be in the middle of the track where the load would be the furthest away from the supports.

5.2.10 Results of FEA

The model was run a total of four times, each time varied either the magnitude of the load or the track material. Since we were unsure of exactly how much of the load one track would carry at any given moment, we decided to test the ideal versus the worst cast condition. The ideal condition is that each track would carry exactly half the load at all times. The worst case condition is that only one track would carry the entire load. Simulating the track carrying the entire load was achieved by applying a couple with a magnitude equal to that of the calculated torque. To simulate the track carrying half the load, only half of the couple was applied. Each of these scenarios was carried out both with Delrin and Aluminum. The resulting deflections for each scenario are seen in Table 9 below.

Table 9 - Deflection Summary

| Deflection Summary | | | | |
|---------------------------|---------------------|-----------------------|----------------------|------------------------|
| | Delrin® - 1x | Delrin® - 0.5x | Aluminum – 1x | Aluminum – 0.5x |
| Deflection (in.) | 0.917 | 0.458 | 0.041 | 0.020 |

NOTE: Nodal displacement plots were also generated as part of the analyses. For graphical results please refer to Appendix E – Graphical FEA Results.

The resulting deflections experienced by the Delrin® in either case were clearly unacceptable. Deflection of 1 inch and a half inch in the full and half load conditions respectively would clearly be a source of binding. As a result of this analysis, the decision was made to manufacture the track using aluminum. The stresses experienced under the applied loads are considered to be relatively small compared to the material's yield strength and therefore was not considered in the failure analysis.

5.3 Design for Manufacture/Assembly (DFM/DFA)

A critical step in the design process was to analyze all components with respect to Design for Manufacture and Design for Assembly. Well designed parts are simple, easy to produce and reproduce, easy to assemble, and utilize common tools. There were two key areas which were improved upon based on DFM and DFA – the arm guide screws and the bearing.

5.3.1 Arm Guide Screws to Arm Guide Cap

The original design called for 8 screws (four on top, four on bottom) to hold the arm guide in place within the tracks (see Figure 54). These screws were screwed into tapped holes on the arm guide.

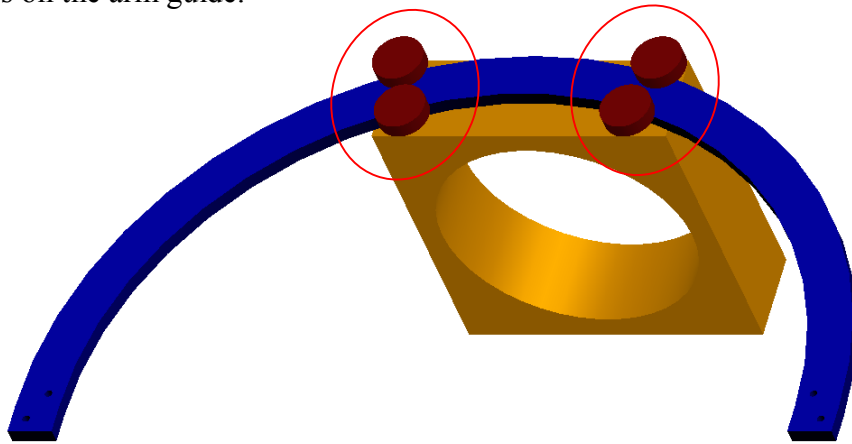

Figure 54 - Arm Guide Screws

Figure 55 shows how the arm guide caps replaced the arm guide screws on the redesign. The arm guide cap is screwed into place into three tapped holes in the arm guide.

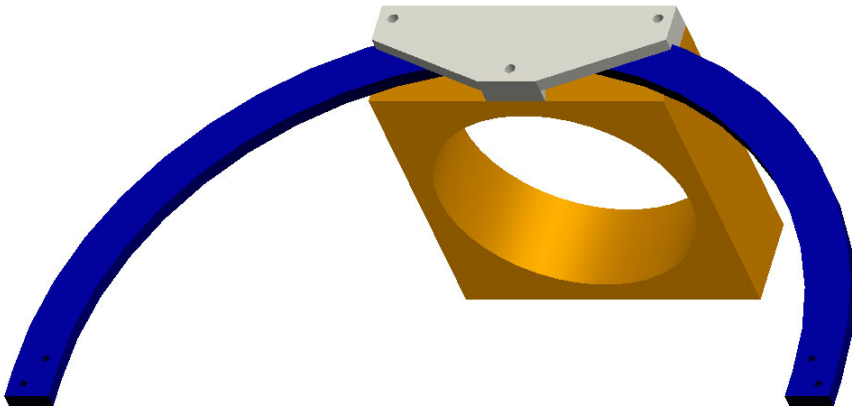

Figure 55 - Arm Guide Cap

This redesign reduces the number of machined pieces from 8 to 2. The only additional pieces that the arm guide cap requires are machine screws. Also, tolerancing a single arm guide cap is easier than tolerancing the location of four tapped holes on the arm guide (as is the case with the arm guide screws). The overall integrity and stability of the connection is vastly improved due to the use of a single cap, as opposed to four independent screws. More information about the arm guide cap can be found in the Final Design section.

5.3.2 Bearing Simplification

Figure 56 shows the original bearing configuration. In the original design, the bearing was composed of two pieces (shown here in yellow and green) that locked to each other, but slid freely within the arm guide. The lips on each respective bearing prevented the bearings from sliding out of the arm guide. The distal bearing piece (yellow) was equipped with protrusions which could be attached to a prosthetic or prosthetic socket.

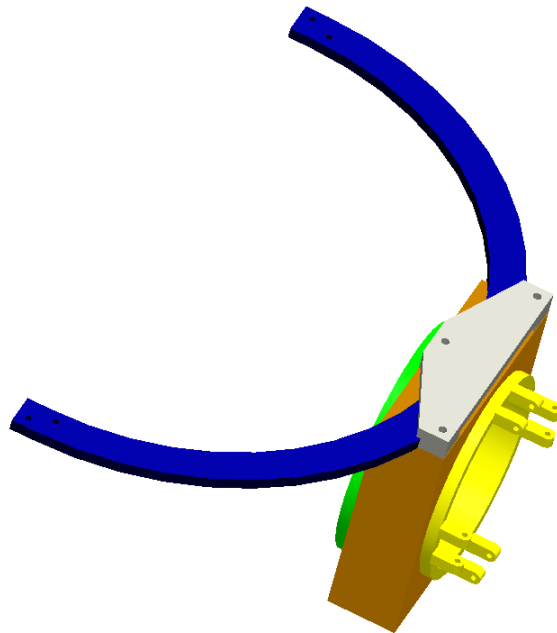

Figure 56 - Original Bearing

However, when in use, the lip on the distal bearing is useless. The bearing will never slide out of the arm guide on the proximal side since the user's residual limb will be in the prosthetic socket which is attached to the bearing. Our main concern is

preventing the bearing (and thus the attached prosthesis) from sliding out of the distal side of the arm guide. This can be accomplished with a single bearing as shown in Figure 57. The lip on the bearing doubles as a flange which the prosthetic socket can be attached to. For more detail on this bearing, see the Final Design Section.

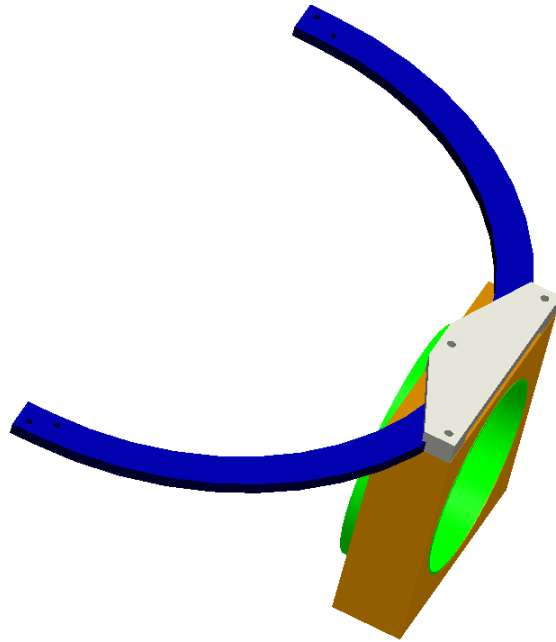

Figure 57 - Revised Bearing 1

The previous analyses resulted in redesign of individual component geometries. At this point we were left with our final design. The one aspect still to be dealt with before the design finalization was to appropriately scale the device.

5.4 Anthropometric Data Analysis

Size is a clear issue regarding this design. For obvious reasons, the device should be made as small and light as possible. However, there is a minimum size that our device must be in order to allow for the proper range of motion in the shoulder. This minimum size was based off of the maximum outside diameter of the upper arm, which affected the size of the bearing, the arm guide, the bearing brake, and the track. A detailed look at the calculations and assumptions used to determine the outside diameter of the upper arm can be found in Appendix D – Anthropometric Data Analysis. A summary of the results will be presented here.

The first step was determining the average length of the upper arm. Arm length can be approximated from total body height.

$$h_{\text{upper_arm}} := 12.9 \text{ in}$$

Next, the volume of the upper arm was approximated using a correlation equation. Both volumes represent men of average height. The smaller volume represents men in the 50th percentile for weight (191 lbs). The larger volume represents men in the 90th percentile for weight (243 lbs).

$$V_{50\text{th}} := 136. \text{ in}^3 \quad V_{90\text{th}} := 180 \text{ in}^3$$

Next, the centroid of the upper arm was approximated from known anthropometric data as a distance away from the proximal end.

$$z := 5.629 \text{ in}$$

Using this data, and approximating the shape of the upper arm as a truncated circular cone, one can determine the diameters of both the proximal and distal end of the arm for men of average height with weights in the 50th and 90th percentile.

$$D_{\text{proximal.50th}} := 4.35 \text{ in} \quad D_{\text{distal.50th}} := 2.932 \text{ in}$$

$$D_{\text{proximal.90th}} := 5 \text{ in} \quad D_{\text{distal.90th}} := 3.374 \text{ in}$$

Based on this data, the approximate diameter of the upper arm can be determined for various distances down the humerus. The following values represent the distance from the proximal end to the point on the upper arm where the diameter becomes smaller than 4 inches.

$$x_{50\text{th}} := 3.2 \text{ in} \quad x_{90\text{th}} := 8 \text{ in}$$

Therefore, the bearing in our design will have an inside diameter of 4 inches. This will give people of average size (5'9", 191 lbs) the ability to don the device with only 3.2 inches of residual limb length. Larger people (5'9", 243 lbs) can also don the device, but require more residual limb length (8 inches). This diameter dimension is critical within the whole device since so many other dimensions are related directly to it. This single dimension affects how small the bearing can be, which affects how small the arm guide can be, which in turn affects the fit of the arm guide between the tracks. We

feel that a 4” bearing will accommodate a majority of people while allowing our device to remain as small as possible.

5.5 Sensitivity Study

When designing anything from scratch there are more often than not several parameters within the design that the designer has explicit control over. With this freedom, the design process can become overwhelming when it comes to deciding which parameters to change. While several parameters may have the ability to be changed, those changes may or may not have a significant impact on the performance of the device. In order to investigate parameter changes and evaluate their effects, a method known as a sensitivity study can be performed which provides insight to the designer as to what changes would be most effective for the desired outcome.

Below are the results and explanation of such a study which was used to determine what dimensions to alter in order to achieve the desired joint motion. The critical outputs in this case are forward flexion in the shoulder joint and flexion in the elbow. The parameters that we were interested in changing were track radius and arm guide height. It should be noted that Arm Location, another variable used in the study, is essentially the same as track radius, as it is implicitly defined by the track radius.

The global constraint on joint flexion in this case is when a moving part such as the arm or the arm guide comes in contact with a stationary part. This would be considered volume interference. The ProE model can be used to visualize such a situation. For example, note in Figure 58 the interference between the forearm and the arm guide when the elbow is flexed.

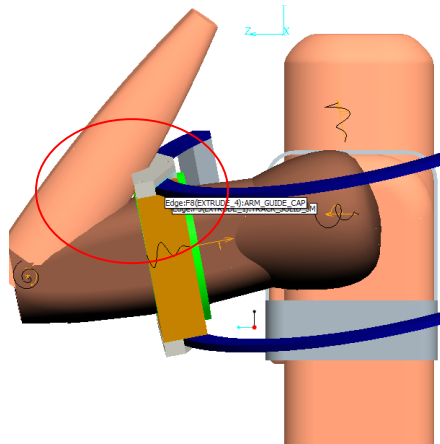

Figure 58 - Volume Interference

It is clear in the model that elbow flexion is limited at the point where interference between the forearm and the arm guide occurs. This is representative of reality as it takes into account the approximate shape and contour of the arm. Since ProE is not able to make interference a parameter in a sensitivity study it was decided that we would proceed by hand using the model only as a guide. All of the calculations that were performed were based on the simple geometric representation of the arm shown in the figures below.

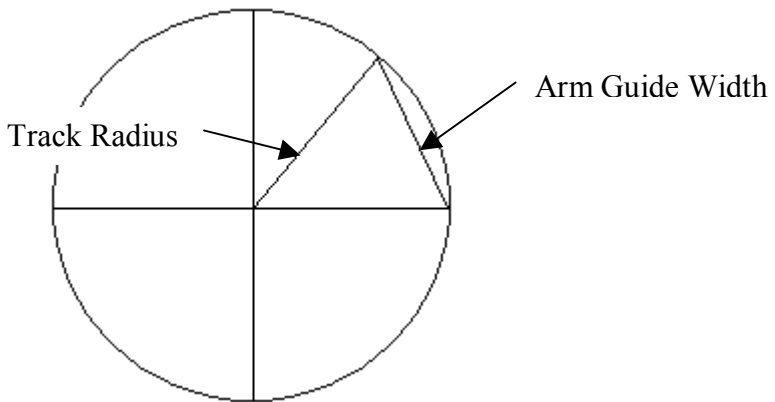

Figure 59 - Forward Flexion

Figure 59 shows a sketch using circle geometry; radius and chords to determine the central angle which is interpreted as the flexion of the shoulder.

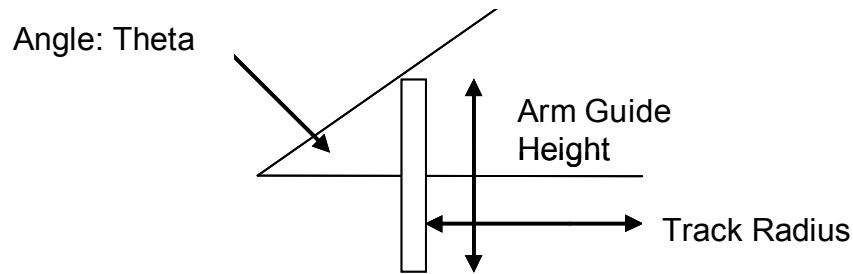

Figure 60 - Elbow Flexion

This second in Figure 60 uses triangle geometry with the upper arm as the hypotenuse, half of the arm guide height as one leg and distal length of the upper arm as the other leg. More specifically the dimensions of the triangle are seen in Figure 61:

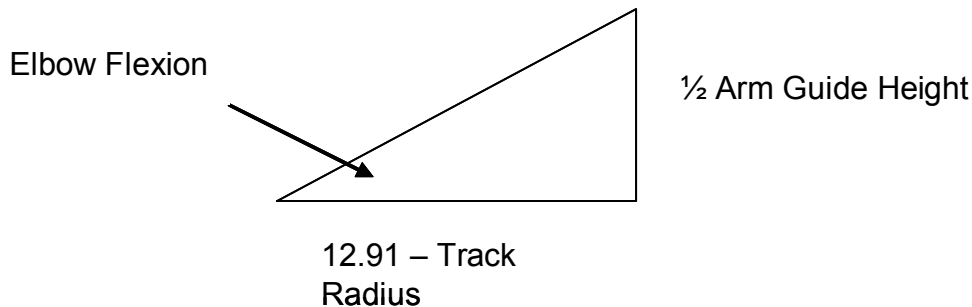

Figure 61 - Triangle Geometry

While we did realize that this is a very simplified model it allowed for easy calculation of the desired values. While not totally accurate, it provided us with information on the general trends that we would expect to see (which we believe would not drastically change should the model be more geometrically accurate). Since we are interested in the trends as opposed to absolute values, it did not warrant spending the extra time to develop a more accurate model.

Three studies were completed, the first of which investigated how keeping the arm guide width at 5 in. while changing the track radius in the range of 2.5 – 10 in. effected shoulder flexion. A summary of the parameters can be seen in Table 10 below.

Table 10 - Study 1 Summary

| Shoulder Flex. v. Track Radius | | | |
|---------------------------------------|-----------------|--------|----------|
| | Parameter | Value | Range |
| Constant: | Arm Guide Width | 5 in. | N/A |
| Variable: | Track Radius | x in. | 2.5 - 10 |
| Output: | Shoulder Flex. | y deg. | 50 - 130 |

Two angles were calculated for shoulder flexion, the first was with respect to the device and the second was with respect to the body. The device is not mounted perpendicular to the body as shown in the figure below. Looking down onto the transverse plane it is oriented 50 degrees off the body. Therefore each of the device relative angles was shifted 50 degrees clockwise to represent the actual functional range of motion. The placement of the device relative to the body can be seen in Figure 62 below.

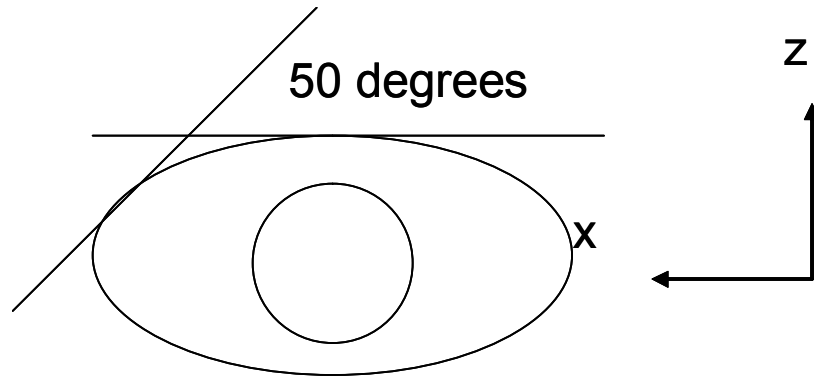

Figure 62 - Device Orientation

A plot of shoulder flexion angle versus track radius is shown in the Figure 63 below.

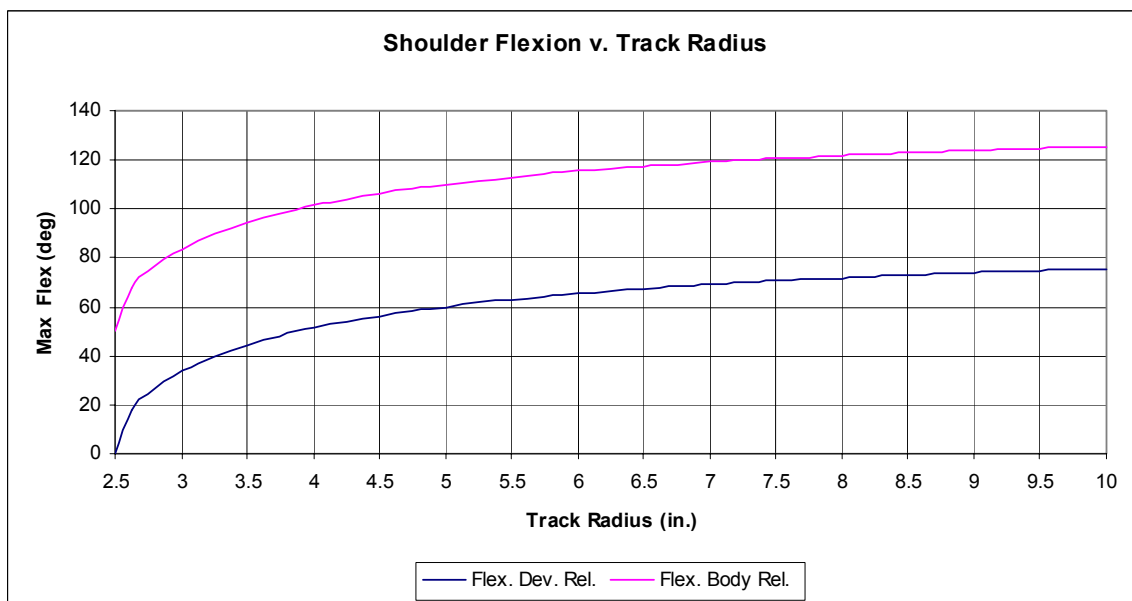

Figure 63 - Study 1 Results

At a track radius of 2.5 inches there was no movement relative to the device as would be expected because the chord (representing the arm guide) became the diameter of the circle. This plot shows a trend of exponential growth which levels off around 130 degrees.

The second study investigated how changing the track radius affected the elbow flexion angle. A summary of the parameters can be seen in Table 11 below.

Table 11 - Study 2 Summary

| Elbow Flex. v. Arm Location | | | |
|-----------------------------|------------------|-----------|-----------|
| | Parameter | Value | Range |
| Constant: | Arm Guide Height | 5 in. | N/A |
| Constant: | UA Length | 12.91 in. | N/A |
| Variable: | Arm Location | x % | 20 - 78 |
| Output: | Elbow Flexion | y deg. | 145 - 120 |

The independent variable was expressed as percent of arm length even though we changed the track radius (the two are directly related). There are also two curves on this plot. The first set of angle values were generated just from the geometrical calculations. However the geometrical model assumes the arm to be a line which does not have thickness. To adjust this value and make it more accurate, the ProE model was used to look at the setup with a particular set of dimensions. This allowed us to come up with an adjustment factor. This factor was estimated to be 20 degrees. The thicker the arm the less flexion would be achieved, therefore 20 degrees was subtracted from each of the nominal values. Again while this is not completely accurate, it gave an idea of the behavior we would expect to see. A plot showing these values can be seen in Figure 64 below.

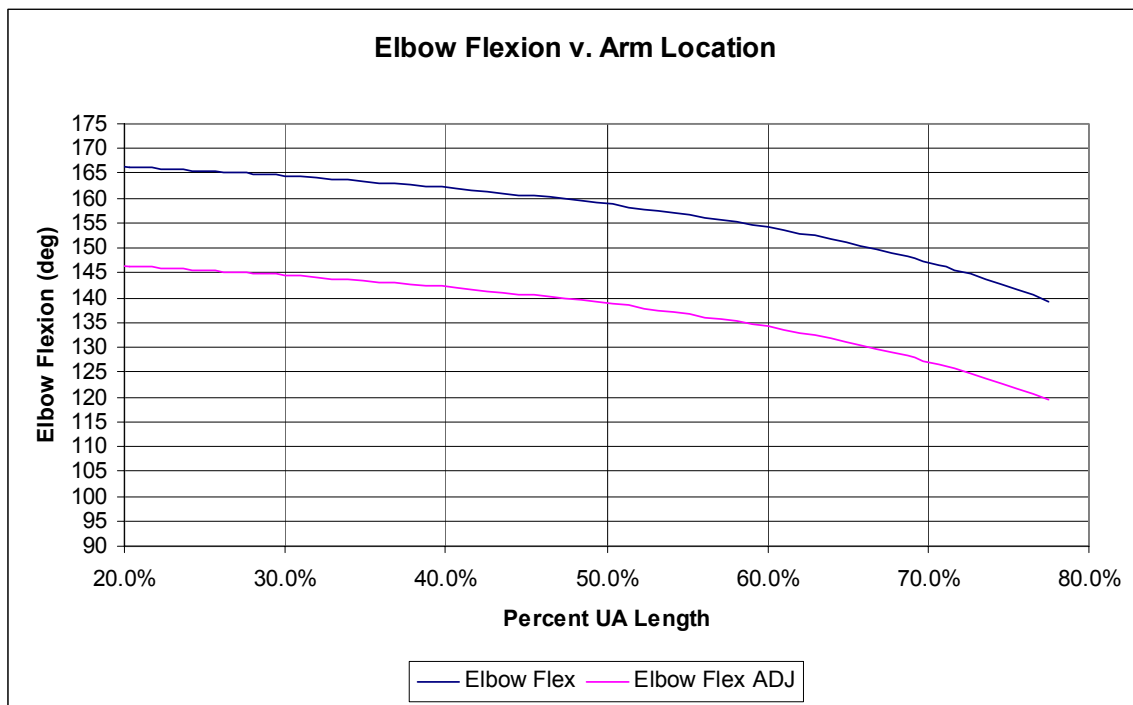

Figure 64 - Study 2 Results

This plot shows a slight trend of exponential decay. At 20% of the arm length the value of elbow flexion is about 145 degrees. While normal flexion is only about 135 degrees this shows that we have some margin to work with. The plot shows that as the arm guide moves distally, elbow flexion is impaired.

The last study investigated how changing the arm guide height affected elbow flexion. A summary of the parameters can be seen in Table 12 below.

Table 12 - Study 3 Summary

| Elbow Flex. v. Arm Location | | | |
|------------------------------------|------------------|-----------|-----------|
| | Parameter | Value | Range |
| Constant: | Track Radius | 5 in. | N/A |
| Constant: | UA Length | 12.91 in. | N/A |
| Variable: | Arm Guide Height | x in. | 4 - 8. |
| Output: | Elbow Flexion | y deg. | 143 - 126 |

Again the geometric model did not take into account the thickness of the arm so the ProE model was used to find a suitable adjustment factor. By the same explanation as the last segment of the study, the adjustment factor was subtracted from the nominal value found by geometry. In this case the value was 15 degrees. A plot of the values can be seen in Figure 65 below.

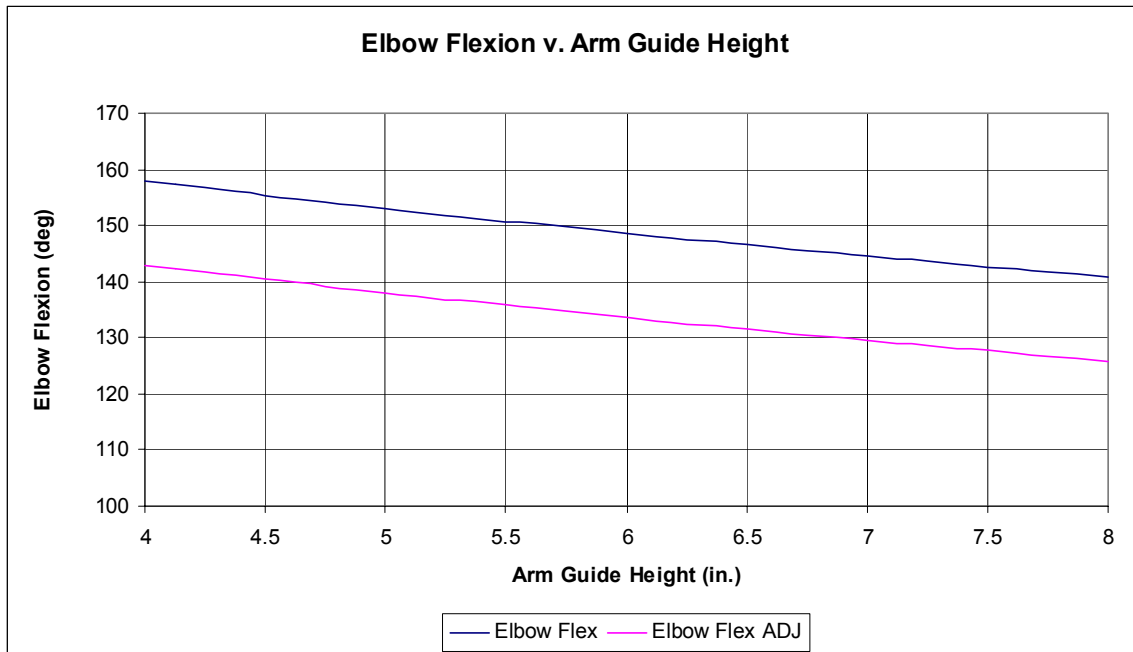

Figure 65 - Study 3 Results

This plot shows an almost linear trend, and again shows that as the size of the arm guide is increased elbow flexion is impaired as would be expected.

In conclusion, it is believed that changing the distance along the arm would give more radical changes in elbow flexion than would changing the arm guide height. This is because there is an exponential decrease in elbow flexion with respect to location along the upper arm compared to a more linear decrease in elbow flexion with respect to arm guide height. From the results it is clear that it would be most optimal to have the device attach as proximally on the arm as possible. While this may be physically impossible due to the residual limb, other problems are presented as well. By locating the device closer to the body forward flexion of the upper arm at the shoulder is lost. These two outputs have an opposing relationship. Furthermore, the arm guide dimensions must also be considered. For example, with respect to placement along the arm for 140 degrees of elbow flexion, the device can be located no more than about 50% down the length of the arm. However, coupled with this is the fact that to achieve 140 degrees of elbow flexion the parameter of arm guide height no more than 4 inches must also be satisfied. More investigation into an optimal value will be conducted. This study may also be useful in determining the smallest possible packaging for the greatest desired ranges of motion.

5.6 Fastener Analysis

One of the most important aspects of an assembly is the means by which it is held together. It must be verified that the selected fasteners are sufficient in providing the required strength. There are two aspects which must be considered. First, we have to ensure that the screws do not pull out of the tapped holes. Second, we must ensure that the material is strong enough and that the fasteners are oriented so that shear failure is not possible.

5.6.1 Thread Pullout Analysis

For the assembly of our device we chose to use machine screws. This would allow us to easily disassemble our device if need be. The fasteners that were chosen were #6 and #8 UNC screws. Some of the screw parameters can be seen below in Table 13.

Table 13 - Screw Summary

| | #6 Machine Screw | #8 Machine Screw |
|---------------------------------|------------------|------------------|
| Diameter (in.) | 0.138 | 0.164 |
| Threads per Inch | 32 | 32 |
| Tensile Area (in ²) | 0.0091 | 0.0114 |
| Shear Area (in ²) | 0.012 | 0.014 |
| Force ¹ (lbf) | 53.7 | 63.8 |

(1) Force required to fail fastener in shear.

The preferred loading of a screw is in tension and there are two possible modes of failure when loaded in this fashion. The first is tensile failure, which is when the tensile stresses experienced by the screw exceed the tensile strength of the screw material. The second mode of failure is a form of shear failure, where the threads fail because the shear stresses in the threads exceed the strength of the material.

The first step in the fastener analysis was to calculate the necessary engagement length that would prevent the screw from failing in shear before failing in tension. The engagement length is the length over which the screw interacts with its counterpart; either a nut or a hole. There is an initial assumption made in this calculation that both the screw and whatever it is interacting with are the same material. Because in our situation this is not the case a correction factor was applied.

In our assembly we will be setting the machine screws into tapped Delrin® holes. To account for this, a comparison between the two material strengths was made. Taking the strength of the screw material and dividing by the strength of the tapped material yielded the necessary correction factor. The corrected engagement length was found by multiplying the original value by the correction factor. The values obtained dictated how deep to tap the holes to prevent shear failure at the connection; also known as thread stripping. By definition of the equation, provided these values are satisfied, the failure mode of the fasteners will be in tension rather than in shear. However in this case since the hole material (Delrin®) is the weaker of the two materials, tensile failure of the fastener is not possible. The fastener would pull out of the hole first. For engagement length values for particular screws please refer to Appendix F – Thread Pullout Analysis.

While the above calculations provide the appropriate engagement length to avoid failure it is still good practice to have an idea of the magnitude of loads that would cause failure. As was mentioned before, we were worried about shear failure in the Delrin®

threads. The first step was to calculate the shear area of the threads. At this point a safety factor of 2 was introduced into the equation by dividing the strength of Delrin® by 2. The force needed to fail a thread was then calculated by multiplying the corrected strength by the shear area. Since this was the force required to fail one thread that number had to be multiplied by the number of threads that were engaged. The value for the force needed to fail one fastener can be seen in Table 13 above.

Not only are these loads notably higher than what we expect the device to experience, there is also nowhere in the design that 1 screw bears an entire load which introduces even more of a safety factor. The exact distribution of the loads was not investigated because of the high variability between different loading conditions and positions. Instead it was assumed that the above calculations were sufficient to say that we do not expect the chosen fasteners to fail.

5.6.2 Shear Pullout Analysis

There were two critical locations where we suspected shear pullout might occur. The detailed shear pullout analysis for both situations can be found in Appendix G – Shear Pullout Analysis. The first, as shown in Figure 66, could occur at the pin joint between the track posts and the support brackets.

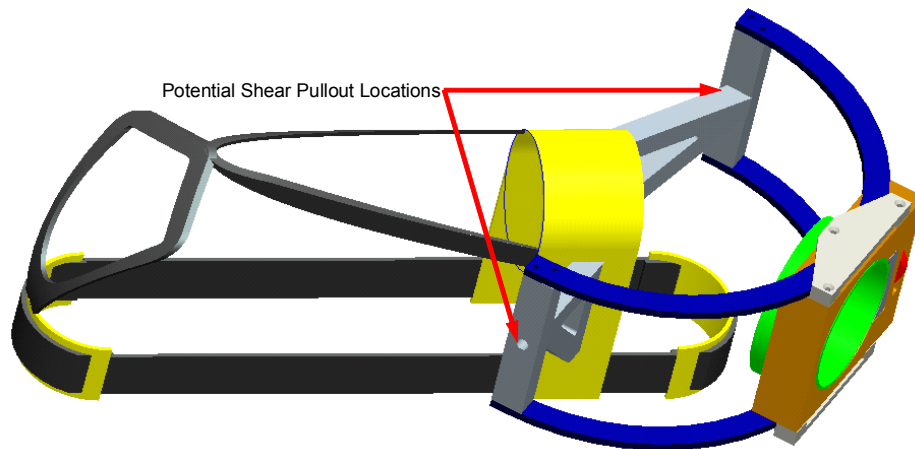

Figure 66 - Shear Pullout Locations 1

The detailed shear pullout analysis showed that the maximum applied force the aluminum can withstand before failure is

$$F_{\text{applied.A1}} = 1.702 \times 10^6 \text{ lbf}$$

This number is much higher than any forces we anticipate our device to encounter. Therefore, shear pullout at the track post/support bracket joint was deemed not an issue.

The second location where shear pullout was critical was the connection of the straps to the harness (see Figure 67).

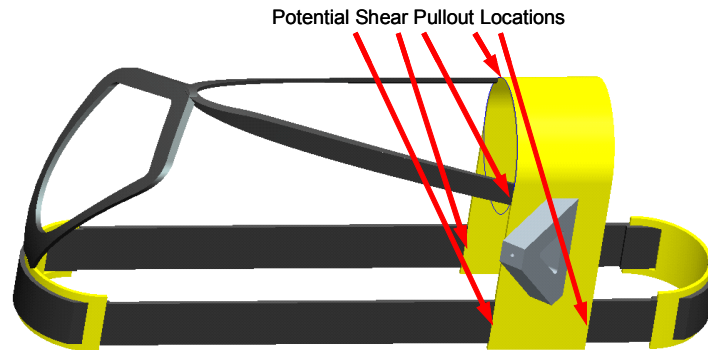

Figure 67 - Shear Pullout Locations 2

Based on the strength of the thermoplastic used for the harness (OmegaMax®), failure will occur at

$$F_{\text{applied.thermo}} = 102.783\text{lbf}$$

While failure occurs at much lower forces here than at the support brackets, this force is still significantly higher than the forces the device is expected to encounter.

5.7 Brake Analysis

In the original design, the bearing was allowed to rotate freely within the arm guide. However, it is important that the device have the ability to transfer torsional loads applied to the prosthesis to the user's body. Thus, a brake analysis was completed which led to an alternative design that incorporated a bearing brake (Figure 68, below). In the figure, the rotation of the red bearing brake knob moves the bearing brake (gray) laterally either towards or away from the bearing via a threaded post. The brake then applies a normal force to the bearing, preventing rotation. This design utilizes the torque that can be generated by the user and translates it into a normal force that creates a frictional force. A more detailed description of the brake assembly can be found in the Final Design section.

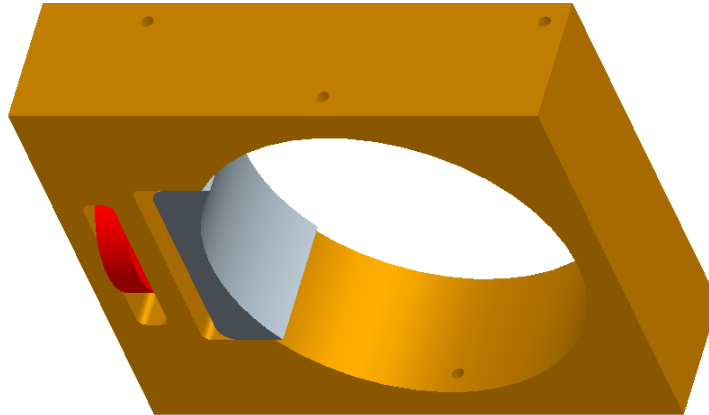

Figure 68 - Bearing Brake Assembly

The entire brake analysis can be found in detail in Appendix H – Brake Analysis. Based on a maximum 20 ft-lbf torque applied to the bearing, and assuming a rubber lining on the bearing brake, the brake needs to apply 452 pounds of normal force on the bearing. It was then determined that the user needs to apply 3.765 ft-lbf of torque on the brake knob to create this normal force. In *Applied Ergonomics* (Imrhan and Farahmand, 1999), the maximum torque that a male could generate on a similar sized knob was 13.07 lbf. The minimum torque a male could generate on a smaller knob while using grease smeared gloves was 2.54 ft-lbf.

Note that the assumptions made in this calculation err on the side of overestimating the torque required by the user. This is because the coefficient of friction used in the calculations was for Delrin® and steel. In reality, the rubber surface acting against the Delrin® produces a higher coefficient of friction. Therefore, the user needs to generate even less torque than calculated to lock the bearing.

5.8 Pressure Analysis

The areas of the thermoplastics were derived from data obtained from Reswick and Rogers, 1976. This study examines the allowable hours of continuous pressure on bony prominences at particular pressures. So, the allowable pressure of the device was determined by agreeing on an expect value of continuous hours for using the device. This was determined to be 4 hours, as one may wear this for half of a work day, take a 1 hour lunch break, and work another 4 hours. At 4 hours, a constant maximum pressure of 120 mm Hg is allowable for a comfortable fit. Upon calculating the forces

experienced by the thermoplastics in the four primary “heavy loading” conditions, the area of the thermoplastics could be determined by: $Pressure = F/A$.

The harness can incur forces of up to 40 lbf on the body in a downward direction. Therefore in calculating the surface area of the curved part of the thermoplastic, with a width of 3 inches, this value comes to approximately 40 square inches. This pressure comes out to 52 mm Hg, a number well under the required 120 mm Hg.

5.8.1 Determining Harness Length

In a sampling of 6 males (ranging from 67 inches to 75 inches in height), it was determined that in order for the diagonal strap to fit “comfortably” and to not injure or rub against the neck that it has to have a minimum distance of 4.5 inches from the top of the shoulder (Table 14). This was tested by holding a 1.5 inch strap at the middle of the right shoulder and moving the other end of the strap at varying vertical lengths away from the apex of the shoulder. The range of comfort of the test subjects did not vary greatly (from 3.7 to approximately 4.2 inches). Due to the range, it was decided that the strap should be located at 4.5 inches, a reasonable “comfort distance”.

Next, holding the strap at 4.5 inches at each test subject’s shoulder, the other end of the strap was brought to the center of the opposite shoulder. The average angle (theta) formed was 19.833 degrees (approximately 20 degrees) from the horizontal. Therefore, all forces will be calculated with the diagonal strap at 4.5 inches below the apex of the shoulder and at 20 degrees from the horizontal.

Table 14 - Comfort Survey for Strapping

| Test Subject | Height (inches) | Comfortable vertical strap distance from apex of shoulder (inches) | Theta at 4.5 vertical inches from shoulder apex (degrees) |
|--------------|-----------------|--|---|
| 1 | 75 | 4.1 | 23 |
| 2 | 71 | 3.8 | 21 |
| 3 | 70 | 3.9 | 17 |
| 4 | 67 | 3.7 | 19 |
| 5 | 75 | 4.0 | 20 |
| 6 | 71 | 4.2 | 19 |

The ideal strap would be located as close to the top of the shoulder as possible, with the smallest value of theta possible; however, both comfort and interference with the neck must be accounted for. Due to the diagonal strap located 4.5 inches from the top of

the shoulder, the harness must be at least longer than 9 inches. In considering the shape and material obtained to work with, a harness overall height of 9.25 inches is suitable.

Additionally, each of the slots must be 1 inch from the side of the thermoplastic to ensure there is no tearing. With a 3 inch wide harness, this does not allow much room for error. If the slots are cut a little more than 1 inch from the edge, then the distance between the two slots will be less than 1 inch. Therefore, it was determined that the harness should be 4.5 inches wide. This width is smaller than the width of shoulder for most males, but big enough to provide a 1 inch clearance amongst slots.

5.8.2 Free Body Diagram Calculations

A force diagram was completed with the given specs of the diagonal strap at 4.5 inches below the apex of shoulder and at 20 degrees, as well as in position #2 (Carrying box with 25lbs weight on left prosthesis). The diagram is shown in Figure 69:

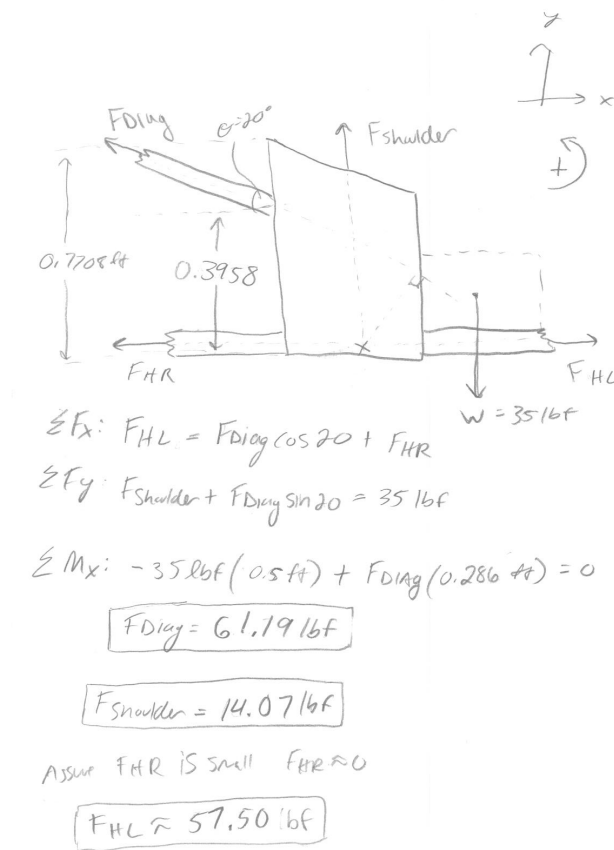

Figure 69- Free Body Analysis of Strapping System

Therefore, the straps experience forces of up to 62 pounds. Again, these values are the result of an upper-level limit (carrying a 50 pound box). The strapping must balance the moments created on the thermoplastic by the weight of the box and thus are expected to be this high.

Due to the high forces in strapping, side thermoplastics are necessary to distribute the forces over a wider area and make for a more comfortable system.

5.8.3 Side Thermoplastic Analysis

With 62 lbf forces as well as the 120 mm Hg pressure value, an area of 27 square inches is necessary for the side thermoplastic to be comfortable over a span of 4 hours.

The side thermoplastic is 6 inches in length and 5 inches in height. These dimensions were approximated from calculations on the T-shirt (assuming approx diameter of side =8.5 inches), along with the assumed shape of the body. The thermoplastic will be cut (6 inches long) from material formed with a diameter of 8.5 inches as in (Figure 2). Because a semi-circle with a 8.5 inch diameter has a total circumference of 13.35 inches, both side thermoplastics can be cut from this material. This is shown in Figure 70:

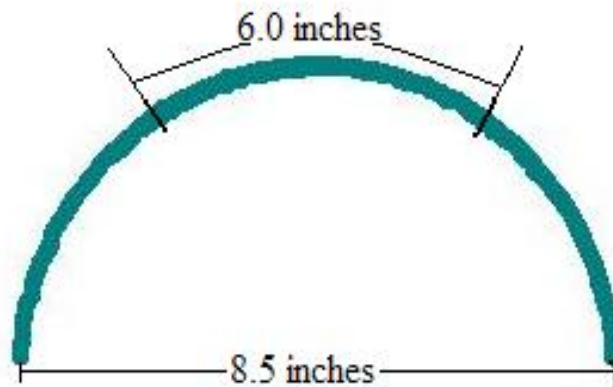

Figure 70- Formation of Side Thermoplastic

To determine maximum allowable height of the thermoplastic, data of maximum upper arm diameter was considered (Appendix D – Anthropometric Data Analysis). With a max diameter of 4.35 inches, the thermoplastic can go up to a height of 1.5 inches above the top of the strapping. Therefore, the height of the thermoplastic is approximately 5 inches. Thus the length of the thermoplastic must be larger than 5.4

inches. A length of 6 inches was chosen, due to measuring on test subjects. Both side thermoplastics will be the same size and will be manufactured much like the harness.

5.8.4 Major Pressure Points

The following 5 points of contact are the potential locations for high pressure. Therefore, extra foam padding will be considered for these locations. Additionally, these areas will be observed during testing of the device.

- 1-Curved part of harness
- 2- Left side thermoplastic due to strap force
- 3- Right side thermoplastic due to tightening of strap around body
- 4- Alpha/Diagonal shoulder connection area
- 5- Buckle to shirt contact

Upon recommendations from last meeting and performing further research, two addenda to the “Strapping and Harness” write-up are included: (1) A more accurate discussion of pressure on thermoplastics and (2) the addition of foam padding.

5.8.5 Pressure on Thermoplastics

In designing the strapping and harnessing system, the shape of the body is simplified to be composed of a rectangular prism with a width (from front to back) of approximately 8.5 inches, along with 3 semi-cylinders: one on the top of the prism and one on each side, each with a diameter of 8.5 inches. This is critical to the design of the system.

The maximum force exerted by the horizontal strapping on L side thermoplastic (from the harness to the left-side of the body—Force “FHL” in Figure 69) was calculated to be approximately 62 lbf. Because Figure 1 is in 2-D, this value represents both the front and back strap acting on the side thermoplastic. Therefore each strap contains a force of 31 lbs acting on the side thermoplastic L. These forces must be equal, otherwise the thermoplastic would be accelerating. Thus, the total force acting on the thermoplastic is 62 lbf.

Before the forces and pressures acting on the thermoplastic are further explained, the dimensions of the piece must be outlined.

5.8.6 Side Thermoplastic Pressure

Figure 71 provides a diagram with which dimensions of the side thermoplastic can be calculated.

The value of $S = 6$ inches and $r = 4.25$ inches.

“c” is computed as: $c = 2r \cdot \sin(0.5 \cdot \theta) = 5.51$ inches.

$$d = \frac{1}{2} \sqrt{4R^2 - c^2} = 3.239 \text{ inches.}$$

The area of rectangle $c \cdot d = 17.85$ square inches.

The area of shape “s-c” is 3.82 square inches.

Therefore these areas combined (shaded in yellow) are equal to 21.67 square inches.

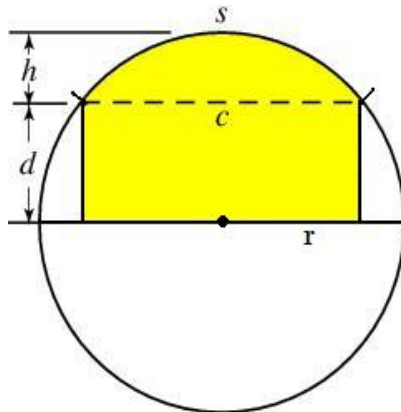

Figure 71- Computation of Thermoplastic Dimensions

When the device is in use, the front and back straps (FHL) exert a collective force of 62 lbf. These point-location forces are balanced by a distributed force due to the side of the body acting on the thermoplastic. This force is distributed such that the highest force is in the center of the thermoplastic, as in the arrangement in Figure 72. Therefore, the forces and the pressure acting on the middle-point of the thermoplastic must be computed, as they are the most critical.

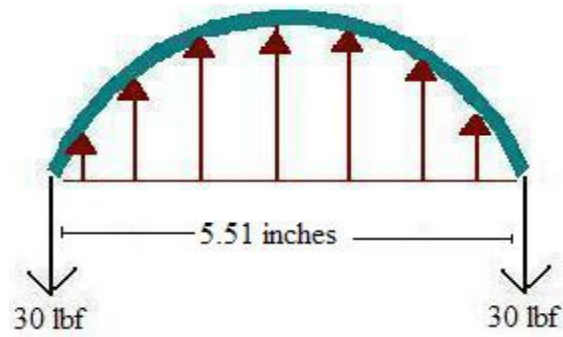
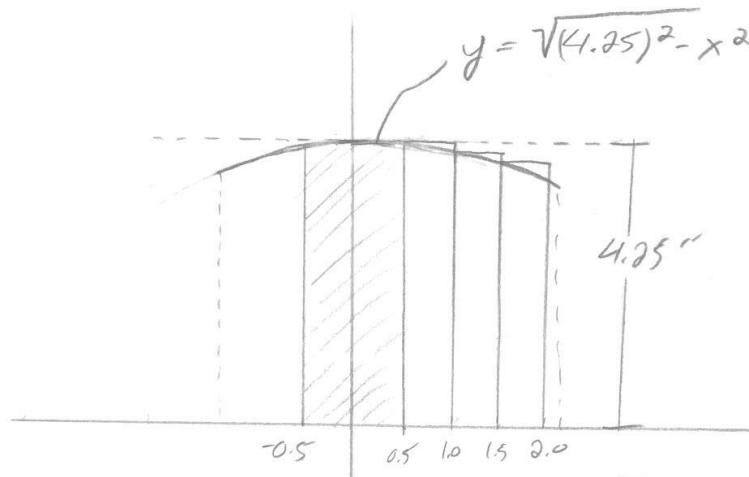
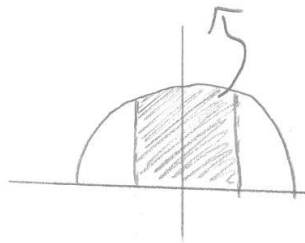

Figure 72- Forces Acting on Side Thermoplastic

To calculate the critical pressure value, a summation of areas under the curve (integration) was computed (Figure 73). To acquire these values, the equation for the semicircle was determined. Next, the shaded area under the apex of the thermoplastic was computed (from -0.5 x-coordinate to 0.5 x-coordinate). This distance, Delta x, has a value of 1 (inch). The area under this curve equals 4.24 square inches. Next, the ratio of the computed area over the entire area is calculated. Because the forces acting on the thermoplastic are proportional to the area under the curve, this ratio helps to figure out the value of forces at particular locations. This ratio is multiplied by the entire force (60 lbf), to achieve the summation of the force acting on this area. This is equal to 11.74 lbf. Divide this force by the area of the thermoplastic upon which it is acting, and a maximum pressure value can be obtained.



Overview of semi-circle:



So, to find peak pressure:

$$\int_{-0.5}^{0.5} y(x) = 4.240 \text{ in}^2 \rightarrow \text{Area Ratio: } \frac{4.240 \text{ in}^2}{21.67 \text{ in}^2}$$

$F \Delta A$

: 20% of total area

$$\text{So, } 60 \text{ lbf} (0.1957) = 11.74 \text{ lbf}$$

$$P = \frac{F}{A} = \frac{11.74 \text{ lbf}}{(1 \text{ inch}) \times (5 \text{ inches wide})} = 2.35 \frac{\text{lbf}}{\text{in}^2}$$

$2.35 \text{ psi} = 121.5 \text{ mm Hg} \therefore$ This Device would be comfortable for approx. 4 hrs of heavy load bearing.

Figure 73- Computation of Maximum Pressure in System

From above, it was determined that the maximum pressure exerted on the body by the thermoplastic is 122 mm Hg. Therefore, this device can be worn for 4 hours under continuous heavy-loading conditions (see Figure 74) This pressure occurs at the “apex” of the thermoplastic, in an area of approximately 5 square inches and is the location of the highest pressure in the entire thermoplastic.

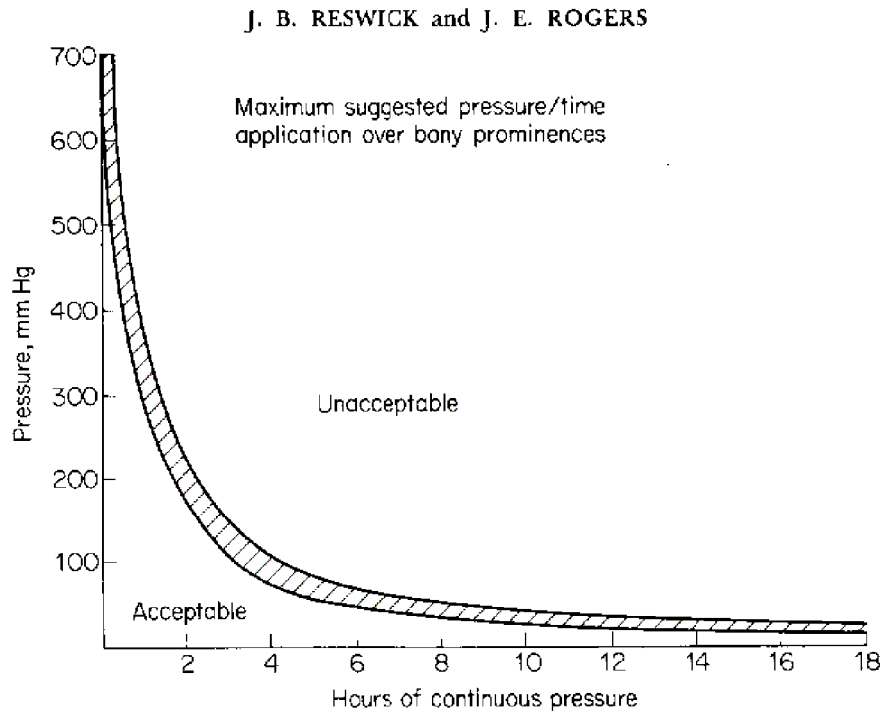

Figure 74 - Allowable Pressure vs. Time under Bony Prominences
©1976

However this high pressure condition is not probable, due to fatigue of muscles from heavy loads occurring far before 4 hours. Yet, the main point to note is that this pressure value does not exceed 160 mm Hg, the maximum “instantaneous” pressure value allowable on particular sensitive areas of human skin. Thermoplastic L is the location of highest pressure under any of the four critical conditions. The pressure on the shoulder by the harness will be lower. Thus, in repeating computations in Figure 5, the area under the curve will be 28.37 square inches. $4.240 \text{ square inches} / 28.37 \text{ square inches}$. Equals approx 15% of the total area. The max force (40 lbf) is multiplied by $15\% = 5.98 \text{ lbf}$. This force, over an area of 5 square inches results in 1.3 psi, a relatively small value.

Yet, with the values of the pressure exceeding 120 mm Hg, it is still important to reduce this potentially “uncomfortable” pressure. Thus foam padding will be added to the inside of the thermoplastics. This makes for a more comfortable and “snug” fit.

5.8.7 Addition of Foam Padding

The primary concern in locations of high force or high pressure on the body are the development of pressure sores (pressure ulcers). The development of sores is

dependant on both pressure and time. Therefore, memory foam padding will be used on the underside of the thermoplastics where there is contact to the body. Pressure sores and the significance of foam padding were studied by David M. Smith in a 1995 journal article. One important point he states is that “healthy persons seated on a flat board generate pressures of 300 to 500 mm Hg under their buttocks. A 2-inch-deep foam pad reduced this pressure only to 160 mm Hg”¹. This significant reduction in pressure manifests the importance of using foam padding, even if under less critical conditions. The two side thermoplastics are not in particularly “bony” areas on the body, but the harness rests over the shoulder, where the clavicle and may increase the risk of sores. Therefore, custom (to each user) padding will line the insides of the thermoplastics.

VI. FINAL DESIGN

This section describes the final design and, more specifically, provides an overview of each of the components that make up the overall assembly and its sub-assemblies. Delrin® was selected as the material of choice for many of the parts due its low weight, excellent durability, good machinability, and low coefficient of friction. Aluminum was used for selected parts due to its low cost and higher stiffness relative to Delrin®. Omega Max® thermoplastic was selected for the harness due to its rigidity, low weight, and versatility. The nominal dimensions of the ProE parts were changed prior to machining to accommodate a RC5 fit based on the American Standard for running and sliding fits. This class of fit allows moving parts to freely rotate/slide without compromising their ability to be machined. The mechanical drawings in Appendix C – Mechanical Drawings reflect these changes.

6.1 Arm Guide Assembly

The arm guide sub-assembly is comprised of six pieces: the arm guide, the bearing brake knob, the bearing brake, the bearing, and the arm guide caps (x2). The sub-assembly is shown below in Figure 75 and Figure 76. This sub-assembly acts as the interface between the prosthesis and the device.

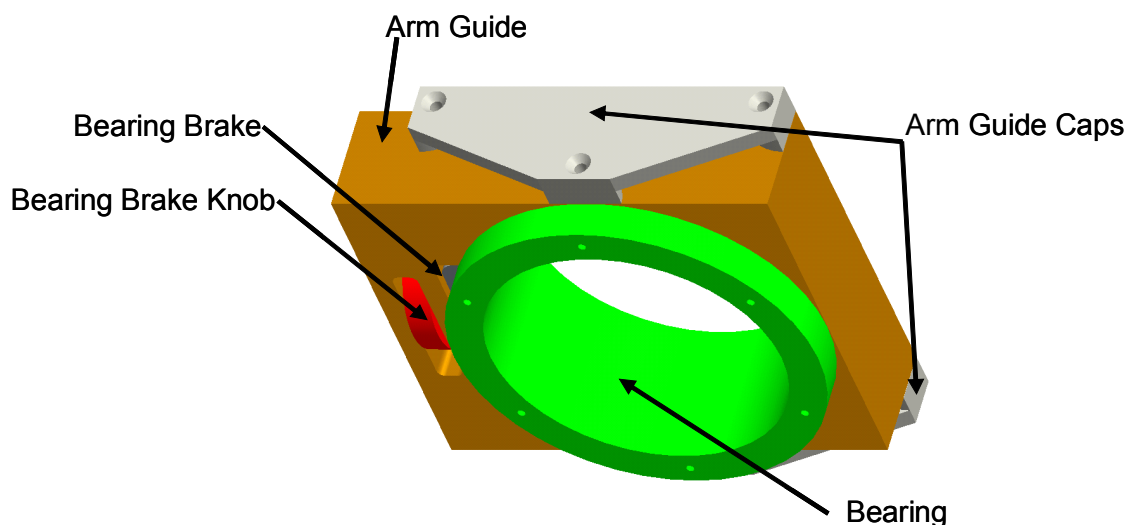

Figure 75 - Arm Guide Assembly (Proximal View)

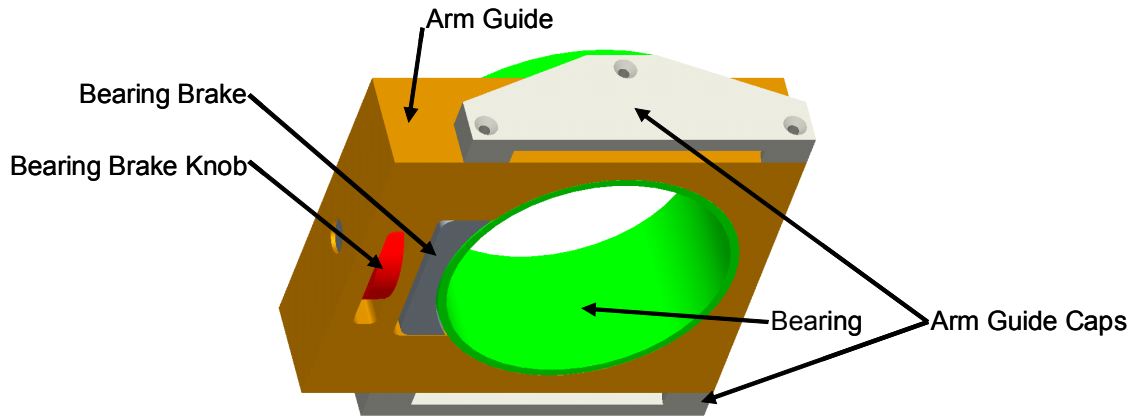

Figure 76 - Arm Guide Assembly (Distal View)

The arm guide (Figure 77) is shown below. There are six holes (three on top, three on bottom) tapped for #8-32 screws. This piece was machined from Delrin®. The function of this piece is to act as a housing for the remaining pieces.

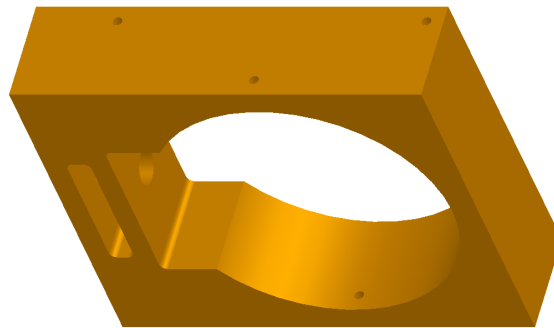

Figure 77 - Arm Guide

Figure 78 shows the bearing brake knob and the bearing brake. Both of these pieces were machined from aluminum. The bearing brake knob is tapped to accept a ½” – 20 threaded post. The bearing brake is machined with a ½” – 20 threaded post. When assembled within the arm guide (Figure 68, above), rotation of the bearing brake knob will cause the bearing brake to move laterally. To increase the coefficient of friction on the bearing brake, a thin strip of thermoplastic elastomer (rubber) was placed on the curved surface.

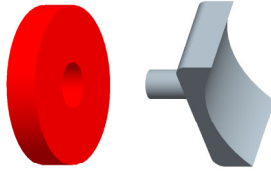

Figure 78 - Bearing Brake Knob & Bearing Brake

The bearing brake is used to prevent the bearing (Figure 79) from slipping. The bearing was machined from Delrin®. The bearing slides into the arm guide from the proximal side since the lip prevents the bearing from slipping through entirely. The piece is allowed to rotate within the arm guide and provides one rotational degree of freedom needed to simulate shoulder motion. This piece has six tapped holes for #6-32 screws located every 60° around the bearing lip. These six tapped holes give the prosthetist a mounting location for the prosthetic socket.

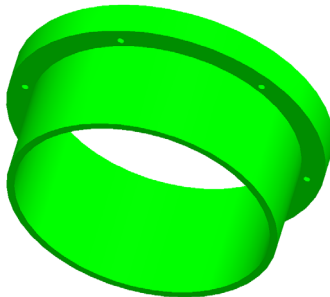

Figure 79 - Bearing

The final piece of the arm guide assembly is the arm guide cap (x2) shown in Figure 80. The assembly requires two of these pieces – for the top and bottom of the arm guide. The arm guide caps were machined from Delrin®. The three holes on the cap are drilled and countersunk for #8-32 machine screws. The arm guide caps hold the arm guide assembly in place against the track assembly (see Figure 81).



Figure 80 - Arm Guide Cap

6.2 Track Assembly

The track assembly (Figure 81) is comprised of six pieces: the tracks (x2), the track posts (x2), the front support, and the rear support. All of these pieces were machined from aluminum. The track assembly is responsible for the remaining two degrees of freedom needed to simulate motion in the shoulder. One degree of freedom

comes from the radius of curvature of the track which forces the arm guide along a circular path. The last degree of freedom is created via the bolts that connect the supports (both front and rear) to the track posts.

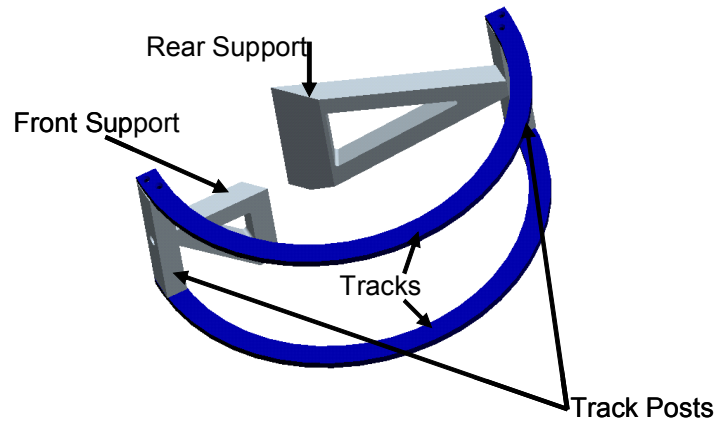

Figure 81 - Track Assembly

The track (x2) (Figure 82) is shown below. The track fits between the arm guide caps (Figure 80) and the arm guide (Figure 77). There are two holes located at either end (four total) which were drilled and countersunk to accept #8-32 machine screws.

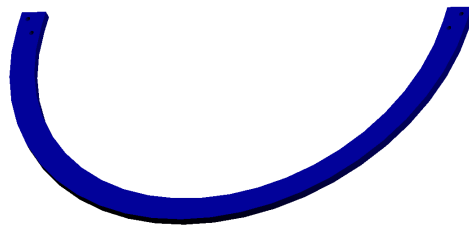

Figure 82 - Track

The track posts (x2) in Figure 83 are used to connect the tracks from above. There are two holes at both ends (four total) tapped for #8-32 machine screws. The center hole acts as a pivot for the 3/8" – 16 carriage bolts used to connect the tracks to the support brackets.



Figure 83 - Track Post

The supports brackets shown below (Figure 84) connect the tracks and track posts to the harness. The end faces of these brackets are tapped for 3/8" – 16 carriage bolts.

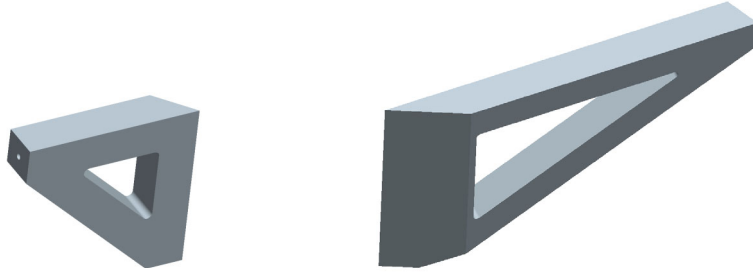

Figure 84 - Front Support & Rear Support

6.3 Harness Assembly

The harness and strapping components of the device included assembling thermoplastic pieces with the strapping and strapping hardware. The “Sliding Alpha Design” was conceived, designed, and manufactured entirely by the team. The overall design of the weight distribution system is displayed in Figure 85:

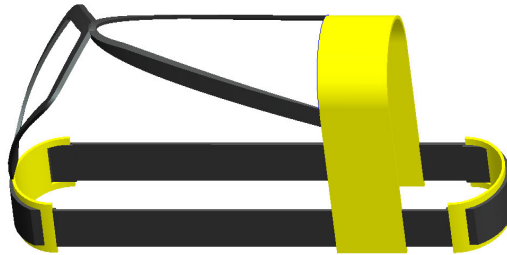

Figure 85- Complete Harness Assembly

The thermoplastic components include a harness with a diameter of 8.5 inches (circumference of 13.35 inches), as well as a length of 5 inches overlapping each side of the body. The harness is made of one continuous piece of thermoplastic, as shown in Figure 86. A further description of thermoplastic manufacturing details is included in section 7.3 Harness.

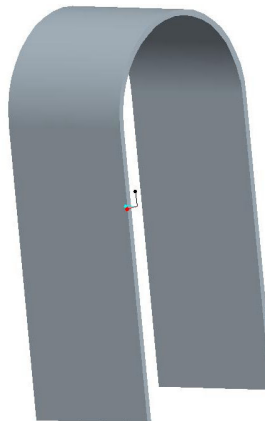

Figure 86- Harness

The two identical side thermoplastic pieces are manufactured from a 13.35 inch long thermoplastic with a diameter of 8.5 inches. They are each cut to a circumferential length of 6 inches and have a width of 5 inches. This is displayed in Figure 87.

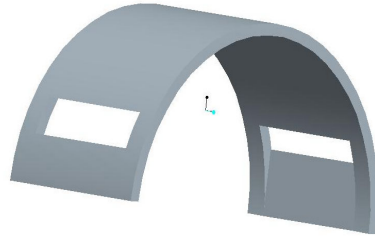

Figure 87- Side Thermoplastic

These thermoplastics were attached to the strapping to create three different strapping systems, all composed of 1.5 inch wide nylon straps: (1) Horizontal system, (2) Diagonal system, and (3) Alpha system, as displayed in Figure 88.

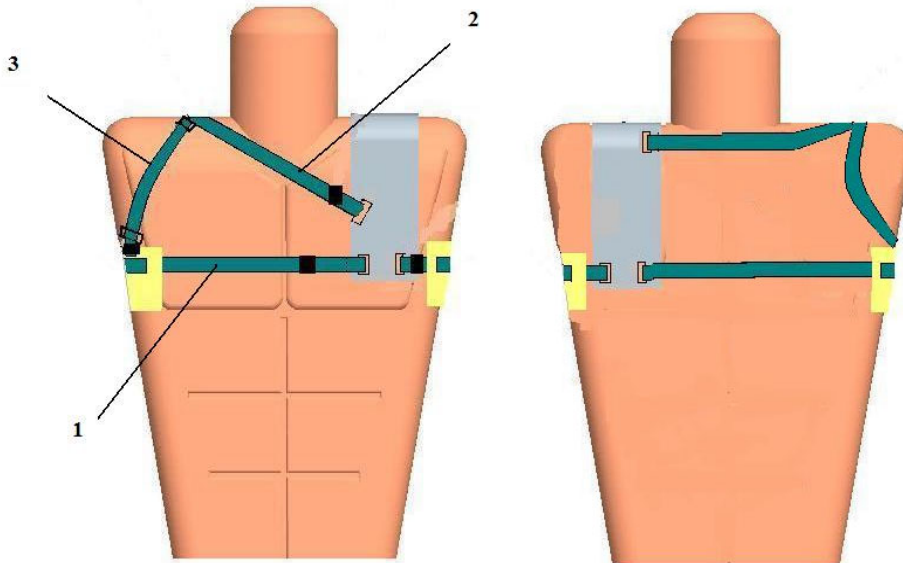

Figure 88- Front and Back Views of Harness Assembly

6.3.1 Horizontal System (1)

The horizontal component consists of two straps sewn to the two front thermoplastic slots and each connected to a female buckle in the front. Secondly, there are two straps sewn to the back of the thermoplastic, woven through a side thermoplastic

piece, slid through a male buckle, and the very end of the strapping doubled over and sewn.

6.3.2 Diagonal System (2)

This component consists of one strap from the front upper thermoplastic slot to the female buckle. Another strap goes from the front male buckle, through one side of the loop connector, wrap around to the back of the thermoplastic, where it is affixed to the slot 1 inch from the top of the harness. This serves to balance moments created on the harness. This strap provides a horizontal balance of moments on the upper-half of the device without causing discomfort to the neck or bust.

6.3.3 Alpha System (3)

This component is one continuous strap from the right side thermoplastic, over the middle of the shoulder and back to the thermoplastic at the same point and sewn together. This strap connects the right thermoplastic (a solid connection point) to the diagonal system by affixing the loop connector to the top of the surface where it meets the diagonal strap. This is done so that foam can be placed under the top part of the alpha strap to ensure comfort. This strap functions mainly to redirect the diagonal strap, so that it may connect to right side thermoplastic, a secure location. For more details concerning Thermoplastic/Harness design, refer to section 7.3 Harness.

6.4 Total Assembly

Figure 89 shows the three assemblies described above (arm guide assembly, track assembly, harness assembly) totally assembled as a single unit. From this view, it is clear how all of the assemblies connect together to distribute forces acting on the terminal end of the prosthesis onto the body.

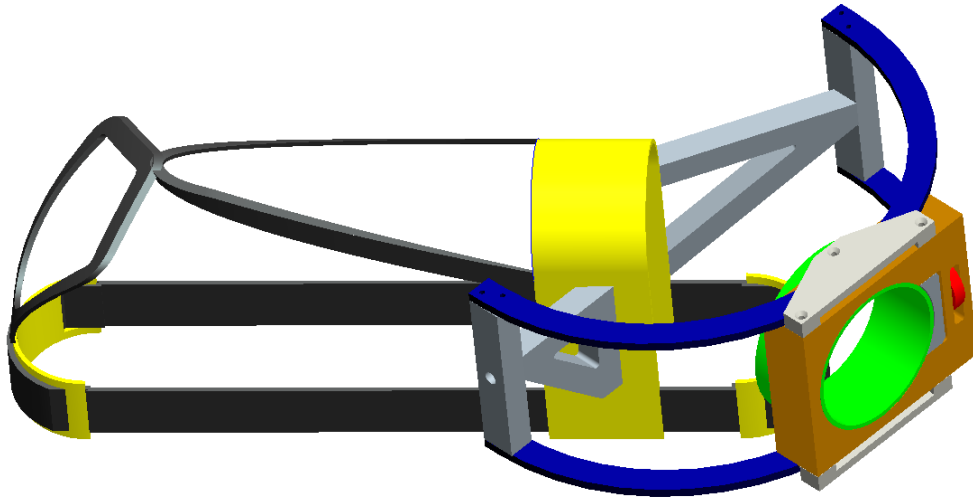

Figure 89 - Total Assembly, Pro-E



Figure 90 – Total Assembly, Actual

VII. MANUFACTURING

This device is composed of parts/components that have been either machined by an outside company or manufactured by the group. The components that make up the track assembly and the arm guide assembly are all machined parts that the group has assembled. The harness assembly and test assemblies have been manufactured and assembled by the group.

7.1 Budget

A key component in all of the manufacturing is constructing a budget that outlines all costs. Table 15 outlines the project budget:

Table 15 - Project Budget

| Supplier | Description | Unit Price | Quantity | Sub Total |
|----------|---|------------|----------|-----------------|
| 1 | Omega Max, Perforated Thermoplastic Splinting Material 1/8 in. x 18 in. x 24 in. | \$56.95 | 1 | \$56.95 |
| 2 | Nylon Strapping – 50ft section—1.5 inches #WPR150 | \$19.20 | 1 | \$19.20 |
| 2 | Loop Ring, Nickel Plated Steel For 1 1/2" webbing #LPN150 | \$0.55 | 2 | \$1.10 |
| 2 | Side Release Buckles For 1 1/2" webbing #BSR150 | \$2.97 | 3 | \$8.91 |
| 3 | Foam Padding | \$8.99 | 1 | \$8.99 |
| 4 | Machining Costs (includes materials) | \$0.00 | 1 | \$0.00 |
| 5 | PVC Pipe | \$0 | 1 | \$0 |
| 5 | Miscellaneous (glue, hardware) | \$20.00 | 1 | \$20.00 |
| | Shipping and Handling Costs * | | | \$26.00 |
| | | | | |
| | TOTAL: | | | \$141.15 |

* Shipping Costs based on Suppliers

List of Suppliers:

1: North Coast Medical

<http://www.beabletodo.com/StoreFront.bok>

2: American Home & Habitat Inc.

<http://americanhomeandhabitat.com/>

3: Spag's 19

4: Kokos Machine Shop: <http://www.kokosmachine.com/>

5: Home Depot

7.2 Machining

Machining was completed at Kokos Machine Company in Dudley, Massachusetts. They make parts for General Electric, Boston Scientific, and take on smaller contracts as well. ProE part files (.prt) and assembly files (.asm) were e-mailed to the owner, Thomas Kokosinski, after mechanical drawings were discussed at a meeting. Parts were machined on a SuperMax FV102A milling machine, with 20,000 rpm spindle speed, 40"x21"x21" travel, and a 24 tool automatic tool changer. The threaded post on the bearing brake was machined on a Hardinge CNC lathe. Due to a prior, established relationship with Mr. Kokosinski, we were able to receive a discounted price on all machined parts. Both material costs and labor were provided free of charge.

7.3 Harness

Manufacturing of the thermoplastics and strapping was performed over the course of four days. After planning and preparing materials the "Sliding Alpha Harness" was manufactured, as displayed in Figure 91:

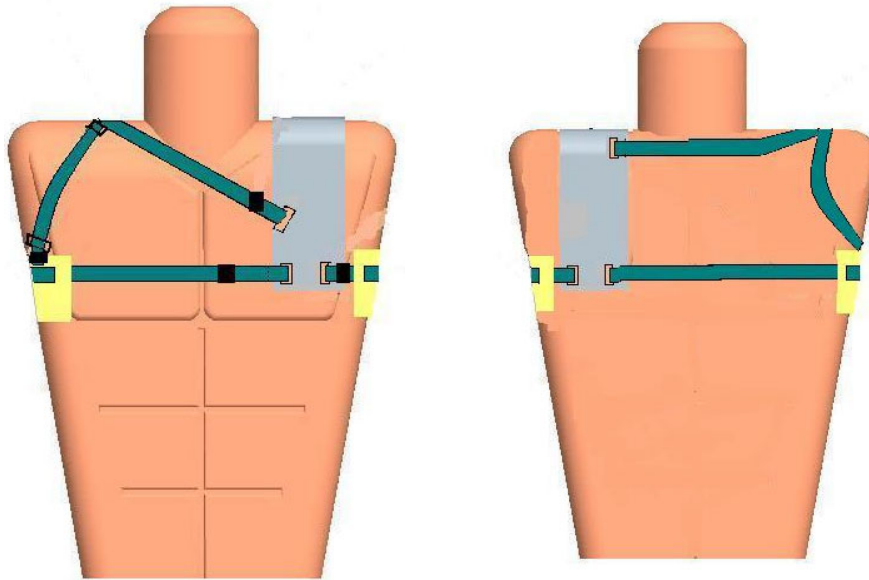

Figure 91- Front and Back view of "Sliding Alpha Harness" System

The components of the system include:

- (1) 50 Feet Poly-Pro Nylon Webbing (1 ½ in width)
- (2) 3 Side Release Plastic Buckles
- (3) 1 Metal Loop connector
- (4) Heavy-duty button thread

- (5) Size 18 needle
- (6) Foam Padding
- (7) 0.25 inch plastic tubing
- (8) Gorilla Glue

The manufacturing of the entire system was achieved in the following **6 steps**:

(A) Manufacturing of Thermoplastics

- (1) Created U-shaped harness and two side thermoplastic pieces to fit large male and fulfill device function requirements
- (2) Cut slots in thermoplastic
- (3) Foam Padding was added to the back of all thermoplastics

(B) Manufacturing of Strapping

- (4) Sewed buckles to strapping systems
- (5) Sewed strapping systems to thermoplastics
- (6) Made size and length of strapping adjustments due to donning by test subjects

7.3.1 Manufacturing of Thermoplastics

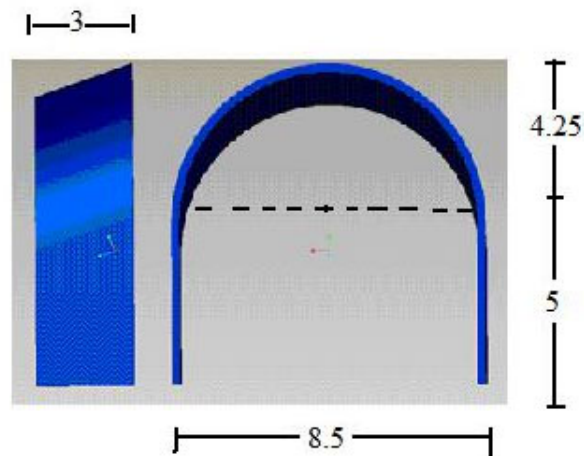

Figure 92 - Front and Side view of Harness

The first step in the manufacturing process was to make the thermoplastic. First, the value of the harness slope was determined by having four test subjects stand against a whiteboard. The angle that their trapezius muscle makes with the horizontal was calculated using trigonometry. The distance between the legs of the harness was determined by having each group member stand against the whiteboard sideways. The

thickness of the body was noted on the whiteboard and later measured. The data gathered is shown in below (Table 16) and some dimensions of the thermoplastic are shown in Figure 92 above.

Table 16 - Slope of trapezius muscle

| Subject | Angle to Horizontal (degrees) | Thickness of Torso (inches) |
|---------|-------------------------------|-----------------------------|
| EP | 15 | 7.75 |
| ZD | 16 | 8.25 |
| JM | 17 | 7.50 |
| MB | 22 | 8.40 |

A middle value of 20° was selected as the slope that would accommodate all of the group members, with a maximum angular deviation of 5° for EP. A thickness of 8.5 inches was selected, as it accommodates all group members. There will be a maximum deviation of 1 inch for JM, but this will be compensated with foam padding beneath the thermoplastic. While not ideal, the use of padding allows all members to don the harness with limited loss of function.

Using the unbend function in the sheetmetal package of ProEngineer, the developable surfaces of the harness were displayed as flattened parts. Figure 93 shows the harness as a flat piece of thermoplastic.

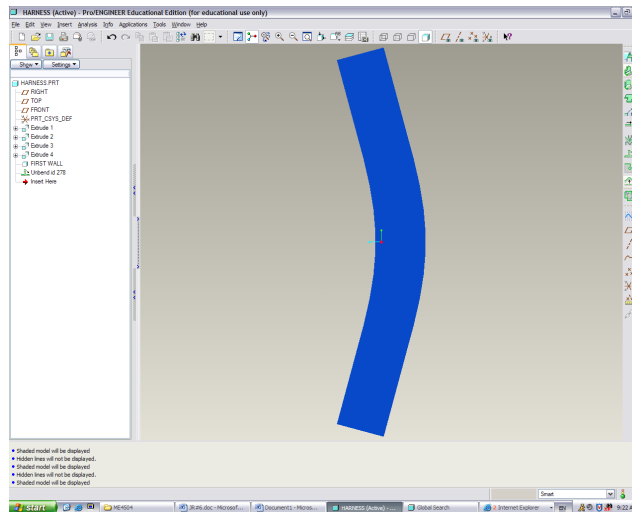

Figure 93- Unbend Function in ProE

The curvature of the flat piece does not remain constant, so it was difficult to measure the exact dimensions of the part. Therefore, to cut the piece on the thermoplastic, a scaled version of the unbent ProE model was printed out and the shape of the harness was drawn onto the thermoplastic and cut out with a band saw.

Next the cut thermoplastic piece was molded to the correct shape by heating the thermoplastic to the manufacturer's specification of 160 degrees Fahrenheit. Upon heating to this temperature, the plastic becomes pliable. Therefore, it was laid over a durable 8.5 inch diameter bucket, where it rested and cooled for 3-4 minutes.

The harness (as well as other thermoplastic pieces) was formed from one OmegaMax Perforated Thermoplastic worksheet (1/8 in x 18 in x 24 in). The two side thermoplastics were measured and cut in a similar manner. An overview of the worksheet is displayed in Figure 94:

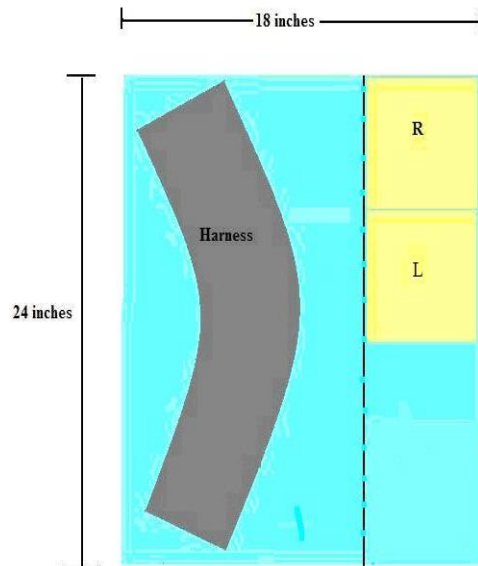

Figure 94- Thermoplastic Worksheet

Next the slot cuts were outlined to the dimensions of 1.50 inches and a width of 0.25 inches. The outer-most edges of the slots were cut 1 inch from each side of all thermoplastics with a 0.25 inch drill bit and a drill press. The slots and the sides of the thermoplastics were filed and heated so the edges were smoothed and rounded. The edges of all thermoplastics were lined with 0.25 inch plastic tubing to prevent any sharp edges.

Lastly 1 inch foam padding was added to the back of all thermoplastics. This was accomplished by using both a slow-setting glue, as well as “sewing” the foam padding onto the device with clear nylon string, weaving through the perforations in the thermoplastic. Thus, the thermoplastic manufacturing was completed.

7.3.2 Manufacturing of Strapping

Next, manufacturing of the strapping system proceeded. This portion primarily included sewing the strapping to the buckles and thermoplastics in a logical and strategic manner. Some of the critical points noted in the manufacturing of the system are displayed in Figure 95.

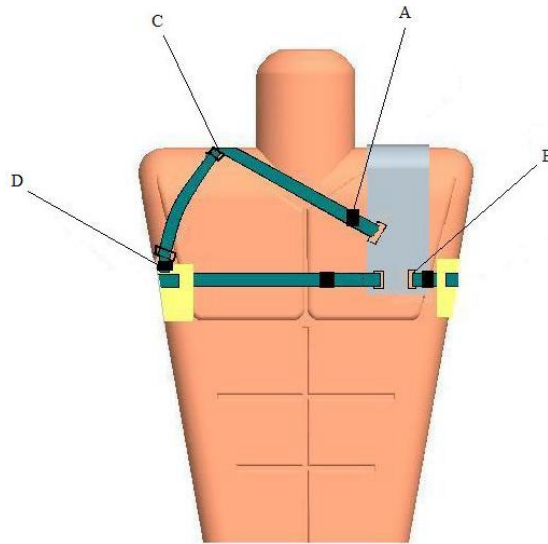

Figure 95- Four Critical Points in Manufacturing

7.3.2.1 Point A: Side-Release Buckle

At Point A, along with point B and the black rectangle near the centerline of the body, all signify a side-release buckle. The buckles function as means of tightening the straps for a tight fit to the body, as well as providing ease of don and doff. All buckles are within easy reach of the user's right arm. A buckle is shown in Figure 96:



Figure 96 - Diagram of Buckle

7.3.2.2 Point B: Method of Attachment to Thermoplastic

At point B, the straps are inserted underneath the surface of the harness, brought through the slot, folded over upon itself, and sewn tightly. This makes for a secure fit

with minimal translational movement, Figure 97. All of these types of connections are located on the harness.

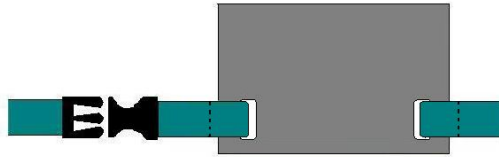

Figure 97 - Attachment to Harness

At other points, such as the side thermoplastic piece, the strapping is weaved through. This is accomplished by inserting the strapping underneath the thermoplastic on one side, through the slot, over the thermoplastic, in the opposite slot, and to the next piece, Figure 98.

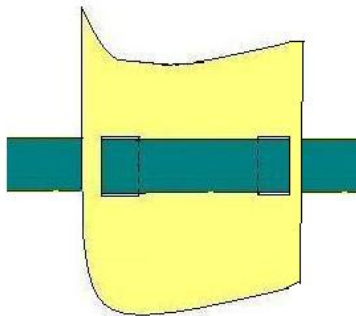

Figure 98 - Attachment to Side Thermoplastic

This form of insertion has two main benefits: (1) It minimizes the amount of surface area upon which the strapping is beneath the surface of the thermoplastic. In tightening the strap, one is compressing the thermoplastic to fit more snugly against the body. Specifically, the more surface area of the strap that is in contact with the harness, a better distribution of pressure will be provided, creating a more snug fit. (2) the distance between the slots needs to be maximized for stability purposes; if the harness has a tendency to move up or down, the side of the strap touching the top or bottom of the slots helps to prevent the harness from accelerating. With these points close to the harness edge, there is greater ability to counteract forces (couples).

7.3.2.3 Point C: Connection of Alpha Strap to Diagonal Strap

The connection between the alpha strap and diagonal strap is simply to loop the diagonal portion through the loop connector, while the alpha strap has the other side of the loop connector affixed to the top of the surface. In doing so, forces can be transferred

from the diagonal strap to the alpha strap, yet the diagonal strap is allowed to “flow” through the ring. This allows a user to perform a forward “shrugging” motion of his/her shoulders, preventing the strapping from binding. The setup is similar to the 9 harness except when the user shrugs tension is not lost in either side of the strapping.

7.3.2.4 Point D: Connection of Right-side Thermoplastic (R) to the Alpha Strap

This point of connection consists of a small 4 inch portion of strapping looped around a slot on the bottom of the thermoplastic. The loop connector is horizontally aligned in the center of piece R and is vertically located 1 inch from the top of the piece. This is displayed in Figure 99.

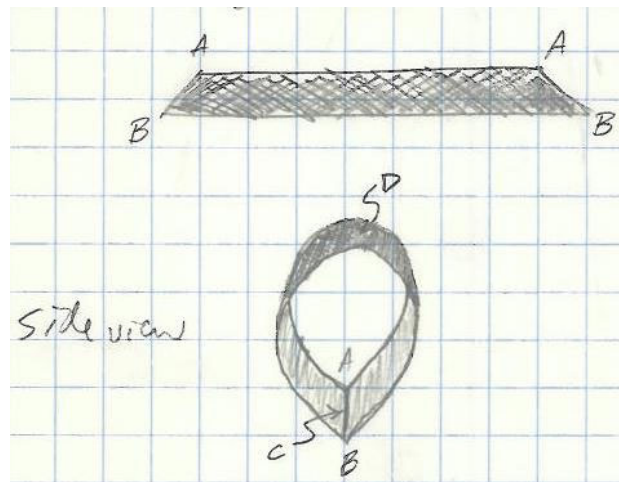

Figure 99 - Alpha Harness Design

Thus, manufacturing of both the thermoplastic and strapping components were completed. Small adjustments, such as shortening strapping were completed. The completed system was donned by several of the group members and successfully fit.

VIII. PROTOTYPE TESTING PROCEDURES

To test whether the proposed Shoulder Mount device successfully fulfilled the three main functional requirements as previously identified, a series of tests were performed. The testing procedures incorporated a group member as the test subject whose purpose was to wear the device and subjectively comment on its function and comfort under load. For assessment of the device under loading conditions, a custom-made apparatus to serve as a 'Mock-Prosthesis' was constructed out of 3" PVC pipe with an end cap cemented to one end, which allowed for fixation of the Mock-Prosthesis into the bearing, to simulate actual attachment. Further, to assess the displacement of the harness, the test subject donned a skin-tight white t-shirt that allowed for direct tracing of the harness onto the shirt and displacements thereafter to be recorded.

8.1 Construction of Mock-Prosthesis

The construction of a Mock-Prosthesis out of 3" i.d. PVC pipe was created to mimic the functions of the Shoulder Mount under various load bearing situations. The Mock-Prosthesis was cut to approximately 40" in length to resemble the arm length of a 95th-percentile male- as reported by the National Center for Health Statistics (2004). An end cap was cemented onto the end of the cut segment using standard PVC cement. Six holes were drilled in the end cap, 60 degrees apart for mounting purposes. To secure the Mock-Prosthesis to the bearing, six 90° brackets were secured to the proximal end of the PVC using the holes drilled in the end cap. The brackets were then aligned with the six holes in the bearing. Two Mock-Protheses were constructed: one for the axial testing procedure and an additional one for the torsional test. For step-by step guide to manufacturing the Mock-Prosthesis, reference

8.2 Range of Motion Assessment

The ability to move the shoulder joint in a wide variety of directions is vital for complete functionality in ADLs. Prior to manufacturing the Shoulder Mount, a range of motion assessment was performed on the 3-D CAD model in Pro-Engineer. Joint motion in the model was defined in two ways. The first was the joint limitations which were imparted to serve as references for the natural joint ROMs. The second was using servo motors to generate motion in the joints. These motion generators were defined using a table that specified time versus joint angle. Tables were created that simulated the desired movements. Simulation of humeral range of motion was conducted, producing a 3-D trace curve and solid envelope which allowed for visualization of the expected range of motion. Post-manufacture, a pretest evaluation of the user's existing range of motion was conducted, where the base envelope of humeral movement was defined. A group member performed three motions while another member recorded the range of motion in degrees. The motions consisted of vertical abduction/adduction in the frontal plane, forward flexion/extension in the sagittal plane, and horizontal abduction/adduction in the transverse plane. The same range of motion assessment was conducted after the device was donned, allowing for comparison and calculation of the percent decrease in range of motion. The device itself was further tested for component interference.

8.3 Axial testing

In addition to accommodating activities of daily living without interference, the shoulder mount must further incorporate lifting loads greater than those of everyday objects (i.e. hairbrush, toothbrush, dinnerware, phone, etc), such as lifting a suitcase (≈ 60 pounds). Existing prostheses are commonly attached to the user by vacuum suction. While this method does provide a sound fit against the residual limb, allowing for functionality in low-force activities, it does not allow for larger loads to be applied distal from the residual limb, as the vacuum force holding the prosthesis cannot counteract the distal, externally applied force. On the other hand, prostheses attached via strapping may support these axial loads, but do not allow for loading throughout the range of motion.

The goal of the axial test was to determine what (if any) changes occur to the Shoulder Mount when a 5 pound incremental force, from 5 to 70 pounds, was applied to ensure that the prosthesis will remain situated in the device during axial load bearing situations. Weight was applied directly along the x-axis as defined in the global coordinate system, via the use of a calibrated spring scale and application of force exerted from a group member until a maximum weight of 70 pounds was achieved. Analysis of the Shoulder Mount was based on the measurements of displacement of the harness with respect to its original placement on the body and each individual component's ability to maintain functionality.

8.4 Torsional Testing

An example of a normal activity that a prospective user would undergo in daily living where torsional loads occur would be lifting an object to the face, such as holding a glass in front of his/her mouth, where the elbow is bent at some angle, θ , the arm is abducted and parallel to ground, and the forearm is parallel to frontal plane. The free body diagram of Position 4 modeled the same anatomical setup using higher forces. Analysis with higher forces was selected as lower-force activities near the face are fully accomplished with prosthetic systems attached via vacuum suction. The Shoulder Mount incorporates a user-controlled friction brake attached to the arm guide. This functions as a means to prevent humeral rotation under loading conditions which would cause torsional loading to the prosthesis. Clockwise rotation of the bearing brake knob moves the brake towards the bearing, thus creating a frictional fit between the two components, prohibiting rotation.

The goal of the torsional test was to determine the overall effectiveness of the variable friction brake and the harness response under application of torque. A constant torque of 28 ft-lbs (in 4 ft-lbs increments) was applied to the Mock-Prosthesis and the harness response was recorded. The number of revolutions the variable friction brake needed to hold the Mock-Prosthesis in place was recorded in order to analyze how much strength a user must possess to tighten the brake. To calculate the amount of torque needed to tighten the brake to the same fit, a spring scale was attached to a 1.25" bolt which was inserted into a hole drilled into the brake knob. A team member pulled on the spring scale to tighten the knob and recorded the required force to tighten.

IX. RESULTS AND DISCUSSION

Both computer and laboratory-based assessment of the Prosthetic Mount were utilized for reporting on the overall functionality of the device. Each test procedure was performed three times, ensuring repeatability in the measurements recorded.

9.1 Range of Motion Assessment Results

Prior to conducting the laboratory test procedures, a series of preliminary analyses were performed in Pro-E to determine the range of motion enabled by the device. After manufacture, the allowable range of motion in the device was then compared to the results obtained during laboratory testing. Conducting the test procedures with the use of a test subject allowed for specific and measurable assessment of the device.

9.1.1 Preliminary RoM Assessment

Pro-E was used for preliminary analysis of the device to ensure that the design could incorporate the desired range of motion. The first major result of the Pro-E model was the verification that the wearer of the device could reach the area surrounding his or her head since this is where many of the activities of daily living take place (i.e. eating, brushing teeth, combing hair, etc.). The model was able to show that the wearer of the device could successfully reach the mouth and surrounding areas of the model's head.

The second major result of the model analysis was the determination of baseline values for the limits on the range of motion. This was done by inspecting where the model interfered with the body. First horizontal abduction/adduction was tested where zero degrees was considered to be with the arm extended in the frontal plane, parallel to the ground. The limit for abduction far exceeded human capability, however adduction was limited to -55 degrees below the global coordinate defined x-axis where the device tracks interfered with the torso. Next, flexion and extension were tested where zero is referenced as the arm in the sagittal plane, pointing directly at the ground. Motion was limited in the forward direction to 140 degrees, while in the rear direction was limited to -20 degrees. There was no limit imposed by the model on humeral rotation (Table 17).

Table 17 - RoM Comparison Between Human and Computer

| Motion Performed | “Normal” Human-Enabled RoM (°) | Pro-E Model-Enabled RoM (°) |
|-------------------------------------|-----------------------------------|--------------------------------|
| Horizontal Abduction / Adduction | 50.3 to 110.1 | -55 to N/A |
| Flexion / Extension | -14.7 to 111.9 | -20 to 140 |

Comparing the Pro-E model to “Normal” Human-Enabled range of motion, it can be concluded that the range of motion needed to successfully perform ADLs is sufficient. The range of motion for humans to successfully complete ADLs falls within the range of motion envelope created by the Pro-E model.

Post-manufacture, the device was placed on a tabletop, such that the harnessing system was resting in the same upright position that it would be if donned by a user. Using the same zero references as described above, the track and arm interface subassemblies were first vertically translated counterclockwise (mock-abduction) to test for interference with the thermoplastic and to calculate the maximum vertical angle allowed by the device. This was followed by a vertical translation clockwise (mock-adduction) to test for interference with the thermoplastic and to record the minimum vertical angle. While the device permitted full motion counterclockwise with no interference with the harnessing system until 140°, which exceeds the range of motion enabled by the shoulder, the device was limited in the clockwise direction. The track and arm interface subassemblies came in direct contact with the main thermoplastic at 55° below the x-axis, as defined in the global coordinate system. This angle measure directly correlates to the expected minimum device angle as presented in the Pro-E model.

The arm guide subassembly was then manipulated across the track to obtain the allowable range of motion in the horizontal direction. The device allows for 120° of horizontal movement, or -20° of horizontal abduction and 100° of horizontal adduction, when resting flat on the tabletop. In reality, the angle of the track on the harness is oriented at ~40°, so range of motion enabled by a user is going to differ. These measures, however, accurately represent the range of motion as presented in the Pro-E model.

9.1.3 Range of Motion

A range of motion assessment was performed on a group member prior to donning the device (Table 18), with the same motions mimicked after properly donning the device. A ‘zero’ or neutral position was selected for each pair of motions. For vertical abduction/adduction the zero position was along the global coordinate system’s x-axis. For flexion/extension, the zero position was at 55° below the global coordinate system’s x-axis. For horizontal abduction/adduction, the zero position was along the global coordinate system’s x-axis, the same for vertical abduction/adduction.

Table 18 – Average RoM Measures

| Motion Performed | Pre-Don (°) | Post-Don (°) |
|-------------------------|------------------------|-------------------------|
| Vertical Abduction | -75 | -65 |
| Vertical Adduction | 10 | 10 |
| Forward Flexion | 125 | 107 |
| Extension | -35 | -21 |
| Horizontal Abduction | -10 | -10 |
| Horizontal Adduction | 115 | 106 |

The group member placed his arm through the arm guide. Donning the device and running through the motions provided a visualization of the envelope of motion that the device would provide a prospective trans-humeral amputee. Full range of motion, as defined by the vertical abduction/adduction prior to donning the device was 85°, which after donning the device reduced to 75°, a 11.8% decrease. The ability to forward flex and extend decreased by 20%. Horizontal abduction/adduction decreased by 7.2% (Table 19).

Table 19 – Average Decrease in Reported Motions

| Motion performed | Pre-don ROM | Post-don ROM | % decrease in ROM |
|--------------------------------|--------------------|---------------------|--------------------------|
| Vertical Abduction/Adduction | 85° | 75° | 11.8% |
| Forward flexion/extension | 160° | 128° | 20% |
| Horizontal abduction/adduction | 125° | 116° | 7.2% |

Although the 20% reduction in forward flexion/extension is significantly higher than the other motions performed, the loss does not effect the range for successful completion of ADLs. Loss occurred where the arm and Prosthetic Mount performed extension, where the arm and Prosthetic Mount were brought behind the body. To further

ensure the device would not hinder performance of ADLs the test subject completed an array of activities and mimicked and went through the range of motions necessary for completion of the four main functions while the device was donned (Figure 100 to Figure 105).



Figure 100 - Normal, rested position of device on body



Figure 101 - Positioned to "Carry a Box"



Figure 102 - Positioned to "Lift an Object" to the front of the body



Figure 103 - Pulling open a door



Figure 104 - ADL: Eating



Figure 105 - ADL: Hygiene (Wiping one's mouth)

9.2 Axial Testing Results

The Prosthetic Mount experienced 5 pound incremental axial loading, orientated along the global coordinate system's x-axis, from 5-70 pounds without undergoing displacement about the body. After three trials, the test procedure was repeated to mimic one of the previously functions a user might encounter during daily life, "carrying a 60 pound suitcase". The Mock-Prosthesis was then oriented to 45° below the global coordinate system's x-axis (Figure 106) and incrementally loaded to 70 pounds. Again, the harnessing system did not experience any displacement. Observations made by the test subject indicate that during axial loads, the user's muscles will give way before the harness experiences movement. The test subject had to station himself to resist the loading distal from the body, keeping his feet secure and requiring the use of his opposite extremity to brace himself from accelerating. In neither position under loading did the components experience interference with each other.



Figure 106 - Axial Load Test at -45°

9.3 Torsional Testing Results

Direct torque was applied to the Mock-Prosthesis in increments of 4 ft-lbs up to 12 ft-lbs, before the bearing began twisting within the arm guide. Therefore, at this point, the device failed, although there was no movement of the harness. The rubber surface acting against the Delrin® produced a higher coefficient of friction than aluminum against Delrin®, however it was not high enough to withstand the torque.

The device successfully withstood 12 ft-lbs of torque before twisting when the brake was tightened 1.43 revolutions. The amount of force needed to tighten the knob was equal to 11 pounds, or a torque of 1.15 ft-lbs. From the brake analysis, the maximum amount of torque that a 50th-percentile male could generate on a similar sized knob was 13.07 ft-lbs, so this torque is easily obtainable. However, due to the relatively small gripping area on our brake knob, this value of 13.07 ft-lbs may be an overestimate. Therefore, exploration into other braking options is presented in the Future Recommendations section.

X. CONCLUSIONS

For persons with a transhumeral amputation, the application of a prosthetic device is life-changing. It can fully restore the cosmetic appearance of the missing limb and provide an array of functionality to regain participation of the limb in activities of daily living. Current prosthesis designs can almost fully restore a user's natural range of motion, but are limited in their ability to carry high loads. Harnessing systems for upper-arm prosthesis attachment can be manufactured to withstand higher axial and torsional loads. However, the combined use of a harnessing system with a prosthesis can restrict the user's full range of motion. The design of a Shoulder Mount addressed the need to incorporate the benefits of both the application of a prosthesis and a harnessing system to increase load-bearing capabilities without compromising the user's existing range of motion. The device design must further distribute both applied loads and the forces from the proposed device across the body.

A model of the final design was constructed in Pro-E and is composed of three subassemblies: a harness system, a track subassembly, and an arm guide subassembly. The harness system serves as an anchor from which the rest of the device is mounted on and can function from. It is the main area for which all forces, both internal and external to the Mount, are distributed. The harness system is comprised of strapping and thermoplastics. The track subassembly serves as an exoskeletal shoulder joint, consisting of six pieces: tracks (x2), track posts (x2), front support, and rear support. There are three rotational degrees of freedom associated with the shoulder. The track sub-assembly is responsible for two of the three degrees of freedom needed to simulate motion. One degree of freedom comes from the radius of curvature of the track which forces the arm guide along a circular path. An axis perpendicular to the radius of curvature is aligned with the shoulder joint. The second degree of freedom is created about an axis perpendicular to the radius of curvature axis. This axis is formed by the bolts that connect the front and rear supports to the track posts and is also aligned with the shoulder joint. The track subassembly is machined from aluminum. The arm guide subassembly serves as an interface between the device and the prosthesis, comprised of six pieces: an arm guide, bearing, bearing brake knob, variable friction bearing brake, and the arm guide caps (x2). The bearing is allowed to rotate within the arm guide and provides the last

rotational degree of freedom needed to simulate shoulder motion. This axis intersects with the previous two at the shoulder joint. The arm guide subassembly is machined from aluminum and Delrin®.

Preliminary analysis was completed on the device to ensure that it would meet the functional requirements prior to manufacturing and be suitable for wear on the human body. Four critical loading positions were defined: (1) carrying a 60 lb suitcase to the side of the body, (2) carrying a 40 lb box in front of the body, (3) pulling open a door, and (4) performing a range of high-force activities near the face and analyzed using Free Body Diagrams. From the manual analysis it was determined that the device should be able to withstand 60 pounds of axial loading along and 25 foot-pounds of torque about the humeral axis. The greatest force that the body would experience from the strapping component would be ≈ 62 pounds. The surface area of the harness systems was therefore designed to distribute these forces so as not to exceed maximum comfortable pressures. To determine the appropriate geometries and materials that limit the stresses and deflections experienced by the device, Delrin® and aluminum models were compared under full (25 ft-lbs) and half (12.5 ft-lbs) torsional loads using ANSYS. Unacceptable deflection of the Delrin® track led to the manufacture of the track in aluminum, as it could withstand greater loads. Finally, the device dimensions were optimized in order to deliver the maximum range of motion while minimizing device size. The focus was on changing the track radius vs. altering arm guide height. The critical outputs were forward flexion in the shoulder joint and flexion in the elbow, using measurements from a 90th percentile male for weight and a 50th percentile male for height. Minimizing the distance along the arm yielded radical changes in elbow flexion as opposed to changing the arm guide height, as there is an exponential decrease in elbow flexion with respect to location along the upper arm compared to a more linear decrease in elbow flexion with respect to arm guide height. Thus, for optimal performance, the device would need to attach as proximally on the arm as possible.

After manufacturing the device a series of laboratory tests were completed which proved the device to fully meet the functional requirement to withstand great axial loads while remaining stable on the body. There was no translation of the harness across the body when axial loads up to 70 pounds were applied. Full range of motion, as defined by

the vertical abduction/adduction prior to donning the device was 85°, which after donning the device reduced to 75°, a 11.8% decrease. The ability to forward flex and extend decreased by 20%. Horizontal abduction/adduction decreased by 7.2%. The device, however, did not withstand torsional loads as expected. Under 28 ft-lbs of torque, the Mock-Prosthesis rotated in the bearing, as the rubber/Delrin® interface did not provide ample coefficient of friction to prevent rotation. The device can, however, withstand 12 ft-lbs of torque before rotation of the bearing occurs using the rubber/Delrin® interface.

Future recommendations for the device include an enhanced customization of the harness, allowing for a closer fit and minimizing the amount of work that a prosthetist would need in assembling the device, creating a more reliable, easier to operate brake, minimize excess weight, allow the user to gain better control over the range of motion, and enhance the applicability of the device to not be limited to transhumeral prosthesis users, but also incorporate upper-arm orthosis users.

XI. RECOMMENDATIONS

After testing the prototype, compiling the results, and discussing the outcomes, the last step is to address the end results that did not meet the expectations. Closely examining the unmet or under met expectations can give a better idea as to why these deficiencies occurred and allow the designer to propose new solutions. The purpose of the future recommendations section is twofold. First, it is to address the shortcomings, explaining why they happened and then suggesting possible solutions. The second is to propose general areas of development for the future of the design. Generally this would be the step before continuing on to a second generation prototype.

11.1 Standardization of Harness

The prosthetist is an integral aspect of our design. He or she is responsible for creating the lip on the prosthetic socket and forming the thermoplastic to the user's body. However, during assembly, it became clear that the prosthetist would also have to mount the support brackets and possibly machine them to the proper shape/size. While it is reasonable to expect the prosthetist to be able to create a custom prosthetic socket and to form a close-fitting shoulder harness, it is not reasonable to expect the prosthetist to machine the aluminum brackets for each user.

A solution to this problem would be to separate the shoulder harness into two unique pieces. One piece would be a rigid shell (Figure 107 – left) with a generic shape that is independent of the user. This allows the same support brackets to be used from user to user. The second piece is a formable solid (Figure 107 - center) which can be custom built by the prosthetist. The inner surface of this piece is cast to closely fit the user's body, thereby distributing pressure over the entire surface area. The outer surface of this piece is cast to fit within the shell (Figure 107 – right).

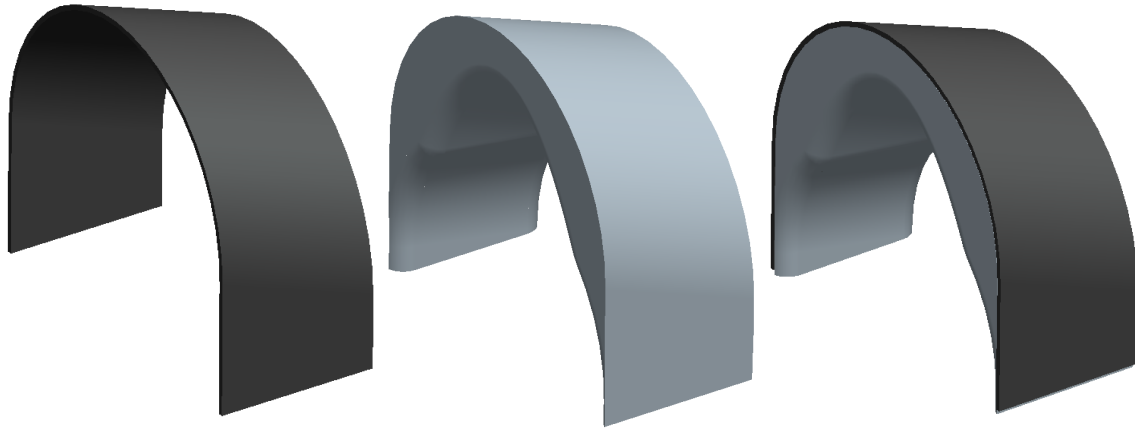

Figure 107 - Universal Harness

11.2 Sliding Alpha Harness

With the current design, the oblique strap that crosses the torso was intended to support the upper half of the harness. While the strap did perform well under the loading conditions and prevented the harness from shifting on the body, its adaptability was poor. It is critical for the operation of this part of the harness that the loop that the arm passes through is only slightly larger than the arm so that when the entire harness is strapped down there is a close fit. The current design presents a problem because the size of this loop is fixed. In the future, a consideration for the loop to be adjustable should be made. Another problem presents itself with regards to the loop size; the smaller the loop the harder it is for the user to don the device. In any case, either a buckle or some other type of adjustment should be incorporated to compensate for the problem.

11.3 Improved Braking Capacity

While the friction brake utilized in the final design withstood 12 ft-lbs of torque, this number was half of our goal. Also, achieving this number required significant torque to be applied to the brake knob. Therefore, future designs would benefit from a more reliable, easy to operate brake. The two design recommendations described below do not use friction as the braking force. Instead, the designs utilize physical connections to hold the bearing in place.

11.3.1 Gear Brake

The gear brake shown below is similar to the final design. The difference is that this design uses gear teeth to brake the bearing. The brake knob rotates to move the

toothed brake (Figure 108 - center) toward or away from the bearing (Figure 108 - right). The arm guide (Figure 108 - left) is cut so that the teeth fit within the arm guide, and thus, line up with the brake. This specific design (Figure 109) has 36 discrete positions in which the bearing can be locked.

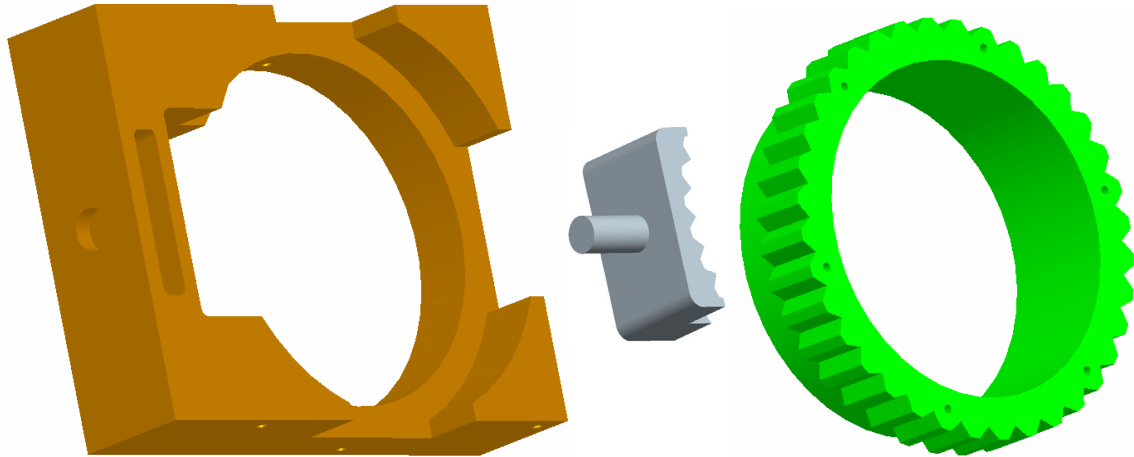

Figure 108 - Gear Brake

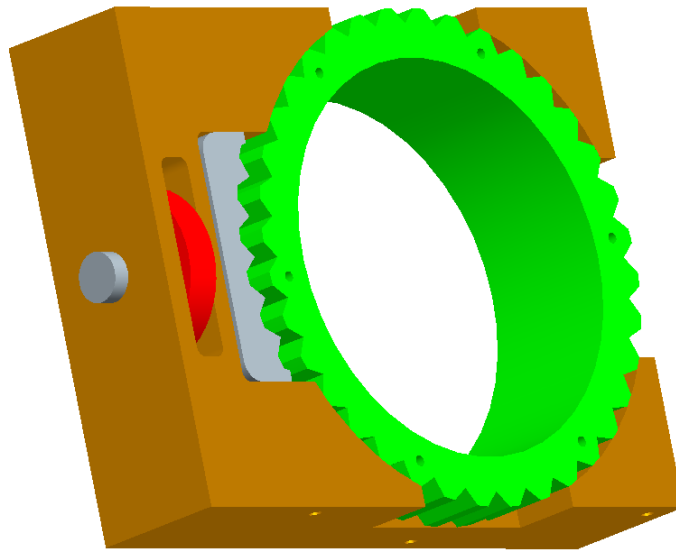

Figure 109 - Gear Brake Assembly

11.3.2 Pin Brake

The pin brake design recommendation is more compact than the previous design. Ten holes have been cut into the bearing (Figure 110 – right). These holes accept the post on the brake (Figure 110 – left). The brake is spring loaded and oriented so that the spring pulls the brake into the arm guide (Figure 110 – center). The brake and the arm guide are equipped with two protrusions spanning 90°. Each set of protrusions is offset

180°. When the protrusions align (Figure 111 – left), the bearing is allowed to rotate freely. Rotating the brake 90° from this position causes the brake engage the bearing, preventing rotation (Figure 111 – right). To allow bearing rotation again, the user simply pulls the brake and rotates it 90°.

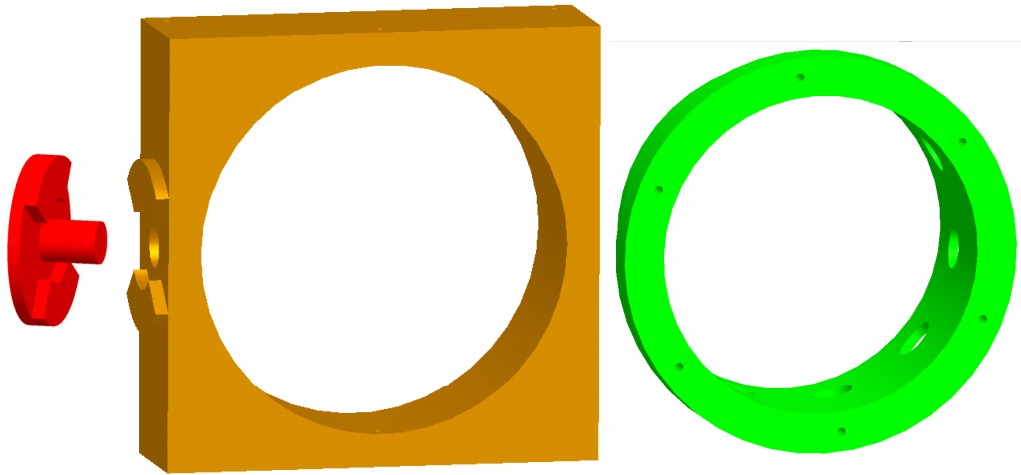

Figure 110 - Pin Brake

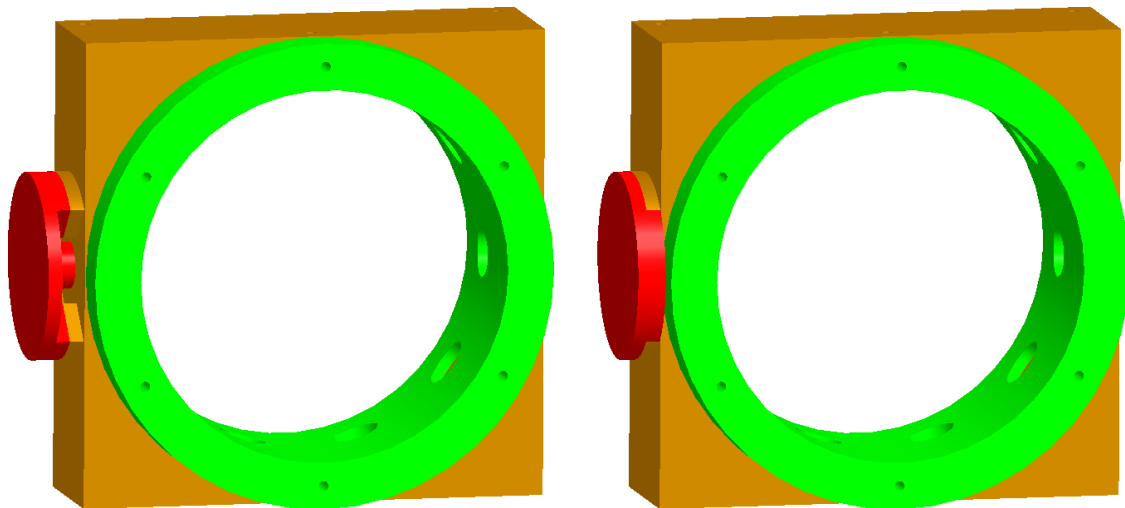

Figure 111 - Pin Brake Assembly

11.4 Weight Savings

The total weight of the assembled device was about 6.5 lbs the majority of which came from the Track and Arm Guide subassemblies. While this is not an impossible or even unreasonable amount of weight to be carried by the user, a reduction in weight is certainly advantageous in this case. In inspecting the assembly there were certainly areas that would lend themselves very well to weight reduction. The first and perhaps most

noticeable were the support brackets; especially the rear. Due to time constraints on manufacturing we did not remove the material from the center of the support brackets as indicated by the original model and part drawings. The rear bracket because of its size therefore added a significant amount of weight that could easily be avoided. The second most noticeable part as far as weight was concerned was the Track Post. The piece was created as a solid block of aluminum. Creating pockets in the sides of these pieces or perhaps through drilling holes would be possible methods of reducing weight. An investigation into whether or not the posts could be made from Delrin® might also prove useful. The third area where some weight savings could be had is in the Arm Guide. The performance of the Delrin® exceeded our expectations and as a result, the components made from Delrin® could be made with less material. The thought is to reduce the thickness of the Arm Guide or again create pockets to remove material. The last place where weight savings is a possibility is in the track. Of all the places this is probably the most tentative as changing the geometry of the part may drastically affect the performance. Drilling holes perpendicular to the top surface of the track would result in some weight savings, however, the results would probably not be as drastic as the others. This should be approached with caution and a proposed design analyzed for stresses and deflections.

11.5 Controlling Degrees of Freedom

The current model only allows the user to control one of the device's three degrees of freedom. The friction brake is used to control the user's humeral rotation, however for the remaining two degrees of freedom the user is left only with his or her residual ability. The use of our device assumes that the user has this residual ability. It is possible that a user would not have such ability and therefore would not be able to utilize our device. A further prototype may include the ability for the user to lock the other two degrees or freedom in place. The idea is that the user would use some means to position the device and then lock it in place. This would allow a user with no residual limb function the ability to carry a load. After developing a way to lock the degrees of freedom there may also be away to power the three degrees of freedom essentially creating a powered shoulder joint transforming the device from passive to active. The difficulty there comes in simultaneously controlling three degrees of freedom.

Also, there remains potential in powering the three degrees of freedom that are found in our device. Our device would then become a powered orthosis and would have much more functionality. However, this idea has not been explored in depth, and much more analysis must be done in order to ensure wearer safety during powered use.

11.6 Enhancing Applicability

The current focus of our device is for use by those who have a prosthetic device. However, there is the possibility that our device could be slightly modified to interface with an orthosis. Specifically, the powered arm orthosis created in an MQP from 2004-2005, which lacks a stable platform at the upper arm and could greatly benefit from our device. For such an application, the bearing would be removed and holes tapped in the Arm Guide to accept the orthosis.

References

- Aetna, Inc. "Myoelectric Prostheses". Clinical Policy Bulletin. (2005) Aetna, Inc. 12 October 2005 <<http://www.aetna.com/cpb/data/CPBA0399.html>>
- "Amputation Statistics by Cause." Limb Loss in the United States. 2005. National Limb Loss Information Center. 26 Apr. 2006 <http://www.amputee-coalition.org/fact_sheets/amp_stats_cause.pdf>.
- "Baby Slings Over the Shoulder Baby Holder." Parent Safely. (2000). 11 October 2005 <<http://www.parentsafely.com/over-the-shoulder-baby-holder/index.html>>
- Biryukova, E.V, Roby-Brami, A., Frolov, A.A., Mokhtari, M. (2000). "Kinematics of human arm reconstructed from spatial tracking system recordings". *Journal of Biomechanics*. 33: 985 – 995.
- "Brown BioMed." Brown University. 1 Nov. 2005. 26 Apr. 2006 <<http://biomed.brown.edu/>>.
- "Delrin" 12 March 2006.<www.MATWEB.com>
- Dowling, Kevin "Robotics Frequently Asked Questions List." Manuel. 1996 (July 2000).
- E-radiography. 20 February 2006. <<http://e-radiography.net/>>
- Farnsworth, T. (2004). "The Call to Arms". Active Living Magazine. 12 October 2005. <http://www.activelivingmagazine.com/artman/publish/article_22.shtml>
- Harris, Tomas. (2005) "How Joysticks Work". 23 November 2005 <<http://computer.howstuffworks.com/joystick3.htm>>
- "Information Center – Limb Loss Frequently Asked Questions." (2005). Amputee Coalition of America. 8 October 2005. <http://www.amputee-coalition.org/nlic_faq.html#3>.
- Kelty™ Illusion Backpack. 2005 Aspen Outdoor Products, Inc. 7 January 2006. <http://www.outdooroutlet.com/shopping.php?pg=product-detail&id=1232>
- Knapik, J., E. Harman, and K. Reynolds. (1996). "Load Carriage Using Packs: A Review of Physiological, Biomechanical, and Medical Aspects." Applied Ergonomics 27.3 Abstract. 8 October 2005 <<http://www.ingentaconnect.com/content/els/00036870/1996/00000027/00000003/art00013>>

Lansang, Jr, Ramon S. and Krouskop, Andrew C. (2001). "Upper Limb Orthotics." eMedicine. 8 October 2005
<<http://www.emedicine.com/orthoped/topic55.htm#section~bibliography>>

"Lumbo-sacral Corset" Durrets O and P. 12 January 2006.
<<http://www.durretsoandp.com/Business/productsbusiness/spinalpage.htm>>

Marymount School. (2005).
<<http://www.marymount.k12.ny.us/marynet/Studentwebwork99/biosystems99/cassieandval/Images/joints/bookballandsocket.gif>>.

Murray, Ingram A. and Garth R. Johnson. (2004). "A study of the external forces and moments at the shoulder and elbow while performing everyday tasks". Clinical Biomechanics. 19: 586 - 594

National Center For Health Statistics. "N C H S --Data Definitions-- a D L." Activities of Daily Living (ADL). 16 Dec. 2004. 26 Apr. 2006
<<http://www.cdc.gov/nchs/datawh/nchsdefs/ADL.htm>>.

"Orthopaedic Surgery: Upper Limb Prosthetic Centre." Department of Orthopaedic Surgery. 2 Dec. 2005. National University of Singapore. 26 Apr. 2006
<<http://www.med.nus.edu.sg/os/facilities/upperlimbprosthetic/>>.

Ozkaya, Nihat and Margareta Nordin. (1999). Fundamentals of Biomechanics: Equilibrium, Motion and Deformation, Second Edition. New York: Springer – Verlan New York Inc.

"Range of Movement (RoM)." Range of Movement (RoM). 1 Jan. 1997. Sports Coach. 26 Apr. 2006 <<http://www.brianmac.demon.co.uk/musrom.htm>>.

Reswick, J.B. and J.E. Rogers, "Experience at Rancho Los Amigos hospital with devices and techniques to prevent pressure sores", Bedsore Biomechanics, 1975

Ritchie, David A. (2005). University of Texas Medical Branch. Upper Limb Prosthetics. Dynamic Prosthetics and Orthotics. 12 October 2005
<<http://www.utmb.edu/footankle/powerpoint%20pdf%20files/orthotics/Upper%20extremity%20prosthetics.pdf>>

Salam, Y. (1994). Technical Forum- The Use of Silicon Suspension Sleeves with Myoelectric Fittings. Academy of Orthotists and Prosthetists. 12 October 2005
<http://www.oandp.org/jpo/library/1994_04_119.asp>

Scheck & Siress (2005). Advanced Prosthetics and Orthotics. 12 October 2005
<<http://www.scheckandsiress.com/Prosthetics/BE%20-%20body%20powered.pdf>>

"Scuba Diving." Wikipedia. 25 Apr. 2006. 26 Apr. 2006
<http://en.wikipedia.org/wiki/Deep-sea_diving>.

Smith, David M. "Pressure Ulcers in the Nursing Home" (1995) Volume 123, Issue 6 Pages 433-438) <<http://annals.org/cgi/content/full/123/6/433>>

"Snugli City Sport Soft Carrier." (2005). 11 October 2005
<<http://www.amazon.com/exec/obidos/ASIN/B0002XO5KG/002-0245950-5091276>>

"Space Suit." Wikipedia. 12 Apr. 2006. 26 Apr. 2006
<<http://en.wikipedia.org/wiki/Spacesuit>>.

Stark, Gerald. "Prosthetic Primer: Upper-Extremity Limb Fitting." In Motion 11 (2001). 26 Apr. 2006 <http://www.amputee-coalition.org/inmotion/jul_aug_01/primer.html>.

Stark, Gerry. "Prosthetics." Prosthetics. 24 June 2005. Northwestern University. 26 Apr. 2006 <<http://www.osler.org/sample/ORT%20Prosthetics.pdf>>.

Thalidomide Victims Association of Canada. (2003). TVAC. 8 October 2005
<<http://www.thalidomide.ca/en/>>

Toren, Sean. "Upper Extremities". 2005. < http://www.amputee-coalition.org/first_step/firststepv2_s1a02.html >

Tortora, Gerard J. and Sandra Reynolds Grabowski. (2003). Principal of Anatomy and Physiology - Tenth Edition. John Wiley & Sons Inc.

Appendix A- Trip Report to Hanger Orthopedic Group

October 5, 2005

Hanger Prosthetics & Orthotics East, Inc.
255 Park Avenue Suite 200

9:30am – 10:30am

All of the group members met with Tim Curran (tcurran@hanger.com), a prosthetist/orthotist at Hanger P&O. Mr. Curran holds a B.S. in chemical engineering and received his certification from Newington (a subsidiary of the University of Connecticut). Upon arrival, Mr. Curran showed us the office, including the examination rooms, the store room, and the machining shop. He explained that each branch of Hanger specializes in a particular aspect of P&O, and while the Worcester branch does not focus on upper extremity prostheses and orthoses, he managed to obtain upper extremity prostheses from the Anaheim branch.

Mr. Curran was able to provide us with extensive details and physical examples of many prostheses that are commonly used. He acknowledged that for our project, we would most likely focus on transhumeral, shoulder disarticulation, and forequarter amputation. Mr. Curran demonstrated how body powered prostheses function. Most prostheses that need to power multiple joints use a system of locking and unlocking to achieve movement. The two joints do not move in tandem; instead, the user flexes one joint, locks it in place, then flexes the other. He also showed us numerous hooks that are used by those who value function over appearance. The hooks are either voluntary open or voluntary close. The strength of the hooks is determined by the number of rubber bands used on the hook (each rubber band is approximately equal to 1 pound force). Typically, users of body powered prostheses must come back every 6-12 months for maintenance.

Myoelectric prostheses read the electrical signals sent to existing muscles and translate those muscle pulses into electric signals that power motors which move the prosthesis. These prostheses are battery powered. Typically, users engage opposite muscle groups to function the myoelectric prosthesis. For example, a transradial amputee may use his/her bicep and tricep to control the prosthesis. A higher amputee (transhumeral or higher) may use his/her pectoral muscle and latissimus dorsi or rear deltoid to control the prosthesis. Because these prostheses use motors to power movement, strength of these prostheses can often exceed the strength of a normal person. Myoelectric prosthesis users must come back for maintenance more often. Things like weight gain or loss can affect the contact with muscles and ultimately affect the effectiveness of the prosthesis.

Mr. Curran told us that many people use multiple upper extremity prostheses. In a workplace environment, an amputee may use a job specific prosthesis (e.g hook) in order to perform certain functions. However, in social situations for example, an amputee may desire something more aesthetically pleasing – something that looks like a real arm. Rejection of upper extremity prostheses remains a major issue. Because people do not need an arm as much as they need a leg, upper extremity amputees often learn to

perform tasks with only one hand. Many find that this outweighs the difficulties in having to clean, don, and learn how to use a prosthesis.

Interestingly, no matter how light a prosthesis may be, users can always feel the weight of the arm. Even when a prosthesis weighs less than the portion of limb that it is replacing, it feels heavier for users. Mr. Curran said that designs must focus on keeping weight as proximal as possible for obvious reasons.

Mr. Curran also described some typical patients he encounters. Some suffer from congenital limb deficiency. These types of cases are difficult since the inner anatomy of the limb may be unknown. Partially formed bones, or “nubbins,” may exist which make fitting problematic. Also, existing nerves may not be ideal for myoelectric prosthesis use. Burns are another common reason for amputation. However, there are often difficulties with skin quality. Residual entrance and exit wounds may preclude the application of many types of prostheses. Skin grafts prevent electrical signals from being sent to myoelectric prostheses. Severe fractures may lead to a malunion of the bones, resulting in what essentially is an extra joint. Trauma, tumors, and osteomyelitis are also potential causes of amputation.

When asked how he would approach our project, Mr. Curran recommended focusing on activity specific or sport specific prostheses. Because the type of harness depends on what type of activity the user wants to participate in, it is very difficult to create something that both a blacksmith who needs something durable and heavy duty and a secretary who just wants something cosmetic would both use. Mr. Curran could not think of any potential uses of a body mount for orthoses since orthoses attach directly to the malfunctioning part of the limb. However, he did acknowledge the existence of ‘prostheses,’ a combination of prostheses and orthoses. For example, someone with a traumatic arm injury may suffer a transradial amputation and also require an elbow brace. These can be combined in one system. Mr. Curran did acknowledge, though, that a universal socket/harness system would enable amputees to only worry about one type of harness for their many prostheses. Also, Mr. Curran said that there are essentially no limits on load bearing post-amputation compared to pre-amputation. If an amputee requires a prosthesis that supports axial loads of 100 pounds because that is what they used to carry before the amputation, there are harnessing systems available that will enable that. However, the actual prosthesis often limits the maximum loads. For example, Mr. Curran can design a harness system that can withstand loads of 100 pounds. However, the amputee cannot use a certain myoelectric prosthesis because the elbow joint is only rated for 40 pounds. Therefore, the amputee must lose some of the overall functionality associated with a myoelectric prosthesis in exchange for a prosthesis designed specifically for carrying heavy loads.

Mr. Curran described some of the current attachment methods for prostheses. One common method is the use of a liner, essentially a sock for the limb. The inside of the liner has a high coefficient of friction against skin and, once rolled on, holds the prosthesis in place. The prosthesis is attached to the liner via a pin on the outside of the liner. Over the shoulder suspension systems vary. The X-frame strapping system is similar to the previous body mount MQP in that it uses a piece that attaches to the side of the torso to improve load distribution. The figure 9 strapping system is used to power body powered prosthesis and also used for additional load bearing in myoelectric prostheses. Triceps cuffs are sometimes used to facilitate the activation of body powered

prostheses. Suction is also used to mount prostheses. However, this type of attachment mandates an intimate fit and a limb without irregularities (e.g. scars, bony protrusions). The suction is controlled with a valve located on the prosthesis. Some prostheses (especially those which support heavy loads) use a combination of the above techniques.

Ironically, these prostheses can greatly improve the quality of life for amputees, but amputees may have difficulty donning the devices since they only have use of one arm. This is why many prostheses and harnesses include donning trees. Donning trees enable amputees to put on the harness and prosthetic without the help of another person.

Mr. Curran also told us about some critical points to consider in the design of our mount. On the elbow, the skin on the inside of the elbow can bunch during flexion, causing problems with fitting. Also, condyles on the elbow offer another problem to consider when fitting. In the armpit and near the shoulder, there are many nerves that one must avoid disturbing when designing a body mount or prosthesis. The heat in the armpit can also cause problems with skin irritation, rash, and sweating. In general, the greater the area over which the load is distributed, the less pressure the user feels. We must avoid bony protrusions (clavicle, ribs, etc) in order to avoid possible fractures or discomfort. Also, check the fit of the design throughout the full range of motion. Bones may become more or less prominent, muscles change shape, and skin bunches.

According to Mr. Curran, liners are typically made of silicone or thermoplastics such as polypropylene. Liner material must be inert. Aloe vera may be used for comfort where the liner makes contact with the skin. It is important that the material is able to be cleaned. Some people use socks to increase padding and make a tighter fit. Carbon fiber is also used, especially in prosthetics, with threaded nylon molded into the carbon. The nylon can add flexibility and color to the carbon fiber. The resulting material is directional; the direction of the nylon threading causes the material to display unique characteristics in different directions. Body powered cables are the same cables used in bicycle brakes and derailleur systems. Not only does this reduce manufacturing costs, it increases the ability of the user to get the prosthesis repaired at any bike shop.

Mr. Curran suggested we look at Hosmer, who make hooks. He also recommended OandP.org and Occupational Therapy as sources for potential journal articles. He also recommended Otto Bock and Liberating Technologies (LTI). LTI is holding a conference in Springfield on November 4th.

Finally, before leaving, Mr. Curran loaned us two examples of prosthetics and harnessing systems which we can use for the duration of our project.

Appendix B – Free Body Diagrams

Carrying a Box

This critical position includes carrying a 50 lbf box with a 55 degree angle between the humerus and the midline of the side of the body, in addition to the forearm (prosthesis) acting parallel to the ground. Assuming that the left and right arm each carry half of the weight of the box, the weight of the box included in the FBD of the prosthesis is denoted as 25 lbf. This position was chosen as a critical loading condition because of real-life situations where a 50 lbf bag of sand or a 50 lbf box must be carried with both hands. This situation could also be interpreted as the user holding a 25 lbf box with only the prosthetic arm and device. The box is away from the body, thus creating a greater moment about the x-axis in the shoulder joint and making the situation more critical. In real-life, the box would be brought closer to the body, thus significantly decreasing many of the resultant forces. The overall Free-Body Diagram can be viewed in the figure below.

Assumptions:

- Elbow joint on the prosthesis does not fail
- User is able to carry 50 lbf from residual musculature
- There also exists a force acting on the harness by the body in a Y-direction, but this force is much less than the y-component of force FAD in the figure below and thus is approximated to zero

Free-Body Diagram of Device (Right View):

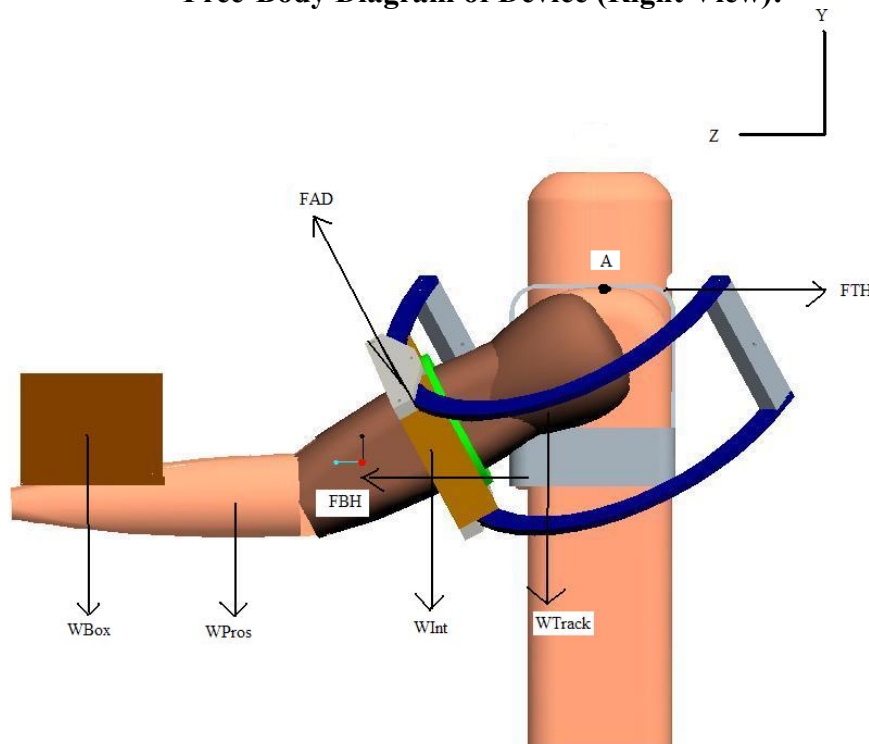

Free Body Calculations of Entire Device (Right View):

| Known Variables (lbf): | Known Distances to Center of Mass (ft): | Unkown Values (lbf): |
|------------------------|---|----------------------|
| WBox := 25lbf | DBox:= 1.5ft | FTH := 50 |
| WPros := 6.8lbf | DPros := 1.1ft | |
| WInt := 2.25lbf | DInt := 0.5ft | |
| WTrack := 1.9lbf | DTrack := 0.1ft | |

$$\Sigma FY \quad FAD := \frac{WBox + WPros + WInt + WTrack}{\sin(45deg)}$$

$$\Sigma MA \quad FHB := \frac{(WBox \cdot DBox + WPros \cdot DPros + WInt \cdot DInt + WTrack \cdot DTrack) - FAD \cdot \cos(55deg) \cdot 0.50ft}{0.6ft}$$

$$\Sigma FZ \quad FTH := FHB + FAD \cdot \cos(45deg)$$

$$FTH = 88.807lbf$$

$$FAD = 50.841lbf$$

$$FHB = 52.857lbf$$

These forces are relatively high; however, FTH and FHB are shown as point forces, but will most likely be distributed throughout a significant area of the harness thermoplastic. It is also very likely that the user's arm will become tired in this position within several minutes. Therefore these forces would only be applied for a small period of time.

Free-Body Diagram of the Box/Prosthesis/Arm Interface on the Track:

This FBD can be seen in the figure below.

Assumptions:

- Prosthesis is securely screwed into arm interface
- Brake is tightened so that the bearing acts as one rigid member with interface

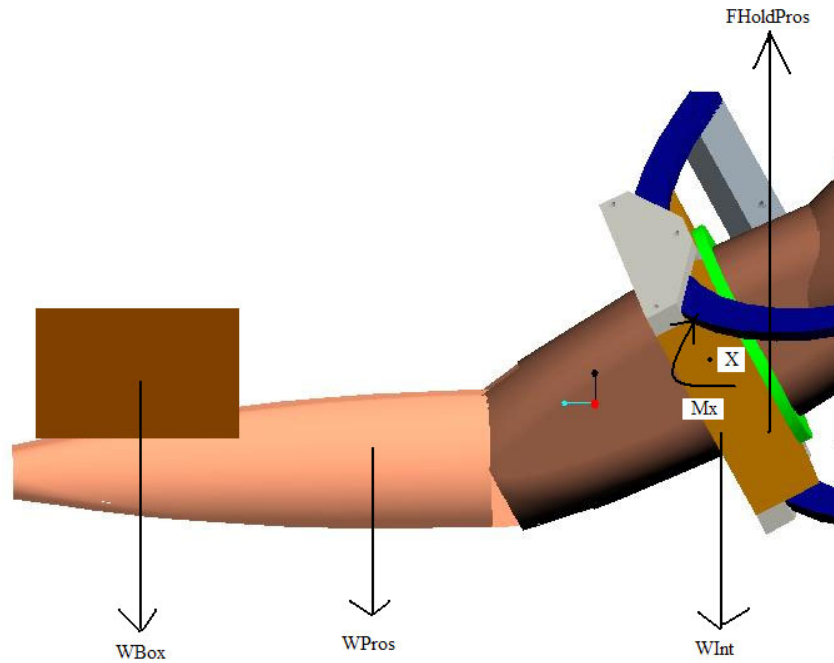

Free Body Calculations of Prosthesis/Arm Guide on Track:

$$\begin{aligned} \Sigma F_Y \quad & F_{\text{HoldPros}} := W_{\text{Box}} + W_{\text{Pros}} + W_{\text{Int}} \\ & F_{\text{HoldPros}} = 34.05 \text{ lbf} \end{aligned}$$

$$\begin{aligned} \Sigma M \quad & M_x := W_{\text{Box}} \cdot D_{\text{Box}} + W_{\text{Pros}} \cdot D_{\text{Pros}} + W_{\text{Int}} \cdot D_{\text{Int}} \\ & M_x = 62.51 \text{ J} \end{aligned}$$

Free Body Diagram of Force on Pins by the Track

This can be seen in the figure below.

Assumptions:

- The forces on the pins are approximately equal

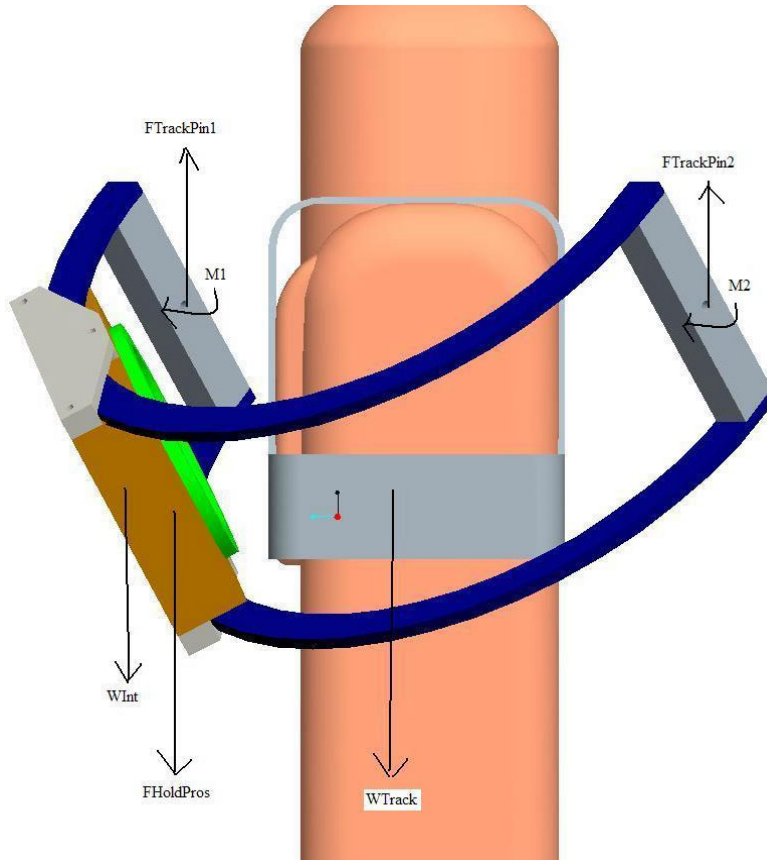

Free Body Calculations of Track on Pins:

$$\Sigma F_Y \quad F_{TrackPin1} := \frac{W_{Int} + F_{HoldPros} + W_{Track}}{2}$$

$$F_{TrackPin1} = 19.11 \text{ lbf} \quad F_{TrackPin2} := F_{TrackPin1}$$

$$F_{TrackPin2} = 19.11 \text{ lbf}$$

$$\Sigma M \quad Mom := F_{HoldPros} \cdot 0.1 \text{ ft} + W_{Track} \cdot 0.5 \text{ ft} - W_{Int} \cdot 0.2 \text{ ft}$$

$$Mom = 5.294 \text{ J}$$

Therefore, the forces on the pins required to hold the device up are about 19 lbf on each bolt. This is a medium sized force over a small area, but the bolts are composed of steel, which are made to withstand these sized forces. Additionally, $M1=M2= 5.294 \text{ J}$, which isn't a very high moment. This is because the musculature in the shoulder is providing moments in the same direction as $M1$ and $M2$.

Free-Body Diagram of Force on Harness by Support Brackets

This FBD can be viewed in the figure below.

Assumptions:

- Weight of support brackets is nearly zero

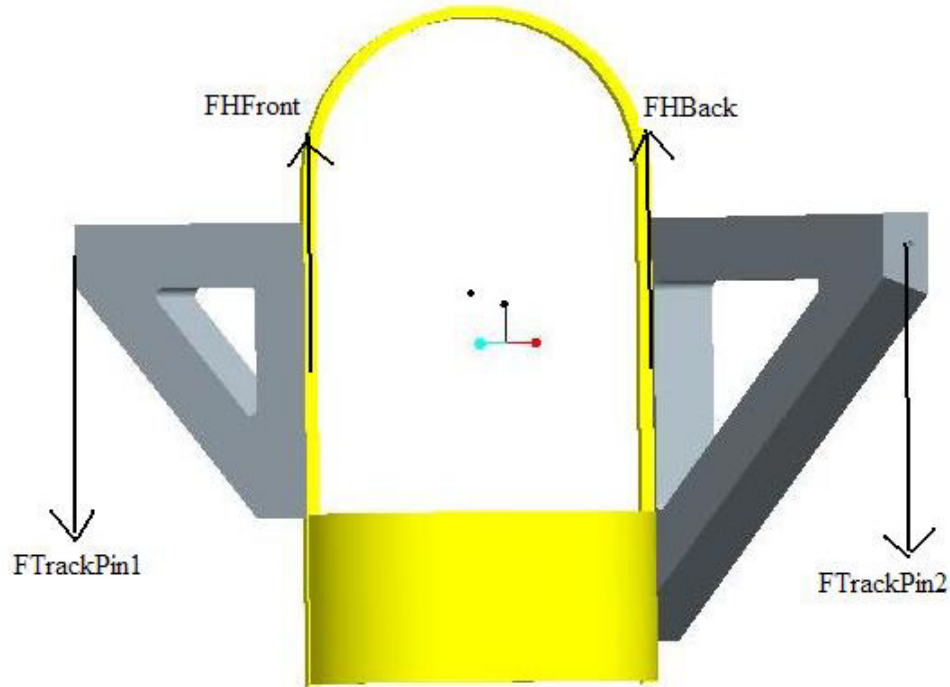

From this Free-Body Diagram, one may infer that $F_{HFront} = F_{TrackPin1}$ and $F_{HBack} = F_{TrackPin2}$. Therefore, each is equal to 19.1 lbf, but this value is distributed over a relatively large area on the harness, thus decreasing the pressure observed by the user.

Forces in Strapping of Device

Some of the most important forces in the device are those created by the straps on the body. The strapping must support a lot of weight over a small area. Therefore, a force diagram is completed with the given specs of the diagonal strap at 4.5 inches below the apex of shoulder and at 20 degrees, as well as in position #2 (Carrying box with 25lbs weight on left prosthesis). An overview of the device is shown in the figure below.

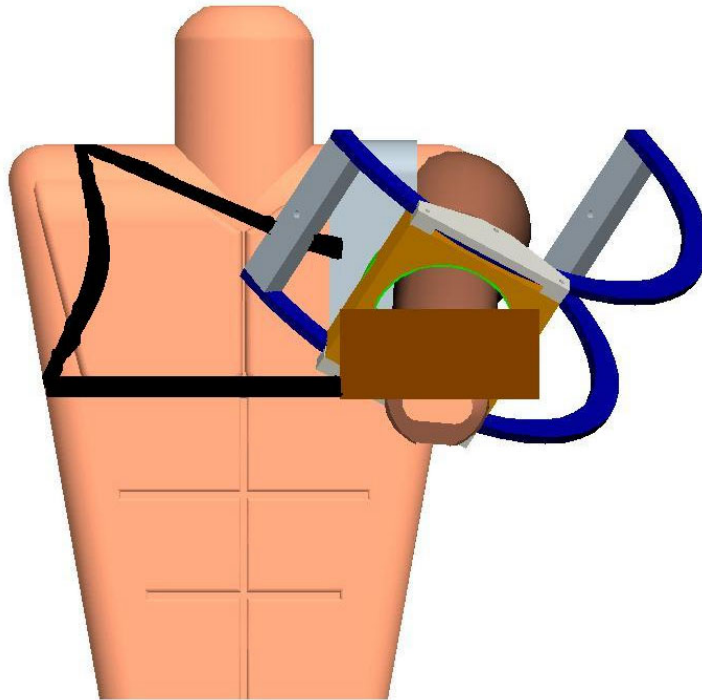

Free Body Diagram of Forces on Harness by Strapping

The forces on the Harness by the Strapping can be viewed in the figure below.

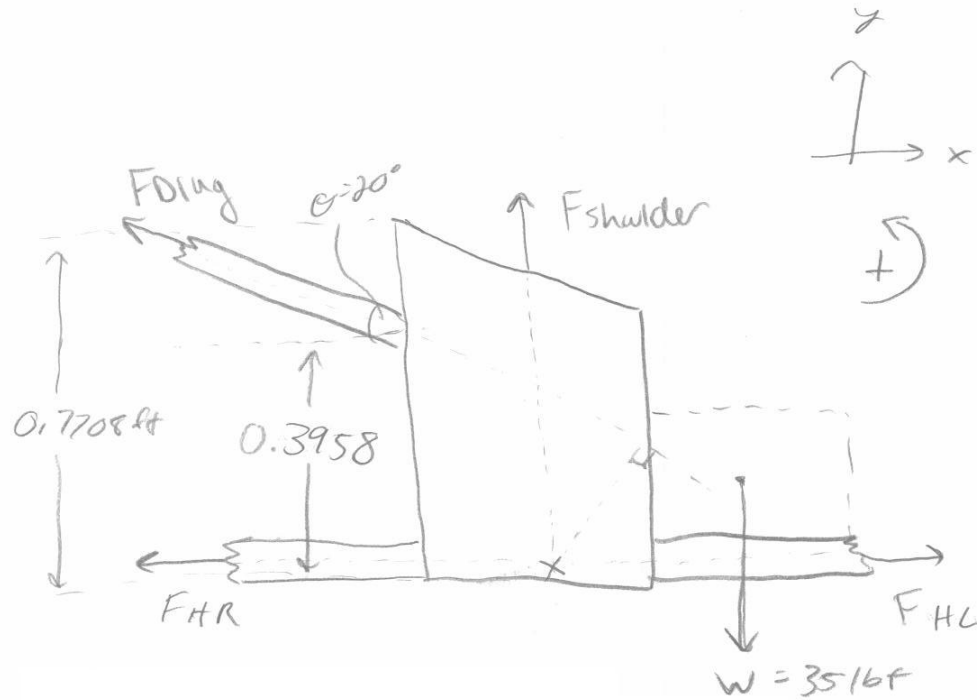

Forces on Harness by Strapping:

$$\Sigma M_X \quad F_{Diag} := \frac{(35 \text{ lbf} \cdot 0.5 \text{ ft})}{0.286 \text{ ft}}$$

$$F_{Diag} = 61.189 \text{ lbf}$$

$$\Sigma F_Y \quad F_{Should} := 35 \text{ lbf} - F_{Diag} \cdot \sin(20 \text{ deg})$$

$$F_{Should} = 14.072 \text{ lbf}$$

$$\Sigma F_X \quad F_{HL} := F_{Diag} \cdot \cos(20 \text{ deg})$$

$$F_{HL} = 57.499 \text{ lbf}$$

Therefore, the straps experience forces of up to 62 pounds. Again, these values are the result of an upper-level limit (carrying a 50 pound box). The strapping must balance the moments created on the thermoplastic by the weight of the box and thus are expected to be this high.

Due to the high forces in strapping, side thermoplastics are necessary to distribute the forces over a wider area and make for a more comfortable system.



$$\tan 70 = \frac{x}{0.3958} \quad \rightarrow \quad x = 1.0875$$

$$\sin 20 = \frac{\text{perp}}{0.8375} \quad \rightarrow \quad \text{perp} = 0.2864$$

Opening a Door

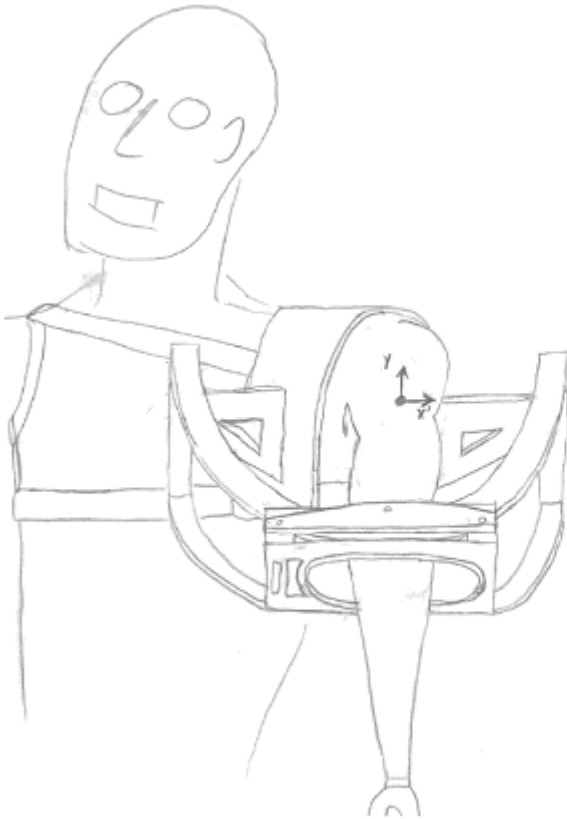

Assumptions:

- Arm makes angle Φ with z-axis
- X'-axis lies along the device's axis of rotation that controls vertical motion of arm
- Y-axis is vertical through shoulder joint
- Z'-axis is horizontal through shoulder joint. Projection of arm lies on Z'-axis (out of page)
- Force applied is applied at hand in the positive Z' direction to simulate opening a door
- For calculations, $\Phi=40^\circ$ will be used

FBD: Entire Assembly

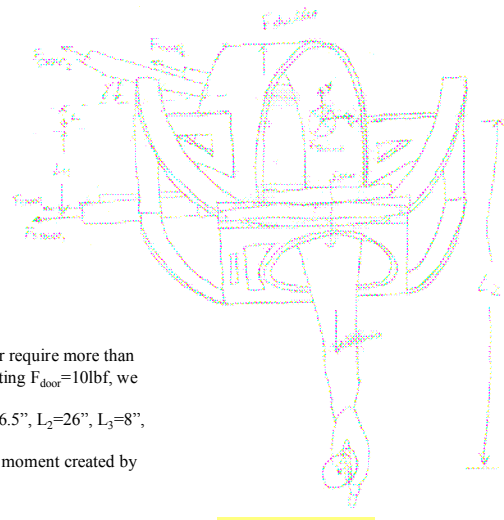
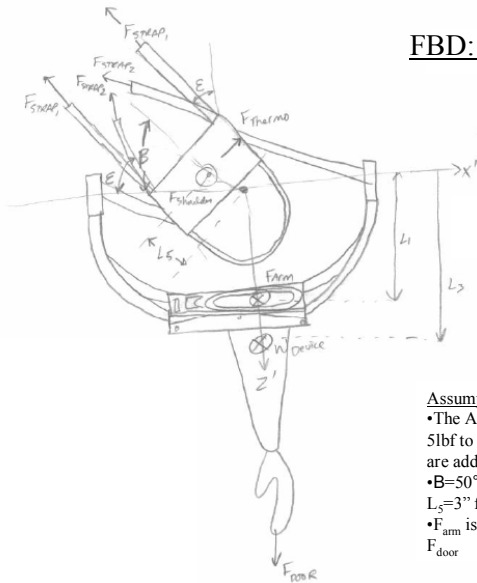

Assumptions:

- The ADA requires no door require more than 5lbf to open. However, letting $F_{door}=10lbf$, we are adding a safety factor
- $B=50^\circ, \epsilon=70^\circ, \gamma=20^\circ, L_1=6.5'', L_2=26'', L_3=8'', L_5=3''$ from ProE model
- F_{arm} is used to counter the moment created by F_{door}

$$\begin{aligned} \Sigma F_{z,p} & F_{door} = F_{thermo} \cdot \cos(\beta) + 2 \cdot F_{strap,1} \cdot \sin(\beta) + F_{strap,2} \cdot \sin(\epsilon) + F_{strap,2} \cdot \cos(\epsilon) \\ \Sigma F_{x,p} & F_{thermo} \cdot \sin(\beta) = 2 \cdot F_{strap,1} \cdot \cos(\beta) + F_{strap,2} \cdot \cos(\epsilon) + F_{strap,2} \cdot \sin(\epsilon) \\ \Sigma F_y & F_{shoulder} + 2 \cdot F_{strap,2} \cdot \sin(\gamma) = F_{arm} + W_{device} \\ \Sigma M_{x,p} & L_2 \cdot F_{door} \cdot \sin(\phi) = F_{shoulder} \cdot L_5 \cdot \sin(\beta) + F_{arm} \cdot L_1 \cdot \sin(\phi) + W_{device} \cdot L_3 \cdot \sin(\phi) \\ & F_{strap,1} = F_{strap,2} \end{aligned}$$

$$F_{thermo} = 6.746lbf$$

$$F_{strap,1} = 2.013lbf$$

$$F_{strap,2} = 2.013lbf$$

$$F_{shoulder} = 23.429lbf$$

$$F_{arm} = 14.806lbf$$

FBD: Prosthesis

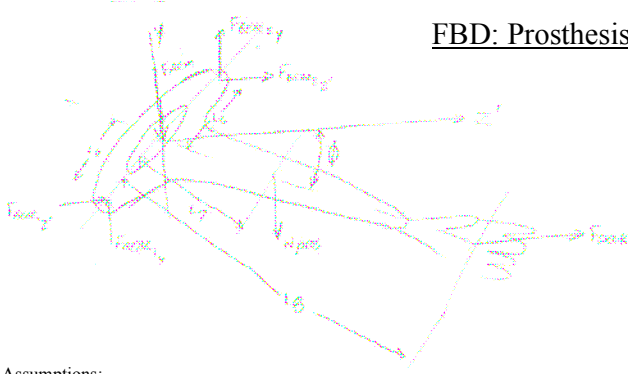

From Drillis and Contini (1966)

$$W_{\text{pro}} = W_{\text{forearm}} + W_{\text{hand}}$$

$$W_{\text{pro}} := 0.013 \text{ BW} + 2.41 \text{ lbf} + 0.0059 \text{ BW} + .75 \text{ lbf}$$

$$W_{\text{pro}} = 7.753 \text{ lbf}$$

$$L_8 = (\%BH_{\text{forearm}} + \%BH_{\text{hand}}) \cdot BH$$

$$L_8 := (0.146 + 0.108) \cdot BH$$

$$L_8 = 18.796 \text{ in}$$

$$L_7 := 9.4 \text{ in}$$

$$L_6 := 2.5 \text{ in}$$

Assumptions:

- Assume Y-direction reaction forces are distributed evenly between F_{bear1y} and F_{bear2y}

- Use anthropometric data for human arm. Because $W_{\text{arm}} > W_{\text{pro}}$, we are adding a safety factor

- Let $L_7 = 50\%L_8$. The actual CG of the forearm and hand is located slightly more proximal. Using 50% segment length will add a safety factor since W_{pro} will create a larger moment

- Body height (BH) = 74". This max height represents the 95th percentile for men's heights (CDC, 2005)

- Body weight (BW) = 243lbs. This max weight represents the 90th percentile for men's weights

$$\Sigma F_{z,p} \quad F_{\text{bear1.zp}} + F_{\text{bear2.zp}} + F_{\text{door}} = 0$$

$$\Sigma F_y \quad F_{\text{bear1.y}} + F_{\text{bear2.y}} = W_{\text{pro}} + F_{\text{arm}}$$

$$\Sigma M_o \quad W_{\text{pro}} \cdot L_7 \cos(\theta) + F_{\text{bear2.zp}} \cdot L_6 \cos(\theta) + F_{\text{bear1.y}} \cdot L_6 \sin(\theta) = F_{\text{door}} \cdot L_8 \sin(\theta) + F_{\text{bear2.y}} \cdot L_6 \sin(\theta) + F_{\text{bear1.zp}} \cdot L_6 \cos(\theta)$$

$$F_{\text{bear1.y}} = F_{\text{bear2.y}}$$

$$F_{\text{bear1.zp}} = -21.968 \text{ lbf}$$

$$F_{\text{bear2.zp}} = 11.968 \text{ lbf}$$

$$F_{\text{bear1.y}} = 11.279 \text{ lbf}$$

$$F_{\text{bear2.y}} = 11.279 \text{ lbf}$$

FBD: Arm Interface Assembly

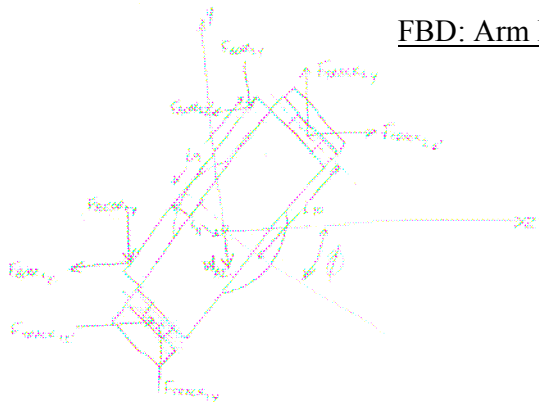

Assumptions:

- W_{AI} is the weight of the arm interface = 2lbf

- The load in the Y-direction is equally shared between the top and bottom track ($F_{\text{track1y}} = F_{\text{track2y}}$)

- $L_9 = 2.5"$, $L_{10} = 3"$, $L_{11} = 2"$ based on ProE model

$$F_{\text{track1.zp}} = -23.863 \text{ lbf}$$

$$F_{\text{track2.zp}} = 13.863 \text{ lbf}$$

$$F_{\text{track1.y}} = 12.279 \text{ lbf}$$

$$F_{\text{track2.y}} = 12.279 \text{ lbf}$$

$$\Sigma F_{z,p} \quad F_{\text{bear1.zp}} + F_{\text{bear2.zp}} = F_{\text{track1.zp}} + F_{\text{track2.zp}}$$

$$\Sigma F_y \quad F_{\text{track1.y}} + F_{\text{track2.y}} = W_{\text{AI}} + F_{\text{bear1.y}} + F_{\text{bear2.y}}$$

$$\Sigma M \quad F_{\text{bear2.zp}} \cdot L_{11} \sin(\phi) + L_9 \cos(\phi) + F_{\text{track2.y}} \cdot L_{10} \sin(\phi) + F_{\text{bear1.y}} \cdot L_{11} \cos(\phi) + L_9 \sin(\phi) + F_{\text{track1.zp}} \cdot L_{10} \cos(\phi) = F_{\text{bear2.y}} \cdot L_{11} \cos(\phi) + L_9 \sin(\phi) + F_{\text{track1.zp}} \cdot L_{10} \cos(\phi) + F_{\text{bear1.y}} \cdot L_{11} \sin(\phi) - L_9 \cos(\phi) + F_{\text{track1.y}} \cdot L_{10} \sin(\phi)$$

$$F_{\text{track1.y}} = F_{\text{track2.y}}$$

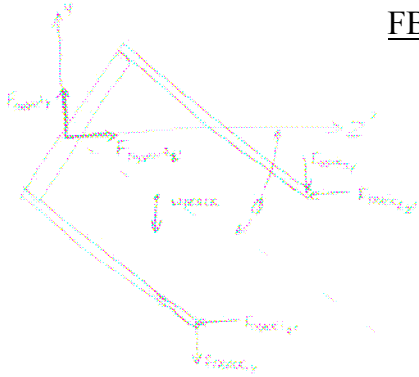

FBD: Track

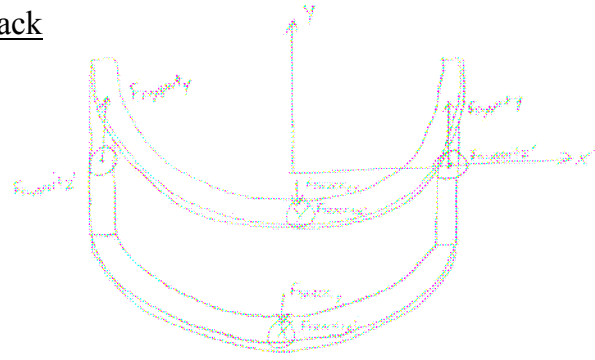

$$\Sigma F_{z,p} \quad 2 \cdot F_{\text{support.zp}} = F_{\text{track1.zp}} + F_{\text{track2.zp}}$$

$$\Sigma F_y \quad 2 \cdot F_{\text{support.y}} = F_{\text{track1.y}} + F_{\text{track2.y}} + W_{\text{track}}$$

$$F_{\text{support.zp}} = -5 \text{ lbf}$$

$$F_{\text{support.y}} = 13.779 \text{ lbf}$$

Assumptions:

- Reaction forces are equally distributed on each side of the track
- $W_{\text{track}} = 3 \text{ lbf}$

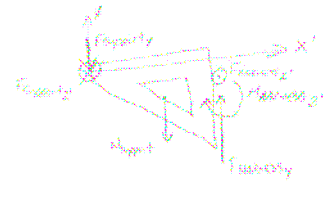
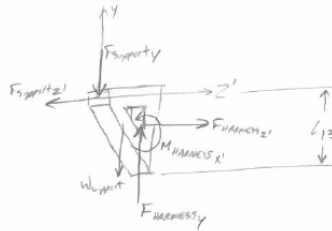
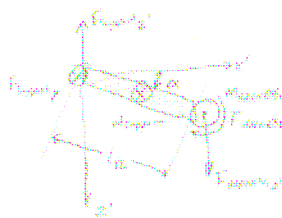

FBD: Front Support

$$\Sigma F_y \quad F_{\text{harness.y}} = F_{\text{support.y}} + W_{\text{support.front}}$$

$$\Sigma F_{z,p} \quad F_{\text{harness.zp}} = F_{\text{support.zp}}$$

$$\Sigma M_y \quad M_{\text{harness.y}} + F_{\text{harness.zp}} \cdot L_{12} \cos(\alpha) = 0$$

$$\Sigma M_{xp} \quad M_{\text{harness.xp}} + F_{\text{harness.y}} \cdot L_{12} \sin(\alpha) + F_{\text{harness.zp}} \cdot \frac{L_{13}}{2} = W_{\text{support.front}} \cdot \frac{L_{12}}{2} \sin(\alpha)$$

$$\Sigma M_{zp} \quad M_{\text{harness.zp}} + W_{\text{support.front}} \cdot \frac{L_{12}}{2} \cos(\alpha) = F_{\text{harness.y}} \cdot L_{12} \cos(\alpha)$$

$$F_{\text{harness.y}} = 14.779 \text{ lbf}$$

$$F_{\text{harness.zp}} = -5 \text{ lbf}$$

$$M_{\text{harness.y}} = 2.083 \text{ ft} \cdot \text{lbf}$$

$$M_{\text{harness.xp}} = 0.833 \text{ ft} \cdot \text{lbf}$$

$$M_{\text{harness.zp}} = 5.95 \text{ ft} \cdot \text{lbf}$$

Assumptions:

- Assume CG support is in center of support. In reality, CG is proximally located. Using a more distal CG adds a safety factor since W_{support} creates a larger moment
- Assume $F_{\text{harness.z}}$ acts on center of support
- $W_{\text{support.front}} = 1 \text{ lbf}$, $L_{12} = 5''$, $L_{13} = 4''$, $\alpha = 0^\circ$ based on ProE model

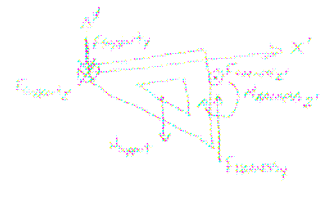
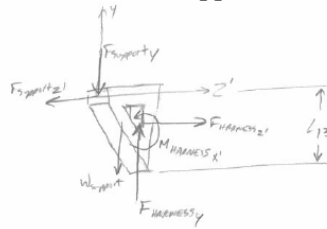
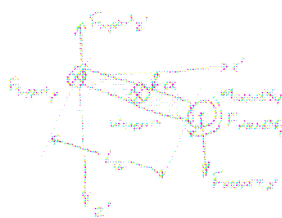

FBD: Rear Support

$$\Sigma F_y \quad F_{\text{harness.y}} = F_{\text{support.y}} + W_{\text{support.rear}}$$

$$\Sigma F_{z,p} \quad F_{\text{harness.zp}} = F_{\text{support.zp}}$$

$$\Sigma M_y \quad M_{\text{harness.y}} + F_{\text{harness.zp}} \cdot L_{12} \cos(\alpha) = 0$$

$$\Sigma M_{xp} \quad M_{\text{harness.xp}} + F_{\text{harness.y}} \cdot L_{12} \sin(\alpha) + F_{\text{harness.zp}} \cdot \frac{L_{13}}{2} = W_{\text{support.rear}} \cdot \frac{L_{12}}{2} \sin(\alpha)$$

$$\Sigma M_{zp} \quad M_{\text{harness.zp}} + W_{\text{support.rear}} \cdot \frac{L_{12}}{2} \cos(\alpha) = F_{\text{harness.y}} \cdot L_{12} \cos(\alpha)$$

$$F_{\text{harness.y}} = 15.279 \text{ lbf}$$

$$F_{\text{harness.zp}} = -5 \text{ lbf}$$

$$M_{\text{harness.y}} = 3.021 \text{ ft} \cdot \text{lbf}$$

$$M_{\text{harness.xp}} = -3.26 \text{ ft} \cdot \text{lbf}$$

$$M_{\text{harness.zp}} = 8.779 \text{ ft} \cdot \text{lbf}$$

Assumptions:

- Assume CG support is in center of support. In reality, CG is proximally located. Using a more distal CG adds a safety factor since W_{support} creates a larger moment
- Assume $F_{\text{harness.z}}$ acts on center of support
- $W_{\text{support.rear}} = 1.5 \text{ lbf}$, $L_{12} = 8''$, $L_{13} = 4''$, $\alpha = 25^\circ$ based on ProE model

Carrying a Backpack

FOREARM

- FRONT VIEW

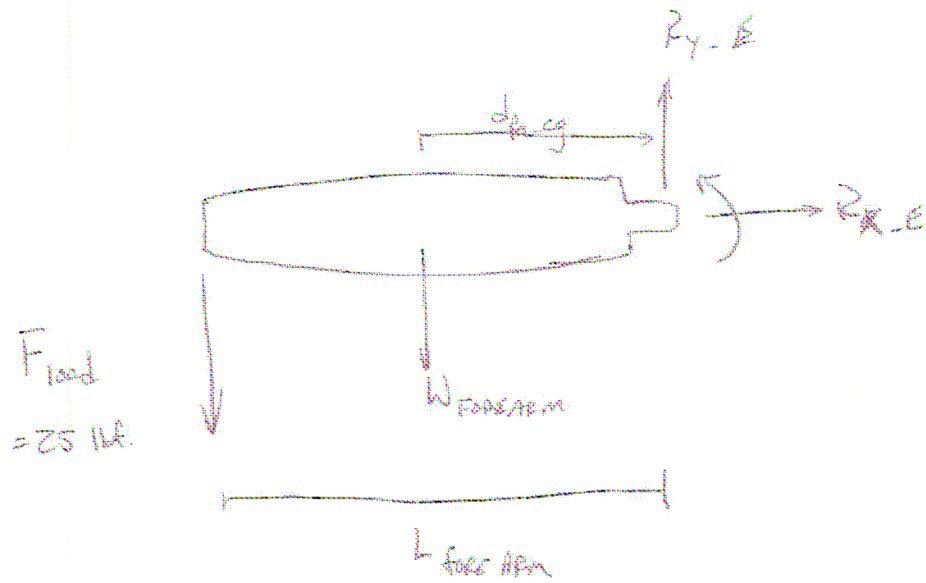

Forearm Analysis:

Forearm Length:

$$L_{\text{forearm}} := 11 \cdot \text{in}$$

Distance from Elbow to forearm C.G.

$$d_{\text{fa_cg}} := 5.5 \cdot \text{in}$$

Load of Backpack:

$$F_{\text{load}} := 25 \cdot \text{lbf}$$

Weight of Forearm:

$$W_{\text{forearm}} := 5 \cdot \text{lbf}$$

Guess Values:

Reactions Forces at Elbow:

$$R_{x_E} := 1 \cdot \text{lbf}$$

$$R_{y_E} := 1 \cdot \text{lbf}$$

$$R_{z_E} := 1 \cdot \text{lbf}$$

Reaction Moments at Elbow:

$$M_{x_E} := 1 \cdot \text{lbf} \cdot \text{in}$$

$$M_{y_E} := 1 \cdot \text{lbf} \cdot \text{in}$$

$$M_{z_E} := 1 \cdot \text{lbf} \cdot \text{in}$$

Given

Sum Forces in the y-direction:

$$R_{y_E} = F_{\text{load}} + W_{\text{forearm}}$$

Sum Moments about z-axis:

$$F_{\text{load}} \cdot L_{\text{forearm}} + W_{\text{forearm}} \cdot d_{\text{fa_cg}} + M_{z_E} = 0$$

$$\begin{pmatrix} R_{x_E} \\ R_{y_E} \\ R_{z_E} \\ M_{x_E} \\ M_{y_E} \\ M_{z_E} \end{pmatrix} := \text{Find}(R_{x_E}, R_{y_E}, R_{z_E}, M_{x_E}, M_{y_E}, M_{z_E})$$

Solution to Reactions at Elbow:

$$R_{x_E} = 0 \text{ lbf}$$

$$R_{y_E} = 30 \text{ lbf}$$

$$R_{z_E} = 0 \text{ lbf}$$

$$M_{x_E} = 0 \text{ lbf} \cdot \text{in}$$

$$M_{y_E} = 0 \text{ lbf} \cdot \text{in}$$

$$M_{z_E} = -25.2 \text{ lbf} \cdot \text{ft}$$

UPPER ARM

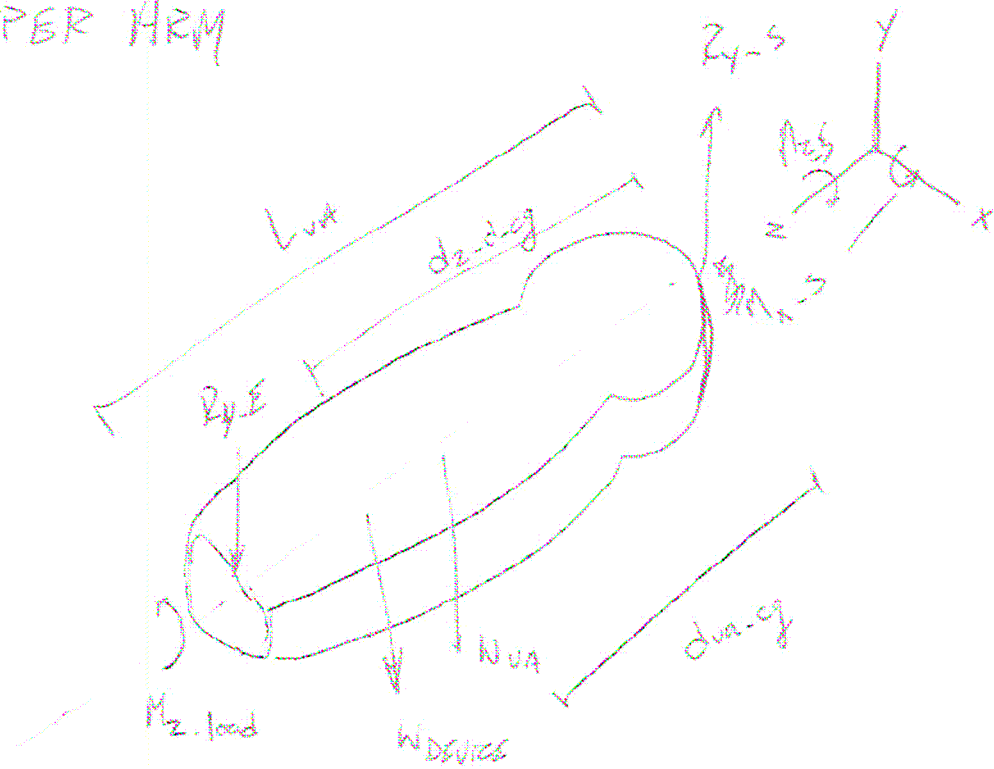

Analysis of Reactions At Shoulder Joint:

$$\begin{array}{llll}
 W_{\text{device}} := 3 \cdot \text{lbf} & W_{\text{ua}} := 5 \cdot \text{lbf} & L_{\text{ua}} := 12.91 \cdot \text{in} & d_{\text{ua_cg}} := 6 \cdot \text{in} \\
 d_{z_d_cg} := 5 \cdot \text{in} & d_{y_d_cg} := 0 \cdot \text{in} & d_{x_d_cg} := 0 \cdot \text{in} &
 \end{array}$$

Reaction Forces at Shoulder:

$$R_{x_S} := 1 \cdot \text{lbf} \qquad R_{y_S} := 1 \cdot \text{lbf} \qquad R_{z_S} := 1 \cdot \text{lbf}$$

Reaction Moments at Shoulder:

$$M_{x_S} := 1 \cdot \text{lbf} \cdot \text{in} \qquad M_{y_S} := 1 \cdot \text{lbf} \cdot \text{in} \qquad M_{z_S} := 1 \cdot \text{lbf} \cdot \text{in}$$

Given

$$R_{x_S} = 0$$

$$R_{y_S} = F_{\text{load}} + W_{\text{ua}} + W_{\text{device}}$$

$$R_{z_S} = 0$$

$$F_{\text{load}} \cdot (L_{\text{ua}}) + W_{\text{ua}} \cdot (d_{\text{ua_cg}}) + W_{\text{device}} \cdot (d_{z_d_cg}) + M_{x_S} = 0$$

$$M_{y_S} = 0$$

$$M_{z_E} + M_{z_S} = W_{\text{device}} \cdot (d_{x_d_cg})$$

$$\begin{pmatrix} R_{x_S} \\ R_{y_S} \\ R_{z_S} \\ M_{x_S} \\ M_{y_S} \\ M_{z_S} \end{pmatrix} := \text{Find}(R_{x_S}, R_{y_S}, R_{z_S}, M_{x_S}, M_{y_S}, M_{z_S})$$

Solution to Reactions at Shoulder:

$$R_{x_S} = 0 \text{ lbf} \qquad R_{y_S} = 33 \text{ lbf} \qquad R_{z_S} = 0 \text{ lbf}$$

$$M_{x_S} = -30.6 \text{ lbf} \cdot \text{ft} \qquad M_{y_S} = 0 \text{ lbf} \cdot \text{in} \qquad M_{z_S} = 25.2 \text{ lbf} \cdot \text{ft}$$

With our device on, the moment in the shoulder about the z-axis would actually be supported by the device.

$$M_{z_load} := M_{z_S} \qquad M_{z_load} = 25.2 \text{ lbf} \cdot \text{ft}$$

DEVICE

TOP VIEW

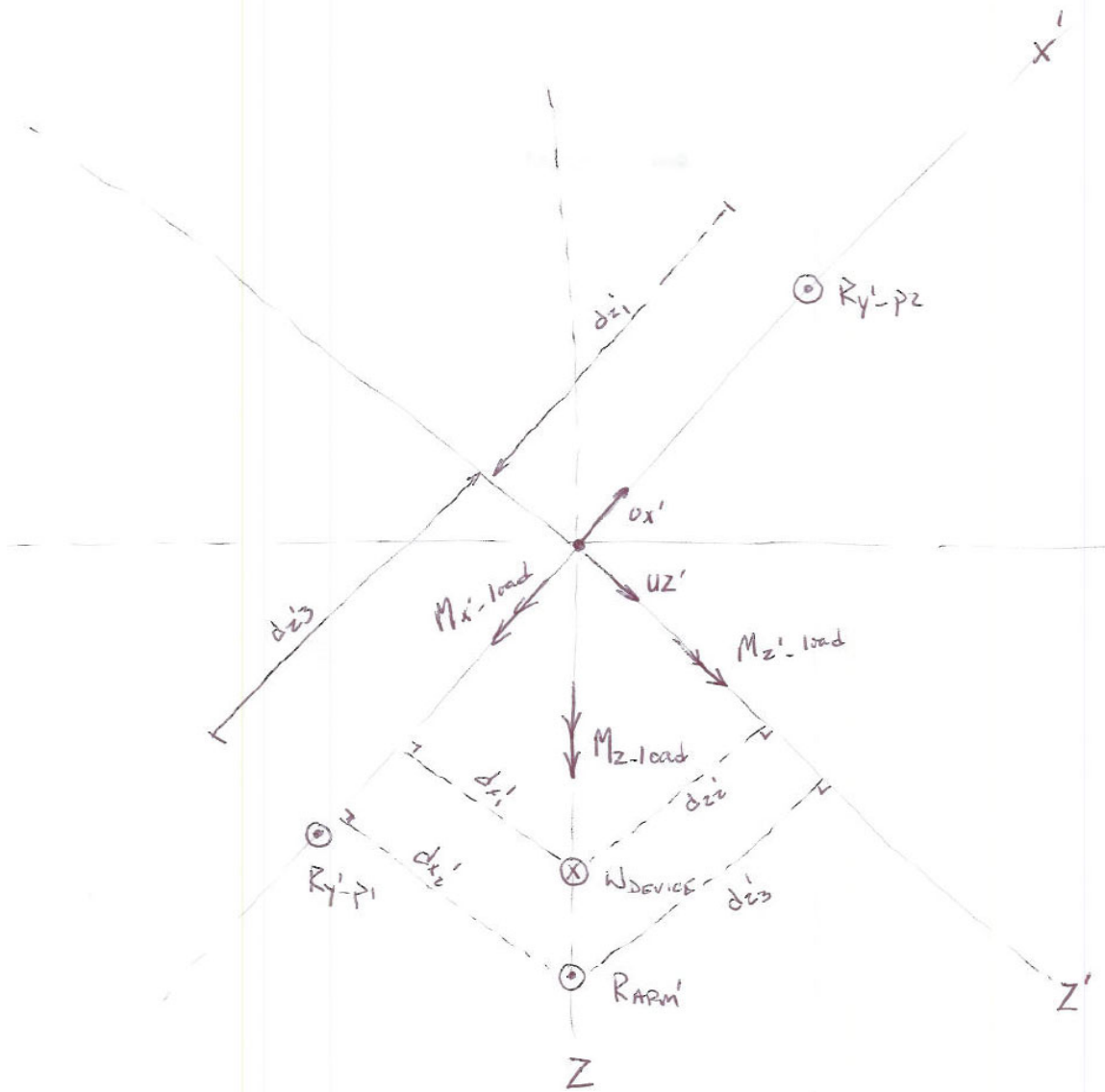

Resolving the moment created by the load into the local device coordinate system (x' , y' , z'). This is done by dotting the moment vector with a unit vector in the direction of the desired axis. The moment applied by the load is in the k direction.

Unit Vector along the x' -axis: $u_{x'} = (0.643i - 0.766k)$ $\cos(40\text{-deg}) = 0.766$

Unit Vector along the z' -axis: $u_{z'} = (0.766i + 0.643k)$ $\cos(50\text{-deg}) = 0.643$

Dotting the applied moment in the k -direction with the above unit vector yields:

$M_{x'_{load}} := M_{z_{load}} \cdot (-0.766)$ $M_{x'_{load}} = -19.303 \text{ lbf}\cdot\text{ft}$

$M_{z'_{load}} := M_{z_{load}} \cdot (0.643)$ $M_{z'_{load}} = 16.204 \text{ lbf}\cdot\text{ft}$

The moment load along the x' axis is going to be supported by the shoulder musculature. The moment load along the z' axis will be supported by the pin joints on the x' axis.

Taking the load on the z' axis and resolving it back to the global coordinate system yields:

$M_{z'_{Z}} := M_{z'_{load}} \cdot 0.643$ $M_{z'_{Z}} = 10.419 \text{ lbf}\cdot\text{ft}$

$M_{z'_{X}} := M_{z'_{load}} \cdot 0.766$ $M_{z'_{X}} = 12.412 \text{ lbf}\cdot\text{ft}$

BODY HARNESS

SIDE VIEW

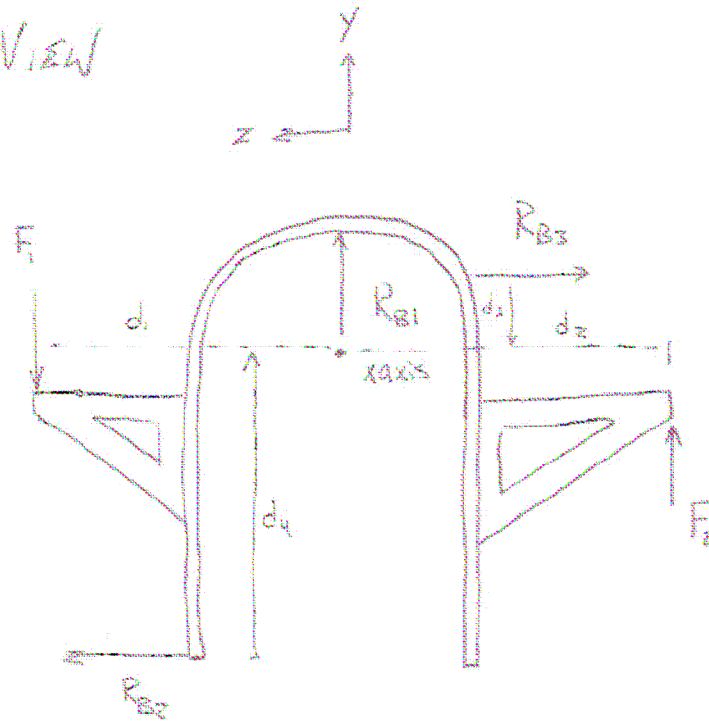

Looking from the Left side the forces that will balance the torque:

$$d_1 := 7 \cdot \text{in} \cdot \sin(50 \cdot \text{deg}) \quad d_1 = 5.362 \text{in} \quad d_2 := d_1$$

$$d_3 := 3 \cdot \text{in} \quad d_4 := 5 \cdot \text{in}$$

$$F_{C1_X} := 1 \cdot \text{lbf}$$

Given

$$M_{z_X} = F_{C1_X}(d_1 + d_2)$$

$$F_{C1_X} := \text{Find}(F_{C1_X})$$

$$F_{C1_X} = 13.9 \text{lbf}$$

$$F_{C2_X} := F_{C1_X}$$

$$R_{B1} := 1 \cdot \text{lbf}$$

$$R_{B2} := 1 \cdot \text{lbf}$$

$$R_{B3} := 1 \cdot \text{lbf}$$

Given

$$R_{B1} + F_{C1_X} - F_{C1_X} = 0$$

$$R_{B2} - R_{B3} = 0$$

$$F_{C1_X}(d_1) + F_{C1_X}(d_2) - R_{B3}(d_3) - R_{B2}(d_4) = 0$$

$$\begin{pmatrix} R_{B1} \\ R_{B2} \\ R_{B3} \end{pmatrix} := \text{Find}(R_{B1}, R_{B2}, R_{B3})$$

$$R_{B1} = 0 \text{lbf}$$

$$R_{B2} = 18.6 \text{lbf}$$

$$R_{B3} = 18.6 \text{lbf}$$

RB1 is 0 in this case because I am neglecting the weight of the device since it is relatively small compared to the forces exerted upon it. RB2 and RB3 will be exerted on the chest and back respectively and distributed over the area of the thermoplastic.

Body HARNESS

FRONT VIEW

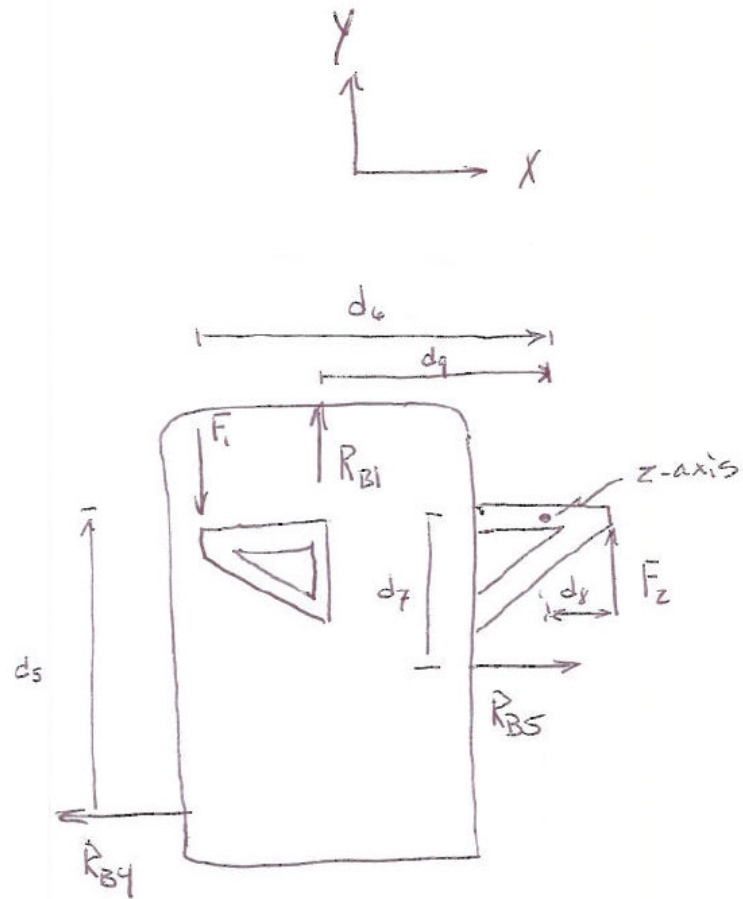

Looking from the Front, the forces that will balance the torque:

$$d_6 := 7 \cdot \text{in} \cdot \cos(50 \cdot \text{deg}) \quad d_6 = 4.5 \text{in} \quad d_8 := d_6$$

$$F_{C1_Z} := 1 \cdot \text{lbf}$$

Given

$$M_{Z_Z} = F_{C1_X} \cdot (d_6 + d_8)$$

$$F_{C1_Z} := \text{Find}(F_{C1_X})$$

$$F_{C1_Z} = 13.9 \text{lbf}$$

$$F_{C2_Z} := F_{C1_Z}$$

$$R_{B1} := 1 \cdot \text{lbf}$$

$$R_{B4} := 1 \cdot \text{lbf}$$

$$R_{B5} := 1 \cdot \text{lbf}$$

$$d_5 := 8 \cdot \text{in}$$

$$d_7 := 4 \cdot \text{in}$$

$$d_9 := 5 \cdot \text{in}$$

Given

$$R_{B5} - R_{B4} = 0$$

$$R_{B1} + F_{C2_Z} - F_{C1_Z} = 0$$

$$F_{C1_Z} \cdot (d_6) - R_{B5} \cdot (d_7) + F_{C2_Z} \cdot (d_8) - R_{B4} \cdot (d_5) - R_{B1} \cdot (d_9) = 0$$

$$\begin{pmatrix} R_{B1} \\ R_{B4} \\ R_{B5} \end{pmatrix} := \text{Find}(R_{B1}, R_{B4}, R_{B5})$$

$$R_{B1} = 0 \text{lbf}$$

$$R_{B4} = 10.419 \text{lbf}$$

$$R_{B5} = 10.419 \text{lbf}$$

RB4 will be provided by the horizontal strap. The diagonal strap is not being included in this analysis because it is not need to support the load that I have analyzed. RB5 which is shown in the diagram on the right side of the Harness will actually be created by the shoulder. It will be created by the angled shape of the top of the thermoplastic and therefore will not rely on friction.

Appendix C – Mechanical Drawings

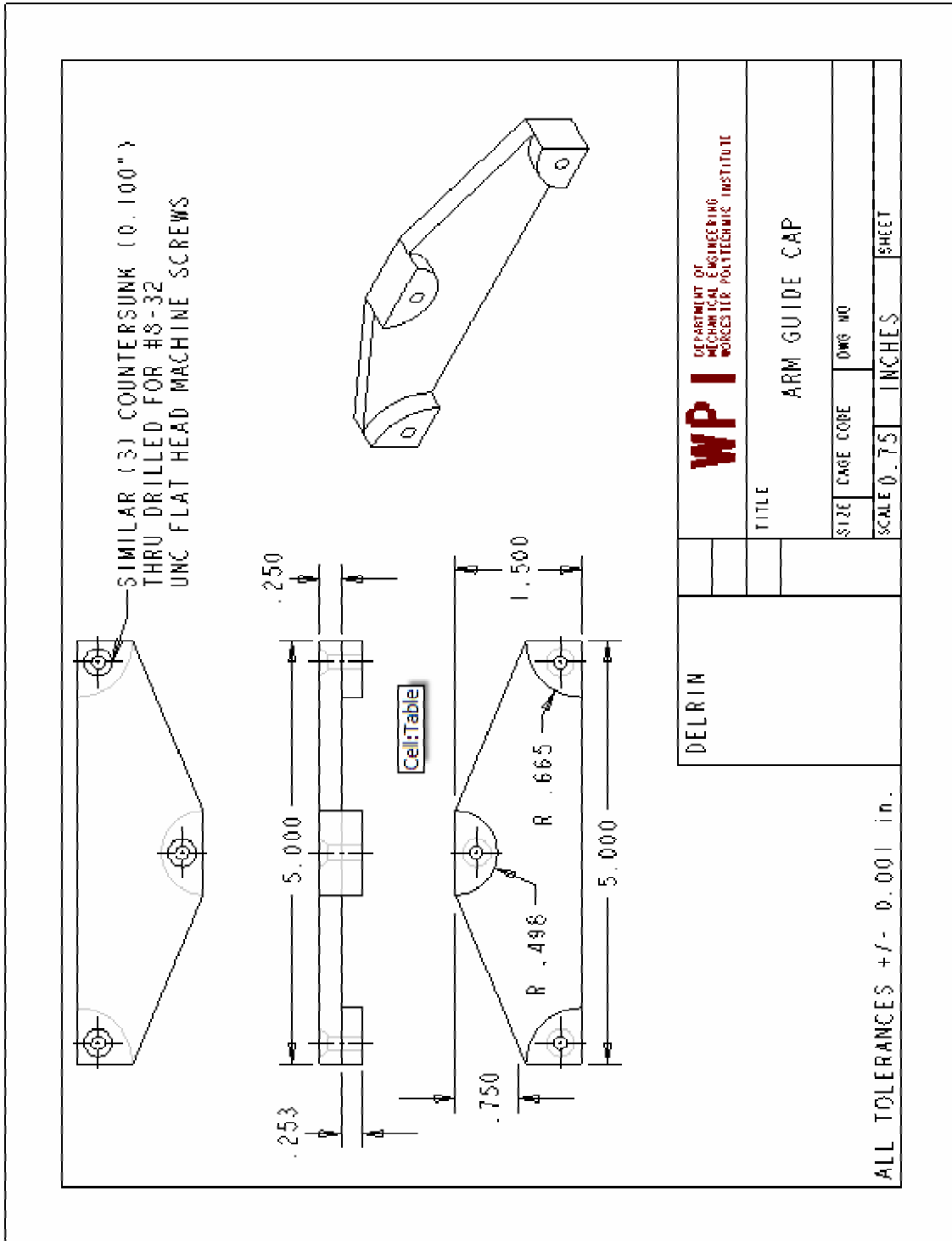

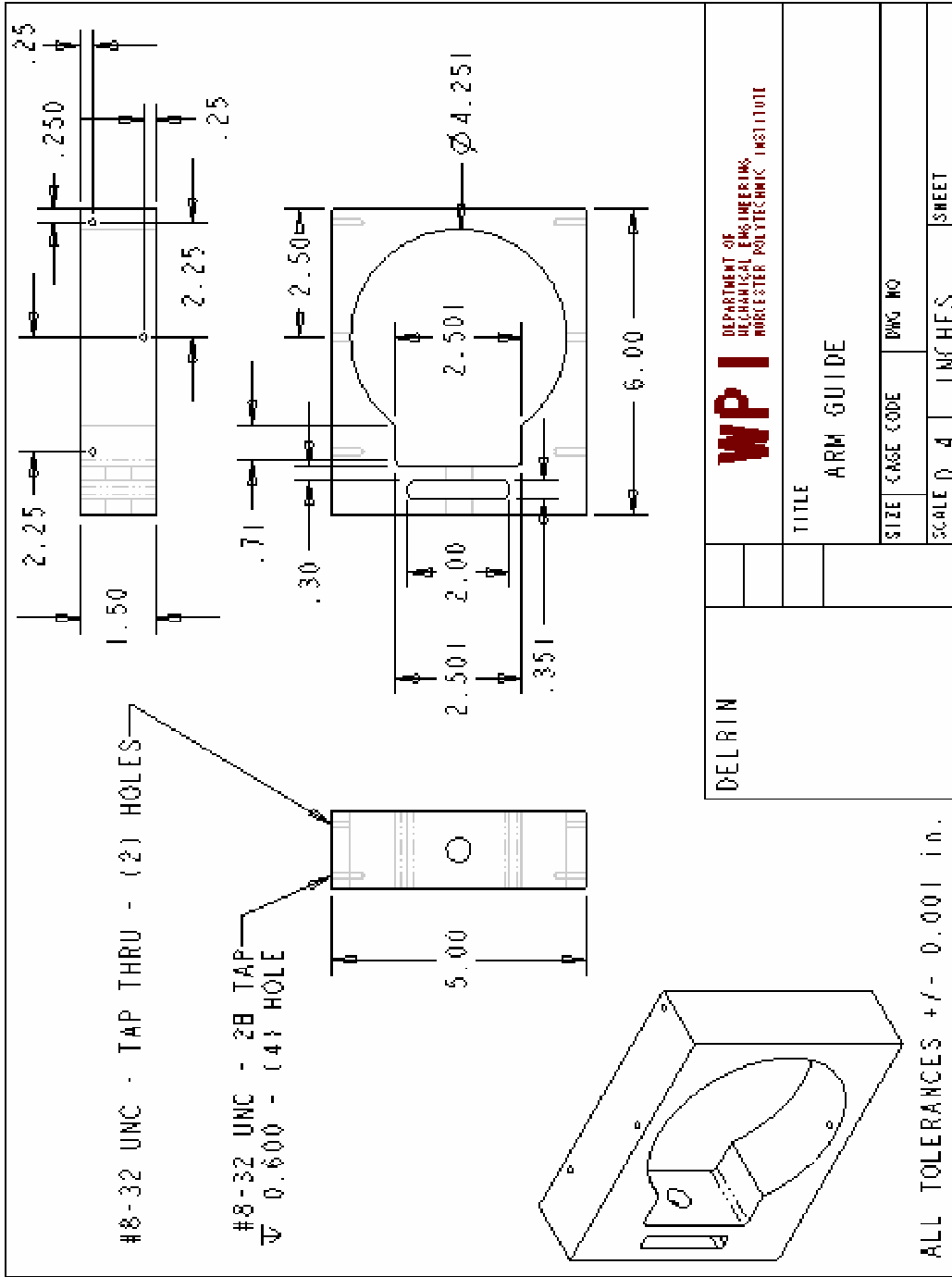

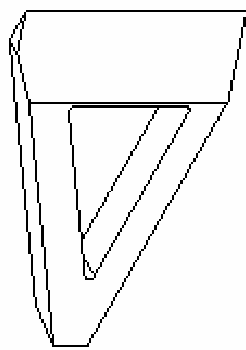
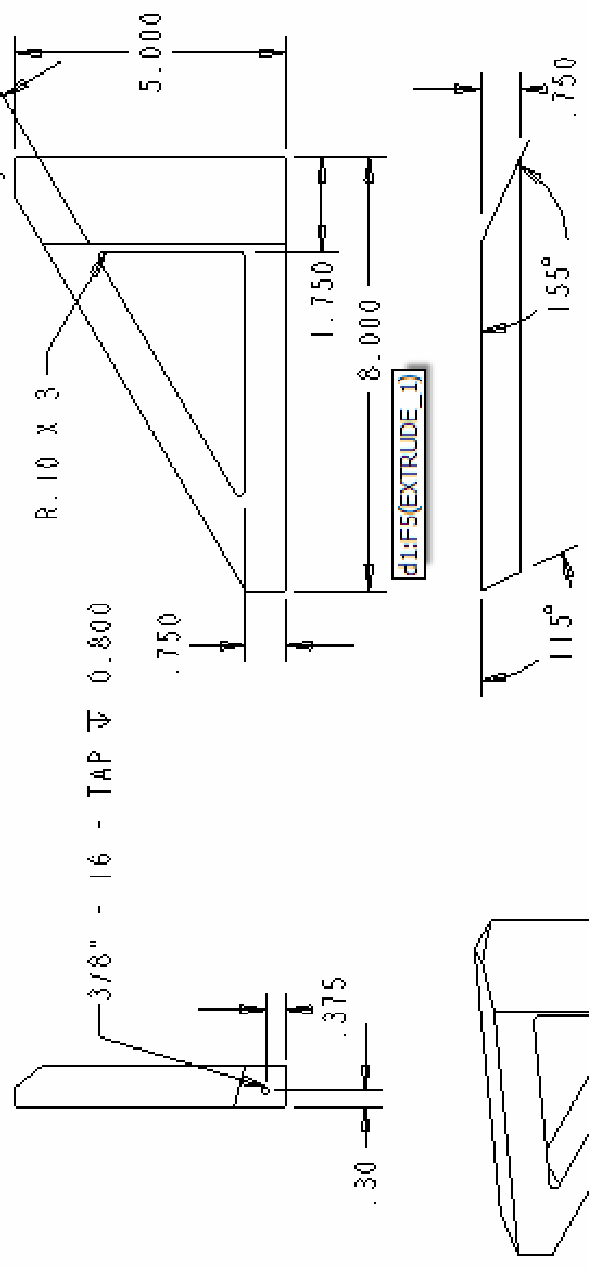

| | | | | |
|----------|--|-----------|--------------|-------|
| ALUMINUM | DEPARTMENT OF ENGINEERING WORCESTER POLYTECHNIC INSTITUTE | | TITLE | |
| | | | BACK SUPPORT | |
| STATE | | CAGE CODE | DWG NO | |
| SCALE | | 0.4 | INCHES | SHEET |

ALL TOLERANCES +/- 0.001 in.

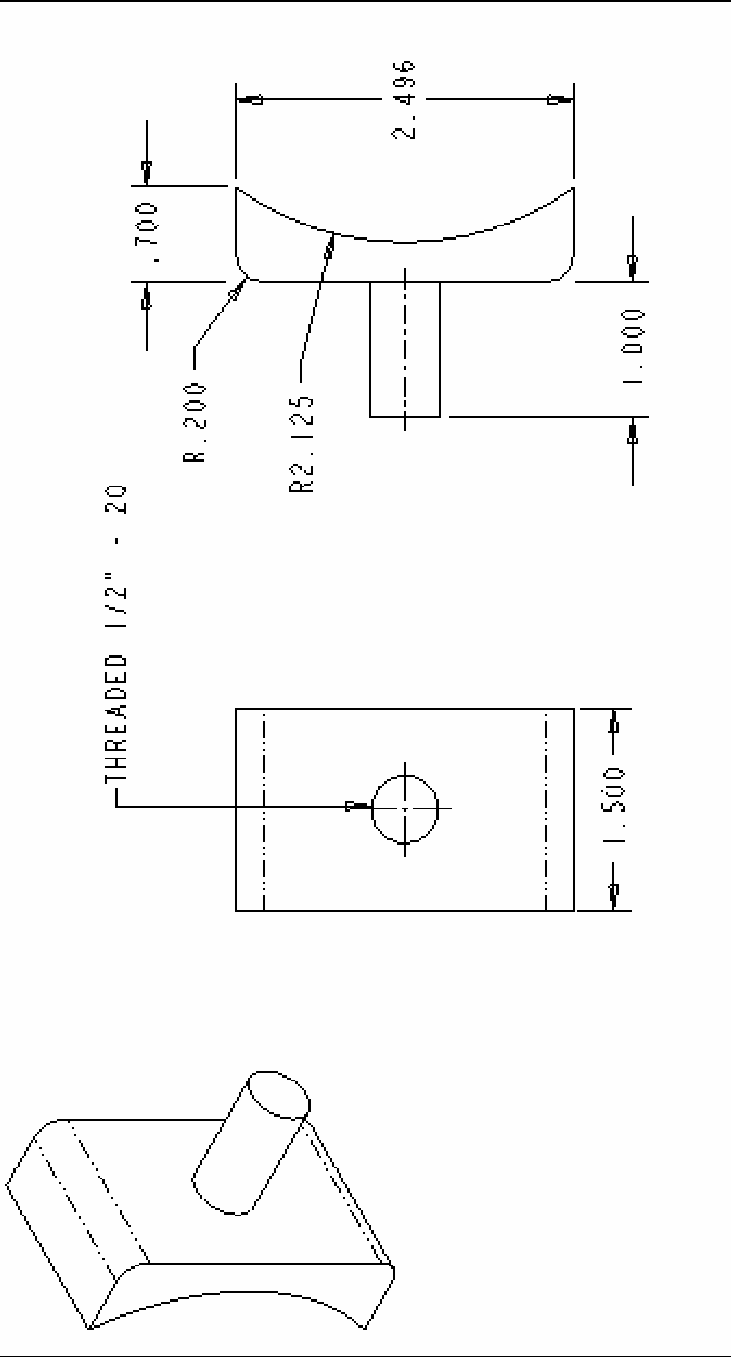

| | | |
|----------|---|-----------|
| ALUMINUM | WPI DEPARTMENT OF MECHANICAL ENGINEERING WORCESTER POLYTECHNIC INSTITUTE | |
| | TITLE BEARING BRAKE | |
| SIZE | | CAGE CODE |
| SCALE | | DWG NO |
| 1.0 | | INCHES |
| | | SHEET |

ALL TOLERANCES +/- 0.001 in.

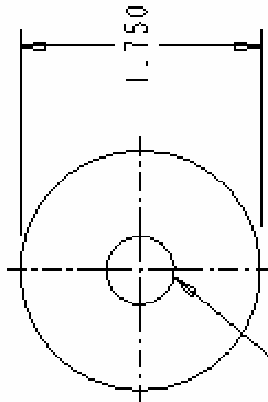
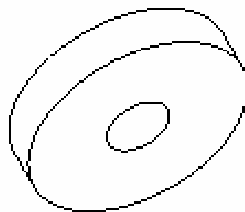

1/2" - 20 TAP THRU

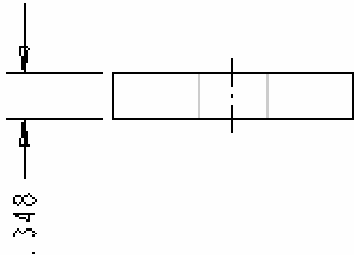

ALUMINUM

WPI DEPARTMENT OF
MECHANICAL ENGINEERING
WORCESTER POLYTECHNIC INSTITUTE

TITLE

BEARING BRAKE KNOB

SIZE | GAGE CODE | DWG NO

SCALE | 1.0 | INCHES | SHEET

ALL TOLERANCES +/- 0.001 in.

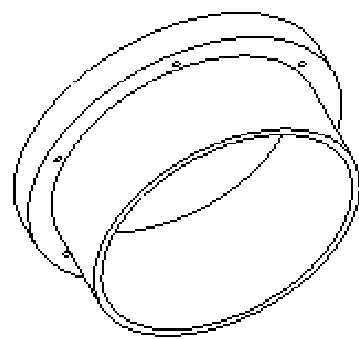
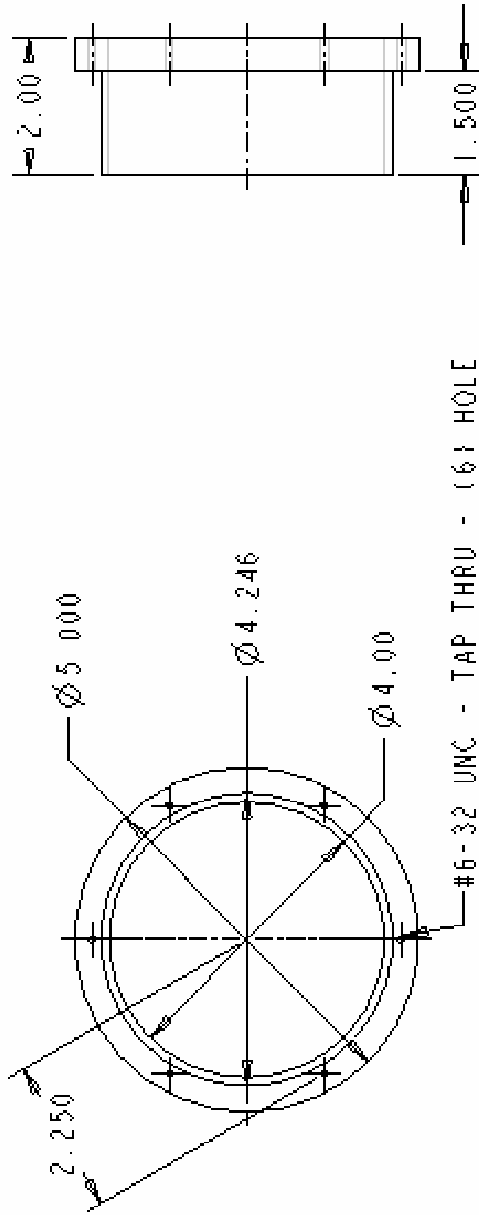

ALL TOLERANCES $\pm 0.001 \text{ in.}$

| | | | |
|---------|--|---|-----------|
| DEL RIN | | WPI DEPARTMENT OF MECHANICAL ENGINEERING MANCHESTER POLYTECHNIC INSTITUTE | |
| | | TITLE BEARING | |
| | | SIZE | CAGE CODE |
| | | DWG NO | |
| | | SCALE | SHEET |
| | | $\text{Ø} .5$ | INCHES |

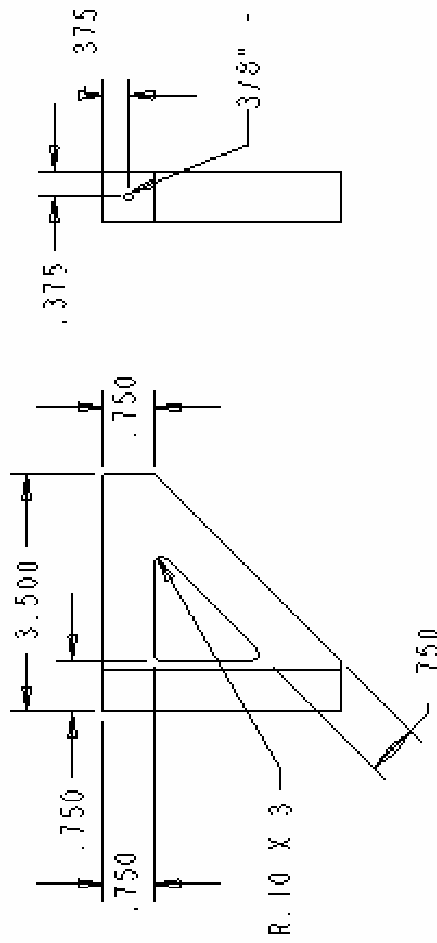
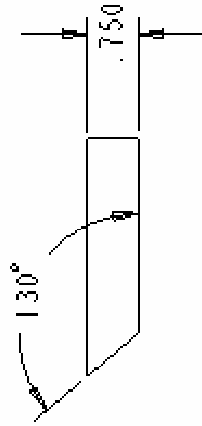
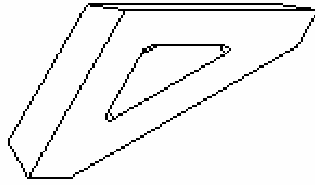

| | | | |
|---------------|--|--|--|
| ALUMINUM | |  DEPARTMENT of MECHANICAL ENGINEERING WABLER POLYTECHNIC INSTITUTE | |
| TITLE | | | |
| FRONT SUPPORT | | | |
| SIZE | | DWG NO | |
| SCALE | | SHEET | |
| 0.5 | | INCHES | |

ALL TOLERANCES +/- 0.001 in.

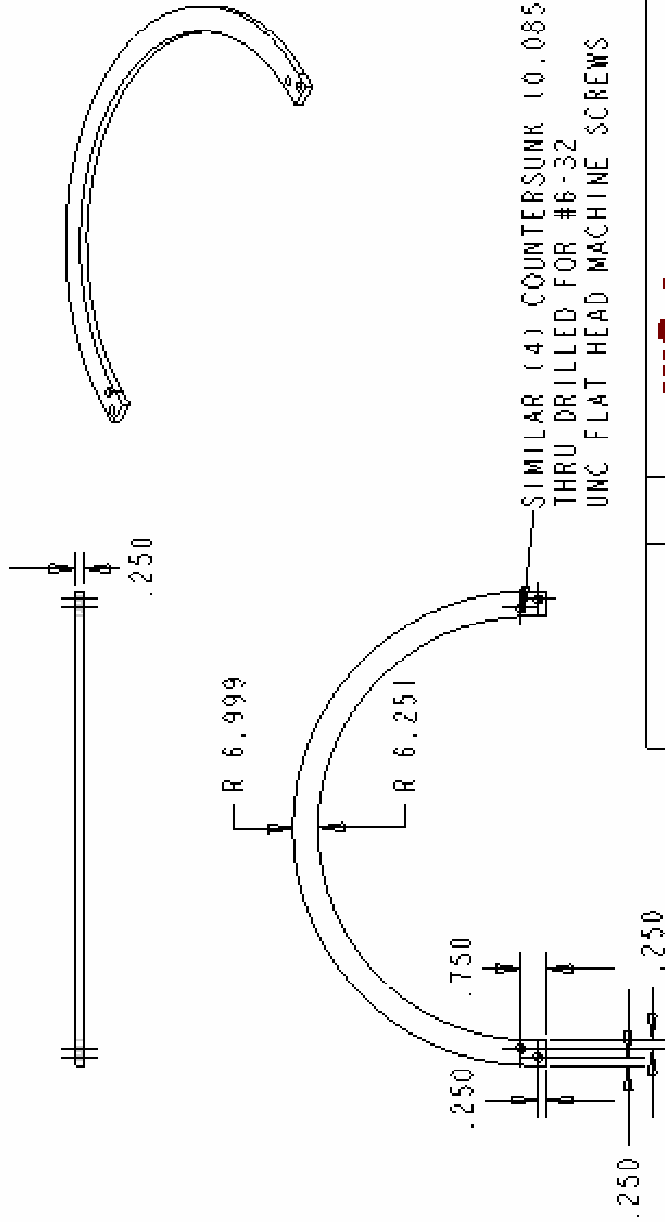

| | | | |
|----------------|-----------|--|-------|
| ALUMINUM | | WPI DEPARTMENT OF MECHANICAL ENGINEERING WORCESTER POLYTECHNIC INSTITUTE | |
| TITLE TRACK | | | |
| SIZE | CAGE CODE | DWS NO | |
| SCALE 0.25 | | INCHES | SHEET |

ALL TOLERANCES +/- 0.001 in.

Appendix D – Anthropometric Data Analysis

Determining the outer diameter of the upper arm

First, we must determine the length of the upper arm. The length of the upper arm segment is proportional to the body height (BH):

$$h_{\text{upper_arm}} = (0.186) \cdot (\text{BH}) \quad (\text{Drillis and Contini, 1966})$$

The mean body height for American males (aged 20-74) between the years of 1999 and 2002 is given by:

$$\text{BH} = 69.4 \text{ inches} \quad (\text{CDC, Advance Data No 347, 10/27/2004})$$

Therefore, the average length of the upper arm (males) is:

$$h_{\text{upper_arm}} = (0.186) \cdot (69.4 \text{ inches})$$

$$h_{\text{upper_arm}} = 12.91 \text{ inches}$$

We also must determine the volume of the upper arm. McCanville (2003) determined the volume of various body segments on 31 males and generated a formula for determining the volume of individual body segments. The equations are given below:

$$V_{\text{right_upper_arm}} = 76 - 2.14(\text{stature (cm)}) + 13.25(\text{weight (lbs)})$$

$$V_{\text{left_upper_arm}} = 856 - 8.09(\text{stature (cm)}) + 14.66(\text{weight (lbs)})$$

Using additional data from the CDC Advance Data publication, we know the mean height and weight for males aged 20-74 is:

$$\text{weight}_{50\text{th}}(\text{lbs}) = 191$$

$$\text{stature (cm)} = 176.2$$

Therefore, we obtain: $V_{\text{right_upper_arm}} = 76 - 2.14(176.2) + 13.25(191)$

$$V_{\text{right_upper_arm}} = 2230 \text{ cm}^3$$

$$V_{\text{left_upper_arm}} = 856 - 8.09(176.2) + 14.66(191)$$

$$V_{\text{left_upper_arm}} = 2231 \text{ cm}^3$$

Averaging these values together, we obtain:

$$V_{50\text{th}} = 2230.5 \text{ cm}^3$$

Converting to cubic inches, we obtain:

$$V_{50\text{th}} = 2230.5 \text{ cm}^3 \cdot \left(\frac{1 \text{ inch}}{2.54 \text{ cm}} \right)^3$$

$$V_{50\text{th}} = 136.1 \text{ in}^3$$

Also From the CDC, 200lbs, represents the 90th percentile weight for men

$$\text{weight}_{90\text{th}}(\text{lbs}) = 243$$

Using the same stature (176.2cm), we find volumes for the upper arms:

$$V_{\text{right_upper_arm}} = 76 - 2.14(176.2) + 13.25(243)$$

$$V_{\text{right_upper_arm}} = 2919 \text{ cm}^3$$

$$V_{\text{left_upper_arm}} = 856 - 8.09(176.2) + 14.66(243)$$

$$V_{\text{left_upper_arm}} = 2992 \text{ cm}^3$$

Averaging these values together, we obtain:

$$V_{90\text{th}} = 2955 \text{ cm}^3$$

Converting to cubic inches, we obtain:

$$V_{90\text{th}} = 2955 \text{ cm}^3 \cdot \left(\frac{1 \text{ inch}}{2.54 \text{ cm}} \right)^3$$

$$V_{90\text{th}} = 180 \text{ in}^3$$

Additionally, we need to obtain the distance from the proximal end of the arm to the center of mass. The upper arm center of mass is located 43.6% from proximal (wide) end or:

$$z = (0.436)(h) \quad (\text{Miller and Nelson, 1976})$$

$$z = (0.436)(12.91 \text{ inches})$$

$$z = 5.629 \text{ inches}$$

This is the same for the 50th and 90th weight percentile male since it is based only on height.

Using the Hanavan model (1964), we can approximate the shape of the upper arm using a truncated circular cone (TCC) (see figure). The volume of a TCC is given by:

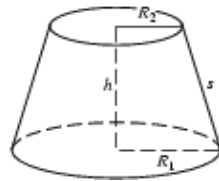

$$V = \frac{1}{3} \cdot \pi \cdot h \cdot \left[(r_1)^2 + r_1 \cdot r_2 + (r_2)^2 \right] \quad [\text{eq 1}]$$

Where L represents the segment length of the upper arm, and r1 and r2 represent the bottom and top radii, respectively. Because this equation involves two unknowns (the radii at either end of the cone), we must utilize another equation to solve for the radii. The centroid of a TCC is given by:

$$z = \frac{h \cdot \left[(r_1)^2 + 2 \cdot r_1 \cdot r_2 + 3 \cdot (r_2)^2 \right]}{4 \cdot \left[(r_1)^2 + r_1 \cdot r_2 + (r_2)^2 \right]} \quad [\text{eq 2}]$$

Equation 2 assumes a homogeneous material in the calculation of the center of mass. Obviously, the arm is non-homogeneous and varies in density throughout the arm. But for our purposes, this assumption still generates an acceptable answer.

Substituting z, h, and V into eq's 1 and 2, we can now obtain the radii (r1 and r2) for the 50th percentile male:

$$136.1 = \frac{1}{3} \cdot \pi \cdot 12.91 \cdot \left[(r_1)^2 + r_1 \cdot r_2 + (r_2)^2 \right] \quad [\text{eq 1}]$$

$$5.629 = \frac{12.91 \cdot \left[(r_1)^2 + 2 \cdot r_1 \cdot r_2 + 3 \cdot (r_2)^2 \right]}{4 \cdot \left[(r_1)^2 + r_1 \cdot r_2 + (r_2)^2 \right]} \quad [\text{eq 2}]$$

From this, we obtain:

$$r_1(50\text{th}) = 2.174$$

$$r_2(50\text{th}) = 1.466$$

Therefore, the diameter at the proximal end of the upper arm for 50th percentile males is:

$$D_{\text{proximal.50th}} = (2) \cdot (2.174 \text{ inches})$$

$$D_{\text{proximal.50th}} = 4.35 \text{ inches}$$

Also, the diameter at the distal end of the upper arm for 50th percentile males is:

$$D_{\text{distal.50th}} = (2) \cdot (1.466 \text{ inches})$$

$$D_{\text{distal.50th}} = 2.932 \text{ inches}$$

Similarly for the 90th percentile male,

$$180 = \frac{1}{3} \cdot \pi \cdot 12.91 \left[(r_1)^2 + r_1 \cdot r_2 + (r_2)^2 \right] \quad [\text{eq 1}]$$

$$5.629 = \frac{12.91 \left[(r_1)^2 + 2 \cdot r_1 \cdot r_2 + 3 \cdot (r_2)^2 \right]}{4 \left[(r_1)^2 + r_1 \cdot r_2 + (r_2)^2 \right]} \quad [\text{eq 2}]$$

From this, we obtain:

$$r_1(90\text{th}) = 2.5$$

$$r_2(90\text{th}) = 1.687$$

Therefore, the diameter at the proximal end of the upper arm for 90th percentile males is:

$$D_{\text{proximal.90th}} = (2) \cdot (2.5 \text{ inches})$$

$$D_{\text{proximal.90th}} = 5 \text{ inches}$$

Also, the diameter at the distal end of the upper arm for 90th percentile males is:

$$D_{\text{distal.90th}} = (2) \cdot (1.687 \text{ inches})$$

$$D_{\text{distal.90th}} = 3.374 \text{ inches}$$

To determine the diameter at any length of the 50th percentile arm (x), we can use simple geometry:

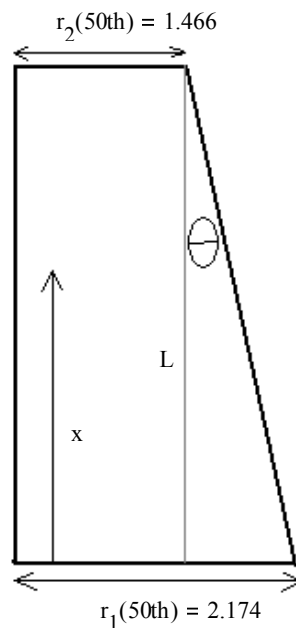

$$\theta = \arctan \left(\frac{r_1 - r_2}{L} \right)$$

$$\theta = \arctan \left(\frac{2.174 - 1.466}{12.91} \right)$$

$$\theta = 3.14^\circ$$

Therefore, the diameter at any given location on the arm is given by:

$$D(x) = 2 \cdot [1.466 + (12.91 - x) \cdot \tan(3.14^\circ)]$$

To determine at what distance, our device will no longer be useful (i.e. the diameter of the arm exceeds 4 inches), simply plug in 4 for D(x) and solve for x:

$$4 = 2 \cdot [1.466 + (12.91 - x) \cdot \tan(3.14^\circ)]$$

$$x_{50\text{th}} = 3.17 \text{ inches}$$

Therefore, our device will be useful as long as there is 3.2 inches of residual upper arm length on a 50th percentile male.

Similarly, for the 90th percentile male,

$$r_2(90\text{th}) = 1.687$$

$$r_1(90\text{th}) = 2.5$$

$$\theta = 3.60^\circ$$

$$D(x) = 2 \cdot [1.687 + (12.91 - x) \cdot \tan(3.60^\circ)]$$

To determine at what distance, our device will no longer be useful (i.e. the diameter of the arm exceeds 4 inches), simply plug in 4 for D(x) and solve for x:

$$4 = 2 \cdot [1.687 + (12.91 - x) \cdot \tan(3.60^\circ)]$$

$$x_{90\text{th}} = 8 \text{ inches}$$

Therefore, our device will be useful as long as there is 8 inches of residual upper arm length on a 90th percentile male.

As anticipated, the upper diameters are larger for the larger person. Still though, the diameter at the distal end is small enough for the user to still be able to fit his/her arm through our device.

Assuming that the liner is no thicker than the material we are using for our harness, the maximum thickness of the prosthetic socket will be 1/8"

Therefore, there will be an additional 1/4" added to the thickness of the users distal arm diameter:

$$D_{191 \cdot \text{lb person}} = 3.182 \text{ inches}$$

$$D_{243 \cdot \text{lb person}} = 3.624 \text{ inches}$$

If we also assume that the user's clothing is no thicker than the liner, then we can add an additional 1/4" for the thickness of the clothing. We obtain:

$$D_{191 \cdot \text{lb person}} = 3.432 \text{ inches}$$

$$D_{243 \cdot \text{lb person}} = 3.874 \text{ inches}$$

Even for the 90th percentile weight for males, the device is still large enough to accommodate his arm, his prosthetic liner, and his clothing at the distal end of the upper arm. While these numbers are not 100% accurate (many assumptions have been made), we feel that this data backs up our design choices regarding sizing of the device.

Appendix E – Graphical FEA Results

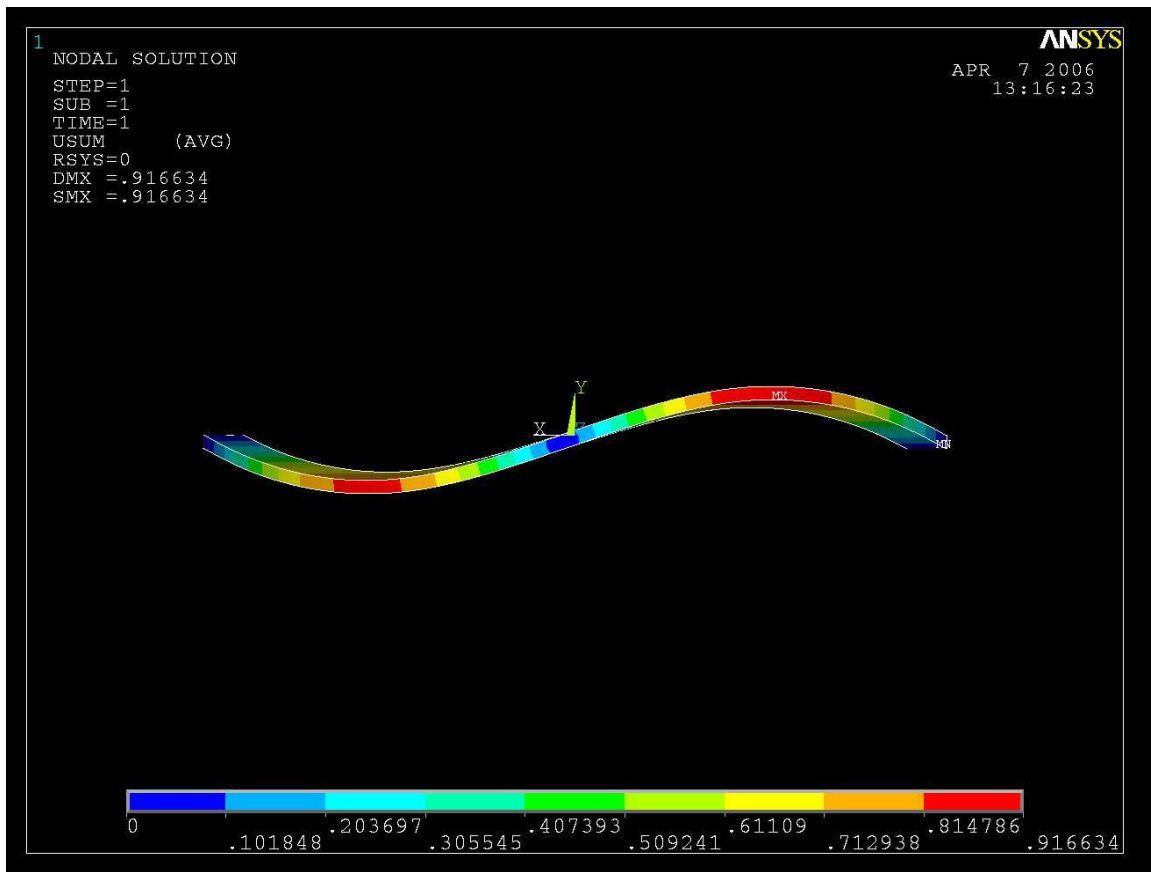

This is the result of the full 25 ft-lb torsional load on the Delrin® track. The displacement of the track ends was 0 as defined by the boundary conditions and the deflection at the center of the track was also zero as a result of the pure couple. The most severe deflection is seen at about 5 inches to either side of the center of the track at a value of almost 1 inch. This is clearly unacceptable as it would not allow for proper operation of the device.

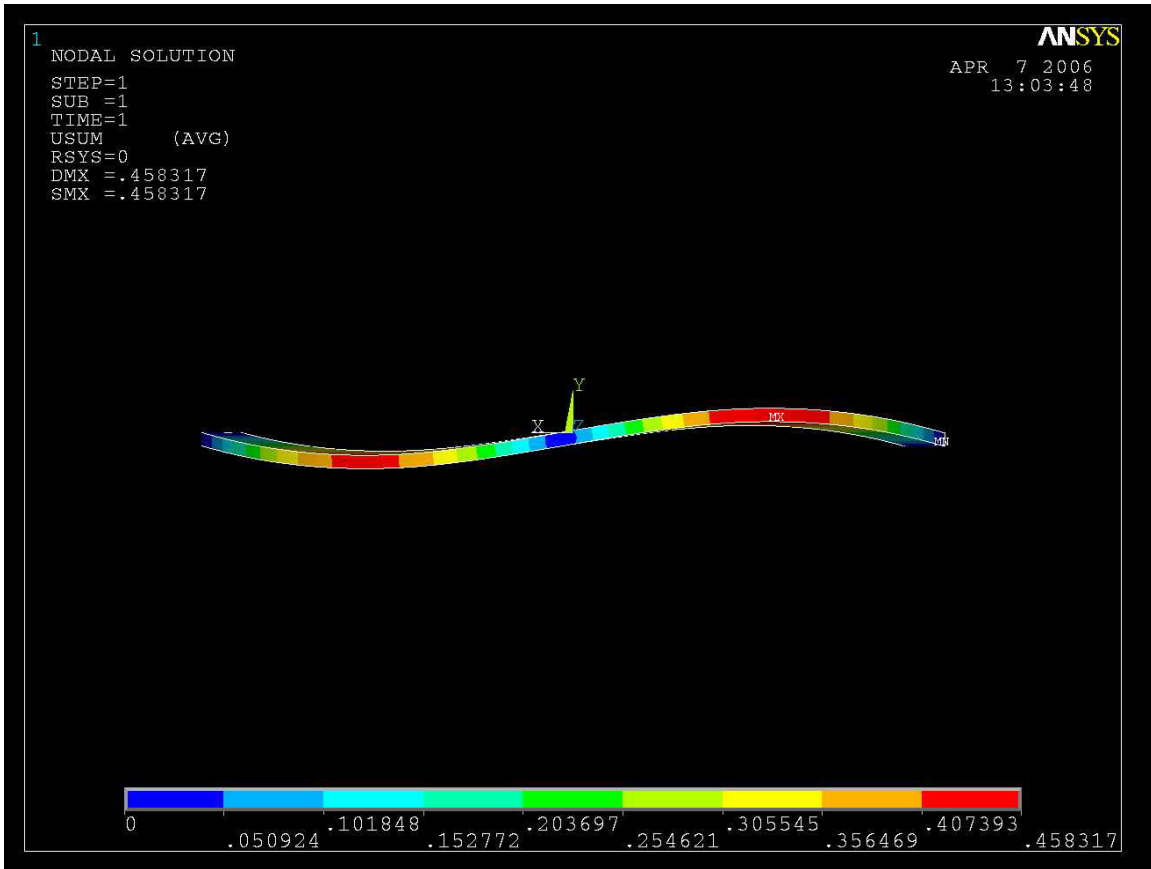

This is a result of half the torsional load or 12.5 ft-lb. on the Delrin® track. The zero displacement occur in the same locations as the previous setup. Under the load the track takes the same general shape as before, just with maximum deflections of a smaller magnitude. The maximum deflections was, as expected, half the value of the previous at 0.5 in. While considerably better, deflections of this magnitude would still hinder operation. In addition this load is the ideal loading condition and should not be counted on.

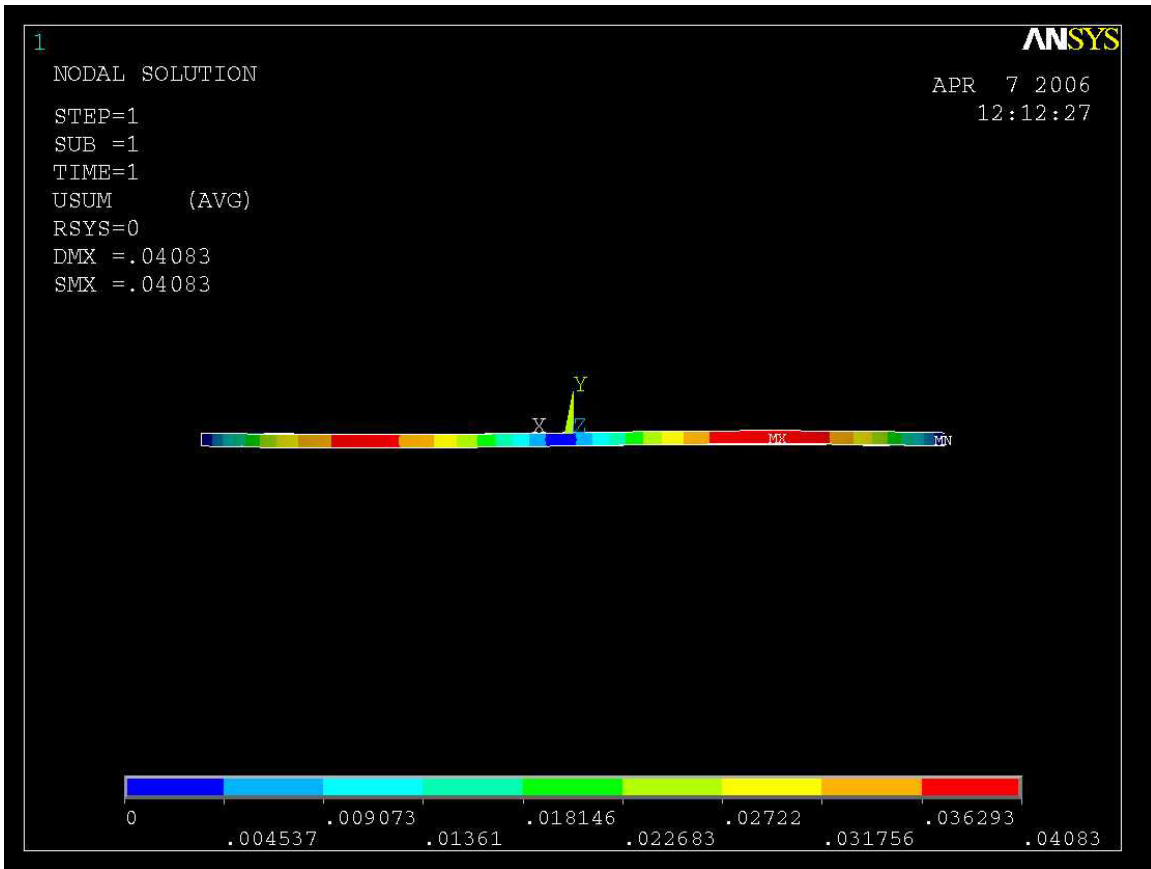

This is the result of the full 25 ft-lb. torsional load on the Aluminum track. As with the previous case the locations of 0 deflections are the same. The magnitude of the maximum deflections has changed dramatically. With the increase in stiffness of the material the maximum deflections became 0.04 inches. While taking the same general shape as previously seen under the deflections we believed that the magnitude would be small enough to still allow for full function. It must also be noted that this is the worst case loading condition, so generally there will be less deflection than this.

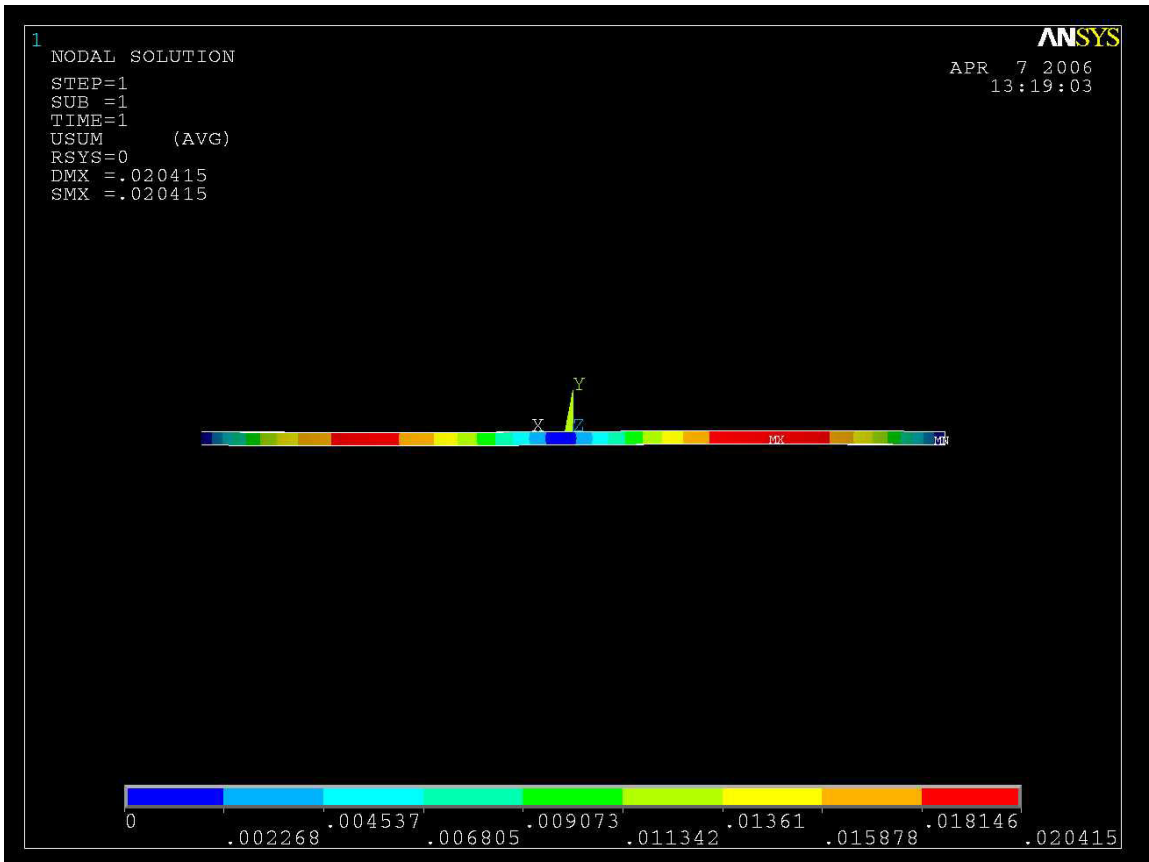

This is the result of half the torsional load, or 12.5 ft-lb. on the Aluminum track. Again, the increase in stiffness of material served to greatly lower the maximum deflections. The maximum value of the deflections in the case was 0.02 inches. This is the ideal loading condition and chances are there would be slightly more deflection, however it will be less than the worst case condition which we deemed to be acceptable.

Appendix F – Thread Pullout Analysis

Screw Information:

#6 - 32 UNC Machine Screw:

$$\begin{aligned}d_6 &:= 0.138 \text{ in} & N_6 &:= 32 \cdot \frac{1}{\text{in}} & p_6 &:= \frac{1}{N_6} & p_6 &= 0.031 \text{ in} \\d_{p6} &:= d_6 - \frac{0.649519}{N_6} & d_{p6} &= 0.118 \text{ in} & d_{r6} &:= d_6 - \frac{1.299038}{N_6} & d_{r6} &= 0.097 \text{ in}\end{aligned}$$

Tensile Area

$$A_{t6} := \frac{\pi}{4} \cdot \left(\frac{d_{p6} + d_{r6}}{2} \right)^2 \quad A_{t6} = 0.0091 \text{ in}^2$$

#8 - 32 UNC Machine Screw:

$$\begin{aligned}d_8 &:= 0.164 \text{ in} & N_8 &:= 32 \cdot \frac{1}{\text{in}} & p_8 &:= \frac{1}{N_8} & p_8 &= 0.031 \text{ in} \\d_{p8} &:= d_8 - \frac{0.649519}{N_8} & d_{p8} &= 0.118 \text{ in} & d_{r8} &:= d_8 - \frac{1.299038}{N_8} & d_{r8} &= 0.123 \text{ in}\end{aligned}$$

Tensile Area

$$A_{t8} := \frac{\pi}{4} \cdot \left(\frac{d_{p8} + d_{r8}}{2} \right)^2 \quad A_{t8} = 0.0114 \text{ in}^2$$

From Machine Design book:

$$\omega_0 := 0.88$$

Engagement Length for #6 Screw Assuming similar materials:

$$L_{e6'} := \frac{2 \cdot A_{t6}}{0.5 \cdot \pi \cdot (d_6 - 0.64952 p_6)} \quad L_{e6'} = 0.098 \text{ in}$$

Engagement Length for #8 Screw Assuming similar materials:

$$L_{e8'} := \frac{2 \cdot A_{t8}}{0.5 \cdot \pi \cdot (d_8 - 0.64952 p_8)} \quad L_{e8'} = 0.101 \text{ in}$$

Since the Previous Calculation was done under the assumption that the fastener material and the tapped material are the same a correction factor must be applied. This is found by the ratio of the tensile strengths of the materials. If the ratio is greater than 1 than the orginal engagement length must be multiplied by at least that number to prevent stripping of the threads.

Ultimate Tensile Strength of Steel Screw:

$$S_{ut_screw} := 50000 \text{ psi}$$

Ultimate Tensile Strength of Steel Hole (Delrin):

$$S_{ut_hole} := 11000 \text{ psi}$$

Correction Factor:

$$J := \frac{S_{ut_screw}}{S_{ut_hole}} \quad J = 4.545$$

Corrected Engagement Lenght for #6 Screw:

$$L_{e6} := L_{e6} \cdot J \quad L_{e6} = 0.447 \text{ in}$$

Corrected Engagement Lenght for #8 Screw:

$$L_{e8} := L_{e8} \cdot J \quad L_{e8} = 0.46 \text{ in}$$

These corrected engagement lengths are required to avoid shear failure of the threads (stripping). By definition of the equation, provided these values are satisfied, the failure mode of the fasteners will be in tension rather than in shear. However in this case since the hole material (Delrin) is the weaker of the two materials, tensile failure of the fastener is not possible. The fastener would pull out of the hole first.

While the above calculations provide the appropriate engagement length to avoid failure it is still good practive to have an idea of the magnitude of loads that would cause failure. As was mentioned before, we are worried about shear failure in the Delrin threads. The first step is to calculate the shear area of the threads.

Shear Area for #6 Screw:

$$A_{s6} := \pi \cdot d_6 \cdot \omega_0 \cdot p_6 \quad A_{s6} = 0.012 \text{ in}^2$$

Shear Area for #8 Screw:

$$A_{s8} := \pi \cdot d_8 \cdot \omega_0 \cdot p_8 \quad A_{s8} = 0.014 \text{ in}^2$$

The Shear Strength of Delrin:

$$S_{us_Delrin} := 9000 \text{ psi}$$

At this point we will introduce a safety factor into the calculations:

$$N := 2$$

To apply the safety factor we will divide the shear strength of Delrin by the safety factor:

$$\tau_s := \frac{S_{us_Delrin}}{N} \quad \tau_s = 4500 \text{ psi}$$

Now we will calculate the force F at which the threads would shear using the Shear Strength and the Tensile Area. :

For a #6 machine screw:

$$F_6 := \tau_s \cdot A_{s6} \qquad F_6 = 53.7 \text{ lbf}$$

For a #8 machine screw:

$$F_8 := \tau_s \cdot A_{s8} \qquad F_8 = 63.8 \text{ lbf}$$

By definition of the equation, this force is the force required to fail 1 thread. Because there is more than one thread engaged this is too conservative of an estimate. At this point we can use the information calculated above regarding how many threads are engaged. To do this we take the number of threads per inch and multiply by the engagement length.

Number of Threads engaged for a #6 Screw:

$$\text{threads}_6 := N_6 \cdot L_{e6} \qquad \text{threads}_6 = 14.295$$

Number of Threads engaged for a #8 Screw:

$$\text{threads}_8 := N_8 \cdot L_{e8} \qquad \text{threads}_8 = 14.71$$

With these values we can multiply the Shear Area by the number of threads that carry the load to find out the force required to fail that number of threads. At this point we can introduce another safety factor. We will assume that only half of the threads carry the load:

Force Required to Fail #6 Machine Screw:

$$F_6 := \tau_s \cdot A_{s6} \cdot \frac{\text{threads}_6}{2} \qquad F_6 = 383.475 \text{ lbf}$$

Force Required to Fail #8 Machine Screw:

$$F_8 := \tau_s \cdot A_{s8} \cdot \frac{\text{threads}_8}{2} \qquad F_8 = 468.958 \text{ lbf}$$

These are the forces required to fail 1 screw. Not only are these load notably higher than what we expect the device to experience, there is also nowhere in the design that 1 screw bears an entire load which introduces even more of a safety factor. The exact distribution of the loads will not be investigated because of the high variability between different loading conditions and positions. Instead it will be assumed that the above calculations are sufficient to say that we do not expect the chosen fasteners to fail.

Appendix G – Shear Pullout Analysis

There are two critical locations on our device where shear pull-out is a possibility - the pins in the support brackets and the strapping in the harness.

Pins in the Support Brackets

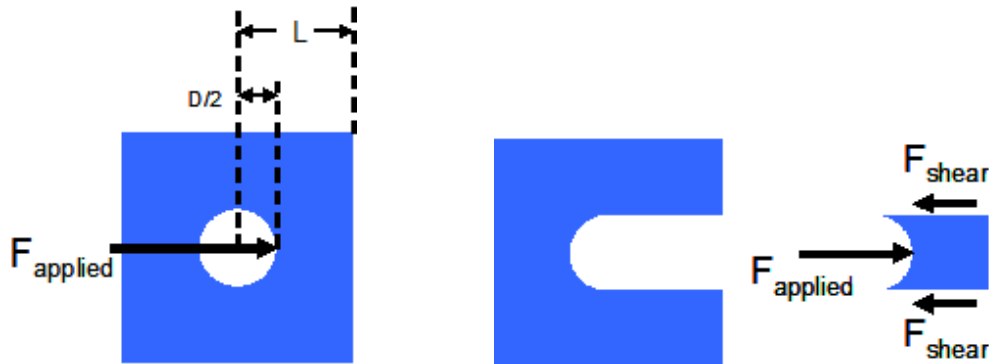

L is the distance from the center of the pin hole to the edge of the support bracket. D is the diameter of the pin hole. The pin hole is 0.75 inches deep. F_{applied} is the force applied on the support bracket by the pin (carriage bolt). F_{shear} are the resulting shear forces experienced by the top and bottom faces of the piece of material that may fail. A is the area on which F_{shear} acts.

Given: $D := \frac{3}{8} \text{ in}$ $L := \frac{1}{2} \text{ in}$

$$A := \left(L - \frac{D}{2} \right) \cdot 0.75 \text{ in}$$

$$A = 0.234 \text{ in}^2$$

Using the Shear Strength of the Aluminum support brackets (www.matweb.com), we can determine the maximum shear force that the material can withstand:

$$\text{ShearStrength}_{Al} := 3630 \text{ ksi}$$

The maximum shear force that the Aluminum can support before shear failure is given by:

$$F_{\text{shear}} := \text{ShearStrength}_{Al} \cdot A$$

$$F_{\text{shear}} = 8.508 \times 10^5 \text{ lbf}$$

Summing forces in the horizontal direction from the above diagram, we obtain:

$$F_{\text{applied}, Al} := 2 \cdot F_{\text{shear}}$$

The maximum applied force that this scenario can withstand is:

$$F_{\text{applied}, Al} = 1.702 \times 10^6 \text{ lbf}$$

This is much larger than any of the forces we anticipate our device to experience. Also, this is a conservative estimate for F_{applied} because:

- 1) The actual shear force will be distributed over a larger area - the flaps that create the circular pin cutout were not included in this analysis to add a safety factor. This is why we used $(L-D/2)$ in determining A .
- 2) Also, there is an additional face experiencing shear in the above scenario. The rear face of the cutout also experiences shear since the hole does not go all the way through the material. Both of these factors combine to create a conservative estimate for what F_{applied} is necessary to create failure.

Strapping in the Harness

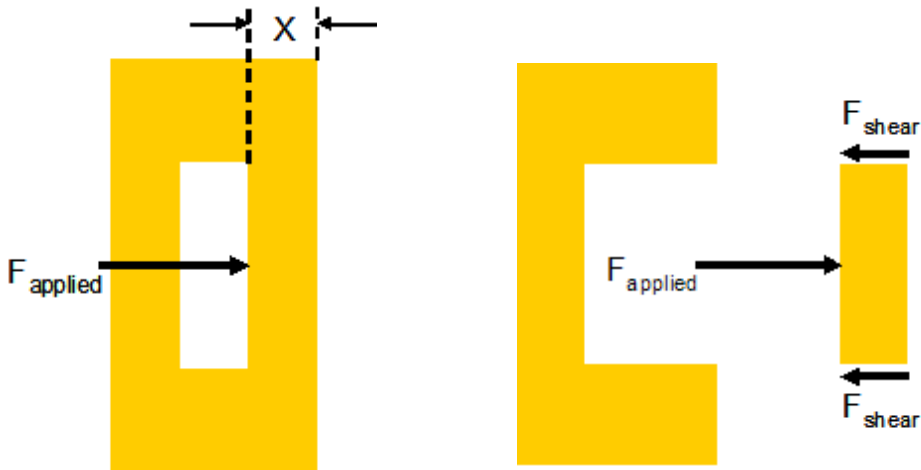

X is the distance to the edge of the hole that the strapping will be looped through to the edge of the material. F_{applied} is the maximum force that the straps will apply to the thermoplastic.

F_{shear} are the resulting shear forces acting within the thermoplastic.

Assume: $X := 1\text{in}$ Thickness $:= \frac{1}{8}\text{in}$

$$A := X \cdot \text{Thickness}$$

$$A = 0.125\text{in}^2$$

We found the material OmegaMax is manufactured from using the MSDS from the manufacturer. Using the lowest Tear Strength for polycaprolactone (www.matweb.com), we can determine the maximum shear force that the material can withstand:

$$\text{TearStrength}_{\text{poly}} := 72 \frac{\text{kN}}{\text{m}}$$

Based on a length of 1 inch, we can determine the shear strength of the polycaprolactone.

$$\text{ShearStrength}_{\text{poly}} := \frac{\text{TearStrength}_{\text{poly}}}{X}$$

$$\text{ShearStrength}_{\text{poly}} = 411.13\text{ lpsi}$$

The maximum shear force that the polycaprolactone can support before shear failure is given by:

$$F_{\text{shear}} := \text{ShearStrength}_{\text{poly}} \cdot A$$

$$F_{\text{shear}} = 51.391\text{ lbf}$$

Summing forces in the horizontal direction from the above diagram, we obtain:

$$F_{\text{applied.thermo}} := 2 \cdot F_{\text{shear}}$$

The maximum applied force that this scenario can withstand is:

$$F_{\text{applied.thermo}} = 102.783\text{ lbf}$$

This value is also much larger than any anticipated forces that we believe the device will experience.

Appendix H – Brake Analysis

The bearing brake holds the bearing in place relative to the arm interface. This aspect is crucial to ensure that the prosthesis does not slip during torsional loading. The brake will be manufactured with a rubber lining (thermoplastic elastomer) in order to increase the coefficient of friction between the bearing and the brake. The coefficient of friction used in these calculations is the μ of Delrin and steel. Therefore, the actual μ observed will be higher (Delrin and rubber).

$$\mu := .25 \quad (\text{Average value of } \mu \text{ from } \text{www.matweb.com})$$

The act of lifting a 25 pound backpack creates a 20ft-lb moment at the bearing (OD = 4.25) as shown in the following diagram.

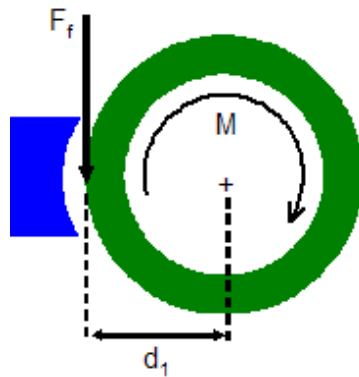

$$\text{Given:} \quad M := 20\text{ft}\cdot\text{lbf} \quad d_1 := 2.125\text{in}$$

$$\begin{aligned} \Sigma M \quad M &= F_f d_1 \\ F_f &:= 112.94\text{lbf} \end{aligned}$$

Use the following formula to determine what Normal force (N) will produce the required frictional force:

$$\begin{aligned} N &:= \frac{F_f}{\mu} \\ N &= 451.764\text{lbf} \end{aligned}$$

Assuming regular series screw threads that are used on dry surfaces, we can approximate the torque necessary needed to produce an axial force of $N = 62.745$ lbf when D is the diameter of the screw (nominal).

$$\begin{aligned} D &:= 0.5\text{in} \\ \text{Torque} &:= (.2) \cdot D \cdot N \\ \text{Torque} &= 3.765\text{ft}\cdot\text{lbf} \end{aligned}$$

Imrhan and Farahmand (Applied Ergonomics, 1999) found that, for males, cylinders 40-60mm in diameter are best for torque application by the hand. Our device falls within this range.

$$\begin{aligned} d_2 &:= 1.75\text{in} \\ d_2 &= 44.45\text{mm} \end{aligned}$$

The same study also showed that the greatest torque measurement generated was 17.73Nm (13.07 ft-lbf), with the minimum being 3.44Nm (2.54 ft-lbf). The minimum was obtained with the smallest handle (length and diameter) and using grease smeared gloves.

This falls in the range of the torques that the above study's participants were able to generate. This suggests that there should be no problem for our device's users to be able to tighten the brake knob to the required amount.

Appendix I – Range of Motion Test Procedures

Objective: to ensure the device does not impede on the user's 'normal' range of motion

Rationale: The shoulder is the most flexible joint in the human body. The anatomical structure of the joint enables it to have the most range of motion of any other joint in the body (Tortora and Grabowski, 2003). The ability to move the shoulder joint in a wide variety of directions is vital for complete functionality in activities of daily living.

I: Computer Test:

Materials: Computer
Pro-Engineer Wildfire 2 software
Human/Device model

Procedure:

1. Open the human/device model in Pro-Engineer Wildfire and perform Kutzbach analysis to confirm 3 degrees of freedom
Description of Model's Degrees of Freedom: There are three pin joints in the model that define the motion of the device. All three of these pin joints intersect at the center of the shoulder and because of this constraint mimic the natural motion of the ball and socket joint in the shoulder. The first pin joint runs down the center axis of the arm and controls humeral rotation. The second pin joint has an axis that stays perpendicular to the previous axis and controls some combination of flexion/extension and abduction/adduction depending on the orientation. The third joint is horizontal and also controls some combination of flexion/extension and abduction/adduction.
2. Define servo motors on each joint
Note: The motors will be defined using tables. The first column in the table is time and the second column is joint position. In the case of a pin joint, the joint position is defined as an angle. To test the various ranges of motion with regards to the ADLs listed in the table above, joint angles versus time will be determined and input into the servo motor table.
This will allow for a visual demonstration of an 'ideal' maximum and minimum envelope of motion. With the arm and elbow in a locked position, the servo motors will abduct the arm to 45°, forward flex the shoulder to the maximum, perform elbow flexion followed by humeral rotation to 90°, perform the motions in reverse, and then repeat the entire operation at 90 and 135°.
 - i. The servo motor definitions for range of motion envelope analysis at 45, 90, 135° are located in an Excel sheet
3. Define and set limits on pin-joints, as the joints are initially free to rotate 360°

- a. Limitation will be imposed on the joints and defined by the angle at which the device begins to interfere with the body.

Table 20 - Model Range of Motion and Respective Joint Angles

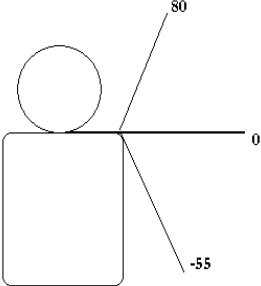
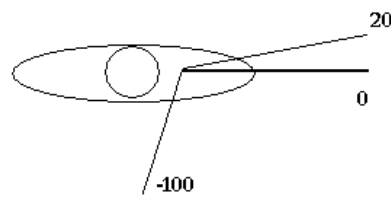
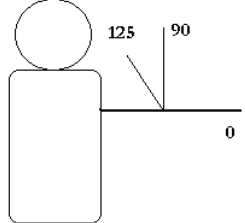
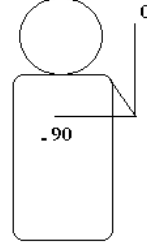
| <i>Range of Motion*</i> | <i>Minimum Joint Angle (degrees)</i> | <i>Maximum Joint Angle (degrees)</i> | <i>Diagram of Angle Measures</i> |
|-------------------------|--------------------------------------|--------------------------------------|--|
| Abduction | -55 | 80 |  |
| Forward Flexion | -100 | 20 |  |
| Elbow Flexion | 90 | 125 |  |
| Humeral Rotation | -90 | 0 |  |

*with respect to the model's orientation.

The joint measures presented cannot be directly compared to typical values for range of motion due to the orientation of the device on the body.

4. Start simulation by implementing movement of the arm about the glenohumeral joint
 - a. The definition of the joint motors in conjunction with definitions of the joint limitations will be used to determine the range of motion of the device. The motors will move the arm by way of the

appropriate nominal joint angles presented in Step 3. This will provide proof of the functionality of the device.

Note: In the event that a joint limitation is reached the model will produce an error alerting us of the problem. Any limitations will be noted. This will yield a baseline for when testing the prototype on an actual subject.

5. Record maximum and minimum angle measures for each articulation
6. Construct a 3-D trace-curve and solid envelope for visualization of maximum and minimum range of motion values.

Analysis Procedure:

1. Determine the percent difference between the measured range of motion with the device on the model and the range of motion presented in the literature for young, normal, healthy joints.

II: Device Test I: To measure the allowable range of motion of the device and possible self-interference

Materials: 2 ft x 2 ft sheet of paper (or larger)
Pen, pencil
Tape
Shoulder Mount Device
Protractor
Goniometer
Meter/Yard Stick
Ruler

Procedure:

Create an Axis by which to measure allowable range of horizontal motion of device:

1. Obtain a 2 ft. x 2 ft sheet of paper, or larger
2. Create a general Cartesian coordinate system by drawing two perpendicular straight lines intersecting at the center of the paper

Measuring horizontal range of motion:

3. Attach a pen or pencil to the center of the arm interface such that the point of the writing utensil will create a mark on the paper
4. Place the device flat on the surface, such that the arc of the track is orientated away from the center of the coordinate system and the flat ends are aligned with the vertical line drawn in Step 2, see Figure 112 for reference.
 - a. Note: The track should also be equally aligned with the horizontal axis, such that the device is symmetric about the horizontal axis.

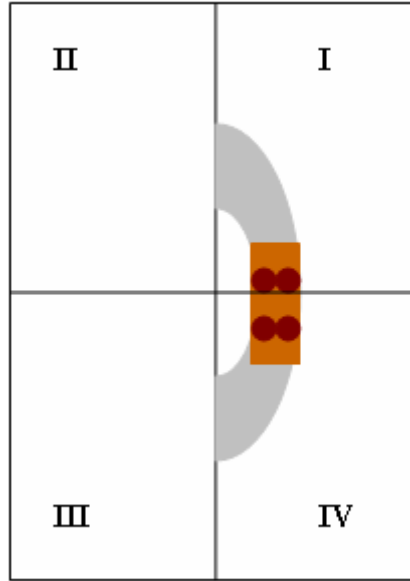

Figure 112 – Orientation of the device on the paper

5. Slide the arm interface component clockwise to the end of the track, Figure 113

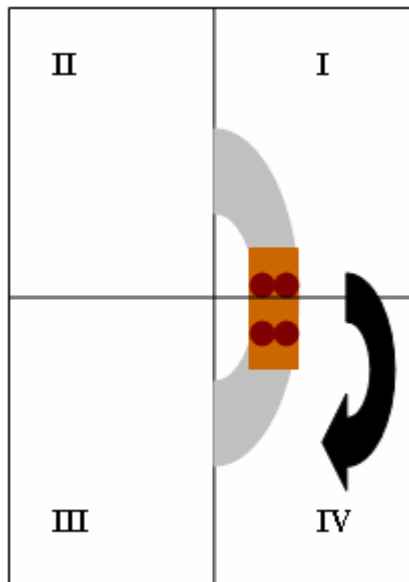

Figure 113 – Motion for the Arm Interface

6. Repeat in the counterclockwise direction, sliding the arm interface to quadrant I
 7. Remove device from paper and connect the maximum and minimum points drawn by the pencil to the origin of the coordinate system drawn in Step 1.
 8. Using a protractor, measure the angles
- Measuring vertical range of motion:

9. Place device on flat surface (i.e. tabletop), such that the thermoplastic is resting in an upright position and the track/arm interface components are resting in its natural position
10. Extend track and arm interface components upwards in a counterclockwise fashion
11. Using a goniometer, measure and record the angles at which the device reaches the following (mock-abduction):
 - a. Interference with the thermoplastic
 - b. Limitations with the brace(s)
 - c. Maximum vertical angle
12. Bring thermoplastic to the edge of the flat surface, extend the track/arm interface clockwise and record any interference at the following points (mock-adduction):
 - a. Interference with the thermoplastic
 - b. Limitations with the brace(s)
 - c. Minimum vertical angle

III: Device Test II: To test for the percent change in the range of motion pre- and post donning the device for a user

Materials: Test subject(s)
Shoulder Mount Device
Goniometer

Range of Motion Assessment for Each Test Subject:

1. Perform the following actions and record angle measures:
 - a. Vertical Abduction
 - b. Vertical Adduction
 - c. Forward Flexion
 - d. Extension
 - Flex the arm to 90°
 - e. Horizontal Abduction
 - f. Horizontal Adduction
2. Test subject dons the device
3. Repeat step 1
4. Compare post-donning degree measures to prior-donning; record the average percent change for each group

Analysis: To ensure that the device does not impede on the user's existing range of motion, measurements from the pre-test, where no device was present, will be compared to the measurements made with the device on. Measurements will be tabulated and compared to not only user against his/herself but also in comparison to the range of motion given in the computer model.

Appendix J – Axial Load Carrying Test Procedure

Objective: to determine if the device has an axial load carrying capacity greater than 20 pounds

Rationale: In addition to accommodating activities of daily living without interference, the shoulder mount must further incorporate lifting loads greater than those of every day objects (i.e. hairbrush, toothbrush, dinnerware, phone, etc) , such as lifting a suitcase (≈ 60 pounds). Existing prostheses are commonly attached to the user by vacuum suction and thus do not allow for such heavy loads to be applied distal from the residual limb, as the vacuum force holding the prosthesis cannot counteract the distal, externally applied force. On the other hand, prostheses attached via strapping may support these axial loads, but do not allow for loading throughout the range of motion.

Test Specific Goal: to determine the displacement of the harness about the body during axial load-bearing situations

Materials:

- Test Subject(s)
- Spring Scale
- Shoulder Mount Device
- Axial Mock-Prosthesis
- Meter Stick
- White t-shirt (5)

Procedure:

1. Place a reference mark at 90° on the outer lip of the Mock- Prosthesis

Note: This will serve as a reference point from which to measure any rotation during weight bearing, as represented in Figure 114 by the 'x'. An additional marker should be placed on the arm interface directly in line with the 'x' to be used in the possible determination of radial movement.

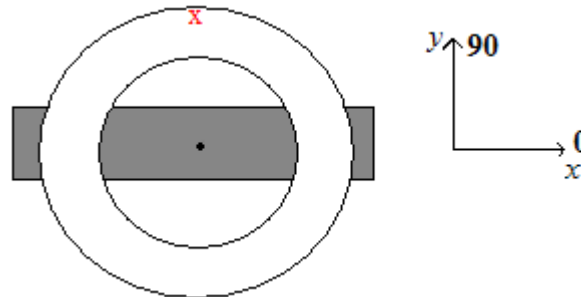

Figure 114 - PVC and Bolt, Zero and Ninety Degree Measures

2. Draw a circumferential line around the PVC to serve as a reference for axial displacement at the point closest to the PVC/bearing interface
3. Attach the Mock Prosthesis to the Arm Interface of the device by screwing the mock prosthesis into the tapped holes in the bearing through the brackets
4. Have test subject, wearing a white t-shirt, don the Harness and Strapping of the device, sliding arm through the Mock-Prosthesis

Note: The test subject's arm will serve as a positioning system, so the angle measurement required for testing will remain constant. In order to differentiate between forces of the trunk and that of the upper arm, test subject should remain seated upright in a chair for the duration of the test.

5. Trace an outline of the harness in marker, directly onto the test subject's shirt
Simulating Weight-bearing Situations
6. Affix Spring Scale to the center of the bolt length and center of the bolt diameter of the Mock-Prosthesis
7. Pulling straight down, apply an initial 5 pounds of force to the Spring Scale
Note: Test subject should abduct arm to a stationary position 45° below the x-axis.

The test subject will simply have his/her arm in the PVC pipe, making a fist. This way, the arm is providing minimal frictional force, and the force balancing the spring scale is completely within the device and strapping. Articulated at 45° allows for situational comparison between forces measured in the lab and forces calculated in Free-Body Diagrams

8. In 5 pound increments, apply a load up to 70 pounds to the mock prosthesis
9. For analysis of the Mock-Prosthesis, measure the following possible changes to the system after each incremental load:
 - a. Rotation of the Mock-Prosthesis (as measured from the marks in Step 4)
 - b. Axial Displacement of the Mock-Prosthesis (as measured from the circumferential line around the PVC created in Step 5 to the edge of the arm interface)
 - c. Movement of the harness
10. For analysis of the device under load bearing situations, record possible observations of the following:
 - a. Component interference
 - b. Deformation of any component
 - c. Pressures and respective locations of occurrence on the body
 - i. Defined as observed pressures greater than the pressure of application of the system to the body
11. Remove all applied loads and have the test subject position Mock-Prosthesis along the x-axis
Note: When applying forces to the prosthesis situated along the x-axis, the spring scale should be applied on the same axis as the arm, creating a purely axial load.

Analysis:

The main objective of the test is to determine whether or not the device is capable of supporting loads greater than 20 pounds. In true-load bearing situations, the design incorporates a custom-made prosthesis that will interlock with the arm interface via screws that hold the prosthetic socket against the bearing. The reference marks constructed in Step 4 and 5 serve as markers in determining the rotation and axial displacement. The Mock-Prosthesis will be considered effective if there is less than 2° of rotation or less than 1 cm displacement as defined in Step 12 and movement of the harness cannot exceed 1 inch in any direction.

Stress analysis of the system can be inferred from the force applied at the specific angles and correlation to the Free-Body Diagram analysis can be discussed.

Component interference, possible deformation of the components, excessive pressures on the body, and movement of the harness as observed by the test subject will yield to future design changes and or recommendations for improvement.

Appendix K – Torsional Load Carrying Test Procedure

Objective: To assess the torsional (moments about the humeral axis) load carrying capacity of the device

Rationale: The strength of a given shoulder action is determined by the net torque created by the muscles responsible for that action. During the action, both the magnitude and direction of the muscle force and the distance between the point of application of the force and the center of movement (the moment arm) determine the net torque on the shoulder (U. of Washington, 2005). The summation of all the muscle actions around the glenohumeral joint must provide joint stability and the torque necessary to carry out the desired action.

The Shoulder Mount has incorporated the addition of a user-controlled friction brake attached to the arm guide. This functions as a means to prevent humeral rotation under loading conditions that would cause torsional loading to the prosthesis to compensate for users without a fully functional glenohumeral joint. Clockwise rotation of the bearing brake knob moves the brake towards the bearing, thus creating a high friction fit between the two components, prohibiting rotation.

An example of a normal activity that a prospective user would undergo in daily living where torsional loads occur would be lifting an object to the face, such as holding a glass in front of his/her mouth, where the elbow is bent at some angle, θ , the arm is abducted and parallel to ground, and the forearm is parallel to the frontal plane. Without sound torsional stability, activities such as eating and grooming independently will be virtually impossible without assistance.

Test Specific Goal: to determine the overall effectiveness of the variable friction brake and harness response under application of torque

Materials:

- Test subject
- White tshirt (5)
- Straight-edge
- Marker (8 colors)
- Spring Scale (2)
- Mock-Prosthesis
- 6 feet Picture hanger wire (25 lb strength)
- Protractor
- Goniometer

Protocol Set-up:

Reference Marks

Purpose: to determine how many rotations the brake knob must be turned to insure a sound fit between the bearing and the bearing brake

1. Turn the brake knob all the way counterclockwise, thereby aligning the brake knob such that the brake is furthest away from the bearing, in a “least secure” position; this point will be referenced as the ‘starting position’ for the brake knob
2. On the arm guide, use a straight edge and a marker to create a horizontal reference line to the right of the brake knob insert

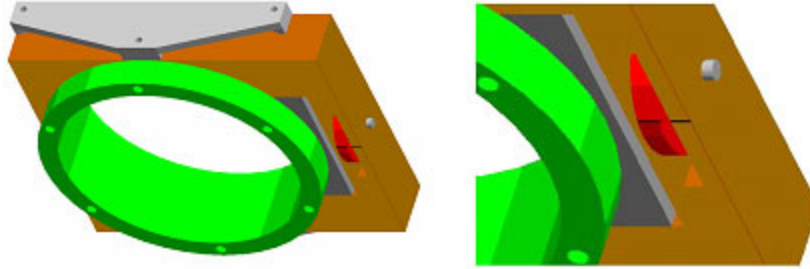

Figure 115 - Reference marks on Arm Guide & Brake Knob

3. Create an identical horizontal line of the same thickness across the thickness of the bearing knob, Figure 115
4. Using different colors, draw two more reference lines on the knob marking for quarter-revolution reference marks at the top of the brake knob and bottom, Figure 116

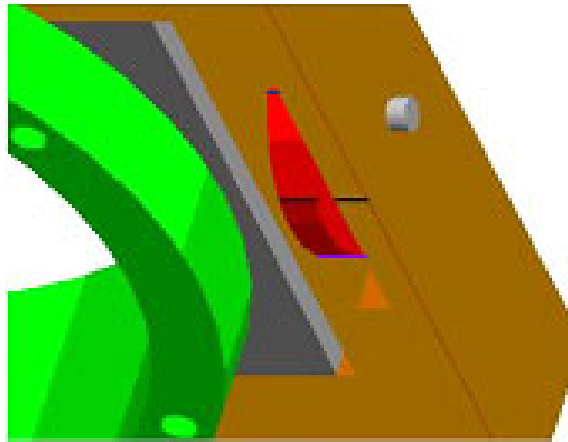

Figure 116 - Quarter-Revolution Reference Marks

5. Rotate the brake knob clockwise such that the bottom-most reference mark created in Step 4 is now aligned with the reference line marked on the arm guide created in Step 2
6. Mark a final reference mark, in a different color, on the bottom of the brake knob such that there is now a series of four different colored reference lines on the brake knob, accounting for quarter-revolution accuracy

Setting up the Spring Scale

Purpose: to enable variable torsional force to be applied to the Mock-Prosthesis

1. Cut the picture hanger wire into two pieces, 3 ft. in length
2. Wrap one end of the picture hanger wire around one spring scale three times and tie secure
3. Repeat for the remaining wire piece and spring scale
4. Wrap the free end of the picture hanger wire between the two hex nuts that are situated on the attachment rod, as referenced in the Manufacturing Procedure for the Torsional Mock-Prosthesis
5. Repeat for remaining wire-spring scale set-up on the opposite attachment rod

Torsional Test

1. Have test subject don the device for positioning purposes and sit in a chair for the duration of the testing procedure
2. Secure the Mock-Prosthesis into the bearing
 - a. Turn the brake knob to greatest number of revolutions that the strongest team member can achieve and record
3. Use a straight edge and a marker to create two identical marks: one to the left of the brake knob insert on the arm guide and one directly next to it, at the same horizontal location, on the Mock-Prosthesis, Figure 117

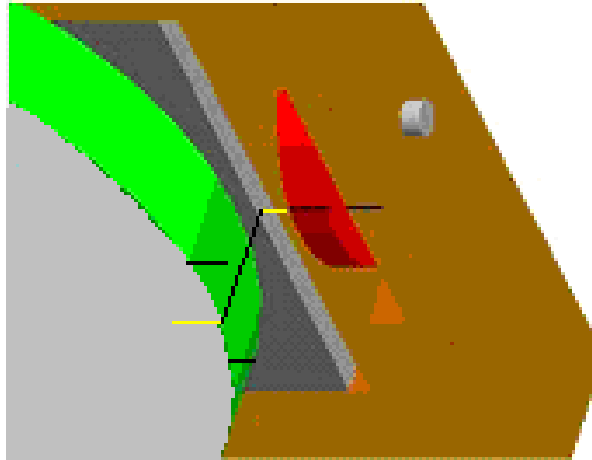

Figure 117 - Additional Reference Marks

Step 3 is denoted by the yellow marks with a black line connecting the two for visual purposes. Step 4 is denoted by the 5° of rotation as denoted by the black lines above and below the initial yellow reference marker.

4. Create two additional marks on the arm guide: one 5° clockwise and one 5° counterclockwise from the mark created in the previous step to be used when judging for possible rotation of the Mock-Prosthesis during loading, Fig. 3
5. Using a marker, trace the harness outline directly onto test subject's t-shirt
6. Have test subject orient the Mock-Prosthesis to be abducted at a stationary position at 90°, on the x -axis, as presented in the team-defined 'Coordinate System'
 - a. For testing purposes, a custom-made ramp on which the test subject can rest his/her arm on was constructed. This will insure that the arm does not decrease the 90° angle during testing due to fatigue.
7. Align the springs to create a couple, Figure 118.

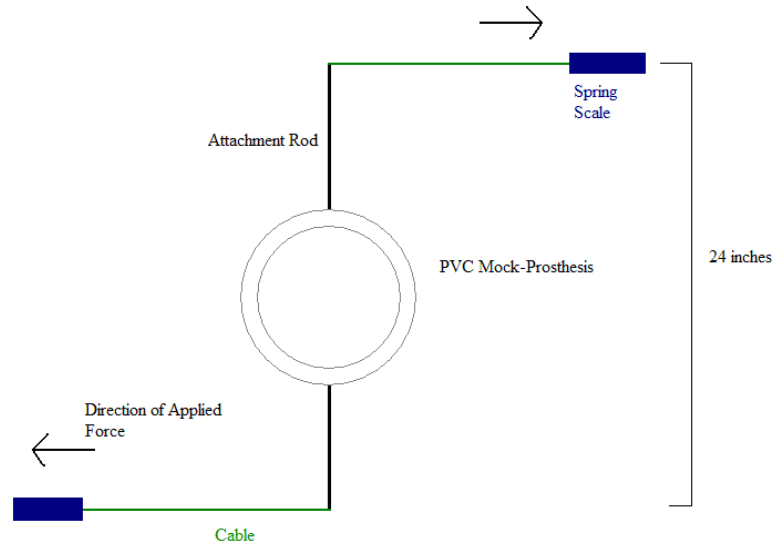

Figure 118 - Torsional Test Set-Up, Front View

8. Apply 14 initial pounds of force to each spring scale, by having one team member pull on one spring scale (one team member/one spring scale). Set-up should mimic Figure 5, from the side view. The arrows indicate the direction the force is being applied.
 - a. Be observant for movement of the Mock-Prosthesis as measured from the reference marks constructed in Step 3 of this testing procedure
 - b. Use a different colored marker than used to draw the harness outline to mark locations on the white t-shirt to indicate any applicable movement of the harness
 - c. With the 14 pounds still applied to each spring scale, have test subject translate the Mock-Prosthesis horizontal, 90° to the frontal plane and record any movement of the harness and/or Mock-Prosthesis
 - i. If translation to 90° cannot be accomplished record the maximum angle of translation and movement of the harness about that angle measure; record reason for $<90^\circ$ translation
 - d. At 90° (or the greatest angle measured) in the frontal plane, with the 14 pounds still applied to each spring scale, have test subject forward flex the Mock-Prosthesis and record greatest angle achieved; repeat for extension

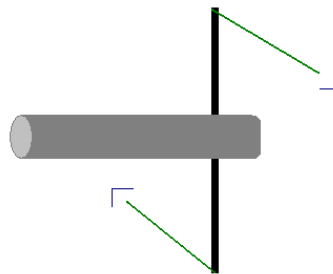

Figure 119 - Torsional Set-Up, Side View

9. Decrease the number of revolutions by one, holding the 14 pounds applied to each

- spring scales
- a. Be observant for movement of the Mock-Prosthesis as measured from the reference marks constructed in Step 3 of this testing procedure
 - b. Use a different colored marker than used to draw the harness outline to mark locations on the white t-shirt to indicate any applicable movement of the harness
10. Continue to decrease the number of revolutions -one revolution at a time, of the brake knob until failure, recording both possible Mock-Prosthesis and harness movement after each revolution decrease
- a. Failure is constituted as:
 - i. the Mock-Prosthesis twists beyond 5° from its original start-location, as annotated by the reference marks in Step 3
 - ii. when the Mock-Prosthesis comes out of the arm guide
 - iii. the harness exhibits movement greater than one inch in any direction
11. Repeat the procedure 4 times, insuring that the brake knob remains at the ‘starting position’ prior to tightening and recording the number of initial revolutions

Analysis

By decreasing the number of revolutions incrementally, a range of applicable revolutions will be reported to the prospective user to ensure that the same standard of security will be in place. This also allows for the prospective user to exhibit varying strength in his/her right arm to rotate the brake knob.

The Torsional Test procedure results will be judged pass-fail. If the device can withstand torsional loads and not subject the Mock-Prosthesis to failure as stated in Step 10 of the Torsional Test, then it can conclusively be stated that the bearing brake is fully effective to a maximum of 28 ft-lbs. If the brake fails at low forces, then the surface material of the brake can be altered from rubber to another material with a higher coefficient of friction and thereby preventing motion. The test procedure can also be repeated, decreasing the initial amount of force applied to each spring scale to yield a trend in results. Conclusions can be gathered in stating how many revolutions are needed to hold the Mock-Prosthesis in place under 2-14 pounds applied to each spring scale and the different angle measures achieved during flexion-extension, abduction-adduction (as referenced in Step 8c and 8d).

During the varying load bearing situations, changes of the harness will be measured, recorded, and reported regarding angle and displacement. Possible recommendations for harness adaptation can be reported for future recommendations based on the degree of displacement.

In locking humeral rotation, the entire Shoulder Mount should be able to perform all desired range of motion activities as defined in the RoM and ADL assessment testing procedure.

Appendix L - Manufacturing Plans for Mock-Prostheses

Axial Mock-Prosthesis

Materials:

3" i.d. PVC pipe
3" i.d. PVC end-cap
PVC cement
Chop Saw
Drill Press & 9/32" drill bit
1/4" x 4" carriage bolt
Lock nut
90° brackets (6)

Procedure:

1. Using a chop saw, cut a 3" ID PVC pipe to 40" length
2. Using a drill press, drill a 9/32" hole, 1" from the end of the pipe, through both walls of the pipe
3. Cement the pipe to the end cap, at the opposite end of the hole from Step 2
4. Place a 1/4" x 4" carriage bolt through this hole and secure with a lock nut
5. Affix the six 90° brackets to the opposite end of the PVC pipe equally around the circumference of the pipe

Torsional Mock-Prosthesis

Materials: 3" i.d. PVC pipe
3" i.d. PVC end-cap
PVC cement
Chop saw
Drill Press & 13/32" drill bit
10.5 inch 3/8-16 threaded rod (2)
hex nuts (4)
90° brackets (6)

Procedure:

1. Using a chop saw, cut a 3" ID PVC pipe to 40" length
2. Affix the six 90° brackets to the smooth end of the PVC end-cap equally around the circumference of the pipe
3. Cement the pipe to the end cap
4. Using a drill press, drill a 13/32" hole approx. 5" from the end of the pipe at the opposite end as the 90° brackets
5. Place a 10.5 inch long, 3/8 - 16 threaded rod through each hole securing the rod with a lock nut on each side of the PVC pipe, leaving the center of the PVC unobstructed
6. Secure two hex nuts to the end of each threaded rod, distal from the PVC, leaving 3-5 threads in between each nut

Note: attachment of the Mock-Prostheses into the bearing requires (6) #8-32" screws.

Appendix M – Completed Selection Matrices

The following figures are the completed selection matrices from each group member. Analysis of the results led to the selection of the preliminary design.

Bertini Completed Selection Matrices

| Shoulder Joint | | | | | | | | | | | | | |
|---------------------------------------|--------|--------|----------|-----------|----------|-----------------|----------|-------------|----------|-------------|----------|-----------------|----------|
| Criteria | Weight | Gimbal | | L-Bracket | | Ferromag Sheath | | Locking Bar | | Locking Cam | | Modified Gimbal | |
| | | Score | Wtd. Sc. | Score | Wtd. Sc. | Score | Wtd. Sc. | Score | Wtd. Sc. | Score | Wtd. Sc. | Score | Wtd. Sc. |
| Performance | 0.3 | | | | | | | | | | | | |
| Interface with existing pros/orth | 0.1 | 5 | 0.15 | 3 | 0.09 | 2 | 0.06 | 4 | 0.12 | 4 | 0.12 | 5 | 0.15 |
| Effect on Required Work | 0.075 | 4 | 0.09 | 2 | 0.045 | 1 | 0.0225 | 3 | 0.0675 | 3 | 0.0675 | 4 | 0.09 |
| Stability (+) | 0.2 | 3 | 0.18 | 5 | 0.3 | 1 | 0.06 | 4 | 0.24 | 4 | 0.24 | 4 | 0.24 |
| Range of motion (+) | 0.15 | 4 | 0.18 | 5 | 0.225 | 1 | 0.045 | 4 | 0.18 | 4 | 0.18 | 4 | 0.18 |
| Load Distrib. (+) | 0.2 | 3 | 0.18 | 2 | 0.12 | 1 | 0.06 | 3 | 0.18 | 3 | 0.18 | 3 | 0.18 |
| Facilitate activities of daily living | 0.075 | 4 | 0.09 | 4 | 0.09 | 2 | 0.045 | 4 | 0.09 | 4 | 0.09 | 4 | 0.09 |
| Load Capacity (+) | 0.2 | 1 | 0.06 | 3 | 0.18 | 2 | 0.12 | 3 | 0.18 | 3 | 0.18 | 3 | 0.18 |
| Sub-Total: | 1 | | 0.93 | | 1.05 | | 0.4125 | | 1.0575 | | 1.0575 | | 1.11 |
| Safety | 0.2 | | | | | | | | | | | | |
| No sharp edges (-) | 0.5 | 3 | 0.3 | 4 | 0.4 | 2 | 0.2 | 5 | 0.5 | 5 | 0.5 | 5 | 0.5 |
| Minimize pinch points (-) | 0.5 | 2 | 0.2 | 3 | 0.3 | 1 | 0.1 | 3 | 0.3 | 3 | 0.3 | 3 | 0.3 |
| Sub-Total: | 1 | | 0.5 | | 0.7 | | 0.3 | | 0.8 | | 0.8 | | 0.8 |
| Use Friendliness | 0.15 | | | | | | | | | | | | |
| Don/Doff Ease (+) | 0.2 | 2 | 0.06 | 2 | 0.06 | 1 | 0.03 | 3 | 0.09 | 3 | 0.09 | 3 | 0.09 |
| Ease of storage | 0.05 | 5 | 0.0375 | 1 | 0.0075 | 2 | 0.015 | 4 | 0.03 | 4 | 0.03 | 4 | 0.03 |
| Ease of Maintenance (-) | 0.1 | 3 | 0.045 | 2 | 0.03 | 2 | 0.03 | 4 | 0.06 | 4 | 0.06 | 3 | 0.045 |
| Adjustability (+) | 0.2 | 3 | 0.09 | 3 | 0.09 | 3 | 0.09 | 2 | 0.06 | 2 | 0.06 | 2 | 0.06 |
| Breathability (+) | 0.15 | 4 | 0.09 | 2 | 0.045 | 3 | 0.0675 | 2 | 0.045 | 2 | 0.045 | 3 | 0.0675 |
| Non-irritating to skin (+) | 0.15 | 5 | 0.1125 | 2 | 0.045 | 3 | 0.0675 | 3 | 0.0675 | 3 | 0.0675 | 3 | 0.0675 |
| Aesthetics (+) | 0.15 | 2 | 0.045 | 4 | 0.09 | 1 | 0.0225 | 4 | 0.09 | 4 | 0.09 | 4 | 0.09 |
| Sub-Total: | 1 | | 0.48 | | 0.3675 | | 0.3225 | | 0.4425 | | 0.4425 | | 0.45 |
| Reliability | 0.15 | | | | | | | | | | | | |
| Shock Resistant (+) | 0.4 | 3 | 0.18 | 1 | 0.06 | 2 | 0.12 | 4 | 0.24 | 4 | 0.24 | 4 | 0.24 |
| Washable (+) | 0.1 | 2 | 0.03 | 1 | 0.015 | 1 | 0.015 | 1 | 0.015 | 1 | 0.015 | 1 | 0.015 |
| Sweat and Performance | 0.2 | 3 | 0.09 | 2 | 0.06 | 3 | 0.09 | 2 | 0.06 | 2 | 0.06 | 2 | 0.06 |
| Fatigue Resistance (+) | 0.3 | 3 | 0.135 | 1 | 0.045 | 2 | 0.09 | 3 | 0.135 | 3 | 0.135 | 3 | 0.135 |
| Sub-Total: | 1 | | 0.435 | | 0.18 | | 0.315 | | 0.45 | | 0.45 | | 0.45 |
| Cost | 0.05 | | | | | | | | | | | | |
| Materials (-) | 0.4 | 5 | 0.1 | 1 | 0.02 | 3 | 0.06 | 4 | 0.08 | 4 | 0.08 | 4 | 0.08 |
| Manufacture (-) | 0.4 | 4 | 0.08 | 1 | 0.02 | 3 | 0.06 | 3 | 0.06 | 3 | 0.06 | 3 | 0.06 |
| Maintenance costs (-) | 0.2 | 4 | 0.04 | 2 | 0.02 | 2 | 0.02 | 3 | 0.03 | 3 | 0.03 | 3 | 0.03 |
| Sub-Total: | 1 | | 0.22 | | 0.06 | | 0.14 | | 0.17 | | 0.17 | | 0.17 |
| Production | 0.15 | | | | | | | | | | | | |
| Ease of Manufacture (+) | 0.5 | 3 | 0.075 | 2 | 0.05 | 3 | 0.075 | 3 | 0.075 | 3 | 0.075 | 3 | 0.075 |
| Ease of Assembly (+) | 0.5 | 2 | 0.05 | 1 | 0.025 | 2 | 0.05 | 4 | 0.1 | 4 | 0.1 | 4 | 0.1 |
| Sub-Total: | 1 | | 0.125 | | 0.075 | | 0.125 | | 0.175 | | 0.175 | | 0.175 |
| TOTAL | 1 | | 2.69 | | 2.4325 | | 1.615 | | 3.095 | | 3.095 | | 3.155 |

Harness

| Criteria | Weight | | Backpack | | Shoulder Plate | | Double-Nine | | Double Armpit | | Doublet X-Yoke | | Vest | | Corset | | Arm w/ Torso | | Harness w/ Torso | |
|---------------------------------------|----------|----------|---------------|----------|----------------|----------|---------------|----------|---------------|----------|----------------|----------|---------------|----------|---------------|----------|---------------|----------|------------------|----------|
| | Score | Wtd. Sc. | Score | Wtd. Sc. | Score | Wtd. Sc. | Score | Wtd. Sc. | Score | Wtd. Sc. | Score | Wtd. Sc. | Score | Wtd. Sc. | Score | Wtd. Sc. | Score | Wtd. Sc. | Score | Wtd. Sc. |
| Performance | | | | | | | | | | | | | | | | | | | | |
| Interface | 0.1 | 4 | 0.12 | 3 | 0.09 | 3 | 0.09 | 4 | 0.12 | 4 | 0.12 | 4 | 0.09 | 3 | 0.09 | 4 | 0.12 | 4 | 0.12 | 4 |
| Effect on Required Work | 0.075 | 4 | 0.09 | 3 | 0.0675 | 4 | 0.09 | 5 | 0.1125 | 5 | 0.1125 | 2 | 0.045 | 2 | 0.045 | 5 | 0.1125 | 5 | 0.1125 | 5 |
| Stability (+) | 0.2 | 4 | 0.24 | 4 | 0.12 | 4 | 0.12 | 4 | 0.24 | 5 | 0.3 | 5 | 0.12 | 2 | 0.12 | 5 | 0.3 | 5 | 0.3 | 5 |
| Range of motion (+) | 0.15 | 2 | 0.09 | 5 | 0.225 | 3 | 0.135 | 3 | 0.135 | 3 | 0.135 | 2 | 0.09 | 2 | 0.09 | 4 | 0.18 | 2 | 0.09 | 3 |
| Load Distrib. (+) | 0.2 | 4 | 0.24 | 4 | 0.12 | 3 | 0.18 | 5 | 0.3 | 5 | 0.3 | 3 | 0.18 | 1 | 0.06 | 5 | 0.3 | 5 | 0.3 | 5 |
| Facilitate activities of daily living | 0.075 | 2 | 0.045 | 2 | 0.045 | 2 | 0.045 | 4 | 0.09 | 4 | 0.09 | 1 | 0.0225 | 2 | 0.045 | 3 | 0.0675 | 3 | 0.0675 | 3 |
| Load Capacity (+) | 0.2 | 4 | 0.24 | 2 | 0.12 | 3 | 0.18 | 5 | 0.3 | 5 | 0.3 | 4 | 0.24 | 2 | 0.12 | 5 | 0.3 | 5 | 0.3 | 5 |
| Sub-Total: | 1 | | 1.065 | | 0.7875 | | 0.96 | | 1.3575 | | 0.9975 | | 0.57 | | 0.825 | | 1.29 | | 1.335 | |
| Safety | | | | | | | | | | | | | | | | | | | | |
| No sharp edges (-) | 0.5 | 5 | 0.5 | 5 | 0.5 | 5 | 0.5 | 5 | 0.5 | 5 | 0.5 | 3 | 0.3 | 3 | 0.3 | 5 | 0.5 | 5 | 0.5 | 5 |
| Minimize pinch points (-) | 0.5 | 4 | 0.4 | 4 | 0.4 | 3 | 0.3 | 3 | 0.3 | 3 | 0.3 | 2 | 0.2 | 2 | 0.2 | 2 | 0.2 | 2 | 0.2 | 2 |
| Sub-Total: | 1 | | 0.9 | | 0.9 | | 0.8 | | 0.8 | | 0.5 | | 0.5 | | 0.5 | | 0.7 | | 0.7 | |
| Use Friendliness | | | | | | | | | | | | | | | | | | | | |
| Don/Doff Ease (+) | 0.15 | 4 | 0.12 | 4 | 0.12 | 3 | 0.09 | 3 | 0.09 | 3 | 0.09 | 2 | 0.06 | 2 | 0.06 | 2 | 0.06 | 2 | 0.06 | 3 |
| Ease of storage | 0.05 | 4 | 0.03 | 4 | 0.03 | 4 | 0.03 | 4 | 0.03 | 4 | 0.03 | 3 | 0.0225 | 3 | 0.0225 | 4 | 0.03 | 4 | 0.03 | 4 |
| Ease of Maintenance (-) | 0.1 | 5 | 0.075 | 4 | 0.06 | 4 | 0.06 | 4 | 0.06 | 4 | 0.06 | 3 | 0.045 | 3 | 0.045 | 4 | 0.06 | 4 | 0.06 | 4 |
| Adjustability (+) | 0.2 | 4 | 0.12 | 4 | 0.12 | 4 | 0.12 | 4 | 0.12 | 4 | 0.12 | 3 | 0.09 | 2 | 0.06 | 3 | 0.09 | 3 | 0.09 | 3 |
| Breathability (+) | 0.15 | 3 | 0.0675 | 5 | 0.1125 | 4 | 0.09 | 4 | 0.09 | 4 | 0.09 | 2 | 0.045 | 2 | 0.045 | 3 | 0.0675 | 3 | 0.0675 | 3 |
| Non-irritating to skin (+) | 0.15 | 3 | 0.0675 | 4 | 0.09 | 4 | 0.09 | 4 | 0.09 | 4 | 0.09 | 2 | 0.045 | 3 | 0.0675 | 4 | 0.09 | 4 | 0.09 | 4 |
| Aesthetics (+) | 0.15 | 1 | 0.0225 | 3 | 0.0675 | 3 | 0.0675 | 3 | 0.0675 | 3 | 0.0675 | 2 | 0.045 | 1 | 0.0225 | 2 | 0.045 | 2 | 0.045 | 2 |
| Sub-Total: | 1 | | 0.5025 | | 0.6 | | 0.5475 | | 0.5475 | | 0.3525 | | 0.3225 | | 0.4425 | | 0.4425 | | 0.4725 | |
| Reliability | | | | | | | | | | | | | | | | | | | | |
| Shock Resistant (+) | 0.15 | 3 | 0.18 | 2 | 0.12 | 4 | 0.24 | 4 | 0.24 | 4 | 0.24 | 4 | 0.24 | 2 | 0.12 | 3 | 0.18 | 4 | 0.24 | 4 |
| Washable (+) | 0.1 | 5 | 0.075 | 4 | 0.06 | 4 | 0.06 | 4 | 0.06 | 4 | 0.06 | 3 | 0.045 | 2 | 0.03 | 2 | 0.03 | 4 | 0.06 | 4 |
| Sweat and Performance | 0.2 | 3 | 0.09 | 4 | 0.12 | 4 | 0.12 | 4 | 0.12 | 4 | 0.12 | 3 | 0.09 | 2 | 0.06 | 2 | 0.06 | 4 | 0.12 | 4 |
| Fatigue Resistance (+) | 0.3 | 3 | 0.135 | 4 | 0.18 | 4 | 0.18 | 4 | 0.18 | 4 | 0.18 | 4 | 0.18 | 2 | 0.09 | 3 | 0.135 | 4 | 0.18 | 4 |
| Sub-Total: | 1 | | 0.48 | | 0.48 | | 0.6 | | 0.6 | | 0.555 | | 0.3 | | 0.405 | | 0.6 | | 0.6 | |
| Cost | | | | | | | | | | | | | | | | | | | | |
| Materials (-) | 0.05 | 3 | 0.06 | 3 | 0.06 | 3 | 0.06 | 3 | 0.06 | 3 | 0.06 | 2 | 0.04 | 3 | 0.06 | 3 | 0.06 | 3 | 0.06 | 3 |
| Manufacture (-) | 0.4 | 3 | 0.06 | 4 | 0.08 | 4 | 0.08 | 4 | 0.08 | 4 | 0.08 | 4 | 0.08 | 4 | 0.08 | 4 | 0.08 | 4 | 0.08 | 4 |
| Maintenance costs (-) | 0.2 | 4 | 0.04 | 3 | 0.03 | 3 | 0.03 | 3 | 0.03 | 3 | 0.03 | 3 | 0.03 | 3 | 0.03 | 3 | 0.03 | 3 | 0.03 | 3 |
| Sub-Total: | 1 | | 0.16 | | 0.17 | | 0.17 | | 0.17 | | 0.15 | | 0.17 | | 0.13 | | 0.17 | | 0.17 | |
| Production | | | | | | | | | | | | | | | | | | | | |
| Ease of Manufacture (+) | 0.15 | 3 | 0.225 | 3 | 0.225 | 3 | 0.225 | 3 | 0.225 | 3 | 0.225 | 3 | 0.225 | 3 | 0.225 | 2 | 0.15 | 3 | 0.225 | 3 |
| Ease of Assembly (+) | 0.5 | 3 | 0.225 | 4 | 0.3 | 4 | 0.3 | 4 | 0.3 | 4 | 0.3 | 3 | 0.225 | 3 | 0.225 | 3 | 0.225 | 3 | 0.225 | 3 |
| Sub-Total: | 1 | | 0.45 | | 0.525 | | 0.525 | | 0.525 | | 0.45 | | 0.45 | | 0.375 | | 0.45 | | 0.45 | |
| TOTAL | 1 | | 3.5575 | | 3.4625 | | 3.6025 | | 3.6025 | | 3.005 | | 2.3125 | | 2.6775 | | 3.6625 | | 3.7275 | |

| Arm Interface | | | | | |
|---------------------------------------|-------------|-----------------------|---------------|----------------|---------------|
| | | Conc Cylinders | | Bearing | |
| Criteria | Weight | Score | Wtd. Sc. | Score | Wtd. Sc. |
| Performance | 0.3 | | | | |
| Interface with existing pros/orth | 0.1 | 4 | 0.12 | 4 | 0.12 |
| Effect on Required Work | 0.075 | 4 | 0.09 | 4 | 0.09 |
| Stability (+) | 0.2 | 4 | 0.24 | 3 | 0.18 |
| Range of motion (+) | 0.15 | 3 | 0.135 | 4 | 0.18 |
| Load Distrib. (+) | 0.2 | 3 | 0.18 | 3 | 0.18 |
| Facilitate activities of daily living | 0.075 | 3 | 0.0675 | 3 | 0.0675 |
| Load Capacity (+) | 0.2 | 4 | 0.24 | 3 | 0.18 |
| Sub-Total: | 1 | | 1.0725 | | 0.9975 |
| Safety | 0.2 | | | | |
| No sharp edges (-) | 0.5 | 5 | 0.5 | 3 | 0.3 |
| Minimize pinch points (-) | 0.5 | 3 | 0.3 | 4 | 0.4 |
| Sub-Total: | 1 | | 0.8 | | 0.7 |
| Use Friendliness | 0.15 | | | | |
| Don/Doff Ease (+) | 0.2 | 3 | 0.09 | 3 | 0.09 |
| Ease of storage | 0.05 | 5 | 0.0375 | 4 | 0.03 |
| Ease of Maintenance (-) | 0.1 | 4 | 0.06 | 5 | 0.075 |
| Adjustability (+) | 0.2 | 3 | 0.09 | 4 | 0.12 |
| Breathability (+) | 0.15 | 3 | 0.0675 | 5 | 0.1125 |
| Non-irritating to skin (+) | 0.15 | 3 | 0.0675 | 3 | 0.0675 |
| Aesthetics (+) | 0.15 | 4 | 0.09 | 4 | 0.09 |
| Sub-Total: | 1 | | 0.5025 | | 0.585 |
| Reliability | 0.15 | | | | |
| Shock Resistant (+) | 0.4 | 4 | 0.24 | 3 | 0.18 |
| Washable (+) | 0.1 | 2 | 0.03 | 3 | 0.045 |
| Sweat and Performance | 0.2 | 2 | 0.06 | 3 | 0.09 |
| Fatigue Resistance (+) | 0.3 | 4 | 0.18 | 3 | 0.135 |
| Sub-Total: | 1 | | 0.51 | | 0.45 |
| Cost | 0.05 | | | | |
| Materials (-) | 0.4 | 4 | 0.08 | 4 | 0.08 |
| Manufacture (-) | 0.4 | 3 | 0.06 | 4 | 0.08 |
| Maintenance costs (-) | 0.2 | 3 | 0.03 | 3 | 0.03 |
| Sub-Total: | 1 | | 0.17 | | 0.19 |
| Production | 0.15 | | | | |
| Ease of Manufacture (+) | 0.5 | 4 | 0.3 | 5 | 0.375 |
| Ease of Assembly (+) | 0.5 | 3 | 0.225 | 5 | 0.375 |
| Sub-Total: | 1 | | 0.525 | | 0.75 |
| TOTAL | 1 | | 3.58 | | 3.6725 |

Dominguez Completed Selection Matrices

| Shoulder Joint | | | | | | | | | | | | | |
|---|--------|--------|----------|-----------|----------|-----------------|----------|-------------|----------|-------------|----------|-----------------|----------|
| Criteria | Weight | Gimbal | | L-Bracket | | Ferromag Sheath | | Locking Bar | | Locking Cam | | Modified Gimbal | |
| | | Score | Wtd. Sc. | Score | Wtd. Sc. | Score | Wtd. Sc. | Score | Wtd. Sc. | Score | Wtd. Sc. | Score | Wtd. Sc. |
| Performance | 0.3 | | 0.72 | | 0.975 | | 0.6375 | | 1.2075 | | 1.305 | | |
| Interface with existing pros/orth + frame | 0.1 | 4 | 0.4 | 3 | 0.3 | 4 | 0.4 | 5 | 0.5 | 4 | 0.4 | 4 | 1.6 |
| Effect on Required Work | 0.075 | 4 | 0.3 | 3 | 0.225 | 2 | 0.15 | 3 | 0.225 | 4 | 0.3 | 4 | 1.2 |
| Stability (+) | 0.2 | 1 | 0.2 | 4 | 0.8 | 2 | 0.4 | 5 | 1 | 5 | 1 | 5 | 1 |
| Range of motion (+) | 0.15 | 4 | 0.6 | 3 | 0.45 | 2 | 0.3 | 4 | 0.6 | 5 | 0.75 | 5 | 3 |
| Load Distrib. (+) | 0.2 | 2 | 0.4 | 3 | 0.6 | 2 | 0.4 | 4 | 0.8 | 4 | 0.8 | 4 | 1.6 |
| Facilitate activities of daily living | 0.075 | 4 | 0.3 | 1 | 0.075 | 1 | 0.075 | 4 | 0.3 | 4 | 0.3 | 4 | 1.2 |
| Load Capacity (+) | 0.2 | 1 | 0.2 | 4 | 0.8 | 2 | 0.4 | 3 | 0.6 | 4 | 0.8 | 4 | 0.8 |
| Sub-Total: | 1 | | 2.4 | | 3.25 | | 2.125 | | 4.025 | | 4.35 | | 4.4 |
| Safety | 0.2 | | 0.6 | | 0.5 | | 0.6 | | 0.7 | | 0.4 | | 2.1 |
| No sharp edges (-) | 0.5 | 3 | 1.5 | 4 | 2 | 4 | 2 | 4 | 2 | 3 | 1.5 | 3 | 4.5 |
| Minimize pinch points (-) | 0.5 | 3 | 1.5 | 1 | 0.5 | 2 | 1 | 3 | 1.5 | 1 | 0.5 | 4 | 6 |
| Sub-Total: | 1 | | 3 | | 2.5 | | 3 | | 3.5 | | 2 | | 3.5 |
| Use Friendliness | 0.15 | | 0.69 | | 0.5325 | | 0.5175 | | 0.555 | | 0.6075 | | 2.5875 |
| Don/DoF Ease (+) | 0.2 | 4 | 0.8 | 5 | 1 | 3 | 0.6 | 4 | 0.8 | 4 | 0.8 | 4 | 3.2 |
| Ease of storage | 0.05 | 5 | 0.25 | 2 | 0.1 | 2 | 0.1 | 3 | 0.15 | 4 | 0.2 | 4 | 1 |
| Ease of Maintenance (-) | 0.1 | 5 | 0.5 | 1 | 0.1 | 3 | 0.3 | 3 | 0.3 | 3 | 0.3 | 3 | 1.5 |
| Adjustability (+) | 0.2 | 4 | 0.8 | 5 | 1 | 4 | 0.8 | 4 | 0.8 | 4 | 0.8 | 4 | 3.2 |
| Breathability (+) | 0.15 | 5 | 0.75 | 3 | 0.45 | 5 | 0.75 | 5 | 0.75 | 5 | 0.75 | 5 | 3.75 |
| Non-irritating to skin (+) | 0.15 | 5 | 0.75 | 3 | 0.45 | 5 | 0.75 | 4 | 0.6 | 5 | 0.75 | 5 | 3.75 |
| Aesthetics (+) | 0.15 | 5 | 0.75 | 3 | 0.45 | 1 | 0.15 | 2 | 0.3 | 3 | 0.45 | 3 | 2.25 |
| Sub-Total: | 1 | | 4.6 | | 3.55 | | 3.45 | | 3.7 | | 4.05 | | 3.75 |
| Reliability | 0.15 | | 0.54 | | 0.315 | | 0.585 | | 0.63 | | 0.585 | | 1.944 |
| Shock Resistant (+) | 0.4 | 3 | 1.2 | 1 | 0.4 | 4 | 1.6 | 5 | 2 | 4 | 1.6 | 4 | 4.8 |
| Washable (+) | 0.1 | 5 | 0.5 | 1 | 0.1 | 4 | 0.4 | 3 | 0.3 | 4 | 0.4 | 4 | 2 |
| Sweat and Performance | 0.2 | 5 | 1 | 2 | 0.4 | 5 | 1 | 5 | 1 | 5 | 1 | 5 | 5 |
| Fatigue Resistance (+) | 0.3 | 3 | 0.9 | 4 | 1.2 | 3 | 0.9 | 3 | 0.9 | 3 | 0.9 | 3 | 2.7 |
| Sub-Total: | 1 | | 3.6 | | 2.1 | | 3.9 | | 4.2 | | 3.9 | | 3.6 |
| Cost | 0.05 | | 0.25 | | 0.07 | | 0.18 | | 0.13 | | 0.21 | | 5.25 |
| Materials (-) | 0.4 | 5 | 2 | 1 | 0.4 | 4 | 1.6 | 3 | 1.2 | 4 | 1.6 | 4 | 8 |
| Manufacture (-) | 0.4 | 5 | 2 | 2 | 0.8 | 3 | 1.2 | 2 | 0.8 | 4 | 1.6 | 4 | 8 |
| Maintenance costs (-) | 0.2 | 5 | 1 | 1 | 0.2 | 4 | 0.8 | 3 | 0.6 | 5 | 1 | 5 | 5 |
| Sub-Total: | 1 | | 5 | | 1.4 | | 3.6 | | 2.6 | | 4.2 | | 21 |
| Production | 0.15 | | 0.75 | | 0.3 | | 0.525 | | 0.3 | | 0.525 | | 1.875 |
| Ease of Manufacture (+) | 0.5 | 5 | 2.5 | 1 | 0.5 | 3 | 1.5 | 2 | 1 | 3 | 1.5 | 3 | 7.5 |
| Ease of Assembly (+) | 0.5 | 5 | 2.5 | 3 | 1.5 | 4 | 2 | 2 | 1 | 4 | 2 | 4 | 10 |
| Sub-Total: | 1 | | 5 | | 2 | | 3.5 | | 2 | | 3.5 | | 2.5 |
| TOTAL | 1 | | 3.55 | | 2.6925 | | 3.045 | | 3.5225 | | 3.6325 | | 3.67 |

Harness

| Criteria | Weight | Backpack | | Shoulder Plate | | Double-Nine | | Double Ampit | | Doubit X-Yoke | | Vest | | Corset | | Arm w/ Torso | | Harness w/ Torso | |
|---------------------------------------|--------|----------|----------|----------------|----------|-------------|----------|--------------|----------|---------------|----------|-------|----------|--------|----------|--------------|----------|------------------|----------|
| | | Score | Wtd. Sc. | Score | Wtd. Sc. | Score | Wtd. Sc. | Score | Wtd. Sc. | Score | Wtd. Sc. | Score | Wtd. Sc. | Score | Wtd. Sc. | Score | Wtd. Sc. | Score | Wtd. Sc. |
| Performance | 0.3 | | | | | | | | | | | | | | | | | | |
| Interface with shoulder joint | 0.1 | 3 | 0.3 | 5 | 0.5 | 5 | 0.5 | 5 | 0.5 | 5 | 0.5 | 4 | 0.4 | 2 | 0.2 | 5 | 0.5 | 5 | 0.5 |
| Effect on Required Work | 0.075 | 3 | 0.225 | 5 | 0.375 | 5 | 0.375 | 5 | 0.375 | 4 | 0.3 | 4 | 0.3 | 3 | 0.225 | 5 | 0.375 | 4 | 0.3 |
| Stability (+) | 0.2 | 4 | 0.8 | 2 | 0.4 | 2 | 0.4 | 4 | 0.8 | 5 | 1 | 3 | 0.6 | 3 | 0.6 | 5 | 1 | 5 | 1 |
| Range of motion (+) | 0.15 | 1 | 0.15 | 4 | 0.6 | 4 | 0.6 | 5 | 0.75 | 4 | 0.6 | 3 | 0.45 | 3 | 0.45 | 5 | 0.75 | 5 | 0.75 |
| Load Distrib. (+) | 0.2 | 5 | 1 | 2 | 0.4 | 2 | 0.4 | 2 | 0.4 | 4 | 0.8 | 5 | 1 | 4 | 0.8 | 2 | 0.4 | 4 | 0.8 |
| Facilitate activities of daily living | 0.075 | 2 | 0.15 | 2 | 0.15 | 2 | 0.15 | 4 | 0.3 | 3 | 0.225 | 4 | 0.3 | 3 | 0.225 | 4 | 0.3 | 4 | 0.3 |
| Load Capacity (+) | 0.2 | 5 | 1 | 2 | 0.4 | 2 | 0.4 | 2 | 0.4 | 4 | 0.8 | 4 | 0.8 | 3 | 0.6 | 2 | 0.4 | 3 | 0.6 |
| Sub-Total: | 1 | | 3.625 | | 2.825 | | 2.825 | | 3.625 | | 4.225 | | 3.85 | | 3.1 | | 3.725 | | 4.25 |
| Safety | 0.2 | | | | | | | | | | | | | | | | | | |
| No sharp edges (-) | 0.5 | 4 | 2 | 2 | 1 | 2 | 1 | 2 | 1 | 2 | 1 | 3 | 1.5 | 4 | 2 | 2 | 1 | 3 | 1.5 |
| Minimize pinch points (-) | 0.5 | 4 | 2 | 3 | 1.5 | 3 | 1.5 | 2 | 1 | 2 | 1 | 3 | 1.5 | 3 | 1.5 | 2 | 1 | 2 | 1 |
| Sub-Total: | 1 | | 4 | | 2.5 | | 2.5 | | 2 | | 2 | | 3 | | 3.5 | | 2 | | 2.5 |
| Use Friendliness | 0.15 | | | | | | | | | | | | | | | | | | |
| Don/Doff Ease (+) | 0.2 | 5 | 1 | 2 | 0.4 | 3 | 0.6 | 4 | 0.8 | 2 | 0.4 | 5 | 1 | 4 | 0.8 | 2 | 0.4 | 4 | 0.8 |
| Ease of storage | 0.05 | 1 | 0.05 | 5 | 0.25 | 5 | 0.25 | 5 | 0.25 | 4 | 0.2 | 2 | 0.1 | 2 | 0.1 | 5 | 0.25 | 4 | 0.2 |
| Ease of Maintenance (-) | 0.1 | 4 | 0.4 | 4 | 0.4 | 4 | 0.4 | 4 | 0.4 | 4 | 0.4 | 5 | 0.5 | 3 | 0.3 | 4 | 0.4 | 4 | 0.4 |
| Adjustability (+) | 0.2 | 2 | 0.4 | 5 | 1 | 5 | 1 | 5 | 1 | 5 | 1 | 3 | 0.6 | 2 | 0.6 | 2 | 1 | 4 | 0.8 |
| Breathability (+) | 0.15 | 2 | 0.3 | 5 | 0.75 | 5 | 0.75 | 5 | 0.75 | 4 | 0.6 | 1 | 0.15 | 2 | 0.3 | 5 | 0.75 | 4 | 0.6 |
| Non-irritating to skin (+) | 0.15 | 3 | 0.45 | 4 | 0.6 | 2 | 0.3 | 1 | 0.15 | 3 | 0.45 | 2 | 0.3 | 2 | 0.3 | 1 | 0.15 | 2 | 0.3 |
| Aesthetics (+) | 0.15 | 3 | 0.45 | 5 | 0.75 | 5 | 0.75 | 5 | 0.75 | 4 | 0.6 | 2 | 0.3 | 2 | 0.3 | 5 | 0.75 | 4 | 0.6 |
| Sub-Total: | 1 | | 3.05 | | 4.15 | | 4.05 | | 4.1 | | 3.65 | | 2.95 | | 2.5 | | 3.7 | | 3.7 |
| Reliability | 0.15 | | | | | | | | | | | | | | | | | | |
| Shock Resistant (+) | 0.4 | 3 | 1.2 | 5 | 2 | 5 | 2 | 5 | 2 | 4 | 1.6 | 3 | 1.2 | 3 | 1.2 | 5 | 2 | 5 | 2 |
| Washable (+) | 0.1 | 4 | 0.4 | 5 | 0.5 | 5 | 0.5 | 5 | 0.5 | 5 | 0.5 | 3 | 0.3 | 3 | 0.3 | 5 | 0.5 | 5 | 0.5 |
| Sweat and Performance | 0.2 | 4 | 0.8 | 4 | 0.8 | 4 | 0.8 | 3 | 0.6 | 4 | 0.8 | 4 | 0.8 | 3 | 0.6 | 3 | 0.6 | 3 | 0.6 |
| Fatigue Resistance (+) | 0.3 | 4 | 1.2 | 5 | 1.5 | 5 | 1.5 | 5 | 1.5 | 4 | 1.2 | 4 | 1.2 | 4 | 1.2 | 5 | 1.5 | 5 | 1.5 |
| Sub-Total: | 1 | | 3.6 | | 4.8 | | 4.8 | | 4.6 | | 4.1 | | 3.5 | | 3.3 | | 4.6 | | 4.6 |
| Cost | 0.05 | | | | | | | | | | | | | | | | | | |
| Materials (-) | 0.4 | 3 | 1.2 | 5 | 2 | 4 | 1.6 | 5 | 2 | 4 | 1.6 | 3 | 1.2 | 3 | 1.2 | 4 | 1.6 | 5 | 2 |
| Manufacture (-) | 0.4 | 2 | 0.8 | 5 | 2 | 5 | 2 | 5 | 2 | 4 | 1.6 | 4 | 1.6 | 4 | 1.6 | 5 | 2 | 5 | 2 |
| Maintenance costs (-) | 0.2 | 3 | 0.6 | 3 | 0.6 | 3 | 0.6 | 3 | 0.6 | 3 | 0.6 | 3 | 0.6 | 3 | 0.6 | 3 | 0.6 | 4 | 0.8 |
| Sub-Total: | 1 | | 2.6 | | 4.6 | | 4.2 | | 4.6 | | 3.8 | | 3.4 | | 3.4 | | 4.2 | | 4.8 |
| Production | 0.15 | | | | | | | | | | | | | | | | | | |
| Ease of Manufacture (+) | 0.5 | 3 | 1.5 | 5 | 2.5 | 5 | 2.5 | 5 | 2.5 | 4 | 2 | 3 | 1.5 | 4 | 2 | 5 | 2.5 | 4 | 2 |
| Ease of Assembly (+) | 0.5 | 5 | 2.5 | 5 | 2.5 | 5 | 2.5 | 5 | 2.5 | 5 | 2.5 | 4 | 2 | 5 | 2.5 | 5 | 2.5 | 5 | 2.5 |
| Sub-Total: | 1 | | 4 | | 5 | | 5 | | 5 | | 4.5 | | 3.5 | | 4.5 | | 5 | | 4.5 |
| TOTAL | 1 | | 3.615 | | 3.67 | | 3.635 | | 3.7425 | | 3.695 | | 3.4175 | | 3.345 | | 3.7225 | | 3.935 |

| Arm Interface | | | | | |
|---------------------------------------|-------------|-----------------------|---------------|----------------|--------------|
| | | Conc Cylinders | | Bearing | |
| Criteria | Weight | Score | Wtd. Sc. | Score | Wtd. Sc. |
| Performance | 0.3 | | 1.2075 | | 1.305 |
| Interface with existing pros/orth | 0.1 | 4 | 0.4 | 4 | 0.4 |
| Effect on Required Work | 0.075 | 4 | 0.3 | 3 | 0.225 |
| Stability (+) | 0.2 | 4 | 0.8 | 5 | 1 |
| Range of motion (+) | 0.15 | 5 | 0.75 | 5 | 0.75 |
| Load Distrib. (+) | 0.2 | 3 | 0.6 | 4 | 0.8 |
| Facilitate activities of daily living | 0.075 | 5 | 0.375 | 5 | 0.375 |
| Load Capacity (+) | 0.2 | 4 | 0.8 | 4 | 0.8 |
| Sub-Total: | 1 | | 4.025 | | 4.35 |
| Safety | 0.2 | | 0.7 | | 0.8 |
| No sharp edges (-) | 0.5 | 4 | 2 | 4 | 2 |
| Minimize pinch points (-) | 0.5 | 3 | 1.5 | 4 | 2 |
| Sub-Total: | 1 | | 3.5 | | 4 |
| Use Friendliness | 0.15 | | 0.4725 | | 0.555 |
| Don/Doff Ease (+) | 0.2 | 3 | 0.6 | 4 | 0.8 |
| Ease of storage | 0.05 | 3 | 0.15 | 4 | 0.2 |
| Ease of Maintainence (-) | 0.1 | 4 | 0.4 | 4 | 0.4 |
| Adjustability (+) | 0.2 | 4 | 0.8 | 4 | 0.8 |
| Breathability (+) | 0.15 | 3 | 0.45 | 3 | 0.45 |
| Non-irritating to skin (+) | 0.15 | 3 | 0.45 | 4 | 0.6 |
| Aesthetics (+) | 0.15 | 2 | 0.3 | 3 | 0.45 |
| Sub-Total: | 1 | | 3.15 | | 3.7 |
| Reliability | 0.15 | | 0.6 | | 0.51 |
| Shock Resistant (+) | 0.4 | 4 | 1.6 | 4 | 1.6 |
| Washable (+) | 0.1 | 3 | 0.3 | 2 | 0.2 |
| Sweat and Performance | 0.2 | 3 | 0.6 | 2 | 0.4 |
| Fatigue Resistance (+) | 0.3 | 5 | 1.5 | 4 | 1.2 |
| Sub-Total: | 1 | | 4 | | 3.4 |
| Cost | 0.05 | | 0.17 | | 0.15 |
| Materials (-) | 0.4 | 4 | 1.6 | 3 | 1.2 |
| Manufacture (-) | 0.4 | 3 | 1.2 | 3 | 1.2 |
| Maintenance costs (-) | 0.2 | 3 | 0.6 | 3 | 0.6 |
| Sub-Total: | 1 | | 3.4 | | 3 |
| Production | 0.15 | | 0.375 | | 0.3 |
| Ease of Manufacture (+) | 0.5 | 2 | 1 | 2 | 1 |
| Ease of Assembly (+) | 0.5 | 3 | 1.5 | 2 | 1 |
| Sub-Total: | 1 | | 2.5 | | 2 |
| TOTAL | 1 | | 3.525 | | 3.62 |

Morin Completed Selection Matrices

| Shoulder Joint | | | | | | | | | | | | | |
|---------------------------------------|-------------|-------|--------------|-----------|-----------------|-------------|---------------|-----------------|---------------|----------|---------------|----------|---------------|
| Criteria | Weight | Score | Gimbal | L-Bracket | Ferromag Sheath | Locking Bar | Locking Cam | Modified Gimbal | Score | Wtd. Sc. | Score | Wtd. Sc. | |
| Performance | 0.3 | | | | | | | | | | | | |
| Interface with existing prosth | 0.1 | 5 | 0.15 | 5 | 0.15 | 4 | 0.12 | 3 | 0.09 | 4 | 0.12 | 4 | 0.12 |
| Effect on Required Work | 0.075 | 5 | 0.125 | 5 | 0.125 | 4 | 0.09 | 3 | 0.0675 | 4 | 0.09 | 4 | 0.09 |
| Stability (+) | 0.2 | 4 | 0.24 | 4 | 0.24 | 4 | 0.24 | 3 | 0.18 | 4 | 0.24 | 4 | 0.24 |
| Range of motion (+) | 0.15 | 4 | 0.18 | 5 | 0.225 | 2 | 0.09 | 4 | 0.18 | 4 | 0.18 | 5 | 0.225 |
| Load Distrib. (+) | 0.2 | 4 | 0.24 | 4 | 0.24 | 4 | 0.24 | 4 | 0.24 | 4 | 0.24 | 4 | 0.24 |
| Facilitate activities of daily living | 0.075 | 5 | 0.125 | 5 | 0.125 | 3 | 0.0675 | 5 | 0.125 | 3 | 0.0675 | 3 | 0.0675 |
| Load Capacity (+) | 0.2 | 4 | 0.24 | 5 | 0.3 | 3 | 0.18 | 4 | 0.24 | 3 | 0.18 | 4 | 0.24 |
| Sub-Total: | 1 | | 1.275 | | 1.38 | | 1.05 | | 1.0875 | | 1.05 | | 1.2225 |
| Safety | 0.2 | | | | | | | | | | | | |
| No sharp edges (-) | 0.5 | 5 | 0.5 | 5 | 0.5 | 5 | 0.5 | 5 | 0.5 | 5 | 0.5 | 5 | 0.5 |
| Minimize pinch points (-) | 0.5 | 3 | 0.3 | 4 | 0.4 | 4 | 0.4 | 4 | 0.4 | 4 | 0.4 | 3 | 0.3 |
| Sub-Total: | 1 | | 0.8 | | 0.9 | | 0.9 | | 0.7 | | 0.9 | | 0.8 |
| Use Friendliness | 0.15 | | | | | | | | | | | | |
| Don/Doff Ease (+) | 0.2 | 5 | 0.15 | 4 | 0.12 | 4 | 0.12 | 5 | 0.15 | 4 | 0.12 | 4 | 0.12 |
| Ease of storage | 0.05 | 5 | 0.0375 | 5 | 0.0375 | 4 | 0.03 | 5 | 0.0375 | 4 | 0.03 | 4 | 0.03 |
| Ease of Maintenance (-) | 0.1 | 5 | 0.075 | 5 | 0.075 | 3 | 0.045 | 5 | 0.075 | 3 | 0.045 | 3 | 0.045 |
| Adjustability (+) | 0.2 | 3 | 0.09 | 3 | 0.09 | 3 | 0.09 | 3 | 0.09 | 3 | 0.09 | 3 | 0.09 |
| Breathability (+) | 0.15 | 5 | 0.125 | 5 | 0.125 | 3 | 0.0675 | 5 | 0.125 | 3 | 0.0675 | 3 | 0.0675 |
| Non-irritating to skin (+) | 0.15 | 5 | 0.125 | 5 | 0.125 | 5 | 0.125 | 5 | 0.125 | 5 | 0.125 | 5 | 0.125 |
| Aesthetics (+) | 0.15 | 3 | 0.0675 | 2 | 0.045 | 3 | 0.0675 | 2 | 0.045 | 3 | 0.0675 | 3 | 0.0675 |
| Sub-Total: | 1 | | 0.645 | | 0.5925 | | 0.6225 | | 0.5325 | | 0.6225 | | 0.5325 |
| Reliability | 0.15 | | | | | | | | | | | | |
| Shock Resistant (+) | 0.4 | 4 | 0.24 | 4 | 0.24 | 3 | 0.18 | 3 | 0.18 | 3 | 0.18 | 3 | 0.18 |
| Washable (+) | 0.1 | 2 | 0.03 | 2 | 0.03 | 2 | 0.03 | 2 | 0.03 | 2 | 0.03 | 2 | 0.03 |
| Sweat and Performance | 0.2 | 3 | 0.09 | 3 | 0.09 | 3 | 0.09 | 3 | 0.09 | 3 | 0.09 | 4 | 0.12 |
| Fatigue Resistance (+) | 0.3 | 4 | 0.18 | 4 | 0.18 | 3 | 0.135 | 4 | 0.18 | 3 | 0.135 | 4 | 0.18 |
| Sub-Total: | 1 | | 0.54 | | 0.54 | | 0.435 | | 0.48 | | 0.435 | | 0.51 |
| Cost | 0.05 | | | | | | | | | | | | |
| Materials (-) | 0.4 | 3 | 0.06 | 3 | 0.06 | 3 | 0.06 | 3 | 0.06 | 3 | 0.06 | 3 | 0.06 |
| Manufacture (-) | 0.4 | 3 | 0.06 | 3 | 0.06 | 2 | 0.04 | 2 | 0.04 | 2 | 0.04 | 5 | 0.1 |
| Maintenance costs (-) | 0.2 | 5 | 0.05 | 5 | 0.05 | 3 | 0.03 | 5 | 0.05 | 3 | 0.03 | 5 | 0.05 |
| Sub-Total: | 1 | | 0.17 | | 0.17 | | 0.15 | | 0.13 | | 0.15 | | 0.19 |
| Production | 0.15 | | | | | | | | | | | | |
| Ease of Manufacture (+) | 0.5 | 3 | 0.225 | 2 | 0.15 | 3 | 0.225 | 1 | 0.075 | 3 | 0.225 | 4 | 0.3 |
| Ease of Assembly (+) | 0.5 | 4 | 0.3 | 3 | 0.225 | 3 | 0.225 | 1 | 0.075 | 3 | 0.225 | 4 | 0.3 |
| Sub-Total: | 1 | | 0.525 | | 0.375 | | 0.45 | | 0.15 | | 0.45 | | 0.6 |
| TOTAL | 1 | | 3.955 | | 3.9575 | | 3.6075 | | 3.08 | | 3.6075 | | 3.855 |

Harness

| Criteria | Weight | Backpack | | Shoulder Plate | | Double Nine | | Double Armpit | | Doublet X-Yoke | | Vest | | Corset | | Arm w/ Torso | | Harness w/ Torso | |
|---------------------------------------|-------------|----------|---------------|----------------|---------------|-------------|--------------|---------------|---------------|----------------|---------------|-------|---------------|--------|---------------|--------------|---------------|------------------|---------------|
| | | Score | Wtd. Sc. | Score | Wtd. Sc. | Score | Wtd. Sc. | Score | Wtd. Sc. | Score | Wtd. Sc. | Score | Wtd. Sc. | Score | Wtd. Sc. | Score | Wtd. Sc. | Score | Wtd. Sc. |
| Performance | 0.3 | | | | | | | | | | | | | | | | | | |
| Interface with existing pros/orth | 0.1 | 3 | 0.09 | 3 | 0.09 | 3 | 0.09 | 3 | 0.09 | 3 | 0.09 | 3 | 0.09 | 3 | 0.09 | 3 | 0.09 | 3 | 0.09 |
| Effect on Required Work | 0.075 | 3 | 0.0675 | 4 | 0.09 | 3 | 0.0675 | 4 | 0.09 | 3 | 0.0675 | 2 | 0.045 | 2 | 0.045 | 3 | 0.0675 | 3 | 0.0675 |
| Stability (+) | 0.2 | 4 | 0.24 | 3 | 0.18 | 4 | 0.24 | 3 | 0.18 | 5 | 0.3 | 4 | 0.24 | 4 | 0.24 | 4 | 0.24 | 4 | 0.24 |
| Range of motion (+) | 0.15 | 4 | 0.18 | 4 | 0.18 | 3 | 0.135 | 4 | 0.18 | 4 | 0.18 | 3 | 0.135 | 4 | 0.18 | 4 | 0.18 | 5 | 0.225 |
| Load Distrib. (+) | 0.2 | 4 | 0.24 | 3 | 0.18 | 4 | 0.24 | 3 | 0.18 | 5 | 0.3 | 5 | 0.3 | 4 | 0.24 | 4 | 0.24 | 4 | 0.24 |
| Facilitate activities of daily living | 0.075 | 3 | 0.0675 | 3 | 0.0675 | 3 | 0.0675 | 3 | 0.0675 | 3 | 0.0675 | 4 | 0.09 | 4 | 0.09 | 4 | 0.09 | 4 | 0.09 |
| Load Capacity (+) | 0.2 | 3 | 0.18 | 3 | 0.18 | 4 | 0.24 | 3 | 0.18 | 5 | 0.3 | 5 | 0.3 | 4 | 0.24 | 4 | 0.24 | 4 | 0.24 |
| Sub-Total: | 1 | | 1.065 | | 0.9675 | | 1.08 | | 0.9675 | | 1.305 | | 1.26 | | 1.125 | | 1.1475 | | 1.1925 |
| Safety | 0.2 | | | | | | | | | | | | | | | | | | |
| No sharp edges (-) | 0.5 | 5 | 0.5 | 5 | 0.5 | 5 | 0.5 | 5 | 0.5 | 5 | 0.5 | 5 | 0.5 | 5 | 0.5 | 5 | 0.5 | 5 | 0.5 |
| Minimize pinch points (-) | 0.5 | 4 | 0.4 | 4 | 0.4 | 4 | 0.4 | 4 | 0.4 | 4 | 0.4 | 4 | 0.4 | 4 | 0.4 | 4 | 0.4 | 4 | 0.4 |
| Sub-Total: | 1 | | 0.9 | | 0.9 | | 0.9 | | 0.9 | | 0.9 | | 0.9 | | 0.9 | | 0.9 | | 0.9 |
| Use Friendliness | 0.15 | | | | | | | | | | | | | | | | | | |
| Don/Dooff Ease (+) | 0.2 | 4 | 0.12 | 5 | 0.15 | 3 | 0.09 | 4 | 0.12 | 3 | 0.09 | 4 | 0.12 | 3 | 0.09 | 3 | 0.09 | 3 | 0.09 |
| Ease of storage | 0.05 | 3 | 0.0225 | 5 | 0.0375 | 5 | 0.0375 | 5 | 0.0375 | 4 | 0.03 | 3 | 0.0225 | 3 | 0.0225 | 5 | 0.0375 | 5 | 0.0375 |
| Ease of Maintenance (-) | 0.1 | 3 | 0.045 | 5 | 0.075 | 5 | 0.075 | 5 | 0.075 | 4 | 0.06 | 3 | 0.045 | 3 | 0.045 | 5 | 0.075 | 5 | 0.075 |
| Adjustability (+) | 0.2 | 3 | 0.09 | 4 | 0.12 | 5 | 0.15 | 4 | 0.12 | 4 | 0.12 | 3 | 0.09 | 3 | 0.09 | 4 | 0.12 | 4 | 0.12 |
| Breathability (+) | 0.15 | 2 | 0.045 | 5 | 0.1125 | 5 | 0.1125 | 5 | 0.1125 | 4 | 0.09 | 2 | 0.045 | 3 | 0.0675 | 5 | 0.1125 | 5 | 0.1125 |
| Non-irritating to skin (+) | 0.15 | 3 | 0.0675 | 4 | 0.09 | 4 | 0.09 | 4 | 0.09 | 4 | 0.09 | 1 | 0.0225 | 3 | 0.0675 | 4 | 0.09 | 4 | 0.09 |
| Aesthetics (+) | 0.15 | 3 | 0.0675 | 4 | 0.09 | 4 | 0.09 | 4 | 0.09 | 3 | 0.0675 | 3 | 0.0225 | 4 | 0.09 | 4 | 0.09 | 4 | 0.09 |
| Sub-Total: | 1 | | 0.4575 | | 0.675 | | 0.645 | | 0.645 | | 0.5475 | | 0.4125 | | 0.4725 | | 0.615 | | 0.615 |
| Reliability | 0.15 | | | | | | | | | | | | | | | | | | |
| Shock Resistant (+) | 0.4 | 5 | 0.3 | 5 | 0.3 | 5 | 0.3 | 5 | 0.3 | 5 | 0.3 | 5 | 0.3 | 5 | 0.3 | 5 | 0.3 | 5 | 0.3 |
| Washable (+) | 0.1 | 4 | 0.06 | 5 | 0.075 | 5 | 0.075 | 5 | 0.075 | 5 | 0.075 | 3 | 0.045 | 4 | 0.06 | 5 | 0.075 | 5 | 0.075 |
| Sweat and Performance | 0.2 | 3 | 0.09 | 4 | 0.12 | 4 | 0.12 | 4 | 0.12 | 3 | 0.09 | 3 | 0.09 | 3 | 0.09 | 4 | 0.12 | 4 | 0.12 |
| Fatigue Resistance (+) | 0.3 | 4 | 0.18 | 3 | 0.135 | 3 | 0.135 | 3 | 0.135 | 4 | 0.18 | 4 | 0.18 | 4 | 0.18 | 3 | 0.135 | 4 | 0.18 |
| Sub-Total: | 1 | | 0.63 | | 0.63 | | 0.63 | | 0.63 | | 0.645 | | 0.615 | | 0.63 | | 0.63 | | 0.675 |
| Cost | 0.05 | | | | | | | | | | | | | | | | | | |
| Materials (-) | 0.4 | 4 | 0.08 | 5 | 0.1 | 5 | 0.1 | 5 | 0.1 | 5 | 0.1 | 3 | 0.06 | 4 | 0.08 | 5 | 0.1 | 5 | 0.1 |
| Manufacture (-) | 0.4 | 4 | 0.08 | 5 | 0.1 | 5 | 0.1 | 5 | 0.1 | 4 | 0.08 | 3 | 0.06 | 3 | 0.06 | 5 | 0.1 | 5 | 0.1 |
| Maintenance costs (-) | 0.2 | 5 | 0.05 | 5 | 0.05 | 5 | 0.05 | 5 | 0.05 | 4 | 0.04 | 4 | 0.04 | 3 | 0.03 | 5 | 0.05 | 5 | 0.05 |
| Sub-Total: | 1 | | 0.21 | | 0.25 | | 0.25 | | 0.25 | | 0.22 | | 0.16 | | 0.17 | | 0.25 | | 0.25 |
| Production | 0.15 | | | | | | | | | | | | | | | | | | |
| Ease of Manufacture (+) | 0.5 | 4 | 0.1 | 5 | 0.125 | 5 | 0.125 | 5 | 0.125 | 4 | 0.1 | 3 | 0.075 | 3 | 0.075 | 5 | 0.125 | 5 | 0.125 |
| Ease of Assembly (+) | 0.5 | 5 | 0.125 | 5 | 0.125 | 5 | 0.125 | 5 | 0.125 | 5 | 0.125 | 3 | 0.075 | 3 | 0.075 | 5 | 0.125 | 5 | 0.125 |
| Sub-Total: | 1 | | 0.225 | | 0.25 | | 0.25 | | 0.25 | | 0.225 | | 0.15 | | 0.15 | | 0.25 | | 0.25 |
| TOTAL | 1 | | 3.4875 | | 3.6725 | | 3.755 | | 3.6425 | | 3.8425 | | 3.4975 | | 3.4475 | | 3.7925 | | 3.8825 |

| Arm Interface | | | | | |
|---------------------------------------|-------------|-----------------------|---------------|----------------|--------------|
| | | Conc Cylinders | | Bearing | |
| Criteria | Weight | Score | Wtd. Sc. | Score | Wtd. Sc. |
| Performance | 0.3 | | | | |
| Interface with existing pros/orth | 0.1 | 5 | 0.15 | 5 | 0.15 |
| Effect on Required Work | 0.075 | 5 | 0.1125 | 5 | 0.1125 |
| Stability (+) | 0.2 | 4 | 0.24 | 4 | 0.24 |
| Range of motion (+) | 0.15 | 5 | 0.225 | 5 | 0.225 |
| Load Distrib. (+) | 0.2 | 5 | 0.3 | 5 | 0.3 |
| Facilitate activities of daily living | 0.075 | 5 | 0.1125 | 5 | 0.1125 |
| Load Capacity (+) | 0.2 | 4 | 0.24 | 4 | 0.24 |
| Sub-Total: | 1 | | 1.38 | | 1.38 |
| Safety | 0.2 | | | | |
| No sharp edges (-) | 0.5 | 5 | 0.5 | 5 | 0.5 |
| Minimize pinch points (-) | 0.5 | 4 | 0.4 | 4 | 0.4 |
| Sub-Total: | 1 | | 0.9 | | 0.9 |
| Use Friendliness | 0.15 | | | | |
| Don/Doff Ease (+) | 0.2 | 5 | 0.15 | 5 | 0.15 |
| Ease of storage | 0.05 | 5 | 0.0375 | 5 | 0.0375 |
| Ease of Maintenance (-) | 0.1 | 4 | 0.06 | 4 | 0.06 |
| Adjustability (+) | 0.2 | 4 | 0.12 | 5 | 0.15 |
| Breathability (+) | 0.15 | 3 | 0.0675 | 3 | 0.0675 |
| Non-irritating to skin (+) | 0.15 | 4 | 0.09 | 4 | 0.09 |
| Aesthetics (+) | 0.15 | 3 | 0.0675 | 2 | 0.045 |
| Sub-Total: | 1 | | 0.5925 | | 0.6 |
| Reliability | 0.15 | | | | |
| Shock Resistant (+) | 0.4 | 5 | 0.3 | 5 | 0.3 |
| Washable (+) | 0.1 | 3 | 0.045 | 3 | 0.045 |
| Sweat and Performance | 0.2 | 3 | 0.09 | 3 | 0.09 |
| Fatigue Resistance (+) | 0.3 | 4 | 0.18 | 4 | 0.18 |
| Sub-Total: | 1 | | 0.615 | | 0.615 |
| Cost | 0.05 | | | | |
| Materials (-) | 0.4 | 4 | 0.08 | 4 | 0.08 |
| Manufacture (-) | 0.4 | 4 | 0.08 | 4 | 0.08 |
| Maintenance costs (-) | 0.2 | 5 | 0.05 | 5 | 0.05 |
| Sub-Total: | 1 | | 0.21 | | 0.21 |
| Production | 0.15 | | | | |
| Ease of Manufacture (+) | 0.5 | 4 | 0.3 | 4 | 0.3 |
| Ease of Assembly (+) | 0.5 | 5 | 0.375 | 5 | 0.375 |
| Sub-Total: | 1 | | 0.675 | | 0.675 |
| TOTAL | 1 | | 4.3725 | | 4.38 |

Palumbo Completed Selection Matrices

| Shoulder Joint | | | | | | | | | | | |
|--|-------------|---------------|---------------|-----------------|--------------|--------------|-----------------|--------------|---------------|---------------|---------------|
| | Weight | Gimbal | L-Bracket | Ferromag Sheath | Locking Bar | Locking Cam | Modified Gimbal | | | | |
| Criteria | Score | Wtd. Sc. | Score | Wtd. Sc. | Score | Wtd. Sc. | Score | Wtd. Sc. | Score | Wtd. Sc. | Score |
| Performance | 0.3 | | | | | | | | | | |
| Interface with existing parts/ orth | 0.1 | 4 | 0.12 | 3 | 0.09 | 3 | 0.09 | 4 | 0.12 | 4 | 0.12 |
| Effect on Required Work | 0.075 | 4 | 0.09 | 3 | 0.0675 | 2 | 0.045 | 3 | 0.0675 | 4 | 0.09 |
| Stability (+) | 0.2 | 3 | 0.18 | 4 | 0.24 | 4 | 0.12 | 4 | 0.24 | 5 | 0.3 |
| Range of motion (+) | 0.15 | 3 | 0.135 | 4 | 0.18 | 1 | 0.045 | 4 | 0.18 | 4 | 0.18 |
| Load Distrib. (+) | 0.2 | 4 | 0.24 | 3 | 0.18 | 1 | 0.06 | 3 | 0.18 | 3 | 0.18 |
| Facilitates activities of daily living | 0.075 | 3 | 0.0675 | 2 | 0.045 | 2 | 0.045 | 3 | 0.0675 | 3 | 0.0675 |
| Load Capacity (+) | 0.2 | 3 | 0.18 | 3 | 0.18 | 2 | 0.12 | 3 | 0.18 | 3 | 0.18 |
| Sub-Total: | 1 | 1.0125 | 0.9825 | 0.525 | 1.035 | 1.035 | 1.035 | 1.035 | 1.1175 | 1.1175 | 1.1175 |
| Safety | 0.2 | | | | | | | | | | |
| No sharp edges (-) | 0.5 | 4 | 0.4 | 4 | 0.4 | 4 | 0.4 | 4 | 0.4 | 4 | 0.4 |
| Minimize pinch points (-) | 0.5 | 3 | 0.3 | 3 | 0.3 | 3 | 0.3 | 3 | 0.3 | 3 | 0.3 |
| Sub-Total: | 1 | 0.7 | 0.7 | 0.7 | 0.7 | 0.7 | 0.7 | 0.7 | 0.7 | 0.7 | 0.7 |
| Use Friendliness | 0.15 | | | | | | | | | | |
| Don/Dooff Ease (+) | 0.2 | 3 | 0.09 | 4 | 0.12 | 2 | 0.06 | 3 | 0.09 | 3 | 0.09 |
| Ease of storage | 0.05 | 4 | 0.03 | 3 | 0.0225 | 3 | 0.0225 | 4 | 0.03 | 4 | 0.03 |
| Ease of Maintenance (-) | 0.1 | 3 | 0.045 | 2 | 0.03 | 2 | 0.03 | 3 | 0.045 | 3 | 0.045 |
| Adjustability (+) | 0.2 | 5 | 0.15 | 3 | 0.09 | 4 | 0.12 | 2 | 0.06 | 2 | 0.06 |
| Breathability (+) | 0.15 | 3 | 0.0675 | 2 | 0.045 | 3 | 0.0675 | 3 | 0.0675 | 3 | 0.0675 |
| Non-irritating to skin (+) | 0.15 | 5 | 0.1125 | 2 | 0.045 | 3 | 0.0675 | 3 | 0.0675 | 3 | 0.0675 |
| Aesthetics (+) | 0.15 | 2 | 0.045 | 4 | 0.09 | 1 | 0.0225 | 4 | 0.09 | 4 | 0.09 |
| Sub-Total: | 1 | 0.54 | 0.4425 | 0.39 | 0.39 | 0.39 | 0.39 | 0.39 | 0.45 | 0.45 | 0.51 |
| Reliability | 0.15 | | | | | | | | | | |
| Shock Resistant (+) | 0.4 | 3 | 0.18 | 3 | 0.18 | 3 | 0.18 | 4 | 0.24 | 4 | 0.24 |
| Washable (+) | 0.1 | 4 | 0.06 | 2 | 0.03 | 2 | 0.03 | 2 | 0.03 | 2 | 0.03 |
| Sweat and Performance | 0.2 | 4 | 0.12 | 3 | 0.09 | 3 | 0.09 | 2 | 0.06 | 2 | 0.06 |
| Fatigue Resistance (+) | 0.3 | 3 | 0.135 | 2 | 0.09 | 2 | 0.09 | 4 | 0.18 | 4 | 0.18 |
| Sub-Total: | 1 | 0.495 | 0.39 | 0.39 | 0.39 | 0.39 | 0.39 | 0.39 | 0.51 | 0.51 | 0.51 |
| Cost | 0.05 | | | | | | | | | | |
| Materials (-) | 0.4 | 4 | 0.08 | 2 | 0.04 | 4 | 0.08 | 4 | 0.08 | 4 | 0.08 |
| Manufacture (-) | 0.4 | 4 | 0.08 | 2 | 0.04 | 3 | 0.06 | 3 | 0.06 | 3 | 0.06 |
| Maintenance costs (-) | 0.2 | 4 | 0.04 | 2 | 0.02 | 2 | 0.02 | 3 | 0.03 | 3 | 0.03 |
| Sub-Total: | 1 | 0.2 | 0.1 | 0.1 | 0.1 | 0.1 | 0.1 | 0.1 | 0.1 | 0.1 | 0.21 |
| Production | 0.15 | | | | | | | | | | |
| Ease of Manufacture (+) | 0.5 | 3 | 0.075 | 3 | 0.075 | 3 | 0.075 | 3 | 0.075 | 3 | 0.075 |
| Ease of Assembly (+) | 0.5 | 2 | 0.05 | 2 | 0.05 | 2 | 0.05 | 4 | 0.1 | 4 | 0.1 |
| Sub-Total: | 1 | 0.125 | 0.125 | 0.125 | 0.125 | 0.125 | 0.125 | 0.125 | 0.175 | 0.175 | 0.175 |
| TOTAL | 1 | 3.0725 | 2.74 | 2.29 | 3.04 | 3.04 | 3.04 | 3.04 | 3.2225 | 3.2225 | 3.2225 |

Shoulder/Back Mount

| Criteria | Weight | Backpack | | Shoulder Plate | | Double-Nine | | Double Ampitt | | Doubt X-Yoke | | Vest | | Corset | | Arm w/ Torso | | Harness w/ Torso | |
|---------------------------------------|--------|----------|----------|----------------|----------|-------------|----------|---------------|----------|--------------|----------|--------|----------|--------|----------|--------------|----------|------------------|----------|
| | | Score | Wtd. Sc. | Score | Wtd. Sc. | Score | Wtd. Sc. | Score | Wtd. Sc. | Score | Wtd. Sc. | Score | Wtd. Sc. | Score | Wtd. Sc. | Score | Wtd. Sc. | Score | Wtd. Sc. |
| Performance | | | | | | | | | | | | | | | | | | | |
| Interface | 0.3 | | | | | | | | | | | | | | | | | | |
| Effect on Required Work | 0.1 | 3 | 0.09 | 3 | 0.09 | 2 | 0.06 | 4 | 0.12 | 4 | 0.12 | 3 | 0.09 | 2 | 0.06 | 4 | 0.12 | 4 | 0.12 |
| Stability (+) | 0.075 | 4 | 0.09 | 4 | 0.09 | 4 | 0.09 | 5 | 0.1125 | 2 | 0.045 | 4 | 0.09 | 3 | 0.0675 | 5 | 0.1125 | 5 | 0.1125 |
| Range of motion (+) | 0.2 | 3 | 0.18 | 2 | 0.12 | 4 | 0.24 | 4 | 0.24 | 4 | 0.24 | 4 | 0.24 | 3 | 0.18 | 4 | 0.24 | 4 | 0.24 |
| Load Distrib. (+) | 0.15 | 2 | 0.09 | 5 | 0.225 | 3 | 0.135 | 3 | 0.135 | 3 | 0.135 | 3 | 0.135 | 2 | 0.09 | 2 | 0.09 | 3 | 0.135 |
| Facilitate activities of daily living | 0.2 | 4 | 0.24 | 1 | 0.06 | 3 | 0.18 | 4 | 0.24 | 3 | 0.18 | 4 | 0.24 | 2 | 0.12 | 4 | 0.24 | 4 | 0.24 |
| Load Capacity (+) | 0.075 | 2 | 0.045 | 3 | 0.0675 | 3 | 0.0675 | 3 | 0.0675 | 1 | 0.0225 | 2 | 0.045 | 3 | 0.0675 | 4 | 0.09 | 4 | 0.09 |
| Sub-Total | 0.2 | 4 | 0.24 | 2 | 0.12 | 3 | 0.18 | 5 | 0.3 | 4 | 0.24 | 4 | 0.24 | 3 | 0.18 | 5 | 0.3 | 5 | 0.3 |
| Sub-Total | 1 | 0.975 | 0.725 | | | 0.9525 | 1.215 | | | 0.9825 | 1.08 | 0.745 | 1.1925 | | | 1.2375 | | | |
| Safety | | | | | | | | | | | | | | | | | | | |
| No sharp edges (-) | 0.5 | 4 | 0.4 | 5 | 0.5 | 5 | 0.5 | 5 | 0.5 | 3 | 0.3 | 3 | 0.3 | 4 | 0.4 | 4 | 0.4 | 4 | 0.4 |
| Maintains pinch points (-) | 0.5 | 4 | 0.4 | 4 | 0.4 | 4 | 0.4 | 3 | 0.3 | 2 | 0.2 | 3 | 0.3 | 3 | 0.3 | 3 | 0.3 | 3 | 0.3 |
| Sub-Total | 1 | 0.8 | 0.9 | | | 0.9 | 0.8 | | | 0.5 | 0.6 | 0.7 | 0.7 | | | 0.7 | | | |
| Use Friendliness | | | | | | | | | | | | | | | | | | | |
| Don/Doff Ease (+) | 0.15 | | | | | | | | | | | | | | | | | | |
| Ease of storage | 0.2 | 4 | 0.12 | 4 | 0.12 | 3 | 0.09 | 4 | 0.12 | 2 | 0.06 | 4 | 0.12 | 3 | 0.09 | 2 | 0.06 | 4 | 0.12 |
| Ease of Maintenance (-) | 0.05 | 4 | 0.03 | 4 | 0.03 | 5 | 0.0375 | 5 | 0.0375 | 3 | 0.0225 | 4 | 0.03 | 4 | 0.03 | 4 | 0.03 | 4 | 0.03 |
| Adjustability (+) | 0.1 | 3 | 0.045 | 5 | 0.075 | 5 | 0.075 | 4 | 0.06 | 3 | 0.045 | 3 | 0.045 | 2 | 0.03 | 4 | 0.06 | 4 | 0.06 |
| Breathability (+) | 0.2 | 4 | 0.12 | 4 | 0.12 | 4 | 0.12 | 3 | 0.09 | 3 | 0.09 | 2 | 0.06 | 2 | 0.06 | 3 | 0.09 | 3 | 0.09 |
| Non-irritating to skin (+) | 0.15 | 2 | 0.045 | 5 | 0.1125 | 4 | 0.09 | 2 | 0.045 | 3 | 0.0675 | 2 | 0.045 | 2 | 0.045 | 3 | 0.0675 | 5 | 0.1125 |
| Aesthetics (+) | 0.15 | 3 | 0.0675 | 4 | 0.09 | 4 | 0.09 | 4 | 0.09 | 3 | 0.0675 | 2 | 0.045 | 2 | 0.045 | 4 | 0.09 | 5 | 0.1125 |
| Sub-Total | 1 | 0.0225 | 0.615 | | | 0.5925 | 0.51 | | | 0.3975 | 0.345 | 0.3675 | 0.4425 | | | 0.615 | | | |
| Reliability | | | | | | | | | | | | | | | | | | | |
| Shock Resistant (+) | 0.15 | | | | | | | | | | | | | | | | | | |
| Washable (+) | 0.4 | 4 | 0.24 | 3 | 0.18 | 4 | 0.24 | 3 | 0.18 | 5 | 0.3 | 4 | 0.24 | 3 | 0.18 | 4 | 0.24 | 4 | 0.24 |
| Sweat and Performance | 0.1 | 4 | 0.06 | 4 | 0.06 | 3 | 0.045 | 4 | 0.06 | 3 | 0.045 | 3 | 0.045 | 4 | 0.06 | 4 | 0.06 | 4 | 0.06 |
| Fatigue Resistance (+) | 0.2 | 3 | 0.09 | 4 | 0.12 | 3 | 0.09 | 2 | 0.06 | 3 | 0.09 | 4 | 0.12 | 4 | 0.12 | 4 | 0.12 | 5 | 0.15 |
| Sub-Total | 0.3 | 3 | 0.135 | 4 | 0.18 | 4 | 0.18 | 4 | 0.18 | 4 | 0.18 | 3 | 0.135 | 4 | 0.18 | 4 | 0.18 | 4 | 0.18 |
| Sub-Total | 1 | 0.5325 | 0.54 | | | 0.5325 | 0.6 | | | 0.615 | 0.51 | 0.51 | 0.51 | | | 0.6 | | | |
| Cost | | | | | | | | | | | | | | | | | | | |
| Materials (-) | 0.05 | | | | | | | | | | | | | | | | | | |
| Manufacture (-) | 0.4 | 4 | 0.08 | 3 | 0.06 | 5 | 0.1 | 4 | 0.08 | 2 | 0.04 | 3 | 0.06 | 3 | 0.06 | 3 | 0.06 | 3 | 0.06 |
| Maintenance costs (-) | 0.2 | 3 | 0.06 | 4 | 0.08 | 5 | 0.1 | 4 | 0.08 | 3 | 0.06 | 4 | 0.08 | 4 | 0.08 | 4 | 0.08 | 4 | 0.08 |
| Sub-Total | 1 | 0.04 | 0.04 | | | 0.04 | 0.24 | | | 0.03 | 0.03 | 0.03 | 0.03 | | | 0.03 | | | |
| Sub-Total | 1 | 0.18 | 0.17 | | | 0.24 | 0.19 | | | 0.13 | 0.18 | 0.17 | 0.17 | | | 0.17 | | | |
| Production | | | | | | | | | | | | | | | | | | | |
| Ease of Manufacture (+) | 0.15 | | | | | | | | | | | | | | | | | | |
| Ease of Assembly (+) | 0.5 | 4 | 0.3 | 4 | 0.3 | 3 | 0.225 | 3 | 0.225 | 3 | 0.225 | 3 | 0.225 | 3 | 0.225 | 3 | 0.225 | 3 | 0.225 |
| Sub-Total | 1 | 3 | 0.225 | 4 | 0.3 | 4 | 0.3 | 4 | 0.3 | 3 | 0.225 | 3 | 0.225 | 3 | 0.225 | 3 | 0.225 | 3 | 0.225 |
| Sub-Total | 1 | 0.5225 | 0.6 | | | 0.5225 | 0.525 | | | 0.45 | 0.45 | 0.45 | 0.45 | | | 0.45 | | | |
| TOTAL | 1 | 3.485 | 3.5975 | | | 3.765 | 3.84 | | | 3.075 | 3.1875 | 2.97 | 3.555 | | | 3.825 | | | |

| Arm Interface | | | | | |
|---------------------------------------|-------------|----------------|---------------|---------|--------------|
| | | Conc Cylinders | | Bearing | |
| Criteria | Weight | Score | Wtd. Sc. | Score | Wtd. Sc. |
| Performance | 0.3 | | | | |
| Interface with existing pros/orth | 0.1 | 4 | 0.12 | 5 | 0.15 |
| Effect on Required Work | 0.075 | 3 | 0.0675 | 5 | 0.1125 |
| Stability (+) | 0.2 | 4 | 0.24 | 3 | 0.18 |
| Range of motion (+) | 0.15 | 4 | 0.18 | 4 | 0.18 |
| Load Distrib. (+) | 0.2 | 4 | 0.24 | 3 | 0.18 |
| Facilitate activities of daily living | 0.075 | 4 | 0.09 | 3 | 0.0675 |
| Load Capacity (+) | 0.2 | 4 | 0.24 | 3 | 0.18 |
| Sub-Total: | 1 | | 1.1775 | | 1.05 |
| Safety | 0.2 | | | | |
| No sharp edges (-) | 0.5 | 5 | 0.5 | 4 | 0.4 |
| Minimize pinch points (-) | 0.5 | 4 | 0.4 | 4 | 0.4 |
| Sub-Total: | 1 | | 0.9 | | 0.8 |
| Use Friendliness | 0.15 | | | | |
| Don/Doff Ease (+) | 0.2 | 4 | 0.12 | 5 | 0.15 |
| Ease of storage | 0.05 | 4 | 0.03 | 4 | 0.03 |
| Ease of Maintenance (-) | 0.1 | 3 | 0.045 | 4 | 0.06 |
| Adjustability (+) | 0.2 | 3 | 0.09 | 4 | 0.12 |
| Breathability (+) | 0.15 | 4 | 0.09 | 5 | 0.1125 |
| Non-irritating to skin (+) | 0.15 | 3 | 0.0675 | 5 | 0.1125 |
| Aesthetics (+) | 0.15 | 4 | 0.09 | 4 | 0.09 |
| Sub-Total: | 1 | | 0.5325 | | 0.675 |
| Reliability | 0.15 | | | | |
| Shock Resistant (+) | 0.4 | 4 | 0.24 | 4 | 0.24 |
| Washable (+) | 0.1 | 3 | 0.045 | 2 | 0.03 |
| Sweat and Performance | 0.2 | 3 | 0.09 | 3 | 0.09 |
| Fatigue Resistance (+) | 0.3 | 4 | 0.18 | 3 | 0.135 |
| Sub-Total: | 1 | | 0.555 | | 0.495 |
| Cost | 0.05 | | | | |
| Materials (-) | 0.4 | 4 | 0.08 | 3 | 0.06 |
| Manufacture (-) | 0.4 | 3 | 0.06 | 4 | 0.08 |
| Maintenance costs (-) | 0.2 | 3 | 0.03 | 3 | 0.03 |
| Sub-Total: | 1 | | 0.17 | | 0.17 |
| Production | 0.15 | | | | |
| Ease of Manufacture (+) | 0.5 | 4 | 0.3 | 5 | 0.375 |
| Ease of Assembly (+) | 0.5 | 4 | 0.3 | 5 | 0.375 |
| Sub-Total: | 1 | | 0.6 | | 0.75 |
| TOTAL | 1 | | 3.935 | | 3.94 |

