

Smart Intersection System (SIS)

Interactive Qualifying Project (IQP)

Khalid T. Alkusayer
Ibraeim A. Bukhamsin

Adviser:

Professor Tahar El-Korchi

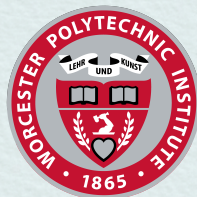

WPI

Table of Contents

ABSTRACT:	4
CHAPTER 1	5
INTRODUCTION AND BACKGROUND:	5
INTRODUCTION:.....	6
BACKGROUND:	8
OBJECTIVE:	16
CHAPTER 2	18
METHODS:	18
SURVEYS:.....	19
INTERVIEWS WITH SELECTED DRIVERS IN THE US:.....	30
INTERVIEWS WITH SPECIALISTS IN THE FIELD OF TRAFFIC AND TRAFFIC CONTROL:	34
SIMULATIONS:	35
CHAPTER 3	44
RESULTS:	44
ONLINE SURVEYS:.....	45
PAPER BASED SURVEYS:	48
SURVEY METHOD:.....	50
SELECTED DRIVERS INTERVIEWING METHOD:	52
SPECIALISTS IN THE FIELD OF TRAFFIC INTERVIEWING METHOD:	55
SIMULATION METHOD:	61
CHAPTER 4	63
DISCUSSION AND CONCLUSION:	63
DISCUSSION OF RESULTS:.....	64
CONCLUSION (OPTIMUM-SYSTEM):.....	67
RECOMMENDED FUTURE RESEARCH:	71
REFERENCES:	72
APPENDIX:	74
APPENDIX (1):	74
<i>(Appendix 1.1)</i>	74
<i>(Appendix 1.2)</i>	75
APPENDIX (2):	76
<i>(Appendix 2.1)</i>	76
<i>(Appendix 2.2)</i>	86
APPENDIX (3):	95
<i>(Appendix 3.1)</i>	95
<i>(Appendix 3.2)</i>	96
<i>(Appendix 3.3)</i>	97
<i>(Appendix 3.4)</i>	98
<i>(Appendix 3.5)</i>	99
<i>(Appendix 3.6)</i>	100
<i>(Appendix 3.7)</i>	101

Abstract:

In this paper the proposed Smart Intersection System (SIS), is critically analyzed using several different methods. These methods include investigation of related literature and research in the field of traffic control as well as surveys, both Internet and paper based, interviews with selected drivers represent the US , interviews with specialists in the field of traffic control, and finally simulations. Together these methods support innovations that have resulted in a well-developed optimum system of traffic control at intersections. These innovations include changes to the physical model design and system functionality. The final design has six columns of red lights and six columns of green arrows, with a diamond yellow timer in between. The system is capable of counting cars at every intersection interactively and is also capable of determining the timing of green arrows accordingly. Some critical details still need to be defined before the system can be applied to real life intersections. Therefore, future research routs are suggested at the end of the paper.

Chapter 1

Introduction and Background:

- Defining problems in current traffic systems.
- Introducing latest technology in traffic control.
- The objectives of the paper.

Introduction:

The current models of traffic control systems at intersections are no longer effective and are unable to cope with today's increasing traffic volumes. The physical model of the traffic light presently in use does not differ in shape and dimensions from the first model introduced in 1912. ⁽¹⁾ Minor changes have been made to traffic signals over the years but include only modifications to enhance clarity and brightness. Changing the shape of the traffic light has not been considered an important factor in the attempt to reduce unnecessary delay at intersections. In addition, the most common control system for traffic signals is the classical fixed time controller. This type of controller is widely thought to be the least efficient in controlling traffic because it does not include a detector for counting or estimating the traffic volume at intersections. Therefore, there is a great need to develop and implement more effective and efficient traffic control systems at intersections in order to reduce traffic delay and accommodate increasing traffic volumes.

The problems of traffic delay and inefficient management of traffic at intersections have many effects on the daily life of a community. According to the 2012 Urban Mobility Report, the amount of CO₂ produced in the US due to traffic congestion was approximately 56 million pounds in both 2010 and 2011. ⁽²⁾ This amount of CO₂ is high when compared to the early 2000s, which saw the production of only 47 million pounds. In addition, the amount of CO₂ produced by the US has remained approximately constant for the last two years. This evidence indicates that the minor improvements to traffic control systems already in place have not reduced the amount of CO₂ produced by traffic congestion. Moreover, since most of the traffic controllers currently in operation do not depend on detectors, the amount of unnecessary delay time caused by these systems is significant. In short, the current system cannot cope with fluctuations in traffic volume. Therefore, delays

and long travel times are both negative byproducts of the current system. Finally, as mentioned earlier, the current model of traffic light has not been updated in order to reduce delay. Therefore, as survey method indicates, drivers in the US tend to be frustrated when stopping at traffic intersections because they do not have the ability to estimate the approximate time before the traffic light changes.

The Smart Intersection System (SIS) has been introduced as a solution to these problems. SIS is a traffic control system that has an improved physical model and directs intersections using interactive traffic data. It is expected that the Smart Intersection System (SIS) will be helpful in reducing delay at intersections. Delays result in unnecessary fuel consumption and increase the amount of CO₂. According to Kotwal, Lee, and Kim from the Department of Engineering Technology, Texas State University, a system similar to SIS has been implemented in five cities in the United States. This system has already reduced delay time by an average of 27.5% in all five cities. ⁽³⁾

Finally, two areas of focus are developed in this report in order to critically analyze the SIS model. These two areas are the physical model of the traffic signal and traffic delay at intersections. Four different methods are used to evaluate the way in which these two areas differ between current system and SIS. These methods are: distributing surveys, interviewing nominated drivers to represent the US, interviewing experts in the field, and simulations. Together, these methods result in an optimal version of SIS that is feasible and can be a positive development in current traffic light system.

Background:

Current progress in the field of traffic system:

In this review, developments that have been applied to the field of traffic system are reviewed and analyzed in detail. Five areas are developed in order to cover all improvements that have been made to the current traffic system. First, historical developments in the physical model of the traffic light are explained and analyzed. Second, developments in control systems are specified and analyzed. Third, developments in detecting devices are recognized and evaluated. Fourth, the role of artificial intelligence in this field is reviewed. Finally, privacy and environmental issues are discussed.

The current physical model of traffic light signals has not been redesigned or reshaped since the traffic light was introduced in 1912. ⁽¹⁾ This model is the familiar three circular lights of red, green, and yellow. However, over the years only minor changes have been made to the current physical model. One major update to traffic signals has been the introduction of LED lights, which are energy efficient. ⁽⁴⁾ However, this change focuses on the problems of brightness and clarity; it does not reduce delays or travel times. Nevertheless, according to Joseph F. Borbone, director of engineers in the traffic control room of the city of Worcester, adding timers to the traffic light for both vehicles and pedestrians is considered to be one of the greatest improvements to the traffic light model, and it has received a lot of positive feedback **(Appendix 2.2)**. This feedback indicates that the design and structure of traffic intersections are key factors in the attempt to improve the flow of vehicles. According to Andrew Chatham, a major software engineer at Google Inc., by designing and constructing intersections and roadways that make it easy for people and motorists to navigate, civil engineers have also made it easier to navigate Google's driverless car. ⁽⁵⁾ From the presented evidence so far, changing the shape of

the physical model, which is a major part of the structure of intersections, is expected to have a large impact on vehicles' flow, delay time, and travel time.

The types of controllers that have been used in traffic lights can be classified in three categories. The first is a local, time based controller, also called a fixed-time controller. It is considered to be the classical design and is the most widely used. This type of controller operates by using a pre-programmed cycle length. Usually, fixed-time controller is not connected to a central system, and local controllers must update and adjust them periodically to assign a new time function. Therefore, this type of controller is inefficient because its time patterns do not take real traffic conditions into consideration. Also, the need for periodic human involvement is considered wasting of resources. ⁽⁶⁾

Another type of controller is the dynamic controller. These controllers are capable of communicating traffic conditions at intersections to computerized network systems. These types of controllers are also known as actuated controllers. They are able to utilize traffic detecting devices in order to assign predetermined time functions programmed into them. Dynamic controllers can significantly reduce traffic congestion and improve traffic flow in comparison to fixed time controllers. However, the effectiveness of dynamic controllers relies heavily on the type of detector that is used. According to Kotwal, Lee, and Kim, a study from the University of California shows that, on an average day in 2005, only 60% of sensors provided reliable measurements. ⁽³⁾ The key point is that detectors and sensors vary widely in terms of quality and effectiveness. Very accurate measurements require very accurate detectors, which will increase their cost. Therefore, the cost of high-quality detectors is a restriction to the implementation of such control systems. ⁽⁶⁾

Adaptive Traffic Control Systems (ATCS) is another type of traffic control systems and were introduced in The United States in 1970s. ⁽³⁾ This system relies on actuated control through the use of detection and surveillance devices over a central communications network. The principal objective of ATCS is to adjust traffic signal

timing patterns in order to meet estimated real-time traffic demand. ATCS is most efficient in large urban areas with continuous traffic fluctuations because it is able to adjust traffic signal timing in real time based on current traffic conditions, demand and system capacity. A disadvantage of this system is its expensive installation process due to the extensive detection, surveillance and communication system it requires. However, the advantage of this system is that it requires less maintenance and a less level of human involvement than the other two systems discussed above. (7)

Detection technologies are mostly used for actuated controllers that assign cycle length time and sequences based on data received from detectors. Detection technologies can be organized into three categories. The first type is the traditional detecting device, which is inductive loops or magnetometers. This type is usually installed under the pavement. Therefore, one advantage is that it is insensitive to extreme weather conditions. However, according to Kotwal, Lee, and Kim, its expensive installation and maintenance, which requires cutting and replacing pavement, is one of its main disadvantages. (3)

Other technically advanced detecting devices such as radar, infrared, cameras, ultrasonic and acoustic devices also exist. These types of sensors are typically installed on a support structure, not in the pavement. Their installation therefore does not require unnecessary cutting of pavement, which reduces the cost of installation and maintenance. However, their main disadvantage is that they are sensitive to weather conditions. In fact, as stated above, a study from the University of California found that only 60% of such modern detectors provided reliable measurements on an average day. Their low reliability rate is caused by missing or incorrect data received by the detector. (3)

Smart detecting systems are the newest detecting technology in the field of traffic control systems. This technology works by installing a device inside vehicles.

This tool communicates with a central computer using Wireless technology. Many GPS companies have already adapted to this system. According to Joseph F. Borbone, TomTom GPS Company uses individuals' GPS devices to send and receive signals. If a car slows down due to traffic delay, a TomTom central computer receives a signal from the delayed car and then sends a message to approaching cars with TomTom GPS devices, alerting them to the delay.⁽⁸⁾ This system has also been adapted by Google's self-driving vehicle, promising a high level of safety in the future.⁽⁵⁾

Artificial intelligence has become a significant and important topic in the field of traffic system. National Highway Traffic Safety Administration (NHTSA) has announced that it will begin initiating the launch of Vehicle-To-Vehicle (V2V) communication devices. A V2V communication device is an alert system that communicates with other vehicles, specifically those outside of the line of sight of the alerted car. According to the magazine *Traffic Technology International*, NHTSA administrator David Strickland said that V2V has the ability to help drivers avoid crashes in 80% of crash scenarios.⁽⁹⁾ These devices are capable of making safe decisions in dangerous and potentially fatal situations based on data received from a central computer. The magazine also indicates that these devices are able to send and receive data 10 times a second.⁽⁹⁾ Additionally, According to Andrew Chatham of Google, the artificial intelligence behind self-driving cars is able to operate efficiently in highly structured situations.⁽⁵⁾ Therefore, based on the evidences discussed above, one advantage of using artificial intelligence in the field of traffic system is high-speed communication. In addition, no data goes missing since the devices are already implanted inside the car. This technology also reduces crashes. However, the amount of data collected by a single device implanted inside a car is massive. Therefore, One obstacle to the successful implementation of these devices is the amount of computing power required in a single car.

Privacy issues are mostly related to new implantations in the field of traffic system such as V2V communication devices. However, according to *Traffic Technology International*, Farid Ahmed-Zaid, a technical expert for global driving assistance at Ford's Active Safety Department, said that V2V would only detect vehicles on the range of 450m. Therefore, Vehicle's type, color, and license plate number would still be anonymous. ⁽⁹⁾

Finally, as stated above, according to 2012 Urban Mobility Report, the amount of CO₂ produced due to congestion was 56 million pounds in both 2010 and 2011. ⁽²⁾ The data shows that the average level of CO₂ produced by congestion has remained almost constant for the past couple of years. In other words, the latest developments in the field of traffic system just discussed have shown minimum effects on the level of CO₂ production due to congestion. Therefore, a breakthrough in the field of traffic system that would reduce congestion is urgently needed.

Based on the above date, it is expected that the Smart Intersection System (SIS) will be helpful in reducing delay at intersections. These delays result in unnecessary fuel consumption and increase the carbon footprint. To that end, two areas of focus were developed in this paper to critically analyze the SIS. These two areas were the physical modal of the traffic signal and unnecessary delay.

Smart Intersection Systems

Smart Intersection System (SIS) is a traffic control system that manages traffic flow through intersections using an integrated system of traffic sensors, traffic data management and smart control systems. SIS is different from the current traffic control system in three ways. First, it includes the ability to count real-time traffic volume. Second, it introduces a new physical model of the traffic light. Third, it develops a central communication network that is able to manage traffic at intersections and throughout the entire traffic network.

First, SIS has the ability to count the number of cars at an intersection and then distribute the timing of green lights based on this real-time traffic volume data. Theoretically, this feature would reduce the amount of time lost at intersections due to poorly timed green lights. An example of this type of time loss would be when an east-west street has high traffic volume and its intersecting north-south street has low traffic volume, but both streets receive the same amount of green light time. The method for counting cars introduced by SIS is to use high-speed sensors and control systems that are able to make decisions according to real-time conditions. A similar idea has also been applied in the V2V communication devices discussed earlier. According to *Traffic Technology International*, V2V devices are able to send and receive data 10 times a second. ⁽⁹⁾ Therefore, V2V and Google Vehicles have already proved the feasibility of sending and receiving real-time data using high-speed communication systems.

Second, the new physical model of the traffic light introduced by SIS has six columns of red lights on the left-hand side, six columns of green lights on the right-hand side, and a yellow diamond in between the two sets of lights that serves as a numerical timer. The timer is designed in this way in order to simulate the international traffic signal for yield. The cycle starts with the entire columns of red lights turning on. Then, the lights start to turn off, beginning on the left and moving

to the right toward the yellow diamond in the middle. When only one red light remains lit, the timer begins to count off, in descending order, the amount of time remaining before the last red light turns off and the entire set of green lights turns on. The transition from the green light to the red light occurs in a similar fashion. Thanks to these modifications, the decreasing red lights will help drivers approximate the amount of time before a light change from a farther distance from the intersection than before. Also, the yellow timer in the middle of the traffic light is advantageous for those drivers who are closer to the intersection. This model is thought to be more informative for drivers than the classical model of the traffic light, which includes only green, red, and yellow circles (**Appendix 1.1**).

Third, in SIS system, all traffic light controllers are linked to one central communication network. This central network sends data to and from traffic lights, analyzes incoming data about traffic volumes, and then develops estimated time patterns for all intersections. This process would ensure that green light time was more efficiently distributed because all traffic lights are able to interact with each other through this central network. In other word, the system is capable of adapting to any extreme fluctuation in traffic volume. The Adaptive Traffic Control Systems (ATCS) discussed above also utilizes such a system. According to Kotwal, Lee, and Kim, only five cities have implemented this system so far. Their data shows that in Broward County, Florida, delay times were reduced by 42%, and travel times were reduced by 20%. In Oakland County, Michigan, delay times were reduced by an average of 7.8%. In Newark, Delaware, delay times were reduced by almost 25%. In Los Angeles, California, delay times were reduced by 44%, and travel times were reduced by 13%. Finally, in Minneapolis, Minnesota, delay times caused by special events were reduced by 19%.⁽³⁾ This evidence indicates that an adaptive system that utilizes one central communication network is exceedingly helpful in reducing delay time, and thus the amount of CO₂ caused by traffic issues. However, as discussed earlier, this type of control system can be expensive because of the detectors and tools required by the system. Therefore, one aim of this paper is to

investigate a cost-efficient technology that is able to fulfill the same role as the adaptive system (ATCS).

In conclusion, current evidences indicate that the three modifications introduced by the SIS will improve the flow of traffic at intersections. The expected benefits of this improvement include reduced delay times, reduced gas consumption, a reduced the amount of CO₂, and increased driver satisfaction. Therefore, two areas of focus are developed in this paper in order to critically analyze the effectiveness of the SIS. These two areas are the physical modal of the traffic light and unnecessary delays at intersections.

Objective:

The objective of this paper is to analyze the SIS proposal and determine an optimal system of traffic control that is both feasible to implement and favored by selected drivers in the US. The paper employs four methods to test the feasibility of SIS: (1) surveys, (2) interviews with selected drivers represent the US, (3) interviews with experts in the field, and (4) simulations.

The study employed two different survey methods: electronically based surveys and paper based surveys. Both versions contain the same questions and have very similar formats in order to minimize bias. All attempts were made to maximize the distribution of surveys in order to insure that the results gave an accurate representation of the population of drivers in the US.

The study carried about interviews in two different ways. The objective of interviews being done with nominated drivers who represent the US was to clarify results from the survey questions as well as to elicit a more detailed response on areas of interest in traffic control. The objective of the second type of interview was to obtain detailed and critical responses from three different specialists in the field of traffic control: an academic, a government employee and a corporate employee.

The study also conducted two different simulations in order to estimate the effects of SIS on the flow of traffic through intersections. The first simulates traffic flow through an intersection using the current traffic control system. The second simulates traffic flow through an intersection according to the conditions introduced by the SIS. Using the first simulation as a reference, the study then generates a numerical estimation of the effects of SIS on traffic flow through intersections.

In order to optimize the SIS configuration, this paper references different literature of traffic control and related research. The paper concludes with a detailed description of the optimal version of SIS at intersections as well as recommendations for future research.

Chapter 2

Methods:

- Surveys, online and paper based.
- Interviews with selected drivers in the US.
- Interviews with specialists in the field of traffic control.
- Simulations.

Surveys:

Surveys were distributed both electronically and paper based and had as their target population drivers in the United States. Both types of surveys employ a cluster sampling method that identifies the population of drives in the United States as a homogenous group.

Online survey design and strategy:

The cluster sampling technique has two stages: sampling by gender, then sampling by age. ⁽¹⁰⁾ The first cluster set was selected according to the gender of the driver: male or female. According to Jerry Edgerton of CBS News, women are thought to have less aggressive driving behavior and therefore tend to have lower insurance rates than men. ⁽¹¹⁾ The second cluster set was then determined based on the age distribution of drives within the sets of male and female drivers. After reviewing insurance research and rates for different age clusters, the study found that the three age clusters agreed upon by the majority of insurance firms are: (16-24) years old, (25-64) years old, and (65+) years old. ⁽¹²⁾ ⁽¹³⁾ Figure 2.1 shows the six total clusters that were selected. They are male drives organized into three age clusters and female drivers organized into three age clusters. These clusters ensure that the focus group interviewed in this study was an accurate representation of the population of drivers in the United States. The number of participants per cluster category was determined using data from the Federal Highway Administration. ⁽¹⁴⁾

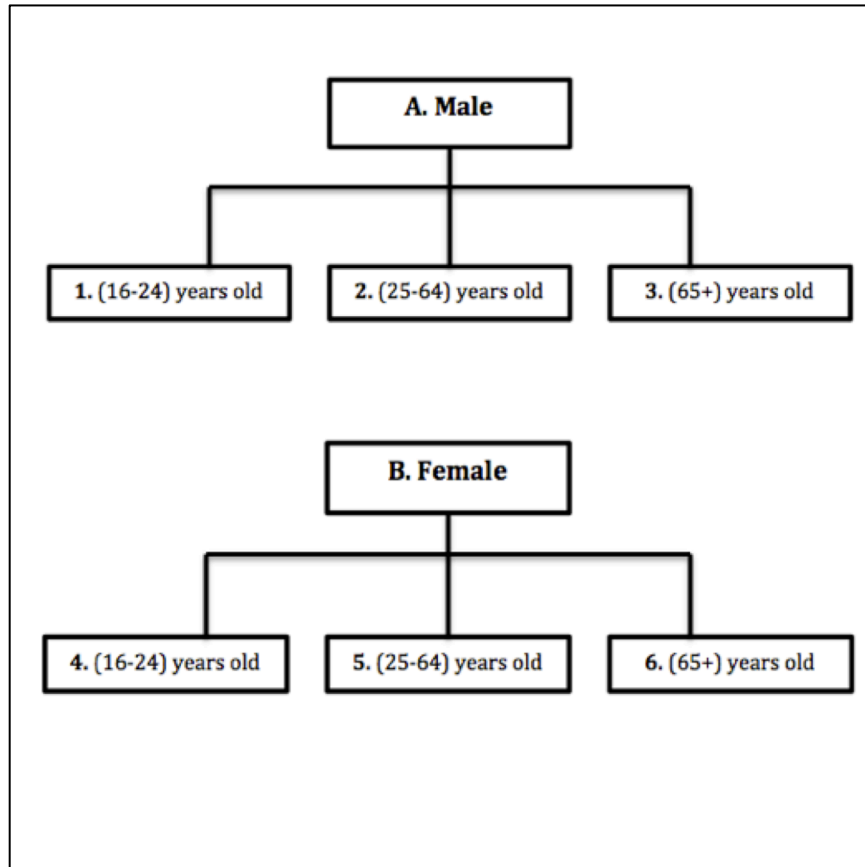

Figure 2.1: Total clusters represent drivers in the US

According to Creative Research Systems, a firm that provide software for professional market researchers who use questionnaires, a survey must have a large number of selected participants in order to have representative survey results. They write: “A good estimate of the margin of error (or confidence interval) is given by $1/\sqrt{N}$, where N is the number of participants or sample size.”⁽¹⁵⁾

Online distribution served as the first round of survey collection. The paper-based surveys were then used to fill any gaps in the data to ensure that all clusters were adequately represented according to the sampling requirements. The online survey was designed and distributed using WPI Qualtrics, which is an online tool for designing and collecting electronic surveys. It was emailed to all WPI students and faculty, approximately 5,000 individuals.⁽¹⁶⁾

The distributed survey asks seven close-ended questions. This type of question was employed because it is a good fit for research related to social science and human behavior. All seven questions are multiple-choice, and the survey asks only seven questions in order to be as brief as possible.⁽¹⁷⁾ This also ensures that each question was carefully selected with a specific purpose in mind. Furthermore, space is provided between each question to ensure clear visibility for the respondents, and diamonds are used to mark the answers instead of a different geometrical shape in order to be attractive to the participant. In addition, the survey offers four multiple choice criteria: strongly disagree, disagree, agree, and strongly agree. Using these four options specifically was found to be the best fit for surveys measuring common behavior, attitudes, or behavior.⁽¹⁸⁾ An even number of multiple choice criteria are given instead of an odd number in order to eliminate unbiased answers such as “I Do Not Know” or “I am Not Sure”.⁽¹⁹⁾ This type of answers is considered unbiased because it would not support one system over another, or one behavior over another, data that is useless for analysis. Four selections is the optimal choice instead of three or five, which are odd numbers and can result in this type of unbiased answer. Finally, when considering six selections, it seems redundant and a bit excessive. When taken together, these guidelines make for an effective survey.

Steps for developing the survey:⁽²⁰⁾

- 1- Specifying goals:
The first step was to clarify the goals of the survey. This step ensured that each question was asked with the specific purpose of addressing one or more of these goals.
- 2- Questionnaire strategies:
In this step, the survey was written by employing different strategies, as mentioned earlier.
- 3- First draft:
The first draft was created. **(Appendix 1.2)**
- 4- Pre-testing:
Pre-testing was conducted in order to find critical flaws in the first draft.
- 5- Second draft:
The second draft was submitted as an online version for complete and final testing.

- 6- Final draft distribution:
The final draft of the survey was distributed to participant using the electronic and paper base methods discussed above.
- 7- Analysis and results of the surveys.

The design of the online survey begins with a visual question, which asks the respondent to arrange a series of pictures of SIS physical traffic light at different stages during the traffic light cycle. The visual question has been assigned as a formal filtration tool when analyzing received responses. ⁽²¹⁾ Four evaluation values are assigned to the answer of this question. First, a value of 3 means the participant answered the question correctly. Second, a value of 2 means the participant understands the flow of the traffic light pictures, but made one minor mistake when arranging the pictures. Third, a value of 1 means that the respondent has a poor understanding the flow of the traffic light pictures, and made one critical mistake when arranging the pictures. Finally, a value of 0 means that the respondent does not understand the logic behind this new physical model, or left the question unsolved. This question was assigned at the beginning of the survey to serve as a filter question. The responses of all participants scoring either a 1 or 0 have been excluded from the data set. Including such a filter was an important way to analyze how well respondents understand the new SIS model displayed in the first question. The raw data for the visual question are provided in **Table 2.1**.

Table2.1: Raw Data for graphical question from Online Surveys

Results for Graphical Question from Online Syrveys					
Question	Question details	Does not	Lack in	Almost	Perfect
Order		understand	understanding	perfect	
1	~ Ask to rearrange SIS new traffic light cycle ~ theme: filtration purposes	(Excluded)	(Excluded)	63	29
			Total	92	Surveys

The first filter question is followed by seven multiple-choice questions. As discussed earlier, each question has 4 possible answer choices: strongly disagree, disagree, agree, and strongly agree. These options were assigned codes from 0-3 respectively in order to translate the data into Microsoft Excel. ⁽¹⁸⁾ Each question measures a pre-specified theme in order to maximize the amount of useful data gathered by survey.

The theme of first question is the safety and functionality of the SIS as well as the desirability of the shape of the traffic light it introduces. The second question indirectly compares the SIS to the current system of traffic control and therefore also reflects the desirability of SIS. The third question targets the functionality and feasibility of synchronizing the timing of green lights between traffic lights. The fourth question targets flaws in the current system. The theme of the fifth question addresses the feasibility that SIS is able to overcome the flaws of the current system. The sixth question focuses on the flaws of the current system pertaining specifically to extreme weather conditions as well as the functionality of the SIS in such situations. Finally, the seventh question focuses on the feasibility and safety of the SIS. The raw data for the multiple-choice questions are given in **Table 2.2**.

Table 2.2: Raw Data for multiple-choice Questions from Online Surveys

Results for multiple-choice Questions from Online Surveys					
Question Order	Question details	Strongly disagree	Disagree	Agree	Strongly agree
2	<p>~ Question: Do you believe that the ability to see the change of traffic signals from a further distance would make intersections safer ?</p> <p>~ Themes: (Safety, functionality, desirability)</p>	1	11	55	25
3	<p>~ Question: Do you believe that the suggested traffic signals are a good replacement for the current traffic Signals?</p> <p>~ Themes: (functionality, and desirability)</p>	5	25	44	18
4	<p>~ Question: Do you believe that synchronizing green lights according to traffic at intersections is a good idea?</p> <p>~ Themes: (functionality, and feasibility)</p>	0	4	49	48
5	<p>~ Question: Do you believe that some drivers take a long time to move through traffic lights when they turn green</p> <p>~ Themes: (flaws in current system)</p>	1	17	38	36
6	<p>~ Question: Do you believe that knowing when to expect a green light would help solve the previous problem in No. 4?</p> <p>~ Themes: (flaws in current system, and functionalty of SIS)</p>	0	16	47	29
7	<p>~ Question: Do you believe that the current traffic lights system could be better adjusted in dealing with hazardous weather conditions?</p> <p>~ Themes: (functionality, flaws in current system)</p>	1	9	60	22
8	<p>~ Question: Do you believe that Smart Intersection System, as explained earlier, could reduce traffic jams and improve safety at intersections?</p> <p>~ Themes: (safety, feasibility of SIS)</p>	0	18	48	26

After the multiple choice section, biographical questions follow, asking the respondent about driver's license status, sex, and age. The driver license question is included in order to serve as a filter question. All respondents who indicated that they do not have a driver's license have been excluded from the final survey count because these individuals do not fall within the target population (i.e. drivers in the United States). The questions about the respondent's sex and age, however, were included in order to fulfill the requirements of the proposed cluster sampling discussed above.

Finally, the survey concludes with, open-ended, free-response questions. The first question asks for any suggestions about how to better alert traffic about light status at intersections from a farther distance. The second question asks for suggestions about how to count cars at intersections. These questions are at the end of the survey because statistics show that respondents usually lose interest in a survey when asked to address these types of questions. According to Harrison in his tip sheet in question wording, respondents are more expected to skip an open-ended than closed-ended question. ⁽²²⁾ Therefore this placement ensures a maximum number of complete surveys.

Paper based strategies:

The paper-based survey begins with a question similar to the first question on the online survey. However, instead of having the respondent arrange pictures of the SIS traffic light in the right order, it asks them to connect the pictures in the right order beginning from a given starting point. Except for this one different, the paper-based and electronic-based versions of the survey were identical in format and question contents. The raw data for the visual question are shown in **Table 2.3**. The raw data for the multiple-choice questions are shown in **Table 2.4**.

Table 2.3: Raw Data for graphical question from Paper Surveys

Results for Graphical Question from Paper Surveys					
Question	Question details	Does not	Lack in	Almost	Perfect
Order		understand	understanding	perfect	
1	~ Ask to rearrange SIS new traffic light cycle ~ theme: filtration purposes	(Excluded)	(Excluded)	22	5
				Total	28
					Surveys

Table 2.4: Raw Data for multiple choice Questions from Paper Surveys

Results for multiple-choice Questions from Paper Surveys					
Question Order	Question details	Strongly disagree	Disagree	Agree	Strongly agree
2	<p>~ Question: Do you believe that the ability to see the change of traffic signals from a further distance would make intersections safer ?</p> <p>~ Themes: (Safety, functionality, desirability)</p>	0	2	16	9
3	<p>~ Question: Do you believe that the suggested traffic signals are a good replacement for the current traffic Signals?</p> <p>~ Themes: (functionality, and desirability)</p>	0	6	13	8
4	<p>~ Question: Do you believe that synchronizing green lights according to traffic at intersections is a good idea?</p> <p>~ Themes: (functionality, and feasibility)</p>	0	3	16	8
5	<p>~ Question: Do you believe that some drivers take a long time to move through traffic lights when they turn green</p> <p>~ Themes: (flaws in current system)</p>	0	2	16	9
6	<p>~ Question: Do you believe that knowing when to expect a green light would help solve the previous problem in No. 4?</p> <p>~ Themes: (flaws in current system, and functionalty of SIS)</p>	1	6	15	5
7	<p>~ Question: Do you believe that the current traffic lights system could be better adjusted in dealing with hazardous weather conditions?</p> <p>~ Themes: (functionality, flaws in current system)</p>	0	1	18	8
8	<p>~ Question: Do you believe that Smart Intersection System, as explained earlier, could reduce traffic jams and improve safety at intersections?</p> <p>~ Themes: (safety, feasibility of SIS)</p>	0	6	18	3

Distribution technique:

The online surveys were distributed using the WPI emailing mainframe, which includes all students and faculty. Using the first question on the survey as a filter, some survey results have been excluded (according to the criteria discussed above) to ensure that the results accurately represent drivers in the US. Before filtering, 124 surveys were returned. **Table 2.5** shows the number of completed online surveys after the first filter was conducted.

Table 2.5: *Obtained online surveys per cluster*

Aquired Online Survey per Cluster		
	<i>Male</i>	<i>Female</i>
<i>Age of (16-24) years old</i>	16	11
<i>Age of (25-64) years old</i>	43	22
<i>Age of (65+) years old</i>	0	0
<u>Total</u>	<u>92</u>	<u>Surveys</u>

The desired number of survey results for each cluster group was determined in reference to statistics regarding the gender and age of drives in the US, as discussed above. Beginning with a total of 100 surveys, it was determined how many surveys of each cluster group were needed to reflect these statistics. The margin of error for a sample of 100 participants is 10%.⁽¹⁵⁾ **Table 2.6** illustrates the desired distribution surveys per cluster group.

Table 2.6: *desired distribution in a base of 100 surveys*

Required Number of Surveys per Cluster in a Base of 100 Surveys		
	<i>Male</i>	<i>Female</i>
<i>Age of (16-24) years old</i>	7	7
<i>Age of (25-64) years old</i>	36	36
<i>Age of (65+) years old</i>	7	7
<u>Total</u>	<u>100</u>	<u>Surveys</u>

Several cluster groups received more responses that the number required by the above determination. Males ages (16-24) years old had 9 extra responses, females ages (16-24) years old had 4 extra responses, and males ages (25-64) years old had 7 extra responses. These extra responses were eliminated according to the

filtration strategies discussed above. **Table 2.7** shows the resulting number of completed online survey after the second filter was conducted.

Table 2.7: *completed online survey after second filtration stage*

Reduced Number of Online Surveys		
	<i>Male</i>	<i>Female</i>
<i>Age of (16-24) years old</i>	7	7
<i>Age of (25-64) years old</i>	36	22
<i>Age of (65+) years old</i>	0	0
<u>Total</u>	<u>72</u>	<u>Surveys</u>

As the table above indicates, females ages (25-64) years old needed 14 more surveys in order to accurately represent the population of drivers in the United States. In addition, both clusters of male and females above (65) years old need 7 more surveys in order to meet the study's standards. These additional surveys were obtained through the paper-based method introduced above. **Table 2.8** shows the numbers of paper-based surveys need in order to reach the appropriate distribution of 100 surveys.

Table 2.8: *required paper base surveys*

Needed Paper Base Surveys Per Cluster		
	<i>Male</i>	<i>Female</i>
<i>Age of (16-24) years old</i>	0	0
<i>Age of (25-64) years old</i>	0	14
<i>Age of (65+) years old</i>	7	7
<u>Total</u>	<u>28</u>	<u>Surveys</u>

All paper base surveys acquired, and all clusters were valid representatives for the population, drivers in the US.

Survey analysis techniques:

According to David Silverman, in his book *Interpreting Qualitative Data*; the analysis of qualitative data should be conducted according to a specific set of steps. First, result categories corresponding to the text of the question must be identified. ⁽²³⁾ These categories represent the theme or aim of each question. For example, the category corresponding to the second question was “functionality of SIS vs. Current system.”

The second step is to construct a coding frame or “categorization scheme” that assigns a numerical value to the answer format used for every multiple choice question fits both theoretical consideration, and selected result categories. ⁽²³⁾ Therefore, all answers that contain the word “strongly,” both “Strongly Agree” and “Strongly Disagree,” were given a code of +2 and -2 respectively. The other possible answers, “Agree” or “Disagree,” were given a code of +1 and -1 respectively. These codes were used as weights or multipliers for the answers in order to create a comprehensive simplified result.

After applying this categorization scheme to the data, all “Disagree” answers, both “Strongly Disagree” and “Disagree” were summed in order to produce a single category. A similar process was conducted with all “Agree” answers. This weighing technique makes it possible to represent the raw data results in a clear fashion so that each question has two possible final results, either “Agree” or “Disagree”.

Interviews with selected drivers in the US:

The interview method provides clarification to any results that remain unclear from the survey portion of the study. The interviews also provide more detailed answers and therefore give the results more depth. The participants in the interview portion of the study were selected according to the same cluster sampling technique as the one used in the survey portion, using age and gender as parameters. ⁽¹⁰⁾

The interviews are designed to be semi-structural interviews. This is the best design for gathering the optimum amount of qualitative data because it does not provide so much data that it becomes overwhelming, but it provides enough data that the results are not reprehensible. ⁽²⁴⁾ After analyzing the data from the surveys, the answers appeared to need little clarification. Therefore, only a small number of interviews have been conducted. The minimum number of interviews that had to be conducted in order to meet the distribution requirements of the cluster sampling method used in this study was 10. **Table 2.9** below illustrates required number of interviews per cluster.

Table 2.9: *required number of interviews per cluster*

Required interviews on a base of 10		
	<i>Male</i>	<i>Female</i>
<i>Age of (16-24) years old</i>	1	1
<i>Age of (25-64) years old</i>	3	3
<i>Age of (65+) years old</i>	1	1
<u>Total</u>	<u>10</u>	<u>Interviews</u>

Interview design and format:

A minimum number of questions were included in the interviews in order to ensure that interview time was kept to a minimum. According to Rowley in *Conducting Research Interviews*, interview results should not cause the researcher to be “drowning in a sea of data”.⁽²⁵⁾ Therefore, a concise number of direct questions were developed for this study. After pre-testing, interviews to between 8 and 10 minutes to conduct.

An outline of the interview process is as follows: the interview began with an introduction to our research. We then showed the interviewees the physical model of the SIS traffic light and asked some questions about it. After that, we asked the interviewees questions about delay times at intersections. Then, we screened a video of an intersection in Worcester for the interviewees. This video demonstrated lost green-light time at the intersection. After the video, we asked the interviewees questions related to the video. Next, we asked the interviewees about extreme weather situations and how well the current system is able to deal with them. Finally, we asked the interviewees to disclose their age and sex for filtering purposes.

Each interview started with an introduction of the research idea, and then guidelines for the interview were given to the interviewee. Interviewee was asked whether the audio of the interview session could be recorded, and every interview was recorded except for three guests. In these instances notes were taken instead. After the introduction, interviewee was asked to watch a power point display presenting the physical model of the SIS traffic light and the suggested traffic light cycle. Questions regarding the physical model were then posed. The first question targets the functionality of the SIS traffic light to notify people at a distance. Next, the interviewee was asked to explain his/her response. Finally, the interviewee

was asked to provide any additional suggestions regarding the model's ability to notifying people at a distance.

The interview process then moved on to questions about delay issues at intersections. The first question inquired about a driver's mental state when delayed by other drivers at an intersection. The second question also asked about the mental state of the driver, but this time when he/she causes the delay. After that, interviewee was asked to identify any solutions to the problems discussed in the previous two questions. The final question in this portion of the interview asked the interviewee to provide any further suggestions as to how the current model might be modified in order to better notify drivers waiting to pass through the traffic light of the status of the change in light at the intersection.

Next, a video about the lost green time at an intersection was shown to the respondent, followed by a set of questions. The first question asked for solutions to the problem introduced in the video. The second question asked whether the respondent believed that a system that automatically recognized the flow rate through an intersection would solve this problem. The respondent was then asked about what adjustments might be made to the current traditional system in order to better deal with cases of extreme weather conditions such as heavy snow, heavy rain, fog, or emergency situations.

The final part of the interview asked one question from an additional set of questions based on the six specified clusters. It was predicted that those above the age of (65) would face more visibility issues. Therefore, male and female guests who were above (65) years of age were asked about improving the visibility of the current traditional system. In addition, male drivers between the ages of (16-24) years old were asked whether it would be possible to accelerate the flow of cars through an intersection. Female drivers were asked whether drivers being more

relaxed would increase the flow of cars through traffic lights. According to Hartocollis and Anemona from the *New York Times*, women are found to be safer drivers than men, and the stereotype of men being better drivers would die. ⁽²⁶⁾

To conclude, the interviews were conducted as in-depth, individual interviews, because this makes it possible for the interviewer to be flexible with the flow of question. Interviewees were asked 5-10 questions as was appropriate for the flow of conversation. ⁽²⁴⁾ All of the questions addressing the physical model of the SIS traffic light, delay issues, and lost green light time were based on the survey results, as discussed in the previous section. The additional questions targeting the specific clusters to which an interviewee belonged, were included in order to create more in-depth results that would help clarify the survey results. See **(appendix 2.1)** for all 10-recorded interviews.

Interviews with Specialists in the field of traffic and traffic control:

It was necessary to submit SIS to critical analysis. Specialists in the field of traffic control are the best fit for such an objective; as they are well aware of the traffic challenges that might arise for this system. Both positive and negative feedback from such specialists was carefully considered when optimizing the optimum version of the SIS in this paper. Three specialists were asked to consider the SIS: (1) Joseph F. Borbone, director of engineering at the Department of Public Works and Parks, in the city of Worcester; (2) Professor Suzanne LePage, an established professor in the field of traffic control and management at WPI; and (3) Abdulhameed Ali, cofounder and partner at DAAR Corporate, a professional engineering corporation whose work includes transportation engineering.

Each of these interviews was designed to critically analyze SIS and its feasibility. The first interview, with Joseph F. Borbone, focused primarily on the visibility of SIS and its module as compared to current traditional systems. The second interview, with Professor Suzanne LePage, aimed at understanding current and advanced research in the field of traffic control and simulation. The third interview, with Abdulhameed Ali, focused on the financial side of constructing such a traffic system and any feasible potential for revenue.

All three specialists interviews followed the same procedure as the general interviews. Therefore, all specialist interviews were recorded. See **(Appendix 2.2)** for all recorded data of these interviews.

Simulations:

A simulation method was introduced in order to establish the time line and flow rates through an intersection. Using this method, the SIS was compared to the current model through a series of simulations modules. The simulation focuses on the differences in flow rate and delay time at intersections. The results are percentages by which SIS reduced delay time. These factors were also helpful in determining whether SIS is able to reduce the amount of CO₂.

Highway capacity software:

Highway capacity software is one of the most accurate simulation software for analyzing traffic intersections because of the amount of details it includes in its simulations.⁽²⁷⁾ It has built-in simulation models for different intersection designs as well as different control systems. First the user enters the relevant data, which for this study were functions of approaching cars in each direction. Then, the user specifies the intersection design desired, such as a 4-direction intersection or 2-direction intersection. After that, the user selects the desired type of control system. Possible control systems vary from uniform controlled delay to a counting system that counts the number of cars in real time.

As mentioned earlier, highway capacity software is very detailed and specific. Therefore the users is also able to include factors such as the width of the lanes at the intersection, parking settings on the sides, people's reaction time, acceleration values, etc.

The simulation's output is a service rate. The service rate of the whole intersection varies between (A, B, C, D, E and F), with every street direction being given a separate rate. A service rating of (A) means that the direction is not causing a problem for the intersection and its service level is excellent.⁽²⁸⁾ When a direction

has a low service rating, it is diminishing the service of the intersection as a whole. With this information, the user is then able to begin analyzing the roots of the problem, such as insufficient green-light time or a higher number of left turners who need higher priority in the cycle and so forth.

The software discussed above is different from the software used in the simulations conducted for this study. It does, however, serve an educational purpose and helps establish familiarity with the nature of traffic simulation software. Since the main goal of the simulations conducted for this study was to focus on the controlled delay caused by the settings of the control function assigned for the traffic light. All other factors could be excluded in order to simplify the simulation. The only simulation data necessary for this study was reduced delay time at intersections and lost green-light time.

Delay measurements:

The most often cited measure of operational quality is delay time. Therefore, it was convenient to have a current real life model to estimate delay. There are five common quantified delay types.⁽²⁹⁾ The first is stopped-time delay and it indicates the time a vehicle is delayed in a queue while waiting to pass through an intersection. The delay begins when the vehicle is fully stopped and ends when the vehicle starts to accelerate. Average stopped-time delay is the average of all vehicles during a specified time period.⁽²⁹⁾

The second type of delay is called approach delay, and it includes stopped-time delay. To this delay, it adds the time loss due to deceleration from the speed approaching an intersection to rest and the time loss due to re-acceleration back to the desired speed. Average approach delay is the average of all vehicles during a specified time period.⁽²⁹⁾

The third type of delay is called travel time delay. It indicates the difference between the driver's expected travel time through an intersection and the actual time taken. Finding the desired travel time is challenging, and therefore, this delay concept is rarely used. ⁽²⁹⁾

The fourth type of delay is called Time-in-queue delay. It is the total time it takes for a vehicle to join an intersection queue until it crosses the stop line upon departure. The average time-in-queue delay is the average for all vehicles during a specified time period. ⁽²⁹⁾

The fifth type of delay is called control delay. It names the delay caused by a control device like a traffic signal. It is approximately equal to the time-in-queue delay plus the acceleration and deceleration delay times. This delay measure can be determined for a single vehicle and as an average for all vehicles over a specified time period. ⁽²⁹⁾

Studying real intersection (Highland St and West St):

“Turning Movements Counts “provides data from real intersections. ⁽³⁰⁾ This data is obtained by counting cars at each direction of the intersection. This data can be obtained from Central Mass Regional Planning Commission (CMRPC). However another way to obtain traffic data at intersections is simply to count cars for a period of time and then factor this data based on the season, time, peak hours, and etc. Following this approach, turning movement counts at the intersection of Highland St. and West St. were obtained for 30 minutes (**appendix 3.1**). This count will not be used directly in the simulation process of this project. Instead, it has been considered in order to understand the traffic light cycle. It was used in order to estimate the average volume of cars for each direction of the intersection in a single cycle of the traffic light system. **Figure 2.2** is a turning movement counts’ sheet produced for the intersection of Highland St and West St.

Intersection Name: Highland St and West St, Worcester, MA, 01609
Time: 6:20 pm – 6:50 pm **Date:** 6/10/2014
Duration: 30 minutes
Weather: Sunny

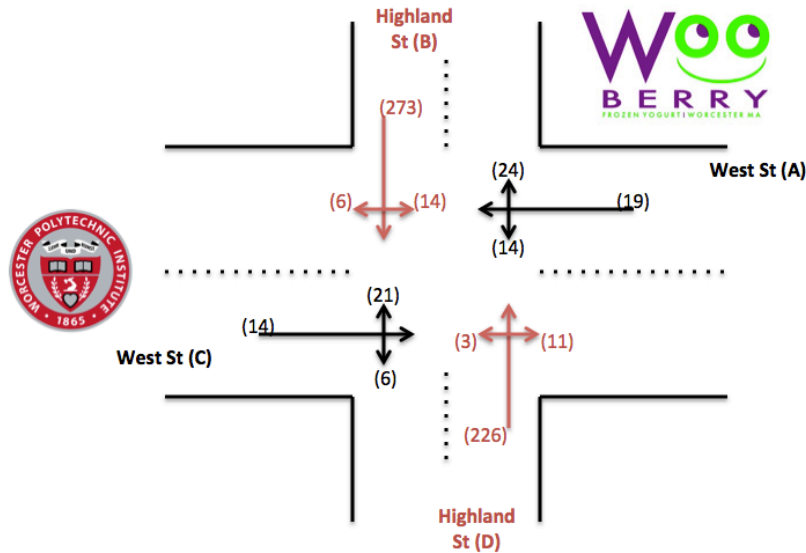

highland St (A)				
left	Straight	Right	Total	Average cars per cycle
3	226	11	240	17

West St (B)				
left	Straight	Right	Total	Average cars per cycle
14	19	24	57	4

highland St (C)				
left	Straight	Right	Total	Average cars per cycle
14	273	6	293	20

West St (D)				
left	Straight	Right	Total	Average cars per cycle
21	14	6	41	3

Figure 2.2: Turning Movement Counts for the intersection of Highland St and West St

The length of the cycle was estimated by averaging the cycle length of 5 cycles. Accordingly, the average length of a complete traffic light cycle was found to be 55 seconds. For Highland St., average cycle time was 36 seconds. For West St., average cycle time was 19 seconds. These values were used in the simulation process as the current control function.

Simulation objectives:

The simulation considered three possible scenarios at the intersection of Highland St. and West St. using ARENA Software. ⁽³¹⁾ Each scenario reflects a single cycle of the traffic light at the intersection. The purpose of this examination was to focus on the effects of control delay, which is the delay caused by a control device like a traffic signal. This type of delays factors in all other type of delays such as time-in-queue delay, acceleration delay and deceleration delay.

Every scenario was run twice. First, the intersection was tested under the current control function, which as a pre-assigned function was assumed to be uniform. As mentioned earlier, for Highland St. the control function was 36 seconds, and for West St, it was 19 seconds. This means that time was pre-assigned for all directions of the intersection even with the inconsistency of cars in every cycle. These values were therefore constant for all three scenarios.

Second, the intersection was tested under the SIS control function. This function was assigned to be different for every cycle; since the traffic light controller receives data indicating the number of approaching vehicles from all directions. This means that the traffic light would assign different time functions to every cycle based on the data it received.

In order to guarantee the validity of the simulation process, several factors were kept constant between both simulations. First, the total length of the cycle for both the current control function and SIS control function was designed to be 55 seconds to keep the simulation process consistent. However, the 55 seconds could be distributed in different proportions for the different directions of the intersection. Second, inter-arrival time was measured and estimated to be a triangular function from 0 to 2.5 seconds, which includes the perception reaction time of drivers

required by the Federal Highway Administration (FHWA). This inter-arrival value is fixed for both simulation designs discussed above as well.

Third, the capacities of both Highland St. directions as well as the capacities of both West St. directions were averaged to one value. These values will be referred to as the normal-average capacity for both directions, and they can be found in **Table 2.10** below.

Table 2.10: *Normal-Average*

Normal-Average capacities:		
	<i>Highland St</i>	<i>West St</i>
<i>Normal-average capacity</i>	19	4

The delay model of the intersection was simplified in order to focus on the effects of control delay. Since all legs of the intersection were symmetrical in shape, several detailed delay factors were excluded. For example, the effects of lane width, presence of pedestrians, and parking on the sides were excluded because their effects were estimated to be constant for both SIS and current conditions. In addition, delays caused by right and left turners were neglected for the purpose of simplification.

Simulation scenarios:

Three scenarios were developed for the purpose of simulation. In first scenario, average capacity was assumed to be 30 cars for both directions of Highland St., which is higher than the normal-average capacity. The average capacity for both directions of West St. was assumed be 2 cars, which is lower than the normal-average capacity. **Table 2.11** explains the details of this scenario.

Table 2.11: *First scenario details*

First Scenario:			
	<i>Current System</i>	<i>SIS</i>	<i>Mutual</i>
<i>assumed capacity in highland St per direction</i>			30 cars
<i>assumed capacity in West St per direction</i>			2 cars
<i>Total capacity for the whole intersection</i>			64 cars
<i>Control function for Highland St</i>	36 seconds	50 seconds	
<i>Control function for West St</i>	19 seconds	5 seconds	
<i>Total cycle length</i>			55 seconds

For the second scenario, average capacity was assumed to be 40 cars for both directions of Highland St, which is higher than the normal-average capacity. Average capacity for West St. was assumed be 0 cars for both directions. **Table 2.12** describes the details of this scenario.

Table 2.12: *second scenario details*

Second Scenario:			
	<i>Current System</i>	<i>SIS</i>	<i>Mutual</i>
<i>assumed capacity in highland St per direction</i>			40 cars
<i>assumed capacity in West St per direction</i>			0 cars
<i>Total capacity for the whole intersection</i>			80 cars
<i>Control function for Highland St</i>	36 seconds	55 seconds	
<i>Control function for West St</i>	19 seconds	0 seconds	
<i>Total cycle length</i>			55 seconds

For the third scenario, average capacity was assumed to be 10 cars for both directions of Highland St, which is lower than the normal-average capacity. The average capacity for West St. was assumed to be 20 cars for both directions, which is much higher than the normal-average cars capacity. **Table 2.13** explains the details of third scenario.

Table 2.13: *third scenario details*

Third Scenario:			
	<i>Current System</i>	<i>SIS</i>	<i>Mutual</i>
<i>assumed capacity in highland St per direction</i>			10 cars
<i>assumed capacity in West St per direction</i>			20 cars
<i>Total capacity for the whole intersection</i>			60 cars
<i>Control function for Highland St</i>	36 seconds	15 seconds	
<i>Control function for West St</i>	19 seconds	35 seconds	
<i>Total cycle length</i>			55 seconds

Simulations design:

As mentioned above, the simulations were conducted using ARENA Software. This software is designed to simulate processes that involved queues, waiting time, and flow rates. First, four modules were designed and placed as entries points, each for one direction of the intersection. Average capacities per cycle were placed in these modules. These modules represent the queue line in each direction. For each process module, one resource was assigned to serve the queue line. This resource represents one of the four traffic lights at the intersection. Then, the control function was assigned for each resource in order to distribute green light and red light times. Finally, four dispose modules were placed, each linked to the end tail of each queue. It disposes of cars, which already passed through the intersection. The length of each simulation, as discussed above, was 55 seconds. See (Appendix 3.3) for the complete design.

As mentioned earlier, the purpose of the simulations was to focus on the effects caused by control delay. Therefore, the overall flow rate per cycle was used to quantify the effects of this delay. In other words, the higher the flow rate per cycle, the lower the time drivers were unnecessarily delayed by the controller. In the results section of this paper, the flow rate of the current control function is compared to the flow rate of the SIS control function.

Simulation of the new physical model:

The new model represented by SIS has two counting methods. First, there is a timer in the middle of the light, which notifies drivers who are close to the traffic light. Second, decreasing lights for both the green and red times were included in the design to notify drivers at a farther distance from the intersection. However, in this section, the effects of these changes was determined according to public opinion as measured by both the survey and interview methods. Public opinion about the new physical model will be interpreted to clarify which types of delay this model might produce.

Chapter 3

Results:

- Online survey format and results.
- Paper based survey format and results.
- Surveys cumulative results.
- Interviews with selected drivers' outline and results.
- Interviews with specialists in traffic control outline and results.
- Simulations results.

Online surveys:

The distributed online survey was three pages and is illustrated in **Figure 3.1**, **Figure 3.2**, and **Figure 3.3**.

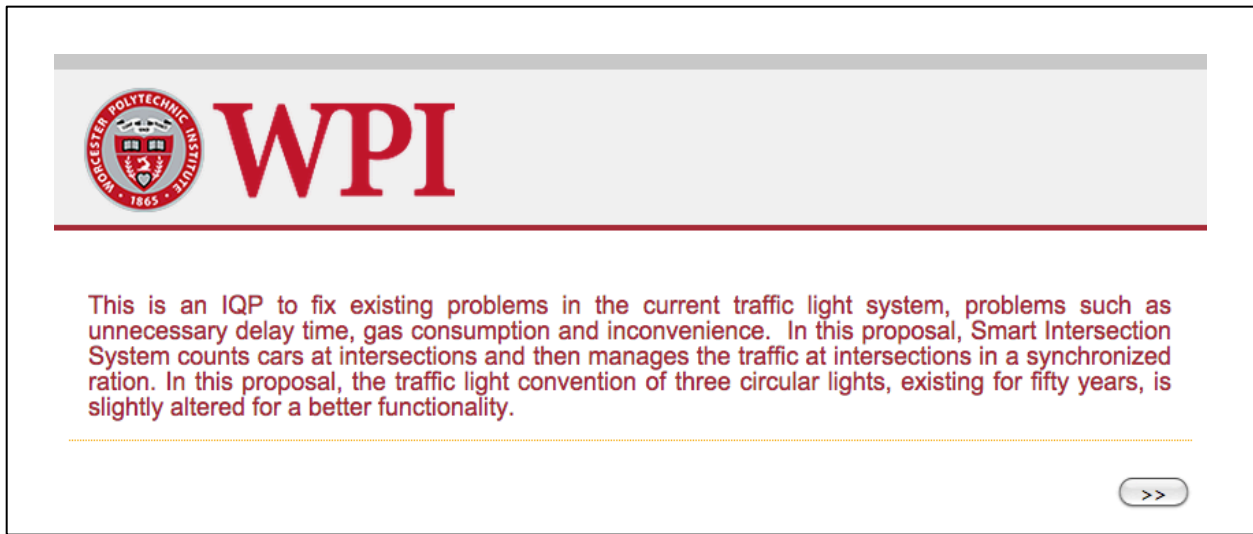

Figure 3.1: *Online Survey (1-3)*



Do you believe that the ability to see the change of traffic signals from a further distance would make intersection safer?

- Strongly Agree
- Agree
- Disagree
- Strongly Disagree

Do you believe that the suggested traffic signals are a good replacement for the current traffic signals?

- Strongly Agree
- Agree
- Disagree
- Strongly Disagree

Do you believe that synchronizing green lights according to traffic at intersections is a good idea?

- Strongly Agree
- Agree
- Disagree
- Strongly Disagree

Do you believe that some drivers take a long time to move through traffic lights when they turn green?

- Strongly Agree
- Agree
- Disagree
- Strongly Disagree

Do you believe that knowing when to expect a green light would help solve the previous problem in No. 4?

- Strongly Agree
- Agree
- Disagree
- Strongly Disagree

Do you believe that the current traffic lights system could be better adjusted in dealing with hazardous weather conditions?

- Strongly Agree
- Agree
- Disagree
- Strongly Disagree

Do you believe that Smart Intersection System, as explained earlier, could reduce traffic jams and improve safety at intersections?

- Strongly Agree
- Agree
- Disagree
- Strongly Disagree

Figure 3.2: Online Survey (2-3)



WPI

Do You have a driver License?

- Yes
- No

Sex:

- Male
- Female

Age

- (16 - 24)
- (25 - 65)
- (65 +)

Besides the current system of three circular lights, what method would you propose to alert approaching traffic for the change in traffic signals?

Besides using pressure sensors and cameras, can you suggest other methods for counting cars at intersection?

Figure 3.3: *Online Survey (3-3)*



Paper based surveys:



The distributed paper survey was two pages and is illustrated in **Figure 3.4**, and **Figure 3.5**:

This is a survey for the WPI-IQP **Smart Intersection System**

This is an IQP proposal to fix existing problems in the current traffic light system, problems such as unnecessary delay time, gas consumption and inconvenience. In this proposal, SIS functions through counting cars at intersections and then manages the traffic at intersections in a synchronizing ration. In this proposal, the traffic light convention of three circular lights, existing for fifty years, is slightly altered for better functionality.

- Please connect the pictures of traffic signals starting from the connected ones:

- Please answer the following questions:

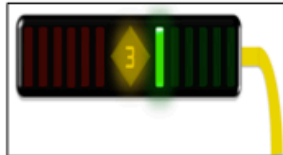
	Strongly Agree	Agree	Disagree	Strongly Disagree
1- Do you believe that the ability to see the change of traffic signals from a further distance would make intersections safer	<input type="checkbox"/>	<input type="checkbox"/>	<input type="checkbox"/>	<input type="checkbox"/>
2- Do you believe that the suggested traffic signals are a good replacement for the current traffic Signals?	<input type="checkbox"/>	<input type="checkbox"/>	<input type="checkbox"/>	<input type="checkbox"/>
3- Do you believe that synchronizing green lights according to traffic at intersections is a good idea?	<input type="checkbox"/>	<input type="checkbox"/>	<input type="checkbox"/>	<input type="checkbox"/>
4- Do you believe that some drivers take a long time to move through traffic lights when they turn green?	<input type="checkbox"/>	<input type="checkbox"/>	<input type="checkbox"/>	<input type="checkbox"/>

Figure 3.4: Paper Survey (1-2)

		Strongly Agree	Agree	Disagree	Strongly Disagree
	5- Do you believe that knowing when to expect a <u>green</u> light would help solve the previous problem in No. 4?	<input type="checkbox"/>	<input type="checkbox"/>	<input type="checkbox"/>	<input type="checkbox"/>
	6- Do you believe that the current traffic lights system could be better adjusted in dealing with hazardous <u>weather</u> conditions?	<input type="checkbox"/>	<input type="checkbox"/>	<input type="checkbox"/>	<input type="checkbox"/>
	7- Do you believe that Smart Intersection System, as <u>explained</u> earlier, could reduce traffic jams and <u>improve</u> safety at intersections?	<input type="checkbox"/>	<input type="checkbox"/>	<input type="checkbox"/>	<input type="checkbox"/>

A-	Do you have a driver's license:	Yes <input type="checkbox"/>	No <input type="checkbox"/>		
B-	Sex:	Male <input type="checkbox"/>	Female <input type="checkbox"/>		
C-	Age:	(16-24) <input type="checkbox"/>	(25-65) <input type="checkbox"/>	(65+) <input type="checkbox"/>	

Q1: Besides the current system, what method would you propose to alert approaching traffic for the change in traffic signals?					
.					
.					
Q2: Besides using pressure sensor and cameras, can you suggest other methods for counting cars at intersection?					
.					
.					

Figure 3.5: *paper Survey (2-2)*

Survey method:

The results from both the online and paper surveys are illustrated in **Table 3.1**. The table shows the questions that were asked in both survey methods as well as the corresponding percentage of agreement and disagreement to these questions based on the analysis technique explained in an earlier section of this paper.

Table 3.1: Final results for all 100 surveys

Question Order	Question details	Overall Agreement	Overall Disagreement
2	<p>~ Question: Do you believe that the ability to see the change of traffic signals from a further distance would make intersections safer ?</p> <p>~ Themes: (Safety, functionality, desirability)</p>	92%	8%
3	<p>~ Question: Do you believe that the suggested traffic signals are a good replacement for the current traffic Signals?</p> <p>~ Themes: (functionality, and desirability)</p>	75%	25%
4	<p>~ Question: Do you believe that synchronizing green lights according to traffic at intersections is a good idea?</p> <p>~ Themes: (functionality, and feasibility)</p>	97%	3%
5	<p>~ Question: Do you believe that some drivers take a long time to move through traffic lights when they turn green</p> <p>~ Themes: (flaws in current system)</p>	92%	8%
6	<p>~ Question: Do you believe that knowing when to expect a green light would help solve the previous problem in No. 4?</p> <p>~ Themes: (flaws in current system, and functionalty of SIS)</p>	85%	15%
7	<p>~ Question: Do you believe that the current traffic lights system could be better adjusted in dealing with hazardous weather conditions?</p> <p>~ Themes: (functionality, flaws in current system)</p>	91%	9%
8	<p>~ Question: Do you believe that Smart Intersection System, as explained earlier, could reduce traffic jams and improve safety at intersections?</p> <p>~ Themes: (safety, feasibility of SIS)</p>	85%	15%

Five themes were selected from **Table 3.1** to construct the results of the surveys in **Figure 3.6**. These themes were functionality, desirability, feasibility, safety and overall assessment.

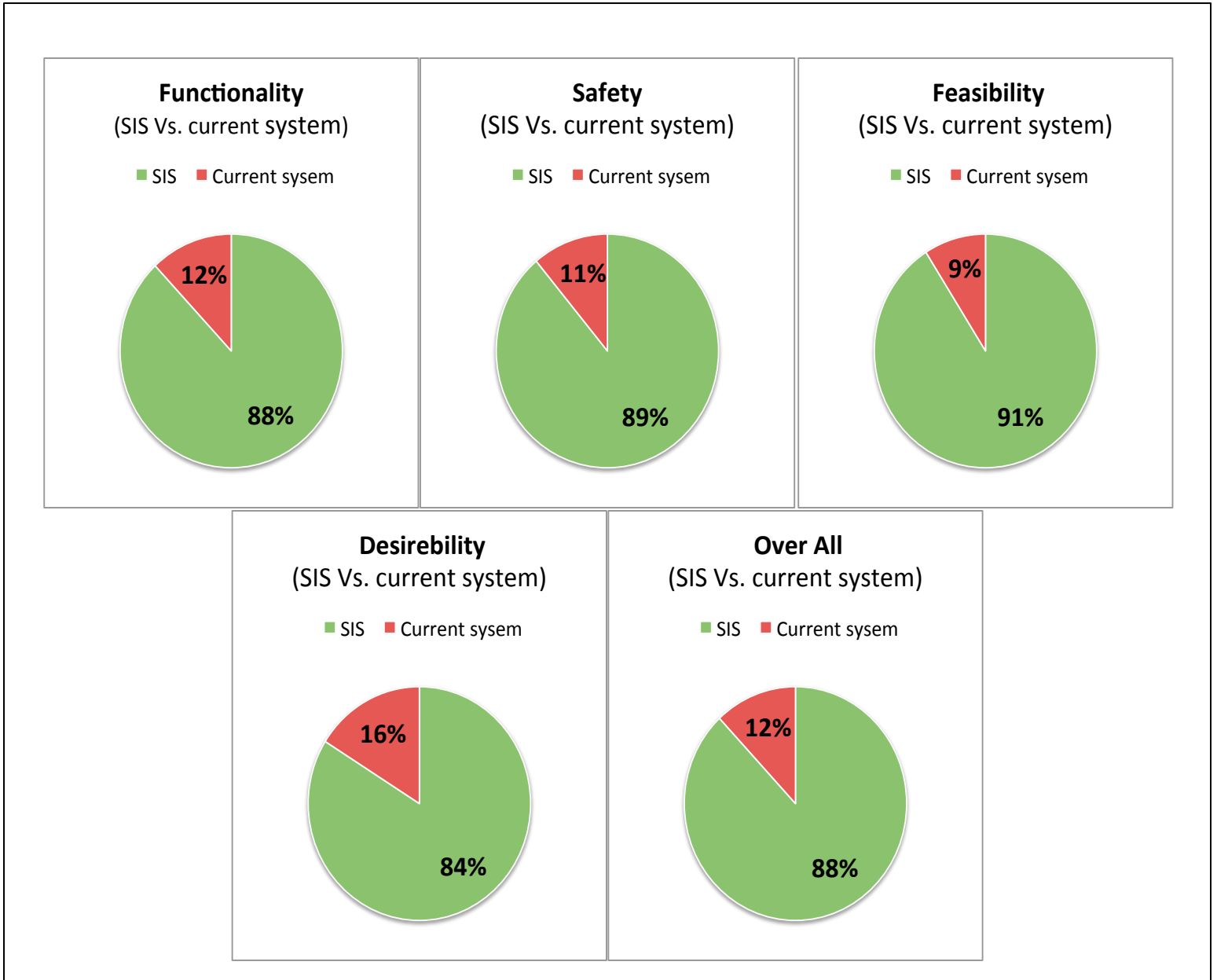

Figure 3.6: surveys results based on 5 themes

Selected drivers interviewing method:

The format of the 10 interviews conducted in this paper is illustrated in **Figure 3.7**.

<u>Interview Final Format</u>	
1. Introduction:	<ul style="list-style-type: none">a. "Hello, we are a group of students from WPI conducting a research in the field of traffic system. The purpose of this study is to improve the quality and functionality of traffic system, as the current system has not been majorly developed in the last couple years to cope with increasing traffic volume."b. Interviewee is given interview's guidelines that clarify all guidelines such as time, contact information, privacy of information, and ... etc.
2. PowerPoint:	<ul style="list-style-type: none">- <i>Physical model of SIS that shows a complete traffic light cycle as it a real traffic light.</i>
3. Category of the physical model:	<ul style="list-style-type: none">a. Do you believe that Smart Intersection System new physical model would help in notifying people of the change in traffic lights from further distance?b. Why?c. What would you change in the current traffic light to make it visible from further distance?
4. Category of delay issues:	<ul style="list-style-type: none">a. How do you feel when other drivers delay you?b. How do you feel when you delay other driver?c. How would you overcome these affects?d. Why do think people take long time to move on a green light?e. What method do you suggest to notify people of the change in traffic light?
5. Short video:	<ul style="list-style-type: none">- <i>Video shows bad distribution of green light of one of the current traffic system intersections.</i>
6. Category of lost green time:	<ul style="list-style-type: none">a. How would you overcome the problem shown in the video?b. Do you believe that a system that automatically recognizes the flow rate through it would solve this problem?
7. A question about Extreme weather conditions:	<ul style="list-style-type: none">a. How would you adjust the current system in cases of extreme weather conditions such as heavy snow, heavy rain, fog, or emergency situations?
8. Category of additional questions:	<ul style="list-style-type: none">➤ Male, and female drivers who are (65+) years old:<ul style="list-style-type: none">▪ How would you improve the traffic light to make it more visible?➤ Male drivers who are (16-24) years old:<ul style="list-style-type: none">▪ Do you believe that it is possible to accelerate the flow rate through an intersection?➤ Female drivers in general:<ul style="list-style-type: none">▪ Do you believe that it is possible to increase the flow rates through traffic lights by having more relaxed drivers?

Figure 3.7: Interview final format

As mentioned above, all interviewees enjoyed the physical model of SIS. However, they also state that the size and dimensions of a traffic light are important factors to consider. Participants adamantly agreed that large-sized traffic lights placed in the middle of the road would help drivers see the change of lights from a farther distance. This confirms that the SIS model would be visible from a farther distance than current systems. Regarding the current model of traffic lights, interviewees have interesting suggestions for possible adjustments. First, they suggested that adding more counting abilities would help to make the current model of traffic lights smarter when interacting with drivers. Second, they suggested using a hologram to notify drivers of the change of traffic light from a farther distance. This is a safe option that can be placed far from the stop line of the intersection.

Category of delay issues:

Interviewees categorized causes for delay in two ways: external and internal. External causes were those that occurred outside the vehicle such as a bus stopping in front of a vehicle. Internal causes were those distractions that happened inside the vehicle such as texting, calling, or dropping off a passenger. Causes for delays can also be categorized into in-control types, and out-of-control types. In-control causes include unnecessary deceleration, texting, and calling. Out-of-control causes include those that are caused by factors outside of the vehicle such as intersection being blocked. In order to overcome these issues, interviewees suggested three types of solution. The first type of solution was education, whereby increasing the knowledge and the awareness of traffic systems could rectify the problem. The second type of solution suggested assigning new policies and fines that would deter careless drivers. The third type of solution suggested using a smarter system that would grab the attention of drivers waiting at an intersection. Possible ideas included using holograms, sound effects, and modern timers.

Category of lost green time:

According to the interviewees, in order to distribute time effectively, high quality sensors and detectors must be used to detect approaching traffic. One possible way of achieving this would be to link the traffic sensors to a microchip attached to a car. This will provide for more accurate readings of traffic and in turn a more accurate distribution of green-light time.

Category of extreme weather conditions:

Most interviewees thought that driver' behavior needs to be adjusted during extreme weather conditions rather than traffic systems. However, a few adjustments can be applied to the current system to make it safer for drivers during extreme weather situations. For example, one interviewee suggested optimizing the cleaning process for snow. Another suggestion was to increase the transition time of the traffic light. This would help during extreme weather since in these situations some drivers might have reduced control over their vehicles.

Specialists in the field of traffic interviewing method:

A. Interview with Joseph F. Borbone:

Figure 3.8 illustrates the outline of the interview conducted with Mr. Joseph:

- **Outline interview with Joseph F. Borbone:**
 - 1) What down flaws does the current traffic light system have?
 - 2) Is it possible to overcome the problem of lost green time?
 - 3) Do you believe some drivers take longer time than needed when moving on green light?
 - 4) Introduce SIS model.
 - 5) Is SIS a good replacement for the current system?
 - 6) What type of control and coordinating system is used in Worcester?
 - 7) What issues should be considered when optimizing traffic control system?
 - 8) Is SIS feasible for counting traffic flow?
 - 9) Suggestions, and criticism for SIS?

Figure 3.8: *Outline of interview with Mr. Joseph*

Summarized interview with Joseph F. Borbone:

The biggest concern he had regarding the current traffic light model was visibility when the sun is behind it. Drivers are not able see the change of traffic light clearly when the sun is facing them. Another problem he cited was that for some streets the traffic light is visible for drivers driving in directions other than the one controlled by the light. In such cases, these drivers might be motivated to accelerate, but for a change in the wrong traffic light. He noted that many accidents occur when drivers become restless and make fast, immediate, and dangerous decisions.

However, in order to decide if the SIS model would help notify drivers at a farther distance, he thought that the model must be applied to a real intersection

because some unexpected scenarios might arise. For example, the pedestrian timer was a great and efficient addition to the traffic light system. However, some drivers tend to take advantage of these pedestrian timers to make fast, dangerous, and wrong decisions, which has been the cause of some traffic accidents at intersections.

He did not believe that implanting a microchip in cars to work as sensors was a costly idea. He pointed out that GPS companies such as Tom Tom are already using individuals' GPS devices to send and receive signals. If a car slows down due to a traffic delay, Tom Tom's central computer receives a signal from the delayed cars and then sends it to the approaching cars using the Tom Tom GPS device to alert them. Furthermore, he suggested that technology and computers are able to learn from day-by-day flows and also adapt when something unusual happens. Therefore, he believes that an integrated traffic light system is absolutely possible.

Finally, he thought that upgrading detecting devices is urgently needed in order to cope with high-speed computers that would make very fast traffic decisions. Also, he pointed out that there is a lag of three seconds at all intersections where every direction has a red light and that this lag should be taken into account when implanting any type of smart system.

B. Interview with Professor Suzanne LePage:

Figure 3.9 illustrates the outline of the interview conducted with Prof. LePage:

- **Outline interview with Professor Suzanne LePage:**
 - 1) Explain the SIS briefly.
 - 2) Interview:
 - What would you change in SIS physical shape?
 - What method would you suggest for collecting flow data at intersections?
 - How would you deal with delay issues at traffic lights?
 - What are some specific problems of current traffic lights and how would you overcome them?
 - How accurate is the data from simulations when representing real life examples.
 - What are the strength and the weaknesses of the SIS system shown?
 - 3) Explain simulation process and requirements.
 - 4) Pointers for simulation, and data needed for simulation.
 - 5) MIT simulation project.
 - 6) Recommended research for current employed traffic light system
 - 7) Recommended research for simulation of traffic light system.

Figure 3.9: *Outline of interview with Prof. LePage*

Summarized interview with Prof. Suzanne LePage:

Prof. LePage began by discussing the MUCTD. MUCTD, or the Manual on Uniform Traffic Control Devices, is a federal manual. It specifies everything related to the traffic light including standardized materials, shapes, sizes, colors, international uniform signs, etc. She explained that the more consistent the SIS model is with the MUCTD standards, the easier it will be to educate the public to the change to the new system with the least amount of collateral damage. She also pointed out that the human factor could not be controlled or fully predicted. Being unfamiliar with the roads of the city might cause bad driving. On the other hand, if the driver was familiar with the roads of a city, predictability factor would help to increase the flow of cars and decrease delay behind since the experienced driver always knows which lane to take.

She also indicated that federal highway data showed that it takes 2 to 2.5 seconds for people to perceive and react to a change in traffic light. Driver perception and reaction time might vary depending on many factors such as weather condition, age category, or time of day. However, real perception time usually falls between 0.6 to 0.9 second. In addition, there is the time people use in order to make decisions such as going straight, left, or right. There is also a car's acceleration reaction time, which can be estimated easily using the laws of motion.

The first cause behind delays at intersections, according to Prof. LePage, was that the system is too static because the time function is pre-assigned for the intersection and only re-assigned from time to time. Second, she also highlighted careless driving as a cause of delay.

She believed the hidden strength of the SIS was the capability to obtain real time data, which will allow the system to optimize the time assigned to the traffic light cycle. She pointed out that the V2V (Vehicle-to-Vehicle) concept is similar to the one developed here in SIS (which will be discussed briefly in the future research recommendations made at the end of this study). The main weaknesses in the SIS that she found were the cost of implementing such a system and the alleged attack on drivers' privacy. She believed that some drivers might resist placing a microchip anywhere on their vehicle. Therefore, she indicated that social resistance would be an obstacle for the implementation of this model.

C. Interview with Mr, Abdulhameed Ali (DAAR):

Figure 3.10 illustrates the outline of the interview conducted with Mr. Abdulhameed Ali:

- **Format interview with Mr. Abdulhameed Ali:**
 - 1) What role do traffic system in general and traffic intersections play in VHB?
 - 2) Introduce SIS (Power Point + Video)
 - 3) Do you think that SIS is feasible?
 - 4) What issues might abstract the flow of SIS?
 - 5) How does the industry of traffic control work, and how much advantage a person will get by knowing or approximating the flow of cars?
 - 6) What challenges would arise from commercializing traffic light system, for example, Ads when people are waiting?
 - 7) In theory, do you believe that the income from commercializing traffic light intersection and selling flow data could cover all the cost of implementing SIS?
 - 8) Do you find any down flaws in the design or optimization technics used by SIS?
 - 9) What are advantages and disadvantages of SIS when comparing to current system?

Figure 3.10: *Outline of interview with Mr. Abdulhameed*

Summarized interview with Mr. Abdullhameed:

Mr. Abdullhameed indicated that the functionality of the SIS physical model depends on the geometrics as well as the placement of the traffic light. He thought there might be a visibility issue since many people now drive SUVs, sedans, trucks, etc. As a result, everyone has a specific line of sight. For example, once a driver becomes accustomed to a line of sight of 20-degree, it is difficult for him/her to adapt immediately to a 45-degree line of sight. He also pointed out that when designing a traffic zone, the designers must think about all of the different age categories. A 50 years old driver might require extra brightness as compared to a 20 years old driver. He thought that a model such as the one introduced by the SIS would be feasible in countries like Japan, which are very welcoming to new ideas. In contrast, he thought it might be very hard to implement the change in the U.S.

Regarding the system's ability to count the number of cars approaching from every direction instantly, he explained that there are people working on this. A woman in China has developed a Bluetooth service capable of this and she is trying to sell it to different states. In fact, this service might be able to collect all traffic information and would be extremely useful. The government, of course, is expected to be a giant customer for this kind of data, and he did not think that it was probable that the government would prohibit the collection of this type of data. If this data is accurately obtained, he believes there will be a change in the role of private business in traffic systems.

He also pointed out that there would be unexpected factors when implanting any new model of traffic light. Therefore, until the system is tested, there will not be enough criticism because the best criticism comes from real life experiences. Furthermore, he did not expect that the new system would increase the flow rate of cars through intersection, but he did think that it would improve the operation of the system unit itself so that it would reach its maximum operational capacity.

Simulation method:

First Scenario:

Under the assumptions of the current control delay, the total flow rate per cycle was 36 cars out of 64. **(Appendix3.2)** On the other hand, under the assumptions of the SIS control delay, the total flow rate per cycle was 58 cars out of 64. **(Appendix3.3)** Therefore, for this scenario, the SIS increased overall flow rate by 61%.

Second Scenario:

Under the assumptions of the current control delay, the total flow rate per cycle was 39 cars out of 80 cars. **(Appendix3.4)** On the other hand, under the assumptions of the SIS control delay, the total flow rate per cycle was 58 cars out of 80. **(Appendix3.5)** Therefore, for this scenario, the SIS increased overall flow rate by 48%.

Third Scenario:

Under the assumptions of the current control delay, the total flow rate per cycle was 38 cars out of 60 cars. **(Appendix3.6)** On the other hand, under the assumptions of the SIS control delay, the total flow rate per cycle was 60 cars out of 60. **(Appendix3.7)** Therefore, for this scenario, the SIS increased overall flow rate by 57%.

Simulation of the new physical model:

All participants in the surveys and interviews agreed that the new model would capture people's attention. In other word, drivers who are already waiting for green light would pay attention and therefore be ready to accelerate as soon the light changed. Also, they agreed that drivers who are approaching the intersection would be able to avoid unnecessary deceleration. This suggests that the SIS will reduce two different types of delay. First, it will reduce drivers' perception-reaction delay, especially for cars at the front of the lane. Second, it will reduce the delay caused by unnecessary deceleration, especially for cars approaching from a farther distance.

Chapter 4

Discussion and Conclusion:

- Discussion of the results.
- Optimizing Smart Intersection System.
- Recommendations for future research.

Discussion of results:

In this section, the two areas of focus of this study are analyzed according to the data obtained. These areas are the physical model of the traffic light and unnecessary delay time at intersections.

Regarding the physical model of traffic light, 25% of surveyed people disagree that the SIS physical model is a good replacement for current model. This percentage of disagreement was the highest as compare to the other questions asked in the survey. One interpretation of this result is that people need to be educated about the new traffic system when it is applied. Also, some people might be afraid of change and would resist a new system in order to keep their older vehicles and habits. In contrast with the survey results, 100% of interviewees preferred new physical model of the SIS over the current one. This perfect percentage indicates how easily the new model can be taught to users Education can take the form of new visual technologies such as videos or PowerPoint slides. Indeed, watching a dynamic visualization of the SIS cycle for the first time was enough for most interviewees to understand the new physical model.

Furthermore, when the five themes were selected for **Table 3.1** in order to construct the survey results, the desirability of the current traditional system was found to be 16%, which was the highest supporting percentage for the current system. Therefore, the SIS physical model needs to have a modern, neat, and clear finish regarding materials, colors, lights type, and curves. However, it has been found that LED lights are the best fit for the SIS because of their high quality and energy efficiency. In addition, the size and dimensions of the new physical model are important factors in order to make the SIS model visible from a farther distance. Therefore, the Manual on Uniform Traffic Control Devices (MUCTD) has to be applied to all new designs in order to receive international approval for the model.

Regarding concerns about traffic light visibility, the biggest concern the study found is when the sun is behind a traffic light and facing the driver. Therefore, the type of material or paint used for the back of traffic light might be a subject to change. Another concern is that each driver has different lines of sight based on the type of vehicle he/she drives, such as a SUV, Sedan, or a truck. In response to this concern, the position of traffic light in the intersection might be a subject to change as well. Furthermore, it has been found that there are two types of drivers who tend to have difficulty with traffic light visibility. They are elderly drivers and colorblind drivers. Therefore, concerns from both groups of drivers must be taken into consideration before the SIS model can be implemented. One final concern is that the direction of the traffic light is a sensitive issue. People tend to take advantage of other traffic lights in the intersection in order to predict when a light change will occur. In response, the position and design of the light are subject to change in the new physical model. Lights will need to be covered from the sides in order to eliminate being seen by drivers from intersecting streets.

Regarding unnecessary delay, 97% of people included in this study agree that synchronizing green lights at intersection is an urgent need. This issue received the highest percentage of agreement. This indicates that people are supportive of any new traffic control system that would minimize their delay time. It also shows how much frustration many people have with the current static system. Also, participants indicated the desirability of adding more counting abilities to traffic lights in order to eliminate driver frustration at intersections. Respondents approved of counting abilities including timers, decreasing light times, and holograms. In addition, the idea of using a microchip was highly approved of by experts in the field as both feasible and efficient. Cost would not be an issue to the implementation of such a system since GPS companies are already working on minimizing the cost of high-speed data transfer. In summation, while the simulations showed that the SIS would increase the flow of cars during a specified

period, a similar system has already been shown to be effective in five cities in the US.

In conclusion, in order to ensure 100% feasibility of the SIS, it must be tested at a real intersection. From experience, the number of scenarios that might happen at an intersection is unpredictable. Furthermore, it has been found there are two ways for applying such smart system to the real world. The first way is by applying mandatory regulations that require all drivers to obey such system. Fines and polices are the basis of such mandatory regulations. However, this method must first deal with the privacy concerns of certain drivers before implementation. The second way smart systems can be applied is by marketing and commercializing the system. The beneficiaries of this system are the drivers. Therefore, drivers can become potential customers for the microchips when they are marketed. Furthermore, commercializing this system might also create new employment opportunities.

Conclusion (Optimum-system):

The first step in optimizing the SIS system was to optimize the physical model. The final model must be large in size and centered in the middle of the street with dimensions and location that are acceptable according to the (MUCTD). All of these modifications ensure that drivers are able to see the lights from a farther distance. In addition, LED lights will be added to the final physical model since they are the most energy efficient. However, considerations must be made as to the visibility of all drivers, especially the elderly and those who might be visually impaired or colorblind. One idea is to have different shapes for green lights and red lights, so the driver can recognize the change in the traffic light without the need to distinguish the colors. The shape of the green light would be any standardized international sign for the action (GO) and the shape of the red light would be any standardized international sign for the action (STOP). See **Figure 4.1** for a developed SIS design that illustrates this.



(**Figure 4.1:** *Developed SIS physical model*

The second step is to optimize the functionality of SIS in order to reduce unnecessary delay efficiently. This study has found that the best option for counting cars at intersections is to employ a cost efficient microchip that is placed in the car or license plates. The microchip is able to send and receive signals only of a car's location. Therefore, no private information, including plate number, car type, and

driver's name, will be stored or sent.. Another simple method would be to use smart phones to send and received data. An efficient smart phone application could be designed for such purpose. Using the idea of a smart phone application would cut a lot of the implementation cost since almost everyone now has a smart phone that sends and receives GPS information.

The third step towards optimization is to construct a database for the SIS system in order to analyze and predict traffic flows as well as to rely on instantaneous, real-life data. This would be possible by connecting all major streets to a single mainframe that analyzes traffic data as it flows. This has already been shown to be feasible by a couple of companies in the field such as Tom Tom GPS.

Furthermore, in order to increase the safety of SIS system, the all-red interval of three seconds for all intersections will need to be included. Furthermore, participants indicated a desire to increase counting abilities at intersections. Therefore, using a hologram to notify the people of the change in traffic light is an effective and safe option. It would also help notifying drivers of the change in traffic light from farther distance since a hologram can be placed anywhere in the streets' lanes and it cannot be hit by a car.

Because of the unpredictable scenarios that might happen at intersection, SIS has to be tested on real intersections in order to ensure 100% feasibility. The MUTCD identifies the steps of the process for experimenting with traffic control devices. **Figure 4.2** illustrates this process in detail. After completing the experimentation process, the SIS model could be approved nationally.

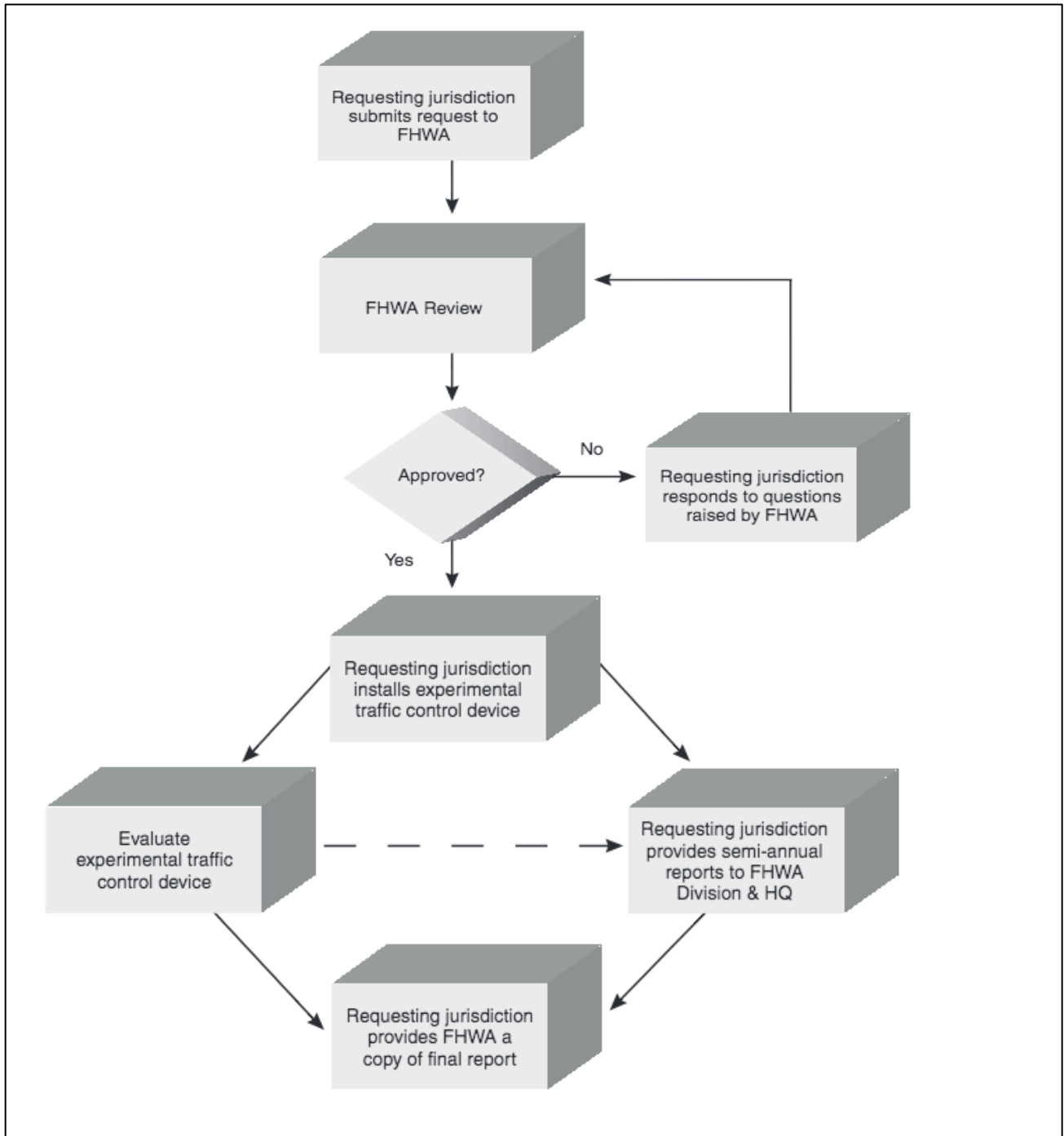

Figure 4.2: *Process for Conducting Experimentations for New Traffic Control Devices*

To conclude, people support the idea of a new traffic system and are willing to try new and smart system. Such a system will save them time and money. Also, it will reduce drivers' irritation since drivers consider the system efficient. It will reduce delay for all vehicles to the optimum. Therefore, total travel time is optimized due to these developments in intersections. Optimizing travel time will reduce the amount of CO₂ affecting the environment. Potentially, this kind of project could generate revenue as well as increase travel quality. The population growth of drivers in the US is larger than the growth in the traffic control industry. The SIS is a suitable replacement for the current traffic light system.

Recommended future Research:

This study indicates several areas of potential future research in order to expand upon its findings:

- Research into determining the exact and optimal dimensions and location for the new SIS model. It is crucial to spend proper time in deciding the size of the new traffic light and the brightness required as well as any related visibility issues. Standards required by the MUTCD must be applied to the model before implementation.
- Research into using an app on a driver's phone as a sensing device that interacts with traffic lights as well as other cars, similar to the V2V and V2X.
- Research regarding the financial advantages of such a system in saving people money and time.
- Research regarding the financial advantages collecting and selling different traffic data. This information could be sold to governments and used to evaluate real-estate values. It could also be used by consulting firms because cars entail drivers who may be potential customers.
- Research into creating capable and powerful traffic management software that is intelligent enough for the task at hand.

References:

- 1- Bellis, Mary. "History of Roads - Inventions for Traffic Management." *About.com Inventors*. About.com, 27 May 2014. Web. 23 June 2014.
<http://inventors.about.com/od/rstartinventions/a/History-Of-Roads.htm>
- 2- Schrank, David , Bill Eisele, and Tim Lomax . "TTI's 2012 URBAN MOBILITY REPORT ." *INRIX Traffic Data* 1 (2012): 63. *mobility.tamu.edu*. Web. 25 June 2014.
- 3- Kotwal, Ashley Russell , Soon Jae Lee, and Yoo Jae Kim. "Science and Technology 2013, Department of Engineering Technology, Texas State University." *Traffic Signal Systems: A Review of Current Technology in the United States* 1 (2013): 33-41. *sapub.org*. Web. 25 June 2014.
- 4- "Summary of LED and Traffic Signal Technology | Transportation Lighting | Programs | LRC." *Summary of LED and Traffic Signal Technology | Transportation Lighting | Programs | LRC*. N.p., n.d. Web. 25 June 2014.
<http://www.lrc.rpi.edu/programs/transportation/led/LEDTrafficSignal.asp>
- 5- Birdsall, Michelle. "Google and ITE. The Road Ahead for Self-Driving Cars." *ITE* May (2014): n. pag. *www.ite.org*. Web. 17 June 2014.
- 6- "Traffic Signal 101." *National Transportation Operations Coalition* 1 (2012): 2. *www.ite.org*. Web. 20 July 2014.
- 7- SELINGER, MATT, and LUKE SCHMIDT. "'Adaptive Traffic Control Systems in the United States: Updated Summary and Comparison'." *HDR, Inc.*. N.p., n.d. Web. 20 July 2014.
<http://www.hdrinc.com/about-hdr/knowledge-center/white-papers/2010-adaptive-traffic-control-systems-in-the-united-states-u>
- 8- "TomTom." *TomTom*. N.p., n.d. Web. 25 June 2014.
http://www.tomtom.com/en_us/
- 9- "V2X Communications: fast forward." *Traffic Technology International* May 2014: 32-38. Print.
- 10- Kalton, Graham. *Introduction to survey sampling*. Beverly Hills: Sage Publications, 1983. Print.
- 11- "Men vs. Women: Who Are Safer Drivers?." *CBSNews*. CBS Interactive, n.d. Web. 4 June 2014.
- 12- "How much will Your Auto Insurance Premium Decrease after 25." *CarsDirect*. N.p., n.d. Web. 5 June 2014.
<http://www.carsdirect.com/car-insurance/how-much-will-your-auto-insurance-premium-decrease-after-25>
- 13- "Older drivers." *Q&As*. N.p., n.d. Web. 5 June 2014.
<http://www.iihs.org/iihs/topics/t/older-drivers/qanda>
- 14- "Licensed Drivers by Age and Sex (In Thousands)." *Licensed Drivers by Age and Sex (In Thousands)*. N.p., n.d. Web. 5 June 2014.
<http://www.fhwa.dot.gov/ohim/onh00/bar>
- 15- "Sample Size Calculator." - *Confidence Level, Confidence Interval, Sample Size, Population Size, Relevant Population*. N.p., n.d. Web. 5 June 2014.
<http://www.surveysystem.com/sscalc.htm>
- 16- "Qualtrics Research Suite." *WPI Teaching with Technology Collaboratory* -. N.p., n.d. Web. 5 June 2014.
<http://www.wpi.edu/Academics/ATC/Collaboratory/HowTo/Qualtrics/>
- 17- "SMART SURVEY DESIGN ." *Survey Monkey* 1 (2011): 34.//*www.surveymonkey.com*. Web. 5 May 2014.
- 18- Seibert, Therese. "Designing Surveys That Count." *Keene State College* 1 (2002): 31. Print.
- 19- Brace, Ian. *Questionnaire Design: How to Plan, Structure and Write Survey Material for Effective Market Research*. 3. ed. London: Kogan Page, 2013. Print.
- 20- Boyer, Susan, and Mark Stron. "Best Practices for Improving Survey Participation." *Oracle An Oracle Best Practice Guide* (2012): 21. Print.

- 21-Nazirova, Saadat. "Survey On Spam Filtering Techniques." *Communications and Network* 03.03 (2011): 153-160. Print.
- 22-Harrison, Chase. "TIP SHEET ON QUESTION WORDING." *Harvard University Program of Survey Research* 1 (2007): 4. Print.
- 23-Silverman, David. *Interpreting qualitative data: methods for analyzing talk, text and interaction*. 3. ed. London: SAGE, 2006. Print.
- 24-DiCicco-Bloom, Barbara, and Benjamin F Crabtree. "The Qualitative Research Interview." *Medical Education* 40.4 (2006): 314-321. Print.
- 25-Rowley, Jennifer. "Conducting research interviews." *Management Research Review* 35.3/4 (2012): 260-271. Print.
- 26-Hartocollis, Anemona. "For Women Who Drive, The Stereotypes Die Hard." *The New York Times*. The New York Times, 17 Aug. 2010. Web. 25 June 2014.
<http://www.nytimes.com/2010/08/18/nyr>
- 27-Papacostas, C. S.. *Fundamentals of transportation engineering*. Englewood Cliffs, NJ: Prentice-Hall, 1987. Print.
- 28-*HCM 2010: highway capacity manual*.. 5th ed. Washington, D.C.: Transportation Research Board, 2010. Print.
- 29-Tom V, Mathew. (February 2014). Signalized Intersection Delay Models. Department of Civil Engineering at Indian Institute of Technology, Bombay.
- 30-"Traffic Volume Counts." *Traffic Volume Counts*. N.p., n.d. Web. 18 June 2014.
<http://www.mhd.state.ma.us/default.asp?pgid=content/traffic01&sid=about>
- 31-Kelton, W. David, Randall P. Sadowski, and Deborah A. Sadowski. *Simulation with Arena*. Boston, Mass.: WCB/McGraw-Hill, 1998. Print.

Appendix:

Appendix (1):

(Appendix 1.1)



(1)



(2)



(3)



(4)



(5)



(6)



(7)



(8)



(9)



(10)



(11)



(12)



(13)



(14)



(15)



(15)

(Appendix 1.2)

This is a survey for the IQP project Smart Intersection System:

- First category: Please connect the system flow chart:

(6 pictures of the physical model would be placed here)

- Second Category: (multiple-choice questions):

Question	Strongly agree	Agree	Disagree	Strongly disagree
Do you feel that the suggested traffic signals are a good replacement for the current traffic signals, and that they would present a more civilized image?				
Do you think that synchronizing green lights according to traffic at intersections is a good idea?				
Do you agree that some drivers take a long time to move at the turn of a green light?				
Do you feel that knowing when to expect a green light would help solve the previous problem?				
Do you believe that the current traffic lights system could be better adjusted in dealing with critical weather conditions?				
Do you believe that the current traffic lights system could be better adjusted in dealing with critical weather conditions?				
Do you think that Smart Intersection System, as explained earlier, would reduce traffic jams and accidents at intersections?				

- Third category: (Open-Ended questions)

Q1: What method do you propose in distributing green light time on intersections?

Q2: What kind of method would you propose in counting cars at intersections?

Appendix (2):

(Appendix 2.1)

Interview (1):

Joquin, from a nursing home in Worcester is a male above 65 years old.

- **Category of physical model:**
Joquin liked the concept of SIS model that had shown by the PowerPoint slides. He said it is better than the current one that small regarding size. Additionally, a shortcoming of the current system is that it changes very fast. Also, he believes that SIS conceptual model is a solid model to replace the current system since it withdraws driver's attention by its counting abilities.
- **Category of delay issues:**
Joquin does not think that he usually delays other people, and it happens only in emergency cases. On other hand, when people delay him, Joquin tend to be not irritated because of his 60 years of experience of driving. However, he believes that the major causes behind delay are careless drivers, who need more education, and media and movies that tend to build aggressive driver personality.
- **Category of lost green time:**
Joquin admitted the problem shown in the video of lost green time, and recognized that one car only has passed during 20 seconds. He also emphasize that since the current system that does not optimize the destruction of time, careless drivers tend to over smart the system because they know it is designed under certain functions and systematic approaches.
- **Category of Extreme weather conditions:**
Joquin said that people should seriously consider making adjustments on the current system to deal with cases of extreme weather conditions. And they should be expect the change and be aware of it.
- **Extra Question:**
Joquin suggested that traffic lights must be large to cope with elderly people. Also, they always have to be placed in the middle.
- **Additional suggestions:**
Joquin advised project team to go and visit a traffic control office because he obviously acknowledges that there is a lot of area to develop in the current system.

Interview (2):

Shikhah is a female WPI student, who falls in the age category of (16-24) years old. Interview with Shikhah has been done in the library.

- **Category of physical model:**

Shikhah said that the SIS model shown in the slides was interesting because it has different capabilities of counting down. Furthermore, she believes that drivers should not be impatient anymore because SIS model shows that expected time for the traffic light to change from and to different stages. Also, she mentioned that SIS model obviously help drivers see the change from further distance since it is possible to approximate the time by staring at the lines of the traffic light. Shikhah emphasized that the height of traffic light should be measured, and calculated under scientific methods because it is one of the major flaws of the current traffic light that needed change. She also suggested that size, colors, and lights type are other areas to change in the current traffic light.

- **Category of delay issues:**

Shikhah usually feels bad when she delays other drivers at an intersection, and she easily gets nervous and not focusing because of drivers' honks. In the other hand, She feels very frustrated when she is delayed by other driver in an intersection because mostly she could not confirm if the delay is caused by the car in front of her car or other car much further. However, Shikhah believes that having distractions such as texting and phone calls are some of the reasons behind delay at intersection. Also, in some cases, the first car in the line is not notified enough by the change in the traffic light. As a solution, Shikhah thinks that education is the first step to overcome the problem of delay. Also, fixing the current model to have more counting abilities is a major solution to the problem. In the end, she said that using the lines of the light of SIS traffic light would bring drivers attention, which itself would eliminate some other distractions.

- **Category of lost green time:**

Shikhah acknowledged the problem of lost green time shown in the video, and she asks if this situation might happen because the intersection shown was not busy at that time. However, Shikhah instantly thought about a current solution that is used in her country; Nepal. The solution is to place a traffic control officer or a policeman at busy intersections to control the flow from the intersection itself. She believes that this solution would help accelerate the flow since the person in control has better estimation of the flow in the four directions at an intersection, but it is not cost efficient. Finally, Shikhah said that using smart system to count cars would definitely solve the problem of bad distribution of green light because of since and technology.

- **Category of Extreme weather conditions:**
Shikhah focused in a special case of extreme weather situation that is highways. Under heavy snow, highways usually are extremely dangerous to drive because they are slippery and not cleaned fast. Optimal cleaning time and optimal cleaning process are two areas that have to be focused on by people in charge.
- **Extra Question:**
Shikhah said that different situations are different, and different people are different, and drivers' level of relaxation is not the subject to talk about. In the other hand, having more cautious drivers is more important.
- **Additional suggestions:**
How you are going to deal with people crossing the street.

Interview (3):

- **Khalid Al-Zahrani is a P.H.D student at WPI studying, who falls in the age category of (25-64) years old. The interview with Khalid was in Panera Bread Coffee in Worcester.**

- **Category of physical model:**
Khalid first thought about SIS model is that its special advantage is the variety of the counting down methods used in the model. This ability would make people more patient when they are waiting for a traffic light change. He also mentioned that traffic light must consist of green, red, and orange, where the model shown consists of yellow instead of green. Furthermore, Khalid disagree that this model can help people to see the change of traffic light from further distance because there is nothing to indicate the size of the model shown by Power Point. To sum the talk about the physical model, Khalid suggested changes to the current system is to have smart system that figure what directions have cars and the ones do not.
- **Category of delay issues:**
Khalid always feels very bad when delaying other drivers behind him, and he always feels uncomfortable when there is a pile of cars behind him. In the other hand, he also get annoyed when other drivers delay him, and he stated different causes behind such delays at intersections. They are smart phones distraction, old people slow reaction, and some out of control causes like blocked intersections. Khalid suggests adding more extreme polices and fines to control intersections and reduce delay. However, people do not have to be blamed all the time for delay issues, and engaging more technological tools to notify drivers of the change in traffic light such as using sound effects.

- **Category of lost green time:**
Khalid acknowledged the problem of lost green time that is shown in the video, and he thinks that sensors must be used to reduce lost green time by decide priorities between the four directions. In addition, Khalid agreed that using automated system to count cars at intersections since it would give the optimal time distribution.
- **Category of Extreme weather conditions:**
Khalid said that people tend to need more time to move and stop their vehicles during extreme weather conditions. And he placed an interesting question if wither the current system has some adjustments or rules to apply during extreme weather conditions. All in all, Khalid believe that people behavior is the major area to focus on when studying the flow during extreme weather conditions
- **Extra Question:**
Khalid agreed that the flow rate of cars can be accelerated at intersections, but there might be two flaws. First, old people reaction cannot cope with the acceleration comparing with young drivers. Second, the level of safety might be reduced
- **Additional suggestions:**
He placed an interesting question if wither the current system has some adjustments or rules to apply during extreme weather conditions.

Interview (4):

- **Abbass is a WPI undergraduate studying Industrial Engineering, who falls in the age category of (16-24) years old.**

- **Category of physical model:**
Abbass said that the size and the dimensions of the model shown are the factors that should be considered for notifying people from further distance. He thinks that bigger display would help to overcome. In addition, Abbass said that current model is working well regarding visibility.
- **Category of delay issues:**
Abbass usually get annoyed and frustrated when other drivers delay him, but it also depend on the period of delay. In the other hand, he is not used to delay other drivers, and he always believes that there is at least one driver behind him is in hurry. Some reasons of the delay are sell phones, texting, and external distraction such as people crossing the street. In order to overcome the problem, drivers should pay more attention to the change of traffic light rather than focusing on their phones and other distractions.

Other method such as timers that counts down is one suggested addition to the current traffic lights at intersections.

- **Category of lost green time:**
Abbass acknowledges the problem of lost green time shown in the video. Methods such as sensors can be used to overcome the problem. He also believes in the idea of smart system. However, when the system recognize and count the flow rate at intersections, Abbass thinks that such system would be greatly helpful unless it is not financially attractive
- **Category of Extreme weather conditions:**
Abbass said that people already adjust their behavior during extreme weather conditions to make street safer.
- **Extra Question:**
Abbass believes that flow rate at intersections can be accelerated, and he does not believe that time distribution of traffic lights is a subject that is updated based on factors such as the change of the population

Interview (5):

Mohammed Al-Rifiai is a WPI alumni majoring in Computer Science, who is currently working in IBM Company. He falls in the age category of (25-64) years old.

- **Category of physical model:**
Mohammed said that the model shown in the slides is interesting and useful since it has the ability of counting down by its light bars. He strongly thinks that size is a major missing factor to determine if the traffic light would help notifying people from further distance. He believe that have counting down lighting bars would help drivers to make easier decisions since the driver can easily estimate the time remaining. Also, number of people who pass the traffic light on red would be reduced because people would be notified by the change from further distance. Additions such as using hologram can be added to the current system to notify people of the change in traffic light. For example, it can be used as huge timer in the middle.
- **Category of delay issues:**
Mohammed usually feels bad when other drivers delay him. In the other hand, he is not used to delay the traffic. Some reasons such as dropping a passenger, or cell phone are behind the delay at intersections. However, it mostly depends on the period of delay time. In order to overcome the delay problem, using a smart system that can evaluate the traffic to assign different time for the four directions would results fast cycles. People would become more focusing on the traffic light since it is smart and helps drivers to move

as fast as possible. Finally, intelligent and smart cars eventually would fill the streets, which should redirect all research toward machines not human beings. Linking traffic lights with these smart cars would definitely be infinite solution, which also does not on the details such as color or shape of traffic light. One day, human being may not need traffic light at all.

- **Category of lost green time:**
Mohammed acknowledges the problem of waste green time and he notice how the street was empty for 20 seconds with only one car passed. Alternatively, he strongly suggest altering all traffic lights by smart ones that have sensors stops the flow of the empty direction by a red light. Furthermore, smart systems that can count cars at intersections for the purpose of time distribution is a feasible solution to overcome the problem of waste green time.
- **Extra Question:**
It is possible to accelerate the flow rate of cars at intersections.
- **Additional suggestions:**
As an engineer, Mohammed believes that currently human beings have the tools to build smart system such as SIS, but there is not much effort toward this type of projects.

Interview (6):

Prof. Scott Jiusto is an associate professor works at WPI, and a project director at Interdisciplinary & Global Studies Division. The Interview took place in Prof. Scott's Office.

- **Category of physical model:**
Prof. Scott said that the model is intuitive and easy to understand, but he is color blinded and sometime green and red can be an issue. Using symmetrical shape of the traffic light from left to right would not solve the problem for color-blinded people. International symbols for GO and STOP actions might be engaged in the design of the traffic light to help color blinded people. For example, including cross symbol in the design for red light. Furthermore, size is the most important factor to determine if this model would help notifying people from further distance. Changes such as counting down timer and lighting lines are perfect tools to make the information travel to further distance. Using flashes won't help notifying people with color blinding.
- **Category of delay issues:**
Prof. Scott admitted that he hates when someone delays him, and feel bad because of that. In the other hand, he feels embarrassed when he delayed

other. In order to overcome the problem of delay, traffic optimization studies are the best road to the roots of the problem. However, Prof. Scott encourages people to look through intersection before moving in order to avoid accidents. Also, he believes that encouraging people to look to the various changes at the intersection should be the focus area rather than motivate them to accelerate by notify them of the change earlier. If the cars are driving themselves, people do not have to worry about noticing the change of traffic light, but there will be other expenses. Also, changing traffic lights to LED lights was one of the huge breakthroughs of the design of the current traffic light. So, Energy efficiency of SIS model is a major determinant factor to compare with the current system since the main reason of this project is reduce gas consumption and carbon footprint.

- **Category of lost green time:**
Prof. Scott Acknowledge the problem of lost green time, and one car only has passed during the 20 seconds of green light. Smarter traffic light would be a better solution to deal with these scenarios, and it is a good step to take because of the revolution of smart and intelligent cars. Moreover, a system that recognizes the flow of cars automatically would be a smart move since smart cars have been introduced.
- **Category of Extreme weather conditions:**
People already tend to pay more attention in these cases, especially if they are living in an area that is expected to have such conditions. Education is solution to overcome this problem.

Interview (7):

Marylou Horanzy is a female working in WPI. She falls in the age category of (25-64) years old.

- **Category of physical model:**
Marylou thinks that SIS model shown by Power Point is Bright and representable. She understands the purpose of the new model, but she really get used to the current circular model. Size is the main factor that determines if SIS model would help from further distance or not. Moreover, she said that time of the transitional periods between traffic light stages must be increased in the current system in order to notify people of the change of traffic light.
- **Category of delay issues:**
Marylou mostly is very patient, so she does not tend to delay other drivers. Also, she thinks that the reason behind this delay is that human beings tend to be multitask inside the car, which is distraction by itself. In order to

overcome this problem, sound effects are the best method to notify people since they already use honks.

- **Category of lost green time:**
Marylou admitted the problem of lost green time shown in the video, but she thinks that capacity of cars is related to the time during the day. Furthermore, to solve the problem, intersections should have better time distribution since it is related to the capacity of in the intersection. This adjustment of green light time would result in a quick cycles. Finally, Marylou said that a smart system that recognizes the flow by itself is would get people attention since they know that that system is by their side.
- **Category of Extreme weather conditions:**
Marylou said that people already are driving slower during extreme weather conditions.
- **Extra Question:**
Yes, having more relaxed drivers would defiantly increase the flow rate through an intersection.

Interview (8):

Lynne Riley is a Research and Instruction Librarian at WPI Library, and she is a female who fall in the age category of (25-64) years old.

- **Category of physical model:**
Lynne thought that the physical model of SIS proves as a good replacement for the current system, even though she feels comfortable with the current system because she is used to it. She also thought that the traffic light should be centered in the middle of the rode for best visibility. The increase of the size of current traffic light was also mentioned as a solution for visibility at a further distance.
- **Category of delay issues:**
Lynne doesn't necessary feel bothered when delayed. However, she does not like it especially when on a timeline. On the other hand, she feels guilty when delaying people. In order to overcome delay issues, Lynne said that people must pay more attention when at an intersection and not get distracted. One great idea she had is using holograms as a method of notifying people of the change of traffic light instead of the classic convention of traffic colors.
- **Category of lost green time:**
She acknowledges the problem displayed in the video as lost green time.

Distributing time more efficiently between the streets could solve the problem. Furthermore, she agrees that a smart system that reads the flow could distribute time in a better fashion thus saving green time.

- **Category of Extreme weather conditions:**
She thought very little could be adjusted with traffic lights in extreme weather conditions. Snow would be an example where deicers are in effect.
- **Extra Question:**
She thought that relaxed drives would make for better streets as long as they are paying all the attention they are supposed to

Interview (9):

Marry, from a nursing home in Worcester is a female above 65 years old.

- **Category of physical model:**
Marry liked the new physical module a lot because it is large and had a good display of when the traffic light will change. Also, she believes if it was large enough and clear it will help to see at a further distance.
- **Category of delay issues:**
Marry doesn't get angry, but a little annoyed of inconsiderate people. On the other hand, she doesn't feel comfortable when delaying other people, which cause her to rush and make quick decision. She also thought that delay is difficult to overcome but if people pay more attention it would help. In addition, she said large traffic light helps for people to pay attention. Other solution, using sounds to indicate a change in traffic light.
- **Category of lost green time:**
She sees that there is a loss in green time with current system, but it is difficult to solve the problem. She also agrees that a smart system with technology could help the flow of cars as long as it doesn't make the change in signals too fast.
- **Extra Question:**
Marry recommended making the transition of lights slower to give people all the time they need to stop or go, and making traffic lights larger and centered for better visibility. Finally, she believes that drivers should have more patience this will lead to better flow with fewer accidents

Interview (10):

Kathryn is an employer at subway downtown of Worcester, who falls in the age category of (25-64) years old.

- **Category of physical model:**
Kathryn Liked the new SI model shown because it gives more details. It would be more feasible if its size were larger than the current traffic light. The large size with details would help people to decide whether to speed up or slow down as they approach the traffic light.
- **Category of delay issues:**
Kathryn sometimes feels frustrated when delayed, but it always depends on her mode when driving. On the other hand, she feels bad when delaying other people, which only happen when necessary. She said that it is difficult to overcome delay because it is usually out of control delay. The cause behind delay issues could be that people are distracted and don't notice the change of signal right away where other people honk the horn to notify them when it happens.
- **Category of lost green time:**
Kathryn acknowledged the problem of lost green time in video. She also admitted that using technology is one way to solve the problem, using sensors in the streets. Therefore, SIS can solve the problem very well.
- **Category of Extreme weather conditions:**
In critical weather conditions, few people would be in streets driving and most likely at slow speeds where traffic lights could notify traffic with red if there is someone in the intersection to show that they will have to yield.
- **Extra Question:**
Relaxed drivers would reflect positively on driving atmosphere to create less stress and more attention to driving.

(Appendix 2.2)

Interview (1): (A person in the field of traffic control):

Joseph F. Borbone, Director of Engineering at the Department of public works and Parks, the city of Worcester.

- **(Physical model)**
The physical model of SIS is very interesting. What is MUTCD? It is a manual on uniform traffic control devices. This manual has international excepted standardizations about all pieces of traffic control such as stop sign, and traffic light. The MUTCD should be changed to include the standardizations of SIS model, and after that, the implementation of SIS. Also, this manual gets updated all the time by the new symbols and standards such as some of the new traffic symbols that used near schools these days.
- **(Problems with current traffic system at intersections)**
The current system works very well, and the biggest problem is related to the signal itself. There are many problem related to the current model of traffic light. First, when the sun behind it, the driver facing the traffic light cannot see the signal. Second, each signal must be seen from one side only not from the adjacent sides. Other lanes must not be misled by other traffic signals for different lanes in different direction. An old system was built by Treyam Co. that has couple filters that prevents the lenses from being seen from the sides; same technology used for TVs. Now days, loafers are used to cover the lens and direct it only toward one direction. Also, based on the manual, two signals must face the coming traffic always.
- **(Lost green time)**
At these situations similar to the video, detectors are used to detect if the street with green light has cars approaching to enter the intersection, and when there is not any car the detectors switch the green light to the next direction. Also, backup plan on the computer is used. If one car enters the intersection, the computer holds the green light for a while so the yellow or red light won't surprise the next approaching car at speed such as 30 mph. It will be better if there is way to detect cars further back in the lane, so computer would give more accurate decisions.
- **(Do some drivers take long time to move at the green light?)**
Yes, I do. Usually, the first car always takes longer time to move when traffic light is green.

- **(Would SIS be a good replacement of the current system at intersections?)**

It seems to be a really good and interesting idea, but it is better if it is tested on the field. As example, now days, count down pedestrian light is used in traffic lights. In the old days, it was just green, and red for walk and not walk respectively. Then, these color turned to the known symbols of pedestrian. However, people specially the elders like the countdown pedestrian light, and they sent a lot of amazing supportive feedbacks about it. On the side, drivers in the intersection are using these pedestrian count down timers to predict the time left for their green time because they know that their light will turn to green as soon as the pedestrian counting down timer reaches zero. This attitude from the drivers was not expected, but it shows a positive indicator, which is they are paying attention to the traffic light. For example, if the first car in the line is monitoring this pedestrian timer, it will take less time than usual. In the bad side, sometimes the first driver accelerates the car when the pedestrian timer reach zero, and the green light opens for other direction.

However, having a countdown for the drivers would help to eliminate the frustration from the waiting drivers, and make them pay attention to the traffic light because of the advantage of the timer given to them.

It is important to now couple factors in order to ensure that SIS model is visible from further distance. First, the size is a major factor. Second, the type of lights used; expecting LED lights.

- **(What type of traffic control is used in Worcester; Classic control rooms, or smart system?)**

Each of the computers at the intersections has some design built on it to make specific decisions based on the detectors linked with it. Also, some intersections, such as Highland and west, have video cameras that count shadows of cars in each direction and then sent these data to the computer. After that, the computer would make decisions based on the number of cars in each direction. Therefore, the counting sensors idea is already implemented in somehow.

- **(Placing microchip inside the vehicle to receive and send signals to and from the approaching traffic light)**

Implanting microchip in cars to work as sensors is not that costly idea. GBS companies such as Tom Tom are using individuals' GBS devices to send and receive signals. Therefore, if a car slows down due to traffic delay, Tom Tom central computer receives a signal from the delayed cars and then sent it to the approaching cars with Tom Tom GBS devices to alert them from the delay in front. So, the technology is already out there!

- **(What additional areas should be considered when optimizing traffic system at intersections?)**

The technology for detection must be upgraded as soon as possible. The biggest problem is being able to know what happening at each leg of the intersection since some intersections have more than four legs. Therefore, upgrading detecting tools would help to make fast decision since the computer is able to detect what happening fast enough. On the other hand, using the classic control rooms is not a bad thing, but it could be considered as waste of resource when comparing to computers, which can do multitasks rather than one. All of the controllers for all signals are built specifically for this single reason, which show some restrictive aspects.

- **(Using Smart system that is connected and integrated, so all controllers of all signals would send and receive data to each other immediately, and learn from day-to-day data)**

It is an interesting idea because the same people everyday use a lot of intersections. So, the computer has to be able to learn from day-by-day flows and also adapt when something unusual happens. Furthermore, fail-safe system must be built in. it is impossible to get two green lights at a conflict point at the same time, and when it happens, all traffic lights shut down to red immediately and automatically to prevent accidents, which is a nice fail system.

- **(Coordinated system)**

In Shrewsbury Street, six traffic signals are connected together, and each one has its own computer. There is a master computer that watches all these single computers. The task for this central computer is to make sure that flow is moving in Shrewsbury Street as efficient as possible with a priority given always to Shrewsbury Street.

- **(All red light intervals)**

In the old days, when a direction got the green light, the other direction turns to red instantaneously. Now days, this system is not applied anymore because there are some people who approaching the yellow light with 30 mph and then take a portion of the red light. In such cases, accidents happen a lot. What is currently applied is a lag of three seconds where everybody has red light. This is called all red light intervals, and it happens between each transition.

Interview (2): (An academic on the field):

Professor, Suzanne LePage is a professor in civil and environmental engineering department in Worcester Polytechnic institute.

- **(Highway capacity software)**

It is already built software. User needs to enter the incoming capacity of cars coming to the intersection from different directions. These data are available especially in Worcester. The output of the simulation is a serves rate. For example, the serves of the whole intersection is given a rate of C. After that, each single direction is also given a rate such as A, B, C, D, E, and F. A means that this direction is not causing a problem for the intersection and its serves level is excellent. When a direction has low serves rate, it means this direction dragging the whole serves of the intersection down. Then, user starts to analyze the roots of the problem such as insufficient green time, or high capacity of left turner who need higher priority in the cycle. Usually, after making such adjustment in the simulation, the new output will yield to A, B, or C for all directions. This software includes all complex factors that might be included in the simulated intersection such as number of lanes, are there car parks in the sides? How many pedestrian are there in the intersection? And the width of the lanes. It also includes four to five delay types. First, uniform delay is a pre-assigned function that includes the green time for each direction, and the whole cycle length. Second, incremental delay, total control delay, residual demand delay. Also, the simulation software already has the smart detecting system as a tool called actuation system.

- **(Inputs Data for simulation)**

There are data for real intersection in a form called (Turning Movements Counts). These data can be obtained from Central Mass Regional Planning Commission (CMRPC). However, other way to obtain traffic data at intersections is to count cars for 15 minutes only, and then factor these data based on the season, time, peak hours, and etc.

- **(Using Smart system that is connected and integrated, so all controllers of all signals would send and receive data to each other immediately, and learn from day-to-day data)**

Probably, city of Worcester has something similar system. Cities that are grown recently might already considered such system such as Dubai, or Los Angeles. Actually, V2V concept has similar idea to the one presented in SIS.

- **(Physical model of SIS)**

How would you deal with the exclusive left turn? In some cases people can turn left in both situation when the arrow is yellow or green.

- **(MUCTD)**

MUCTD refers for Manual on uniform traffic control devices, which is a federal manual. This manual specify everything related to the traffic light such as the material, shapes, sizes, colors, international uniform signs, and etc. the more consistent is the model with MUCTD, the easier public is educated and adapted to the change. The reasoning behind this manual should be clarified in this paper.

- **(What method would you use to collect data at intersection?)**

Available data can be collected from the Internet. Also, there are data collection units that have buttons in it to count cars at each direction manually. The longer time the data collection, the more valuable are these data.

- **(How would you deal with delay issues at intersection?)**

Simulation must be run to figure out what direction causing the problem to the intersection. After that, analyzing the causes behind the delay at that direction such as insufficient green time, complied left turners, or etc. However, regarding drivers, federal highway requires 2 second or 2.5 second as people perception reaction time to the change of traffic light. Perception reaction might change based on many factors such as weather condition, age category, or time during the day. However, the real perception time usually fall between 0.6 to 0.9 second. Also, there is the time people consume to make decisions such as going strait, left, or right. In addition, there is car's acceleration time, which can be estimated easily by physics.

- **(How would criticize the current system at intersection?)**

The first problem is that the system is too static, which means that the time function is pre-assigned for the intersection, and re-assigned from time to time. The second problem is bad driving. Being unfamiliar with the roads of the city might cause bad driving. On the other hand, if the driver is familiar with roads of the city, predictability factor would help to increase the flow of cars, and decrease delay behind since the driver always know which lane to take. Therefore, traffic signs, and conventions have to consistent and standardized to help driver unfamiliar with the environment. The point is that human factor cannot be controlled by the design to reduce delay.

- **(What strengths and weaknesses do you find in SIS?)**

The main strength of SIS is the capability to obtain real time data, which mean the time assigned is optimum. The main weaknesses are the cost, and

driver's privacy. Asking drivers to place a microchip anywhere in their vehicles might face some resistance from some drivers. Therefore, social resistance is a big obstacle for this model.

Interview (3): (a privet-sector point view on the field):

Abdulhameed Ali PE established in 2001 a civil engineering consulting firm that offers a range of design and construction management services to public and private sector clients. This firm called DAAR.

- **(What role does DAAR corporate play in the systems of traffic control in general)?**

Well, we had a contract run practical operation center in Milwaukee, which basically receives data from the state of Wisconsin, and then analyze this traffic data. So the state has changeover I would say the last 20 years what they want to use that data for. At the beginning they put all of the interstate systems traffic, speed, gate control, ramps going in. And what they noticed was that ramps going in are permissible to have people coming in, and the gates people complained about putting signals to join the traffic. So, they put that in contract with the law enforcement. When accidents happen and they have cameras out, someone would call the closest law enforcement to clear the accident. They have used many different software for that. But now they are including more information coming from the pavement sensors to have them ready for the automated vehicles like Google Mobile coming in. So, we have not had that contract in the last 40 years, and it is coming up. We are trying to compete for that. Now they are trying to install helpful tools in the pavement like for the buses; they have tested buses in California where the bus does not need traffic light. The bus system would recognize where people are waiting and where to stop by.

- **(When do you think cars are going to drive themselves in public?)**
That is tough to say. I think California would have something like that in the next five years.

- **What do you think of the flow of the traffic light, the physical model that is shown in power point slides?**

I missing a few slides, but I think I can see how the sequence works.

- **(How you would criticize or develop or maybe support this model?)**

Well, for it to work, it depends on the geometrics where you are placing. Let us say the city you are located in. Where are you located right now? If you are in a vertical road, you are coming from the bottom of a hill. How would your

eyesight be affected? You would not see all of the lights. Imagine you are in an inclined road, or maybe driving a truck. There is visibility issue. If you drive today, look at how you look at it. People drive SUVs, sedans, trucks, etc. Everyone would have a line of sight. And when you have that line of sight, it is very tough for your brain to change. Let's say your line of sight is 20 degrees, and all of a sudden I tell you that you should look at 45 degrees.

It could change, but it would take a while. And the age group should be taken into account especially when the age is advanced. Traffic light was not my expertise, but I took one traffic class, and the guys who came were telling us when you are designing a traffic zone, you have to think about anybody that is at my age right now. I am 50 years old. I cannot see as well as you. My eyes are not going to absorb, I need more light that you do. So, when it comes to light, the brightness of the light will affect different people. Twenty years old you will be fine, but if a 60 years old is driving the car, the brightness will affect. So you have to consider the age group, comfort of looking at it, and the geometry of the places.

- **(So maybe from another angle, you said at inclines; maybe it is not going to be very helpful for people to see it?)**

No, I think this would be feasible in countries that are like Japan. Japan is very welcoming to new ideas. In the U.S, it is going to be very hard. I think in America for to it works, it would take some time. I remember working for the government here when they introduced roundabouts, although it was demonstrated better than stop signs. It was very hard for the people to be implemented.

- **(That is very interesting. In Worcester, we have a street with four intersecting streets not two at one intersection and the people refused to put a roundabout)**

Yes! I remember going to public information meeting; we had a demonstration to show them how the traffic is going to flow. And it included existing traffic data showing the delay and how it is going to be comfortable. But then, these people had limits, like farmers coming in if they see a roundabout they would not be sure whether to go in or stop. But, now they like it after 20 years in Wisconsin. I think your design can be implemented in countries like China and Japan, but the U.S I do not know.

- **(Do you believe that a system that can read how many cars that are in every street, and if I know how many cars there are in every street, do you believe that this information can be used and sold?)**

Yes, there are people doing that. A Chinese lady has developed a Bluetooth service and she is trying to sell to states. They collect all traffic information from here. That is very useful.

- **(What challenges might arise from commercializing this kind of data? Would the government have issues with it? Or would the government be one potential customer?)**

The government could be a customer.

- **(Would they have any issues to obstruct this, as this company should not know this kind of data?)**

I do not know, but I do not think so because there are many people that are selling any kind of data. I do not think that this would be an issue.

- **(If possible, could you take a look at the video that I sent?)**

Sure. Yes I saw it.

- **(The video is 20 seconds long and only one car passed through. This shows us that there is a definite problem with the distribution of the green time and this is an existing problem. This was a random traffic light at a random time that we noticed that there is a problem with. Just to show the idea of a smarter second system. We want to implement a system that can read how many cars exist at every traffic light at every time. By knowing that, every traffic light is going to know how many cars are approaching before they get there based on the data from the traffic lights before. We were thinking about a more systematic approach to the problem. So we know the flow of cars in every street, and every traffic light by itself is aware of how many cars are approaching from every direction. From that it should distribute green time at every direction. The idea that we have is a system that can develop itself by knowing the flow from every day. If we implement the system today, one year from it will have data of one year).**

That would be a great idea, but what happens if unexpected situations happen? Let's say that the traffic going north is heavy and the traffic going west is heavy too.

- **(There different algorithms that are applied to make the system definitely not go to these specific glitches. These are going to be put in effect. But, the idea we have in mind is what if we have Bings connected between cars, for examples at the plates. These Bings are going to be bouncing between different cars but obviously are going to show where every car exists. And maybe in the future cars will be able to drive themselves, right? The driver would not need to see the traffic light. At this point, still there will be delays where people will have to stop and wait. We are thinking about the opportunity of ads at these moments. For example, a person is driving through a neighborhood, which has Wal-Mart, and Wal-Mart has some offers with good discounts. As the**

driver stops by, an ad would just pops up. These are factors that can be added to the system. Do you think these factors combined including ads, selling traffic information, etc., can cover the overhead cost of building the system of traffic lights as in creating a business that has side incomes of selling information and advertisement? Do you believe that in theory that would be enough to cover the cost?)

I think based on the way you described it, there would be a game change.

- **(I am glad to hear that. Do you find any flaws or would you add any factors to the system I explained? I know it is a broad question, but I would like you to criticize as much as possible.)**

What I will tell you is that when applying any system, there will be unexpected factors. So, unless the system is tested, there won't be criticism. I think the best criticism is done by reviews. When you choose a relatively small village with maybe two thousand people, and then you set up videos and test it. Then, you would find what the capacity of the system is. My point to you is that it is a great idea; do not let it discourage you. In my view, I think it is a great idea.

- **(Comparing this to the current system, do you believe that there is the ability of increasing the flow of cars through traffic lights using the ideas explained earlier?)**

I do not think it will be able to increase the flow, but it will improve the operation of the system. You are going to improve the maximum operational capacity.

Appendix (3):

(Appendix 3.1)

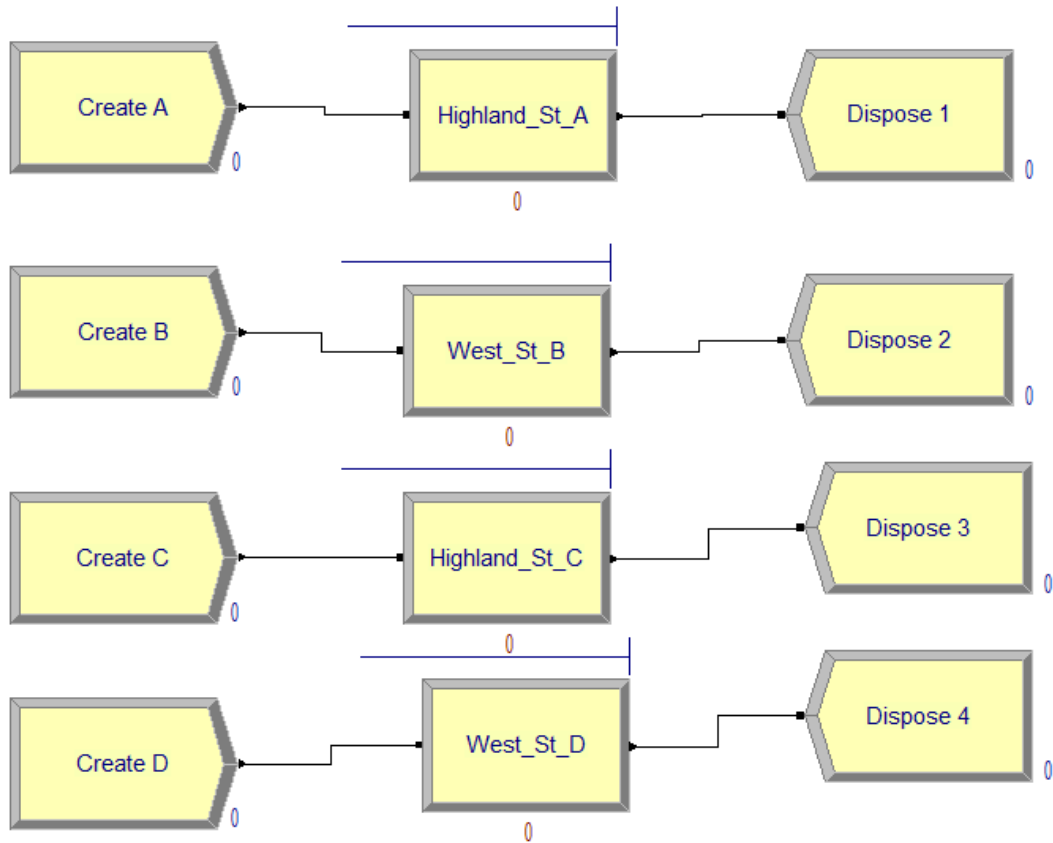

(Appendix 3.2)

2:35:18PM

Category Overview

June 16, 2014

Unnamed Project

Replications: 1 Time Units: Seconds

Key Performance Indicators

System

Average
36

Number Out

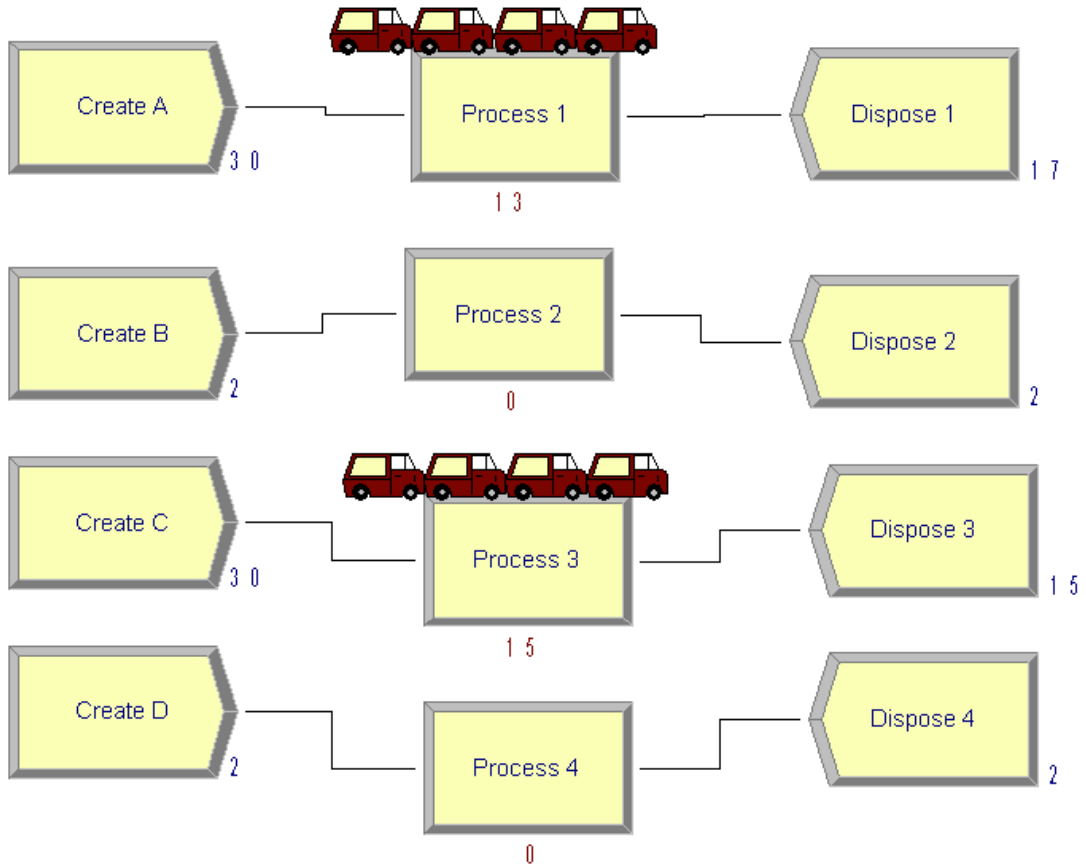

(Appendix 3.3)

2:39:16PM

Category Overview

June 16, 2014

Unnamed Project

Replications: 1 Time Units : Seconds

Key Performance Indicators

System

Number Out

Average

58

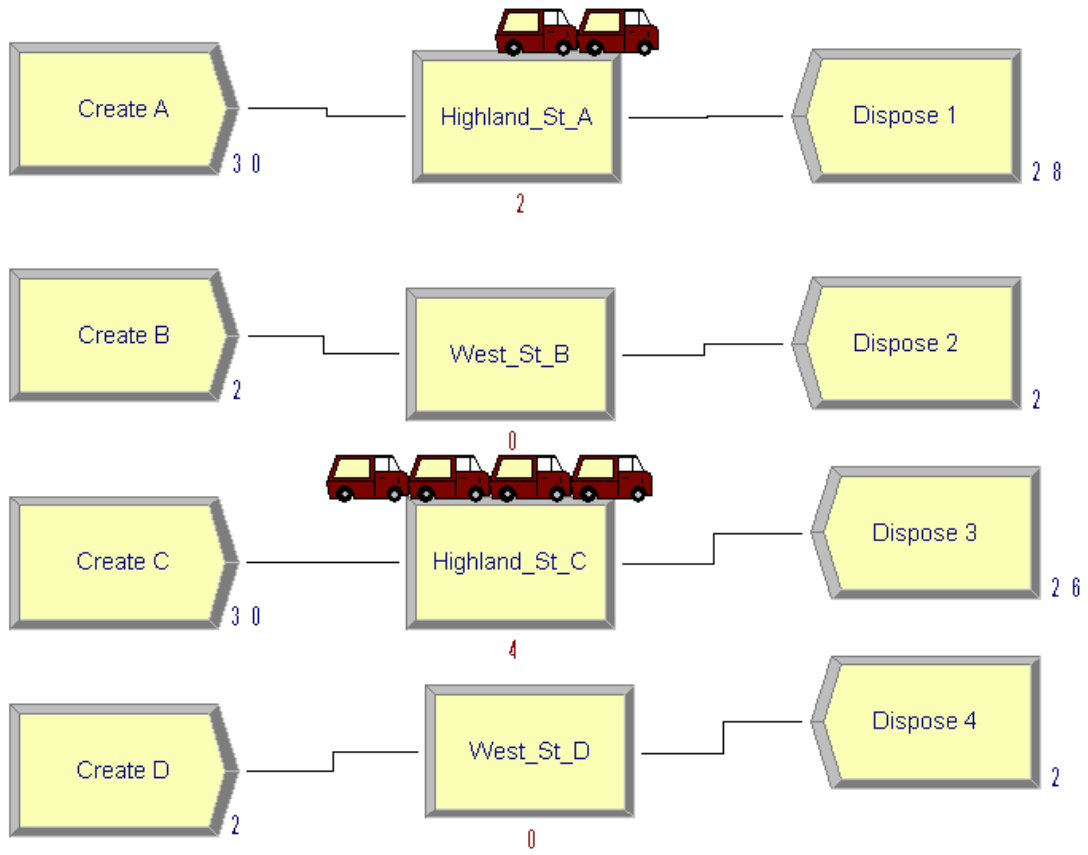

(Appendix 3.4)

2:41:23PM

Category Overview

June 16, 2014

Unnamed Project

Replications: 1 Time Units: Seconds

Key Performance Indicators

System

Average

Number Out

39

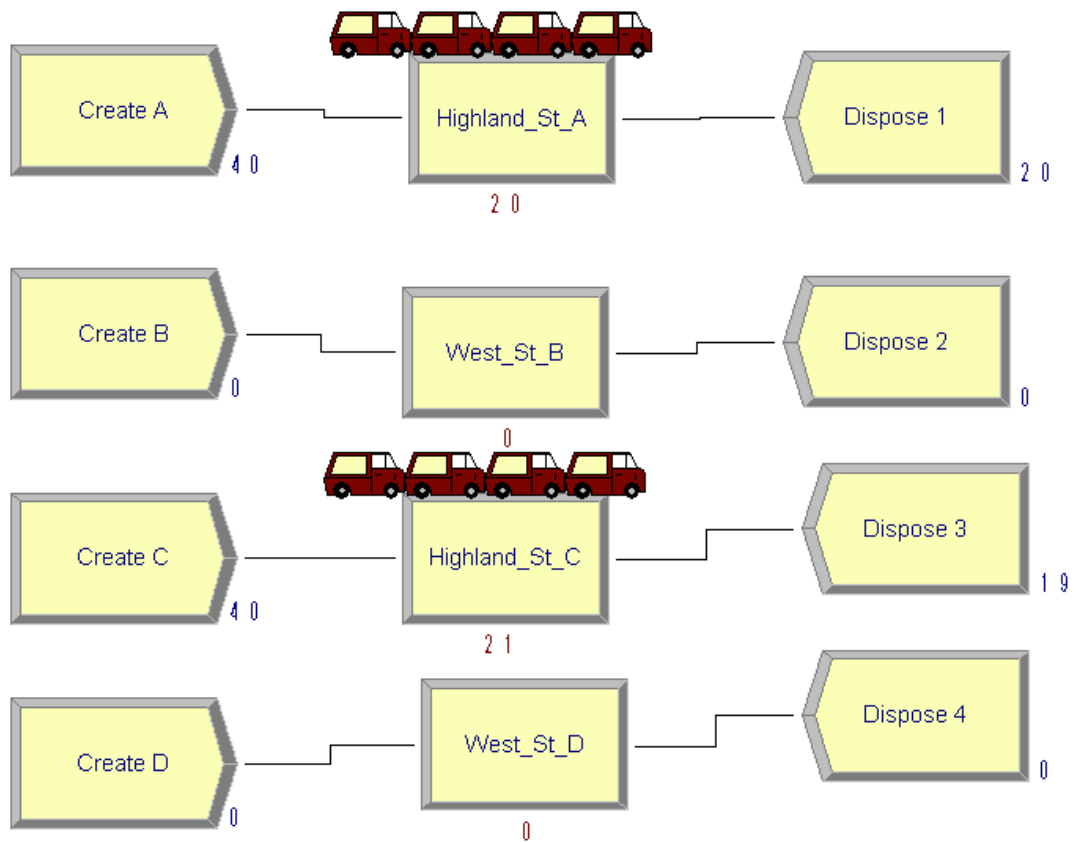

(Appendix 3.5)

2:43:17PM

Category Overview

June 16, 2014

Unnamed Project

Replications: 1 Time Units: Seconds

Key Performance Indicators

System

Number Out

Average
58

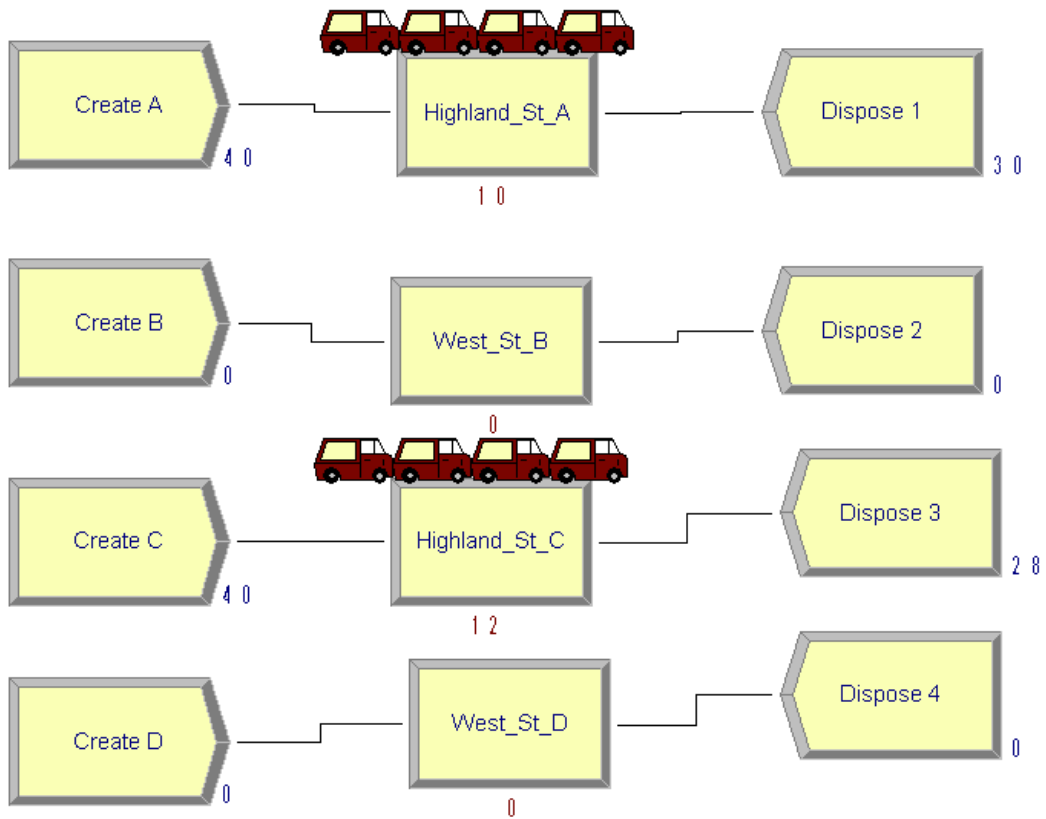

(Appendix 3.6)

2:46:47PM

Category Overview

June 16, 2014

Unnamed Project

Replications: 1 Time Units: Seconds

Key Performance Indicators

System
Number Out

Average
38

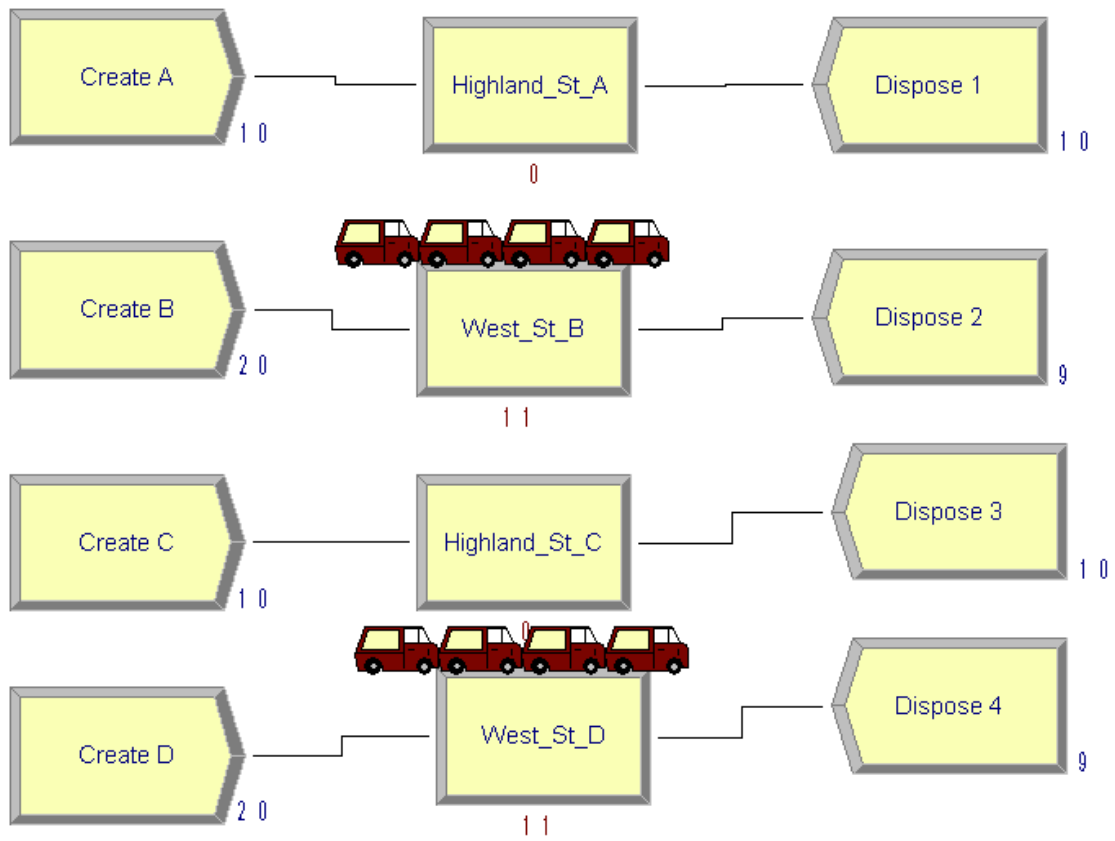

Unnamed Project

Replications: 1 Time Units: Seconds

Key Performance Indicators

System

Number Out

Average
60

