



WPI IQP: Congestion and Passenger Flow in the Tube

Edward Chiang, Robert Crockett, Ian
Johnson, and Aidan O'Keefe



Background on the Tube

- The first Tube lines were built in 1863 (Metropolitan, Circle)
- Since 1863, the population of London has increased almost three-fold
- Renovation and maintenance on the tube is common
 - Four Lines Modernization, Victoria Line Improvements
 - Revamp of Victoria Station, Bank/Monument Maintenance
- Delays cause hundreds of thousands of hours in lost productivity for passengers

Tube Delays due to Overcrowding, Hours/Year

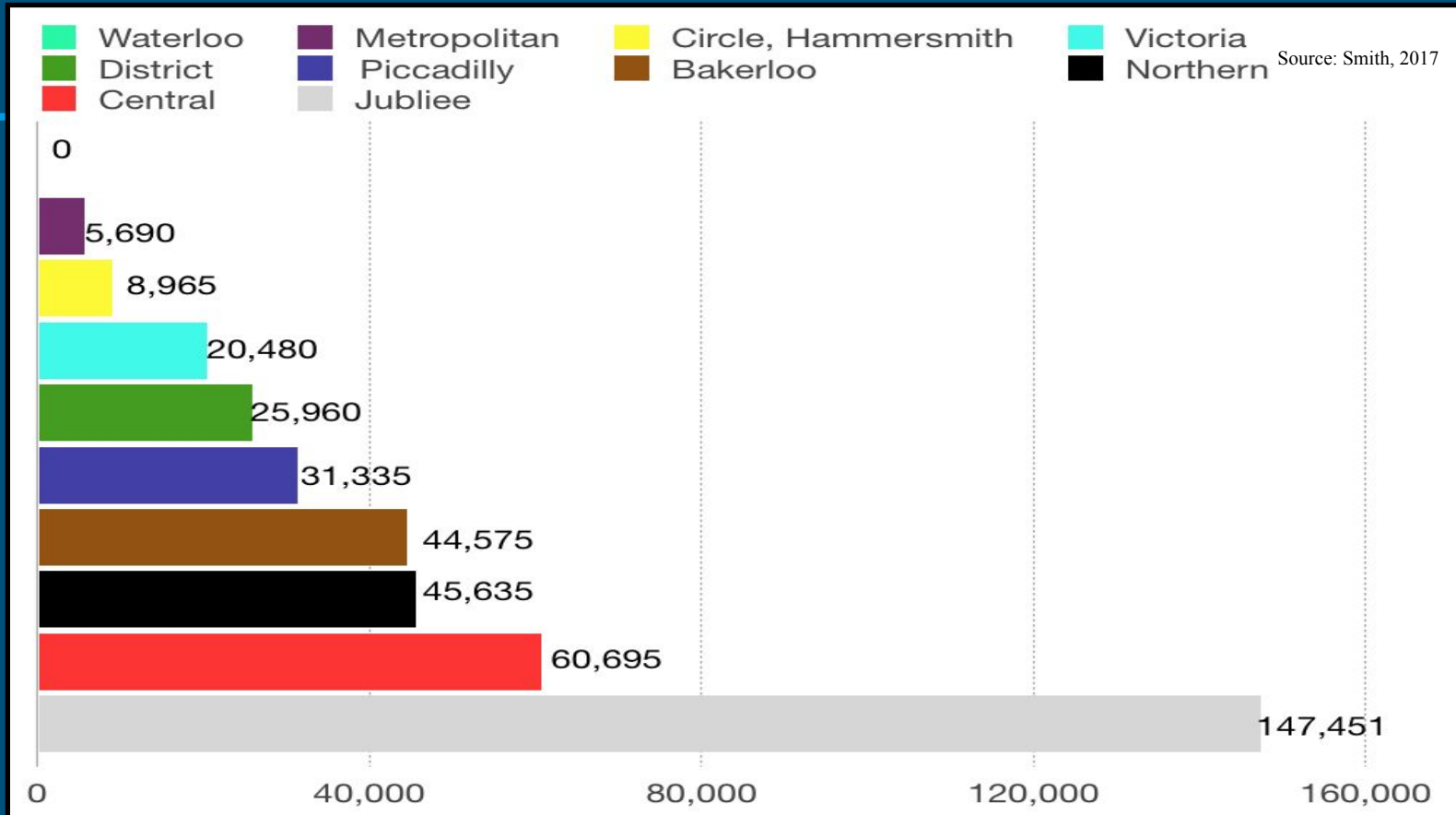





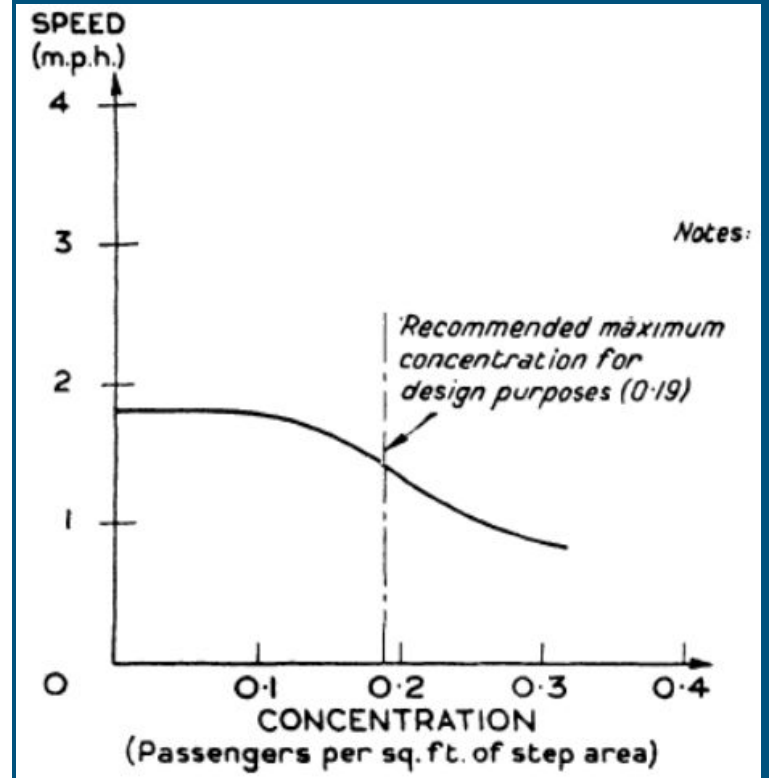
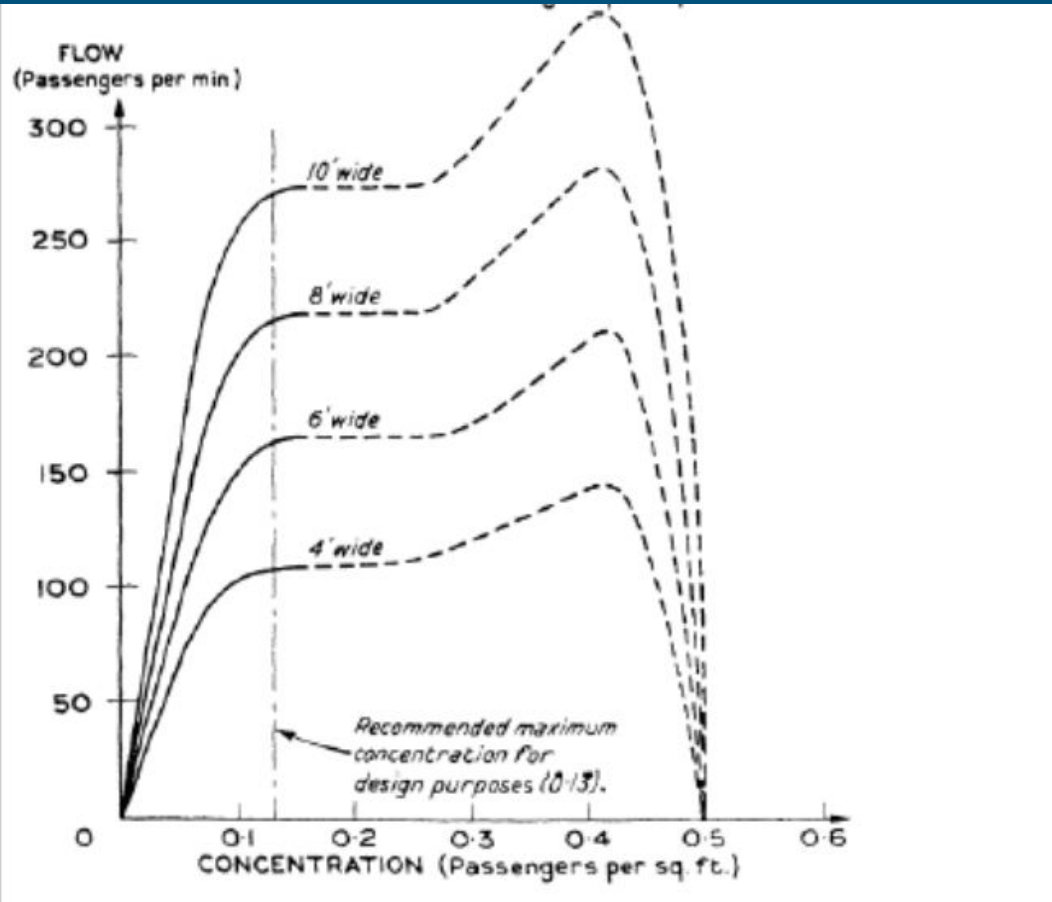

*Originally located on previous slide, moved for clarity due to no animations

Passenger Flow

- Passenger flow is the act of and measurement of passengers moving through a particular area
 - Three kinds of measurements:
 - Directional: Direction that a person is travelling. (Used in corridors, escalators)
 - Spatial: Amount of people in a given area. (Passenger density on platforms)
 - Temporal: Time at which passenger flow occurs
- Passenger flow is an oft-studied topic, and we have many conclusions to base our findings on



LOS	Average pedestrian space (ft ² /p)	Average inter-person space (ft)	Description	Illustration
A	≥ 13	≥ 4.0	Standing and free circulation through the queuing area possible without disturbing others within the queue.	
B	10-13	3.5-4.0	Standing and partially restricted circulation to avoid disturbing others within the queue is possible.	
C	7-10	3.0-3.5	Standing and restricted circulation through the queuing area by disturbing others is possible; this density is within the range of personal comfort.	
D	7-10	2.0-3.0	Standing without touching is impossible; circulation is severely restricted within the queue, and forward movement is possible only as a group; long-term waiting at this density is discomforting.	
E	3-7	< 2.0	Standing in physical contact with others is unavoidable; circulation within the queue is not possible; queuing at this density can be sustained only for a short period without serious discomfort.	
F	< 2	Variable	Virtually all people within the queue are standing in direct physical contact with others; this density is extremely discomforting; no movement is possible within the queue; the potential for pushing and panic exists.	

*Originally located on previous slide, moved for clarity due to no animations

Methodology Overview

- Station Selection
 - Determine the most important stations to focus on
- Employee Interviews
 - Find the problem areas in the stations
- CCTV Observation
 - Collect raw data about congestion at peak times
- Passenger Survey Analysis
 - Determine correlations between congestion and passenger satisfaction based on intranet data within TfL
- Refine Solutions
 - Focus group with CSM to improve on suggested solutions for issues

Station Selection Criteria

- Station selection was a multi-step process
 - Receive recommendations for stations from sponsors
 - Create matrix comparing stations

	Interchange station	Construction	Severe Congestion	CCTV	Accessible	Network Rail Interface
Bank/Monument	Y	Y	Y	N	N	N
Embankment	Y	N	N	N	N	N
Euston	Y	N	Y	Y	Y	Y
Liverpool Street	Y	N	N	Y	N	Y
Oxford Circus	Y	N	N	N	N	N
Paddington	Y	N	Y	N	Y	Y
Victoria	Y	Y	Y	Y	N	Y
Waterloo	Y	Y	Y	N	N	Y

*Originally located on previous slide, moved for clarity due to no animations

Employee Interviews

- Euston
 - 6 employees
 - Peaks: Fri. (0700-0900, 1730-1900) and weekend (0930-1200, 1730-1900)
 - Customers had problems with wayfinding
 - Identified problem areas

Packed Escalators (6,7,8)

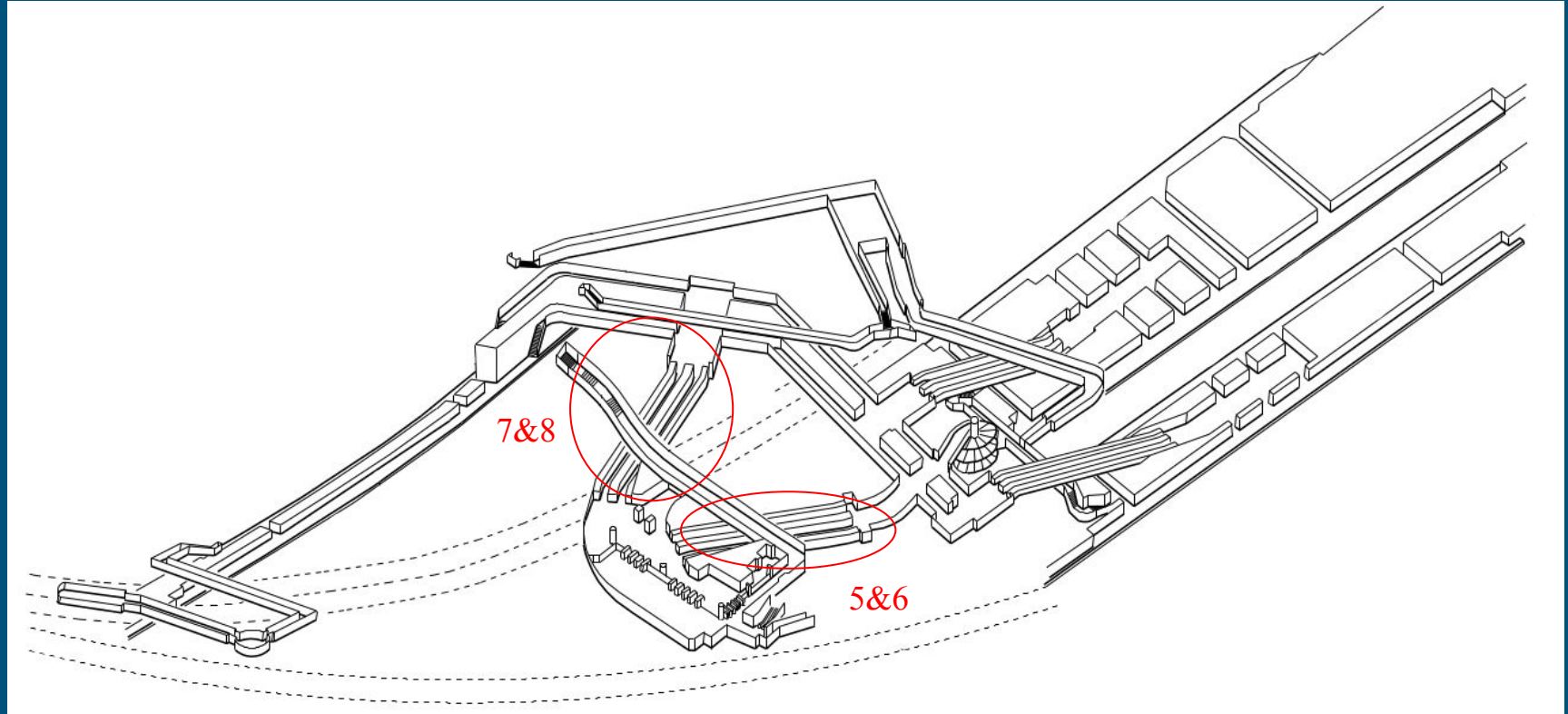

Employee Interviews

- Liverpool Street
 - 10 employees
 - Peaks: Tue. and Wed. (0630-0930, 1630-1930), weekend (0930-1230)
 - Customers had problems with wayfinding
 - Identified problem areas

Ticket Hall B & C

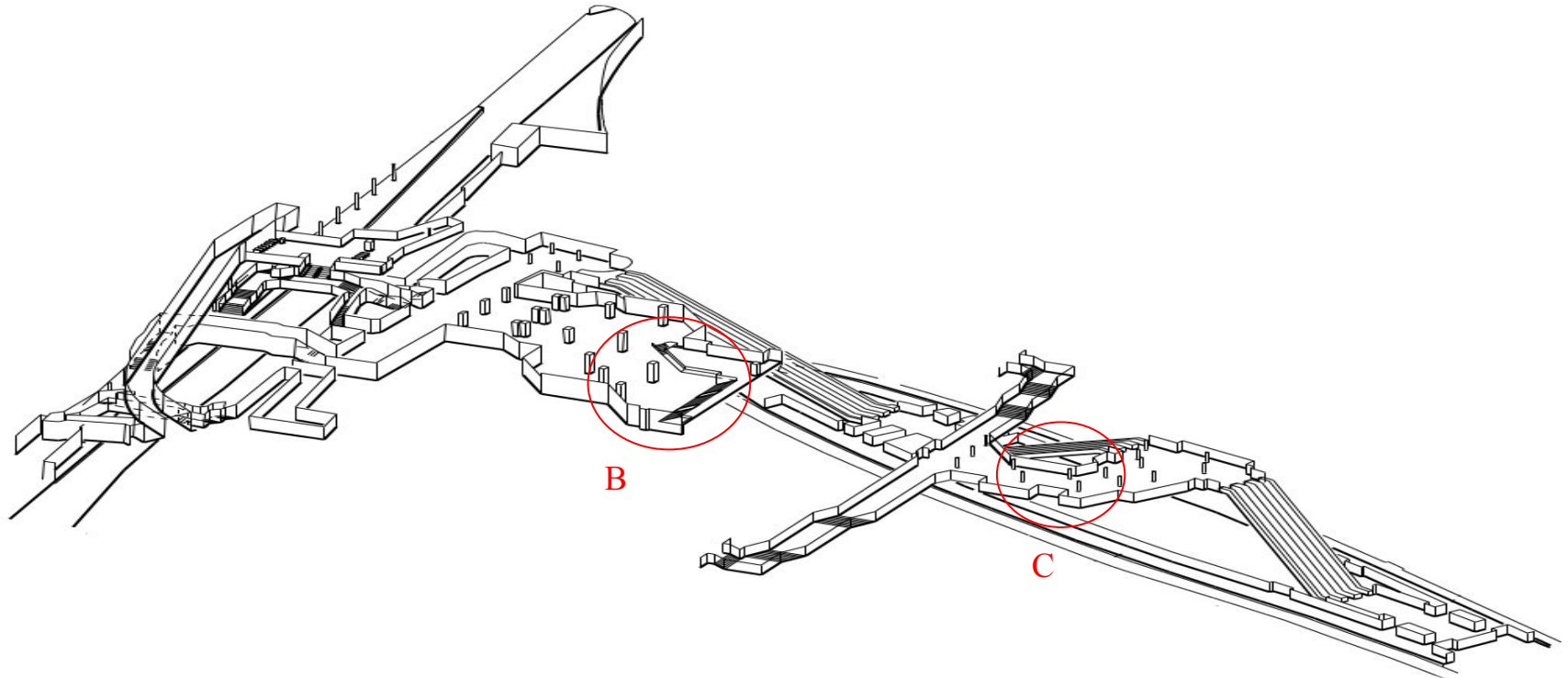

CCTV Observation

- British Transport Police laptop
- Capture image every minute, on the minute
- 180 captures taken for each 3-hour set
- Count passengers in frame
- Repeat for different views

On-Peak vs. Off-Peak Example: Liverpool Street Ticket Hall B, Tuesday 6/6

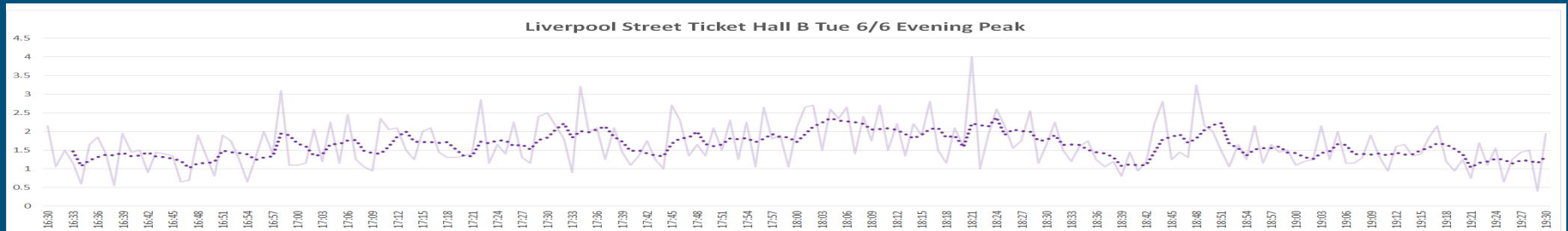
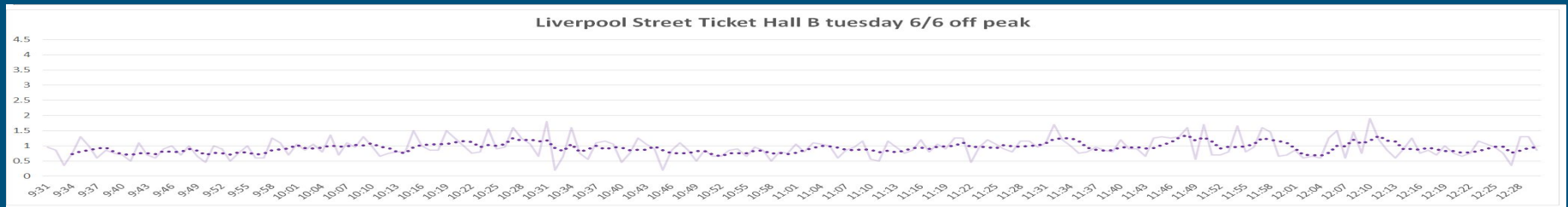
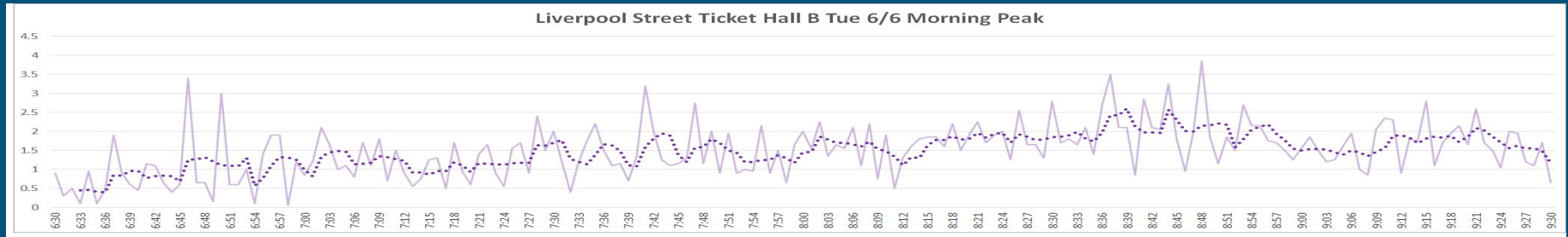

Data - Liverpool Street, Common Occurrences

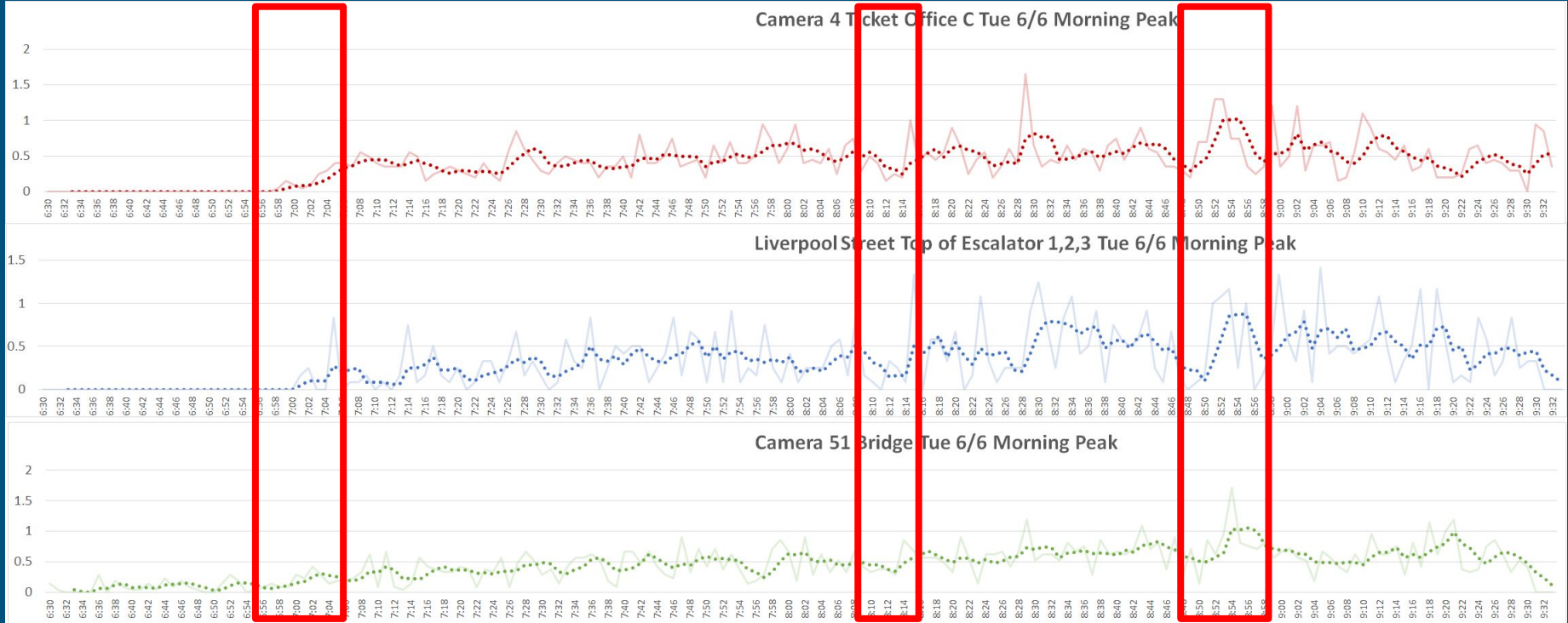

Level of Service Values - Liverpool Street

LOS Rating	A	B	C	D	E	F
density (p/m ²)	0.3	0.3<d<0.43	0.43<d<0.718	0.718<d<1.08	1.08<d<2.15	2.15<d

- Level of Service
 - Measurement devised in the 1970s
 - Determines how well a system flows based on density

Liverpool Street Ticket Hall B Tue 6/6 Morning Peak LOS

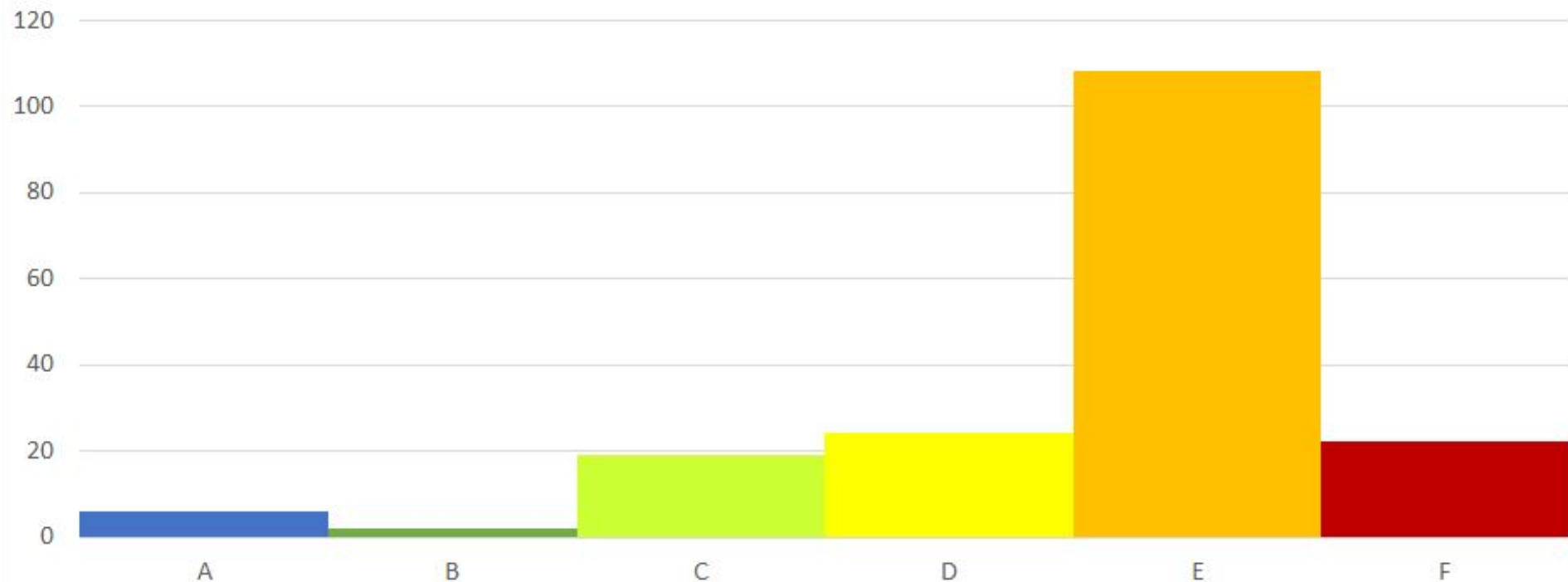

*Originally located on previous slide, moved for clarity due to no animations

Liverpool Street Escalators 1,2,3 Tue 6/6 Morning Peak LOS

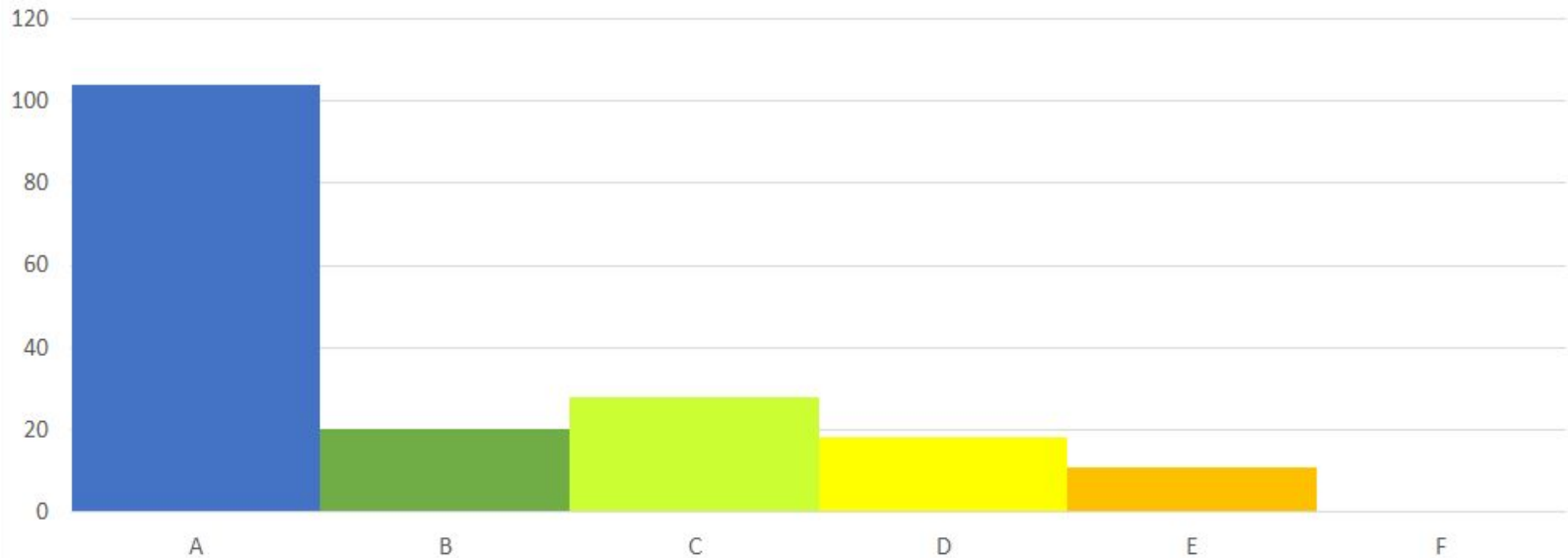

*Originally located on slide 17, moved for clarity due to no animations

Liverpool Street Ticket Office C Tue 6/6 Morning Peak LOS

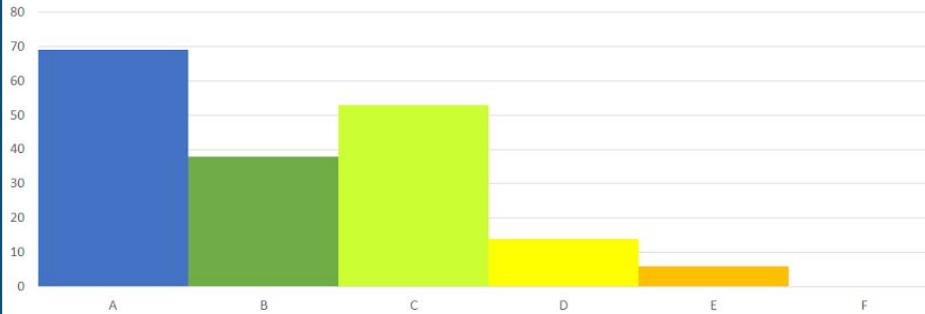

Liverpool Street Escalators 4,5,6 Tue 6/6 Morning Peak LOS

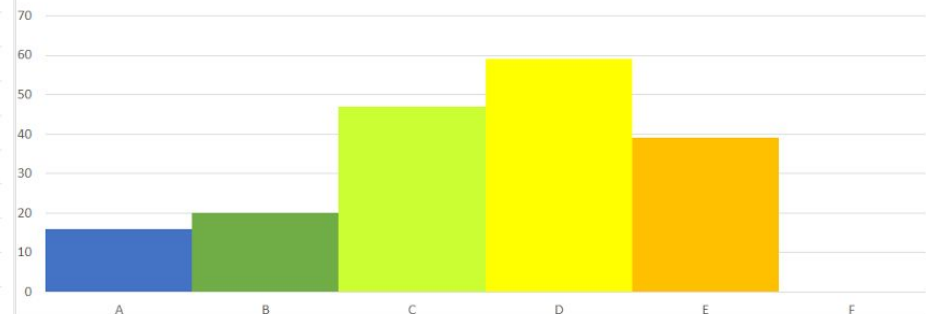

Liverpool Street Bridge Tue 6/6 Morning Peak LOS

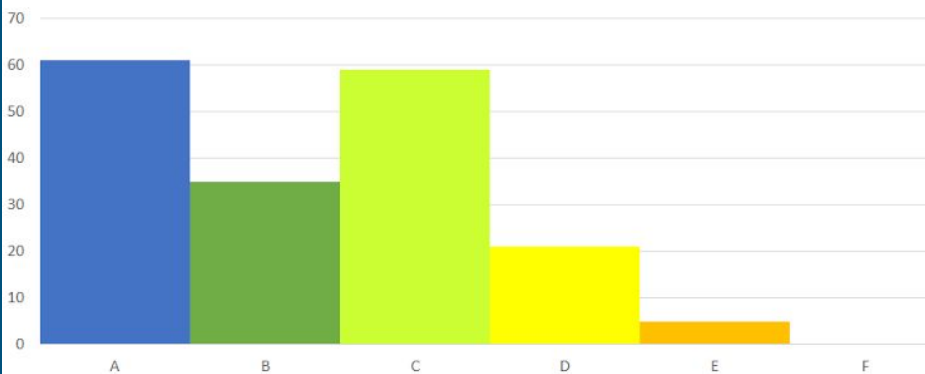

Liverpool Street Escalators 7,8,9 Tue 6/6 Morning Peak LOS

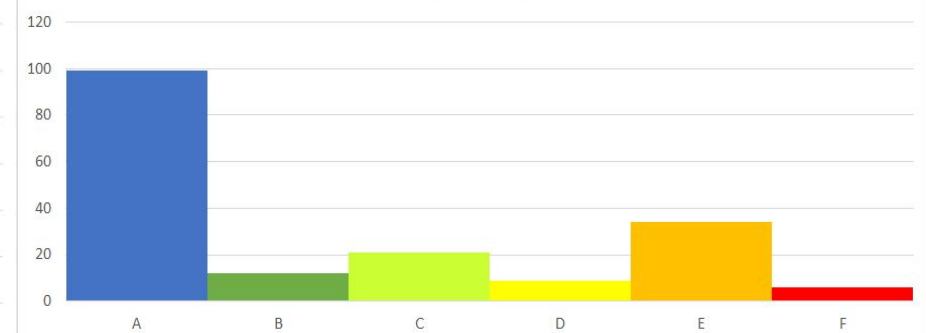

*Originally located on slide 17, moved for clarity due to no animations

Euston Ticket Hall On Peak vs. Off Peak

Euston Ticket Hall Friday 19/5 Morning Peak

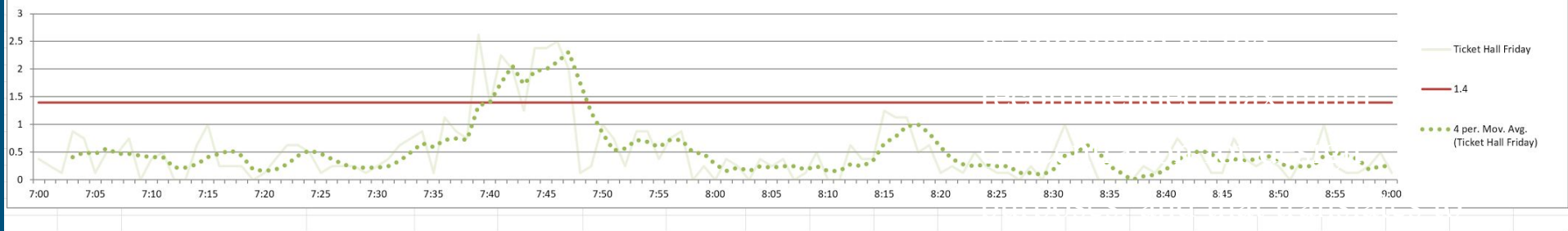

Euston Ticket Hall Saturday 20/5 Morning

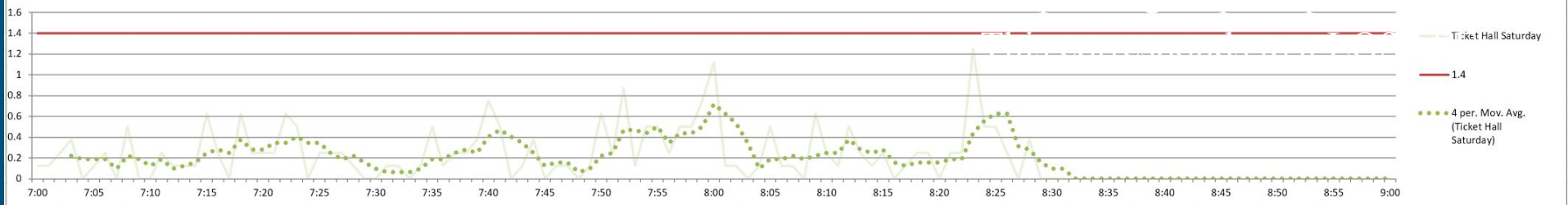

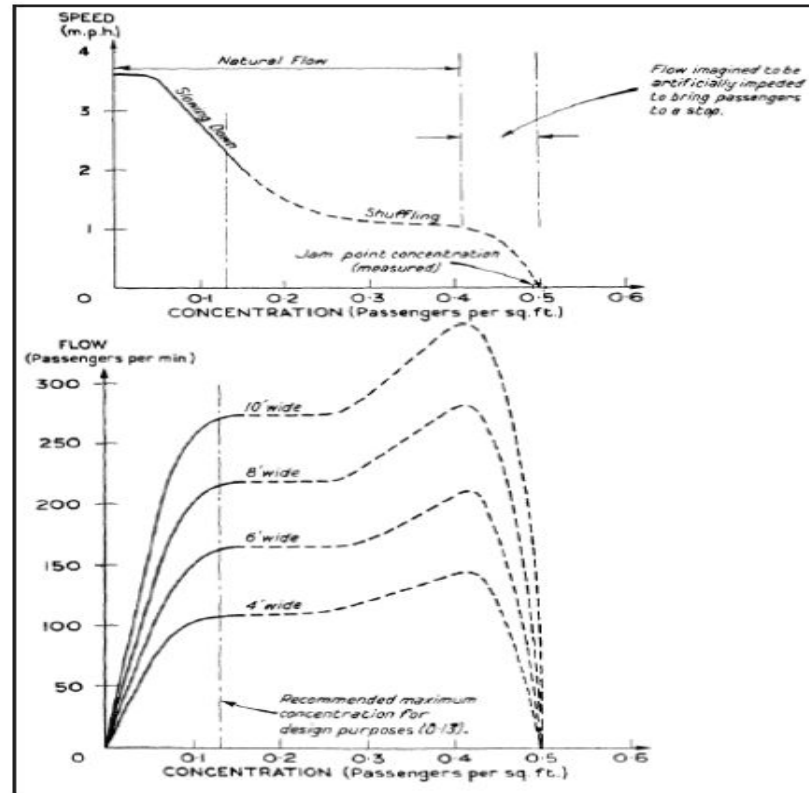

*Originally located on slide 21, moved for clarity due to no animations

Euston Ticket Hall Fri 19/5 Morning peak

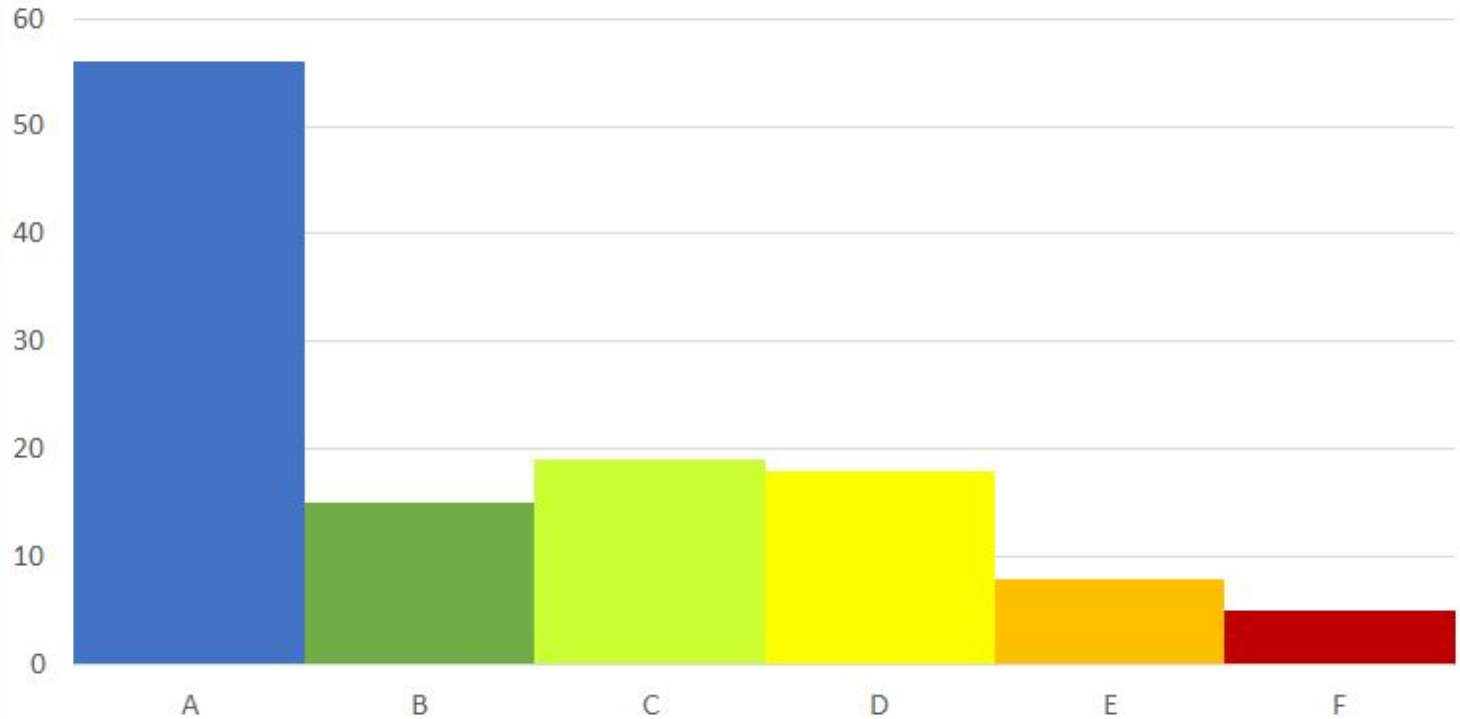

*Originally located on slide 21, moved for clarity due to no animations



Euston Ticket Hall Fri 19/5 Morning peak

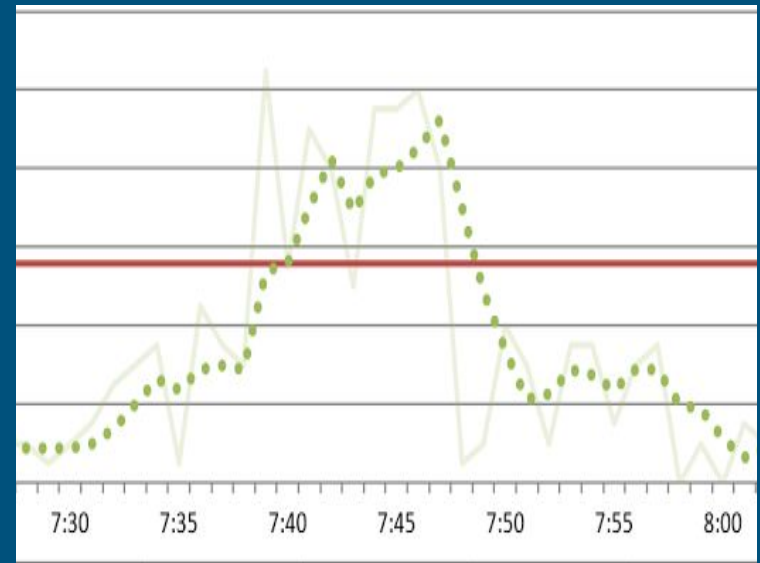
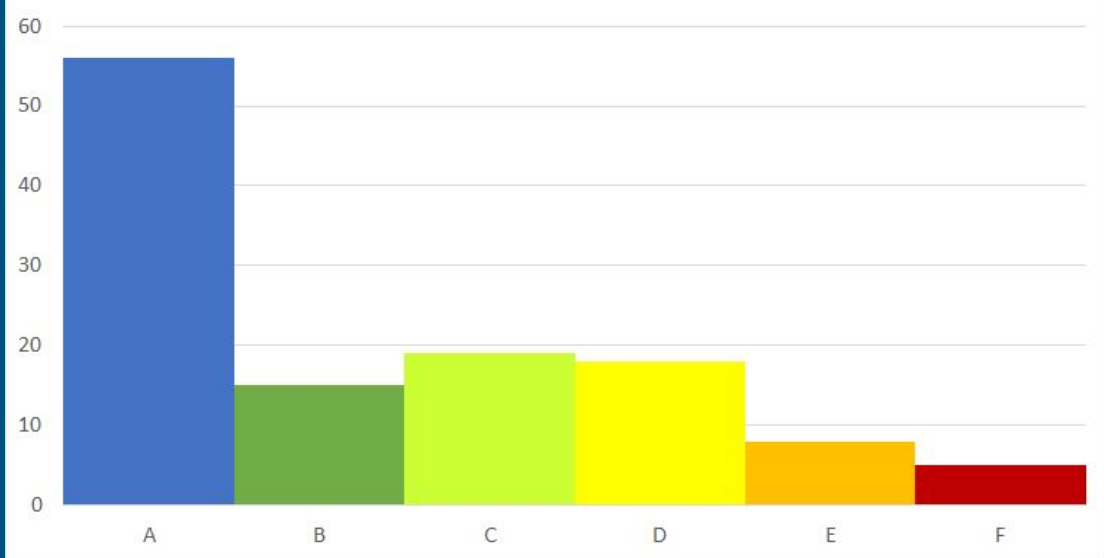

*Originally located on slide 21, moved for clarity due to no animations

Liverpool Street Ticket Hall B LOS

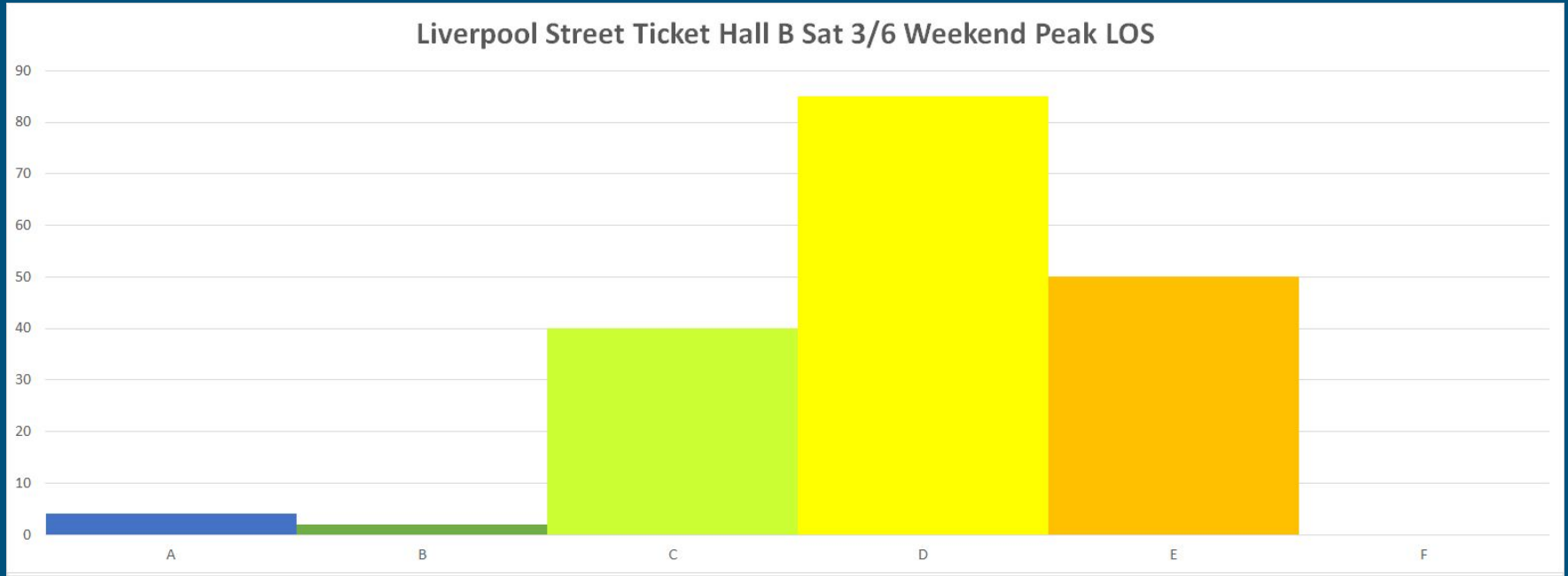

Passenger Survey Analysis - Euston

- Northern Line
 - The Northern Line has customers who are satisfied overall with the line
 - Signage and information on delays are good, but still have room for improvement
 - Train service is a major issue on the Northern Line and a big point of concern
 - Platforms tend to be crowded and navigating through stations is a hassle for customers
- Victoria Line
 - Customers overall satisfaction with the Victoria Line is above average
 - Signage concerns make up a significant portion of the issues with the Victoria Line
 - Stations are harder to navigate than average and platforms are too crowded

Passenger Survey Analysis - Liverpool St

- Central Line:
 - Overall, passenger satisfaction has gone down recently (85 Q4 15/16, 83 Q1 16/17)
 - Passenger satisfaction on the Central Line is below average for the Tube
 - Train crowding is rated a paltry 69 out of 100, well below average
 - 6% of passengers experience a delay
- Circle, Metropolitan, Hammersmith and City:
 - Circle & Hammersmith have overall passenger satisfaction well below that of the Tube
 - Signage and information for these lines are significantly below average (up to 24 points)
 - Circle & Hammersmith need major revamps to stations and the trains themselves
 - Metropolitan line has no significant strengths or weaknesses in terms of satisfaction

Preliminary Solutions:

Overall:

- Increase quality of CCTV cameras to allow better data collection
- Allow passengers to swipe out and back in for no charge within a small time period (<10 min) to allow alternative routes within stations
- Allow cleaning staff to swipe themselves in/out
- Make Help Points more visible from a distance
- Install fail-safe escalators at every set of bidirectional escalators
- Lines on the ground for navigation

Preliminary Solutions:

Euston:

- Increase width of all major passageways
- Remove or replace confusing signage
- Move maps away from choke points
- Split the Northern line to reduce confusion
- Consider a station revamp/rebuild to account for Crossrail 2/High-Speed 2 traffic

Unclear Signage



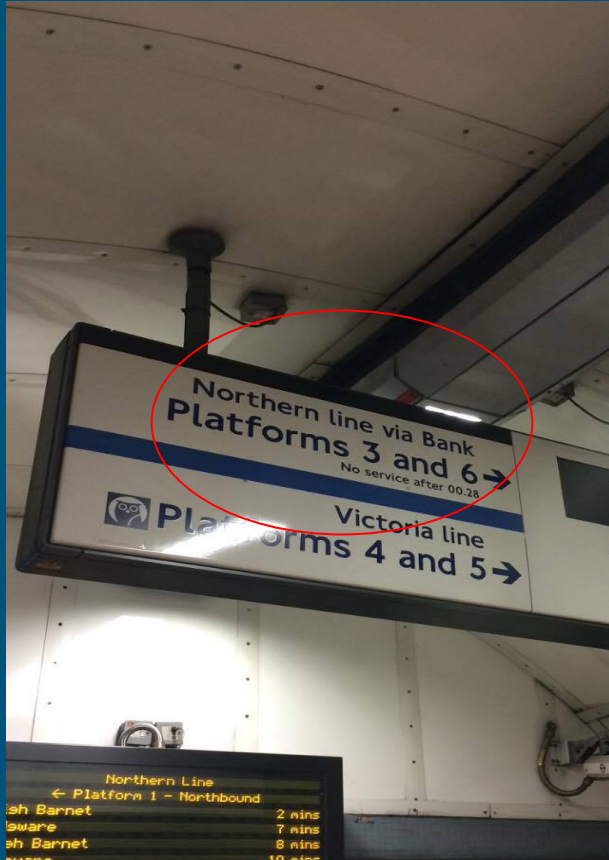

*Originally located on previous slide, moved for clarity due to no animations

Map Location



Preliminary Solutions:

Liverpool St:

- Add more Ticket booths to Ticket Hall C
- Add another bridge across the tracks near Ticket Hall A
- Expand the platforms, or
- Implement platform doors to improve safety on congested platforms
- Add lifts from street to platform for more handicapped accessibility
- Brighter signage and platforms

Unclear Signage



Ticket Machines & Gatelines



Refining Solutions

- Review sessions with senior TfL staff
 - Covered Overall and station-specific suggestions
- Overall, suggestions aligned with current issue lists
- Some suggestions already being considered
- Review sessions helped to improve and clarify solutions

Special Thanks

We would like to thank **Dr. Taku Fujiyama** , the staff at Euston and Liverpool Street, especially **Sadiq Parker**, **Mike Donnithorne**, and **Cassius Powell**, and our sponsor, **Steve Walling**. We couldn't have done it without them.

Questions?

Tube_E17@wpi.edu

Euston Layout

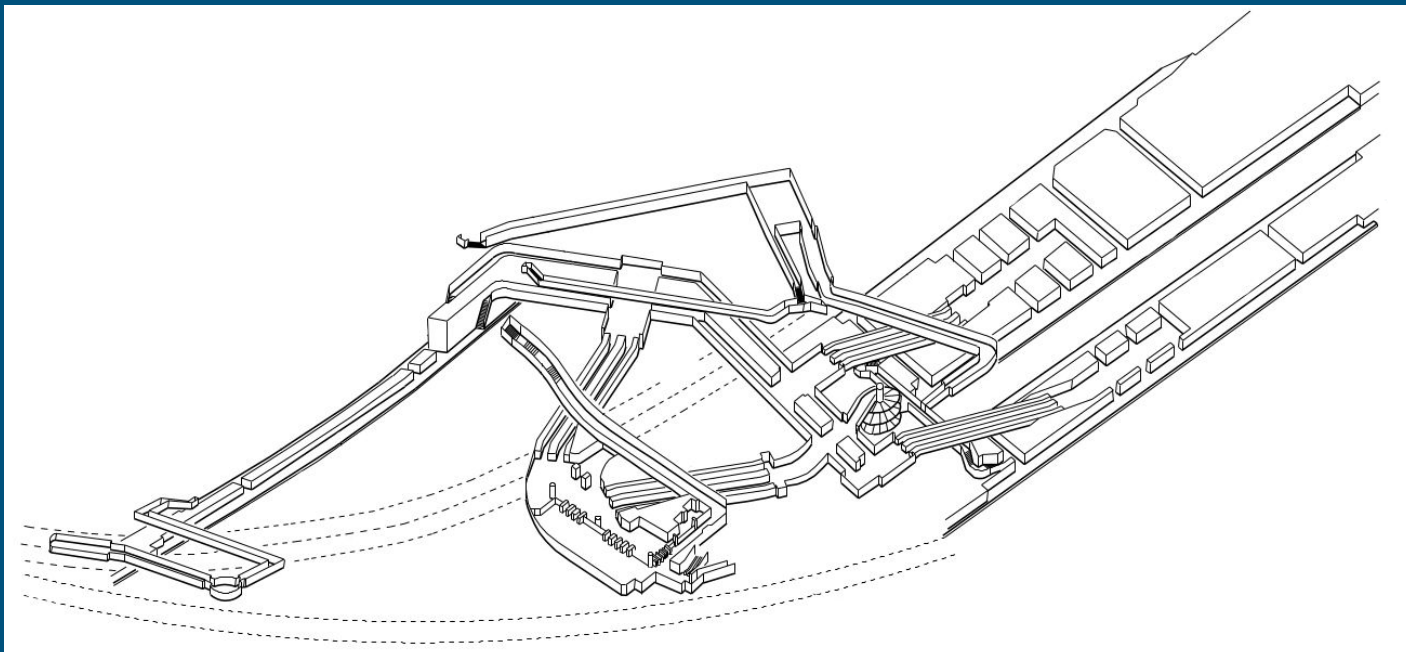

Liverpool Street Layout

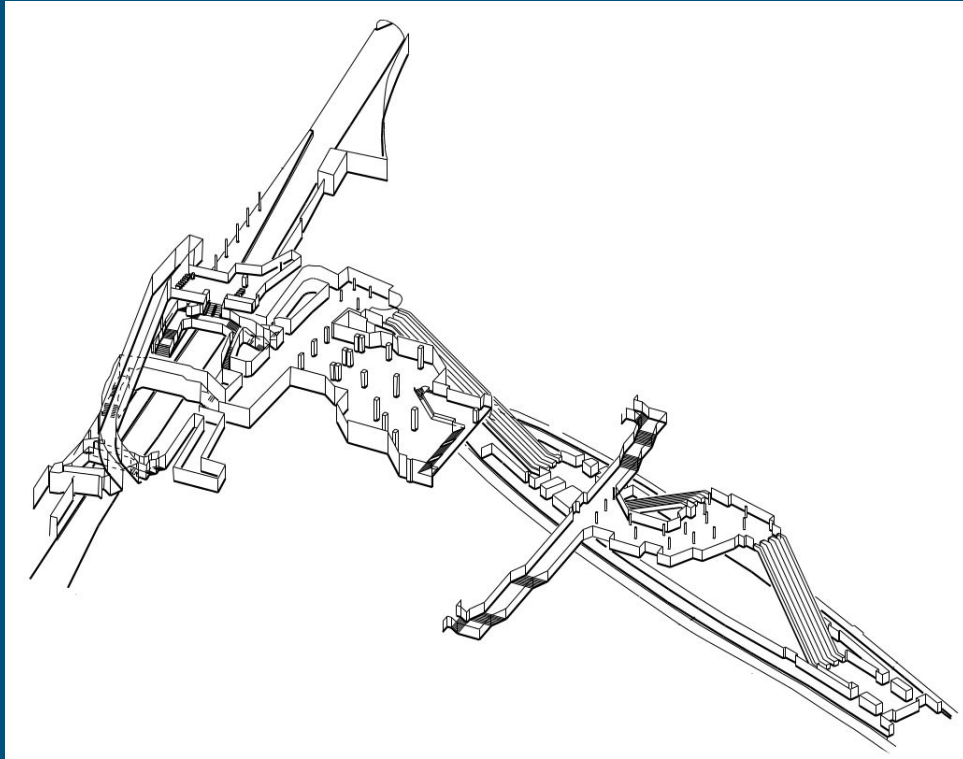

Camera 55 Central Escalators 7,8,9

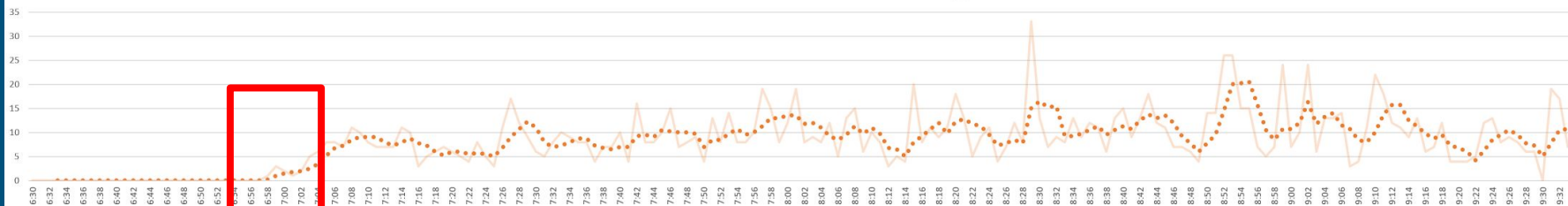

Camera 51 Bridge Tue 6/6 Evening Peak



Camera 28 Esc 4,5,6 Tue 6/6 Morning Peak

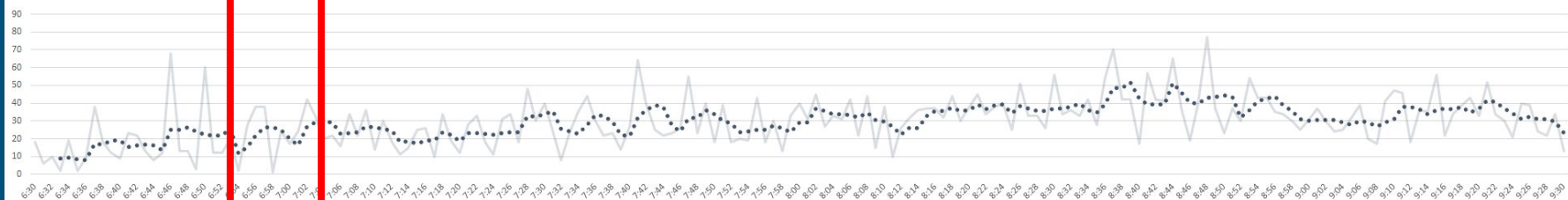

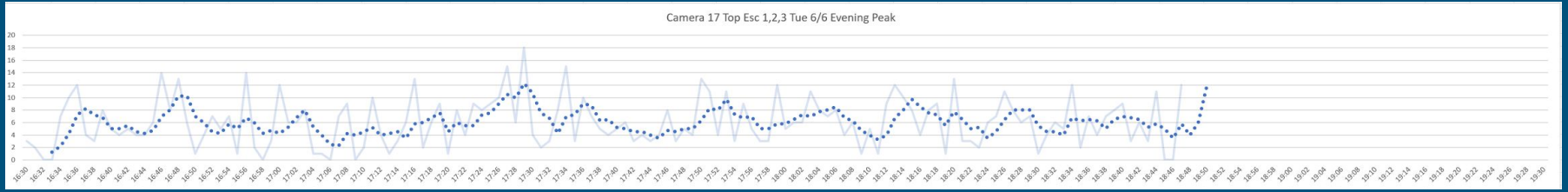
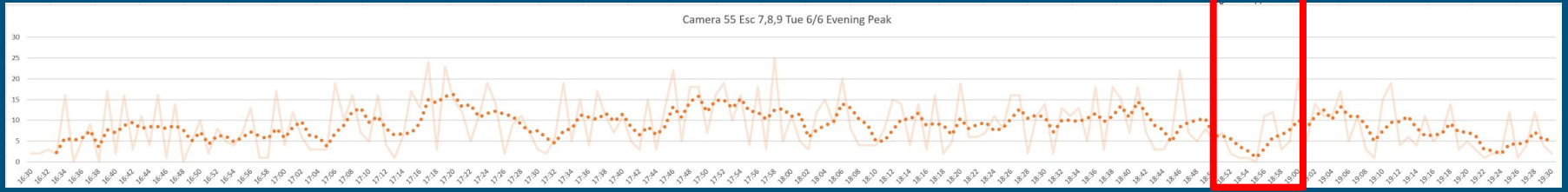
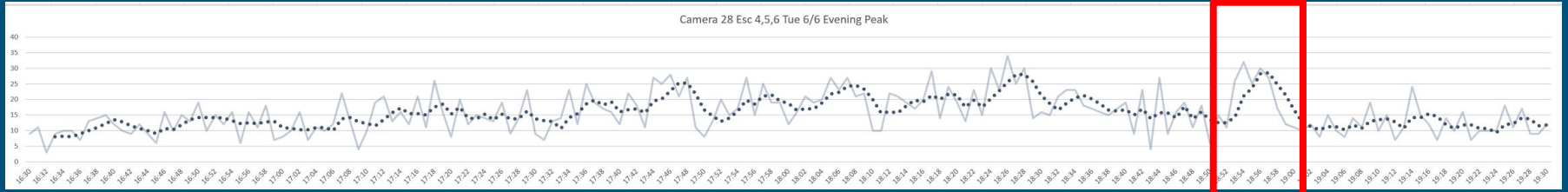

Bottom Esc 5,6 Friday 19/5 Evening Peak

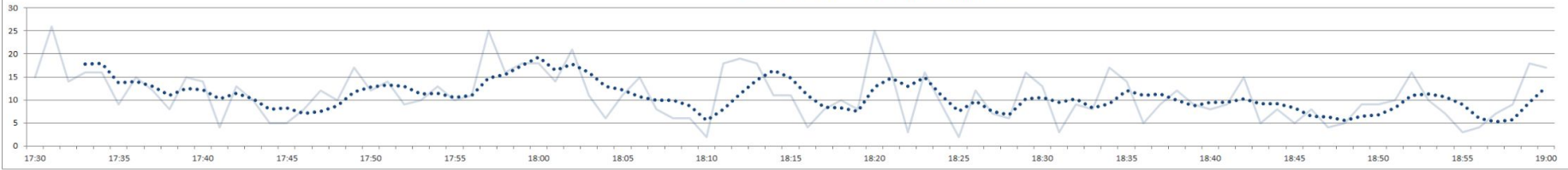

Bottom Esc 7,8 Friday 19/5 Evening Peak

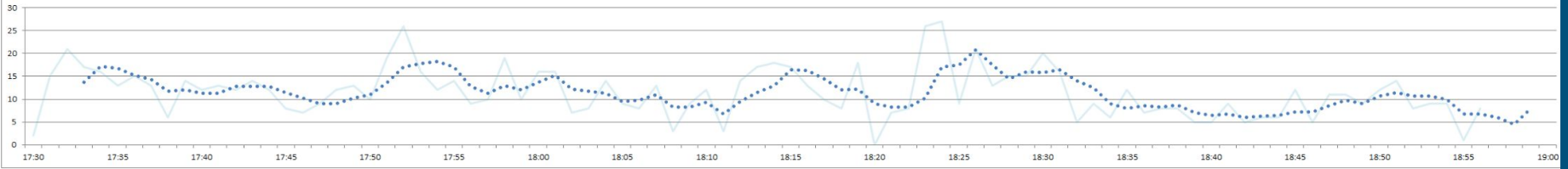

Bottom Esc 1,2 Saturday 20/5 Evening Peak

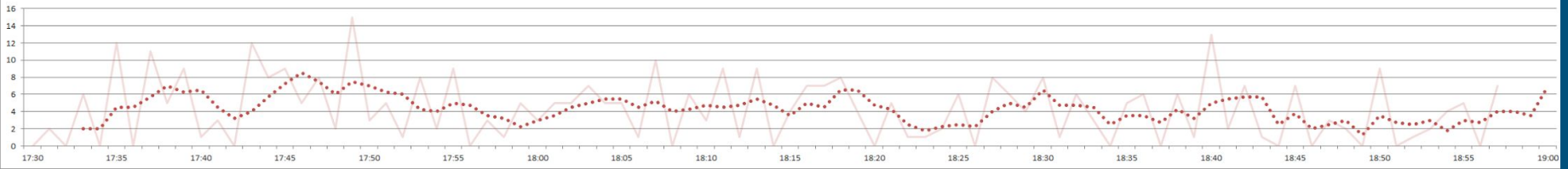

Top Esc 7,8 Saturday 20/5 Morning Peak

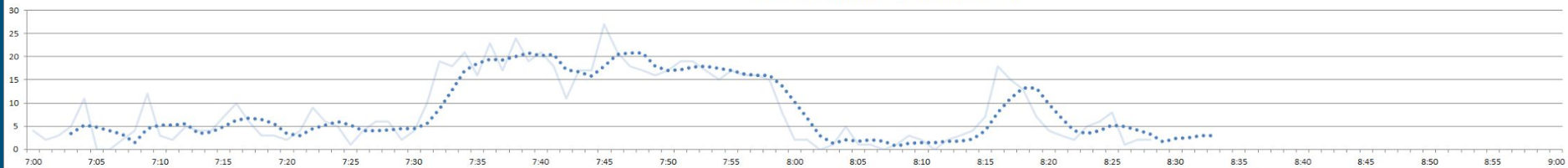

Top Esc 7,8 Saturday 20/5 Peak

