



Residential Electrical Fires:  
Effects of Increased Demand on Aging Electrical Distribution  
Systems in Victoria, Australia

An Interactive Qualifying Project to be submitted to the Faculty of Worcester Polytechnic Institute in partial fulfillment of the requirements for the degree of Bachelor of Science

Submitted by:

Daniel Distler  
Richard Emberley  
Harold Reader  
Zachary Taillefer

Submitted to:

Project Advisors:

Prof. Peter Christopher, Worcester Polytechnic Institute  
Prof. Lauren Mathews, Worcester Polytechnic Institute

Project Liaisons:

Jarrold Edwards, Metropolitan Fire & Emergency Services Board  
Jeff Watt, Metropolitan Fire & Emergency Services Board

Metropolitan Fire & Emergency Services Board

April 30, 2010

*For more information about the project please contact [mfb@wpi.edu](mailto:mfb@wpi.edu)*

## **ABSTRACT**

This project supports the efforts of the Metropolitan Fire and Emergency Services Board in Melbourne, Victoria to investigate potential risk associated with placing high electrical demand on deteriorating residential wiring systems. Our project team analyzed electricity consumption and fire incident data, and conducted a survey and interviews which indicated the existence of an increase in electricity consumption per capita and related electrical fires from 1986 to 2009. We made recommendations to implement routine residential electrical inspections, address failing electrical distribution systems attributable to overloads and establish stronger consumer awareness of associated risk.

## **ACKNOWLEDGMENTS**

We would like to thank Professor Lauren Mathews and Professor Peter Christopher for their extensive guidance, commitment to our project, and all the extra late night meetings at the Milano.

We would like to thank Jarrod Edwards for presenting us with this opportunity, for never pushing us to assume conclusions, and for being accommodating to the social aspect of the IQP.

We also would like to thank Jeff Watt for his extensive knowledge in the field of statistics and data analysis. He also helped us understand the fire incident data and that statistics is merely a representation of the truth. He also went above and beyond to help us with the analysis of our data.

We would like to thank Professor Holly Ault for giving us the privilege to complete our off-campus IQP at the Australia project centre.

We would also like to thank everyone at MFB for their hospitality, helping us with the acclimation process, and showing us what Australian's are really like.

We would also like to thank anyone else who has aided with our project

## **AUTHORSHIP**

All aspects of this document including researching, writing, and editing contain equal contributions from Daniel Distler, Richard Emberley, Harold Reader, and Zachary Taillefer.

# TABLE OF CONTENTS

ABSTRACT.....	ii
ACKNOWLEDGMENTS .....	iii
AUTHORSHIP .....	iv
TABLE OF CONTENTS.....	v
TABLE OF FIGURES .....	ix
TABLE OF TABLES .....	x
EXECUTIVE SUMMARY .....	xi
1. INTRODUCTION .....	1
2. BACKGROUND .....	4
2.1 Implications of Increased Electricity Demand on Electrical Fires.....	4
2.1.1 Electricity and the Occurrence of Electrical Fires .....	5
2.1.2 Factors Related to Increased Electrical Consumption .....	8
2.2 Causes and Types of Electrical Fires .....	9
2.2.1 Poor Connections.....	9
2.2.2 Arcing, Carbonization of Insulation and Sparks.....	9
2.2.3 Overloads and Short Circuits.....	10
2.2.4 Combustible Materials.....	11
2.2.5 Faulty Circuit Breakers.....	11
2.3 Evolution of Electrical Systems in Australia and the United States .....	12
2.3.1 Electrical Wiring Comparison .....	12
2.3.2 Circuit Comparison.....	15
2.4 The Effects of Time on Electrical Systems.....	16
2.4.1 Aging Electrical Systems.....	17
2.4.2 Behavior and Electrical Demand Changes .....	17
2.4.3 Global Comparison .....	19

2.5	Legislative Context .....	20
2.5.1	Prescriptive versus Performance-Based Design .....	20
2.5.2	United States .....	21
2.5.3	Canada.....	22
2.5.4	United Kingdom.....	22
2.5.5	Victoria, Australia.....	23
2.5.6	Privatization of the Electricity Industry.....	24
2.6	Socioeconomic Factors in the Incidence and Effects of Electrical Fires .....	28
2.6.1	Income Levels.....	29
2.6.2	Community Awareness Programs.....	31
2.6.3	Insurance Companies .....	32
2.7	Summary .....	33
3.	METHODOLOGY .....	34
3.1	Objective 1: Identifying Trends in Household Electricity Consumption.....	34
3.1.1	Describe Trends in Electricity Demand.....	34
3.1.2	Characterize Current Appliance Household Usage .....	35
3.1.3	Interview with Rod East.....	36
3.2	Objective 2: Identifying Trends in Electrical Fires.....	36
3.2.1	Interview MFB.....	36
3.2.2	Analysis of Fire Incident Data from MFB.....	37
3.3	Objective 3: Establish Social Dimensions related to Electrical Fires .....	37
3.3.1	Interview with MFB Employees .....	37
3.3.2	Correlation Analysis of Societal Dimension Data .....	38
4.	RESULTS AND ANALYSIS.....	39
4.1	Electrical Consumption .....	39
4.1.1	Population vs. Electricity Consumption .....	39
4.1.2	Electricity Consumption per Household.....	41

4.1.3 Analysis of Current Appliances .....	43
4.1.4 Power Boards .....	46
4.2 Electrical Fires .....	47
4.2.1 Percent of Electrical Fires with Respect to All Fires .....	48
4.2.2 Ignition Factors and Equipment .....	49
4.2.3 Progression of Electrical Fires .....	54
4.2.4 Time of Day .....	56
4.2.5 Summer vs. Winter .....	57
4.2.6 Weekend vs. Weekday .....	59
4.2.7 Month of the Year .....	60
4.2.8 Heat of Ignition Analysis .....	61
4.3 Societal Dimension .....	62
4.3.1 Census Data Analysis .....	62
4.3.2. Cost Analysis of Electrical Fires vs. Other Ignition Factors .....	66
5. CONCLUSIONS .....	68
5.1 Electrical Demand Increase .....	68
5.2 Electrical Fire Characteristics .....	68
5.3 Social Dimensions .....	69
6. RECOMMENDATIONS .....	71
6.1 AIRS and Firefighter Investigators .....	71
6.2 Analysis of Aging Wiring .....	72
6.3 Privatization and Routine Inspections .....	73
6.4 AFDD's .....	74
6.5 Public Awareness and Education .....	75
APPENDIX A: ABBREVIATIONS .....	83
APPENDIX B: AS/NZS 3000 DEFINED TERMS .....	85
APPENDIX C: OTHER TERMS DEFINED NOT INCLUDED IN APPENDIX B .....	102

APPENDIX D: TRANSCRIPTION OF CONFERENCE CALL WITH JARROD EDWARDS AND JEFF WATT .....	103
APPENDIX E: ELECTRICAL WIRING SYSTEM FAULT DETECTION FLOW CHART ..	115
APPENDIX F: OFFICE OF THE CHIEF ELECTRICAL INSPECTOR GUIDELINES FOR PRESCRIBED AND NON-PRESCRIBED WORK .....	116
APPENDIX G: OCEI – OBJECTIVES AND FUNCTIONS.....	122
APPENDIX H: EQUIVALISED DISPOSABLE HOUSEHOLD INCOME.....	125
APPENDIX I: SURVEY QUESTIONS .....	129
APPENDIX J: T-TESTS FOR CONSUMPTION PER CAPITA .....	133
APPENDIX K: RESIDENTIAL ELECTRICITY CONSUMPTION IN VICTORIA FROM ABS .....	134
APPENDIX L: AFAC AIRS INSTRUCTION MANUAL .....	135
APPENDIX M: METROPOLITAN FIRE BRIGADE ZONES & SUBURBS .....	142
APPENDIX N: T-TEST TABLES FOR PERCENT OF ELECTRICAL FIRES WITH RESPECT TO ALL FIRES.....	143
APPENDIX O: EQUIPMENT INVOLVED IN IGNITION.....	144
APPENDIX P: SHORT-CIRCUITS AND OTHER ELECTRICAL FAILURES COMBINED DATA TABLES AND FIGURES .....	147
APPENDIX Q: SHORT-CIRCUITS DATA TABLES AND FIGURES.....	148
APPENDIX R: OTHER ELECTRICAL FAILURES DATA TABLES AND FIGURES.....	150
APPENDIX S: ELECTRICAL FIRES FOR SUMMER & WINTER MONTHS (540, 550, AND 540/550) DATA TABLES AND FIGURES.....	152
APPENDIX T: SHORT CIRCUITS AND OTHER ELECTRICAL FAILURES COMBINED: WEEKEND AND WEEKDAY DATA TABLES.....	154
APPENDIX U: SHORT CIRCUITS: WEEKEND AND WEEKDAY DATA TABLES AND FIGURES .....	155
APPENDIX V: OTHER ELECTRICAL FAILURES: WEEKEND AND WEEKDAY DATA TABLES AND FIGURES .....	157
APPENDIX W: HEAT OF IGNITION BREAKDOWN AND DATA TABLE .....	159
APPENDIX X: LINEAR REGRESSION OF INCOME VS. FIRES.....	160



## TABLE OF FIGURES

Figure 1: Overall electricity consumption in Victoria, Australia, from 1960-present; data from Australian Bureau of Agricultural and Resource Economics (Schultz, 2009).....	5
Figure 2: Summer electricity consumption for New South Wales, 30 January, 2003 (EMET Consultants Pty Limited, 2004).....	7
Figure 3: Winter electricity consumption for New South Wales, 18 June, 2002 (EMET Consultants Pty Limited, 2004).....	8
Figure 4: Breakdown of electricity consumption among residential end-use equipment in EU-15 yr. 2004 (from Bertoldi & Atanasiu, 2007).....	18
Figure 5: Human impact on fire initiation and loss (TriData Corporation, 1997). ....	29
Figure 6: Cumulative distribution of disposable income in Australia (Australian Bureau of Statistics, 2009b). .....	31
Figure 7: Project overview graphic. ....	34
Figure 8: The percent changes in residential electricity consumption per capita rate in Victoria (1974-2006) .....	40
Figure 9: Flowchart showing progression of households as average household size declines (Department of Sustainability and Environment, 2004).....	42
Figure 10: The percent of homes that contain various high electrically demanding appliances, based on 59 responses from a survey conducted of Metropolitan Fire Brigade employees. ....	44
Figure 11: Distribution of the type of largest television in Victorian homes from survey results. ....	46
Figure 12: Percent of residential electrical fires with respect to all fires that occurred in the MFD per year (1986-2009).....	49
Figure 13: Division 5 ignition factors of fires in MFD (1986-2009).....	50
Figure 14: Number of fires that occurred in each division of the equipment.....	51
Figure 15: Fires started by equipment involved in residential electrical fires (1986-2009).Table 4 .....	53
Figure 16: Percent of residential electrical fires involving electrical distribution equipment (1986-2009)...	55
Figure 17: Percent of residential electrical fires involving appliances (1986-2006). ....	56
Figure 18: Average electrical fires per time of day (mean 10.17, standard deviation 3.92).....	57
Figure 19: Average number of electrical fires per year by time of day for winter and summer. ....	58
Figure 20: Average number of electrical fires per year by time of day for weekend and weekday.....	59
Figure 21: Average number of electrical fires per year by month of year (mean 20.3, standard deviation 3.3). ....	60
Figure 22: Percent of electrical fires by heat of ignition. ....	61
Figure 23: Linear regression of electrical fires per 100,000 people by average weekly income (1986-2009) .....	62
Figure 24: Average education ratio by electrical fires per 100,000 people (1986-2009).....	64
Figure 25: The cost of fires from July 1993 to December 2009 related to the factor resulting in their ignition. standard error bars are included. ....	66

## TABLE OF TABLES

Table 1: Data used in average electricity consumption and number of people per home calculations for Victoria (Schultz, 2009; Australian Bureau of Statistics, 2010). .....	41
Table 2: A breakdown of the average power demanded from various modern universal household appliances (Energy Australia, n.d.; Rainbow Power Company Ltd., 2006) .....	45
Table 3: Equipment definition in each division of Block E of AIRS.....	52
Table 4: Top 15 equipment with their corresponding code from division 4 of the equipment involved in Block E of AIRS. ....	53
Table 5: Electrical fires by maintenance area, average income, average education level .....	65

## **EXECUTIVE SUMMARY**

Residential structure fires due to ignition from malfunction and failure of electrical distribution systems are the source of major property damage and loss of life in metropolitan areas. This project supports the efforts of the Metropolitan Fire and Emergency Services Board (MFB) in Victoria, Australia to investigate the potential risk associated with placing high electrical demand on deteriorating residential wiring systems. Electrical fires are extremely destructive and difficult to predict. Because electrical systems are wired throughout the walls of a house, they also are difficult to detect and are often inaccessible. The walls create a network of passageways for fire to continue to get oxygen and spread completely throughout the house. This makes fires originating from the electrical distribution system extremely costly and dangerous. From MFB's fire incident data, the average cost resulting from an electrical fire is AUD\$11,416. Over time, increasing age of wires and electricity consumption has put a high demand on the electrical distribution systems. Our goal is to make recommendations that can help mitigate the risks of electrical distribution systems failures attributable to overloaded and degraded wiring that cause residential electrical fires.

Other countries have seen similar increases in electrical demand and have tried to counteract the corresponding increases to protect homes against preventable electrical failure resulting from ignition of building material. When properly maintained, older electrical systems operate at the same level of effectiveness as newly installed electrical systems, but it is often the case that older electrical systems are neglected. Different systems require different maintenance strategies for the homeowner to remain safe. As existing technologies advance and electricity demands increase, outdated electrical systems need to be upgraded with new installations appropriate to the increase in electrical demand.

To accomplish our goal, we first examined trends in residential electrical demand in Victoria and their implications. Changes in household electricity consumption from 1996 to 2006 were identified. We analyzed electricity consumption data from the Australian Bureau of Statistics and conducted a survey to characterize the variety and quantity of household appliances in homes today. Next, we analyzed fire incident data provided by MFB to describe trends in electrical fires according to their specific causes of ignition. We also performed

statistical analyses on the incident data collected from MFB. We then synthesized our results using linear regression analysis to investigate possible correlations between changes in electrical demand, the number of electrical fires and societal dimensions, such as income level, education level and cost analysis, which may underlie fire trends. We also conducted interviews with MFB and Energy Safe Victoria (ESV) employees to understand the steps underway to educate the community about electrical fires. Finally, we made recommendations to help reduce the number of electrical fires in Victoria.

The analysis of the census and electricity consumption data revealed that electricity consumption per capita is increasing more rapidly than the population in Victoria is increasing. This has a major effect on residential electrical distribution systems, and from our analysis we assume the increase in the number of electrical fires is attributed to the degradation of wiring systems and to the increased use of household appliances. We also concluded that electrical fires are more prevalent in summer and winters months and that this is likely attributable to the use of air conditioners and heaters. The time of day also has a correspondence with the number of electrical fires. We identified a large increase in the number of electrical fires occurring around 16:00. This is potentially due to the number of people returning home from work and turning on appliances which puts a high demand on electrical systems. Our analysis of the correspondence between average weekly income and education level related to electrical fires revealed that electrical fires are more prevalent as income and education levels increase. This was a surprising result, as it was contrary to what we had obtained from our background research.

The conclusions drawn from our analysis allowed for several recommendations. First, further research must be conducted with a stronger focus on quantitative results that were not feasible in this report due to database inconsistencies, logistical limitations and a narrow project timeframe. A new or improved method of collection and organization of data is necessary; this will ensure the validity of the data and allow for a more accessible dataset. Also, further research needs to be performed by surveying, recovering, and analyzing samples of existing installed residential wiring systems in homes of different ages. Field samples will allow for case studies to draw direct links between deteriorated wiring and associated potential fire risks, where our team could only apply informed inferences and assumptions to draw conclusions. Also, we recommend installation of arc fault detection devices, which will aid in reducing the large

number of electrical fires caused by arcing. Lastly, we recommend that education programs be implemented for the public. No such programs are currently implemented to inform the public explicitly of the potential risks associated with placing a high electrical demand on deteriorating wiring systems. Making communities aware of residential electrical systems and the dangers that come with not upgrading their systems will help reduce the number of electrical fires.

# 1. INTRODUCTION

Residential structure fires due to ignition from electrical failure and malfunction are the source of major property damage and loss of life in metropolitan areas. In the United States, for example, electrical failure or malfunction in the year 2006 alone resulted in 340 civilian deaths, 1,400 civilian injuries and US\$1.45 billion in direct property damage (Hall Jr., 2009). A high number of residential electrical fires from malfunctions and overloads of electrical distribution equipment are seen throughout the world. According to the Fire and Rescue Service of the United Kingdom, during 2005, there were over 47,000 fires in dwellings in the U.K. Of the reported fires, 43 percent were due to an electrical problem (Electrical Safety Council, n.d.). Aging homes are a particular concern in regards to electrical fires. According to the U.S. Census Bureau, half of all homes in the United States were built before 1973. This means that up to half of the homes in the United States are running modern appliances on electrical systems built to sustain pre-1973 technology if the electrical systems were not properly updated. This pattern is typical of countries with older electrical systems and housing stocks. With electricity demands per household increasing, electrical fires will continue to be a major problem in the absence of concerted attention to this problem.

From 1996 to 2004, twenty-three percent of residential house fires in Australia were ignited by electrical faults (Australasian Fire Authorities Council, 2005). Today, Australia is experiencing an increase in the number of electrical fires in residential homes. This can be seen by reviewing fire incident data for Victoria over the past 25 years. Electrical fires are the second most common type of fire in Melbourne, behind cooking-related fires, with their number increasing every year (Jarrod Edwards, personal communication, Appendix D). Residential electrical fires are extremely destructive and difficult to detect in an early stage. Because the electrical system is contained within the walls of a dwelling, a person's view of them is blocked. These walls create a network of passageways for the fire to continue to get oxygen and spread completely throughout the house. By the time the fire is realized, due to smoke, an outlet bursting or the ceiling igniting, there is little hope of recovery since access is limited by the walls. However, electrical fires are preventable with proper legislative requirements, safety considerations and routine maintenance.

The effects of electrical fires in dwellings are a major concern throughout Australia. One main cause of electrical fires is the combination of aged wiring and over-loaded circuits. Part 12 of the Victorian Building Regulations was passed in 2006, making it mandatory that an Annual Essential Safety Measures Report (AESMR) be prepared by property owners for all non-residential buildings built before 1 July 1994, rather than solely for buildings built after this date, as previous building regulations stated. However, there are no existing requirements for residential buildings similar to this regulation, making residential buildings the most under regulated (Jarrod Edwards, personal communication). In 2008, Jeff Watt, a data analyst for Metropolitan Fire Brigade (MFB) in Melbourne, began examining occurrences of fire in different categories of buildings and identified a major increase in electrical fires. Despite the significant effort that MFB puts into education and instruction aimed at minimizing the occurrences of residential fires, Watt discovered that residential fires ignited from wiring were on the rise (Jarrod Edwards, personal communication, Appendix D).

Using the extensive data analysis performed by Watt, MFB has attempted to determine the causes of fires in residential buildings and to identify key trends in electrical fires so that upgrades can be made to improve the safety of the community. Despite increasing efforts in public education on how to minimize the chances of fires, the fire incident data MFB examined showed that residential electrical fires are on the increase. The Community Safety Technical Department at MFB believes that deteriorating wiring within aging homes is a major cause of electrical fires, but the organization currently lacks sufficient evidence to support this hypothesis (Jarrod Edwards, personal communication, Appendix D). This project examined the causes of electrical fires and explored whether older homes are at a greater risk for electrical fires to occur. We researched current and pending legislation regarding electrical codes and standards in Victoria and hypothesized on whether that legislation contributed to a reduction in the increasing number of electrical fires.

The goal of this project was to investigate the potential risk associated with placing high electrical demand on deteriorating residential wiring systems. First, we examined trends in electrical demand and the implications thereof. Changes in electricity demand per household over time were also identified, as these changes represent major changes in household electricity demand. Next, we analyzed fire incident data from MFB to detect trends in electrical fires and

their specific causes of ignition. Subsequently, we determined the societal influences increasing the frequency of electrical fires. Finally, we made recommendations to help reduce the number of electrical fires in Victoria.



## **2. BACKGROUND**

The homes built in the 1960s did not have wiring systems designed for the loads of modern day appliance usage. However, as is the case in Victoria and elsewhere, old wiring systems designed for lower electrical demands are being subjected to current high power consumption. We hypothesized that increases in electricity demands in residential buildings cause increases in electrical fires due to aging electrical wires and outdated electrical systems.

Numerous countries have seen this trend and have tried to counteract the increase in the number of residential electrical fires by implementing codes and standards to protect homes against preventable electrical failure resulting in ignition of building material. As current technologies advance and electricity demands increase, outdated homes need to be upgraded with new installations appropriate to the increase in electrical demand; this may lead to the prevention of overloads on the electrical infrastructure that result in fire.

This chapter characterizes the trends in electrical demand over the past half century and provides a brief explanation of the causes of residential electrical fires as well as changes in electrical systems and legislation. The chapter also provides a comparison of solutions to the problem of residential electrical fires attempted by the United States, United Kingdom, Canada and Australia. Finally, the societal implications of these fires are explored and trends between social class, residential areas and income by household are discussed.

### **2.1 Implications of Increased Electricity Demand on Electrical Fires**

Victoria is the second most populated state in the country of Australia, trailing only New South Wales. Victoria is also home to Melbourne, Australia's second largest city after Sydney. As a result, Victoria is a large consumer of electricity. Electricity consumption in Victoria, shown in Figure 1, increased from 6302 GWh in 1960-61 to 59,090 GWh in 2007-08 (Schultz, 2009). This is an increase of around 1130 GWh (4.8 percent) per year. This dramatic rise in electricity demand has been accompanied by an increase in electrical fires (Jarrod Edwards, personal communication, February 2, 2010, Appendix D). Over that same time period, Australia's real GDP increased steadily at an average rate of 3.4 percent per every 5 year period (Narayan & Smyth, 2005). Given that sustained economic growth is a desired national goal, as

it is for any country, Australia's consumption of electricity can be expected to increase even further.

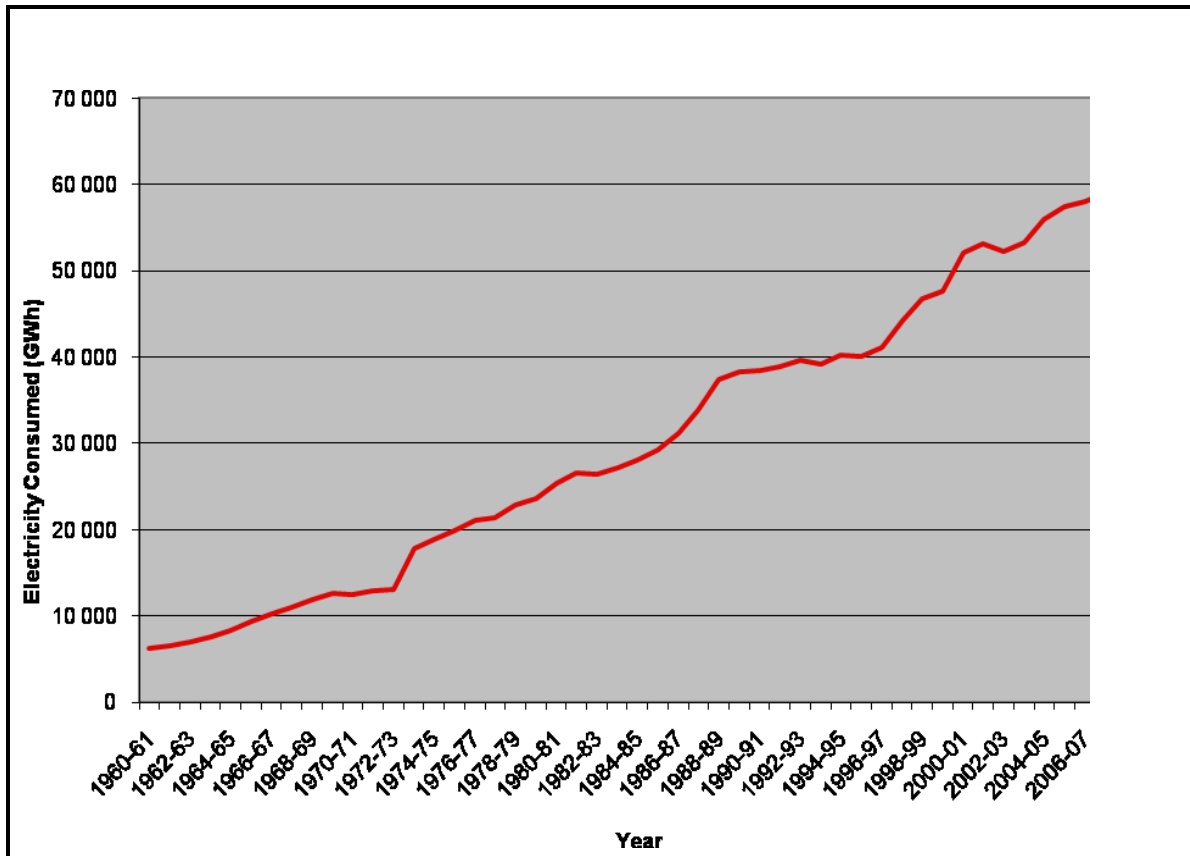

Figure 1: Overall electricity consumption in Victoria, Australia, from 1960-present; data from Australian Bureau of Agricultural and Resource Economics (Schultz, 2009).

### 2.1.1 Electricity and the Occurrence of Electrical Fires

Electricity is a fundamental form of energy observable in positive and negative forms that occur naturally (as in lightning) or is produced (as in a generator) and is expressed in terms of the movement and interaction of electrons. This phenomenon, which we all take for granted, can lead to devastating fires when wiring systems are improperly installed or maintained.

The damage caused by electrical fires is extensive and costly. That is the reason why the prevention and understanding of ignition factors are the key components to stopping residential electrical fires. In the United States, residential electrical fires resulting from electrical malfunction takes an average of 350 lives per year (Electrical Safety Foundation International,

2010). Most electrical fires occur during the winter months when temperatures are colder and there are fewer hours of sunlight (United States Fire Administration, 2008). In the southern hemisphere, winter months consist of June, July, and August. In Victoria, winter weather consists of rainy days, morning frosts, increased wind speeds and relatively colder temperatures (Australian Bureau of Meteorology, 2010). Overall these factors lead to an increase in indoor activities and electricity consumption due to heating and lighting, which can lead to increases in electrical fires. People want to live comfortably in their homes, and as a result turn to appliances, which increases electricity consumption (Bethel, 2009). Electricity consumption is largely dependent on weather and time of day.

Dramatic differences in electricity consumption occur during the summer and winter. Figures 2 and 3 show the electricity consumption for the peak day in summer and winter respectively, for the state of New South Wales, Australia. The summer electricity peak is around 3500 MW for the residential sector, whereas the winter electricity peak is 4750 MW. Since these data are unavailable for the state of Victoria, Jarrod Edwards of the MFB recommended using data for New South Wales because of its close proximity and temperature characteristics similar to those of Victoria; therefore the data from New South Wales are likely to be an accurate representation of the electrical consumption in Victoria.

Appliance usage varies with the season as well. In the winter, hot water, space heating, and lighting are the highest consumers of electricity, whereas the summer, air conditioning and refrigerators are the greatest consumers. The graph of electricity consumption in winter (Figure 3) clearly shows an extreme increase attributable to ovens, heating, space heating and lighting.

A large fraction of electrical consumption is used for lighting, which can be seen in the pink area of Figures 2 and 3. In the summer months, when daylight hours are longer, people use lighting for fewer hours per day with the peak around 2100-2200 hours. In the winter the sun sets earlier, leading to increases in lighting usage around 1700 hours (Figure 3). In both the winter and summer months, lighting is a major contributor to total electricity consumption in the residential sector, especially in the later hours of the day. However, lighting is a greater contributor to electricity consumption in the winter.

In the United States electrical fires are most common in the late afternoon and evening (United States Fire Administration, 2008). One reason is during these times people come home from work and use appliances for longer periods of time. These appliances include televisions, washer and dryer, and kitchen appliances. Many of the appliances are used at the same time (Bhavnagri, 2010). This can also be seen in the electrical consumption graphs, especially in the winter figure. Both figures show an increase around 1600 hours, which corresponds to the time when most people are arriving home from work or school.

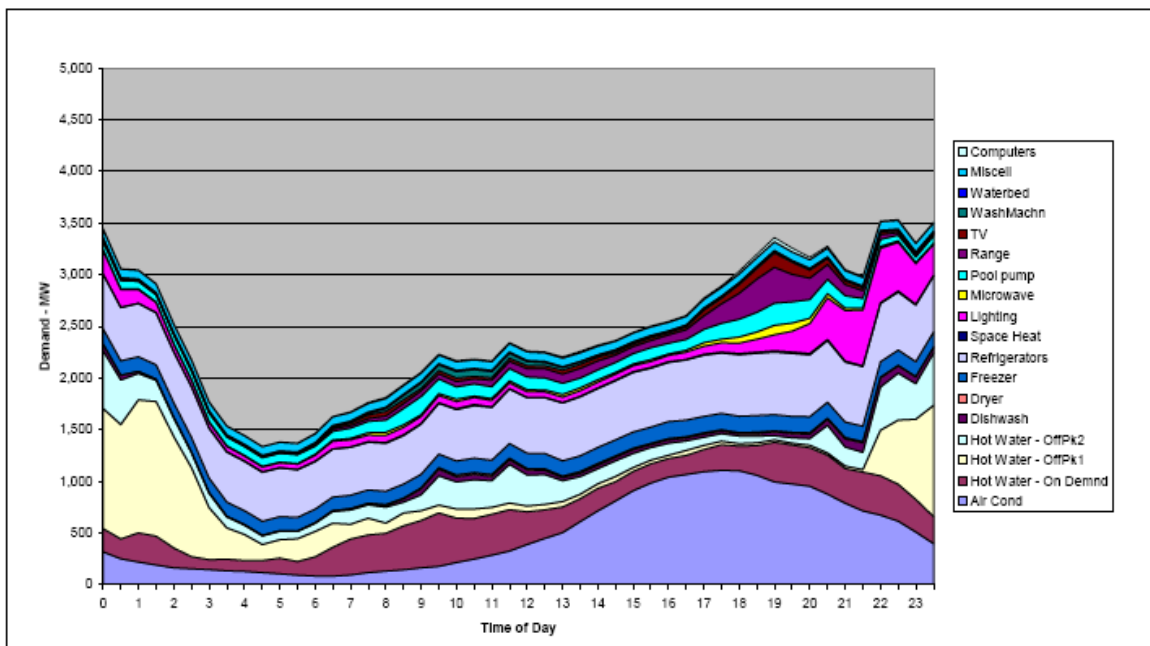

Figure 2: Summer electricity consumption for New South Wales, 30 January, 2003 (EMET Consultants Pty Limited, 2004).

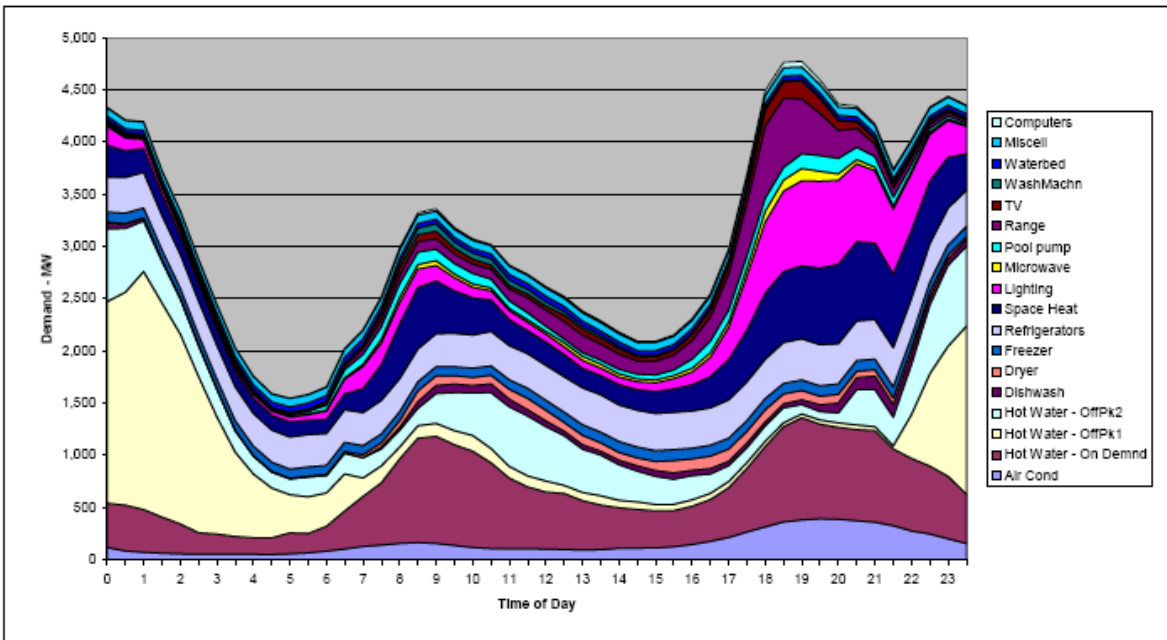

Figure 3: Winter electricity consumption for New South Wales, 18 June, 2002 (EMET Consultants Pty Limited, 2004).

### 2.1.2 Factors Related to Increased Electrical Consumption

The size and characteristics of residential buildings have significant impacts on electricity usage of households. According to the Australian Bureau of Statistics (2009a), electricity consumption increased by 49 percent or an average of 2.6 percent per year from 1988 to 2007. A home with greater floor space will require more electrical energy to heat and cool, assuming the use of electric heating. Also the efficiency of the heating and cooling system directly affects the electricity required to heat and cool the home. Different types of heating and cooling systems have different efficiencies, and the efficiencies of certain systems vary from home to home. In 2008, 37 percent of homes had four or more bedrooms, while 77 percent of all households used a heater and 67 percent used an air conditioner. Household use of heaters and air conditioners is the major contributor (41 percent) to household energy use and costs. Water heating (24 percent) and other appliances (13 percent) were also significant users of household energy (Australian Bureau of Statistics, 2009a).

## **2.2 Causes and Types of Electrical Fires**

The extensive use of electricity and the number of residential electrical fires have been increasing. Our primary focus in this project was electrical fires in residential dwellings due to the number of occurrences of these fires. In the following sections, the causes of electrical fires are discussed. These causes include poor connections of wiring, arcing, carbonization of insulation, sparking and overloaded wiring.

### **2.2.1 Poor Connections**

Poor connections in the wiring of a house can lead to electrical fires. When a connection is not made or is improperly secured in a circuit or wiring system, heating and/or arcing will occur in that specific location due to increased resistance. An oxide will form, which maintains a connection so electrons continue to flow. The localized oxide will continue to heat as electrons pass through the area and will eventually develop into a glowing orange spot. This localized oxide, when contacted with combustible material, will ignite the material. A loose connection leading to ignition is rare since it typically occurs in electric boxes or appliances, but it still poses a significant threat under the right conditions (National Fire Protection Association, 2008).

### **2.2.2 Arcing, Carbonization of Insulation and Sparks**

Arcing occurs when electricity tries to jump a gap in a conductor causing a “high-temperature luminous electric discharge” (National Fire Protection Association, 2008). The temperature of arc is several thousand degrees but varies in temperature depending on voltage drop, current, and conductor type. Because the duration of the arc lasts for milliseconds, most arcs do not lead to ignition of wood and other solid building materials; however, materials such as thermal insulation and cotton with high surface to mass ratios are extremely susceptible to ignition (National Fire Protection Association, 2008). Carbonization of insulating jacket and short circuits are also several causes of arcing.

Due to moisture and various external substances, current can flow over an insulator through a carbon layer that the contaminants have formed. As they grow, these paths cause increased current, which in turn causes arcing and sparks leading to a decrease in the current through the wire to the device or power point. This circular process, which if undetected, will continue until the sparks ignite surrounding building material (Babrauskas, 2001).

Sparks, which are thrown by arcing, consist of pieces of molten metal that are shattered off of a conductor (National Fire Protection Association, 2008). Sparks tend to cool down rapidly because of their small size; however, if there is a combustible material close enough, the spark will ignite that material and fire will ensue.

### 2.2.3 Overloads and Short Circuits

Overloading occurs when the amount of current through a wire or wiring system exceeds that which is safe for the system. If the current becomes large enough for a long duration in a wire, the wire will heat to an excessive temperature and could ignite materials in close proximity. For an overload to occur in a properly installed and rated electrical system the circuit breakers must be faulty. In the case of fuse boxes, which are no longer installed but are still in operation, fuses are manually installed, initially by a licensed electrician, but usually replaced by the homeowner if blown. These fuses are rated by amperage, but a fuse with any rating can be placed in any fuse location in a fuse box, which allows, for example, a fuse rated for 15 amps to be placed in a location that corresponds to a circuit rated for 10 amps. This fuse will not blow during an overload, and the power to the circuit will be sustained. In circuits, the small conductors of wires will heat up without the fuse or breaker tripping because the load is not great enough. The wires will heat and potentially ignite surrounding materials (National Fire Protection Association, 2008). Similarly, modern circuit breakers are installed to detect and prevent overloads. Circuit breakers are safer than fuses since they cannot be used for the incorrect sized circuit.

A low-resistance, high current fault in a circuit is called a short circuit. This occurs when two conductors, such as wires with electricity flowing through, come into contact. A path forms between the two. If the wires are removed immediately an arc will form where the path of electricity was flowing. Circuit breakers are designed to protect against long arcing of short circuits (Babrauskas, 2001). According to *Consumer Fire Safety: European Statistics and Potential Fire Safety Measures*, such short circuits are the most common cause of fires that originate from electrical wiring.

Overloads and short circuits can also occur from the misuse of power boards in homes. Investigations of incidents involving power boards by the Office of the Chief Electrical Inspector (OCEI) and fire authorities reveal the misuse of boards is prevalent in the home (Office of the

Chief Electrical Inspector, 2005b). When homeowners do not have enough power points to satisfy the desired number of appliances, they may resort to using power boards, known as power strips in the United States. Power boards are an inexpensive and convenient way to have more appliances plugged into a power point at one time. Homeowners sometimes plug one power board into another, which can lead to overloading the circuit. Modern power boards are equipped with a surge protector that prevents overloading when demand exceeds capacity. Older model power boards do not contain surge protectors and therefore do not protect against overloading. Due to their portability and upward facing sockets, power boards are more prone to damage, contamination, and wear and tear than fixed socket outlets (Office of the Chief Electrical Inspector, 2005b).

#### 2.2.4 Combustible Materials

The heat from electricity flow only summarizes one of the two key components needed to ignite an electrical fire. The other component is a consumable: the material ignited by the arc and heat. Since wiring is confined within the walls of a residential building, the main ignitable materials in an electrical fire are the structural components of a building. Building materials, such as wood and thermal insulation, are the primary combustible in residential electrical fires. In a U.S. study of 28,300 residential electrical fires, 44.7 percent of first ignited materials were the structural components or finishes. Of that 44.7 percent, 30.2 percent of first ignited materials were the electrical wiring and thermal insulation. Other primary ignition factors include furniture, clothing, piping, and various combustible liquids (United States Fire Administration, 2008).

#### 2.2.5 Faulty Circuit Breakers

Electricity flowing through a wire will create heat due to the resistance resulting in kinetic energy changing to thermal energy. If a higher load is put on a circuit than it is rated for, and a faulty circuit breaker fails to trip, heating of wires can occur. If the current through the wire is higher than the current that the wire is rated for the heat can cause the protective Polyvinyl Chloride (PVC) jacket to degrade to the point where there is no longer insulating material between the conductors and building material. With no insulating material to protect the building material, arcing and heating will ensue and potentially result in ignition and arc tracking, which is internal arcing between the wires. In addition, as the wire heats up, its electrical resistivity will increase as well, in turn causing the heat to intensify. This overloading



and heating of wires can be prevented if the wiring system is maintained and circuit breakers are properly installed to appropriate circuits. A flowchart of the ignition process of an electrical fire is shown in Appendix E.

## **2.3 Evolution of Electrical Systems in Australia and the United States**

An electrical system can be described as any utility that provides electricity. The type of electrical systems being installed in residential dwellings can vary between countries. Commonly, countries adopt different types of electrical systems from other leading countries with developed wiring systems. Canadian wiring methods are similar to those developed in the United States, as Australian wiring methods are similar to those developed in the United Kingdom. This section will compare and contrast the evolution of wiring systems in the United States and Australia. The main wiring systems focused on in this report are Australian wiring systems; therefore the evolution of electrical systems in the U.K. will be omitted from this section. The United States will be considered due to the availability of information regarding their electrical systems, and therefore the evolution of Canadian wiring systems is unnecessary. As technology has evolved, new and more efficient electrical systems have been developed to meet the changing demand driven by this technology. At the time of construction, electrical systems are installed or designed to meet the existing electricity demands. When all aspects of an electrical wiring system, such as circuit breakers or wiring, are maintained or replaced when necessary, older electrical systems operate with the same efficiency as newly installed systems. However, older electrical systems are often neglected.

### **2.3.1 Electrical Wiring Comparison**

Since the mid twentieth century, there have been a number of stages in the evolution of household electrical systems in Australia and the United States. One of the earliest residential electrical systems in the United States was an open wiring system called “knob and tube”, which was installed in dwellings up until about 1945 (Oglesby, 1994). This system consisted of wiring that ran along or through wooden floors or wall framing. When the wires passed through these frames they became susceptible to moisture and abrasions, which could lead to leakage of current and arcing fires. For this reason the wire was protected by ceramic or porcelain tubing, placed through the wood frames. It was an open system, the wires would be spliced and soldered together and surrounded with electrical tape. The “knob and tube” system is similar to the

cotton-covered electrical system used in Australia. Cotton-covered electrical wiring consisted of solid conductors covered with woven and twisted cotton strands. When the wiring system ages, even under normal operating conditions, the cotton deteriorates exposing the conductors. When using both the cotton-covered and “knob and tube” electrical systems, the risk of ignition is increased when thermal insulation is added due to the high probability of current leakage and arcing. Both wiring systems are dangerous and are no longer used in new installations. The U.S. National Electrical Code (NEC) has not permitted “knob and tube” wiring since the mid-1970s (Dini, 2008). However, both “knob and tube” and cotton covered electrical systems can still be found in older homes today, since there is no requirement for the removal of old electrical systems.

To fill the short-comings of “knob and tube”, nonmetallic and armored cable systems were introduced in the United States, in 1899. An armored cable wire consisted of two or three insulated wires encased in flexible steel armor, which acts as a ground conductor. When armored cable was invented, it was known as BX and has been formally known as Type AC ever since problems developed with installation practices of the BX version (Dini, 2006). The insulation that surrounded the wiring was subject to thermal aging and cracking. Also the cutting and fastening of the system led to many nicks in the insulation and conductors, allowing circuit openings and shorts to occur. BX wiring is still commonly found in homes today. The armored cable system can be compared to rubber insulated cables used in Australia, which were introduced in the 1940s. During the vulcanization process, rubber is combined with sulphur and other ingredients to change the properties of the rubber. Vulcanized rubber does not absorb moisture and is a better insulator than previous types of insulating jackets. The disadvantage of rubber-insulated cable is that over time the insulation does not retain or absorb any moisture, therefore it will dry out and crack similar to the insulation surrounding the wires in the armored cables. When the rubber cracks and falls off the conductor, wires are exposed to each other as well as surrounding building material, which could start an electrical fire (Inquiring Eye Home Inspections, LLC, 2010).

Australia went through more stages of electrical systems than the United States before establishing an electrical system that is commonly used today. When people in Australia began to realize the dangers of rubber-insulated cables, they started using another type of electrical

system, which used PVC-insulated conductors. PVC is flame retardant and resists water and many chemicals. When compared to rubber-insulated cables, PVC-insulated cables do not dry out or crack as easily. However, PVC is not flame retardant once temperatures are above 75 degrees Celsius. (Inquiring Eye Home Inspections, LLC, 2010)

To correct this problem, Thermoplastic Sheathing Systems (TPS) were introduced in Australia around the mid 1980s and are the standard for current installations. TPS systems have an outer layer that is moisture resistant and flame retardant, similar to PVC, however, TPS can withstand temperatures of 90 degrees Celsius. Inside the outer layer there are two or three insulated wires, one of which is a grounding wiring. When this type of wiring is installed in residential dwellings, it is usually one of two types, Flat TPS or Round TPS. Flat TPS systems are more common than Round TPS systems and are used for the fixed wiring of domestic and industrial lighting, power outlets, and heating. Round TPS systems are less common and are generally used where glands, or connections involving terminals, are required (Peppers Cable Glands Ltd, n.d.).

The most commonly used electrical system in the United States is the nonmetallic-sheathed cable, invented in 1922. Nonmetallic-sheathed cables contain similar characteristics as the PVC and TPS insulated cables used in Australia. Nonmetallic-sheathed cables generally referred to as Romex or Type NM cable have not had many changes since 1922 besides general properties such as the size of the cable (Dini, 2006). Romex is used indoors and consists of two or three wires inside a PVC jacket each with separate PVC insulations; if the cable has three wires then one is a grounding wire. Romex can be used inside walls and air voids in masonry block. It can also be used underground or in wet areas but an Underground Feeder or Type UF wire must be used. Type UF wire consists of two or three wires, as is Romex, but Type UF is jacketed with gray PVC that is sunlight, moisture and fungus resistant, and the inner wires have a tougher individual insulation. This wiring system is not immune to mechanical malfunction or improper installation but it is the safest and most advanced system (Paige Electric, n.d.).

The latest electrical wiring systems used in Australia and the United States are very similar, with both countries using a PVC-type of insulating jacket. Since the respective wiring systems have progressed rather similarly, Australia and the United States both have out-dated

wiring systems designed for much lower amperage being subjected to today's high electricity demands (Inquiring Eye Home Inspections, LLC, 2010).

### 2.3.2 Circuit Comparison

Many countries throughout the world use different types of circuits within individual dwellings. An electrical circuit is defined as a closed loop formed by a power supply, wires, a fuse, a load and a switch. The wires in a home are installed in the walls to supply power to individual rooms. The nest of wires throughout the home is broken up into various circuits. In modern homes, the fuse would be the circuit breaker, and the loads would be the appliances or lighting in the home. It is common that circuits are broken up by rooms, or areas of the house. Circuits are rated for different loads depending on the gauge (or cross-sectional area) of the wire used and the load required by the circuit. Different areas of the world use different potential differences (voltages), which also affects the size of the wires required. Where higher voltage is used in the circuits, less current will be demanded to obtain the same amount of power for the appliance. This can be seen by the equation which states the power consumed is proportional to the voltage, or potential difference, from the live or active wire to the neutral, multiplied by the current flowing through the wire.

In the United States, circuits use 110 volts, with the most common circuit sizes being 15 and 20 amps. However, larger circuits are used for larger appliances such as electric ovens, electric water heaters, and permanent air conditioners. These types of appliances are often wired on a 50-amp circuit. A 10-amp circuit is very rarely used due to its inability to deliver enough power using 110 volts. A 15-amp circuit uses 14 gauge copper wire (cross-sectional area of  $2.086 \text{ mm}^2$ ) at a minimum, and is meant to carry small loads for lighting and light-duty appliances. A 20-amp circuit uses 12 gauge wire (cross-sectional area of  $3.3 \text{ mm}^2$ ) at a minimum, and can carry loads for larger lighting fixtures, larger appliances, and can be wired to supply power to more power points and can withstand demands from larger appliances.

In Australia, circuits use 240 volts, which makes the amount of current needed for the appliances much different from that of the U.S., as this is more than double the voltage that American circuits use. In Australia, circuits use many different circuit sizes for specific purposes. They can use a 10-amp circuit for just a few light duty lighting fixtures. For 10-amp circuits they typically use  $1 \text{ mm}^2$  cables. However the amperage a circuit can be rated for is dependent on

not only the size of the wires, but whether they are in the air, in thermal insulation partially surrounded or completely surrounded, and several other factors. A 16-amp circuit will also run lighting but is capable of handling larger and more lights, and will typically use 1.5 mm<sup>2</sup> wires. Twenty amp circuits are used for wiring power-points and larger circuits, and are capable of withstanding much greater loads. Typically one uses 2.5 mm<sup>2</sup> wires for a 20-amp circuit (Joint Technical Committee EL-011, 2009). Due to the higher voltage used in Australia, circuits with smaller amperage ratings can accommodate the same power demands. This can be seen by the formula described above, that power supplied is equal to the current wires to supply the same power multiplied by the voltage ( $P=IV$ ). This explains why Australia uses thinner wires than those in the United States to supply the same amount of power to electricity consumers (lighting and appliances), since the current flowing through the wires will be less. As a result of Australian wiring practices, Australian homes cannot handle more appliances than United States homes (Edwin Dodd, personal communication)

The purpose of the circuit breaker is to limit the load on the overall systems, to prevent a sustained overload on the system. Theoretically, when the load on the circuit becomes too great for the system to handle, the circuit breaker, similar to a fuse, will trip, essentially cutting power to the circuit. A circuit breaker trips when the bimetallic strip within it heats up to a certain temperature due to too much current flowing through it, causing it to bend. This strip is attached to a series of levers, latches, and springs, that mechanically separate electrical contacts, opening the connection between them, killing power to the circuit. The circuit breaker is the safety measure built into the system to prevent the wires from being overloaded. They were first manufactured for home use by Square D, in 1935 (Midwest Electrical Testing & Maintenance Company Inc., 2010). If a circuit breaker is faulty, there is nothing preventing the wires from being overloaded, which can be very dangerous.

## **2.4 The Effects of Time on Electrical Systems**

Age and the increase in electricity consumption due to the increase in the number of appliances are two problems that depreciate electrical wiring systems, which create the potential for an electrical fire to occur. Countries have noticed these problems and have tried to make changes in legislation to protect against electrical fires.

#### 2.4.1 Aging Electrical Systems

One problem that can occur is connections becoming loose over time, or even disconnecting. Vibrations from outside influences such as, loud music, thunder, passing trains, and loud jets flying overhead, can cause connections within the walls to loosen. The expansion and contraction from temperature changes either daily or seasonally can also contribute to the loosening of connections. Constant use of switches and outlets can potentially loosen or even disconnect the wires as well. When connections become loose or disconnect, arcing can occur which will result in a fire.

The deterioration of wires' insulating jacket is another problem associated with aging electrical systems and can result from repeated movement or contact with a hard, sharp or abrasive surface. Additionally, if the wires are subjected to light or another heat source, the rate of drying and cracking can increase. This is a major concern in hot and dry climates present in parts of Australia. If wires are in a moist location then water can be absorbed into the insulation and cause a reduction in its insulating strength (Andrews, n.d.). Deterioration of the insulation can also be caused by rodents or other creatures sharing the space between the walls with the wires. Dried out wiring can crack when disturbed by any movement, which will expose live conductors. Exposed conductors are likely to arc when contacted by other conductors, which can ignite building materials in the vicinity.

#### 2.4.2 Behavior and Electrical Demand Changes

Increasing population is one factor that has contributed to the increase in electricity demands over the past half century. Along with population increase, the number of appliances people use continues to grow, which is causing the electricity consumed in residential dwellings to increase (Carr, 2009). There are more residents using electricity and the number of appliances and amount of lighting being used has also changed from past years.

A wiring system installed in the 1960s was likely intended for the use of small lights, a small television, and other relatively small appliances plugged in around the house. In the 1980s computers were introduced and started consuming energy in homes at faster rates. However, this increase was slow, since computers became part of everyday life gradually. Today, it is common for bedrooms throughout a home to have large televisions, computers, large stereo systems, air conditioners, and many more appliances, some of which did not even exist during the time of

construction. Shown in Figure 4 is the breakdown of the consumption of residential end-use equipment.

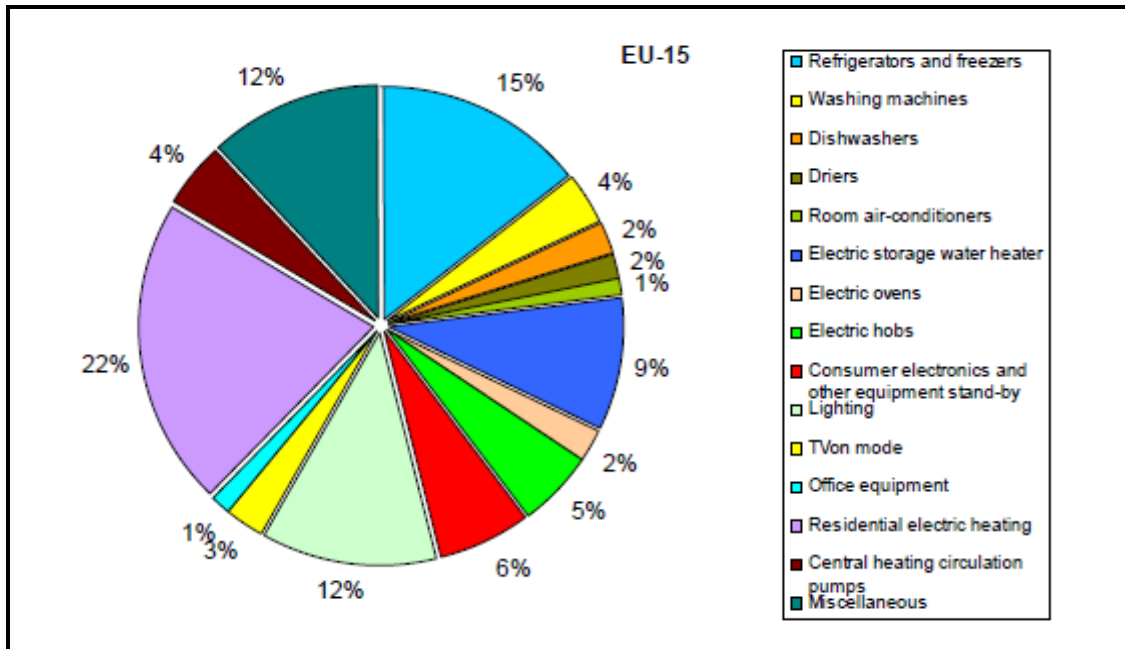

Figure 4: Breakdown of electricity consumption among residential end-use equipment in EU-15 yr. 2004 (from Bertoldi & Atanasiu, 2007).

In some cases, technological advancements have made newer appliances more efficient in power consumption. However, in many cases new appliances are bigger in capacity. Furthermore, consumers are using more appliances in their households than in the past, thus raising the loads on older electrical systems (Patel, 2005). To deal with the increase in electrical demand from appliances, homeowners add more circuits and outlets to existing electrical systems. If an outlet is improperly added to an existing circuit, then the load can easily exceed that for which the wiring was designed. Refrigerators and air conditioners, which have increased in size, account for a significant amount of electricity consumption (Bertoldi & Atanasiu, 2007). Increased number and size of appliances creates a huge increase in the electricity consumed by a home and demand on the electrical systems that are already deteriorating. This combination can lead to electrical fires.

### 2.4.3 Global Comparison

Countries around the world have been experiencing problems similar to those of Australia. The National Science and Technology Council's Wire System Safety Interagency Working Group stated in 2000 that aging wiring was a major safety issue for the United States (Rasdall, 2005). Populations are increasing, residential dwellings are aging, and electrical fires continue to be a major problem all around the globe. In this section we focus on four countries: Canada, the United States, the United Kingdom, and Australia.

Canada's electricity consumption since 1990 has increased 1.2 percent per year (Natural Resources Canada, 2009). Electricity consumption in the United Kingdom increased by 2 percent each year from 1980 to 2001 (Department of Trade and Industry, n.d.). In 2001, 107 million U.S. households consumed 1,140 billion kWh of electricity (Energy Information Administration, 2005). These data suggest that energy consumption has been increasing throughout the developed world. In each of these cases, energy consumption is greater during cold weather than warm. The increase in electrical demand has put a huge strain on the electrical systems in residential dwellings around the world.

Aging dwellings containing deteriorated electrical systems that have not been updated and problems such as corrosion, loose wires, and the deterioration of wires' insulating jackets, can be seen in all these countries. Canada and the U.S. have taken similar steps to prevent residential electrical fires, such as the implementation of arc-fault current interrupters (AFCI). The International Electrotechnical Commission (IEC) is currently in the process of developing a product standard for an arc fault detection device (AFDD). This is the same device as the AFCI. If the standard is passed then requirements for the installation of AFDD's will be included in the IEC 60364, which contains codes and standards on electrical installations for buildings (Reinhard Pelta, personal communication). Most European countries reference the IEC for development of their codes and standards. AFCIs detect arc faults using "advanced electronic technology to monitor the circuit for the presence of 'normal' and 'dangerous' arcing conditions" (National Electrical Manufacturers Association, n.d.). "Normal" arcing can be found in motor driven devices such as a vacuum and "dangerous" arcing is known as parallel arcing, or arcing between conductors.



## **2.5 Legislative Context**

Countries have approached the goal of limiting the damages caused by electrical fires by ignition of building material in several ways. By examining the legislations in select countries, determining what measures have been taken to improve their legislation, and analyzing the impact of the alterations, the team will make recommendations for possible changes in Victorian legislation. It is necessary to evaluate a broad range of legislation to completely understand what countries have done to limit electrical fires. To assure the best possible recommendations are made to Victorians legislature, we chose to explore the legislations in place in the United States, Canada, the United Kingdom and Victoria.

When referring to codes and standards it is important to distinguish between the two. A definition of a code is “a systematic collection of regulations and rules of procedure or conduct.” A code is very broad in scope and is usually intended to become a law. In comparison, a standard is defined as “something established by authority, custom, or general consent as a model or example.” A standard is very narrow in scope and covers a limited range of issues. Codes usually reference standards. Codes and standards are both written by organizations and do not have value unless adopted by local authorities or implemented into law.

### **2.5.1 Prescriptive versus Performance-Based Design**

Throughout the world residential electrical codes and standards are based on two design models: prescriptive design codes and performance-based design codes (Industry Commission, 1995). Prescriptive codes are defined as “the inputs and processes of an activity, specifying the technical means used in undertaking an activity (as in mandatory speed limiters or restrictions on vehicle engine capacity),” where performance-based codes “specify an outcome in precise terms (as in a speed limit)” (Industry Commission, 1995). It has not been until recently that countries are beginning to use more performance-based codes, such as the United States, United Kingdom, Canada, and Australia. Countries are implementing performance-based codes because they provide better guidance to obtain safety by giving firm explanations and explicit boundaries. Also, performance-based design codes can be less costly because it allows for requirements that are not applicable to certain situations to be removed. The designs of buildings are becoming more complex due to the advancement of technology. The complexity of the design makes solutions for obtaining safety within the building difficult. Performance-based codes allow for

more flexible solutions to obtain safety by permitting more than one avenue to achieve the same safety measure. In comparison, prescriptive codes are complex and have specific requirements that are hard to understand. The lack of flexibility of the codes makes it difficult to obtain safety because the codes are open for interpretation, which could be inaccurate. Local authorities such as licensed electricians and engineers are responsible for the implementation of fire safety requirements.

### 2.5.2 United States

The United States has a federalist system, where many regulatory frameworks are designed at the state level. Most safety regulations are implemented by state governments. For this reason safety regulation in the United States can vary by state. As new materials and installation techniques are developed, safety codes and standards are developed to complement these advances. The American National Standards Institute (ANSI) is a voluntary federation that oversees standards; however ANSI is not responsible for writing the standards. Standard Developing Organizations (SDO) work together to develop standards that will address all requirements of the different organizations such as the Institute of Electrical and Electronic Engineers (IEEE), InterNational Electrical Testing Association (NETA) and National Electrical Contractors Association (NECA). The organizations send the standards to ANSI to be approved and recognized as an American National Standard (ANS). ANSI is the single official representative of the United States (Rasbash, et al., 2004). Most codes in the United States are designed for new buildings, and for many years have been prescriptive, meaning that codes are established for specific building requirements and construction methods. Only recently has there been an effort to change to more of a performance based concept, since prescriptive-based codes hinder the ability to update or change existing buildings.

The National Fire Protection Association (NFPA) is an organization that was established in 1896 and is responsible for the publication of 300 codes and standards intended to reduce the risk of fires (National Fire Protection Association, 2010). The NFPA 70, or the National Electric Code (NEC), is the “world’s most widely used and accepted code for electrical installations” (National Fire Protection Association, 2010). The NEC is used in the United States, Mexico, Costa Rica, Venezuela, Columbia, and some countries in South America (Comeau, 1999). NFPA codes are widely adopted and are referenced by the building code in any given state. All NFPA

codes and standards are developed and reviewed every three to five years by approximately 7,000 volunteer committee members with a wide range of professional expertise (National Fire Protection Association, 2010). They are developed using an open, consensus-based process and authorized by ANSI.

### 2.5.3 Canada

Canada has one of the best standards of construction in the world and a high degree of uniformity in building construction and fire safety across the country (National Research Council Canada, 2010). Before Canada became known for their uniformity in building construction and fire safety, there were many variations of codes and standards within Canada. Then the National Research Council of Canada (NRC) and the Canadian Commissions on Building and Fire Codes (CCBFC) developed a set of codes and standards that are accessible for provinces and territories to adopt to suite their local needs. The CCBFC is a committee organized by the NRC, they are responsible for developing and updating codes in Canada. The NRC and CCBFC have established codes for six areas: plumbing, building, fire, energy in buildings, energy in houses, and farming. The Canadian Standard Association (CSA) focuses on the publication of codes and standards based on electricity, gas, and elevator systems. The codes and standards are performance-based, revised to address new technologies and methods. Codes and Standards are reviewed at least every five years by a CSA standards development committee (Canadian Standards Association, 2009). These codes and standards are designed not only for the construction or demolition of buildings, but they also apply when buildings are renovated or altered.

### 2.5.4 United Kingdom

The United Kingdom adopts and follows codes published by the International Electrotechnical Commission (IEC). The IEC is an international organization which publishes codes and standards for all electrical devices (International Electrotechnical Commission , 2010). IEC 60364 is the specific IEC code and standard on electrical installations for buildings. Many organizations within Europe, such as the British Standards Institute (BSI), reference IEC codes and standards. The BSI is an organization that works with the government to develop standards. The BSI helped in the development of new regulations by contracting a design team to develop a draft code of practice for the application of fire safety engineering principles to building fire safety design (Meacham, 1998). BSI publishes the BS 7671 which regulates electrical

installations and is closely related to the IEC 60363. Before 1985 safety regulations in the United Kingdom were prescriptive and were written in a language mainly understood by lawyers (Hadjisophocleous & Bénichou, n.d.). New regulation was published in 1985, and then again in 1991, where alternative methods were considered based on fire safety engineering principles (Meacham, 1998).

#### 2.5.5 Victoria, Australia

In Victoria today, electrical regulation and safety is being maintained through Energy Safe Victoria (ESV). Through various television commercials and rebate programs, ESV is trying to educate the community on electrical fires and Home Safety Inspections and reduce electrical fires in the state of Victoria. When new Electrical Safety Regulations are passed and enforced, ESV and the National Electrical and Communications Association (NECA) hold free seminars to educate the electrical industry on the new regulations. Experts are in attendance to be able to answer questions that the audience has about the new laws.

ESV also has a Home Safety Inspection (HSI) program. These programs are designed for numerous purposes such as: to reveal if any electrical circuits or equipment is overloaded, to find any potential electrical hazards in the electrical installation, to identify any defective do-it-yourself (DIY) electrical work and to highlight any lack of earthing or bonding (Energy Safe Victoria, 2010).

Under Victorian electricity safety regulations, an electrician must provide a certificate of electrical safety to the customer when any work is done to the home. There are two types of certificates; one is for prescribed work and the other is for non-prescribed work. Prescribed work consists of major changes to the electrical system where you cannot switch off the electricity. Prescribed work is performed on the main switchboard and wiring from the pole to the dwelling. This includes all work done on wires up to the switchboard. Non-prescribed work consists of minor changes to the electrical systems where you can turn off the electricity. This includes installation of safety switches and power points. The major reason for differentiating between prescribed and non-prescribed work is that non-prescribed work does not need to be inspected (See Appendix F) (Energy Safe Victoria, n.d.).

Thirty-two Home Safety Inspection (HSI) companies in Victoria provide these inspections at a cost of AUD\$500 and no incentives are offered for their services. Home Safety Inspection companies, such as Archi Centre, conduct visual inspections of homes per voluntary request of customers. This service is almost always requested by a prospective buyer of a home, and if something is found wrong regarding electrical wiring, only recommendations to have a licensed electrician inspect the wiring further are made. Residential electrical wiring inspection procedures include an examination of a switch box to detect the presence of a Residual Current Device (RCD), a test of power points using a commercially available power point testing tool and an examination of any cases of exposed or potential cases of “do-it-yourself” wiring. According to David Hallett, a State Manager with Archi Centre, electrical faults are detected in about a third of the homes inspected and have never been upgraded (David Hallett, personal communication). If a home passes, a certificate is issued identifying the home as being electrically sound. ESV recommends that home safety inspections take place for the following reasons: the property is more than 25 years old, the wiring is old, concerns about installed equipment, prior to selling a property or when buying a previously occupied property, or if none of these apply, at a five year interval. These recommendations are provided to help ensure that homes’ electrical systems are safe. The HSI companies will not restore the electricity back to a home unless it is in a safe condition. Then measures need to be taken to correct the electrical system before the HSI companies restore the power (Energy Safe Victoria, 2010). Through regulating electrical legislation, home safety inspections, and educating the public, ESV is making Victorian homes safer to live in.

#### 2.5.6 Privatization of the Electricity Industry

From 1990 to 2005, many changes to the electricity industry in Australia occurred. These changes include the privatization of the generation, distribution, transmission and retail of electricity. Additionally, in 2005, there was the merging of the Office of the Chief Electrical Inspector (OCEI) with the Office of Gas Safety (OGS). These changes greatly affected Victoria and its electrical infrastructure.

In the early 1990s reforms began in the electricity market when a program known as “Project Victoria” was initiated by the Kennett government (Beder & Cahill, 2005b). This program was designed to deregulate and privatize the electricity industry, beginning with

separating of the State Electricity Commission of Victoria (SECV) (Beder & Cahill, 2005a). The SECV was a government body, established in 1920, that controlled all aspects of the energy sector including generation, distribution, transmission and supply of electricity (Edwards, 1969). During the period of 1920 to 1994, the SECV was responsible for the inspection and maintenance of industrial and residential electrical distribution systems from power generation to retail. Due to the privatization in 1994 the SECV was disbanded into two transmission companies, Generation Victoria and National Electricity, and Electricity Services Victoria, which was responsible for distribution and supply of electricity (Beder & Cahill, 2005a). The Office of the Chief Electrical Inspector (OCEI) was established during the existence of the SEVC and was responsible for the regulation of electrical safety in Victoria. After privatization and in accordance with Electricity Safety Act 1993 the OCEI became an independent regulator of electrical inspection and installation (Gardner, 2005). Energy Safe Victoria (ESV) was established on 10 August 2005 with the merger of the OCEI and the Office of Gas Safety (OGS), and operates under the Electricity Safety Act 1998, which is an updated version of the Electricity Safety Act 1993, and Gas Safety Act 1997, respectively (Energy Safe Victoria, 2006). The Electricity Safety Act defines the objectives and functions of the OCEI, a detailed list of which can be found in Appendix G.

There were many driving forces behind the privatization of the electricity industry and the public was not necessarily one of them. According to Beder & Cahill (2005), "...electricity privatization in Australia did not arise out of popular struggles or discontent. Rather, leading fractions of capital played a key role in advocating and supporting privatization, particularly the financial markets, the media and energy intensive industries". The need for privatization was driven by the possibility of debt reduction and efficiency improvement, however, the validity of these driving forces can be questioned. These driving factors behind privatization were, in some cases, embellished by the government and focus was diverted from real areas where reform was potentially needed. The Business Council of Australia (BCA) formed the Electricity Task Force in 1990 to perform efficiency studies on the electricity industry and evaluate their performance against other leading nations and establish Australia's competitive level against them (Beder & Cahill, 2005). The studies performed by the BCA found obvious areas in need of improvement in the Australian system when compared to other extremely efficient industries around the world.

The BCA also recommended that the appropriate solution would be to open the Australian electricity industry to the private sector for an increased level of competition because government control eliminated the possibility of internal competition (Beder & Cahill, 2005). In reality the State Electricity Commission of Victoria had been running smoothly and from 1985 to 1994 “had reduced staffing, cut operation costs, reduced reserve plant margins and cut average electricity prices by 3 percent a year” (Beder & Cahill, 2005). There were also hidden agendas regarding the privatization of the electricity industry beyond efficiency concerns and taking steps to upgrade the industry as a whole. Furthermore, there was no consideration taken to the possible deterioration of the installation or inspection practices with the conversion from the public to the private sector. Potential reasons behind the government push for privatization had less to do with improving operation and more to do with discouraging union power with a high focus on a short-term influx of funds (Beder & Cahill, 2005). This influx of funds would primarily come from the government no longer held responsible for maintenance of the infrastructure rather than direct government profit from the disaggregation of the electricity industry. The cost of maintenance and other elements would be pushed onto the customers by the private companies because of the short-term profit mindset of capitalism.

Privatization also went against public opinion, which was rightfully concerned with price increases and weakening of the electricity infrastructure as a whole. One of the main consequences of the privatization was a higher cost to the homeowner on all fronts, including installation of electrical systems. According to a 1994 Saulwick Age national poll, over two thirds of those surveyed favored public ownership, and an Economic Planning Advisory Commission (EPAC) study the same year had also found that most Australians supported government provisions of infrastructure (Beder & Cahill, 2005b). Capitalism is based on the assumption that the private market can provide services more cheaply than the government; however, the reduced prices for services do not come without a cost. The cost of the initial reduction was neglect of the delicate infrastructure of the electricity industry. In 1998, several companies were sold at a loss trying to keep wholesale prices low, despite fluctuating hourly prices, with remaining companies cutting overhead cost by decreasing maintenance programs which resulted in black outs and equipment failure (Beder & Cahill, 2005a). After the privatization of the industry, some government regulations remained, such as safety net pricing

caps. The private companies were responsible for these price caps; however, in order to maximize their profit margins, they created clever schemes to keep the average price under the cap. Some companies even increased off-peak pricing by 175 percent while decreasing peak rates to keep the average under the price cap; by 2001 the price of electricity had increased by 60 percent (Beder & Cahill, 2005a). The failing private electricity retailers were bought by other private retailers, which essentially recreated what the privatization scheme disbanded in the first place: a consolidated electricity market.

The idea that privatization would decrease the Australian debt was also an extremely appealing concept, which proved to be rather successful, with net reduction in debt of AUD\$4.86 billion as a result of the privatization (Roarty, 2003). The privatization simply shifted the cost of the electricity industry from the Australian government to the taxpayers of Australia. Clearly, the public would not support this shift but the government did, making the government owned and operated electricity, history.

The privatization also brought with it new requirements for the electricity industry. Prior to 1999, there was no distinction between electrical installations and every installation was inspected, no matter how minor, therefore assuring a high degree of electrical safety and quality. As of 1999, electrical contractors were required, by the OCEI in accordance with the Electricity Safety Act, to issue a certificate of electrical safety for all electrical work (Gardner, 2005). The distinction must be made as whether or not the work is prescribed or non-prescribed in the certificate. The non-prescribed installations consist of small electrical work, with customer control at the highest and prescribed installations for complex electrical work with the customer having little or no control over the installation. In 2006, only 5.3 percent of the 495,157 non-prescribed installations were audited, or inspected (Energy Safe Victoria, 2006). Of the 5.3 percent of audited, non-prescribed installations, 93.31 percent were compliant (Energy Safe Victoria, 2006). This certification process is still used on current installations and renovations. An example of prescribed and non-prescribed installations is located in Appendix F.

There are numerous conclusions drawn from the privatization of electricity supply companies in Victoria; however, the most relevant to our research is the effect it has had on the maintenance of the infrastructure. The separation of each component of the electricity industry



allows for the private companies to ignore investments in the infrastructure and allow for a higher focus on profit because the companies, individually and as a whole are not held responsible. Furthermore, separating the industry into the four sections (generation, transmission, distribution and retail) allows the generation companies to make large profits without investing in the infrastructure that carries the electricity to the customer. Customers are the ones responsible for covering the cost of maintenance of their homes along with related electrical upgrades, and high voltage lines become subject to an “if it is not broken do not fix it” mentality since the companies do not have any top-down pressure influencing their decisions. These conclusions are supported by claims made by Beder (2006) “...the service obligations of government owned electricity companies are replaced by the short-term commercial goals of private companies”. This is supported by findings from other countries such as the United States, which has also privatized their electricity industries, a decision that brought similar consequences. Privatization allowed companies in the United States to cut overhead costs and increase their profit margins by cutting back or even eliminating maintenance programs and ignoring the deterioration of the infrastructure (Beder, 2006).

## **2.6 Socioeconomic Factors in the Incidence and Effects of Electrical Fires**

Socioeconomic factors, such as income level and education, are closely connected with fire risk (TriData Corporation, 1997). These factors can be used as predictors of fires in certain residential communities. When studying or trying to prevent fires, these factors need to be taken into account if major changes are to be accomplished. Humans have a direct and indirect impact on fire risk, especially with respect to the homes they live in. Direct impact is carelessness and misuse of appliances and arson. Indirect impact is building age, upgrades, income levels, age of homeowners and initial building quality. Both of these relate to the ignition of a fire as can be seen in Figure 5. This figure shows the factors leading to fire ignition and losses. Some factors are based on direct human action, such as the misuse of fire. Other factors are from non-human action. These factors include age of building, size of building, household size, and income. Certain mitigating factors such as building age and number of occupants in a home, lead to fire losses. This chart shows how the socioeconomic factor of income level of a household contributes to the ignition of a fire.

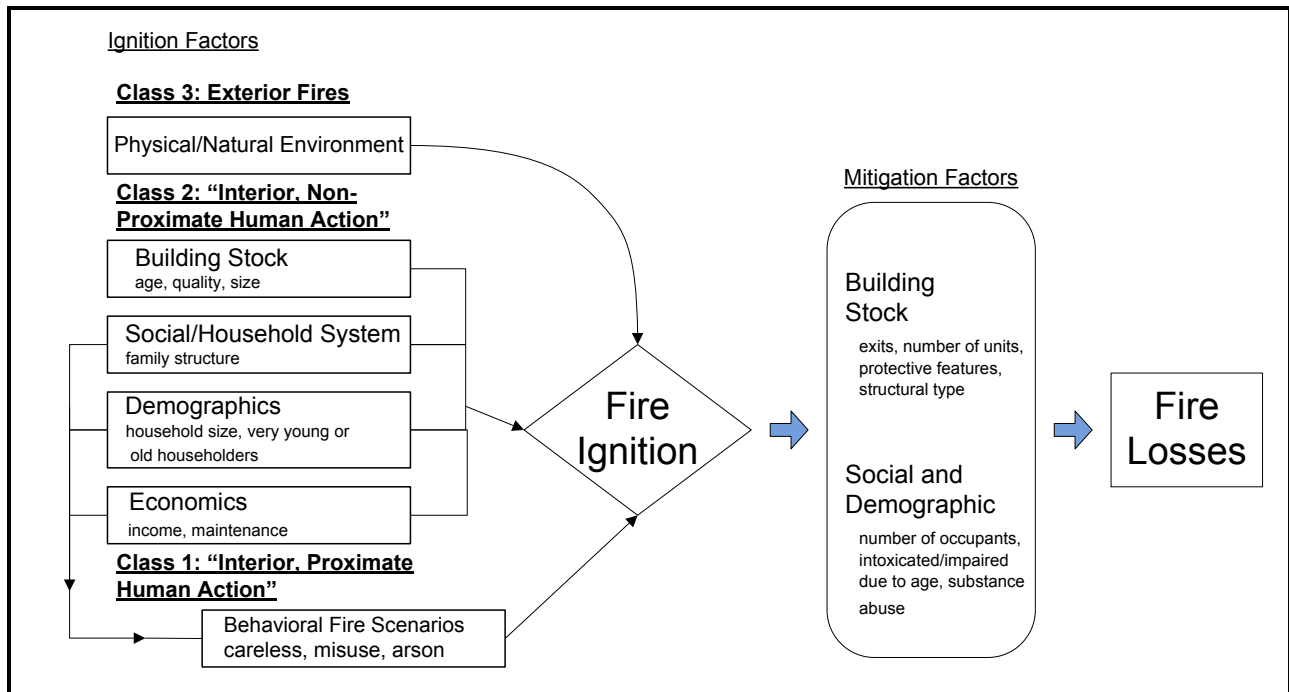

Figure 5: Human impact on fire initiation and loss (TriData Corporation, 1997).

### 2.6.1 Income Levels

Households with a lower income are at a greater risk of fires than those with higher income levels. Individuals or families with low incomes tend to buy homes in sections of town where the property values are the lowest (TriData Corporation, 1997). These homes tend to be run down and not properly maintained. The mechanical systems in homes, such as electrical, heating, and plumbing, need to be properly maintained over the life span of those systems in order to keep the systems in safe working condition. For the most part, low-income families either buy or rent a home in which the mechanical system has not been maintained or they do not have the disposable income to maintain the system themselves. Faced with the choice of meeting immediate needs, such as feeding a family, or maintaining and upgrading wiring, family needs take a higher priority. Middle- to high-income households more often have the resources to be able to make the necessary changes to inadequate electrical systems.

Low-income families do not have the proper disposable income to be able to upgrade the electrical systems in their homes. Consequently, they may be more inclined to use extension cords, power boards or splitters to run the needed appliances. This can overload the power point

and wiring and create a fire because the electrical system cannot handle the overload and prevent it from igniting (TriData Corporation, 1997; Shai, 2006).

In addition, low-income families may be unable to afford the oil or gas to heat their homes in the winter and may opt to use more space heaters as a result. Since most space heaters are run on electricity, this practice can create overloads on an electrical system, particularly when more than one space heater is used in a house along with the appliances already running. Space heaters in themselves are a fire hazard if placed too close to combustible materials, but when added to an already stressed electrical system, they can lead to major problems (TriData Corporation, 1997).

Low-income families may try to share the cost of living by sharing a house among multiple families. This may reduce costs, but with the increased number of people can greatly increase the wear on the existing electrical system. This coupled with the fact that low income families tend to live in older homes greatly increases the risk of fire. This also increases the number of victims that could die in the case of a fire.

The mean equivalised disposable Australian household income was AUD\$811 (Figure 4) per week in 2007-2008 (Australian Bureau of Statistics, 2009b). Mean equivalised disposable income is disposable income adjusted to account for the size of the household and family. Disposable income is the gross income less the value of income tax and Medicare levy to be paid on gross income. Appendix H defines mean equivalised disposable household income in greater detail. For low and middle income families, the mean equivalised disposable income was AUD\$409 and AUD\$692 respectively, whereas high income families have more than double the average equivalised disposable income: AUD\$1646. In low-income households, the average number of people living in a house is 2.6 and the average number of people from that house that are employed is 0.7 (Australian Bureau of Statistics, 2009b). These figures show that if people in a low-income household want to make upgrades to their electrical systems, they will need to save for longer than the middle and high-income households. Low-income families are at a greater disadvantage when it comes to upgrading electrical systems. Many will resort to fixing the problems themselves or hiring unlicensed electricians, which can lead to even further problems.

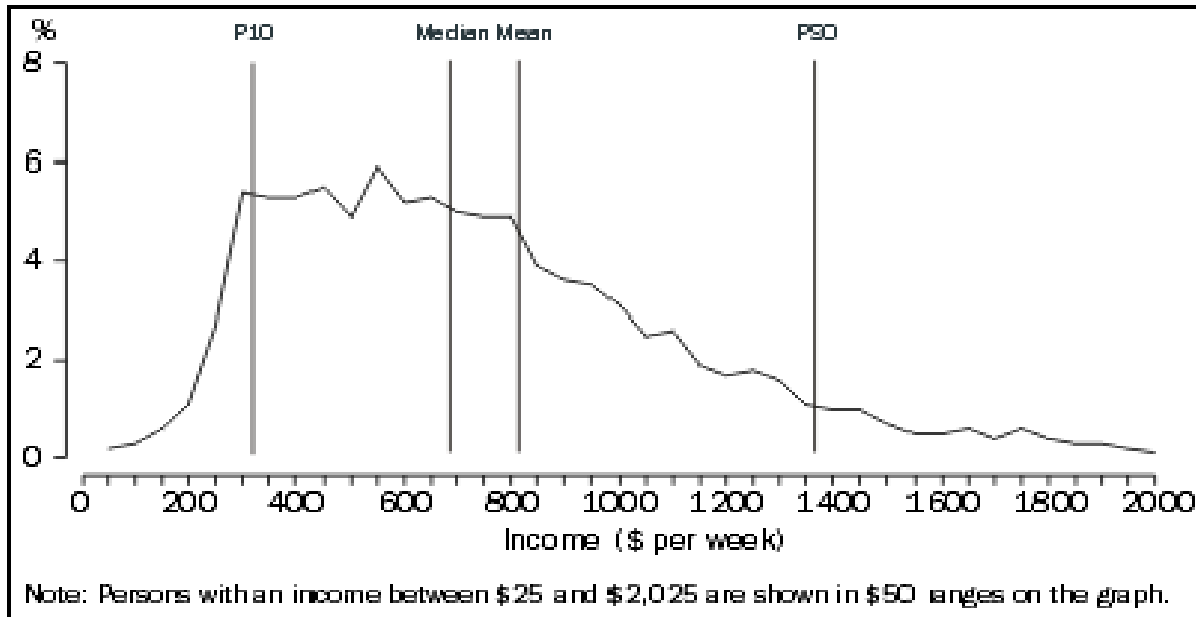

Figure 6: Cumulative distribution of disposable income in Australia (Australian Bureau of Statistics, 2009b).

### 2.6.2 Community Awareness Programs

Community awareness programs have been orchestrated by ESV since 2005 to educate the public on the importance of getting a Home Safety Inspection (HSI) because of deteriorated wiring in residential dwellings. ESV, in an annual report stated that an electrical home safety inspection scheme was initiated at the end of 2005 with the airing of two commercials (Energy Safe Victoria, 2006). One of the commercials was intended to trigger home owners to consider whether their home electrical wiring and installation was aged or overloaded. The other urged both buyers and sellers of properties to arrange inspections for peace of mind. These commercials were potentially the result of a study conducted by Monash University to determine the integrity of very old electricity infrastructure in domestic premises (Office of the Chief Electrical Inspector, 2005a). This study is referenced in the 2005 annual report, with the following annual report referencing the HSI scheme targeting aged infrastructures being initiated. The HSI commercials are also first in the list of ESV's "public awareness and communications" section in the annual report (Office of the Chief Electrical Inspector, 2005a).

In a 2007 annual report, ESV stated that they designed a brochure with seniors as the target audience to promote a AUD\$50 rebate for the cost of an electrical HSI. The promotion was limited to Victorian Senior Card holders. The brochures gave warnings about properties that

were more than 25 years old and that the wiring within those homes may not be “up to scratch,” or adequate. The brochures also claimed that deteriorating wiring may be unsafe and insufficient to withstand today’s electricity demands, a situation which could lead to fire. Again, these brochures only targeted seniors and were placed in seniors’ publications and provided with every new Victorian Senior Card issued from July 2006 to June 2007. Another promotion was run in Monash, which gave AUD\$60 rebates to home owners who booked and paid for an HSI. A contest was run in Greater Geelong which covered the cost of an inspection and AUD\$500 towards any further electrical work to the winners only. The HSI programs were listed at the end of the “public awareness and communications” section in the 2007 annual report (Energy Safe Victoria, 2007). The next year, ESV continued to “heavily promote” the HSI scheme to the senior community with the AUD\$50 rebate marking an increase in the number of inspections carried out; however, there was not much interest in the scheme due to the cost of the inspections and failure of inspections companies to “fully embrace it.” Advertising the rebate in seniors’ newspapers was also discontinued in this reporting year, with consideration given to a future program. There is no indication of what this program could include, and the HSI program was a small paragraph at the end of the “public awareness and communication” section in the report (Energy Safe Victoria, 2008). In the 2009 annual report, there was no mention of HSI’s or any possible future program to increase participation or awareness (Energy Safe Victoria, 2009).

### 2.6.3 Insurance Companies

To calculate a homeowner’s insurance policy, insurance companies determine the risk index of the home. The higher the risk factor, the higher the insurance policy will be. The risk factor of a building is determined through communication with the homeowner about the age of the dwelling, electrical system and other factors. A research project is currently underway at the Insurance Council of Australia to determine the risks of an electrical fire on a building and its associated electrical system. No personal inspection of the home and electrical distribution system is performed when a policy is determined. Insurance companies to date in Victoria, Australia do not give incentives to homeowners to upgrade or to inspect their electrical wiring systems (Andre Mierzwa, personal communication; Brian Hollis, personal communication).

## **2.7 Summary**

There are many ways in which faulty wiring systems can ignite fires. Poor connections and overloaded wires are fairly common problems that lead to electrical fires. There are many different types of electrical systems that are in use. These systems have also changed over the many years that they have been installed in homes either as they are built, or as they are renovated. The aging of these electrical systems can also present a problem in itself. Often connections can loosen over time and conductors can corrode. In addition the insulation of the wiring can deteriorate, posing the danger of exposed conductors. To further worsen the situation for houses with wiring near the end of its usable life, the electricity usage in residential areas has greatly increased, with the development of various new technologies. Collectively, these have lead to an observed increase in electrical fires in residential dwellings.

Targeting individual electrical systems and wiring that are in need of renovation has proven to be difficult, since the majority of the system and wiring is hidden in the walls of homes. Unfortunately, the first warning that a home is at risk for an electrical fire is often, in fact, the fire itself. The only way to adequately be assured that the wiring in the walls is safe is to pay careful attention during the installation process. As a result, in many regions throughout the world, including Australia, electrical inspections are required during the installation process but before the systems become hidden behind walls. Over time, the specifics of these inspections have improved in keeping the homes safe, as people have learned more about electrical fires. However, this does not address the systems installed decades ago that are just waiting to ignite surrounding building materials. As a result, societies have implemented new legislation to address these issues. Different solutions have had various consequences throughout the world, based on many societal factors. By examining the specific factors that have lead to electrical fires and the reduction of electrical fires in some cases, we made recommendations that are suitable for Victoria, Australia.

### 3. METHODOLOGY

The goal of this project is to investigate potential risk associated with placing high electrical demand on deteriorating residential wiring systems in Victoria by working in collaboration with the Metropolitan Fire Brigade. To achieve this goal, we addressed several specific objectives, as shown in Figure 7. First, we identified electrical demand trends, after which identified electrical fire trends. Subsequently, we analyzed electricity demand and electrical fire trends to show the relationship that exists between both of them. Then, we established several societal dimensions related to electrical fires. In the following sections of this chapter, we describe specifically how we accomplished each objective.

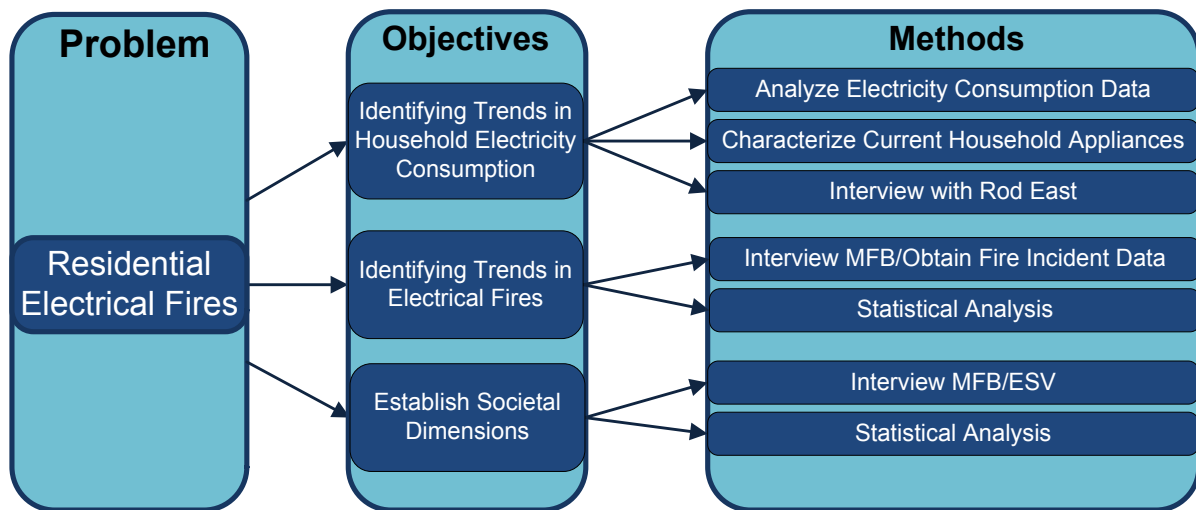

Figure 7: Project overview graphic.

#### 3.1 Objective 1: Identifying Trends in Household Electricity Consumption

Determining the trends in household electricity consumption, our first objective, was achieved through various methods. We implemented a survey, conducted an interview and analyzed statistical data to characterize the electricity demand trends over the past half century.

##### 3.1.1 Describe Trends in Electricity Demand

We first collected the data on the total population in, the total amount of electricity consumed in, and the total number of occupied dwellings in Victoria using the Australian Bureau of Statistics (ABS) website. Obtaining these three datasets allowed us to make elementary

mathematical calculations to determine the electricity consumption per capita and per household. Using the results from the calculations we were able to determine if energy consumption was increasing or decreasing at a faster or slower rate than the population in Victoria and statistically significant changes in the consumption rates for years between 1986 and 2009.

To be able to determine significant changes in the consumption rates for years between 1986 and 2009, we performed a one-sample, two-tailed T-test, because the mean increase in electricity consumption between the years 1986 and 2009 was known from the elementary calculations. Having the mean increase of the entire period enabled us to compare it with each year's average electricity consumption rate. Using the SPSS software we were able to calculate the t-value for each maintenance area. When the t-values are large, it indicates that the datasets means are significantly different. In comparison, when the t-values are small, it indicates that the datasets means are significantly the same. An alpha level of .05 was used when determining which maintenance areas were significantly different than the mean. Maintenance areas with an alpha level of .05 or higher indicated that there was a 5 percent or higher chance of being an error. The comparison demonstrated what years had a statistically significant deviation from the mean energy consumption rate of the entire period.

### 3.1.2 Characterize Current Appliance Household Usage

An increase in the number of household appliances does not explicitly account for overloaded wiring systems. The way these appliances are being used on a daily basis is a necessary factor when understanding the relationship between overloaded wiring systems and electrical fires. To do so we surveyed the corporate staff of MFB in Victoria to identify factors related to appliance usage behaviors. For example, we inquired into how long appliances are left on without actually being used and the number of appliances on a single outlet. The survey also determined the approximate age of each home and the number of appliances being used. This information was used to gauge how many appliances, on average, are being used in homes of a certain age. The survey results also allowed for determining the most recent trend in appliance usage. If a homeowner has a large number of appliances being used properly that are connected to the proper power supply then there is no need for concern; however when homeowners, often unknowingly, use appliances incorrectly for their wiring systems, this does become a dangerous situation. The survey can be found in Appendix I.



### 3.1.3 Interview with Rod East

We then interviewed Rod East, a Station Officer in the Fire Investigation Department of MFB, who investigates not only fires associated with domestic electrical distribution systems but every type of fire responded to by the MFB. We asked him to describe fires that he encounters regularly, specifically regarding electrical fires, and to specify if these fires were associated with overloads to the wiring system. East informed us of fire investigations involving overloading power boards resulting in fire. East explained that these cases are being more and more prevalent and can be easily prevented by using power boards properly and respecting the limitations of power points. From this we included a section of questions regarding power boards in our survey to determine household appliance usage.

## **3.2 Objective 2: Identifying Trends in Electrical Fires**

In order to accomplish the second objective, identifying trends in electrical fires, we needed information regarding the frequency and causes of residential electrical fires. Researching wiring used in different periods of time and reviewing fire incident data helped in completing this objective. By interviewing MFB and analyzing fire incident data with Microsoft Excel and Statistical Package for the Social Sciences (SPSS), we were able to explore the trends occurring with electrical fires.

### 3.2.1 Interview MFB

A goal of this research project was to understand quantitative relationships between electrical fires and their causes in Victoria. In order to perform these analyses, we first identified all the data to which we would have access. Our liaison, Jeff Watt, was familiar with all of the data MFB has, as well as other data available to us through other companies and organizations. Our other liaison, Jarrod Edwards, the Executive Manager of Community Safety Technical Department at MFB, informed us that MFB would make available extensive fire incident data for the past 5-10 year period. MFB also had many records from previous years, dating back to the 1980s, which we also examined. The specific technical causes of electrically ignited fires were included in the extensive fire incident data along with numerous other categories of descriptors about the fires that occurred. We utilized Excel to prepare the data for further inferential analyses and to produce descriptive statistics.

### 3.2.2 Analysis of Fire Incident Data from MFB

Using SPSS software, we performed a one-sample, two-tailed T test on the percent of electrical fires with respect to all fires that occurred in the MFD from 1986 to 2009. This determined which years were significantly different from the mean.

Using Excel, we computed totals, averages, standards deviations, and plotted the data sets for various divisions, such as electrical fires by the time of the fire, the season the fire occurred in, weekend and weekday, and month. We produced figures of the total number of electrical fires for ignition factors and equipment. We also determined the percent of residential electrical fires involving specific electrical distribution equipment by dividing the total number of electrical fires for the given division by the total number of fires.

For heat of ignition, we first researched what types of arcs AFCI's could prevent. We then totaled the number of fires into several categories based on whether AFCI's could have prevented them or not. We then calculated the percent of electrical fires per year of each category by dividing the total of each category by the total number of years. These were then plotted together to show the differences between each category.

### **3.3 Objective 3: Establish Social Dimensions related to Electrical Fires**

To complete our third objective, understanding the social dimensions related to electrical fires, we conducted an interview with employees of MFB and analyzed fire incident data. By performing these two methods we were able to determine if weekly income, cost, and educational level were correlated to the number of fires occurring in the Metropolitan Fire District (MFD).

#### 3.3.1 Interview with MFB Employees

We interviewed Kristen Carter, a Manager of Data Performance and Reporting for MFB, who provided us with census data on the total average weekly income and education level of Victoria. During our interview, Carter informed us the census data would be extracted by maintenance area. Maintenance areas are larger than suburbs but smaller than local government areas (LGA). Also, maintenance areas change periodically depending on the response time of fire stations.

After finding out that the census data obtained from Kristen Carter would be separated by maintenance area, we interviewed Jeff Watt, MFB research analyst, who provided us with fire incident data on the number of fires that occurred in maintenance areas. Originally the data was extracted by suburbs in Victoria but in order for the datasets to be correlated, the fire incident data had to be changed. Jeff Watt also provided us with fire incident data on the cost of fires in the Metropolitan Fire District (MFD). This allowed us to determine how severe and costly damages are after a fire.

### 3.3.2 Correlation Analysis of Societal Dimension Data

After receiving data on average weekly income, education level, and cost of fires in Victoria, we performed a linear regression analysis. We conducted a linear regression to explore the relationship between education level, income, and number of fires. Using SPSS software we were able to make a scatter plot and determine a line of best fit. From the line of best fit, we were able to determine the slope, y-intercept, and R-Squared value. The R-Squared value is a term that demonstrates how well one term predicts the other. If the R-Squared value is 1.0, then one term perfectly predicts the other. If the R-Squared value is 0.0 then knowing one term does not help in predicting the other. An R-Squared value closer to 1.0 is the better the prediction. A positive value indicates as one term increase so does the other; and a negative value indicates as one term decreases the other increases. We also performed a one-sample, two-tailed T-test to determine what maintenance areas had significantly more fires than the mean number of electrical fires occurring between the years 1986 and 2009.

## **4. RESULTS AND ANALYSIS**

This section presents the results and analysis of residential electricity consumption, residential electrical fires and analysis of underlying societal trends associated with residential electrical fires. Electrical consumption analysis is described and potential reasons for the increase are established. Residential electrical fires are then examined and the significant contributing factors are addressed. Finally, the societal implications regarding average income level, average education level and relative cost associated with residential electrical fires is examined.

### **4.1 Electrical Consumption**

At the start of this project, we expected to obtain data on the electrical consumption of household appliances from 1960 to present. With this data we could investigate the hypothesis that the number of electrical fires due to fixed wiring is a result of the increase in electrical consumption of appliances. However, we discovered that it was not possible to determine changes in the demand due to household appliances, as there are no reliable data available for appliance usage. We also found that we could not obtain specific amperage or electricity consumption per household. Electricity supply companies either did not have electricity data dating back to the 1960s, or the companies were unable to allow us access to them due to privacy reasons. Therefore, we obtained data on total electricity consumption and changes in population size through the ABS website. This section presents the results and analyses of electrical consumption related to the population of Victoria, the total electricity consumed per household, and the progression of amperage rating per home due to the current appliances in homes.

#### **4.1.1 Population vs. Electricity Consumption**

Using the information obtained from the ABS website, we calculated the electricity consumption per capita. To do this we needed to first calculate the estimated state population of Victoria. We approximated a linear increase by using the census data collected every five years from ABS beginning in 1976. By dividing the total electricity consumption in residential dwellings by the estimated state population for Victoria for each year, we calculate the electricity consumption per capita. For each year between 1974 and 2006, the percentage increase or decrease of energy consumption per capita was calculated, resulting in an average increase of 1.84 percent per year.

Data referring to overall electricity consumption over time was merged with population data from the census, to provide an estimated average consumption per person across the entire time period. The percentage change per year was plotted in Figure 8, and a one-sample, two-tailed T-test was performed on each data point to determine whether the change in consumption level was statistically different from the average rise in electrical consumption of 1.84 percent. The years that produced a statistically significant deviation from the mean electricity consumption rate per capita are represented in Figure 8 by the red and green points. The red points are for years in which there was a greater statistically significant rate of change in electricity consumption per capita in Victoria, while the green points are for years in which there was a less statistically significant rate of change in electricity consumption per capita in Victoria. The data points in blue are close to the statistical mean, and the dashed line is a third order polynomial trend line fit to the percentage of electrical fires. The tables containing the t-values that determined what years were significantly different than the mean electricity consumption per capita rate of 1.84 percent can be found in Appendix J.

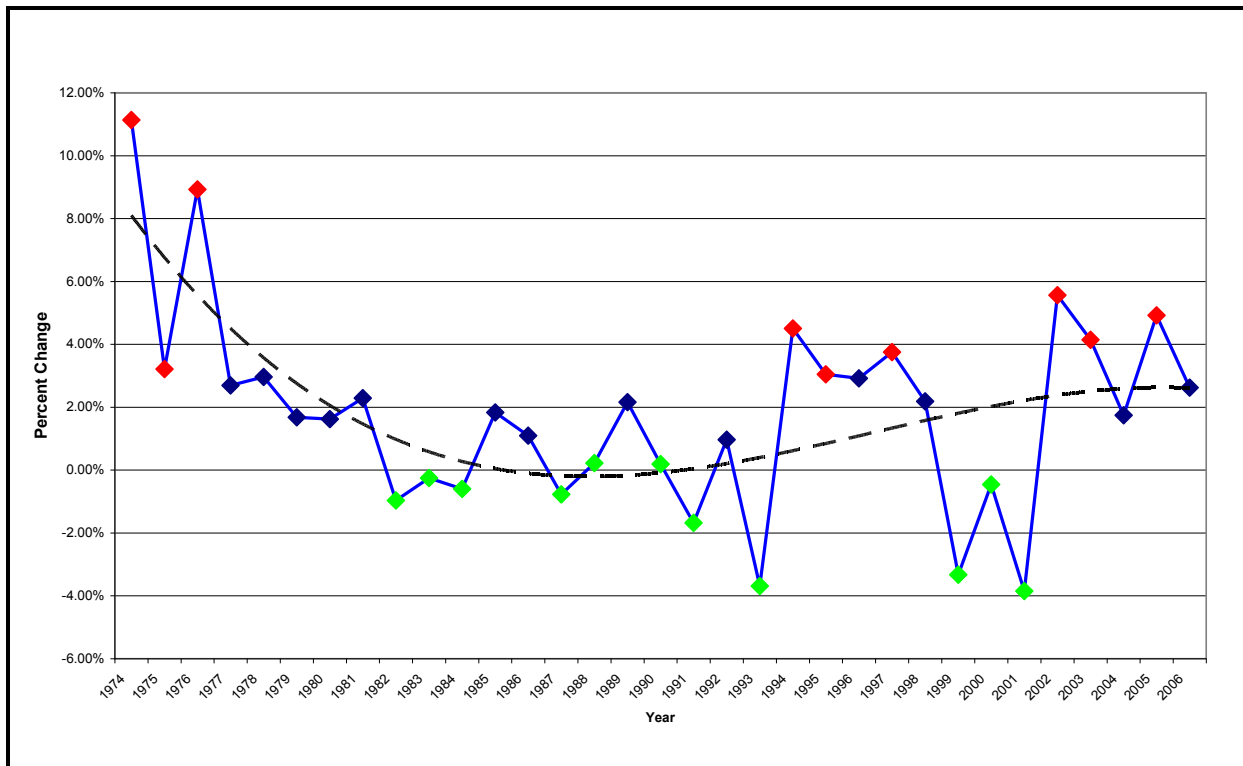

Figure 8: The percent changes in residential electricity consumption per capita rate in Victoria (1974-2006)

Variation in years in which the electricity consumption rate change was statistically different can be contributed by the number of appliances people are using in homes. In earlier years where the values are significantly higher than the mean could suggest that new appliances became available to the average household causing electricity consumption to increase. Likewise, in recent years, electricity consumption increases higher than the average of 1.84 percent. We assume people are using more appliances in their home which caused electricity consumption to increase more rapidly than the population.

#### 4.1.2 Electricity Consumption per Household

Residential electricity consumption per capita has been increasing since 1976, with only a minor drop between 1999 and 2001 (Appendix K) One of our objectives was to understand how the electricity consumption per household changed since 1976, and to elucidate the driving factors behind this change. Unfortunately, we only acquired data for the total population of Victoria and the number of occupied dwellings in Victoria for three census data collection years: 1996, 2001, and 2006. Table 1 shows these data, as well as the results of some basic calculations to determine rough estimates for electricity consumed per household and the average number of people per household.

Year	1996	2001	2006
Population (Victoria)	4,373,520	4,612,097	4,932,422
Occupied Dwellings (Victoria)	1,591,656	1,731,343	1,869,384
Amount of Electricity Consumed by Residential Dwellings for the Entire Year (Gigajoules)	35,200,000	36,800,000	46,900,000
Electricity Consumed per Household (GJ/home/year)	22.12	21.26	25.09
Average Number of People per Household	2.75	2.66	2.64

Table 1: Data used in average electricity consumption and number of people per home calculations for Victoria (Schultz, 2009; Australian Bureau of Statistics, 2010).

This data shows that electricity consumed per household from 1996 to 2001 dropped, but then increased again over the following five year interval. Shown in Figure 9, electricity consumption per capita has been increasing. The reason for the decrease in the energy

consumption per household from 1996 to 2001 can be explained by the large drop in the average number of people per home. During the following five years (2001-2006), where the overall average number of people per household levels off, there is a rise in the electricity consumed per household.

The average number of people per household is dropping as a result of many social factors. These factors include the aging of the majority of the population, declining fertility rates, postponing of major life events such as moving out from parents' homes and partnering, the increasing of divorce rates and changes in acceptable lifestyles (Department of Sustainability and Environment, 2004). The majority of the population in Victoria was born as part of the 'Baby Boom' generation, born just after World War II. In 2000, this generation was in their 50s, with children generally in their 20s, leaving home, thus decreasing the average number of people per home at that time. The flowchart in Figure 10 presents these and several other factors (Department of Sustainability and Environment, 2004). In addition younger women, on average, are having fewer children than previous generations and later in life.

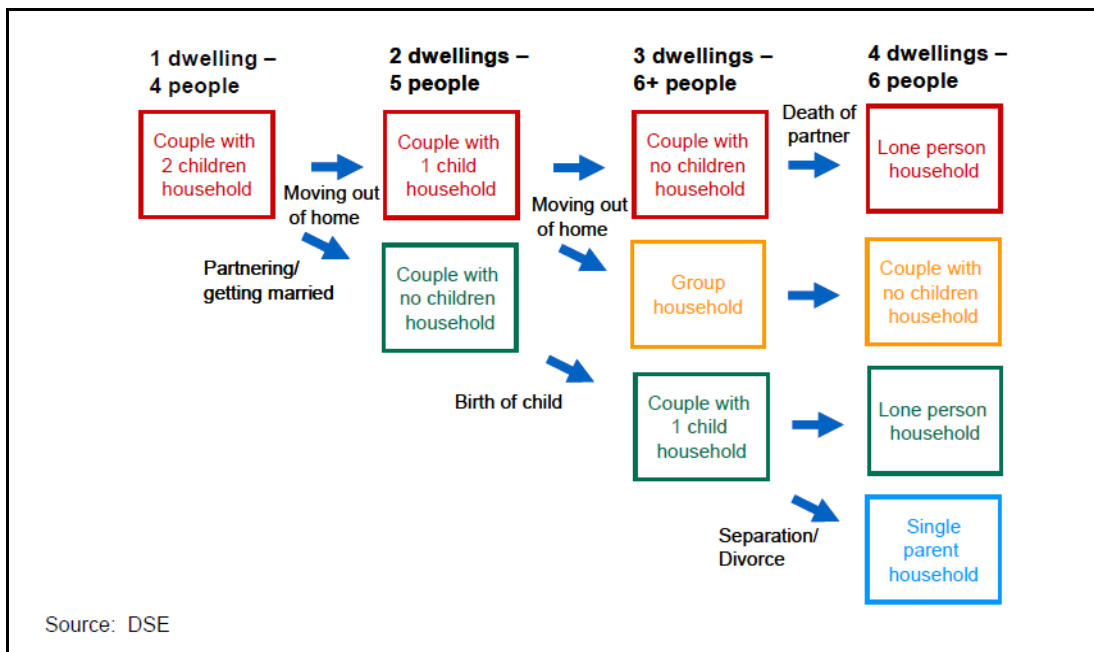

Figure 9: Flowchart showing progression of households as average household size declines (Department of Sustainability and Environment, 2004).

These factors potentially account for the insignificant increase in the household energy consumption and even a decrease between 1996 and 2001. A home with fewer people will use less electricity since there are fewer people running appliances and other equipment (such as lighting) within the home.

#### 4.1.3 Analysis of Current Appliances

The increase in electrical consumption per home can be attributed to modern appliances consuming more electricity than the number and type of appliances that previously existed in homes. By analysing current appliances Australians commonly have in their homes today, we can also see why older wiring systems may be struggling, resulting in fires, to keep up with today's electrical demands. To determine what appliances many Australians have in their homes, we conducted a survey of MFB employees. The questions from this survey can be seen in Appendix I. This survey was sent out to 295 employees and returned 61 responses (21 percent response rate). Recipients of the survey were only MFB employees, which were not an extremely accurate representation of Victoria's population, but due to logistical limitations, this was a practical population we could survey in the project's timeframe. The income range of survey respondents was from AUD\$40,000-\$60,000 to over AUD\$200,000. The mean household income from our sample fell in the range of AUD\$80,000-\$120,000, and through interpolation of this data, the mean was approximately AUD\$101,300. This is 19.3 percent higher than the mean household income of Victoria, which is AUD\$84,864 (Australian Bureau of Statistics, 2009b). This difference will slightly skew our results from appropriately representing Australia's population. This survey revealed that most of the survey respondents have multiple appliances that were not available at the time of their electrical system's installation. The average age of a home for the sample that took our survey was 34.6 years old, with the oldest home being 110 years old. Only 37.7 percent of the homes reported having had electrical upgrades since their construction. Figure 5 shows the percent of survey respondents that reported owning various appliances, which indicates the current popularity of relatively modern appliances, such as air conditioners, desktops, and laptops, among our sample group.



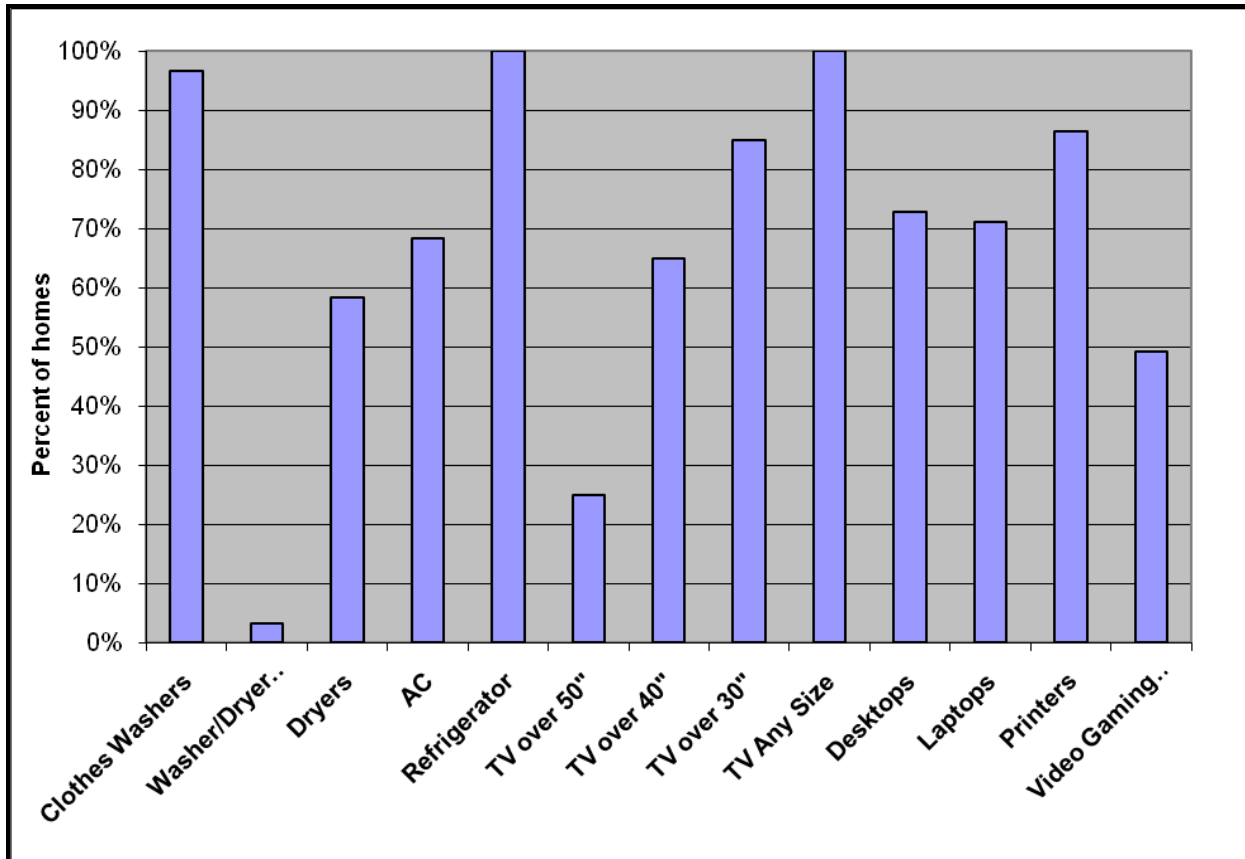

Figure 10: The percent of homes that contain various high electrical appliances, based on 59 responses from a survey conducted of Metropolitan Fire Brigade employees.

The mean electricity consumption for an average-sized home (214.6 square meters: Australia Property News, 2009) in Australia is 6.76 kWh per day (Tass Georgas, personal communication, n.d.). This total consists of the electrical energy consumed by appliances, such as refrigerators, which consume a large amount of electricity throughout the day, but do so at a relatively slow rate. The total also consists of other appliances that consume energy at a very high rate, but are not typically running for extended periods of time, such as a microwave or hair-dryer. Table 2 shows the electricity consumption of various household appliances, measured in Watts (joules/second), the rate at which the energy is consumed.

Household Item	Running Wattage Requirement (W)
<b>Computer</b>	
Desktop	80-150
Stand-by Mode	30-40
Laptop	40-50
Printer	400-600
<b>Dishwasher</b>	
Cool Dry	700
Hot Dry	1450
<b>Electric Range</b>	
6-inch Element	1500
8-inch Element	2100
<b>Microwave Oven</b>	1000
<b>Refrigerator/Freezer</b>	700
<b>Washing Machine</b>	6000
<b>Dryer</b>	
Gas	700
Electric	5750
<b>Television</b>	
LCD (52")	350
Plasma (52")	500-700
Cathode Tube (35")	200
<b>Air Conditioner</b>	
Portable	1000
Small Window	2000
Large Wall	3750
Central Air	7500

Table 2: A breakdown of the average power demanded from various modern universal household appliances (Energy Australia, n.d.; Rainbow Power Company Ltd., 2006)

These numbers are likely to be decreasing for these appliances as they are made more energy efficient. In 2008, 59 percent of Australian households had energy-saving lighting installed (up from 33 percent in 2005). In addition, energy star ratings were a major consideration when purchasing new refrigerators, freezers and clothes dryers. People are becoming more environmentally aware, but more households now own air conditioners (67 percent), dishwashers (45 percent), and other appliances, such as LCD and plasma televisions. Plasma televisions use nearly three times the amount of electrical energy that a standard television uses (Australian Bureau of Statistics, 2009a). A standard television is from another part of our survey, we obtained data on the type of the largest television in a person's home

(Figure 12). The two most common types of televisions are plasmas and LCDs, which were introduced in the late 1990's, and since have become more prevalent. This result from our survey may vary from the general public of Australia since our sample has a slightly higher average household income than that of Victoria's general population. With the general population having a lower household income, one may expect slightly fewer of these modern and more costly appliances to be in homes. LCD televisions consume more energy than the standard cathode-ray or rear projection televisions; however plasma screen televisions use nearly twice the energy than that of LCD televisions, or three times as much as a standard cathode ray television (Australian Bureau of Statistics, 2009a).

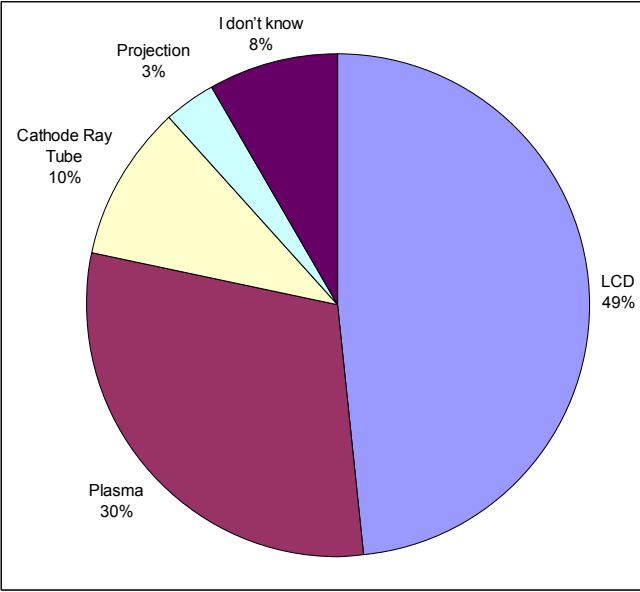

Figure 11: Distribution of the type of largest television in Victorian homes from survey results.

**4.1.4 Power Boards**

From our interview with Rod East, we learned that there are multiple fires under investigation that involve power board failure. However, the focus went to two fires occurring within six months of each other, which were the result of almost identical power board failures. These two fires alone accounted for two fatalities and over AUD\$1 million in damages. We also learned that further information from these investigations could not be divulged to us due to pending investigation by the MFB and the City Coroner. However, East did explain to the team

that he has seen a recent increase in fires related to electrical wiring and further research into this fire cause is absolutely necessary.

This inspired us to include several questions on power boards in the survey we created. Power boards are significant because they enable people to plug numerous appliances into one single power point. This is not a problem if only light-duty appliances are plugged into the power board, or if the appliances plugged into the power board are used individually, rather than simultaneously. However, when several high energy demanding appliances are used simultaneously, there is a high likelihood of overloading of the circuit in use. Therefore we obtained data on the number of power boards in homes and the number of these power boards with surge protectors. A power board without a surge protector enables the appliances plugged into the power board to collectively overload the power point. The 60 people who responded to the power board questions on our survey are collectively using 234 power boards, with an average of four per household, ranging from zero to 15 power boards in a home. Approximately 15 percent of people surveyed stated they have power boards plugged into one another, or “piggy-backed,” to achieve more available receptacles, which in turn further increases the user’s ability to overload the circuit. One home surveyed indicated that they had power boards permanently “piggy-backed” with a 30-year-old home that has never been electrically upgraded. Several other people stated they use power-boards for large appliances such as big-screen TVs, refrigerators, freezers, air-conditioners, washer/dryer units, and even an electric stove. These items should be plugged directly into the power point due to the large amount of energy they demand. By the use of a power board, these appliances share the power from a single power point with several other appliances.

## **4.2 Electrical Fires**

The fire incident data used in the following sections was obtained from the Australasian Incident Reporting System (AIRS). The officer recording the fire incident data follows a manual provided by AIRS for recording the most pertinent information. However, reporting of fire incident data is based on the judgment and experience of the officer recording the data from the incident. Thus, this introduces variability in the recording of data. The AIRS Manual is divided into ten blocks (A-K). Several field items need to be recorded within each block. Certain field items are national (mandatory) items while others are optional. We found that because some

items are optional the data between fire companies varied, thus making it difficult to compare with other datasets. Appendix L details all the blocks and their corresponding field items indicating the reporting option. A set of codes designed to comply with each block record the field items. The codes are separated into divisions depending on similar functions. The AIRS Manual also provides definitions, and examples to further guide the officer in recording the data. For the purposes of this report, we examined Block A (complete for all incidents), Block E (ignition), and Block H (dollar loss fires) from the AIRS Manual. Within Blocks A, E, and H, we examined ignition factors, equipment involved, time of day, month of year, and dollar amount of fire damage (all figures reported in AUD). This section presents the results and analysis of the fire incident data obtained from MFB and provides insight into the causes and trends for residential electrical fires.

#### 4.2.1 Percent of Electrical Fires with Respect to All Fires

Residential electrical fires are a major problem, not only in Melbourne, Victoria, but also throughout the Metropolitan Fire District (MFD), which consists of four zones containing various suburbs and maintenance areas (Appendix M). A total of 47,469 residential fires occurred during 1986-2009 in the MFD. Of those fires, 5,858 were caused by electrical failure. Figure 12 shows the percent of electrical fires with respect to all fires that occurred between 1986 and 2009 by year. Due to issues such as missing data for the years 1996, 2002, 2005, 2006 and also the fluctuations of total fires overall, the proportion of electrical fires of all residential fires was used to standardize the data set. This was performed to allow more relevant comparisons between the different years, and allowed the use of inferential statistical analyses to determine the differences across the entire period.

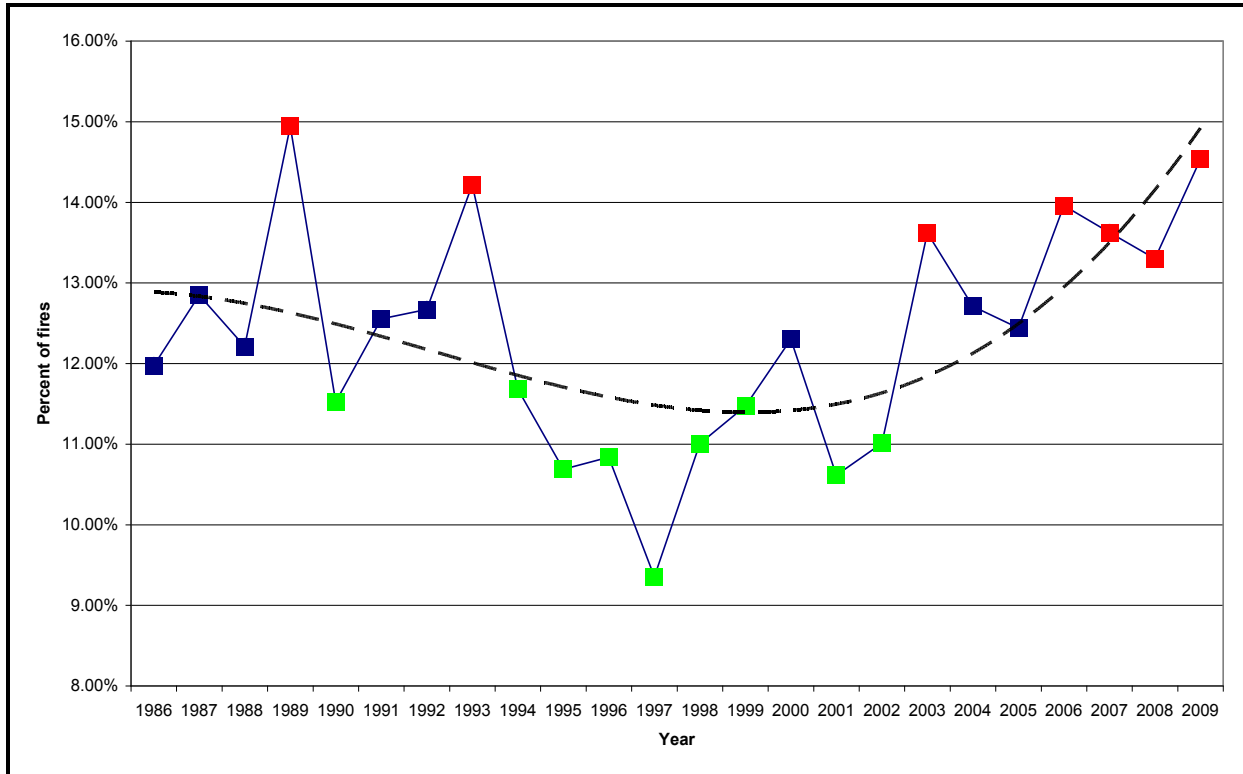

Figure 12: Percent of residential electrical fires with respect to all fires that occurred in the MFD per year (1986-2009).

We performed a one-sample, two-tailed T-test on this dataset to compare the number of fires occurring in any given year against the overall mean value (12.34 percent) of fires for 1986-2009, which allowed us to determine years that were statistically different from the mean. The data points of Figure 12 in red represent statistically high percentages, whereas data points in green are statistically low percentages of electrical fires with respect to all fires. The data points in blue are close to the statistical mean. The dashed line is a third order polynomial trend line fit to the percentage of electrical fires. The tables containing the T-test results for each data point can be found in Appendix N. Since 2000, the percentage of electrical fires with respect to all fires has been consistently higher than the mean. Specifically, the percentage of electrical fires between 2006 and 2009 are statistically higher than the mean, contained in the following sections are breakdowns of the 5,858 residential electrical fires and our findings.

#### 4.2.2 Ignition Factors and Equipment

The 47,469 residential fires that occurred during 1986-2009 in the MFD can be categorized by using Block E of the AIRS Manual. We extracted the fire incident data using

AIRS Division 5 codes for ignition factors (corresponding to fires caused by mechanical failure or other malfunction). Figure 13 gives a breakdown of the number of Division 5 fires contributing to the 47,469 residential fires.

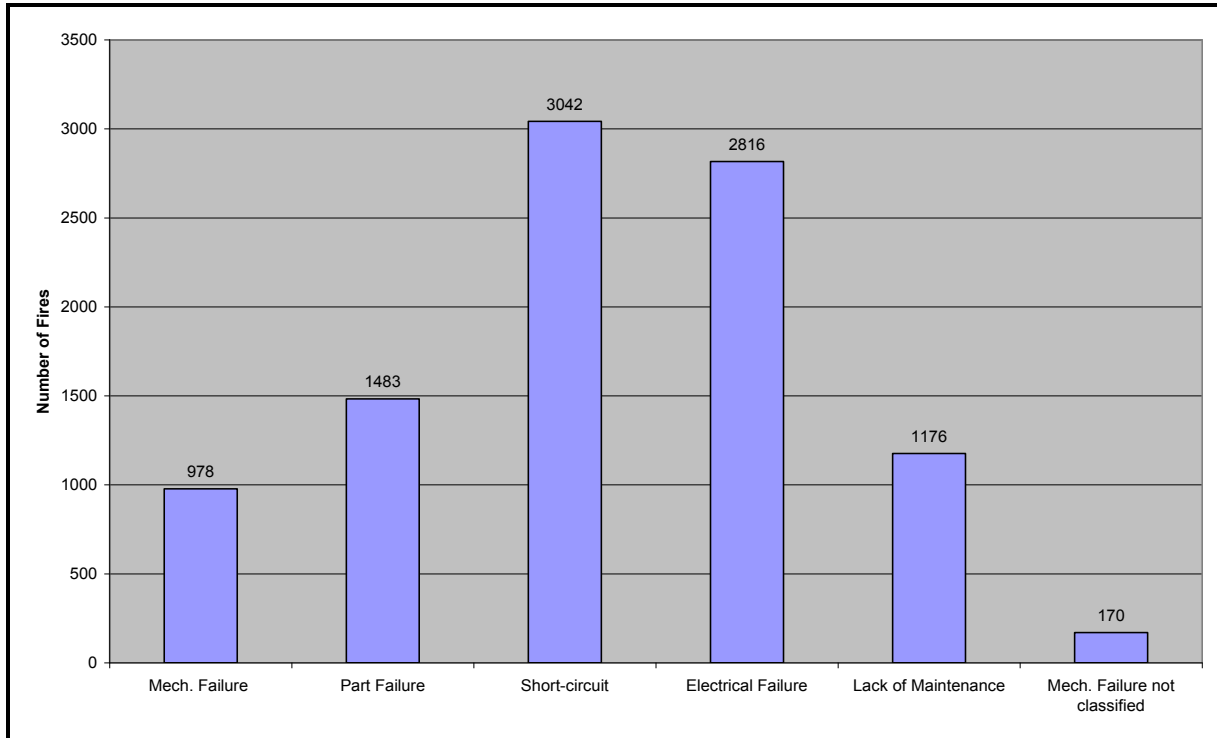

Figure 13: Division 5 ignition factors of fires in MFD (1986-2009).

From Division 5, we focused on codes 540 (corresponding to fires caused by short circuits) and 550 (corresponding to fires caused by general electrical failure). We focused on these two ignition factors because they accounted for the largest proportions of total electrical fires (5,858 fires combined), and pertain to the components of electrical distribution systems in homes. Other ignition factors such as mechanical failure, part failure, and lack of maintenance were less common and do not pertain directly to electrical distribution systems in homes because they are associated with the malfunction/problems with the actual appliance or equipment being used, and therefore are not the main focus of this project. For the remainder of this section, we refer to fires with ignition factors 540 and 550 as electrical fires.

In addition to ignition factors, we also extracted data on the equipment involved in electrical fires (Figure 14).

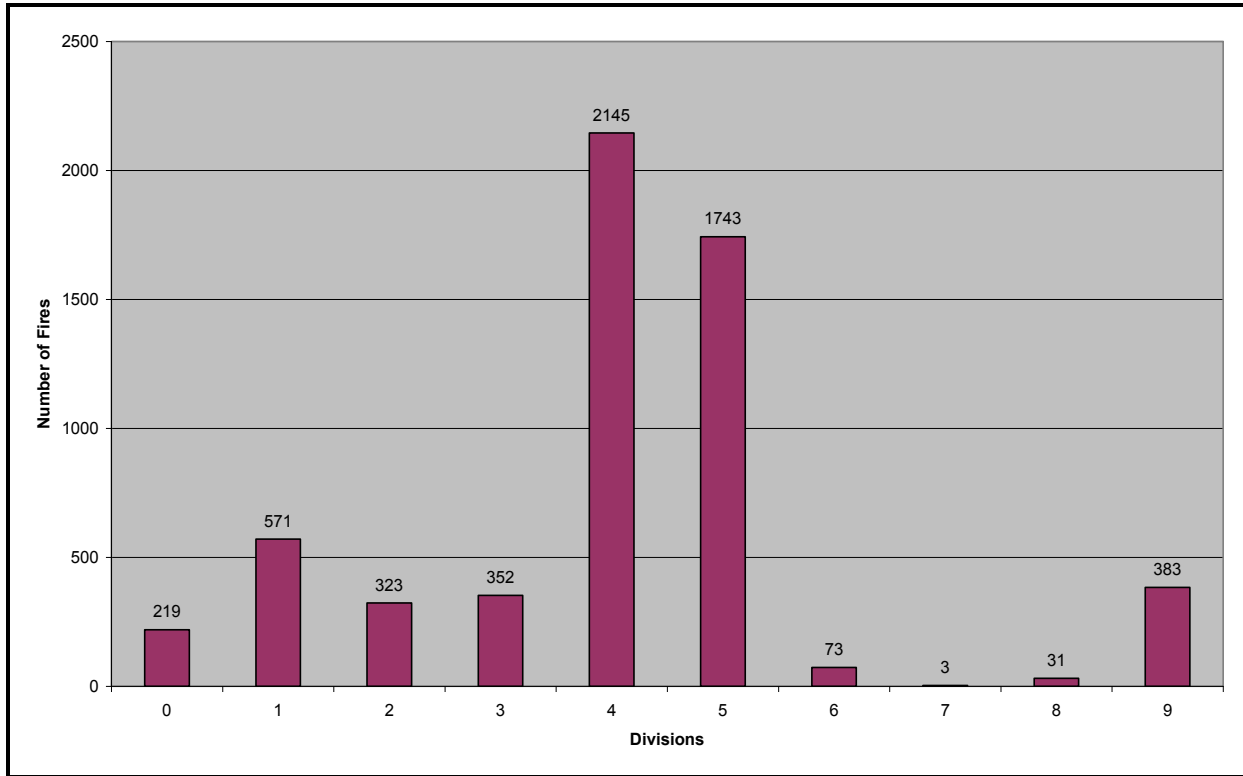

Figure 14: Number of fires that occurred in each division of the equipment involved in residential electrical fires (1986-2009)Table 3.



<b>Division</b>	<b>Description</b>
0	Undetermined or not reported
1	Heating systems
2	Cooking equipment
3	Air conditioning and refrigeration equipment
4	Electrical distribution equipment
5	Appliances and equipment
6	Special equipment
7	Processing equipment
8	Service and maintenance equipment
9	Other objects

Table 3: Equipment definition in each division of Block E of AIRS

Of the 5,858 electrical fires that occurred in the MFD between 1986 and 2009, the largest fraction were attributable to failures in electrical distribution equipment, which accounted for 2,145 (36.62 percent) of the incidents. The individual codes and the description of what each division consist of in the field item, equipment involved, can be seen in Appendix O. In each division there are a set of codes that correspond to the equipment that was involved in the electrical fire. When one compares the different equipment, fixed wiring (code 410) from Division 4 is the leading cause of electrical fires. Figure 15 shows the top fifteen leading types of equipment involved in residential electrical fires between 1986 and 2009.

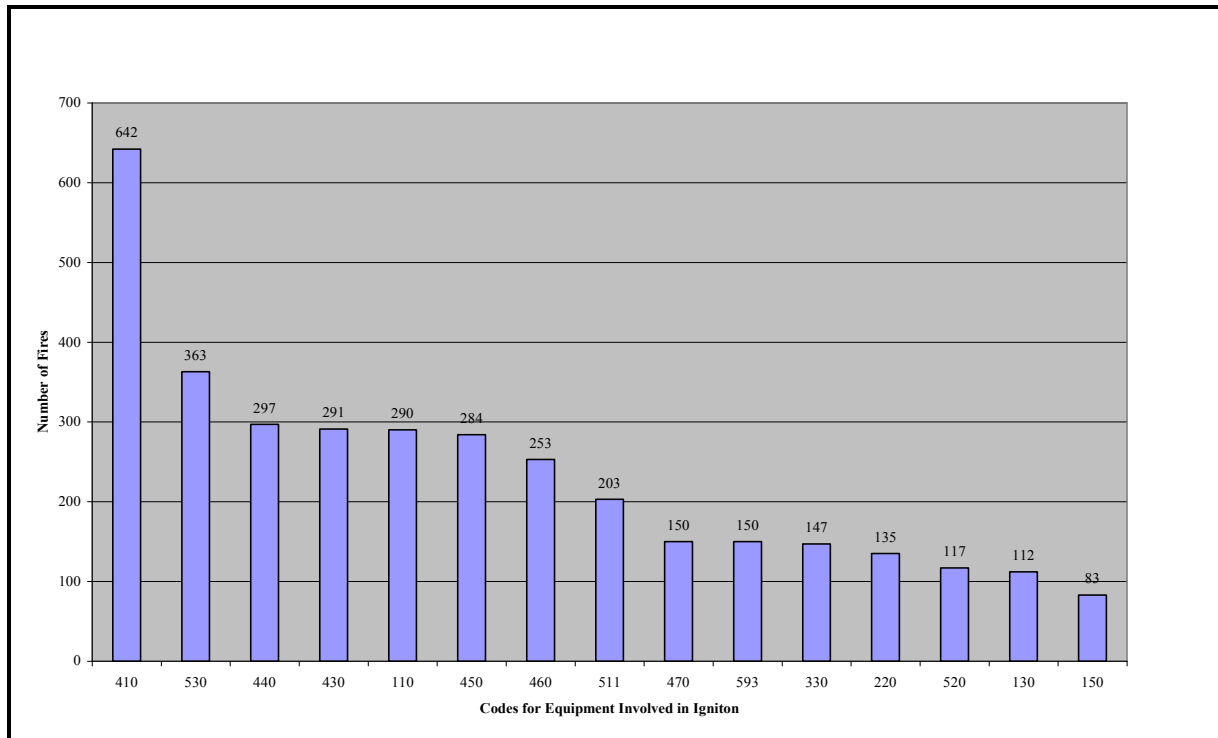

Figure 15: Fires started by equipment involved in residential electrical fires (1986-2009).

Code	Description
410	Fixed wiring
530	Washing machine
440	Power switch gear, over-current protection devices
430	Meter, meter box
110	Central heating unit
450	Switch, receptacle, outlet
460	Lighting fixture, lamp-holder, ballast, sign
511	Television, monitor, computer monitor
470	Cord, plug
593	Dishwashers
330	Fixed, stationary local refrigerator unit
220	Fixed, stationary oven
520	Dryer
130	Fixed, stationary local heating unit
150	Portable local heating unit

Table 4: Top 15 equipment with their corresponding code from division 4 of the equipment involved in Block E of AIRS.

Fixed wiring accounts for 642 (11 percent) of the incidents. Since the majority of fixed wiring is located within the walls of dwellings, fires originating here are of particular concern to homeowners. Fires originating within the walls are difficult to detect, often becoming uncontrollable and severe. We assume that wiring in general is aging without any upgrades done to the electrical systems when home owners get new appliances, because most homeowners are not aware of the need to upgrade, or able to invest in upgrades as needed. Thus, we assume that the 1.84 percent average annual increase in electricity consumption per capita each year is affecting the electrical wiring systems greatly.

#### 4.2.3 Progression of Electrical Fires

Figure 16 shows the percent of electrical fires involving electrical distribution equipment for each year between 1986 and 2009. When examining Figure 16, the mean of residential electrical fires involving electrical distribution equipment is 36.71 percent. From 1986 to 1993 and 2003 and 2009 all have percents higher than the mean. From 2006 the percent of residential electrical fires involving electrical distribution equipment has been increasing. In 2009 the percent is higher than the mean.

We attribute the increase in percentage of electrical fires between 2006 and 2009, shown in Figure 16, to the 1.84 percent average annual increase in electricity consumption per capita each year shown in Figure 8. This increase in electricity consumption each year could also be the reason electrical distribution equipment is the leading cause of electrical fires.

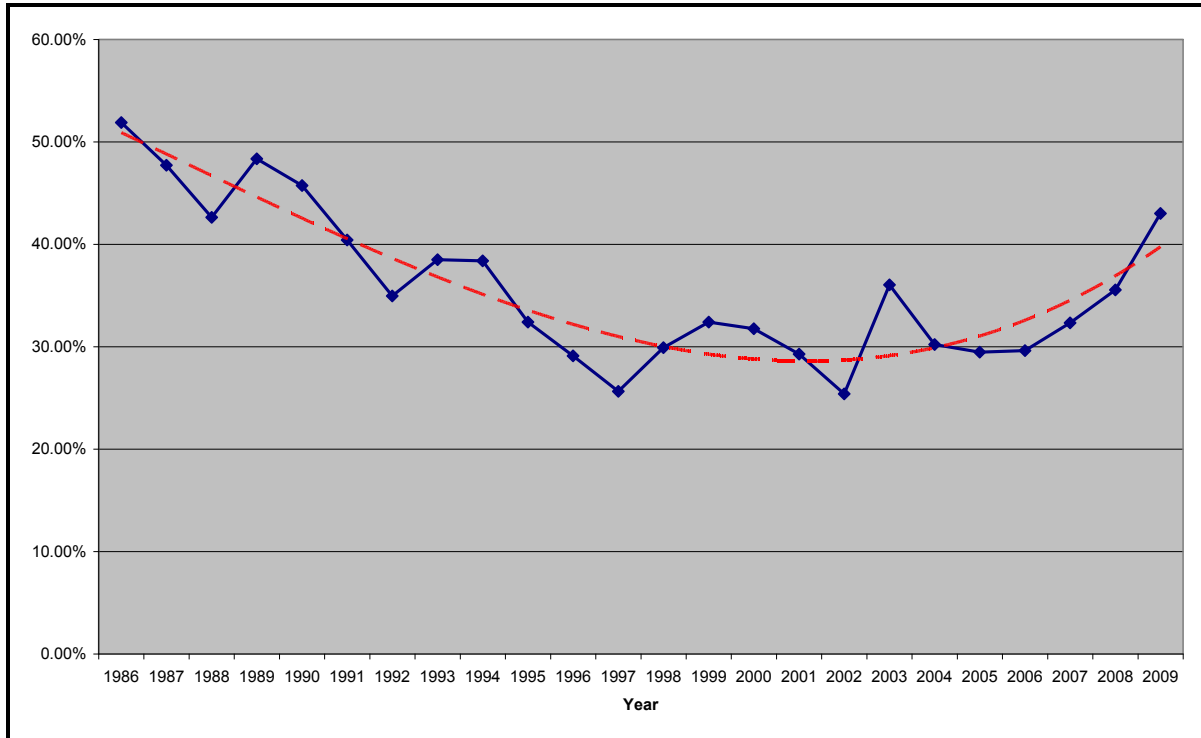

Figure 16: Percent of residential electrical fires involving electrical distribution equipment (1986-2009).

We observe in Figure 12, 16 and 17 that the trend in overall electrical fires is more dependent electrical fires involving electrical distribution equipment than electrical fires involving appliances. When overall electrical fires decrease we attribute its decrease to a decrease in fire due to electrical distribution equipment because fire involving appliances remains generally stable.

The raw numbers of fire involving appliances has remained relatively constant from 1986 to 2009. Therefore, the fluctuation in the percentage of fires caused by appliances, shown in Figure 17, can be attributed to a fluctuation in the number of electrical fires occurring as a result of electrical distribution equipment. Furthermore, when electrical fires by distribution equipment are high, fires involving appliances are low and vice versa, resulting in fluctuations in the percentages of the relative fires. Thus, electrical distribution equipment is the driving factor behind electrical fires, rather than the appliance itself catching fire.

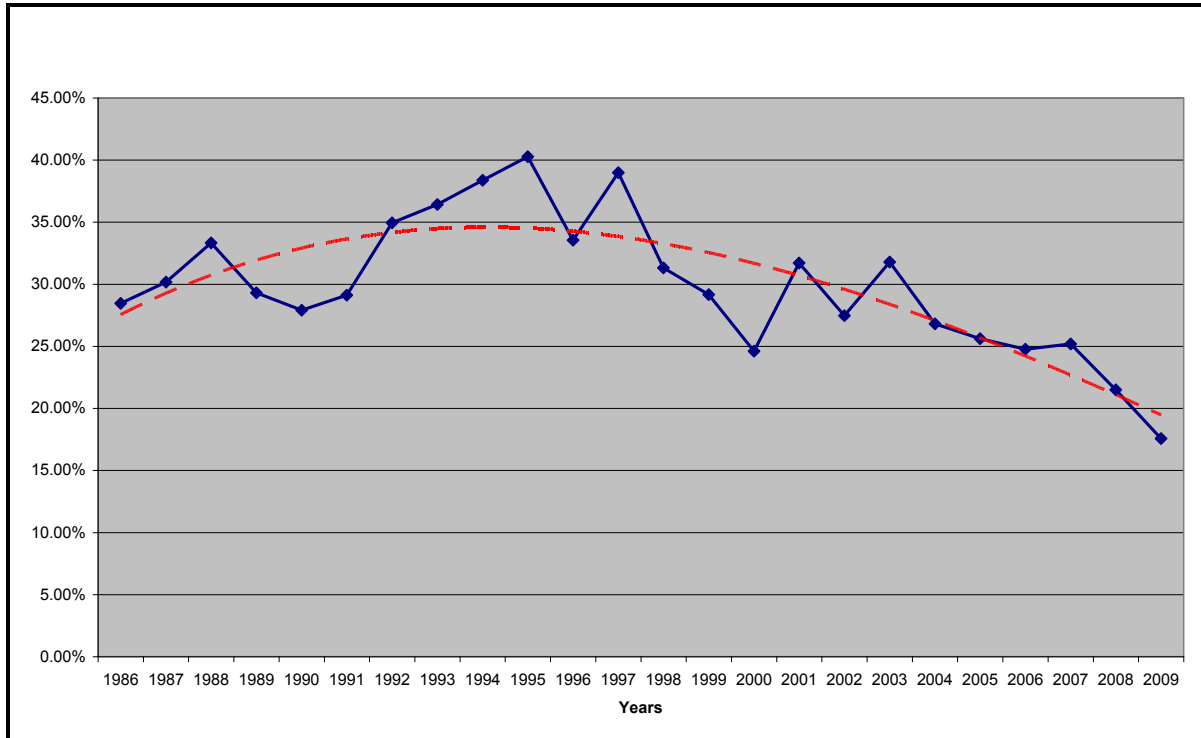

Figure 17: Percent of residential electrical fires involving appliances (1986-2006).

#### 4.2.4 Time of Day

We compared residential electrical fire incidents with time of day, which revealed a non-random pattern in the occurrence of electrical fires throughout a twenty-four hour day. Figure 18 shows the average number of electrical fires caused by short circuits and other electrical failures (AIRS Block E, 540/550), that occurred between 1986 and 2009 for each hour of the day. The general trend is electrical fires occur most frequently in the evening around 18:00 hours and the least around 05:00 hours. Accounting for error, electrical fires still occur more often later in the day. This is when most people are returning home and using appliances which could account for the greater amount of residential electricity consumption.

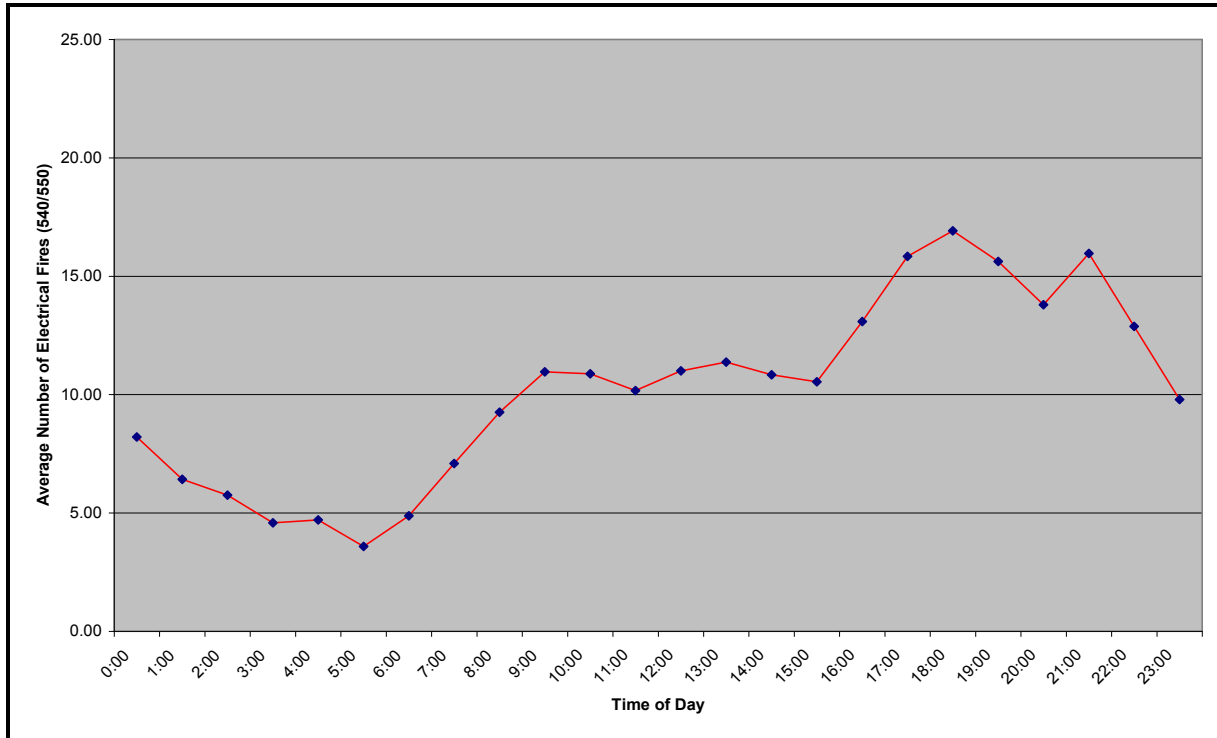

Figure 18: Average electrical fires per time of day (mean 10.17, standard deviation 3.92).

We considered separately the electrical fires caused by short-circuits and by other electrical failures to determine if both categories shared the same pattern of electrical fires occurring more often at night. The separated analyses yielded the same results as Figure 18. The separated graphs and data tables can be seen in Appendix P, Q, and R.

#### 4.2.5 Summer vs. Winter

We also compared the number of electrical fires against season of the year. Figure 19 shows the average number of electrical fires per year over the 24 hours of a day for summer and winter. Both graphs have the lowest point around 05:00 hours and the highest peak around 18:00. This comparison shows several differences between winter and summer. The first difference is that electrical fires are more prevalent in winter. Over the entirety of the figure, winter remains consistently higher than summer, except in two places. Another variation between the two seasons occurs at night. The difference between the average electrical fires is greatest in the evening between the two seasons.

Based on the assumption made in Section 2.1.1 that New South Wales electricity consumption is similar to the state of Victoria and visually comparing Figures 2 and 3 with Figure 19, the relationship between electricity consumption and electrical fires is clear. Both the summer and winter figures of electrical consumption and their associated figures of electrical fires have lowest levels around 05:00 and highest levels around 18:00. The clearest pattern is that the number of fires peaks in both seasons in the evening. Another visual pattern is that both the electricity consumption (Figure 2 and 3) and electrical fires figures (Figure 19) have differences between the summer and winter totals. The winter figures (Figure 3 and 19) have either a higher amount of electricity consumed or number of electrical fires compared to the summer figures (Figure 2 and 19). If the assumption of New South Wales being similar to Victoria is accurate then electricity consumption is related to electrical fires. Based on this relationship, as electricity consumption in a home increases, the likelihood of an electrical fire increases as well and vice versa.

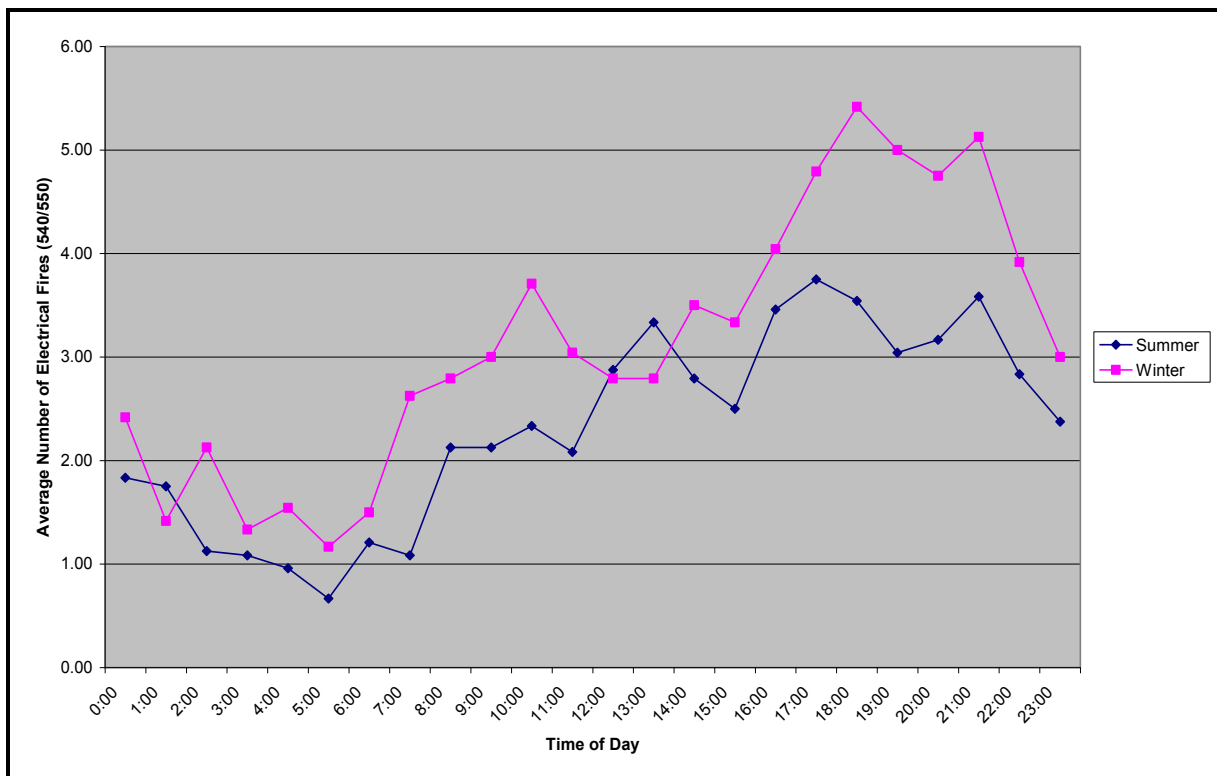

Figure 19: Average number of electrical fires per year by time of day for winter and summer.

We separated and plotted short-circuits and other electrical failures for winter and summer to determine if the figures differed from the trend of Figure 19. The separated figures yield the same trends as the combined figure. The separated figures of short-circuits and other electrical failures for winter and summer and their data tables can be seen in Appendix S.

#### 4.2.6 Weekend vs. Weekday

We also analyzed whether the incidence of electrical fires differed between weekdays and weekends. Figure 20 shows the average number of electrical fires (short-circuits and other electrical fires) by hour of the day for a weekend and weekday. Figure 20 is similar to Figure 19. The highest peak of both weekday and weekend is around 18:00 and the low point of the graph is around 05:00. This figure shows there is no significant variation between weekday and weekend occurrence of electrical fires.

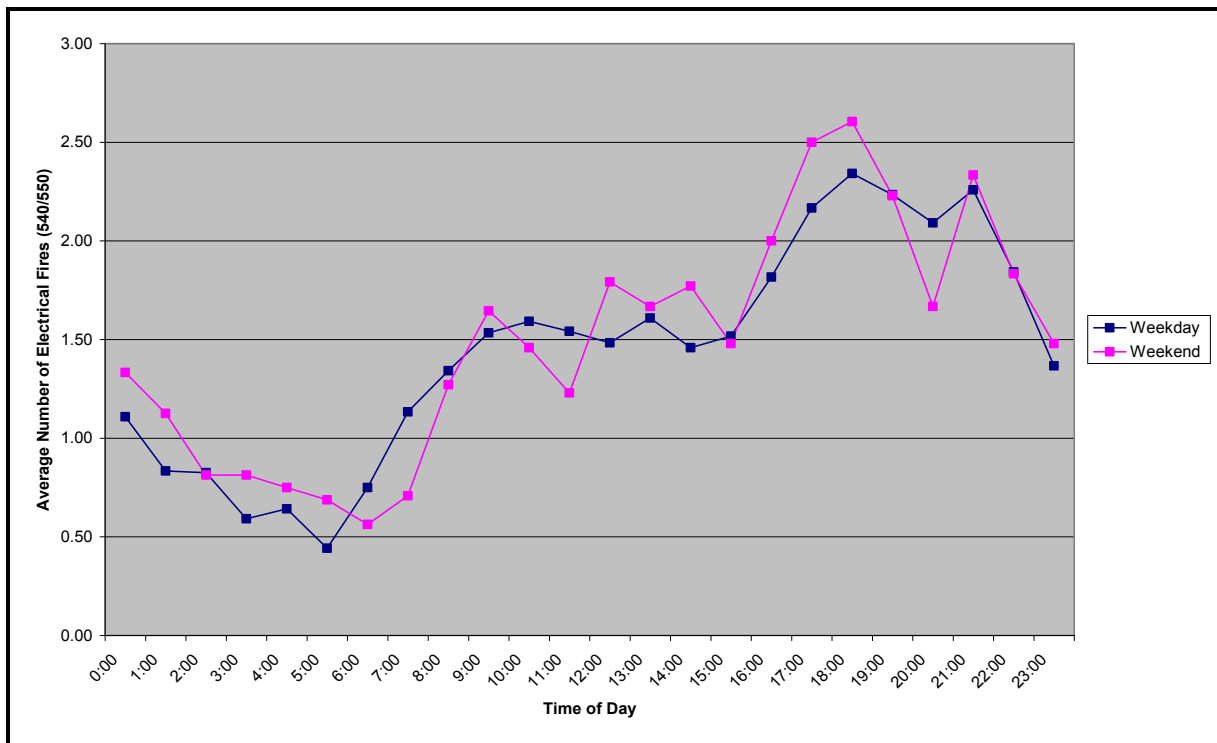

Figure 20: Average number of electrical fires per year by time of day for weekend and weekday.

We also analyzed short-circuits and other electrical failures separately to determine if they differed when plotted separately or when they were plotted together in Figure 20. This



separated analysis yielded the same patterns as Figure 20. The separated figures and data tables can be seen in Appendix T, U, and V.

#### 4.2.7 Month of the Year

Electrical fires occur any time of the year; however, we found that certain months of the year had more fires than others (Figure 20). The winter months of May, June, July and August have the highest number of electrical fires. This is the same observation as in section 4.2.4, where electrical fires occur more in winter. This could be attributed to people using more lighting and heating during the winter, as discussed in Section 2.1.1.

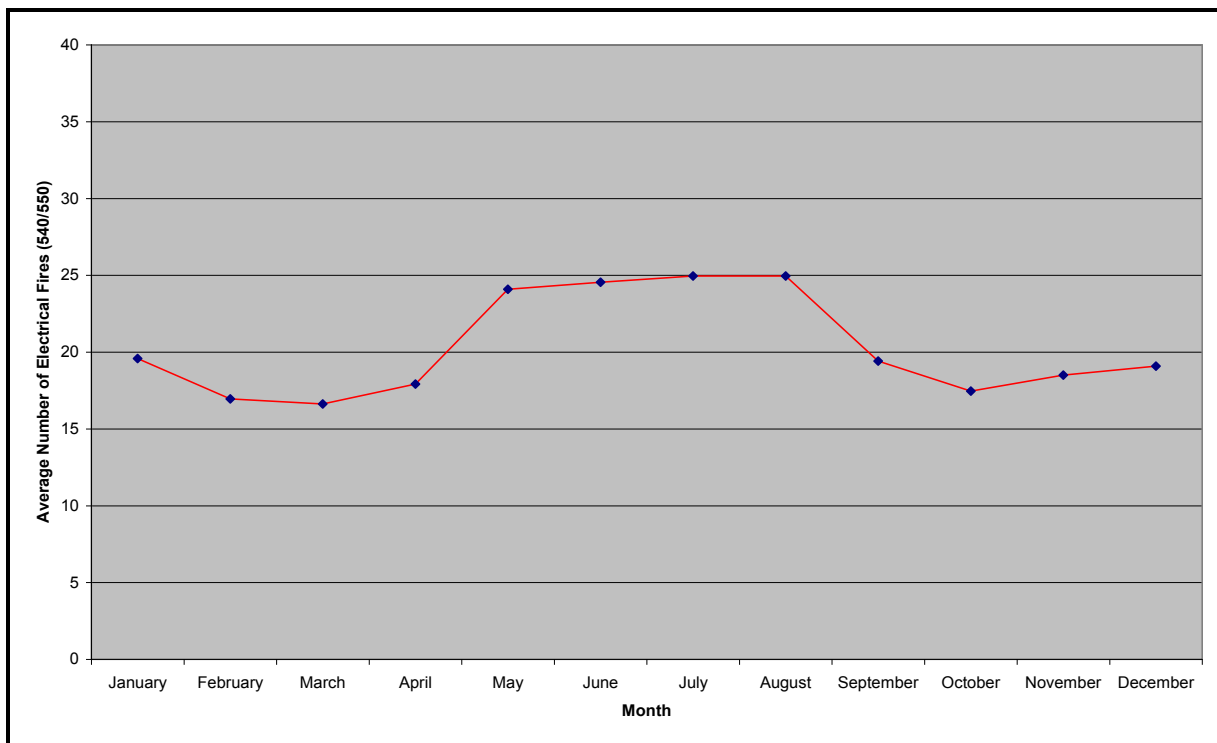

Figure 21: Average number of electrical fires per year by month of year (mean 20.3, standard deviation 3.3).

Short-circuits and other electrical failures were each analyzed separately to determine if they would yield different trends from Figure 21. These separated graphs showed that winter and summer were the highest of the four seasons as Figure 21 shows. The separated graphs and data tables can be seen in Appendix P, Q, and R.

#### 4.2.8 Heat of Ignition Analysis

We analyzed the heat of ignition of residential electrical fires to determine if any division, according to the breakdown in the AIRS manual, within the possible heat sources were significantly larger than another. We found the major heat of ignition in electrical fires was from an arc. After researching devices that could prevent arcing, we discovered Arc Fault Circuit Interrupters (AFCI). To determine if AFCIs would prevent a significant number of electrical fires per year, we separated the heat of ignition data into categories based on if AFCIs could have prevented the arc that resulted in the fire. AFCIs could prevent around 20 percent of electrical fires per year. Sixty-seven percent of electrical fires did not have enough information to properly determine if AFCI's could prevent them. The remaining categories were either not caused by an arc or AFCIs were unable to prevent that type of ignition source. The data table and breakdown of the heat of ignition in each of the four categories in Figure 23 can be seen in Appendix W.

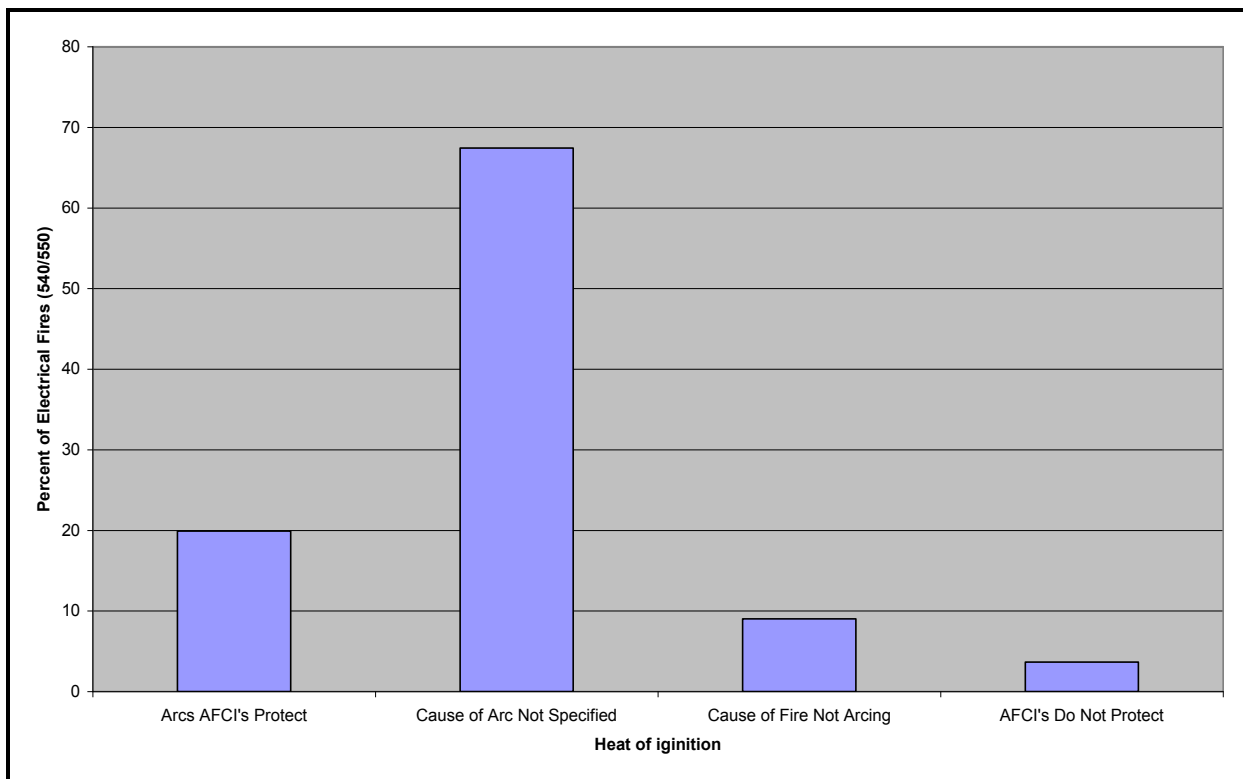

Figure 22: Percent of electrical fires by heat of ignition.

### 4.3 Societal Dimension

Our background sources all indicated that households with a lower net income are more susceptible to fire (TriData Corporation, 1997; Shai, 2006). Our analysis showed that electrical fires deviated from that pattern, increasing in frequency with household income levels. In this section we present analyses of electrical fires by maintenance area compared to income and education level by maintenance area. We also present a cost analysis with respect to residential electrical fires.

#### 4.3.1 Census Data Analysis

From the census data obtained from Kristen Carter, we performed a regression analysis with the help of our liaison, Jeff Watt. We ran a linear regression of electrical fires by average weekly income per 100,000 people from 1986-2009. Each of the data points of the linear regression were individual MFB maintenance areas. Figure 23 is a plot of our result.

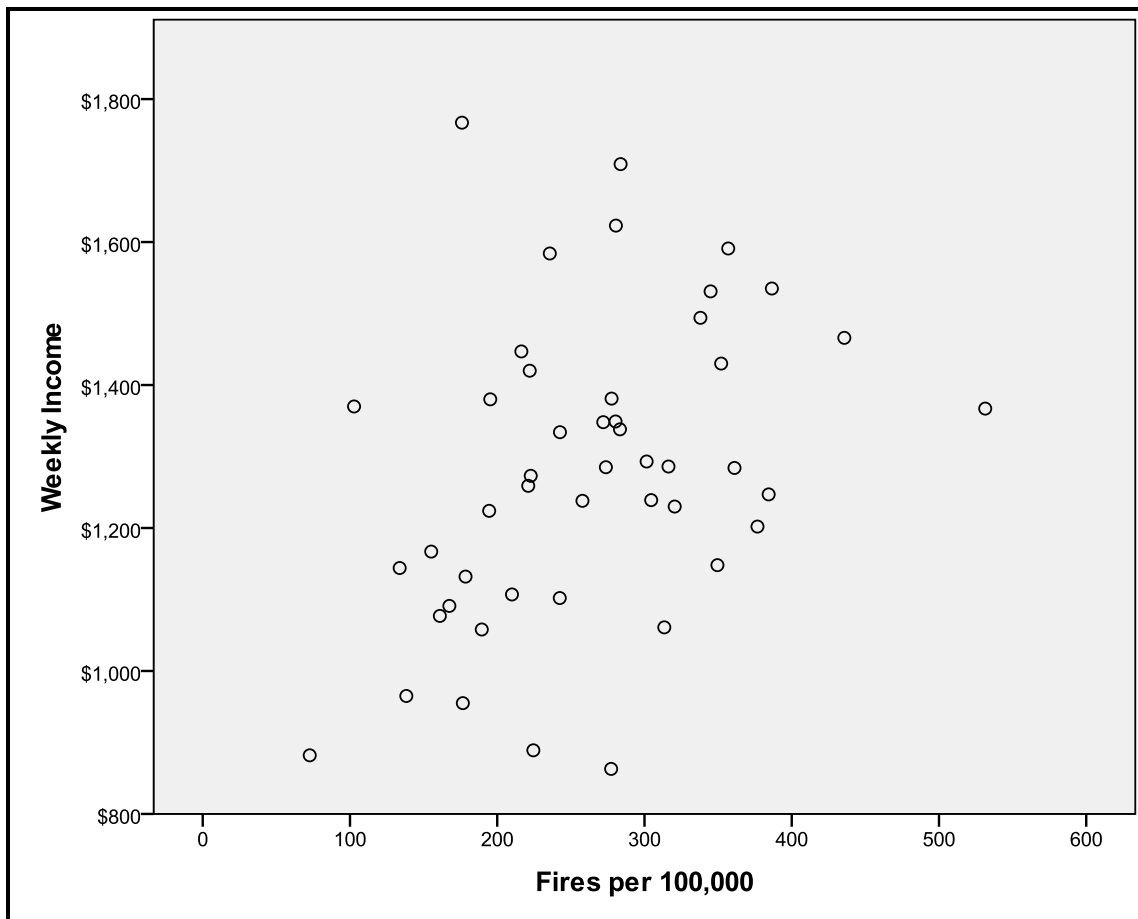

Figure 23: Linear regression of electrical fires per 100,000 people by average weekly income (1986-2009)

The regression analysis indicated a significant association between weekly income and the incidence of fires ( $R^2=0.141$ ). This positive value indicates that as weekly income increases so does the number of electrical fires. For the full statistics of the linear regression see Appendix X. These results are completely opposite to our initial research about the relationship between income and electrical fire incidence. Our research, as shown in Section 2.6.1, demonstrated that electrical fire occurrences are more common in homes where the income of the occupants is lower. Several possible reasons for this are discussed in Chapter 5.

With the census data, we also performed a linear regression of education level with number of fires per maintenance area with the help our liaison Jeff Watt. The regression analysis yielded a significant linear regression. The  $R^2$  value is .348. This regression analysis means that as education level increases so does the number of electrical fires. In Figure 24, education level is displayed as a ratio, where no education level is represented as a 1 and over a twelfth grade education is a 6.

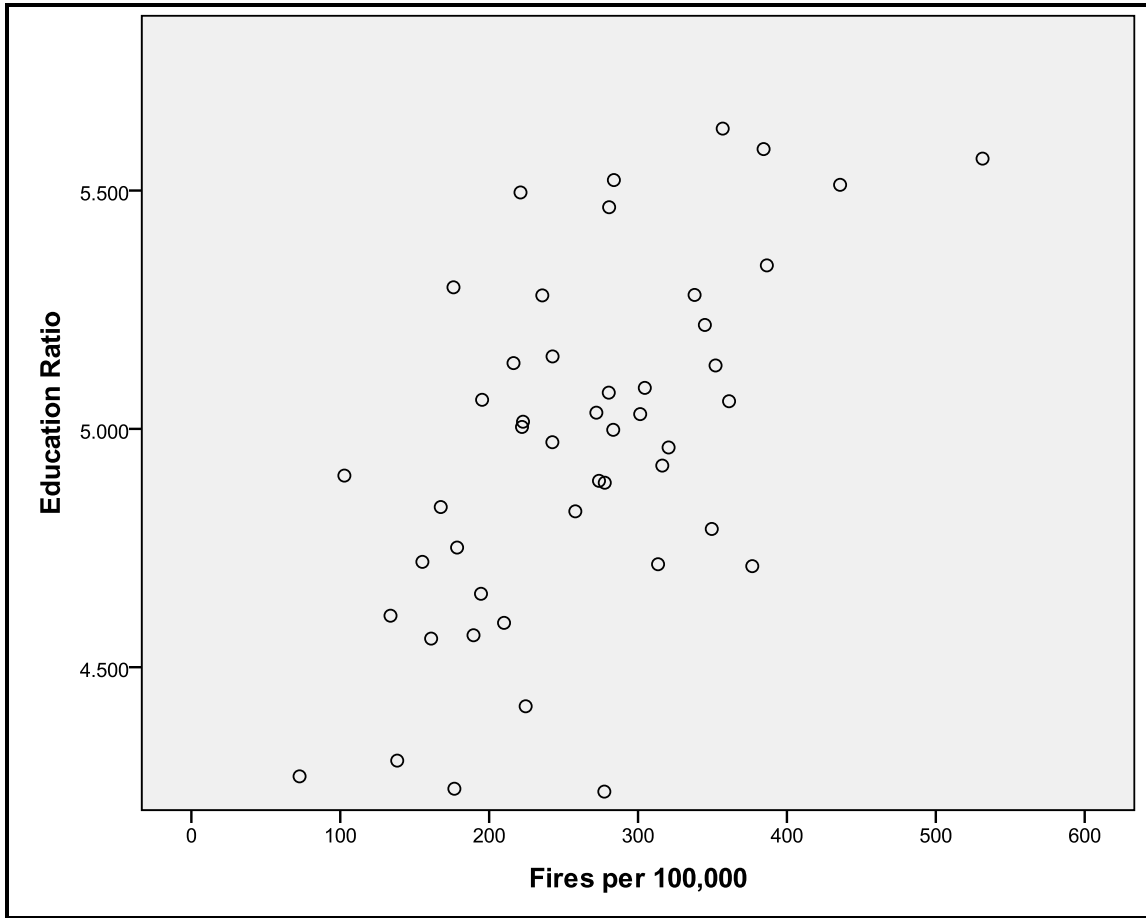

Figure 24: Average education ratio by electrical fires per 100,000 people (1986-2009)

We also separated electrical fires by maintenance areas of the MFD to show where the most number of electrical fires were occurring. Table 5 shows the significance of fires, income, and education by maintenance area. High means high significance; low means low significance, and NS means no significance. Several maintenance areas with high levels of fires, income, and education are Eastern Hill, Windsor, and Ormond.

MA #	Maintenance Area	Fires per	Average	Average	Stat. Distrib		
		100,000	Income	Education	Fires	Income	Education
1	Eastern Hill	531	\$1,367	5.567	HIGH	HIGH	HIGH
35	Windsor	436	\$1,466	5.512	HIGH	HIGH	HIGH
32	Ormond	387	\$1,535	5.343	HIGH	HIGH	HIGH
3	Carlton	384	\$1,247	5.587	HIGH	NS	HIGH
52	Tullamarine	377	\$1,202	4.712	HIGH	NS	LOW
13	Northcote	361	\$1,284	5.058	HIGH	NS	NS
38	South Melbourne	357	\$1,591	5.63	HIGH	HIGH	HIGH
33	Mentone	352	\$1,430	5.133	HIGH	HIGH	HIGH
26	Croydon	350	\$1,148	4.79	HIGH	LOW	LOW
19	North Balwyn	345	\$1,531	5.218	HIGH	HIGH	HIGH
10	Richmond	338	\$1,494	5.281	HIGH	HIGH	HIGH
22	Ringwood	321	\$1,230	4.961	HIGH	NS	NS
16	Greensborough	316	\$1,286	4.923	HIGH	NS	NS
12	Preston	313	\$1,061	4.716	HIGH	LOW	LOW
4	Brunswick	305	\$1,239	5.086	HIGH	NS	HIGH
27	Nunawading	301	\$1,293	5.031	HIGH	NS	NS
18	Hawthorn	284	\$1,709	5.522	NS	HIGH	HIGH
15	Heidelberg	283	\$1,338	4.998	NS	NS	NS
24	Malvern	281	\$1,623	5.465	NS	HIGH	HIGH
50	Ascot Vale	280	\$1,349	5.076	NS	HIGH	NS
42	Newport	278	\$1,381	4.887	NS	HIGH	NS
5	Broadmeadows	277	\$863	4.239	NS	LOW	LOW
45	Spotswood	274	\$1,285	4.891	NS	NS	NS
34	Highett	272	\$1,348	5.034	NS	HIGH	NS
6	Pascoe Vale	258	\$1,238	4.827	NS	NS	LOW
20	Box Hill	243	\$1,334	5.152	NS	NS	HIGH
47	Footscray	242	\$1,102	4.972	NS	LOW	NS
23	Burwood	236	\$1,584	5.28	NS	HIGH	HIGH
44	Sunshine	225	\$889	4.418	LOW	LOW	LOW
25	Oakleigh	223	\$1,273	5.015	LOW	NS	NS
30	Templestowe	222	\$1,420	5.004	LOW	HIGH	NS
2	West Melbourne	221	\$1,259	5.496	LOW	NS	HIGH
28	Vermont South	216	\$1,447	5.138	LOW	HIGH	HIGH
46	Altona	210	\$1,107	4.593	LOW	LOW	LOW
51	Keilor	195	\$1,224	4.654	LOW	NS	LOW
31	Glen Waverley	195	\$1,380	5.061	LOW	HIGH	NS
43	Deer Park	189	\$1,058	4.567	LOW	LOW	LOW
14	Bundoora	178	\$1,132	4.751	LOW	LOW	LOW
7	Thomastown	177	\$955	4.245	LOW	LOW	LOW
39	Port Melbourne	176	\$1,767	5.297	LOW	HIGH	HIGH
29	Clayton	167	\$1,091	4.836	LOW	LOW	LOW
41	St Albans	161	\$1,077	4.56	LOW	LOW	LOW
40	Laverton	155	\$1,167	4.721	LOW	LOW	LOW
49	North Laverton	138	\$965	4.304	LOW	LOW	LOW
11	Epping	134	\$1,144	4.608	LOW	LOW	LOW
48	Taylors Lakes	103	\$1,370	4.902	LOW	HIGH	NS
9	Somerton	73	\$882	4.271	LOW	LOW	LOW

Table 5: Electrical fires by maintenance area, average income, average education level

#### 4.3.2. Cost Analysis of Electrical Fires vs. Other Ignition Factors

Along with many other factors that were extracted with our fire incident data, we obtained data on the cost of fires related to their ignition factors (Section E5 of the AIRS manual). The ignition factors that our project is most concerned with are within Division 5 and are short circuits (540) and other electrical related fires (550). To make cost comparisons of different types of fires, we separated fire incidents from July of 1993 to December of 2009 by their ignition factor. Even though the fire incident data we obtained from MFB ranges from 1986 to 2009, the cost analysis data that we obtained from the AIRS program does not date farther back than 1993. Figure 24 shows the cost of fires of the different divisions of ignition factors.

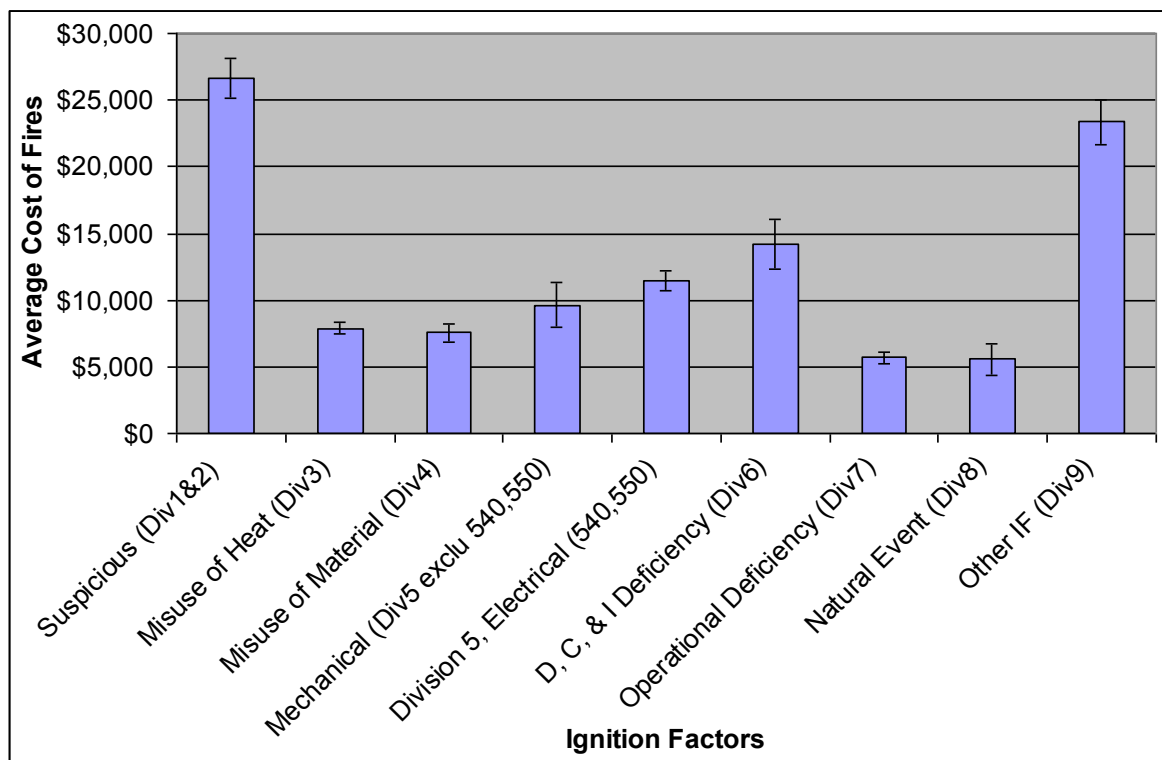

Figure 25: The cost of fires from July 1993 to December 2009 related to the factor resulting in their ignition. standard error bars are included.

The data revealed that the most costly fires on average were a result of suspicious factors (mean of AUD\$26,631). This is not surprising, because the person igniting them in all probability took precautions to ensure the home would burn a fair amount, either by using a flammable substance, such as petroleum, or by ensuring that the fire was not reported immediately to allow for the maximum amount of damage to take place. The second most costly

fires fall under division 9, “other ignition factors” (AUD\$23,390). This category includes fires in which the damage was so substantial that the ignition factor could not be identified, therefore being classified as “other.” This may explain the high cost associated with fires of this ignition factor. The third costliest fires are the division 6 fires (AUD\$14,189), which are a result of design, construction and installation deficiencies. These are fires where deficiencies in the building caused the ignition of a fire. Fires, where the infrastructure of the building is the ignition factor of the fire, may be the result of electrical wiring in the home; however, this cannot be determined from the data that we obtained, and other possibilities of the cause of the fires fall in this division. The fourth most costly fires are a result of short circuits and other electrical distribution equipment in the home. On average, fires falling in these two categories cost AUD\$11,416, ranging to date from zero dollars in damage to AUD\$1,000,000. Fires that have very little or no cost are recorded as zero dollar damage, such as a fire on the stove which is extinguished before it spreads, causing no or minimal damage. This shows that electrical fires in residential dwellings, while on the rise, are typically one of the more costly types of fire as well.



## **5. CONCLUSIONS**

Our analysis and background research led us to draw several conclusions. We describe these conclusions below in four categories: electrical demand increases, electrical fire characteristics, legislative conclusions, and societal conclusions.

### **5.1 Electrical Demand Increase**

From our analysis, electricity consumption per capita in Australia is on the rise. This is in part an apparent result of the increase in the number of energy-demanding appliances in Australian homes. New technologies such as computers, plasma and LCD televisions, and video gaming systems have been introduced in recent years, making a major contribution to the increase in household electricity consumption. Many people have resorted to using power boards as a solution to having more appliances than available power points. This solution has risks associated with it (such as overloading of the power point or circuit) when the power boards are not used with appropriate appliances or when they do not contain a surge protector. In addition, the size of homes in Australia is increasing, causing the electricity consumed for heating and cooling to increase. Moreover, homes are using power-hungry air conditioning systems, which further accounts for the increase in residential electricity consumption.

Older homes without any electrical upgrades were designed to carry loads for the appliances of their time, and since their installation, electrical systems that have not been upgraded have been deteriorating. This creates the compound issue of wires deteriorating as electricity consumption per household increases (shown in Section 4.1.2). We conclude that these two factors collectively account for a significant part of the increase in residential electrical fires originating from components of the electrical distribution system (shown in Section 4.2).

### **5.2 Electrical Fire Characteristics**

Through our research related to electrical fires and analysis of Victorian fire incident data, we identified fixed electrical wiring systems as the leading contributor to the ignition of electrical fires. These types of fires appear to have increased over the past several years and may continue to do so. Also we determined that arcing is the leading source of heat for ignition of combustible materials (Figure 23). Arcing is caused by numerous factors; one major factor is worn and defective insulation of fixed electrical wiring (as seen in Appendix W). Due to its

extreme temperature, an arc, especially in the walls of a home, can ignite almost any combustible material. Unprotected arcing in a home can result in fire, loss of property, and life.

People can directly influence their chances of an electrical fire occurring in their homes by reducing the electricity demand on the circuits. Electricity consumption and the occurrence of electrical fires are related. Throughout the day as electricity consumption increases so does the occurrence of electrical fires (Figure 2, 3 and 19). Electrical fires occur more often in the winter and summer than spring and fall electrical fires due to the temperature, weather, and daylight changes (Figure 21). These changes affect the amount of electricity people consume in their home. As the daylight decreases greater usage of lighting occurs. As the temperature decreases, the increase in the amount of electricity used for heating purposes increases. The weather influences the power consumption because residents want to maintain ideal living conditions within the home. This is not a problem if a home's electrical wiring is updated and rated for the amount of electricity they use; however, if the wiring is not updated then potential problems will arise.

### **5.3 Social Dimensions**

After performing a correlation analysis of weekly income with the number of fires occurring in each maintenance area, we determined that there is a positive relationship between the two. The relationship is variable but statistically significant, and allows us to make the claim that income does have an effect on the number of electrical fires occurring in the MFD. The relationship described in the correlation analysis was not what we first hypothesized. We expected that maintenance areas with lower incomes would have a greater number of electrical fires occurring. We made the assumption that homeowners, who could not afford upgrading their electrical systems or initially buy a home with sufficient electrical wiring systems, would experience more electrical fires. The results from the correlation analysis show the opposite. Possibly, maintenance areas with higher incomes have homeowners that can afford more appliances which consume more electricity, causing a greater demand on electrical systems and as a result cause more fires.

We report a similar positive relationship between education level and the number of fires occurring in each maintenance area. Again, the relationship was variable but statistically significant, and allows us to make the inference that maintenance areas with higher average

education levels have more electrical fires. Given that there is typically a strong relationship between education and income, this pattern is not surprising. However, it also indicates that education level may not correlate positively with a tendency to maintain safe electrical practices in the home.

We also conducted an analysis on the cost of electrical fires. From our analysis of the fire incident data obtained from MFB, we conclude that residential electrical fires are one of the top five costly fires. Given that electrical fires can originate within the walls of a home, destroying the home from the inside out, the results that were found are not surprising. The rehabilitation of a home would be costly because a home would have to be completely restructured with interior walls, insulation, and new electrical systems. Depending on the severity of the fire, an entire house could need restructuring from the ground up.

Our analysis of the occurrence of electrical fires suggests that deregulation and privatization of the electrical industry may have had consequences for the frequency of residential fires. Shown in Figure 12, the percent of residential electrical fires increased steadily from the mid-1990s to the present day. Prior to 1999, all electrical installations were professionally inspected, but since then, non-prescribed installations have not been professionally inspected, and this may contribute to increases in the number of residential electrical fires. When comparing the privatization of the electrical industry in Australia to the privatization in the United States, the conclusion can be drawn that the shift in focus caused by private companies may also be responsible for the decrease in quality inspections and routine maintenance, and created an uninviting situation for legislation to improve these processes. The government did not want to step in and regulate the private sector because the electricity industry is no longer their responsibility. Also, the electricity industry had just gone through the process of deregulating and was not going to sacrifice profit margins just to save infrastructure and essentially reverse the privatization.

## **6. RECOMMENDATIONS**

We have developed several recommendations that will aid the MFB in achieving their long-term goal of increasing public awareness of the dangers of electrical fires and in reducing their occurrences protecting newly constructed homes from arcing, and increasing the validity of fire incident data.

### **6.1 AIRS and Firefighter Investigators**

Throughout this project we found that obtaining certain fire incident datasets was extremely difficult and complex. The age of homes, installations of electrical systems, and electrical system upgrades are not recorded in a database. As a result of not having this data, we were not able to identify any relationships between residential electrical fires and demand on electrical distribution systems. For this reason we recommend that other classifications be added to the Australasian Incident Reporting System (AIRS). The age of homes, installations of electrical systems, and electrical system upgrades should be added to the AIRS to aid in further research in the future. During the course of an investigation, the investigating fire officer could ask the homeowner about the age of the home and electrical system. Then he would be able to add that information into the AIRS system along with the other fire incident data gathered. This would allow better correlation between cause of fire and age of property and electrical systems to be conducted. To accurately determine if aging wiring is causing increases in electrical fires, the age of the home and electrical wiring needs to be determined.

The information contained in the AIRS is not particularly accurate because the system relies on the fire officer's level of training and knowledge of fire science. The lack of consistency within the dataset made it difficult to analyze. For this reason we recommend an educational program for firefighters involved in investigating fire scenes or the use of Certified Fire Investigators. Certified Fire Investigators are people trained in analyzing the scene of a fire. This is a valuable profession in the United States. When the exact cause of a fire needs to be determined, a Certified Fire Investigator is called upon to analyze the scene. Their training would make the data in the AIRS system more accurate and reliable. Both of these recommendations would greatly improve the validity of the fire incident data.

Once these recommendations are completed, we also suggest that another research project be conducted to analyze the data after of couple years of data collection. This research project would answer more definitively the question of whether aging wiring causes electrical fires, because the research would have provided more accurate data. Once this research has been conducted specific recommendations based on the exact cause of electrical fires and aging wiring can be made.

## **6.2 Analysis of Aging Wiring**

To completely understand the effects increased demand has on aging electrical distribution systems, we recommend the MFB gather more data by surveying, recovering, and analyzing samples of existing installed residential wiring systems in homes of different ages. Where our team could only apply informed inferences and assumptions to draw conclusions, the field samples will allow for case studies to draw direct links between deteriorated wiring and associated potential fire risks. In order to obtain accurate information, several homes varying in age will need to be examined in different areas of Australia, including Victoria. We suggest when the houses are surveyed, the buildings' location, style, type of architecture, and age be recorded. To avoid destruction of a person's home, the houses that are examined should be houses that cannot be used for occupancy or houses that are scheduled for demolition. This would allow for the major portions of the wiring to be examined and analyzed in a laboratory. Because the house is no longer in use, it could potentially have problems with the electrical wiring system from not being used periodically. Electrical systems are within the walls and should be found the way they were left when the house was occupied. However, to assure proper data are being collected, the occurrence of vandalism should be assessed. Homes that have not been occupied may have experienced vandalism, which can affect the electrical systems. The houses no longer in use can be determined from local building departments or local contractors. Electrical inspectors, members of MFB, or volunteers could survey and recover the existing electrical systems. Examining previous building permits and talking to building owners will also help in the process of determining if any upgrades or major renovations have been done to the house. The electrical systems from the homes will then be collected for further analysis. To analyze the electrical distribution systems, commercially available power point testing devices would be used. Surveying existing installed wiring will

allow for a better understanding of what factors contribute to the increase of electrical fires in residential dwellings (Dini, 2008).

### **6.3 Privatization and Routine Inspections**

The Electricity Safety Act of 1998 of Victoria required a certificate of electrical safety to be submitted following certain electrical installations. This act divided electrical work into the categories of prescribed and non-prescribed. This resulted in many new installations falling into the non-prescribed classification, and therefore not in need of inspection. Stuart Cook, who has been an electrical inspector for 30 years for CitiPower, communicated to us that many of the problems he commonly finds with new installations of electrical systems that he felt could lead to fire or deemed unsafe now fall under the category of non-prescribed electrical work and does not need to be inspected. In addition, since the privatization of the electricity industry and the division of prescribed and non-prescribed electrical work, electrical fires occurring in dwellings has increased greatly. We recommend that an increased number of audits take place on non-prescribed electrical work after a deeper analysis of effects of privatization on the occurrence of electrical fires. Another idea that ESV attempted to have implemented was to have homes inspected every time the occupants of the home changed. This was an excellent idea but due to the cost of implementation and the cost of all the inspections, it never passed legislation. One problem with the legislation was that some homes change tenants several times a year, so those homes would need more inspections than reasonably affordable. One possible solution to this that will make implementing this more practical would be to make a condition where the home needs to be inspected when the occupants of the home change, if the home has not had an inspection within the past 5 years. These inspections would still cost the homeowners when they are required, but it would be reassuring as a new occupant of the dwelling to know the electrical system is safe.

Another avenue to pursue to have aged electrical systems inspected would be through insurance agencies. We contacted Andre Mierzwa, Vice President and Chief Engineering Technical Specialist for FM Global's Australian and New Zealand Operations. Mierzwa stated that currently insurance agencies do not currently have an assessment system in place regarding the adequacy of electrical systems in homes. FM Global is an international company providing comprehensive global commercial and industrial property insurance, support and risk

management solutions, and property loss prevention research (FM Global, 2010). If insurance companies offered lower premiums for homes that recently had their electrical systems inspected, that would be motivation for homeowners to get their electrical systems inspected. Having electrical systems in dwellings inspected to ensure they meet today's standards will decrease the occurrences of electrical fires. Insurance companies may have the incentive to do this because it will decrease the number of fires they are responsible for covering.

#### **6.4 AFDD's**

To aid in the reduction of electrical fires, we recommended implementing a code or standard for new construction requiring Arc Fault Detection Devices (AFDD's) to be installed. Such a device could be similar to Arc Fault Current Interrupters (AFCI) used in the United States. Since arcing is a major source of heat for ignition of electrical fires, AFCI's would help prevent this major cause. Based on our analysis, anywhere between 20 to 88 percent of electrical fires could be prevented by an AFCI (Figure 22). Since AFCI's are a new technology that have recently been put on the market, statistics about the success rating of them are not known; however, the U.S. Consumer Product Safety Commission, after conducting their own research study on AFCI's, concluded that AFCI's can prevent 50 to 75 percent of residential electrical fires. AFCI's have been extensively studied and tested by the Underwriters Laboratories, the National Association of State Fire Marshals (NASFM), and the U.S. Consumer Product Safety Commission and prove to work. (Consumer Product Safety Task Force, National Association of State Fire Marshals, 2002)

A major consideration in the installation of AFCI's is the overall cost. One AFCI costs between \$35 and \$40 per unit. A single AFCI is installed to a single circuit. In the 2008 NEC, AFCI's are required in all habitable rooms of a home. These include bedrooms, living rooms, and kitchens. Therefore to calculate the entire cost of installing AFCI's into a home, the total number of circuits in the home needs to be known. The total cost of the required units in addition to the cost of a licensed electrician to properly install the devices is the total cost of installation. Implemented on a broad scale, the total cost of these installations is small compared to the average cost of an electrical fire. The average cost of an electrical fire is AUD \$11,416, total cost ranging to date from zero dollars to AUD\$1,000,000 in damage. A potential method to alleviate the cost of installing AFCIs in an existing home would be to provide an incentive from insurers.

As described in the previous section, this incentive could be in the form of lower premiums or rebates from the insurance company. This method is based on the same principle as insurance for automobiles. For automobiles, if a person is a safe driver without any vehicular accidents then his premium decreases over a number of years. This incentive would be the same for a home. If a person installs AFCIs in their home then he would get a reduction in his insurance premiums. This would potentially provide enough incentive to the homeowner to install the needed safety measures.

Electrical fires are destructive to both property and lives. The cost of a home is finite but the cost of lives is incalculable. For only several hundred dollars, protection can be installed in a home to diminish the probability of a fire.

### **6.5 Public Awareness and Education**

A recommendation that will aid in the prevention of electrical fires is to formulate publicity and an educational campaign to better educate the public of the risks associated with aging electrical distribution systems in homes. There are several ways in which this can be accomplished. Very little is being done to inform the general public in Australia about certain actions that lead to electrical fires. If MFB, ESV, and other organisations created public service announcements, educational fliers, and free educational seminars specifically targeted towards the problem of electrical fires, we feel certain electrical fires could be prevented or reduced in frequency.

A specific area where education of the public could be increased is on the proper use of power boards. If power boards are used properly, they do not pose any particular danger to the electrical system in the home. However, when they are used improperly, either by “piggy backing” them to obtain more available power points, or using larger appliances than the power boards are rated for, there is a much greater potential for overloading the electrical circuit or power point that is in use. In addition, it would be beneficial to foster awareness that electrical systems in homes do not have an infinite lifespan. Many people feel that if their electrical distribution system in their home appears to be functioning properly, then there is no need to consider an upgrade. With a car, we notice when something is deteriorating or breaking down and we take the car to the service station to be fixed. Homeowners rarely get their house inspected after the purchase of the home is finalized. An electrical system can appear to be



functioning properly with no noticeable problems, but can then ignite a home due to a faulty over current protection device, exposed conductors, or a loose connection in the walls of the home. As systems age, these are common problems that have led to fires.

Raising awareness of the potential dangers that exist within Australian homes and publicizing potential consequences for not taking action should motivate Australians to have their electrical distribution system inspected, and if need be, upgraded. This can be done by televising public service announcements and sending fliers to homes. Fire stations could host educational programs attracting parents and children by giving a tour of the fire station, and then sit down and educate the families about the increasing occurrence of residential electrical fires and how they can be reduced. The key would be to portray to the homeowners the frequency of residential electrical fires and emphasize the damages from them. Relating the cost of an electrical inspection to the average cost of electrical fires (AUD\$11,416, shown in Section 4.4.4) as well as the psychological factors of having your home burn down should motivate many people to consider an inspection. If the inspection discovers unsafe wiring or electrical components, most people will then have the desire to have it fixed, despite the large cost that may be associated with it. Therefore, these televised public service announcements and educational campaigns should emphasize getting an inspection, after portraying the problem of present electricity demands on aged wiring systems, leading to an increase in residential electrical fires in recent years. This recommendation should increase the desire for homeowners to ensure that their electrical systems are up to par with modern electrical energy demands.

Based on our research we showed that fixed wiring is a major cause of electrical fires and that arcing is the primary heat of ignition in an electrical fire. Also we demonstrated the similarities between household electricity consumption and the occurrence of electrical fires. Residential electricity consumption can be contributed to an increase in the number of appliances. From our regression analysis, the relationship between electrical fires, income level and education level differed from published opinion. If the preceding recommendations are implemented, then we expect that, over time, the MFB will detect a substantial decrease in electrical fires. We feel that homes in Victoria, Australia will be particularly impacted with the installation of AFCIs in newly constructed residences, a higher frequency of inspections and with substantial efforts to increase public awareness of the risk associate with placing high electrical

demand on residential wiring systems.

## BIBLIOGRAPHY

- Andrews, Thomas. (n.d.). *What happens when electrical wiring gets wet inside the house*. Retrieved April 30, 2010, from [http://www.ehow.com/how-does\\_5641388\\_happens-gets-wet-inside-house\\_.html](http://www.ehow.com/how-does_5641388_happens-gets-wet-inside-house_.html)
- Australasian Fire Authorities Council. (2005). *Accidental fire fatalities in residential structures- Who's at risk*. Melbourne: Australasian Fire Authorities Council.
- Australia Property News. (2009). *Australia overtake the US in size stakes*. Retrieved April 2010, from <http://www.apimagazine.com.au/api-online/news/2009/11/australia-overtakes-the-us-in-size-stakes>
- Australian Bureau of Meteorology. (2010). *Climate statistics for Australian locations*. Retrieved March 31, 2010, from [http://www.bom.gov.au/climate/averages.tables/cv\\_086071.shtml](http://www.bom.gov.au/climate/averages.tables/cv_086071.shtml)
- Australian Bureau of Statistics. (2009a). *Are households using renewable energy*. Canberra: Australian Bureau of Statistics.
- Australian Bureau of Statistics. (2009b). *Household income and income distribution*. Canberra: Australian Bureau of Statistics.
- Australian Bureau of Statistics. (2010). *Census of Population and Housing*. Retrieved April 2010, from <http://www.abs.gov.au/websitedbs/d3310114.nsf/Home/census>
- Babrauskas, V. (2001). How do electrical wiring faults lead to structure ignitions. *Paper presented at Proc. Fire and Materials 2001 Conference* (pp. 39-51). London: Interscience Communications Ltd.
- Beder, S. (2006). Electricity: The global impacts of power reforms. In D. Chavez, *Beyond the market: The future of public services, Public Services Yearbook 2005/6* (pp. 57-66). Amsterdam: TNI/Public Services International Research Unit (PSIRU).
- Beder, S., & Cahill, D. (2005a). Neo-liberal think tanks and neo-liberal restructuring: Learning the lessons from project victoria and the privatisation of Victoria's electricity industry. *Social Alternatives* , 24 (1), 43-8.
- Beder, S., & Cahill, D. (2005b). Regulating the power shift: The state, capital and electricity privatisation in Australia. *Journal of Australian Political Economy* , 5-22.
- Bertoldi, P., & Atanasiu, B. (2007). *Electricity consumption and efficiency trends in the enlarged European Union*. Luxembourg: Office for Official Publications of the European Communities.

- Bethel, B. (2009). *Winter brings increased home fire dangers*. Retrieved March 31, 2010, from Abilene Reporter: <http://m.reporternews.com/news/2009/dec/05/winter-fire-xxly-xxly-xxly-xxly>
- Bhavnagri, K. (2010). *How do I use electricity throughout the day-the load curve*. Retrieved March 31, 2010, from: <http://www.solarchoice.net.au/blog/how-do-i-use-electricity-throughout-the-day-the-load-curve.html>
- Canadian Standards Association. (2009). *Standards development*. Retrieved on April 2010 from <http://www.csa.ca/cm/ca/en/standards-development>
- Carr, Shelly. (2009). *Increasing demand for electricity reveals bright future for residential generators market*. Retrieved April 21, 2010, from <http://www.sbireports.com/about/release.asp?id=1527>
- Comeau Ed. (1999). *A comparison of the NFPA National Electrical Code (NEC) and IEC 60364*. Retrieved on April 2010, from <http://www.writer-tech.com/pages/technical/NEC-IEC.htm>
- Consumer Product Safety Task Force, National Association of State Fire Marshals. (2002). *AFCI inquiry and report*. National Association of State Fire Marshals.
- Department of Sustainability and Environment. (2004). *Households: What is the difference between population and household growth*. Retrieved April 22, 2010, from [http://www.land.vic.gov.au/CA256F310024B628/0/A55E3A4F916BE3D2CA256F620014A6A1/\\$File/YQA+-+Households.pdf](http://www.land.vic.gov.au/CA256F310024B628/0/A55E3A4F916BE3D2CA256F620014A6A1/$File/YQA+-+Households.pdf)
- Department of Trade and Industry. (n.d.). *Energy consumption in the United Kingdom*. London: Energy Publications.
- Dini, D. A. (2008). *Residential electrical system aging research project*. Underwriters Laboratories. Quincy: The Fire Protection Research Foundation.
- Dini, D.A. (2006). *Some history of residential wiring practices in the U.S.* Quincy: Underwriters Laboratories Inc.
- Edwards, C. (1969). *Brown power: a jubilee history of the State Electricity Commission of Victoria*. Melbourne: State Electricity Commission of Victoria.
- Electrical Safety Council. (n.d.). *Electricity in the home-guide to fire safety*. Retrieved from <http://www.esc.org.uk/pdfs/safety-in-the-home/FireSafety-ESC.pdf>
- Electrical Safety Foundation International. (2010). *National electrical safety month campaign Toolkit*. Retrieved April 21, 2010, from [http://esfi.org/files/ESFI-NESM-Toolkit\\_FINAL\\_1Apr10.pdf](http://esfi.org/files/ESFI-NESM-Toolkit_FINAL_1Apr10.pdf)

- EMET Consultants Pty Limited. (2004). *The impact of commercial and residential sector's EEI's on electricity demand*. Sustainable Energy Authority of Victoria.
- Energy Australia. (n.d.). *Energy Usage Guide*. Retrieved April 2010, from [http://www.ruralresidentialliving.com.au/saving\\_energy/resource\\_downloads/Energy%20Usage%20Guide.pdf](http://www.ruralresidentialliving.com.au/saving_energy/resource_downloads/Energy%20Usage%20Guide.pdf)
- Energy Information Administration. (2005). *U.S. household electricity report*. Retrieved February 21, 2010, from [http://www.eia.doe.gov/emeu/repse/enduse/er01\\_us.html](http://www.eia.doe.gov/emeu/repse/enduse/er01_us.html)
- Energy Safe Victoria. (n.d.). *About the certificate of electrical safety*. ESV brochure
- Energy Safe Victoria. (2006). *Energy safe victoria annual report*. Southbank: Energy Safe Victoria.
- Energy Safe Victoria. (2007). *Energy safe victoria annual report*. Southbank: Energy Safe Victoria.
- Energy Safe Victoria. (2008). *Energy safe victoria annual report*. Southbank: Energy Safe Victoria.
- Energy Safe Victoria. (2009). *Energy safe victoria annual report*. Southbank: Energy Safe Victoria.
- Energy Safe Victoria. (2010). *Home safety inspection*. Retrieved February 17, 2010, from <http://eservices.esv.vic.gov.au/esvext/hsi/index-cust2.asp>
- FM Global. (2010). *FM Global is insurance evolved*. Retrieved April 16, 2010, from FM Global: <http://www.fmglobal.com/page.aspx?id=01000000>
- Gardner, K. (2005). *Inquiry into housing construction sector and related issues*. Melbourne: Office of the Chief Electrical Inspector.
- Hadjisophocleous, G.V., & Bénichou, N. (n.d.). *Development of performance-based codes, performance criteria and fire safety engineering methods*. National Research Council Canada.
- Hall Jr., John R. (2009). *Home electrical fires*. Quincy: National Fire Protection Association.
- Industry Commission. (1995). *Regulation and its Review*. Belconnen: Industry Commission.
- Inquiring Eye Home Inspections, LLC. (2010). *Newsletter*. Retrieved April 1, 2010, from [http://www.inquiring-eye.com/newsletters/090522\\_newsletter.htm](http://www.inquiring-eye.com/newsletters/090522_newsletter.htm)
- International Electrotechnical Commission. (2010). *Home page*. Retrieved April 2010, from <http://www.iec.ch/>

- Joint Technical Committee EL-011. (2009). *AS/NZS 3000:2007 wiring rules*. (5th ed.). Sydney: Standards Australia, 376, Table C6.
- Meacham, Brian. (1998). *The evolution of performance based codes and fire safety design methods*. Gaithersburg: National Institute of Standards and Technology
- Midwest Electrical Testing & Maintenance Company Inc. (2010). *Circuit Breaker History*. Retrieved April 22, 2010, from <http://www.swgr.com/articles/Circuit-Breaker-Technical-Information.aspx>
- Narayan, P. K., & Smyth, R. (2005). Electricity consumption, employment and real income in australia evidence from multivariate granger causality tests. *Energy Policy*, 33(9), 1109-1116.
- National Electrical Manufacturers Association. (n.d.). *What is an AFCI?* Retrieved April 1, 2010, from National Electrical Manufacturers Association: <http://www.afcisafety.org/qa.html>
- National Fire Protection Association. (2008). *Guide for fire and explosion investigations*. Quincy: National Fire Protection Association.
- National Fire Protection Association. (2010). *Overview*. Retrieved April 2010, from <http://www.nfpa.org/categoryList.asp?categoryID=495&URL=About20NFPA/Overview>
- National Research Council Canada. (2010). *About national research council*. Retrieved April 2010, from <http://www.nrc-cnrc.gc.ca/eng/about/index.html>
- Natural Resources Canada. (2009). *Energy sources: About electricity*. Retrieved April 2010, from <http://www.nrcan-rncan.gc.ca/eneene/sources/eleeele/abofai-eng.php>
- Office of the Chief Electrical Inspector. (2005a). *Office of the chief electrical inspector: Annual report*. Southbank: Office of the Chief Electrical Inspector
- Office of the Chief Electrical Inspector. (2005b). *The safe use of power boards*. Retrieved April 2010, from <http://www.esv.vic.gov.au/Portals/0/Alerts%20&%20Recalls/Files/SafetyAdvice-SafeUseOfPowerBoards2005Mar.pdf>
- Oglesby, T. (n.d.). *Old wiring*. Retrieved from <http://www.homecheckamerica.net/xsites/Inspectors/homecheckamerica/content/uploadeupload/Old%20Wiring.pdf>
- Paige Electric. (n.d.). *Type UF/NMC-B spec*. Retrieved April 30, 2010, from <http://www.paigeelectric.com/specs/P7295D.pdf>

- Patel, V. (2005). *Electrical wiring systems and fire risk in residential dwellings*. Wellington: Energy Safety Service.
- Peppers Cable Glands Ltd. (n.d.). *An introduction to cable glands*. Retrieved April 1, 2010 from [http://www.cableglands.com/pdf/Peppers\\_Introduction\\_To\\_Cable\\_Glands\\_Show.pdf](http://www.cableglands.com/pdf/Peppers_Introduction_To_Cable_Glands_Show.pdf)
- Rainbow Power Company Ltd. ( 2006). *Estimating your needs*. Retrieved April 2010, from [http://www.rpc.com.au/products/efn/efnexttracts/estima\\_rating.html](http://www.rpc.com.au/products/efn/efnexttracts/estima_rating.html)
- Rasbash, D. Ramachandran, G. Kandola, B. Watts, J, Law, M. (2004). *Evaluation of fire safety*. Chichester: John Wiley & Sons.
- Rasdall, J. (2005). *Aging residential wiring issues: Concerns for fatalities, personal injuries, and loss of property*. Muncie: Ball State University, Family and Consumer Sciences Department.
- Red Apple Education. (2010). *Home Appliances*. Retrieved April 23, 2010, from [http://www.skwirk.com.au/p-c\\_s-14\\_u-189\\_t-505\\_c-1863/home-appliances/nsw/home-appliances/australia-s-social-and-cultural-history-in-the-post-war-period/the-impact-of-changing-technology-on-everyday-life](http://www.skwirk.com.au/p-c_s-14_u-189_t-505_c-1863/home-appliances/nsw/home-appliances/australia-s-social-and-cultural-history-in-the-post-war-period/the-impact-of-changing-technology-on-everyday-life)
- Roarty, Mike. (2003). *Electricity Deregulation Outside the New South Wales and Victorian Markets*. Science, Technology, Environment and Resources Group.
- Schultz, Andrew. (2009). *Energy update 2009*. Canberra: Australian Bureau of Agricultural and Resource Economics.
- Shai, D. (2006). *Public health reports*. Income, Housing, and Fire Injuries: a Census Tract Analysis, 121, pp. 149-154.
- TriData Corporation. (1997). *Socioeconomic factors and the incidence of fire*. Washington, DC: United States Fire Administration, Federal Emergency Management Agency.
- United States Fire Administration. (2008). *Residential electrical fires*. Topical Fire Report Series, 8 (2), pp. 1-9.

## **APPENDIX A: ABBREVIATIONS**

ABS – Australian Bureau of Statistics  
AESMR – Annual Essential Safety Measures Report  
AFAC - Australasian Fire and Emergency Service Authorities Council  
AFCI – Arc Fault Circuit Interrupter  
AFDD – Arc Fault Detection Device  
AIRS – Australasian Incident Reporting System  
ANS – American National Standard  
ANSI – American National Standards Institute  
AUD – Australian Dollar  
BCA – Business Council of Australia  
BSI – British Standards Institute  
CCBFC - Canadian Commissions on Building and Fire Codes  
CSA – Canadian Standard Organization  
DIY – “do-it-yourselfer”  
EMET – Engineering & Management Consultants  
EPAC – Economic Planning Advisory Commission  
ESV – Energy Safe Victoria  
HSI – Home Safety Inspection  
IEC – International Electrotechnical Commission  
IEEE – Institute of Electrical and Electronic Engineers  
HSI – Home Safety Inspection  
LCD – Liquid Crystal Display  
LGA – Local Government Area  
MFB – Metropolitan Fire and Emergency Services Board  
MFD – Metropolitan Fire District  
NASFM – National Association of State Fire Marshals (US)  
NEC – U.S. National Electrical Code  
NECA – National Electrical Contractors Association  
NFPA – National Fire Protection Association  
NETA – InterNational Electrical Testing Association  
NRC – National Research Council of Canada  
OCEI – Office of the Chief Electrical Inspector  
OGS – Office of Gas Safety  
PASW – Predictive Analytics Software (formerly SPSS)  
PVC – Polyvinyl Chloride  
QFRS – Queensland Fire and Rescue Services  
RCD – Residual Current Device  
SBI – Specialists in Business Information



SDO – Standard Developing Organization  
SECV – State Electricity Commission of Victoria  
SPSS – Statistical Package for Social Sciences  
TPS – Thermoplastic Sheathing System  
UWUA – Utility Workers Union of America

## APPENDIX B: AS/NZS 3000 DEFINED TERMS

AS/NZS 3000:2007

22

Part 1 (Section 1) of this Standard provides a mechanism for acceptance of design and installation practices that may not be addressed by those given in Part 2 (Sections 2 to 8) of this Standard. This mechanism is only intended to apply where departures from the methods in Part 2 are significant.

NOTE: A degree of flexibility exists within Part 2.

### 1.3 REFERENCED DOCUMENTS

See Appendix A for a list of documents referred to in this Standard.

### 1.4 DEFINITIONS

#### 1.4.1 Application of definitions

Throughout this Standard, the definitions of terms given in Clauses 1.4.2 to 1.4.103 apply.

Where an additional term is defined in a particular section or clause, such a term has the meaning as defined. The definitions apply to both parts of this Standard.

*Exception: Where the context otherwise requires, or the word or term is not specifically defined, the commonly understood meaning shall apply. Where the terms voltage and current are used without further qualification, they imply r.m.s. values.*

#### 1.4.2 Accessible, readily

Capable of being reached quickly and without climbing over or removing obstructions, mounting upon a chair, or using a movable ladder, and in any case not more than 2.0 m above the ground, floor or platform.

#### 1.4.3 Accessory

Any device, such as a switch, fuse, plug, socket-outlet, lampholder, fitting, adaptor or ceiling rose that is associated with wiring, luminaires, switchboards or appliances; but not including the lamps, luminaires, appliances or switchboards themselves.

#### 1.4.4 Active (or active conductor)

Any conductor that is maintained at a difference of potential from the neutral or earthed conductor. In a system that does not include a neutral or earthed conductor, all conductors shall be considered to be active conductors.

#### 1.4.5 Aerial conductor

Any stranded conductor (including aerial bundled conductors) that is supported by insulators or purpose-designed fittings above the ground and is directly exposed to the weather.

Alive (see Clause 1.4.63, Live part).

COPYRIGHT

#### **1.4.6 Appliance**

A consuming device, other than a lamp, in which electricity is converted into heat, motion, or any other form of energy, or is substantially changed in its electrical character.

#### **1.4.7 Appliance, fixed**

An appliance that is fastened to a support or otherwise secured in a specific location.

#### **1.4.8 Appliance, hand-held**

A portable appliance intended to be held in the hand during normal use, the motor, if any, forming an integral part of the appliance.

#### **1.4.9 Appliance, portable**

Either an appliance that is moved while in operation or an appliance that can easily be moved from one place to another while connected to the supply.

#### **1.4.10 Appliance, stationary**

Either a fixed appliance or an appliance having a mass exceeding 18 kg and not provided with a carrying handle.

#### **1.4.11 Area, hazardous**

Area in which an explosive atmosphere is present, or may be expected to be present, in quantities that require special precautions for the construction, installation and use of electrical equipment.

#### **1.4.12 Arm's reach**

A zone extending from any point on a surface where persons usually stand or move about, to the limits that a person can reach with the hand in any direction without assistance, (e.g. tools or ladder) (see Figure 1.1).

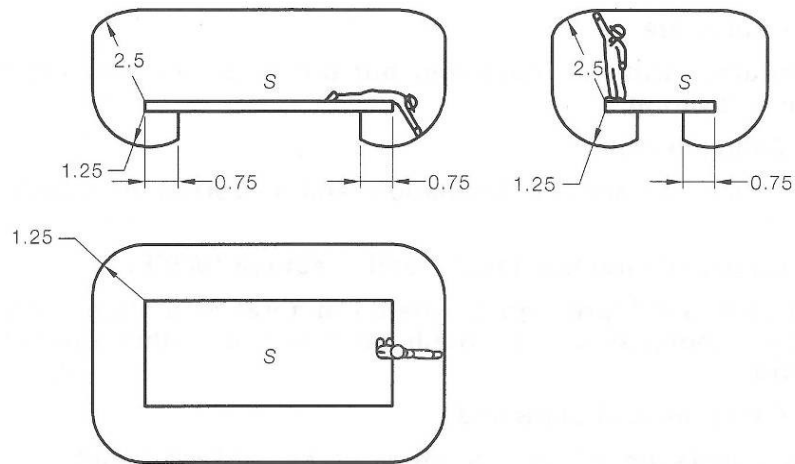

LEGEND:  
S = Surface expected to be occupied by persons

DIMENSIONS IN METRES

FIGURE 1.1 ZONE OF ARM'S REACH

#### 1.4.13 Authority, regulatory

A government agency responsible for relevant legislation and its application.

#### 1.4.14 Authorized person

The person in charge of the premises, or the licensed electrical contractor or electrician or other person appointed or selected by the person in charge of the premises to perform certain duties on the premises.

#### 1.4.15 Available, readily

Capable of being reached for inspection, maintenance or repairs without necessitating the dismantling of structural parts, cupboards, benches or the like.

#### 1.4.16 Barrier

A part providing basic protection from any usual direction of access.

Basic insulation (see Clause 1.4.60, Insulation system).

Basic protection (see Clause 1.4.77, Protection, basic).

#### 1.4.17 Cable

A single cable core, or two or more cable cores laid up together, either with or without fillings, reinforcements, or protective coverings.

#### 1.4.18 Cable, armoured

A cable provided with a wrapping of metal, usually tapes or wires, primarily for the purpose of mechanical protection.

COPYRIGHT

**1.4.19 Cable core**

The conductor with its insulation but not including any mechanical protective covering.

**1.4.20 Cable, flexible**

A cable, the conductors, insulation and covering of which afford flexibility.

**1.4.21 Cable, mineral insulated metal sheathed (MIMS)**

A cable having compressed powdered mineral insulation enclosed in solid-drawn metal sheathing. Such cable may be either single-core or multi-core.

**1.4.22 Cable, neutral-screened**

A cable consisting of one or more cores laid up together with or without fillers, surrounded by a concentric wire outer conductor, further protected with an insulating sheath.

**1.4.23 Cable, sheathed**

A cable having a core or cores surrounded by a sheath.

Cable trunking (see Clause 1.4.97, Trunking, cable).

**1.4.24 Ceiling, suspended**

In accordance with AS/NZS 2785, a suspended ceiling is a ceiling system hung at a distance from the floor or roof above. It does not include a nailed timber ceiling complying with AS/NZS 2589.1 and timber building Standards.

**1.4.25 Circuit**

A circuit comprises live conductors, protective conductors (if any), a protective device and associated switchgear, controlgear and accessories.

**1.4.26 Circuit-breaker**

A switch suitable for opening a circuit automatically, as a result of predetermined conditions, such as those of overcurrent or undervoltage, or by some form of external control.

**1.4.27 Class I equipment**

Equipment in which protection against electric shock does not rely on basic insulation only, but which includes an additional safety precaution in that accessible conductive parts are connected to the protective earthing conductor in the electrical installation in such a way that accessible parts cannot become live in the event of a failure of the basic insulation.

**NOTES:**

- 1 Class I equipment may have parts with double insulation or parts operating at SELV.
- 2 For equipment intended for use with a flexible cord or cable, this provision includes a protective earthing conductor as part of the flexible cord or cable.

#### 1.4.28 Class II equipment

Equipment in which protection against electric shock does not rely on basic insulation only, but in which additional safety precautions, such as double insulation or reinforced insulation, are provided, there being no provision for protective earthing or reliance upon installation conditions. Such equipment may be one of the following types:

- (a) Equipment having durable and substantially continuous enclosures of insulating material that envelope all metal parts, with the exception of small parts, such as nameplates, screws and rivets, that are isolated from live parts by insulation at least equivalent to reinforced insulation. Such equipment is called insulation-encased Class II equipment.
- (b) Equipment having a substantially continuous metal enclosure, in which double insulation is used throughout, except for those parts where reinforced insulation is used, because the application of double insulation is manifestly impracticable. Such equipment is called metal-encased Class II equipment.
- (c) Equipment that is a combination of the types described in Items (a) and (b).

##### NOTES:

- 1 The enclosure of insulation-encased Class II equipment may form part of the whole of the supplementary insulation or of the reinforced insulation.
- 2 If the equipment with double insulation or reinforced insulation throughout has an earthing terminal or earthing contact, it is considered to be of Class I construction.
- 3 Class II equipment may be provided with means for maintaining the continuity of protective circuits, insulated from accessible conductive parts by double insulation or reinforced insulation.
- 4 Class II equipment may have parts operating at SELV.

#### 1.4.29 Class III equipment

Equipment in which protection against electric shock relies on supply at SELV and in which voltages higher than those of SELV are not generated.

NOTE: Equipment intended to be operated at SELV and which has internal circuits that operate at a voltage other than SELV are not included in the classification and are subject to additional requirements.

#### 1.4.30 Competent person

A person, who has acquired, through training, qualification or experience or a combination of these, the knowledge and skill enabling that person to perform the required task correctly.

#### 1.4.31 Conductor

A wire or other form of conducting material suitable for carrying current, but not including wire or other metallic parts directly employed in converting electrical energy into another form.

**1.4.32 Conductor, bare**

A conductor without covering or insulation.

**1.4.33 Consumers mains**

Those conductors between the point of supply and the main switchboard.

**1.4.34 Contact, direct**

Contact with a conductor or conductive part that is live in normal service (see Figure 1.2. and Clause 1.4.77, Protection, basic).

**1.4.35 Contact, indirect**

Contact with a conductive part that is not normally live but has become live under fault conditions (because of insulation failure or some other cause) (see Figure 1.3. and Clause 1.4.78, Protection, fault).

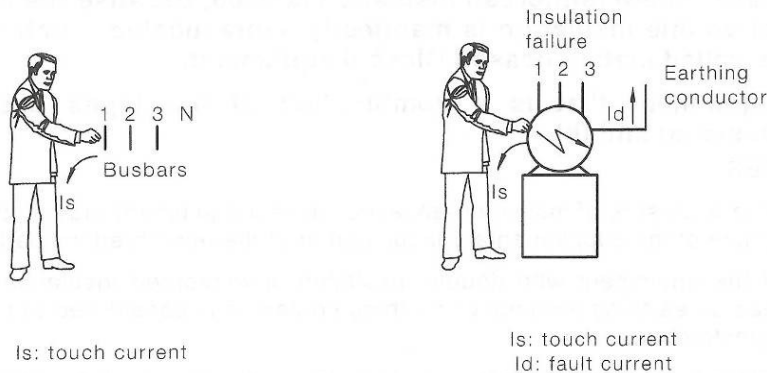

FIGURE 1.2 DIRECT CONTACT

(Basic protection required)

FIGURE 1.3 INDIRECT CONTACT

(Fault protection required)

**1.4.36 Cord, flexible**

A flexible cable, no wire of which exceeds 0.31 mm diameter and no conductor of which exceeds 4 mm<sup>2</sup> cross-sectional area, and having not more than five cores.

**1.4.37 Current, fault**

A current resulting from an insulation failure or from the bridging of insulation.

**1.4.38 Current, overload**

An overcurrent occurring in a circuit that is electrically sound.

#### 1.4.39 Current, short-circuit

**A fault current resulting from a fault of negligible impedance between live conductors having a difference in potential under normal operating conditions. The fault path may include the path from active via earth to the neutral.**

NOTE: This current is also referred to as 'prospective short-circuit current' or a 'bolted fault'. It is the maximum value, at the relevant points for the existing installation. Unless otherwise stated, it is the three-phase r.m.s. value.

#### 1.4.40 Damp situation

**A situation in which moisture is either permanently present, or intermittently present to such an extent as would be likely to impair the effectiveness or safety of an electrical installation that complies with this Standard for ordinary situations.**

**Degree of protection** (see Clause 1.4.61, IP Classification).

**Direct contact** (see Clause 1.4.34, Contact, direct).

#### 1.4.41 Distribution board

A switchboard other than a main switchboard.

**Distributor, electricity** (see Clause 1.4.50, Electricity distributor).

**Domestic electrical installation** (see Clause 1.4.48, Electrical installation, domestic).

**Double insulation** (see Clause 1.4.60, Insulation system).

#### 1.4.42 Duct

**A pipe of 75 mm diameter or greater, or a closed passage formed underground or in any structure and intended to receive one or more cables that may be drawn in.**

#### 1.4.43 Earthed

**Connected to both the supply neutral and the general mass of earth in accordance with the appropriate requirements of this Standard.**

#### 1.4.44 Earthed situation

**A situation wherein there is a reasonable chance of a person touching exposed conductive parts and, at the same time, coming into contact with earth or with any conducting medium that may be in electrical contact with the earth or through which a circuit may be completed to earth. The following situations are deemed to be earthed situations:**

- (a) **Within 2.5 m in any direction from a conductive floor (such as earthen, concrete, tile or brickwork flooring), permanently damp surface, metallic conduit or pipe, metallic cable sheath or armour or any other conductive material on which a person may stand.**



**(b) External to a building**

*Exception: An isolated piece of equipment, such as a luminaire that is mounted more than 2.5 m from the ground and from any exposed conductive part or other conductive material that is in contact with earth, is not deemed to be in an earthed situation.*

**(c) Within 2.5 m of the ground, floor or platform in rooms containing socket-outlets, the earthing terminals of which are earthed, and where there is a reasonable chance of a person making simultaneous contact with any exposed conductive part of electrical equipment and any exposed conductive part of an appliance connected to any of the socket-outlets.****(d) All parts of a bathroom, laundry, lavatory, toilet or kitchen.****1.4.45 Earth fault-loop impedance**

**The impedance of the earth fault-current loop (active-to-earth loop) starting and ending at the point-of-earth fault.**

NOTE: Clause 5.7 provides a description of the constituent parts of an earth fault-current loop.

**Earthing conductor**

(see Clause 1.4.65, Main earthing conductor).

(see Clause 1.4.79, Protective earthing conductor).

**1.4.46 Electrical equipment**

**Wiring systems, switchgear, controlgear, accessories, appliances, luminaires and fittings used for such purposes as generation, conversion, storage, transmission, distribution or utilization of electrical energy.**

**1.4.47 Electrical installation**

**Electrical equipment installed for the purposes of conveyance, control, measurement or use of electricity, where electricity is or is to be supplied for consumption.** It includes electrical equipment supplied from a distributor's system or a private generating system.

**NOTES:**

- 1 An electrical installation usually commences at the point of supply and finishes at a point (in wiring) but does not include portable or stationary electrical equipment connected by plug and socket-outlet (other than where a socket-outlet is used to connect sections of the fixed installation).
- 2 Unless the context otherwise requires, the term 'installation' is used to mean electrical installation.

**1.4.48 Electrical installation, domestic**

**An electrical installation in a private dwelling or that portion of an electrical installation associated solely with a flat or living unit.**

**1.4.49 Electrical installation, multiple**

**An electrical installation incorporating—**

- (a) a number of domestic electrical installations; or
- (b) a number of non-domestic electrical installations; or
- (c) any combination of domestic and non-domestic electrical installations.

**1.4.50 Electricity distributor**

**Any person or organization that provides electricity from an electricity distribution system to one or more electrical installations. Includes distributor, supply authority, network operator, local network service provider, electricity retailer or electricity entity, as may be appropriate in the relevant jurisdiction.**

**1.4.51 Enclosure**

**A part providing an appropriate degree of protection of equipment against external influences and against contact with live parts.**

NOTE: AS 60529 and Appendix G provide further information on appropriate degrees of protection.

**Equipment, electrical** (see Clause 1.4.46, Electrical equipment).

**Equipment wiring** (see Clause 1.4.101, Wiring, equipment).

**1.4.52 Equipotential bonding**

**Electrical connections intended to bring exposed conductive parts or extraneous conductive parts to the same or approximately the same potential, but not intended to carry current in normal service.**

**1.4.53 Exposed conductive part**

**A conductive part of electrical equipment that—**

- (a) can be touched with the standard test finger as specified in AS/NZS 3100; and
- (b) is not a live part but can become live if basic insulation fails.

*Exception: The term exposed conductive part does not apply to the following:*

- (i) *Conductive parts within an enclosure where the parts cannot be touched unless a key or a tool is required to remove the covers of the enclosure.*
- (ii) *Conductive parts within electrical equipment where the parts cannot be touched in normal use and movement of the electrical equipment, because of its configuration and size.*
- (iii) *Conductive parts that are effectively and permanently separated from live parts by—*
  - (A) *double insulation; or*
  - (B) *other conductive parts that are earthed.*

- (iv) *Conductive parts that are in the form of nameplates, screw heads, covers and similar attachments that cannot become live in the event of failure of insulation of live parts because of the manner in which they are supported and fixed.*
- A1 | (v) *A removable or hinged conductive panel fitted to a switchboard or other enclosure containing conductors that are so located and/or restrained that, in the event of any conductor becoming detached from a terminal or mounting, the conductor is incapable of making contact with the panel.*

#### **1.4.54 Extraneous conductive part**

**A conductive part that does not form part of an electrical installation but that may be at the electrical potential of a local earth.**

NOTE: Examples of extraneous conductive parts include the following—

- (a) metal waste, water or gas pipe from outside.
- (b) cooling or heating system parts.
- (c) metal or reinforced concrete building components.
- (d) steel-framed structure.
- (e) floors and walls of reinforced concrete without further surface treatment.
- (f) tiled surfaces, conductive wall coverings.
- (g) conductive fittings in washrooms, bathrooms, lavatories, toilets, etc.
- (h) metallized papers.

**Fault current** (see Clause 1.4.37, Current, fault).

**Fault protection** (see Clause 1.4.78, Protection, fault).

#### **1.4.55 Fault-current limiter**

**A circuit-opening device designed or selected to limit the instantaneous fault current.**

**Final subcircuit** (see Clause 1.4.88, Subcircuit, final).

**Flexible cord** (see Clause 1.4.36, Cord, flexible).

#### **1.4.56 Functional earthing (FE)**

**An earthing arrangement provided to ensure correct operation of electrical equipment or to permit reliable and proper functioning of electrical installations.**

NOTE: 'Clean' (low-noise) earths provided for electrical equipment may be considered as FE. Clause 5.2.2 provides further information on FE.

#### **1.4.57 Fuse**

**A device for protecting a circuit against damage from an excessive current flowing in it by opening the circuit on the melting of the fuse-element by such excessive current. The fuse comprises all the parts that form the protective device.**

**Hazardous areas** (see Clause 1.4.11, Area, hazardous).

**Indirect contact** (see Clause 1.4.35, Contact, indirect).

#### 1.4.58 Installation coupler

A connecting device, in accordance with AS/NZS 61535, consisting of an installation socket and an installation plug designed for permanent connection and not intended to be engaged or disengaged under load (see also Clause 4.3.2.2).

**Installation, electrical** (see Clause 1.4.47, Electrical installation).

**Installation wiring** (see Clause 1.4.102, Wiring, installation).

#### 1.4.59 Insulated

Separated from adjacent conducting material by a non-conducting substance or airspace permanently providing resistance to the passage of current, or to disruptive discharges through or over the surface of the substance or space, to obviate danger of shock or injurious leakage of current.

#### 1.4.60 Insulation system

NOTE: The term 'insulation system' does not imply that the insulation must be one homogenous piece. It may comprise several layers that cannot be tested separately as supplementary or basic insulation.

One, or a combination of, the following:

- (a) **Basic insulation**—The insulation applied to live parts, to provide basic protection against electric shock.

NOTE: Basic insulation does not necessarily include insulation used exclusively for functional purposes.

- (b) **Supplementary insulation**—An independent insulation applied in addition to basic insulation in order to ensure protection against electric shock in the event of a failure of the basic insulation.

- (c) **Double insulation**—Insulation comprising both basic insulation and supplementary insulation.

NOTE: Sheathed cables in accordance with the AS/NZS 5000 series, sheathed flexible cords in accordance with AS/NZS 3191 other than the 'light duty' type, and sheathed neutral-screened cables in accordance with AS/NZS 4961 are deemed to provide double insulation between the conductors of the cable and any conductive material in contact with the cable. The use of flexible cords of the 'light duty' type as supply flexible cords is covered in equipment Standards.

- (d) **Reinforced insulation**—A single insulation system applied to live parts that provides a degree of protection against electric shock, equivalent to double insulation under conditions specified in AS/NZS 3100.

NOTE: Aerial bundled cables in accordance with AS/NZS 3560 are deemed to provide reinforced insulation.

#### 1.4.61 International protection (IP) Classification

**A degree of protection in accordance with AS 60529.**

NOTE: Further information is provided in Appendix G.

#### 1.4.62 Isolation (isolating function)

**Function intended to cut off the supply from the whole installation, or a discrete section of it, by separating it from every source of electrical energy for reasons of safety.**

Lighting fitting (see Clause 1.4.64, Luminaire).

#### 1.4.63 Live part

**A conductor or conductive part intended to be energized in normal use, including a neutral conductor and conductive parts connected to a neutral conductor.**

NOTE: Under the multiple earthed neutral (MEN) earthing system this term does not apply to the following:

- (a) Earthing conductors.
- (b) The MEN connection and the neutral bar or link at which the MEN connection is made.
- A1 | (c) The neutral bar or link in a switchboard without an MEN connection where the active supply to the switchboard has been isolated.
- (d) The sheath of an MIMS cable and associated conductive fittings used as a combined protective earthing and neutral (PEN) conductor in an earth sheath return (ESR) system.
- (e) Conductive supports and enclosures associated with an unprotected consumers mains that are earthed in accordance with Clause 5.5.3.5.

#### 1.4.64 Luminaire (lighting fitting)

**A complete lighting assembly intended to distribute, filter, or transform the light from one or more lamps, together with such components as ancillary and auxiliary equipment, shades, diffusers, reflectors, and accessories.** Such an assembly includes the means of connection to supply circuit wiring, internal and interconnecting wiring, and any associated housings. A lampholder that is not incorporated in an assembly is not regarded as a luminaire.

#### 1.4.65 Main earthing conductor

A1 | **A conductor connecting the main earthing terminal/connection or bar to the earth electrode or to the earthing system of the source of supply.**

**1.4.66 Multiple earthed neutral (MEN) system**

A system of earthing in which the parts of an electrical installation required to be earthed in accordance with this Standard are connected together to form an equipotentially bonded network and this network is connected to both the neutral conductor of the supply system and the general mass of earth.

**Multiple electrical installation** (see Clause 1.4.49, Electrical installation, multiple).

**1.4.67 Neutral (neutral conductor or mid-wire)**

The conductor of a three-wire or multi-wire system that is maintained at an intermediate and approximately uniform potential in respect of the active or outer conductors, or the conductor of a two-wire system that is connected to earth at its origin.

**Neutral-screened cable** (see Clause 1.4.22, Cable, neutral-screened).

**1.4.68 Obstacle**

A part preventing unintentional direct contact, but not preventing direct contact by deliberate action.

**1.4.69 Outbuilding**

A structure completely separated by an area of land from another structure containing the switchboard from which supply is obtained.

**1.4.70 Overcurrent**

A current exceeding the rated value.

NOTE: For conductors, the rated value is the current-carrying capacity.

**Overload current** (see Clause 1.4.38, Current, overload).

**1.4.71 Plug**

A device intended for insertion into a socket-outlet, cord-extension socket or plug-socket adaptor to make a detachable connection between the contacts of any such accessory and the conductors of a flexible cord or flexible cable.

**1.4.72 Point (in wiring)**

A termination of installation wiring, intended for the connection of current using equipment.

**1.4.73 Point of attachment**

The point at which aerial conductors of a service line or aerial consumers mains are terminated on a consumer's structure.

**1.4.74 Point of entry**

The point at which the consumers mains or the underground service cable enters a structure.

**1.4.75 Point of supply**

The junction of the consumers mains with—

- (a) conductors of an electricity distribution system; or
- (b) output terminals of an electricity generating system within the premises.

**1.4.76 Protected extra-low voltage (PELV)**

An extra-low voltage system that is not electrically separated from earth, but that otherwise satisfies all the requirements for SELV.

**1.4.77 Protection, basic**

Protection against dangers that may arise from direct contact with live parts of the installation (see Figure 1.2 and Clause 1.4.34, Contact, direct).

**1.4.78 Protection, fault**

Protection against dangers that may arise from indirect contact with live parts of the installation (contact with an exposed conductive part that is not normally live but has become live under fault conditions) (see Figure 1.3 and Clause 1.4.35, Contact, indirect).

**1.4.79 Protective earthing conductor**

A conductor, other than a main earthing conductor, connecting any portion of the earthing system to the portion of the electrical installation or electrical equipment required to be earthed, or to any other portion of the earthing system.

RCD (see Clause 1.4.80, Residual current device).

Readily accessible (see Clause 1.4.2, Accessible, readily).

Readily available (see Clause 1.4.15, Available, readily).

Regulatory authority (see Clause 1.4.13, Authority, regulatory).

Reinforced insulation (see Clause 1.4.60, Insulation system).

**1.4.80 Residual current device (RCD)**

A device intended to isolate supply to protected circuits, socket-outlets or electrical equipment in the event of a current flow to earth that exceeds a predetermined value.

**1.4.81 Ripple-free d.c.**

For sinusoidal ripple voltage, a ripple content not exceeding 10% r.m.s.

NOTE: The maximum peak value does not exceed 140 V for a nominal 120 V ripple-free d.c. system and 70 V for a nominal 60 V ripple-free d.c. system.

#### **1.4.82 Safety service**

**A system or component that operates to identify an emergency, or is intended to operate during an emergency, and is primarily associated with—**

- (a) the safety of persons evacuating a building; or**
- (b) fire-fighting operations; or**
- (c) fire suppression.**

NOTE: Examples of safety services are given in Clause 7.2.

#### **1.4.83 Separated extra-low voltage (SELV )**

**An extra-low voltage system that is electrically separated from earth and from other systems in such a way that a single fault cannot give rise to the risk of electric shock.**

#### **1.4.84 Service protective device**

**A fuse, circuit-breaker or other device installed as required by the electricity distributor for interrupting the supply to an electrical installation on a consumers premises from the supply main.**

**Short-circuit current** (see Clause 1.4.39, Current, short-circuit).

#### **1.4.85 Socket, cord-extension**

**A device, arranged for attachment to a flexible cord, having contacts whereby a detachable connection may be made with the pins of a plug.**

#### **1.4.86 Socket-outlet**

**A device for fixing or suspension at a point, and having contacts intended for making a detachable connection with the contacts of a plug. The term 'socket-outlet' is deemed to include a cord-extension socket attached to a flexible cord that is permanently connected to installation wiring.**

#### **1.4.87 Source of supply**

**Where used in relation to any electrical installation, the generator, converter, transformer, etc., or group of generators, converters, or transformers, to which the supply mains conveying electricity to that particular electrical installation are connected and that generates, converts, or transforms the electrical energy so supplied to that electrical installation.**

#### **1.4.88 Subcircuit, final**

**A circuit originating at a switchboard and to which only consuming devices or points will be connected.** The origin of a final subcircuit is deemed to be at the connecting devices of the neutral bar or link or at the load terminals of the circuit protective devices provided within or on a switchboard specifically for the connection of the circuit. The termination of a final subcircuit is deemed to be at the supply terminals of consuming devices or points.



#### **1.4.89 Submains**

**A circuit originating at a switchboard to supply another switchboard.**  
The origin of the submains is deemed to be at the connecting devices of the neutral bar or link or at the load terminals of the circuit protective devices provided within or on a switchboard specifically for the connection of the submains. The termination of the submains is deemed to be at the supply terminals of the other switchboard.

#### **1.4.90 Substation**

**An assembly of electrical equipment at one place, including any necessary housing, for the conversion or transformation of electric energy or for connection between two or more circuits.**

NOTE: Measurement transformers and protection transformers are not considered to be transformers for the purpose of this Standard.

**Supplementary insulation** (see Clause 1.4.60, Insulation system).

**Suspended ceiling** (see Clause 1.4.24, Ceiling, suspended).

#### **1.4.91 Switchboard**

**An assembly of circuit protective devices, with or without switchgear, instruments or connecting devices, suitably arranged and mounted for distribution to, and protection of, one or more submains or final subcircuits or a combination of both.**

#### **1.4.92 Switchboard, main**

**A switchboard from which the supply to the whole electrical installation can be controlled.**

#### **1.4.93 Switchgear**

**Equipment for controlling the distribution of electrical energy, or for controlling or protecting circuits, machines, transformers, or other equipment.**

#### **1.4.94 Touch current**

**Electric current that passes through a human body, or an animal body, when that body touches one or more accessible parts of electrical equipment or an electrical installation, under normal conditions or fault conditions.**

#### **1.4.95 Touch voltage**

**Voltage appearing between simultaneously accessible parts.**

NOTES:

- 1 This term is used only in connection with fault protection.
- 2 In certain cases the value of the touch voltage may be appreciably influenced by the impedance of the person or livestock in contact with these parts.

**1.4.96 Track system**

**A system of enclosed wiring comprising conductors spaced apart by, or supported on, insulating material within a channel and having plug-in facilities along its length.**

*Exception: This definition does not apply to busbar trunking systems (busways) complying with AS/NZS 3439.2.*

**1.4.97 Trunking, cable**

**A trunk or trough for housing and protecting electrical cables and conductors.**

**1.4.98 Voltage**

**Differences of potential normally existing between conductors and between conductors and earth as follows:**

- (a) Extra-low voltage: Not exceeding 50 V a.c. or 120 V ripple-free d.c.**
- (b) Low voltage: Exceeding extra-low voltage, but not exceeding 1 000 V a.c. or 1 500 V d.c.**
- (c) High voltage: Exceeding low voltage.**

**1.4.99 Wiring, catenary**

**A system of wiring consisting of a cable or cables attached at intervals to a suitable support that is suspended between two points.**

**1.4.100 Wiring enclosure**

**A pipe, tube, duct, conduit or cable trunking, fixed or supported in position in accordance with the appropriate requirements of this Standard, for the housing or protection of sheathed or unsheathed cables.**

**1.4.101 Wiring, equipment**

**All wiring of an appliance or item of electrical equipment, provided with supply terminals for the purpose of connection to an electrical installation.**

**1.4.102 Wiring, installation**

**A system of wiring in which cables are fixed or supported in position in accordance with the appropriate requirements of this Standard.**

**1.4.103 Wiring, underground**

**A system of installation wiring in which cables are buried in soil, either directly or in a wiring enclosure beneath the surface of the ground in accordance with the appropriate requirements of this Standard.**

## **APPENDIX C: OTHER TERMS DEFINED NOT INCLUDED IN APPENDIX B**

### **Meter Box**

The main box the wires coming into the house are connected too. From the Meter Box, a number of circuits branch out through the house for different purposes. This allows the electricity to run throughout the house. The Meter Box also contains switches to electrically isolate the whole house or parts of it.

(See Clause 1.4.25, Circuit)

### **Transformers**

An electrical device used to raise or lower the voltage of alternating current. For instance, power is transported over long distances in high voltage power lines and then transformers lower the voltage so that the power can be used by household appliances.

(See Clause 1.4.98, Voltage)

### **Ground Fault Circuit Interrupter (GFI)**

A device intended for the protection of personnel that functions to de-energize a circuit or portion thereof within an established period of time when a current to ground exceeds some predetermined value that is less than that required to operate the over current protective device of the supply circuit

(See Clause 1.4.25, Circuit)

(See Clause 1.4.70, Over current)

(See Clause 1.4.80, Residual current device)

### **Arc-Fault Circuit Interrupter (AFCI)**

A device intended to mitigate the effects of arcing faults by functioning to de-energize the circuit when an arc-fault is detected.

(See Clause 1.4.25, Circuit)

(See Clause 1.4.37, Current, Fault)

## APPENDIX D: TRANSCRIPTION OF CONFERENCE CALL WITH JARROD EDWARDS AND JEFF WATT

3 February 2010, 1:00 PM (GMT+10:00)

Jarrold: Good afternoon, Jarrod Edwards, Metropolitan Fire Brigade, Melbourne.

Hal: Hi, we are the students from WPI working on the Metropolitan Fire Brigade Project.

Jarrold: Fantastic, the phone in this meeting room doesn't ring too often so we anticipated that it was you and you had the right number. (Laughter) Bear with me for a moment and I will put you on speaker phone.

Hal: OK

Jarrold: You still there?

Hal: Yes.

Jarrold: Alright, I'll just skip to the volume here. How's that?

Hal: Sounds good.

Jarrold: Fantastic. Oh, wait, I have Jeff Watt here. Jeff Watts is a research and data analyst with which you have been communicating via email. Between the two of us we hope we can introduce ourselves, introduce the MFB, introduce the project and give you the best ground you need to get the thing rolling.

Hal: Perfect.

Jeff: Hi

Danny: Hi

Jeff: I am Jeff

Hal: Nice to meet you.

Jeff: I don't know, all Australians sound the same with our accent but, yeah.

Jarrold: Before we get the niceties over with, first of all, how many of you have been to Australia before?

Hal: No we have not.

Jarrold: Well that's good so we can fill your heads full of false information (laughter).

Jeff: Just make sure you bring saddles because you'll be riding kangaroos. That's how we get around here.

Rick: Ah, nice.

Hal: That sounds good to us. We're looking forward to it.

Jarrold: To start with, how long have you guys got this afternoon or is it evening or morning for you.

Hal: It's, a, 9 pm right now.

Jarrold: Ok so we got about half an hour or 30 minutes of time.

Hal: Yes

Jarrold: I am not sure how much background you have been provided about the MFB or the area in which you will be working from Holly, or from your professors or advisors. Have you been given much background or have you had much opportunity to look on our web site etc.

Hal: I, yes, we've had a chance to look at your website and, a, did some research, um, on what MFB does but we would love to hear a little bit more about it.

Jarrold: Fantastic, I will a talk for a little bit and we will let you do some talking and introduce yourselves to Jeff and me and, a, then we can talk a little bit about the project. How's that sound?

Hal: Sounds great.

Jarrold: Ok, well a, the area where Jeff and I work, we are not operational, so were not fire fighters we are technical and professional in background. The team consists of 10, 9, sorry of the 9, 7 have engineering backgrounds. We also have, Jeff who is, has a background in research and science, and we also have a person who is an expert, if you like, in doing law and the laws that are such as we fire protection in buildings they design, construction, and approval.

Hal: OK

Jarrold: The principle role of our department is to provide technical advice to the chief fire officer who has the responsibility under building legislation and dangerous goods or hazardous materials legislation in relation to fire safety equipment and installed fire protection systems for new and existing premises. That's our role, the majority of the departments we work with are staffed with operational fire fighters who are for various reasons working in an office environment for a period of time and I, a, delegate on behalf of the chief fire officer and I act on his behalf in fulfilling the functions in law. We also get involved in various aspects of research and investigation for matters that arise and the project you are embarking on is a very good example of that. Jeff who no doubt will do a bit more talking before this meetings out, is principally the person within our work area who analyses the statistics that are collected by operational fire fighters and those statistics are analysed with the outcome utilized for anything from recording on our performance as a fire fighting organization right through to giving advice to external state holders, other government departments who have an interest on emerging fire trends or historical events that would influence their changes in relation to the way they manage fire protection.

Hal: OK

Jarrold: Jeff you want to give a little bit of background of bit. Jeff is relatively one on the newer members of my team having been with us for 3 years?

Jeff: 4, almost 3.

Jarrold: Jeff is not an engineer by background where the majority of us are. It is probably worth getting his perspective on what he thinks that we do.

Jeff: Yeah, well, basically from what my position, where I see what happens with our particular department, a lot of it is to do with, when, a developer is building a new building whether it be a residential or a commercial building and um, there is changes made to the various fire safety regulations, um, the (theory?)(?) what an architect might want to house built, ( ?) kind of a building so think it might look crazy or look bad, a, so there's various developments that come in fix it fire fighters and the inconvenience of that coming up with a alternative solutions to still provide the same level of fire protection but not necessarily following the regulations. There's a lot of that that happens and so there's a lot of, a, what's the word I'm looking for, a, um, to and fro negotiations between, you know, the two interested parties. There's also a lot of researching into different American technologies, things like cogeneration plans. Other things escape my mind at the moment, but, a, any that is new or unusual that needs to be looked at coming into various building and all that kind of stuff and there's no real sort of necessarily data of what the fire safety this new equipment that introduced into the various buildings. That's my sort of summary of the department. Would you agree with that Jarrod?

Jarrod: Did that make sense guys?

Hal: Yes, it did. It helped out a lot.

Jarrod: And if at any stage were talking too fast for you please let us know.

Hal: OK, We can understand you just fine.

Jarrod: Can you tell us some about yourselves, pointing out for us what each of you are studying, what your major is, perhaps what you hope to get out of your time in Australia, and then a very successful academic outcome.

Hal: A, well, I'll start off, my name is Hal Reeder, um, I'm studying civil engineering with a concentration in structural engineering. Um, I also play football here for the school, and a, I I'm just looking forward to getting to Australia and learning about your culture and um, seeing things, in a having just a great overall experience with the time I am over there.

What position do you play?

I play on the defensive line, nose guard and D tackle.

Jeff: You're a big guy. Well, ok.

Hal: I'm sure the footy games aren't that much different.

Jarrod: Yeah, well, we have to make sure to get you through a few Australian rules football games because to see them will have commenced by the time you arrive. As a defensive tackle I'm assuming you're quite a quick agile mobile athlete.

Hal: I try.

Jarrod: All right, who's next?

Danny: Hi I'm Daniel Distler, I am a mechanical engineering major. Um, I am on the ice hockey team here at WPI. A, I'm really looking forward to experiencing the culture over there, it seems really interesting and also I would like to get in a lot of surfing if possible. I live on

Long Island, which I am not sure if you know the States at all but it's an island with pretty good surf so I'm excited about that and just generally checking out the scenery.

Jarro: That's very good. Long Island, that's a dense woods, NY from Boston am I right?

Danny: It's in NY, it's just south of Boston about, a, I don't know, like, a 3 hour drive south.

Jarro: Is Long Island the location of the notorious station night club fire, 100 fatalities, is that on Long Island?

Danny: Oh, no. That's in Rhode Island. That's close.

Jarro: Oh Rhode Island there you go, its close.

Jeff: He's Tasmanian so...

Jarro: Just on that menu, from surfing to ice hockey... explain that one?

Danny: I like everything, I don't know. Um, well I just grew up playing ice hockey and I don't know I later got into surfing throughout high school and then I got into ocean lifeguarding and I like the beach and I like playing hockey. I don't know, they don't really mesh I guess but...(laughter)

Jarro: Very good. Thank you.

Zach: Hi, I'm, a, Zack Taillefer, and um an aerospace engineering student here at WPI. I am also on the hockey team with Danny and, a, I am just really looking forward to, a, being a typical tourist in Australia. This will be, a, my first time studying abroad, and leaving the country so I'm just ready to, a, take in the scenery, visit the Great Barrier Reef, and a, anything else I can possibly visit while I'm there.

Jarro: The Great Barrier Reef is a bit of a walk from where we are, do you mind if you take a, a bit of a trip up north at some stage while you're here before or after you're time. I 'm sure you can still see those things. Richard, last.

Rick: My name is Richard Emberley, you can call me Rick, It's a little shorter and easier, um I 'm a, my major is structural and fire protection engineering. Um, let's see, since we're doing a lot of sports, I like to run and swim. I do a lot of running so I am looking forward to getting out and checking out the scenery like the guys said, um, and I am really looking forward to getting to the Great Barrier Reef and maybe doing some dives and, a, overall experiencing Australian culture.

Jarro: Well, a, we certainly do our best to get you exposed to as many of those things as possible. The group that we work here with, the extended work area with the other departments are all a very outgoing bunch of people, as you can imagine, fire fighters generally have a very outgoing and very loud personality so just want you to know that the fit is going to be really well. We look forward to having you here as well as contributing to a great academic success. We hope that we can help you enjoy your time here in Australia. Alright good, we've got most of our things covered, there aren't too many ice rinks in Melbourne, we haven't done too much skating in a while but we can certainly do surfing, Australian football, and we can throw a shrimp on the barby for ya.

Hal: Great, great, we are really looking forward to it.

Jarro: I don't know, we haven't had shrimps on the barby for the others it's a really weird thing.

Jeff: We don't drink Fosters either.

Zach: Oh man.

Jarrold: I guess you have a bit of discussion about the project. I mention that you've commenced your background work, your preparation of your brief, your project brief, anything given to giving us an indication at what stage, a, do think you might have a brief eval., so we, we, would certainly like to have some input into that not merely to, to, make sure that your on the right track and you got as much information and feel confident about commencing on the project when you arrive.

Hal: Ah, yes, we have started some, research and started our background, a, we were hoping you could just briefly, a, give us a run down about the project and what you are looking for within the project. Um,

Jarrold: Sure we can do that. It's interesting how this has come about. I've as Jeff to facilitate a project manage if you like, a, you got a project team and, and he'll be your main contact during your time with us.

Jeff: Yeah, good luck with that.

Jarrold: So this project stems from an extensive data analysis that Jeff undertook on behalf of our organization about 18 months ago, a year and a half ago, and, a, what we were trying to do was explore occurrences of fire in different categories of buildings and try to identify what the key trend and things were going forward to see whether there was any way we in which we could improve for safety for the community of Melbourne and Victoria. One of the areas that was identified as increasing, was fires in homes, in residential homes, despite the significant asset that we that we place into education and instruction guidance behind those trying to minimize their chances of being exposed to fire. But on the same front, we also realize that the most under regulated building that exists in our regulatory environment is the house, the home. A concept that a home is a castle and no one else should really have any input into how you should go about managing your home. One of the areas that we got into fires an increasing or emerging trend in fire occurrences was that of electrical installation. This quite often trends and things in fire evolving particular appliances or particular activities but what was emerging appeared to be associated with the internal wiring or fires originating from within the walls or within the structure of buildings which suggested to me that it was beyond a short circuiting or failure of an individual appliance. Jeff rightly pointed out that if we look back at the use of electricity in the home over the last 30 or 40 years we've gone from homes maybe having a blender or food processor, 1 TV and a radio, and a refrigerator, now in Melbourne, now we have central heating that can be electric, we have air conditioning cooling which is electric, multiple fridge refrigeration units. Most homes have 2 or 3 large flat screen power hungry TV's. Every bedroom has computers, most homes have multiple microwave ovens so the demand of power has increased dramatically yet the wiring in homes that are 20, 30 or 40 years old have not been required to undertake any upgrade or improvement. The legislative regime we have in Victoria doesn't give any requirement to inspect or



upgrade any element of a home's electrical network or circuitry unless you are doing some upgrades on the electrical circuit itself. My thoughts and not trying to bias the outcomes would be that we would be at investigating our data to identify how our hypothesis has been true and then perhaps influence a change in legislation that might suggest as people change homes or as a lease has expired on a rental property that there is compulsory upgrade on circuit boards or circuit breakers from analog fuses to electrical circuit breakers. But again, I don't want to bias the outcome but that is where my thinking is where we might get to. Jeff, I don't know if you?

Jeff: No not really. A lot of the data I am actually working on 2009 reports residential and eventually I will get by the time you get here I might have finished a few other types of buildings in the district. I am not far along on the 2009 report which looks at residential properties and amount of fires that occur there. Now I know that you have stats already from this year and also previous couple years compared to a ten year average that electrical issues are on the rise and have been over the last few years and also which sort of goes hand in hand with fires which starting in the structure of the house as opposed to inside the house. Obviously still the most common fire here in Melbourne is cooking left unattended. I will keep the number 2 and the number 3 (?) are electrical issues and also part breakings which come with not being maintained and also like Jarrod said increased electricity demand that we had we with a electrical distribution system had factored 30 or 40 years ago. So the data I've got from Melbourne is definitely suggesting that it is an increasing problem and my stuff that I've done already in whole there's a lot more left we can do with that data as far as looking at individual incidents and also breaking down like your electrical incidents and seeing what kind of equipment caused and also saving some fire fighters particularly now FIA who go to a lot of these fires after the fact and see the causes and a lot of that stuff, so there is a lot of quality information we can probably look into as well.

Jarrod: That's a bit of background. Now, let's briefly talk guys about the deliverables that I'm looking for and a bit about the methodology we tend to support that we'll provide here. The back ground in which by now would come about identifying this project. Is there any questions you have or does that make sense, or did we give you too much too soon?

Hal: Ah, no, that helped out a lot. So far, we've came out with a few objectives of what we, a, just heard from speaking with you. Um, basically what we have now is that we're going to be looking at, a, electricity demands and the usage of appliances so really look at the appliances and what has changed. Um, also the legislation that's, you know, over there now and what could be implemented in other areas. And then, um, I guess, this would be more when we get over there, but, just the fire incident data from over there, hopefully we can, a, research a little bit now and then hopefully when we get over there, you know, try to figure out trends and what is actually causing these fires. Um, but you have here

you wanted the years of 1960, 1980 and current. We were just wondering do you want those specific years, or just in those time periods.

Jarrold: Those time periods are just numbers and I will give you my rationale behind those numbers and you can reinspect, um my theory was, around the 60's was time when television became prevalent in people's homes so the increase of electrical demand probably had a jump around the 60's. In the 80's it was probably the prevalence of home personal computers in homes, introduction of video game consoles, a shift into larger televisions and then in more recent years we have had an increase in the cost associated with installing what we call split system air conditioning systems, which as we get, and our climate becomes warmer people will want to be cooler and more comfortable at home and the cost of installing those very power hungry units is now in every, our guess is, 6 in every 10 homes now has a quite a large air conditioning system within the home. So, 60's, 80's and current are just ballpark areas so I'm not specifically focused on those years but if you can consider those as eras and perhaps give some thought as you go about what might be the triggers to identifying those key stages in advancements in electrical appliance usage in the home.

Hal: OK

Jarrold: Well, that's just a little bit about your project; I'll talk about your deliverables last. A little bit about the approach, um, what we like to do is provide you with team, a steering committee if you'd like, to bounce ideas. Now my experience with the IQP project is that right?

Hal: Yes

Jarrold: My experience is that your supervisors will want to have weekly or for nightly meetings while you're here just to discuss progress in our presence which is more about you and making sure you're able to deliver the best outcome to get you the best grade you can achieve but recognizing that we are looking and interested in as well your well being and your academic outcomes we're interested in the outcome of the research so I'm having to put together a saying which will include obviously yourselves, it will include Jeff and myself, but it will also include about 5 or 10 of the offices within the MFB. We'll also give it to include key staff from the other fire service that operates within the state of Victoria and that is the Country Fire Authority as well as the government agency that's responsible for the safe use of energy both natural gas and electricity which is Energy Safe Victoria so we will be sending invites to them. I don't say the makings with that cause theory committee if you like occurring as frequently as will occur with your supervisors but to give you the opportunity every 2 or 3 weeks to bounce ideas off of perhaps that collective knowledge to point you in the right direction or identify a contact where we might have come across a gap in some information of data or see the opportunity. How does that sound to you guys?

Hal: Yeah, That'd be a great help.

Jarrold: OK, alright. Well, so just the last point I'd like to talk about is the deliverables that we're hoping to get and to really summarize briefly before the objectives. You did a great job on starting to pick up on most of the deliverables, what I say, to give you some background on what I'm having to do with the document is to use it as a tool to present to other government agencies and people in public office that are responsible for safety in the community and to paint a picture for them as to why we are focused on perhaps upgrading or improving the electrical systems within homes so I'd immediately start with having a summary of how there's been significant step changes in the positive electrical groups within homes and in parallel to that provide a summary of what the electrical safety installation of quality should be in Victoria for those corresponding periods. So, there while imagining, we are painting a picture of what the paramount were at the time, what the legislation requires in terms of the capacity of the homes electrical system at the time, so then straightaway, we can paint a picture if you built your house in 1960 and you're now running the number of appliances that we commonly do in 2010, that there is a significant increase in the demand. Literature review of what any other legislative regimes' around the world are doing in relation to requiring existing buildings to undertake upgrades on a mandatory basis and also, as Jeff talked about, to look at the fire data we have here over the last 5 or 10 year period. Now unfortunately, once we start pushing beyond 10-15 years, our data set starts to become quite scratchy.

Jeff: The 80s is basically where I trust the data, any before that gets a little bit sort of, yeah....

Jarrold: That's sort of the background, those 4 courts, I would say they're not easy but they're relatively straight forward and they're just fact finding from then on it becomes interesting and we'd love to make use of your analytical minds, with our assistance, to try to identify if there is any correlation between any crazy power consumption, ages of property, and ultimately a link between power and fire.

Hal: Right

Jarrold: The greatest hurdle that we might stumble across in the data that we record that the bar officers collect from attending incidents given the specifics to identify the age of the property. However we do have other mechanisms within the organization where we are able to identify the owners or the occupiers of homes that have been subject to fire and we may have an ability to identify ages of buildings that have been involved with fire. That's probably our biggest hurdle; we'll continue to give it some thought as to how we are to overcome that. Unfortunately, I don't know if this is an Australian term or not, it's just a bit of suck it and see. We don't quite know how difficult it will be until you really start getting your hands dirty, so but we'll make sure we work with you to facilitate that. The final aspect is to deliver a report which gives us conclusions as to whether there is or isn't a link between electrical use, or an increase in the electrical demand and fires, and whether there are any options in how we might go about improving the scenario or the environment here in Victoria through legislative change. Probably that is an ambitious target to achieve within the 6-7 weeks which you are here with us and the period of

preparation while you are remaining in the US but I will be a little bit biased and will say that projects that we have provided for the WPI IQP program in the past, I think have been some of the most valuable to our organization and the community. Many of the other project sites here, maybe I'm a bit biased, to me they look a bit simplistic and not necessarily having a great deal of material value to the community or the society in which we operate in so hopefully your efforts with our support to deliver a good outcome which will see let's take a look at the side of Victoria here in Australia subject to fire associated power in the future.

Hal: Ah, yeah. I agree and we're really looking forward to working this project with you guys and MFB.

Jarrold: Fantastic. Well alright before I move on any questions on any of the items we've spoken about.

Hal: Yes, when you speak about legislation within Victoria and international legislation, um, what actually do you mean by that? Are you talking about specific codes and standards for appliances and usage? Or we've done a little bit of research and uh, I might be wrong on this, but there's really 2 types of safety standards you have performance based design and prescriptive design? Is that correct? So, I guess what I'm really asking is do you want us focusing on those two implementations or are you focusing more on the actual codes and what goes into the appliances and installations?

Jarrold: Our thinking is to focus specifics on codes and standards and not so much appliances but more the installations within the homes, to give you an example.

Jeff: The electrical distribution system of a home as opposed, appliances yes, there are some appliances that are more dangerous than others, however, yea more so the distribution throughout the house of the electricity through the wiring and all the power transfer equipment and all that kind of stuff. Isn't that right Jarrold?

Jarrold: Yeah, it would have been great if one of you were majoring in electrical engineering but what I am interested in the compounding effect if the wire in which you analyse power distribution the voltage is not cumulative but the amperage is so I'm imagining that an existing home might be built 30 years ago in the anticipation that the maximum demand of cumulative power would be 10 or 12 amps whereas the reality is now it is probably about 50. We'll focus on the codes and standards that would specify the size of the wire or the size of the part if you like that the house is, its maximum load capacity.

Hal: Right. OK. Thank you, that helps us a lot. Do you guys have any other questions you can think of?

Jarrold: Other questions?

Danny: Yeah, I am curious, when you say in the past 5 or 10 years you have sufficient amount of fire incident data, what type of data do you actually have, what information will we be looking at?

Jeff: On all my 2009 residential reports I will have finished within the next week or so, I can send that to you guys you can have a bit of a look through it. It's about all fires in

residential properties not just electrical wiring that might give you a hand but the common data, there is a lot of data you can get but the common data that I focused on in my report are things like area of fire origin, ignition factor for the fire, cost of equipment involved in the fire, and also former head ignition. Former head ignition is sort of more associated with things like cigarette butts and maybe equipment aiding in setting fires, sitting too close to it, um, those are sort of the four main areas we cover now. Other data that is available is smoke alarms, way they play, also the cost of materials being associated with the fire, say for example in the case we are looking at it might be an electrical wiring run through that contacted with insulation or something like that. So, there is a lot of other data available, some of it is available than others and sometimes it is just a matter of getting the data out and looking at it and seeing where it helps us. But generally, there's a lot of good data available on web sites now, generally described for us and what equipment were involved in getting fires out so that's pretty reliable data we have for the last 25 years.

Hal: OK, thank you. Also, with this legislation, are you looking for how the public will be notified or is it more for, a, the government officers and people that are implementing these laws or is it actually letting society know about these new legislations and installations?

Jarrold: That's a really good question. My thoughts are initially it's probably about government agencies and officers that are in charge of compliance but in the longer term I can't see how we could avoid not focusing on that form of communication so the process of the international or a review of what's going on in other parts of the world is probably more about the codes that the officials would use not necessarily what is communicated to the public. In the context of the output of the report, I'd say initially being focused on the government officials etc. that have the authority, the jurisdiction, for approval but in the longest term it is about educating the community that if you live in a home that is 40 years old, and you're running all the modern appliances, it would be in your best interest to investigate the state of repair of your home in relation to electricity and its use.

Hal: OK

Rick: When you say, um, jurisdiction, what you do mean by that? Do you mean, um, those who are enforcing the codes upon the houses and the people who are installing the electrical systems in those houses?

Jarrold: That's right. The people that have the responsibility for enforcing the law which usually only happens at the time in which a building is first designed or approved for construction so the design approved for construction subsequently it is approved for occupation. That's about the only time that enforcers have the opportunity to check compliance unless there is some significant work being undertaken at a later stage. In Victoria, our approval process has been significantly deregulated over a number of years, whereas once upon a time it would have been a local government official went out to the house as it was being built and physically inspected to make sure that the trades people,

that the electrician, was doing what he or she was supposed to be doing in accordance with the codes and the standards but now a certificate is issued by the electrical contractor which states that it complies with all the codes and the standards. That certificate has been given to what we refer to as the building surveyor or the authority having jurisdiction to issue approval to move into a house and that's registered with the local govern official. So a physical inspection of a local govern official doesn't happen anymore however historically that's the way it would have occurred there would have been a representative of the government visiting every installation and issuing a certificate or an observation to say that it complies with the codes and standards.

Hal: All right. Do you guys have anything else? All right, I think that is all the questions we have for you.

Jarrold: OK. As you progress between now and the time you arrival date, things will arise and yet please don't hesitate to seek further advice, input, or questions via email if you've got anything you'd like us to contribute to. Don't hesitate. If you find or get to the point where email is confusing and a conversation will benefit, let us know and we will hopefully ask Scott organize to make a little more convenient otherwise if inconvenient we can always make the call to you guys.

Hal: Yes, thank you, that would, a, help us a lot.

Jarrold: OK. Well, I don't have any more. I don't recall trying to thin (?) when you anticipate arriving or when is the commencement date of the project-work with us is probably the more pertinent question. Secondary, when do you all anticipate arriving in Australia?

Hal: Um, I believe our project won't start until early March. Possibly around the 12<sup>th</sup> of March and, a, some of us are planning on coming early and doing a little travelling and getting used to the Melbourne area and Australia and then hopefully be ready to go to work on the project.

Jarrold: Of course we will be in touch as to when you will arrive. We don't need to see you with your social activities and early arrival but it probably doesn't hurt to have a friendly face to point you in the right direction in terms of travel and getting around town so if your open to us we'd be happy to meet you at your earliest when you arrive but other than that, we understand that WPI and your advisors will expect you to meet with us several days prior to the commencement of project work on site anyway as a bit of introduction.

Hal: Yeah, a, we're a, I'm sure we'll be in contact and a figure things out so we can make this process smoother.

Jarrold: We hope that, I've got 4 or 5 years with IQP projects so a, I've seen it all, I don't think there is anything that you will shock me with in terms of what you might get up to outside your project work activities. But on the whole I must say my experience has always been very positive and your previous student representatives have always done fantastic job with representing WPI and the US so we look forward to having you here.

Hal: Yes, we appreciate you taking this time to talk with us. We are really looking forward to working on this project. And, a, I am sure we will stay in contact, and, um, the process that we are going through with this project.

Jarrold: Cool, alright guys, enjoy the rest of your evening. I don't know whether you're going to a bit more studying or to hit the bed now. We've got an afternoon of work left so we'll be going. It was nice to meet you guys.

Hal: You too thank you very much.

Rick: Thank you.

Danny, Zach: Nice to meet you

Jeff: And when I finish that report I will send it to Daniel's email so you can have a bit of a look at our data and what me might be able to get for you.

Hal: Thank you very much.

Danny: That'd be great.

Jeff: Alright Good night guys

Hal: Yea you too.

Danny: Good night

Zach: Good night, a, G'day.

# APPENDIX E: ELECTRICAL WIRING SYSTEM FAULT DETECTION FLOW CHART

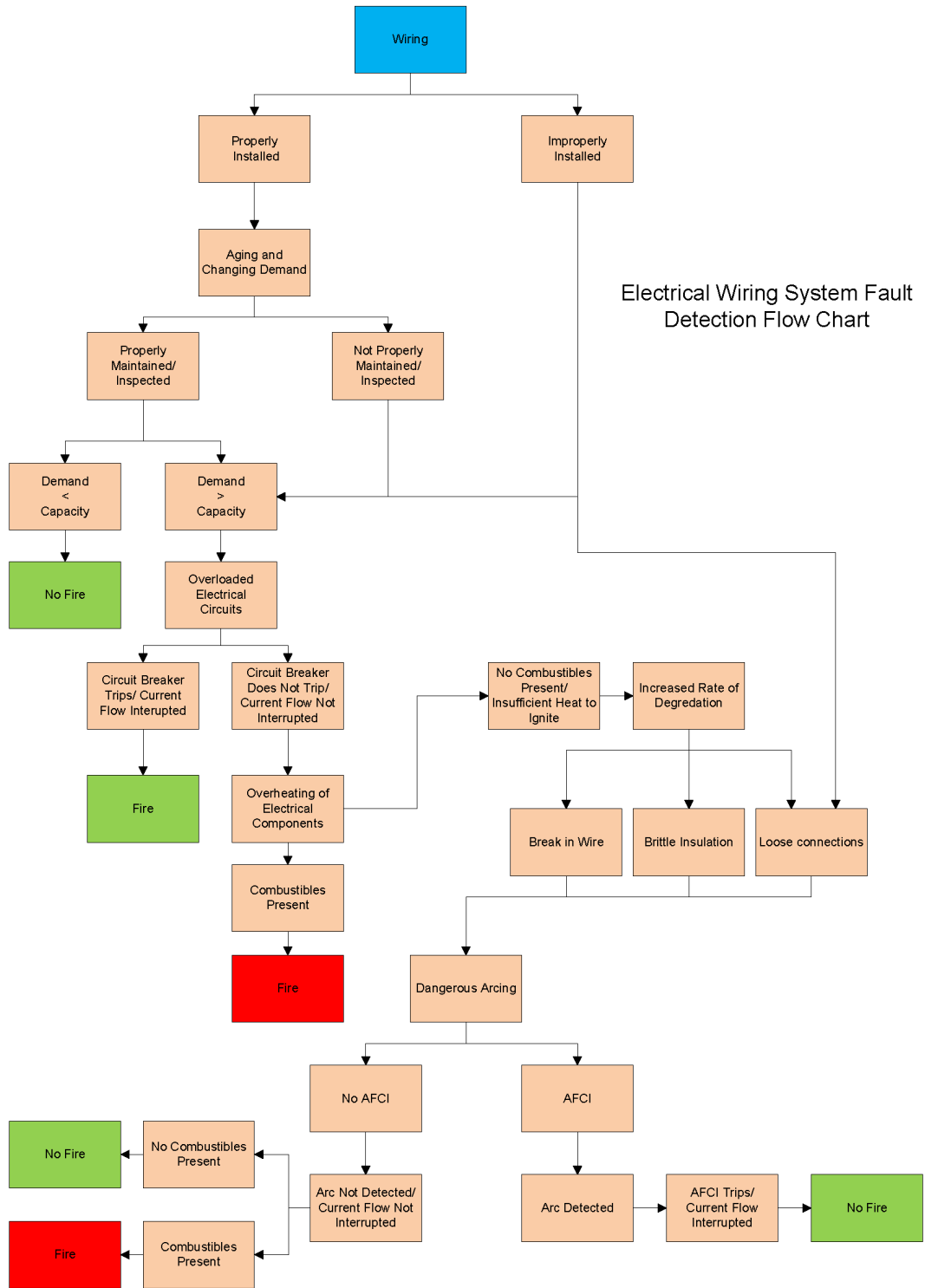



# APPENDIX F: OFFICE OF THE CHIEF ELECTRICAL INSPECTOR GUIDELINES FOR PRESCRIBED AND NON-PRESCRIBED WORK

(This document gives many examples of various forms of electrical work and states whether they are considered prescribed or non-prescribed work.)



OFFICE OF THE CHIEF ELECTRICAL INSPECTOR

**P** - Prescribed Electrical Installation Work in accordance with Regulation 406(1)  
**NP** - Non-Prescribed Electrical Installation Work in accordance with Regulation 406(2)

## 1. MAINS CONNECTION BOX (Fused or Non-Fused)

Repair to cable at a mains connection box.	NP
Repair of connection at a mains connection box.	NP
Replacement of a single component consumers main connection box in the <u>same</u> location (e.g. to allow for fascia replacement or wall cladding installation).	NP
Replacement of a single component consumers main connection box in a <u>different</u> location.	P
Replacement of 55-amp single component consumers mains box with an 80-amp box in the <u>same</u> location.	NP
Replacement of a 55-amp single component box with 80-amp consumers mains box in a <u>different</u> location.	P
Replacement of single component un-fused mains connection box with a fused mains box in <u>same</u> location.	NP

## 2. CONSUMERS' MAINS – GENERAL (including, Submains of Multiple Installations)

Repair to conductor insulation or conductor, (e.g. joint in conductor at junction box).	NP
The replacement of an entire section of consumers mains (or submains of a multiple installation) by use of a <u>similar wiring system</u> of the <u>same</u> current carrying capacity installed in <u>exactly the same</u> location (identical route).	NP
The replacement of an entire section of consumers mains (or submains of a multiple installation) by use of a <u>different wiring system</u> .	P
The replacement of an entire section of consumers mains (or submains of a multiple installation) of <u>lesser or greater</u> current carrying capacity than originally installed in <u>exactly the same</u> location (identical route).	P
The replacement of an entire section of consumers mains (or submains of a multiple installation) of the <u>same</u> current carrying capacity installed in a <u>different</u> location (non-identical route).	P
The replacement of an entire section of consumers mains (or submains of a multiple installation) of <u>lesser or greater</u> current carrying capacity than originally installed in a <u>different</u> location (non-identical route).	P

## 3. CONSUMERS' MAINS – UNDERGROUND ELECTRIC LINES

Repair to conductor insulation or conductor, (e.g. joint in conductor at junction box)	NP
The replacement of consumers mains by use of a <u>similar wiring system</u> of the <u>same</u> current carrying capacity installed in exactly the <u>same</u> location (identical route).	NP
The replacement of consumers mains (or submains of a multiple installation) by use of a <u>different wiring system</u> .	P
The replacement of consumers mains of <u>lesser or greater</u> current carrying capacity installed in exactly the <u>same</u> location (identical route).	P
The replacement of consumers mains of the <u>same</u> current carrying capacity installed in a <u>different</u> location (non-identical route).	P

## 4. CONSUMERS' MAINS – PRIVATE OVERHEAD ELECTRIC LINES

Repair to severed or damaged overhead conductor, (e.g. approved joint in conductor).	NP
Restraining overhead conductor.	NP



## OFFICE OF THE CHIEF ELECTRICAL INSPECTOR

Replacement of single component aerial component hardware, (e.g. insulator, cross-arm brace, stay, pole cap, etc).	NP
Re-securing aerial component hardware, (e.g. tightening insulators, cross-arm braces, struts, pole caps etc).	NP
Replacement of <u>more</u> than 30% of overhead conductor by use of a <u>similar wiring system</u> in the <u>same</u> route location in a high bushfire risk area – <i>only where permitted by an OCEI exemption.</i>	NP
Replacement of <u>more</u> than 30% of overhead conductor by use of a <u>different wiring system</u> in the <u>same</u> route location in a high bushfire risk area – <i>only where permitted by an OCEI exemption.</i>	P
Replacement of <u>less</u> than 30% of overhead conductor by use of a <u>similar wiring system</u> in the <u>same</u> route location in a high bushfire risk area.	NP
Replacement of <u>less</u> than 30% of overhead conductor by use of a <u>different wiring system</u> in the <u>same</u> route location in a high bushfire risk area.	P
Replacement of a single component circuit protective devices of <u>same</u> current carrying capacity at the <u>same</u> location, (e.g. circuit breaker, fused mains box).	NP
Installation of a circuit protective device for the first time at origin of circuit, (e.g. circuit breaker, fused mains box).	P
Replacement of a pole in the <u>same</u> location, which constitutes <u>less</u> than 30% of the total number of poles in the line in a high bushfire risk area.	NP
Replacement of a pole in a <u>different</u> location, which constitutes <u>less</u> than 30% of the total number of poles in the line in a high bushfire risk area.	P
Replacement of a pole in the <u>same</u> location, which constitutes <u>more</u> than 30% of the total number of poles in the line in a high bushfire risk area – <i>only where permitted by an OCEI exemption.</i>	NP
Relocation of an existing pole in a high bushfire risk area – <i>only where permitted by an OCEI exemption.</i>	P
Installation of a new pole in a high bushfire risk area – <i>only where permitted by an OCEI exemption.</i>	P
Replacement of a cross arm.	NP
Temporarily staking defective pole, using approved re-instatement technology - <i>only where permitted by an OCEI exemption.</i>	NP

### 5. MAIN EARTHING SYSTEM

Disconnection/reconnection of existing conductor termination at earth electrode.	NP
Repair to earthing conductor.	NP
Replacement of an earth conductor of the <u>same</u> size and in the <u>same</u> location.	NP
Replacement of an earth conductor of larger or smaller <u>size</u> and in the <u>same</u> location.	P
Replacement of an earth conductor of <u>same</u> size and in <u>different</u> location.	P
Installation of an earth electrode for the first time.	P
Replacement of an earth electrode in <u>same</u> location.	NP
Replacement of an earth electrode in <u>different</u> location.	P

### 6. METER ENCLOSURE & CUSTOMER PROVIDED EQUIPMENT (Equipment not owned by Electricity Supplier)

Replacement of meter box enclosure in <u>same</u> location.	NP
Replacement of meter box enclosure in <u>different</u> location.	P



## OFFICE OF THE CHIEF ELECTRICAL INSPECTOR

### 7. SWITCHBOARD – MAIN (including switchboards installed in individual occupancies of multiple installations)

Relocation of an existing main switchboard.	P
Replacement of a main switch with another switch of the <u>same</u> current rating in the same location.	NP
Replacement of a main switch with another switch of <u>different</u> current rating in the same location.	P
Installation of an additional main switch, (e.g. to allow for off-peak tariff equipment connection).	P
Relocation of main switch on the main switchboard.	P
Replacement of the main neutral link with another link of the <u>same</u> current carrying capacity in the same location.	NP
Replacement of the main neutral link with another link of <u>different</u> current carrying capacity in the same location, (e.g. replacing existing neutral link with limited connecting terminals to allow for additional circuits).	P
Replacement of an existing main switchboard assembly with another main switchboard assembly in the <u>same</u> location, (e.g. replacing panel and frame type switchboard with a circuit breaker type switchboard).	P
Replacement of main switch with a combined RCD/MCB (Residual Current Device / Miniature Circuit Breaker type).	P
Repair of a consumers mains conductor termination (i.e. on the line side of a main switch or at a neutral link).	NP
Installation of an RCD on the line side of a main switch.	P
Installation of single component surge protection device on the line side of a main switch.	P
Replacement of single component surge protection devices on the line side of a main switch in the same location.	NP
Installation of single component surge protection devices on the load side of a main switch in the same location.	NP

### 8. EQUIPMENT IN HAZARDOUS AREAS (including protection equipment associated with hazardous areas)

Repair to conductor insulation or conductor in hazardous areas, (e.g. joint in conductor).	NP
Repair to conductor connection at electrical equipment in hazardous areas.	NP
Replacement of single component electrical equipment of the <u>same</u> current rating and/or hazardous area classification characteristics where the cable termination does not involve re-routing of the original cable - <i>where permitted in accordance with Clause 2.7 of AS/NZS 2381.1:1999.</i>	NP
Replacement of single component electrical equipment of the <u>same</u> current rating and/or hazardous area classification characteristics where the cable termination <u>involves</u> re-routing of the original cable.	P
Replacement of single component electrical equipment of <u>different</u> current rating and/or hazardous area classification characteristics - <i>where permitted in accordance with Clause 2.7 of AS/NZS 2381.1:1999.</i>	P
Replacement of single component control, isolation or protection devices of the <u>same</u> current rating and/or hazardous area classification characteristics in the <u>same</u> location - <i>where permitted in accordance with Clause 2.7 of AS/NZS 2381.1:1999.</i>	NP
Replacement of single component control, isolation or protection devices of the <u>same</u> current rating and/or hazardous area classification characteristics in a <u>different</u> location - <i>where permitted in accordance with Clause 2.7 of AS/NZS 2381.1:1999.</i>	P
Alteration of a cable route in a hazardous area.	P
Replacement of protection equipment associated with hazardous areas of the <u>same</u> current rating in <u>same</u> location - <i>where permitted in accordance with Clause 2.7 of AS/NZS 2381.1:1999.</i>	NP
Replacement of protection equipment associated with hazardous areas of the <u>same</u> current rating in a <u>different</u> location - <i>where permitted in accordance with Clause 2.7 of AS/NZS 2381.1:1999.</i>	P
Alteration of single component protection equipment associated with hazardous areas - <i>where permitted in accordance with Clause 2.7 of AS/NZS 2381.1:1999.</i>	P



**9. HIGH VOLTAGE EQUIPMENT**

Repair to high voltage conductor insulation or conductors.	NP
Repair to high voltage conductor connections at equipment.	NP
Replacement of single component high voltage electrical equipment of the <u>same</u> current rating where the cable termination does not involve re-routing of the original cable.	NP
Replacement of single component high voltage electrical equipment of the <u>same</u> current rating where the cable termination <u>involves</u> re-routing of the original cable.	P
Replacement of single component high voltage electrical equipment of the <u>same</u> current rating and <u>same</u> protection characteristics, (e.g. circuit breaker).	NP
Replacement of single component high voltage electrical equipment of the <u>same</u> current rating and <u>different</u> protection characteristics, (e.g. circuit breaker).	P
Replacement of single component high voltage control, isolation or protection devices of the <u>same</u> current rating in the <u>same</u> location.	NP
Replacement of single component high voltage control, isolation or protection devices of the <u>same</u> current rating in a <u>different</u> location.	P
Replacement of an entire section of high voltage cable by use of a <u>similar wiring system</u> of the <u>same</u> current carrying capacity and <u>same</u> fault level rating in exactly the <u>same</u> location, (identical route).	NP
Replacement of an entire section of high voltage cable by use of a <u>different wiring system</u> .	P
Replacement of an entire section of high voltage cable of the <u>same</u> current carrying capacity and <u>same</u> fault level rating to a <u>different</u> location (non-identical route).	P
Replacement of one of the following single components of high voltage equipment of the <u>same</u> current carrying capacity and fault level rating (where applicable) in the same location, <ul style="list-style-type: none"> <li>* Lightning Arrester</li> <li>* Overhead conductor support structure</li> <li>* Overhead conductor support structure cross-arm</li> <li>* Fuse assembly</li> <li>* Transformer</li> <li>* Insulator</li> <li>* Power factor correction equipment (capacitor bank)</li> <li>* Insulating mediums (oil) within transformer, circuit breaker, capacitor bank etc.</li> </ul>	NP
Replacement of commutator brushes on high voltage motor – by use of tools.	NP
Replacement of slip rings on high voltage motor.	NP
Maintenance of slip rings or commutator/s on high voltage motor.	NP

**10. STANDBY / COGENERATION EQUIPMENT**

The replacement of an entire section of a wiring system by use of a <u>different wiring system</u> .	P
The replacement of an entire section of an <u>identical wiring system</u> of the <u>same</u> current carrying capacity installed in exactly the <u>same</u> location (identical route).	NP
The replacement of an entire section of a wiring system of the <u>same</u> current carrying capacity installed in a <u>different</u> location (non-identical route).	P
The replacement of an entire section of a wiring system of <u>lesser or greater</u> current carrying capacity than originally installed in exactly the <u>same</u> location (identical route).	P
The replacement of an entire section of a wiring system of <u>lesser or greater</u> current carrying capacity than originally	P



## OFFICE OF THE CHIEF ELECTRICAL INSPECTOR

installed in a <u>different</u> location (non-identical route).	
Repair to conductor insulation or conductors.	NP
Repair to conductor connections at electrical equipment.	NP
Replacement of single component electrical equipment of <u>same</u> current rating, (e.g. protection, control, etc).	NP
Replacement of single component electrical equipment of <u>different</u> current rating.	P

### 11. STAND ALONE POWER SYSTEMS

Repair to conductor connection at electrical equipment.	NP
Replacement of single component electrical equipment of <u>same</u> current rating, (e.g. protection, control, etc).	NP
Replacement of single component electrical equipment of <u>different</u> current rating.	P
Repair to conductor insulation or conductor.	NP
The replacement of an entire section of a <u>similar wiring system</u> of the <u>same</u> current carrying capacity installed in exactly the <u>same</u> location (identical route).	NP
The replacement of an entire section of a wiring system by use of a <u>different wiring system</u> .	P
The replacement of an entire section of wiring system of <u>lesser or greater</u> current carrying capacity than originally installed in exactly the <u>same</u> location (identical route).	P
The replacement of an entire section of wiring system of the <u>same</u> current carrying capacity installed in a <u>different</u> location (non-identical route).	P
The replacement of an entire section of wiring system of <u>lesser or greater</u> current carrying capacity than originally installed in a <u>different</u> location (non-identical route).	P

### 12. ELECTRIC FENCES (SECURITY PURPOSES)

Repair to conductor insulation or conductor.	NP
Repair to conductor connection at electrical equipment.	NP
Replacement of single component electrical equipment of <u>same</u> current rating, (e.g. energizers, ancillary, protection, control equipment, etc).	NP
Replacement of single component electrical equipment of <u>different</u> current rating, (e.g. energizers, ancillary, protection, control, equipment etc).	P
The replacement of an entire section by use of a <u>similar wiring system</u> of the <u>same</u> current carrying capacity installed in exactly the <u>same</u> location (identical route).	NP
The replacement of an entire section of a wiring system by use of a <u>different wiring system</u> .	P
The replacement of an entire section of wiring system of <u>lesser or greater</u> current carrying capacity than originally installed in exactly the <u>same</u> location (identical route).	P
The replacement of an entire section of wiring system of the <u>same</u> current carrying capacity installed in a <u>different</u> location (non-identical route).	P
The replacement of an entire section of wiring system of <u>lesser or greater</u> current carrying capacity than originally installed in a <u>different</u> location (non-identical route).	P
Installation or alteration of fence.	P
Replacement of fence in <u>same</u> location.	NP
Replacement of fence in <u>different</u> location.	P
Replacement of physical barrier in <u>different</u> location.	P



**OFFICE OF THE CHIEF ELECTRICAL INSPECTOR**

Installation or alteration of physical barrier in <u>same</u> location.	<b>NP</b>
Replacement of physical barrier in <u>same</u> location.	<b>NP</b>

**13. ELECTRO MEDICAL EQUIPMENT**

Repair to conductor insulation or conductor.	<b>NP</b>
Repair to conductor connection at electrical equipment.	<b>NP</b>
Replacement of electrical equipment of <u>same</u> current rating, (e.g. socket outlet, residual current device, line isolation monitor, circuit breaker, isolating switch, isolating transformer, EP terminal, theatre lighting, etc).	<b>NP</b>
Replacement of electrical equipment of <u>different</u> current rating, (e.g. socket outlet, residual current device, line isolation monitor, circuit breaker, isolating switch, isolating transformer, EP terminal, etc).	<b>P</b>
Installation of electrical equipment, (e.g. socket outlet, residual current device, line isolation monitor, circuit breaker, isolating switch, isolation transformer, EP terminal, etc).	<b>P</b>
Alteration of electrical equipment, (e.g. socket outlet, residual current device, line isolation monitor, circuit breaker, isolating switch, isolating transformer, EP terminal, etc).	<b>P</b>

## **APPENDIX G: OCEI – OBJECTIVES AND FUNCTIONS**

A detailed list of the objectives and functions of the Office of the Chief Electrical Inspector defined by The Electricity and Safety Act

### **1. INTRODUCTION**

#### **1.1 Establishment**

The Office of the Chief Electrical Inspector (OCEI) is the independent safety and technical regulator for the total electricity industry in Victoria.

The Chief Electrical Inspector was established in the State Electricity Commission of Victoria (SECV) to regulate electrical safety throughout Victoria. With the privatisation of the electricity industry in Victoria, the OCEI was established as an independent regulator, firstly in accordance with the Electricity Industry Act 1993 and more recently in accordance with the Electricity Safety Act 1998.

#### **1.2 Electricity Safety Act 1998**

Part 2 of the Act defines the establishment of the OCEI including its objectives and functions.

##### **1.2.1 Objectives**

The objectives of the OCEI are as follows:

- (a) to ensure the electrical safety of electrical generation, transmission and distribution systems, electrical installations and electrical equipment;
- (b) to control the electrical safety standards of electrical work carried out by electrical workers;
- (c) to promote awareness of energy efficiency through energy efficiency labelling of electrical equipment and energy efficiency of electrical equipment;
- (d) to protect underground and underwater structures from corrosion caused by stray electrical currents; and
- (e) to maintain public and industry awareness of electrical safety requirements.

##### **1.2.2 Functions**

The functions of the OCEI are as follows:

- (a) to determine minimum safety standards for electrical equipment, electrical installations and electrical work;
- (b) to encourage and monitor the use of electricity safety management schemes;
- (c) to inspect and test electrical equipment, electrical installations and electrical work for compliance with the specified safety standards;
- (d) to administer the prescribed minimum standards for energy efficiency of electrical equipment;
- (e) to inspect and test electrical equipment for compliance with the specified minimum standards for energy efficiency;

- (f) to investigate events or incidents which have implications for electrical safety;
- (g) to provide advisory and consultative services in relation to electrical safety and electrical equipment, electrical installations and electrical work;
- (h) to advise the electricity industry and the community in relation to electrical safety;
- (i) to monitor and enforce compliance with the Act and associated regulations;  
and
- (j) such other functions as are conferred on the OCEI by or under the Act or any other Act.

### 1.2.3 Powers

For the purpose of performing its functions the OCEI has such powers as are conferred on it by the Act or any other Act and may do all other things necessary or convenient to be done for, or in connection with, or as incidental to, the achievement of the OCEI objectives or the performance of the OCEI functions.

### 1.2.4 Corporate Plan

The OCEI prepares a corporate plan each year and a Statement of Corporate Intent that covers a three-year period including the current financial year and two future financial years.

### 1.2.5 Annual Report

The OCEI prepares an Annual Report that covers each financial year and the Annual Report is presented in the Victorian Parliament. The Annual Report for the year 2003/2004 is available on the OCEI's website ([www.ocei.vic.gov.au](http://www.ocei.vic.gov.au)).

### 1.2.6 Regulations

The OCEI administers regulations as follows:

- Electricity Safety (Bushfire Mitigation) Regulations 2003;
- Electricity Safety (Electric Line Clearance) Regulations 1999;
- Electricity Safety (Equipment Efficiency) Regulations 1999;
- Electricity Safety (Equipment) Regulations 1999;
- Electricity Safety (Infringement) Regulations 2000;
- Electricity Safety (Installations) Regulations 1999;
- Electricity Safety (Management) Regulations 1999;
- Electricity Safety (Network Assets) Regulations 1999; and
- Electricity Safety (Stray Current) Regulations 1999.

### 1.2.7 Orders-in-Council

The OCEI administers a significant number of Orders-in-Council providing for exemptions from the Electricity Safety Act under Section 4 of the Act.



### 1.2.8 Standards

The OCEI administers the significant number of Australian Standards and Australian/New Zealand Standards incorporated in the regulations.

### 1.2.9 Codes of Practice

The OCEI administers relevant Codes of Practice that are incorporated or partly incorporated in regulations.

### 1.2.10 Guidelines

The OCEI has developed a significant number of guidelines to assist the public, other regulatory authorities, industry participants and national/international bodies understand the means by which compliance with the legislation and regulations can be achieved.

### 1.2.11 Policies

The OCEI has developed and published appropriate policies (eg. Enforcement Policy) on the OCEI website and in the Annual Report. The publication of these policies enable the public, industry participants, other regulators and national/international bodies to understand the mode of operation of the OCEI.

## 2. ACHIEVEMENTS

Since the establishment of the OCEI under the Electricity Safety Act in 1998, the OCEI has demonstrated national leadership in electrical safety matters throughout Australia and continues to improve the current superior electrical safety record for Victoria. In 2002/2003, it was reported for the first time since records began, that no person had died from accidental electrocution in Victoria for two years (26 months). This achievement is very significant given that 52 deaths had occurred in other Australian States and Territories and New Zealand during those two years. However, one death from direct contact with overhead electrical assets has occurred in 2003/2004 and 2004/2005, while no deaths have occurred on electrical installations in the housing sector or industrial/commercial or farming sectors for over 5 years.

This safety record has been obtained by the OCEI operating in its independent role to balance the needs of the community with electricity industry participants and other industry stakeholders.

The OCEI intends to continue to ensure it maintains its premier position through building on key initiatives, namely:

- The Certificate of Electrical Safety system, which is the most effective vehicle to ensure electrical installation work (“installation work” means installation, maintenance, repair and alteration) is safe and complies with the relevant standards.
- Actively pursue the OCEI’s ongoing safety switch campaign with the aim of ensuring that Victoria’s 1.6 million domestic properties have the total protection of safety switches in the coming years.
- Build on the OCEI’s “No Go Zone” project to educate workers in a wide variety of occupations in the practices and competencies required to achieve safety when

## APPENDIX H: EQUIVALISED DISPOSABLE HOUSEHOLD INCOME

(From the appendix of ABS 2009)

A detailed description of how the equivalised disposable household income is calculated and why it is used for comparison rather than just disposable household income

### EQUIVALENCE SCALES

Equivalence scales have been devised to make adjustments to the actual incomes of households in a way that enables analysis of the relative wellbeing of households of different size and composition. For example, it would be expected that a household comprising two people would normally need more income than a lone person household if the two households are to enjoy the same standard of living.

One way of adjusting for this difference in household size might be simply to divide the income of the household by the number of people within the household so that all income is presented on a per capita basis. However, such a simple adjustment assumes that all individuals have the same resource needs if they are to enjoy the same standard of living and that there are no economies of scale derived from living together.

Various calibrations, or scales, have been devised to make adjustments to the actual incomes of households in a way that recognises differences in the needs of individuals within those households and the economies that flow from sharing resources. The scales differ in their detail and complexity but commonly recognise that the extra level of resources required by larger groups of people living together is not directly proportional to the number of people in the group. They also typically recognise that children have fewer needs than adults.

When household income is adjusted according to an equivalence scale, the equivalised income can be viewed as an indicator of the economic resources available to a standardised household. For a lone person household it is equal to household income. For a household comprising more than one person, it is an indicator of the household income that would need to be received by a lone person household to enjoy the same level of economic wellbeing as the household in question.

Alternatively, equivalised household income can be viewed as an indicator of the economic resources available to each individual in a household. The latter view underpins the calculation of income distribution measures based on numbers of people, rather than numbers of households.

### CHOICE OF SCALE

While there has been considerable research by statistical and other agencies trying to estimate appropriate values for equivalence scales, no single standard has emerged. In theory, there are many factors which might be taken into account when devising equivalence scales, such as recognising that people in the labour force are likely to face transport and other costs that can affect their standard of living. It might also be desirable to reflect the different needs of children at different ages, and the different cost levels faced by people living in different geographic areas. On the other hand, the tastes and preferences of people vary widely, resulting in markedly different expenditure patterns between households with similar income levels and similar composition. Furthermore, it is likely that equivalence scales that appropriately adjust incomes of low income households are not as appropriate for higher income households, and vice versa. This is because the proportion of total income spent on housing tends to fall as incomes rise, and cheaper per capita housing is a major source of economies of scale that flow from people living together.

It is therefore difficult to define, estimate and use equivalence scales which take all relevant factors into account. As a result, analysts tend to use simple equivalence scales which are chosen subjectively but are nevertheless consistent with the quantitative research that has been undertaken. A major advantage of simpler scales is that they are more transparent to the user, that is, it is easier to evaluate the assumptions being made in the equivalising process.

CHOICE OF SCALE *continued*

In this publication, the 'modified OECD' equivalence scale is used. The 'modified OECD' equivalence scale has been used in more recent research work undertaken for the Organisation for Economic Co-operation and Development (OECD), has wide acceptance among Australian analysts of income distribution, and is the stated preference of key Survey of Income and Housing (SIH) users.

DERIVATION OF EQUIVALISED INCOME

Equivalised income is derived by calculating an equivalence factor according to the chosen equivalence scale, and then dividing income by the factor.

The equivalence factor derived using the 'modified OECD' equivalence scale is built up by allocating points to each person in a household. Taking the first adult in the household as having a weight of 1 point, each additional person who is 15 years or older is allocated 0.5 points, and each child under the age of 15 is allocated 0.3 points.

Equivalised household income is derived by dividing total household income by a factor equal to the sum of the equivalence points allocated to the household members. The equivalised income of a lone person household is the same as its unequivalised income. The equivalised income of a household comprising more than one person lies between the total value and the per capita value of its unequivalised income.

Equivalised household income is an indicator of the economic resources available to each member of a household. It can therefore be used for comparing the situation of individuals as well as comparing the situation of households.

When unequivalised income is negative, such as when losses incurred in a household's unincorporated business or other investments are greater than any positive income from any other sources, then equivalised income has been set to zero.

GROSS INCOME AND EQUIVALISED DISPOSABLE INCOME

The SIH collects data on households' gross income. However, disposable income, that is, gross income less the value of income tax and Medicare levy to be paid on the gross income, is a better indicator of the resources available to a household to maintain its standard of living. Therefore, for this publication, estimates of income tax payable on gross income reported in the SIH are made by means of a tax model. The tax and Medicare estimates are subtracted from gross income to give disposable income, and the equivalence factors are applied to the estimates of disposable income. Person weighted measures of income distribution are then derived from the estimates of equivalised disposable household income. (Appendix 1 describes the difference between person weighted and household weighted measures.)

Means and medians of both gross income and equivalised disposable income are shown in some tables in this publication to allow users to see the differences between data as collected and data as standardised to facilitate income distribution analysis. The following table shows the differences in income measures when calculated from data at different stages in the progression from gross household income to person weighted equivalised disposable household income.

A5. FROM GROSS INCOME TO PERSON WEIGHTED EQUIVALISED DISPOSABLE INCOME, 2007-08

		Gross household income per week	Income tax per week	Disposable household income per week	EQUIVALISED DISPOSABLE HOUSEHOLD INCOME PER WEEK	
					Household weighted	Person weighted
<b>Percentile boundaries and percentile ratios</b>						
P10	\$	324	na	325	286	317
P20	\$	540	na	539	365	410
P50	\$	1 285	na	1 128	674	692
P80	\$	2 390	na	1 962	1 091	1 079
P90	\$	3 192	na	2 537	1 381	1 360
P90/P10	ratio	9.86	na	7.81	4.83	4.30
P80/P20	ratio	4.42	na	3.64	2.99	2.63
<b>Means</b>						
All households	\$	1 649	284	1 366	803	811
One family households						
Couple family with dependent children	\$	2 296	427	1 868	831	810
One parent family with dependent children	\$	1 021	97	923	535	520
Couple only	\$	1 626	285	1 341	896	896
Other one family households	\$	2 157	336	1 820	902	916
Multiple family households	\$	2 523	380	2 144	755	751
Non-family households						
Lone person	\$	806	134	672	673	673
Group households	\$	2 053	371	1 682	997	993

na not available

GROSS INCOME AND EQUIVALISED DISPOSABLE INCOME *continued*

The first column in the table above shows measures calculated from gross household income, as collected in the SIH. The next column shows estimates of income tax to be paid on gross income, with the third column giving the resultant disposable household income.

Individuals with higher incomes will normally be expected to pay higher income tax than individuals with lower incomes, but this relationship is not as strong for households. A household with relatively high income may comprise only one individual with high income or it may include a number of individuals with relatively low income. The disposable income in the first situation will be lower than that in the second situation, and will result in a reranking of the households in the formation of percentiles. Therefore a household may fall into a different percentile in an analysis of disposable income compared to an analysis of gross income.

As would be expected, the difference between disposable income and gross income increases as income levels increase. At the upper boundary of the tenth percentile (P10), there is little difference, that is, the income tax to be paid by households with the lowest levels of gross income is negligible. In contrast, there is more than \$655 per week difference between the P90 value for gross household income and the P90 value for disposable household income.

Disposable income relates to the household as a whole and the percentiles and means are calculated with respect to the numbers of households concerned. These are referred to as household weighted estimates. Equivalised disposable household income can also be household weighted (see the fourth column in the table), but since it can be viewed as a measure of the economic resources available to each individual in a household, income measures for equivalised estimates are generally based on numbers of people rather than numbers of households (see the fifth column in the table). This is referred to as person weighting and ensures that people in large households are given as much weight in the distribution as people in small households. While the ranking underlying the formation of percentiles is the same for the household and person weighted

GROSS INCOME AND  
EQUIVALISED DISPOSABLE  
INCOME *continued*

estimates, the boundaries between the percentiles differ because household weighted percentile boundaries create subgroups with equal numbers of households while person weighted percentile boundaries create subgroups with equal numbers of persons. The extent to which the boundaries differ reflects the extent to which the average household size differs between percentiles.

The person weighted estimate of P10 (\$317) is higher than the household weighted estimate of P10 (\$286). This implies that the households with the lowest rankings of equivalised disposable household income tend to comprise a lower than average number of persons. In other words, the 10% of people with the lowest income make up more than the 10% of households with the lowest income.

For lone person households, the two measures of equivalised disposable income are the same as each other (\$673) and are just a little higher than disposable income (\$672). Equivalised disposable income for lone person households is approximately the same as disposable income, because the equivalising factor for such households is 1.0. The reason for the slight difference between them is that some households have negative disposable income and their values are reset to zero before equivalising is carried out.

For all other types of household composition, equivalised disposable income is lower than disposable income, since income is adjusted to reflect household size and composition. Mean equivalised disposable income for couple only households is the same for both the household weighted and the person weighted measures since there are always two and only two persons in such households. For most other multi-person households, person weighted mean income is lower than the household weighted mean. This implies that, within each type, larger households tend to have lower equivalised household income.

# APPENDIX I: SURVEY QUESTIONS

## Electrical Demand and Appliances Survey

### Page 1 - Basic Information

---

1. **How old are you? (No worries, this survey is anonymous)**

2. **Male or Female**

- Male  Female

3. **Average Household Income**

- Under \$40,000  
 \$40,000-\$60,000  
 \$60,000-\$80,000  
 \$80,000-\$100,000  
 \$100,000-\$120,000  
 \$120,000-\$140,000  
 \$140,000-\$160,000  
 \$160,000-\$180,000  
 Over \$200,000

4. **Number of people living in home**

5. **Type of Home (that you primarily live in)**

- House (class 1a)  
 Apartment or Flat (class 2)  
 Boarding House (class 1b & 3)  
 Not sure

6. **Age of home's construction, if known (give an estimated range of years if necessary)**

7. **Have there been any renovations to the electrical system in your home? If so, please comment on the type and year of the renovation?**

- Yes  
 No

Additional Comments

**8. Please indicate the number of each type of washer and dryer you have in your home. (if none, enter 0)**

# of Front-Load washers	
# of Top-Load washers	
# of Washer/Dryer Combos	
# of Front-Load Dryers	
# of Top-Load Dryers	

**9. Is your clothes dryer Electric or Gas?**

- Electric
- Gas
- Not sure
- I don't have a clothes dryer at home

**10. How many of each type of air conditioner do you have? (if none, enter 0)**

Central AC	
Window AC	
Portable AC	
Split System (cooling only)	
Split System (heating and cooling)	

**11. Number of various types of Electrical Refridgerators (if none, enter 0)**

Full refridgerator only	
Full refridgerator with freezer	
Full Freezer	
Mini Fridges	

**12. How many of these size televisions do you have? (if none, enter 0)**

50" and above	
40"- 50"	
30"- 40"	
20"- 30"	
10"- 20"	
10" or less	

**13. Type of largest TV**

- Plasma
- LCD
- Projection
- Cathode Ray
- I don't know

**14. Do you have an electric hot water heater(s)?**

- Yes  No

**Page 3 - Electrical Hot Water Heater**

---

15. What size is your electrical hot water heater?

- 25L
- 50L
- 80L
- 125L
- 250L
- 300L
- 400L
- I Don't know
- If other, please specify

**Page 4 - Computers**

---

16. Please provide the number of the following personal computers you have in your home.  
(if none, enter 0)

Desktops

Laptops

Printers

Video Gaming Systems

17. In general, when you are not using your appliances that can be shut off, which of the following do you do?

- Shut-down
- Allow to go into standby
- Leave running



18. If you had to estimate, how many powerboards would you say you are using in your home?

19. How many of your powerboards have surge protection built into them?

- All of them
- Most of them
- Some of them
- None of them
- I'm not sure which do and don't

20. What devices do you typically plug into powerboards?  
(Mark all that apply)

- Large Big Screen TVs
- Refrigerators
- Freezers
- Air Conditioners
- Washer/Dryers
- Computers
- Monitors
- Small TVs
- Game Consoles
- Printers
- Microwave
- Toaster Oven
- Electric Stove
- Cell Phone chargers
- Other light-duty chargers
- Lamps
- Stereo Systems
- DVD / VCR Players
- Extension Cords
- Additional Powerboards
- If other, please specify

21. Do you ever "piggy-back" powerboards?  
(plug one powerboard into a socket of another)

- Yes, I have some permanantly piggy-backed
- Yes, but only temporarily when I need more plugs
- No
- I don't have any powerboards

## APPENDIX J: T-TESTS FOR CONSUMPTION PER CAPITA

Table 1 – T-test results for years in which there was a greater statistically significant rate of change in energy consumption per head in Victoria (1974-2006)

Year	% change	T-test
1974	11.13%	t(32) = -16.806, p=.000
1975	3.21%	t(32) = -2.478, p=.019
1976	8.93%	t(32) = -12.826, p=.000
1994	4.50%	t(32) = -4.812, p=.000
1995	3.04%	t(32) = -2.171, p=.037
1997	3.75%	t(32) = -3.455, p=.002
2002	5.56%	t(32) = -6.730, p=.000
2003	4.41%	t(32) = -4.161, p=.000
2005	4.92%	t(32) = -5.572, p=.000

Table 2 – T-test results for years in which there was a lesser statistically significant rate of change in energy consumption per head in Victoria (1974-2006)

Year	% change	T-test
1982	-0.97%	t(32) = 5.083, p=.000
1983	-0.26%	t(32) = 3.799, p=.001
1984	-0.60%	t(32) = 4.414, p=.000
1987	-0.78%	t(32) = 4.740, p=.000
1988	0.22%	t(32) = 2.931, p=.006
1990	0.19%	t(32) = 2.985, p=.005
1991	-1.68%	t(32) = 6.368, p=.000
1993	-3.69%	t(32) = 10.004, p=.000
1999	-3.33%	t(32) = 9.353, p=.000
2000	-0.46%	t(32) = 4.161, p=.000
2001	-3.85%	t(32) = 10.294, p=.000

# APPENDIX K: RESIDENTIAL ELECTRICITY CONSUMPTION IN VICTORIA FROM ABS

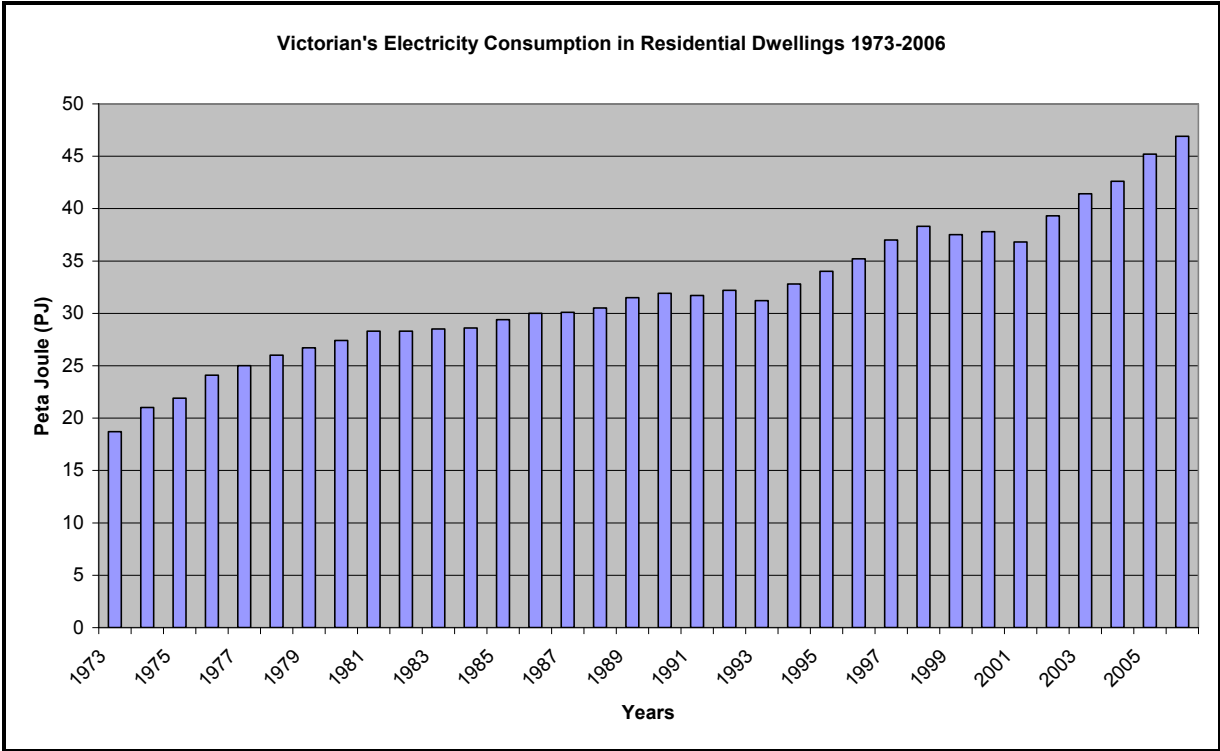

# APPENDIX L: AFAC AIRS INSTRUCTION MANUAL

Details of all the blocks and their corresponding field items, also indicating the reporting option (whether national or optional).

TABLE A NATIONAL AND OPTIONAL ITEMS

BLOCK	FIELD	DESCRIPTION	LENGTH OF FIELD	TYPE	NATIONAL ITEM	OPTIONAL ITEM
Block A	A1	Authority identification	3	Numeric	x	
	A2	Authority type	1	Numeric		x
	A3	Brigade identification	5	Numeric	x	
	A4	Incident number	8	Alpha/ Numeric	x	
	A5	Exposure number	1	Numeric	x	
	A6	Date of call	10	Date	x	
	A7	Day of week	1	Numeric		x
	A8	Alarm time	6	Numeric	x	
	A9	Method of notification	2	Numeric	x	
	A10	Agency/persons raising alarm	2	Numeric		x
	A11	Jurisdiction of origin	1	Numeric		x
	A12	Statistical local area	5	Numeric		x
	A13	Location of incident	11	Alpha numeric	x	
	A14	Occupants name	20	Alpha	x	
	A15	Property number	As required	Alpha/ numeric	x	
	A16	Street	As required	Alpha	x	
	A17	Town/suburb	As required	Alpha	x	
	A18	Post code	4	Numeric		x
	A19	Complex	2	Numeric		x
	A20	Type of property use	3	Numeric	x	
	A21	Type of owner	3	Numeric		x
	A22	Type of occupant	3	Numeric		x
	A23	Type of incident	3	Numeric	x	
	A24	Type of action taken	2	Numeric	x	
	A25	Control or stop date	10	Date	x	
	A26	Control or stop time	6	Numeric	x	
	A27	Duties completed date	10	Date	x	
	A28	Duties completed time	6	Numeric	x	
	A29	Peak number of fire service personnel at scene	3	Numeric		x
	A30	Peak number of pumpers used	3	Numeric		x
	A31	Peak number of aeriels used	3	Numeric		x
	A32	Peak number of specialised vehicles used	3	Numeric		x
	A32i	Number of pumper tanker/slipson (3000 L plus) used	3	Numeric		x
A32ii	Number of pumper tanker/slipson (1000 - 3000 L plus) used	3	Numeric		x	
A32iii	Number of pumper tanker/slipson (less than 1000 L plus) used	3	Numeric		x	
A32iv	Number of mobile canteens or kitchens used	3	Numeric		x	
A32v	Number of all terrain vehicles used	3	Numeric		x	
A33	Peak number of aircraft used	3	Numeric		x	
A33i	Number of fixed wing aircraft used for observation	3	Numeric		x	

TABLE A (CONT.) NATIONAL AND OPTIONAL ITEMS

BLOCK	FIELD	DESCRIPTION	LENGTH OF FIELD	TYPE	NATIONAL ITEM	OPTIONAL ITEM
	A33ii	Number of fixed wing aircraft used for transport	3	Numeric		x
	A33iii	Number of fixed wing aircraft used for firebombing	3	Numeric		x
	A33iv	Number of fixed wing aircraft used for aerial ignition	3	Numeric		x
	A33v	Number of helicopters used for observation	3	Numeric		x
	A33vi	Number of helicopters used for transport	3	Numeric		x
	A33vii	Number of helicopters used for fire bombing	3	Numeric		x
	A33viii	Number of helicopters used for aerial ignition	3	Numeric		x
	A34	Number of other appliances and vehicles dispatched	3	Numeric		x
	A34i	Number of earth moving equipment used	3	Numeric		x
	A34ii	Number of lifting equipment used	3	Numeric		x
	A34iii	Number of tanker vehicles not owned by the Authority	3	Numeric		x
	A34iv	Number of vehicles responded to scene owned/occupied by firefighters	3	Numeric		x
	A35	Mutual aid	1	Numeric	x	
	A36	Weather	1	Numeric		x
	A37	Delayed arrival	2	Numeric		x
	A38	Platoon/ Shift on duty	1	Alpha/ numeric		x
	A39	Self contained breathing apparatus used	2	Numeric		x
	A40	Oxygen (closed circuit) breathing apparatus used	2	Numeric		x
	A41	Additional cylinders used	3	Numeric		x
	A42	Problems encountered	2	Numeric		x
	A43	Responding brigade/appliance/unit Identifier	5	Numeric		x
	A44	Appliance type	2	Numeric		x
	A45	Appliance identification (registration number)	10	Alpha/ Numeric		x
	A46	Staff	2	Numeric		x
	A47	Dispatch date	10	Date		
	A48	Dispatch time	6	Numeric		x
	A49	Mobile date	10	Date		x
	A50	Mobile time	6	Numeric		x
	A51	Arrival date	10	Date		x
	A52	Arrival time	6	Numeric		x
	A53	Return to service date	10	Date		x
	A54	Return to service time	6	Numeric		x
	A55	Kilometres	3	Numeric		x
	A56	Electricity	1	Numeric		x
	A57	Gas	1	Numeric		x

TABLE A (CONT.) NATIONAL AND OPTIONAL ITEMS

BLOCK	FIELD	DESCRIPTION	LENGTH OF FIELD	TYPE	NATIONAL ITEM	OPTIONAL ITEM
	A58	Water	1	Numeric		x
	A59	Police	1	Numeric		x
	A60	Ambulance	1	Numeric		x
	A61	State Emergency Service	1	Numeric		x
	A62	Other Fire Service	1	Numeric		x
	A63	Environmental Protection Agency	1	Numeric		x
	A64	Volunteer Rescue Service	1	Numeric		x
	A65	Charitable support agencies	1	Numeric		x
	A66	Government welfare agencies	1	Numeric		x
	A67	Other	25	Alpha		x
	A68	Number of firefighters at station	3	Numeric		x
	A69	Fire name	25	Alpha		x
<b>BLOCK B</b>	B1	Automatic fire alarm number	8	Alpha/ numeric		x
	B2	Fire indicator panel circuit number	3	Alpha/ numeric		x
	B3	Location of detector initiating alarm	2	Numeric	x	
	B4	Level of detector initiating alarm	3	Alpha/ numeric	x	
	B5	Type of detector initiating alarm	2	Numeric	x	
<b>BLOCK C</b>	C1	Type of hazardous material incident	2	Numeric		x
	C2	UN number	4	Numeric		x
	C3	Chemical name	40	Alpha/ numeric		x
	C4	Trade name	40	Alpha/ numeric		x
	C5	State of substance	1	Numeric		x
	C6	Quantity present	7	Numeric		x
	C7	Quantity released	7	Numeric		x
	C8	Container	2	Numeric		x
	C9	Origin of release	1	Numeric		x
	C10	Cause of HazMat incident	2	Numeric		x
	C11	Primary hazard	2	Numeric		x
	C12	Secondary hazard	2	Numeric		x
	C13	Primary action taken	2	Numeric		x
	C14	Personnel decontamination	1	Numeric		x
	C15	Primary respiratory protection	1	Numeric		x
	C16	Protective clothing	1	Numeric		x
	C17	Specialist equipment used	1	Numeric		x
	C18	Wind force	1	Numeric		x
	C19	Wind direction	1	Numeric		x
	C20	Temperature	3	Numeric		x
	C21	Terrain	1	Numeric		x
	C22	Population Density	2	Numeric		x
	C23	Environmental Impact	2	Numeric		x

TABLE A (CONT.) NATIONAL AND OPTIONAL ITEMS

BLOCK	FIELD	DESCRIPTION	LENGTH OF FIELD	TYPE	NATIONAL ITEM	OPTIONAL ITEM
	C24	Transporter name	40	Alpha/ numeric		x
<b>BLOCK D</b>	D1	Number of brigade personnel injured	3	Numeric	x	
	D2	Number of other persons injured	3	Numeric	x	
	D3	Number of brigade personnel fatalities	3	Numeric	x	
	D4	Number of other fatalities	3	Numeric	x	
	D5	Number of persons rescued by the Reporting Authority	3	Numeric	x	
	D7	Rescue type	1	Numeric		x
	D8	Number of persons evacuated	4	Numeric		x
	D9	Date evacuation completed	10	Date		x
	D10	Time evacuation completed	6	Numeric		x
	D11	Evacuation problems	1	Numeric		x
	D12	Date evacuation commenced	10	Date		x
	D13	Time evacuation commenced	6	Numeric		x
	D14	Authority effecting evacuation	2	Numeric		x
	<b>BLOCK E</b>	E1	Area of fire origin	2	Numeric	x
E2		Occupant of ignition area	2	Numeric		x
E3		Activity in ignition area	2	Numeric		x
E4		Form of heat of ignition	3	Numeric	x	
E5		Ignition factor	3	Numeric	x	
E6		Type of material ignited first	2	Numeric	x	
E7		Form of material ignited first	2	Numeric	x	
E8		Equipment involved in ignition	3	Numeric	x	
E9		Year of manufacture	2	Numeric		x
E10		Make	20	Alpha/ numeric		x
E11		Model	20	Alpha/ numeric		x
E12		Serial number	20	Alpha/ numeric		x
E13		Voltage	6	Alpha/nu meric		x
<b>BLOCK F</b>	F1	Major fire fighting force	2	Numeric	x	
	F2	Initial attack	2	Numeric	x	
	F3	Method of initial attack force by Reporting Authority	2	Numeric	x	
	F4	Method of initial attack - Other persons	2	Numeric		x
	F5	Major method of extinguishment	2	Numeric	x	
	F6	Major extinguishing medium	2	Numeric	x	
	F7	Number of portable extinguishers used	3	Numeric		x
	F8	Number of portable pumps used	3	Numeric		x
	F9	Number of hose reels used	3	Numeric		x
	F10	Number of 35-59 mm delivery lines used	3	Numeric		x

TABLE A (CONT.) NATIONAL AND OPTIONAL ITEMS

BLOCK	FIELD	DESCRIPTION	LENGTH OF FIELD	TYPE	NATIONAL ITEM	OPTIONAL ITEM
	F11	Number of 60-70 mm delivery lines used	3	Numeric		x
	F12	Number of monitors used	3	Numeric		x
	F13	Amount of foam concentrate used	6	Numeric		x
	F14	Amount of dry chemical used	6	Numeric		x
	F15	Water supply	1	Numeric		x
	F16	Water supply method	1	Numeric		x
<b>BLOCK G</b>	G1	Date started	10	Date		x
	G2	Time started	4	Numeric		x
	G3	Area burnt	7	Numeric	x	
	G4	Fire Restrictions	1	Numeric		x
	G5	Fire Danger Rating	1	Numeric		x
	G6	Permit	1	Numeric		x
	G7	Vegetation type	1	Numeric	x	
	G8	Area burnt by vegetation type	7	Numeric		x
	G9	Area burnt by land tenure	7	Numeric		x
	G10	Rural property losses	7	Numeric		x
	G10i	Number of houses destroyed or damaged	7	Numeric		x
	G10ii	Number of other buildings destroyed or damaged	7	Numeric		x
	G10iii	Number of vehicles destroyed or damaged	7	Numeric		x
	G10iv	Number of kilometres of fence lines destroyed or damaged	7	Numeric		x
	G10v	Number of tonnes of fodder or hay lost	7	Numeric		x
	G10vi	Number of sheep lost	7	Numeric		x
	G10vii	Number of cattle lost	7	Numeric		x
	G10viii	Number of horses lost	7	Numeric		x
	G10ix	Number of other livestock lost	7	Numeric		x
	G11	Fire prevention	2	Numeric		x
<b>BLOCK H</b>	H1	Estimated dollar loss	14	Numeric		x
	H2	Estimated value of properties	14	Numeric		x
	H3	Estimated value of contents	14	Numeric		x
	H5	Insurance	1	Numeric		x
	H6	Total number of mobile properties involved in fire	3	Numeric		x
	H7	Total number of structures involved in fire	3	Numeric		x
	H8	Property owner's name	20	Alpha		x
	H9	Owner's address number	4	Alpha/ Numeric		x
	H10	Owner's street	20	Apha		x
	H11	Owner's town/suburb or local area	20	Alpha		x
<b>BLOCK J</b>	J1	Mobile property type	2	Numeric	x	
	J2	Year	2	Numeric		x
	J3	Make	10	Alpha/ numeric		x



TABLE A (CONT.) NATIONAL AND OPTIONAL ITEMS

BLOCK	FIELD	DESCRIPTION	LENGTH OF FIELD	TYPE	NATIONAL ITEM	OPTIONAL ITEM	
	J4	Model	10	Alpha/numeric		x	
	J5	Body number	10	Alpha/numeric		x	
	J6	Registration number	10	Alpha/numeric		x	
	J7	State of registration	1	Numeric		x	
BLOCK K	K1	Structure type	1	Numeric		x	
	K2	Construction type	2	Numeric		x	
	K3	Building dimensions	7	Numeric		x	
	K4	Number of levels	2	Numeric		x	
	K5	Wall linings	1	Numeric		x	
	K6	Ceiling linings	1	Numeric		x	
	K7	Level of fire origin	3	Alpha/numeric	x		
	K8	Type of material ignited second	2	Numeric		x	
	K9	Type of material ignited third	2	Numeric		x	
	K10	Type of material ignited fourth	2	Numeric		x	
	K11	Form of material ignited second	2	Numeric		x	
	K12	Form of material ignited third	2	Numeric		x	
	K13	Form of material ignited fourth	2	Numeric		x	
	K14	Type of material contributing most to fire intensity	2	Numeric		x	
	K15	Type of material generating most smoke	2	Numeric		x	
	K16	Form of material contributing most to fire intensity	2	Numeric		x	
	K17	Form of material generating most smoke	2	Numeric		x	
	K18	Factor contributing to flame spread	2	Numeric		x	
	K19	Avenue of smoke travel	1	Numeric		x	
	K20	Extent of flame damage	1	Numeric	x		
	K21	Extent of smoke and heat damage	1	Numeric		x	
	K22	Extent of extinguishing medium damage	1	Numeric		x	
	K23	Volume of fire damage in cubic metres	6	Numeric		x	
	K24	Smoke alarm/detector performance					
	K24i	Presence of smoke alarm/detector	1	Numeric	x		
	K24ii	Alarm/detector power supply	1	Numeric	x		
	K24iii	Operation of smoke alarm/detector	1	Numeric	x		
	K24iv	Effectiveness of smoke alarm/detector	1	Numeric	x		
	K24v	Reason for smoke alarm/detector failure	1	Numeric	x		
	K25	Sprinkler performance	2	Numeric	x		
K26	Factors degrading sprinkler effectiveness	1	Numeric		x		
K27	Number of heads operated	2	Numeric		x		
K28	Air handling system performance	2	Numeric		x		
K29	Extinguishers installed	1	Numeric		x		
K30	Number of extinguishers used by non-fire personnel	2	Numeric		x		

TABLE A (CONT.) NATIONAL AND OPTIONAL ITEMS

BLOCK	FIELD	DESCRIPTION	LENGTH OF FIELD	TYPE	NATIONAL ITEM	OPTIONAL ITEM
	K31	Hose reels installed	1	Numeric		x
	K32	Number of hose reels used by non-fire personnel	2	Numeric		x
	K33	Hydrants installed	1	Numeric		x
	K34	Number of hydrants used by non-fire personnel	2	Numeric		x
	K35	Estimated percentage of property involved on arrival	3	Numeric		x
	K36	Estimated percentage of property saved due to fire fighting operations	3	Numeric		x
	K37	Building Codes of Australia identifier	2	Numeric		x
	K38	Attack time	6	Numeric		x
	K39	Fire area at attack time	7	Numeric		x
	K40	Extinguishment time	6	Numeric		x
	K41	Compartment size	8	Numeric		x

# APPENDIX M: METROPOLITAN FIRE BRIGADE ZONES & SUBURBS

A map showing the MFB zones and the suburbs that they contain

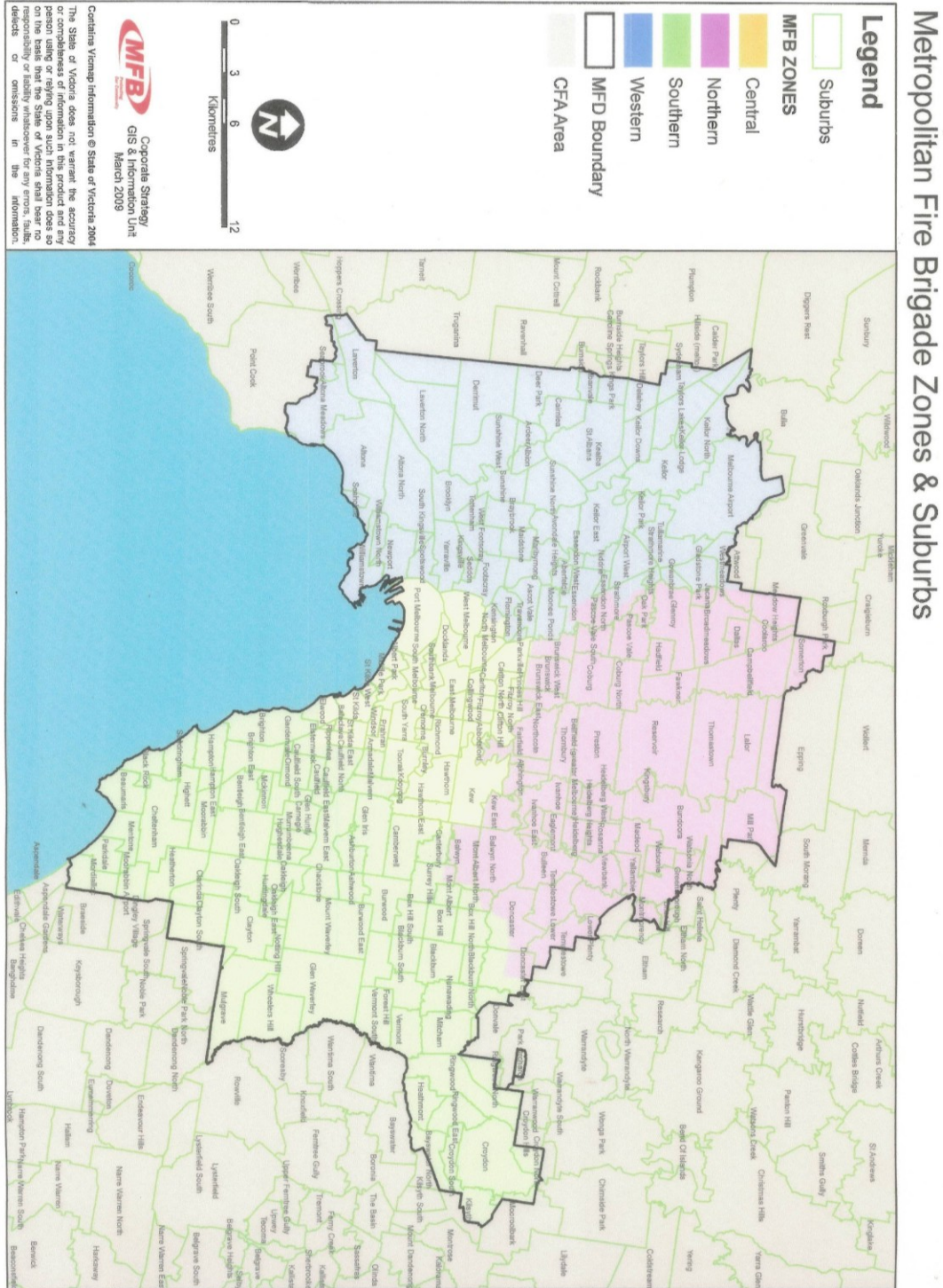

## APPENDIX N: T-TEST TABLES FOR PERCENT OF ELECTRICAL FIRES WITH RESPECT TO ALL FIRES

Table 1 – T-test results for years in which there was a greater statistically significant rate of change in energy consumption per head in Victoria (1974-2006)

Year	%	T-Statistic
1989	14.94%	t(23) = -9.126, p=.000
1993	14.22%	t(23) = -6.602, p=.000
2003	13.62%	t(23) = -4.499, p=.000
2006	13.96%	t(23) = -5.691, p=.000
2007	13.62%	t(23) = -4.499, p=.000
2008	13.30%	t(23) = -3.378, p=.003
2009	14.53%	t(23) = -7.689, p=.000

Table 2 – T-test results for years in which there was a lesser statistically significant rate of change in energy consumption per head in Victoria (1974-2006)

Year	%	T-Statistic
1990	11.52%	t(23) = 2.861, p=.009
1994	11.68%	t(23) = 2.300, p=.031
1995	10.69%	t(23) = 5.770, p=.000
1996	10.84%	t(23) = 5.244, p=.000
1997	9.35%	t(23) = 10.466, p=.000
1998	11.01%	t(23) = 4.648, p=.000
1999	11.47%	t(23) = 3.036, p=.006
2001	10.61%	t(23) = 6.050, p=.000
2002	11.01%	t(23) = 4.648, p=.000

# APPENDIX O: EQUIPMENT INVOLVED IN IGNITION

The individual codes and the description of what ‘equipment involved in ignition’ each division contain.

## E8 EQUIPMENT INVOLVED IN IGNITION

E 1	Area of Fire Origin	E 2	Occupant of Ignition Area	E 3	Activity in Ignition Area	E 4	Form of Heat of Ignition	E 5	Ignition Factor
E 6	Type of Material Ignited First	E 7	Form of Material Ignited First	E 8				E 9	Year of Manufacture
E 10	Make	E 11	Model	E 12	Serial Number	E 13			

### 8.1 Definition

The equipment (if any), which provided the principal heat that caused ignition.

### 8.2 Purpose

This Item provides a classification system for the equipment that provided the heat which started the fire. When linked with the type and extent of the fire, and the form of the heat of ignition and ignition factor, problems related to equipment design or operational procedures may become evident.

### 8.3 Implementation

Record the type of equipment responsible for providing the heat that caused the ignition. If no equipment was responsible, use **code 980**.

Table E8 details the divisions, codes and equipment definitions for this field. Select the most appropriate code from this table and complete the entry.

**Table E8 Equipment Involved in Ignition Codes**

DIVISION	CODE	EQUIPMENT DEFINITIONS
1		<b>HEATING SYSTEMS - COMBINATION HEATING AND COOLING SYSTEMS ARE TO BE CODED UNDER 3 AIR CONDITIONING, REFRIGERATION EQUIPMENT</b>
	110	Central heating unit. Included are central furnaces and power burners or stokers having an air supply and a return air system. Excluded are industrial furnaces (710)
	120	Water heater (hot water service)
	130	Fixed, stationary local heating unit. Included are wall furnaces, unit heaters, room heaters, fixed heating stoves, pot belly stoves, slow combustion stove or heaters, gas fires oil heaters, and heaters not intended for duct connection
	140	Indoor open fireplace
	150	Portable local heating unit. Included are space heaters, room heaters, and portable industrial heaters
	160	Chimney, gas vent flue. Included are masonry, factory built and metal chimneys
	170	Chimney connector, vent connector (connects firebox to chimney)
	180	Heat transfer system. Included are steam lines, heating pipes, and hot air ducts
	190	Heating systems not classified above
100	Heating systems; insufficient information to classify further	

**Table E8 (Cont.) Equipment Involved In Ignition Codes**

	550	Separate motor, generator. Included are those not an integral part of an appliance and those separated by a belt or chain from the equipment they drive, or which drives them
	560	Hand tools. Included are electric chain saws, electric lawn-mowers and drills
	571	Electric blankets
	572	Irons
	573	Electric soldering irons
	574	Hair dryer
	581	Portable cooling fan
	582	Evaporative coolers
	591	Ceiling fans
	592	Exhaust fans including range hoods
	593	Dishwashers
	590	Appliances, equipment not classified above
	500	Appliances, equipment; insufficient information available to classify further
<b>6</b>		<b>SPECIAL EQUIPMENT</b>
	610	Electronic equipment (other than computers). Excluded are separate monitors or visual display units (511)
	611	Computer equipment. Included are computer, central processing unit and keyboard
	612	Radar
	613	X-ray
	614	Telephone and transmitter equipment
	620	Vending machine, water cooler
	630	Other office machine
	631	Photocopiers
	632	Typewriters
	633	Facsimile machines
	640	Biomedical equipment, device. Included are anaesthetising machines
	650	Separate pump, compressor
	660	Internal combustion engine. Included is an exhaust system
	670	Conveyer
	680	Printing press
	690	Special equipment not classified above
	600	Special equipment; insufficient information available to classify further
<b>7</b>		<b>PROCESSING EQUIPMENT</b>
	710	Furnace, oven, kiln. Excluded are those used for food preparation (division 2) and heat treating (730)
	720	Casting, moulding, forging equipment. Included are glass-forming machines and die-casting machines
	730	Heat-treating equipment. Included are quench tanks and associated equipment
	740	Working, shaping machine. Included are sawing, planing, grinding, machining, forming, opening, picking, carding and weaving machines
	750	Coating machine. Included are asphalt-saturating and rubber-spreading machines
	760	Painting equipment. Included are dipping, spraying and flow-coating equipment
	770	Chemical process equipment. Included are digesters, reactors, black liquor recovery units, and distilling equipment
	780	Waste recovery equipment. Included are garneting and solvent recovery equipment
	790	Processing equipment not classified above
	700	Processing equipment; insufficient information available to classify further
<b>8</b>		<b>SERVICE, MAINTENANCE EQUIPMENT</b>
	810	Incinerator
	820	Bearing, brake
	830	Rectifier, charger. Included are invertors and batteries
	840	Tarpot, tar kettle
	850	Arc, oil lamp. Included are gas mantles and arc-lighted motion picture projectors
	860	Lift

Table E8 (Cont.) Equipment Involved In Ignition Codes

<b>2</b>		<b>COOKING EQUIPMENT</b>
	210	Fixed stationary surface unit. Included are stove hot plates. Excluded are charcoal grills (260)
	220	Fixed, stationary oven. Included are rotisseries, built in microwave ovens
	230	Fixed, stationary food warming appliance. Included are coffee urns, bain-marie, warming drawers and warming tables
	240	Fixed deep fat fryer
	250	Portable cooking appliances, warming unit. Included are portable microwave ovens and toasters
	260	Open fired grill. Included are charcoal, wood or gas fired
	261	Outdoor cooking equipment. Included are barbecues, webbers and hibachi
	270	Grease hood, duct
	290	Cooking equipment not classified above
	200	Cooking equipment; insufficient information available to classify further
<b>3</b>		<b>AIR CONDITIONING, REFRIGERATION EQUIPMENT- INCLUDED ARE COMBINATION COOLING AND HEATING SYSTEMS. EXCLUDED ARE THE CORDS AND PLUGS (470)</b>
	310	Central air conditioning, refrigeration equipment
	320	Water cooling device, tower
	330	Fixed, stationary local refrigerator unit. Included are cold boxes, freezers and refrigerators.
	340	Fixed, stationary local air conditioning unit
	350	Portable air conditioning, refrigeration unit. Included are dehumidifiers
	360	Portable cooling fans
	370	Fixed stationary cooling, exhaust fans
	390	Air conditioning, refrigeration equipment not classified above
	300	Air conditioning, refrigeration equipment; insufficient information available to classify further
<b>4</b>		<b>ELECTRICAL DISTRIBUTION EQUIPMENT EXCLUDED ARE HEATING, COOKING, AIR CONDITIONING AND REFRIGERATION EQUIPMENT (DIVISIONS 1, 2 AND 3)</b>
	410	Fixed wiring. Included are power lines, junction boxes, cables and wiring in conduits
	420	Transformer, associated over-current or disconnect equipment
	430	Meter, meter box
	440	Power switch gear, over-current protection devices. Included are panel boards or switchboards, fuses and circuit breakers
	450	Switch, receptacle, outlet
	460	Lighting fixture, lamp-holder, ballast, sign.
	470	Cord, plug Included are <i>temporary</i> extension cords, appliance cords and plugs
	480	Lamp, light bulb
	490	Electrical distribution equipment not classified above
	400	Electrical distributed equipment; insufficient information available to classify further
<b>5</b>		<b>APPLIANCES, EQUIPMENT - TELEVISION, RADIO, PHONOGRAPH-INCLUDED ARE TAPE RECORDERS, SOUND OR PICTURE RECEIVING EQUIPMENT AND REPRODUCTION EQUIPMENT</b>
	511	Television, monitor, computer monitor.
	512	Video recorder including ancillary equipment
	513	Radio
	514	Tape recorders
	515	Stereo equipment
	516	Compact disk player
	520	Dryer. Included are coin-operated dryers and extractors removing any liquid or solvent
	530	Washing machine. Included are coin-operated machines in laundries
	540	Floor care equipment
	541	Vacuum cleaners

## APPENDIX P: SHORT-CIRCUITS AND OTHER ELECTRICAL FAILURES COMBINED DATA TABLES AND FIGURES

Time	Number of Fires	Average per Year
0:00	197	8.21
1:00	154	6.42
2:00	138	5.75
3:00	110	4.58
4:00	113	4.71
5:00	86	3.58
6:00	117	4.88
7:00	170	7.08
8:00	222	9.25
9:00	263	10.96
10:00	261	10.88
11:00	244	10.17
12:00	264	11.00
13:00	273	11.38
14:00	260	10.83
15:00	253	10.54
16:00	314	13.08
17:00	380	15.83
18:00	406	16.92
19:00	375	15.63
20:00	331	13.79
21:00	383	15.96
22:00	309	12.88
23:00	235	9.79
Standard Deviation		3.92351
Mean		10.17

Month	Number of Fires	Average per Year
January	470	19.583
February	407	16.958
March	399	16.625
April	430	17.917
May	578	24.083
June	589	24.542
July	599	24.958
August	599	24.958
September	466	19.417
October	419	17.458
November	444	18.5
December	458	19.083
Standard Deviation		3.30465
Mean		20.340278



## APPENDIX Q: SHORT-CIRCUITS DATA TABLES AND FIGURES

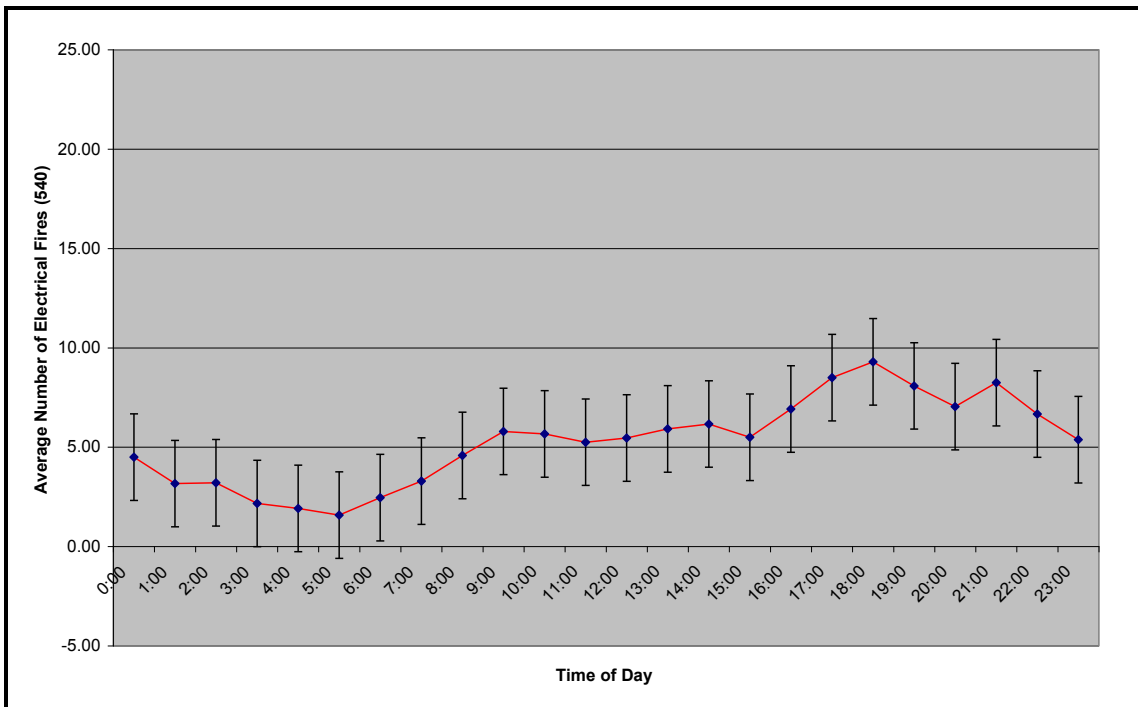
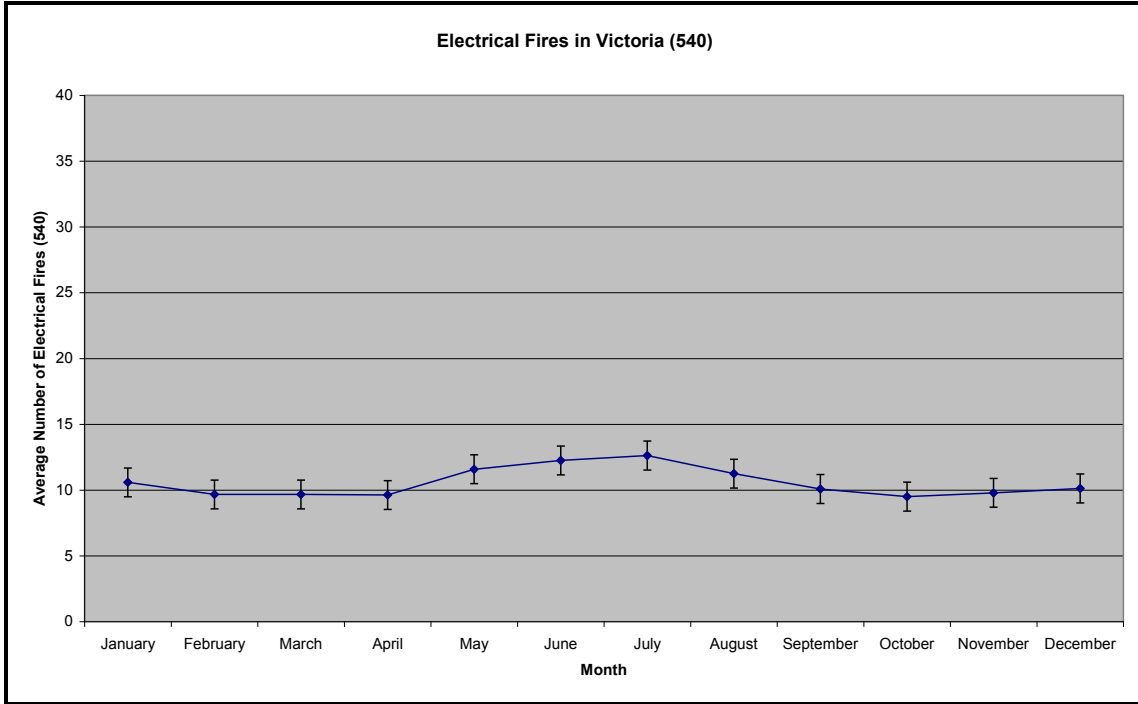

Month	Number of Fires	Average per Year
January	254	10.583
February	232	9.667
March	232	9.667
April	231	9.625
May	278	11.583
June	294	12.250
July	303	12.625
August	270	11.250
September	242	10.083
October	228	9.500
November	235	9.792
December	243	10.125
Standard Deviation		1.09730
Mean		10.56250

Time	Number of Fires	Average per Year
0:00	108	4.500
1:00	76	3.167
2:00	77	3.208
3:00	52	2.167
4:00	46	1.917
5:00	38	1.583
6:00	59	2.458
7:00	79	3.292
8:00	110	4.583
9:00	139	5.792
10:00	136	5.667
11:00	126	5.250
12:00	131	5.458
13:00	142	5.917
14:00	148	6.167
15:00	132	5.500
16:00	166	6.917
17:00	204	8.500
18:00	223	9.292
19:00	194	8.083
20:00	169	7.042
21:00	198	8.250
22:00	160	6.667
23:00	129	5.375
Standard Deviation		2.17672
Mean		5.28125

# APPENDIX R: OTHER ELECTRICAL FAILURES DATA TABLES AND FIGURES

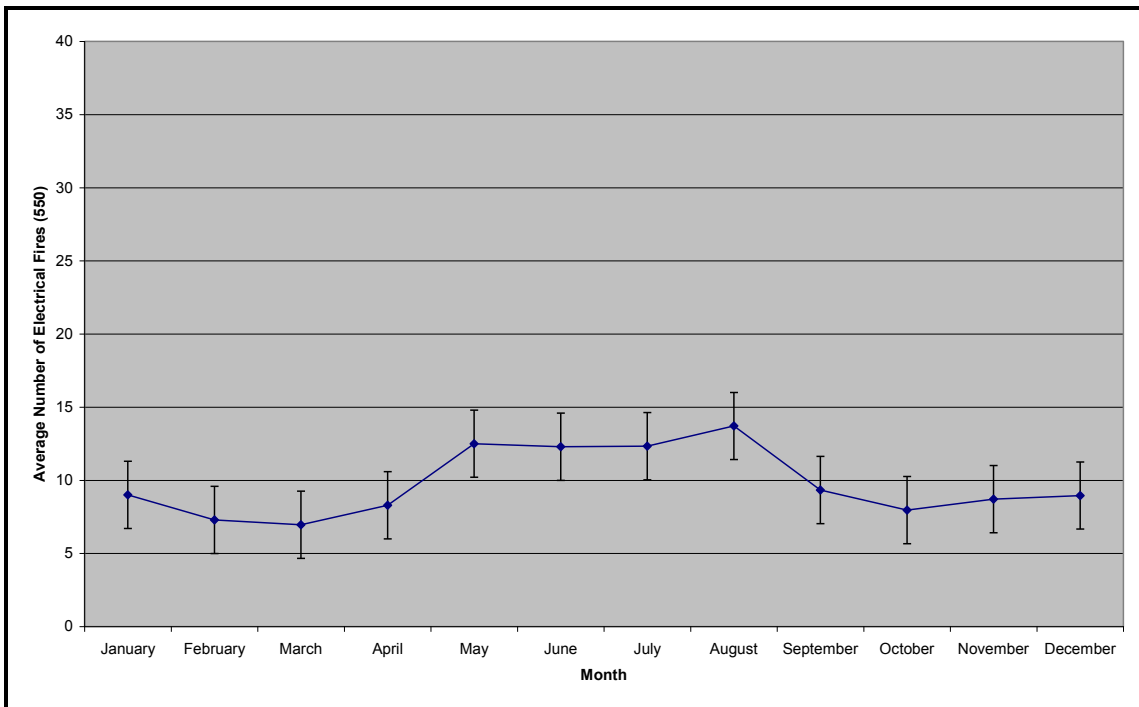
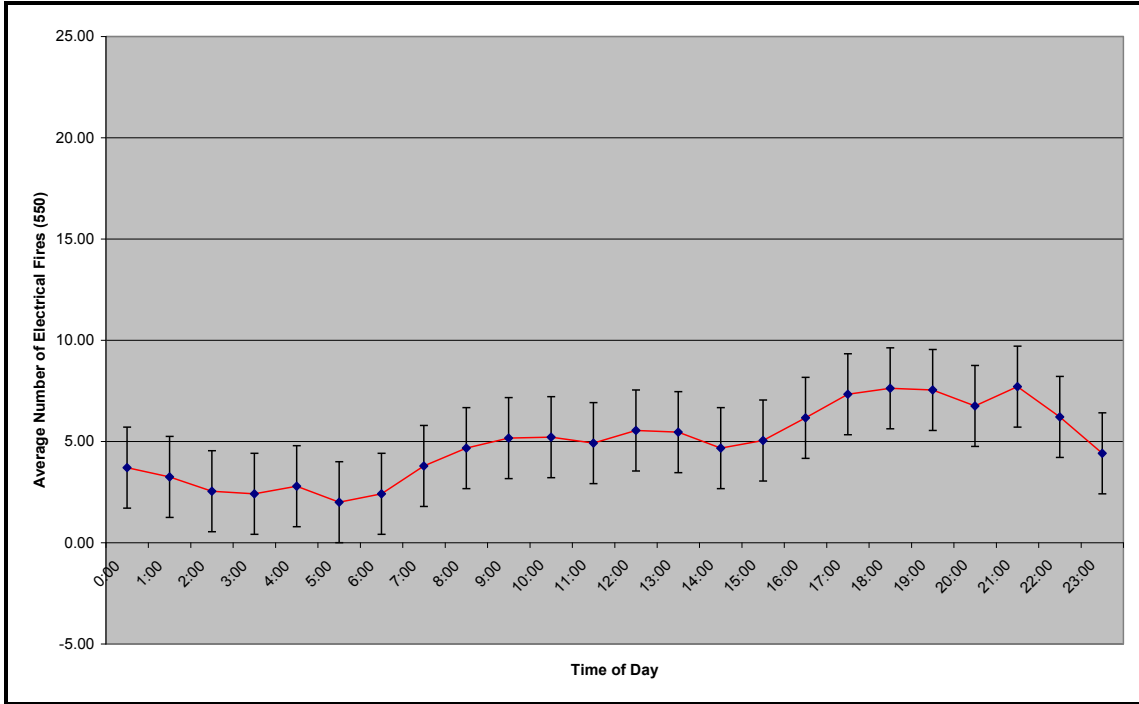

Month	Number of Fires	Average per Year
January	216	9
February	175	7.292
March	167	6.958
April	199	8.292
May	300	12.500
June	295	12.292
July	296	12.333
August	329	13.708
September	224	9.333
October	191	7.958
November	209	8.708
December	215	8.958
Standard Deviation		2.29578
Mean		9.20224

Time	Number of Fires	Average per Year
0:00	89	3.71
1:00	78	3.25
2:00	61	2.54
3:00	58	2.42
4:00	67	2.79
5:00	48	2.00
6:00	58	2.42
7:00	91	3.79
8:00	112	4.67
9:00	124	5.17
10:00	125	5.21
11:00	118	4.92
12:00	133	5.54
13:00	131	5.46
14:00	112	4.67
15:00	121	5.04
16:00	148	6.17
17:00	176	7.33
18:00	183	7.63
19:00	181	7.54
20:00	162	6.75
21:00	185	7.71
22:00	149	6.21
23:00	106	4.42
Standard Deviation		1.77325
Mean		4.88889

**APPENDIX S: ELECTRICAL FIRES FOR SUMMER & WINTER MONTHS  
(540, 550, AND 540/550) DATA TABLES AND FIGURES**

Winter both		
Time	Total Fires	Average Fires per Year
0:00	58	2.42
1:00	34	1.42
2:00	51	2.13
3:00	32	1.33
4:00	37	1.54
5:00	28	1.17
6:00	36	1.50
7:00	63	2.63
8:00	67	2.79
9:00	72	3.00
10:00	89	3.71
11:00	73	3.04
12:00	67	2.79
13:00	67	2.79
14:00	84	3.50
15:00	80	3.33
16:00	97	4.04
17:00	115	4.79
18:00	130	5.42
19:00	120	5.00
20:00	114	4.75
21:00	123	5.13
22:00	94	3.92
23:00	72	3.00

Winter 550		
Time	Total Fires	Average Fires per Year
0:00	31	1.29
1:00	13	0.54
2:00	23	0.96
3:00	25	1.04
4:00	24	1.00
5:00	15	0.63
6:00	19	0.79
7:00	38	1.58
8:00	37	1.54
9:00	36	1.50
10:00	46	1.92
11:00	39	1.63
12:00	37	1.54
13:00	37	1.54
14:00	33	1.38
15:00	45	1.88
16:00	49	2.04
17:00	51	2.13
18:00	61	2.54
19:00	58	2.42
20:00	67	2.79
21:00	58	2.42
22:00	51	2.13
23:00	36	1.50

Winter 540		
Time	Total Fires	Average Fires per Year
0:00	27	1.13
1:00	21	0.88
2:00	28	1.17
3:00	7	0.29
4:00	13	0.54
5:00	13	0.54
6:00	17	0.71
7:00	25	1.04
8:00	30	1.25
9:00	36	1.50
10:00	43	1.79
11:00	34	1.42
12:00	30	1.25
13:00	30	1.25
14:00	51	2.13
15:00	35	1.46
16:00	48	2.00
17:00	64	2.67
18:00	69	2.88
19:00	62	2.58
20:00	47	1.96
21:00	65	2.71
22:00	43	1.79
23:00	36	1.50

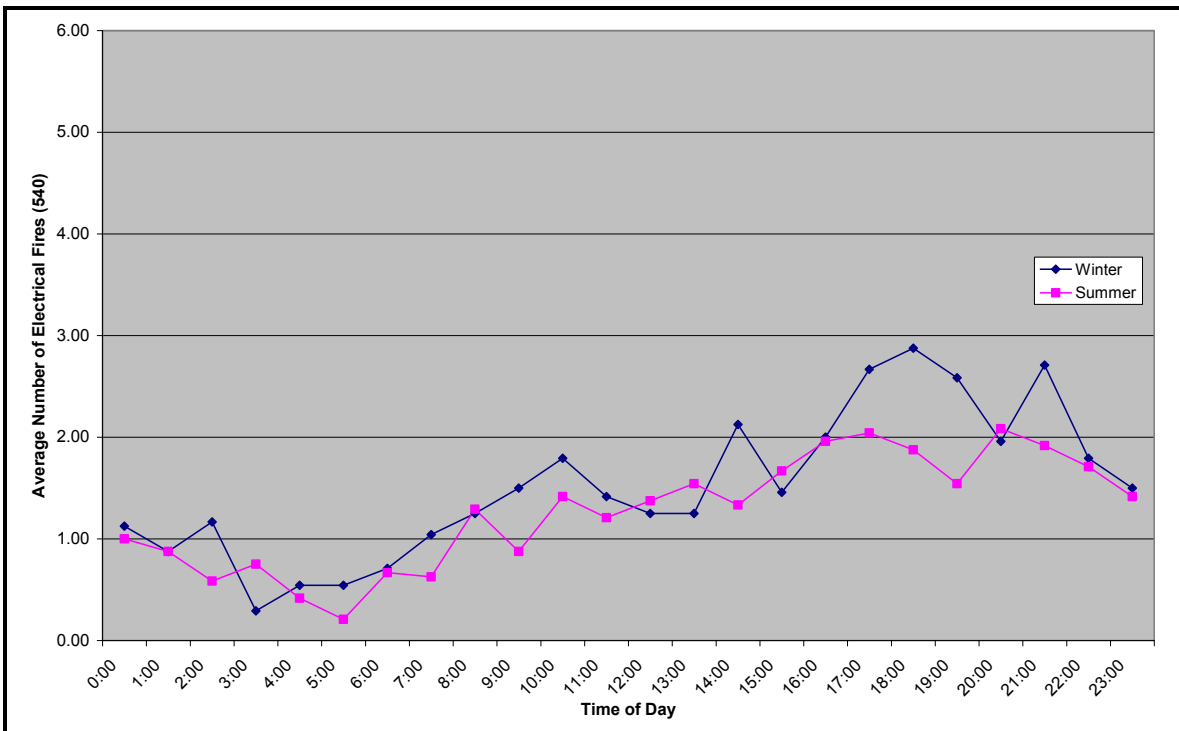
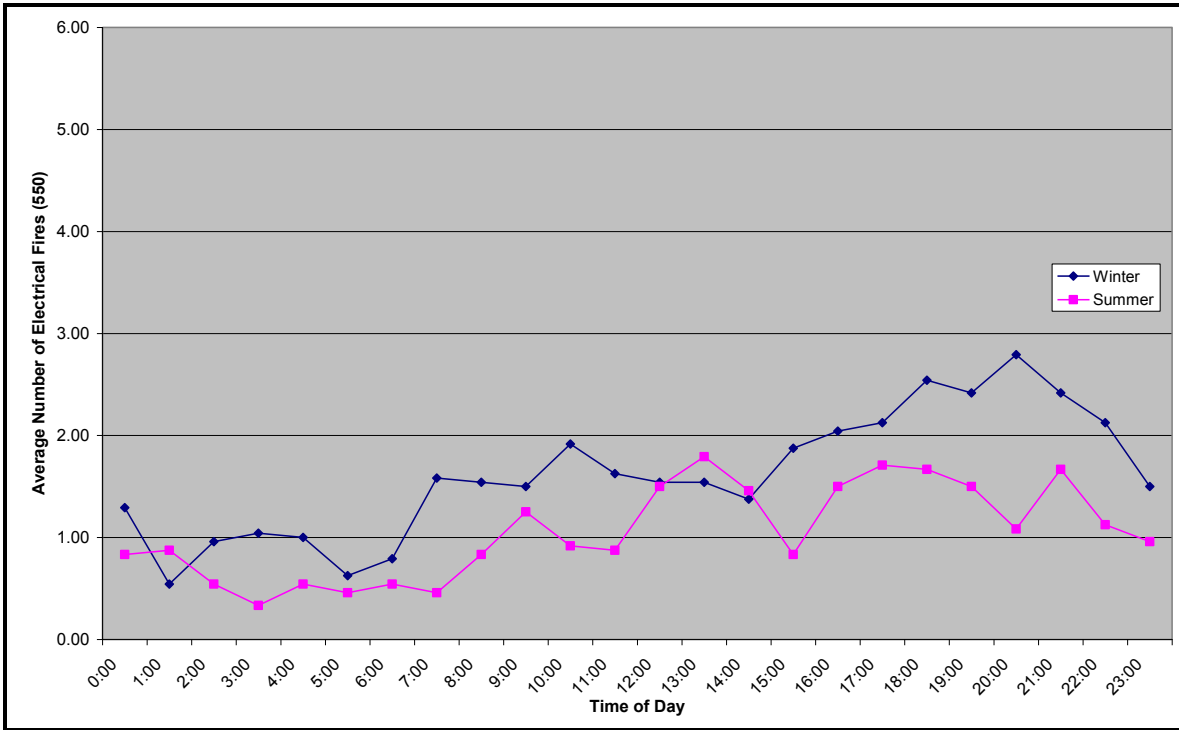

## APPENDIX T: SHORT CIRCUITS AND OTHER ELECTRICAL FAILURES COMBINED: WEEKEND AND WEEKDAY DATA TABLES

Weekday			
Time	Number of Fires	Average per Day	Average per Year
0:00	133	26.6	1.11
1:00	100	20	0.83
2:00	99	19.8	0.83
3:00	71	14.2	0.59
4:00	77	15.4	0.64
5:00	53	10.6	0.44
6:00	90	18	0.75
7:00	136	27.2	1.13
8:00	161	32.2	1.34
9:00	184	36.8	1.53
10:00	191	38.2	1.59
11:00	185	37	1.54
12:00	178	35.6	1.48
13:00	193	38.6	1.61
14:00	175	35	1.46
15:00	182	36.4	1.52
16:00	218	43.6	1.82
17:00	260	52	2.17
18:00	281	56.2	2.34
19:00	268	53.6	2.23
20:00	251	50.2	2.09
21:00	271	54.2	2.26
22:00	221	44.2	1.84
23:00	164	32.8	1.37

Weekend			
Time	Number of Fires	Average per Day	Average per Year
0:00	64	32	1.33
1:00	54	27	1.13
2:00	39	19.5	0.81
3:00	39	19.5	0.81
4:00	36	18	0.75
5:00	33	16.5	0.69
6:00	27	13.5	0.56
7:00	34	17	0.71
8:00	61	30.5	1.27
9:00	79	39.5	1.65
10:00	70	35	1.46
11:00	59	29.5	1.23
12:00	86	43	1.79
13:00	80	40	1.67
14:00	85	42.5	1.77
15:00	71	35.5	1.48
16:00	96	48	2.00
17:00	120	60	2.50
18:00	125	62.5	2.60
19:00	107	53.5	2.23
20:00	80	40	1.67
21:00	112	56	2.33
22:00	88	44	1.83
23:00	71	35.5	1.48

## APPENDIX U: SHORT CIRCUITS: WEEKEND AND WEEKDAY DATA TABLES AND FIGURES

Weekday			
Time	Number of Fires	Average per Day	Average per Year
0:00	73	14.6	0.61
1:00	50	10	0.42
2:00	55	11	0.46
3:00	31	6.2	0.26
4:00	34	6.8	0.28
5:00	26	5.2	0.22
6:00	45	9	0.38
7:00	60	12	0.50
8:00	78	15.6	0.65
9:00	98	19.6	0.82
10:00	100	20	0.83
11:00	96	19.2	0.80
12:00	90	18	0.75
13:00	99	19.8	0.83
14:00	102	20.4	0.85
15:00	98	19.6	0.82
16:00	116	23.2	0.97
17:00	135	27	1.13
18:00	154	30.8	1.28
19:00	136	27.2	1.13
20:00	130	26	1.08
21:00	142	28.4	1.18
22:00	114	22.8	0.95
23:00	94	18.8	0.78

Weekend			
Time	Number of Fires	Average per Day	Average per Year
0:00	35	17.5	0.73
1:00	26	13	0.54
2:00	22	11	0.46
3:00	21	10.5	0.44
4:00	12	6	0.25
5:00	12	6	0.25
6:00	14	7	0.29
7:00	19	9.5	0.40
8:00	32	16	0.67
9:00	41	20.5	0.85
10:00	36	18	0.75
11:00	30	15	0.63
12:00	41	20.5	0.85
13:00	43	21.5	0.90
14:00	46	23	0.96
15:00	34	17	0.71
16:00	50	25	1.04
17:00	69	34.5	1.44
18:00	69	34.5	1.44
19:00	58	29	1.21
20:00	39	19.5	0.81
21:00	56	28	1.17
22:00	46	23	0.96
23:00	35	17.5	0.73



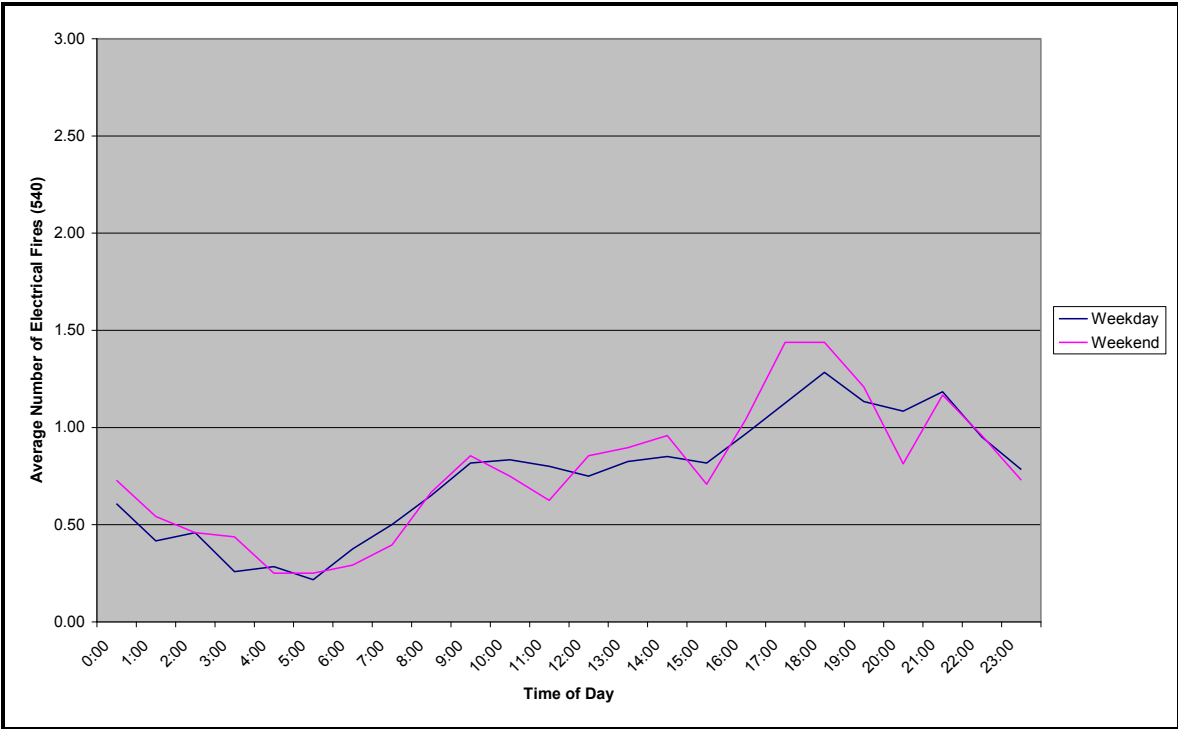

## APPENDIX V: OTHER ELECTRICAL FAILURES: WEEKEND AND WEEKDAY DATA TABLES AND FIGURES

Weekday			
Time	Number of Fires	Average per Day	Average per Year
0:00	60	12	0.50
1:00	50	10	0.42
2:00	44	8.8	0.37
3:00	40	8	0.33
4:00	43	8.6	0.36
5:00	27	5.4	0.23
6:00	45	9	0.38
7:00	76	15.2	0.63
8:00	83	16.6	0.69
9:00	86	17.2	0.72
10:00	91	18.2	0.76
11:00	89	17.8	0.74
12:00	88	17.6	0.73
13:00	94	18.8	0.78
14:00	73	14.6	0.61
15:00	84	16.8	0.70
16:00	102	20.4	0.85
17:00	125	25	1.04
18:00	127	25.4	1.06
19:00	132	26.4	1.10
20:00	121	24.2	1.01
21:00	129	25.8	1.08
22:00	106	21.2	0.88
23:00	70	14	0.58

Weekend			
Time	Number of Fires	Average per Day	Average per Year
0:00	29	14.5	0.6041667
1:00	28	14	0.5833333
2:00	17	8.5	0.3541667
3:00	18	9	0.375
4:00	24	12	0.5
5:00	21	10.5	0.4375
6:00	13	6.5	0.2708333
7:00	15	7.5	0.3125
8:00	29	14.5	0.6041667
9:00	38	19	0.7916667
10:00	34	17	0.7083333
11:00	29	14.5	0.6041667
12:00	45	22.5	0.9375
13:00	37	18.5	0.7708333
14:00	39	19.5	0.8125
15:00	37	18.5	0.7708333
16:00	46	23	0.9583333
17:00	51	25.5	1.0625
18:00	56	28	1.1666667
19:00	49	24.5	1.0208333
20:00	41	20.5	0.8541667
21:00	56	28	1.1666667
22:00	42	21	0.875
23:00	36	18	0.75

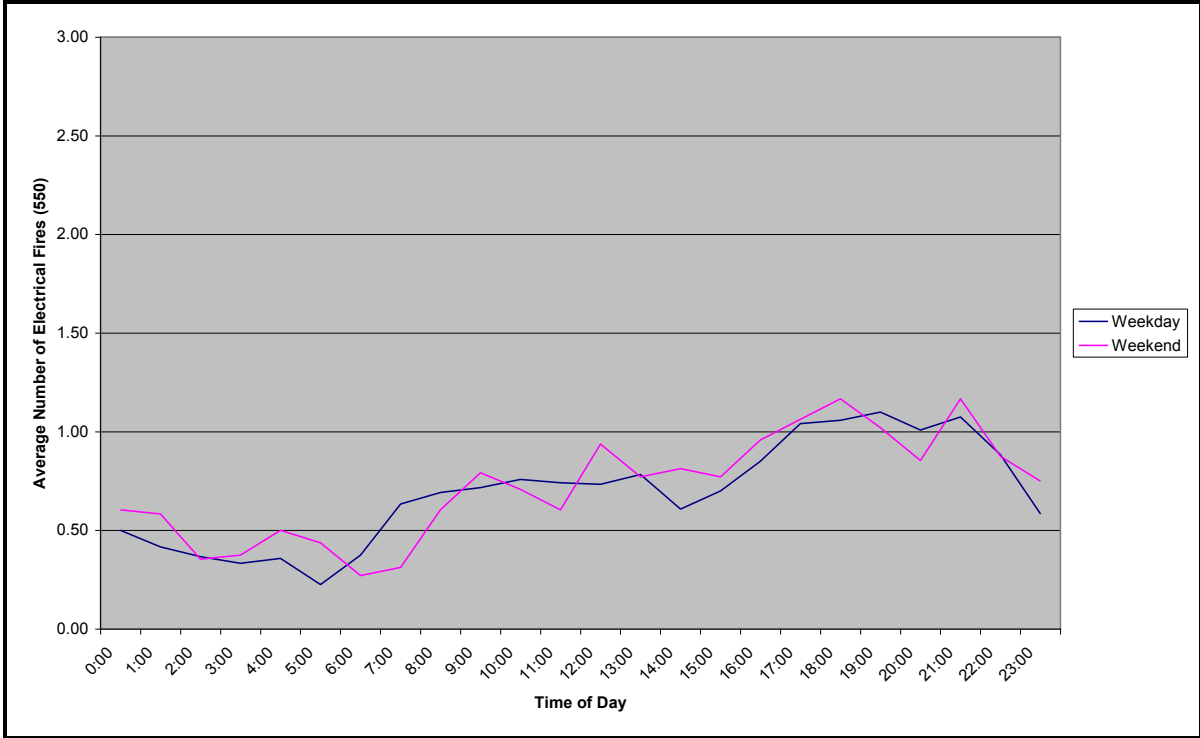

## APPENDIX W: HEAT OF IGNITION BREAKDOWN AND DATA TABLE

Appendix W shows the breakdown of the heat of ignition for short-circuits and other electrical failures. The categories were broken up into four categories based on if AFCIs could prevent the arc from igniting the fuel causing a fire.

Cause of Arc Not Specified	173	290	Other electrical failure.	Heat from electrical equipment arcing, overloaded not classified above.
	961	200	Other electrical failure.	Heat from electrical equipment arcing, overloaded; insufficient information available to
	2362	240	Other electrical failure.	Unspecified short-circuit arc.
Cause of Fire Not Arcing	15	120	Other electrical failure.	Heat from gas-fuelled equipment.
	3	140	Other electrical failure.	Heat from liquid-fuelled equipment.
	2	160	Other electrical failure.	Heat from solid-fuelled equipment.
	5	170	Short-circuit, ground fault.	Spark, ember, flame escaping from liquid-fuelled equipment.
	3	180	Other electrical failure.	Heat from equipment; fuel not known.
	1	190	Other electrical failure.	Heat from fuel-fired, fuel-powered object not classified above.
	249	270	Other electrical failure.	Heat from overloaded equipment.
	1	330	Other electrical failure.	Pipe.
	1	470	Other electrical failure.	Open fires, insufficient information available to classify further.
	3	490	Short-circuit, ground fault.	Heat from open flame, spark
	8	500	Short-circuit, ground fault.	Heat from hot objects or friction
	1	510	Other electrical failure.	Heat, spark from friction.
	4	520	Other electrical failure.	Molten, hot material.
	71	560	Short-circuit, ground fault.	Heat from improperly operating electrical equipment.
	31	560	Other electrical failure.	Heat from properly operating electrical equipment.
	5	590	Other electrical failure.	Heat from hot objects or friction not classified above.
	1	730	Short-circuit, ground fault.	Lightning discharge.
	1	890	Short-circuit, ground fault.	Heat spreading from another hostile fire
	1	910	Other electrical failure.	Microwaves.
	15	990	Other electrical failure.	Other form of heat of ignition not classified in any division above.
	46			Blank
Arcs AFCI's Protect	381	210	Short-circuit, ground fault.	Water caused short-circuit arc.
	651	230	Short-circuit, ground fault.	Short-circuit arc from defective, worn insulation.
AFCI's Do Not Protect	190	220	Short-circuit, ground fault.	Short-circuit arc from mechanical damage.

Cause of Arc Not Specified	67.4253
Cause of Fire Not Arcing	9.006750241
Arcs AFCI's Protect	19.90356798
AFCI's Do Not Protect	3.664416586

## APPENDIX X: LINEAR REGRESSION OF INCOME VS. FIRES

Average weekly Income by Electrical Fires per 100,000 head (1986-2009)

### Linear Regression Analysis

R	R Square	Adjusted R Square	Std. Error of the Estimate	Change Statistics				
				R Square Change	F Change	df1	df2	Sig. F Change
.370	.137	.117	\$199.357	.137	7.118	1	45	.011