



# Green Production

*LED Application*

A Major Qualifying Project Report

Submitted to the Faculty

of the

WORCESTER POLYTECHNIC INSTITUTE

in partial fulfillment of the requirements for the

Degree of Bachelor of Science

in Mechanical Engineering

Submitted by:

WPI Project Team

with partners from HUST

---

Edward Lee

Bo Li

---

Christopher Szlatenyi

Fu Gaosheng

Long Jing

Pan Dan

Submitted to:

Major Advisors:

Prof. Yiming(Kevin) Rong

Prof. Liang Gao

August 31, 2009

## Abstract

Advances in light emitting diode (LED) technology have made LEDs a viable option for energy efficient illumination. Light fixtures utilizing LEDs were designed and prototyped to replace incandescent factory task lights and fluorescent stairway lights at a Central Industrial Supply factory in Wuxi, China. Emphasis was placed on LED selection, circuit design, and heat dissipation. Energy savings of 85.2% for the factory task lights and 38.9% for the stairway lights were achieved with a combined payback period of 2.5 years.

## Table of Contents

|  |     |
|--|-----|
| Abstract .....                                 | ii  |
| Table of Figures .....                         | iii |
| Table of Tables .....                          | iv  |
| Glossary of Terms .....                        | 1   |
| Chapter 1: Introduction .....                  | 2   |
| Chapter 2: Background .....                    | 4   |
| 2.1 CIS .....                                  | 4   |
| 2.1.1 The Problem .....                        | 4   |
| 2.2 Photometry .....                           | 5   |
| 2.3 LEDs .....                                 | 6   |
| 2.3.1 History .....                            | 6   |
| 2.3.2 Technology .....                         | 7   |
| 2.3.3 Applications .....                       | 7   |
| 2.3.4 LEDs for illumination .....              | 8   |
| 2.4 Premature LED Degradation .....            | 9   |
| 2.5 Comparison to Previous MQPs .....          | 10  |
| Chapter 3: Methodology .....                   | 11  |
| 3.1 Circuit Design .....                       | 12  |
| 3.1.1 Integrated Circuit .....                 | 13  |
| 3.1.2 Simple Circuits .....                    | 14  |
| 3.1.3 Comparison .....                         | 17  |
| 3.2 Factory Task Lights .....                  | 17  |
| 3.2.1 Initial Measurements .....               | 18  |
| 3.2.2 LED Selection .....                      | 20  |
| 3.2.3 Fixture Design .....                     | 21  |
| 3.3 Stairway Lights .....                      | 29  |
| 3.3.1 Initial Measurements .....               | 29  |
| 3.3.2 Cause of Premature LED Degradation ..... | 29  |
| 3.3.3 Enhance Stairway Lighting .....          | 30  |
| Chapter 4: Results .....                       | 34  |
| 4.1 Premature LED Degradation .....            | 34  |
| 4.2 Prototypes .....                           | 35  |
| 4.2.1 Factory Task Light .....                 | 35  |
| 4.2.2 400t Machine Light .....                 | 38  |
| 4.2.3 Stairway Light .....                     | 40  |
| 4.3 Energy and Cost Analysis .....             | 41  |

|  |    |
|--|----|
| 4.3.1 LED Factory Task Light .....   | 41 |
| 4.3.2 LED Stairway Light .....   | 43 |
| 4.3.3 Total Lighting Cost Savings .....  | 45 |
| 4.3.4 Cost Projection.....   | 46 |
| 4.4 Light Quality .....  | 46 |
| 4.4.1 Factory Task Light.....  | 46 |
| 4.4.2 Stairway Light.....  | 48 |
| Chapter 5: Conclusion.....   | 49 |
| 5.1 Future Recommendations.....  | 49 |
| 5.1.1 LED Light Fixture Design .....   | 49 |
| 5.1.2 Implementation at CIS .....  | 50 |
| Acknowledgements.....  | 51 |
| References.....  | 52 |
| Appendix A: Photometric Quantities and Relationships .....                         | 53 |
| Appendix B: Initial Factory Task Light Quality Assessment.....                     | 54 |
| Appendix C: Procedure for Photometric Tests .....                                  | 55 |
| Appendix D: Photometric Data of Existing Factory Task Light .....                  | 56 |
| Appendix E: Photometric Data of LED Factory Task Light Prototype.....              | 58 |
| Appendix F: Photometric Data of 400t Machine LED Factory Task Light Prototype..... | 60 |
| Appendix G: Available LED Comparison.....  | 62 |
| Appendix H: 1W High Power LED LSP-830CW1B Datasheet.....                           | 63 |
| Appendix I: Material Comparison Data.....  | 65 |
| Appendix J: Final Prototype Factory Task Light Quality Assessment.....             | 66 |

## Table of Figures

|   |    |
|---|----|
| Figure 1: LED Light Fixture in Stairway.....  | 4  |
| Figure 2: Existing Task Light Quality on an 80t Machine .....                       | 5  |
| Figure 3: Increasing Light Output of LEDs Over Time .....                           | 7  |
| Figure 4: Gantt Chart for Time at CIS .....   | 11 |
| Figure 5: Typical Current-Voltage Relationship of a Diode .....                     | 12 |
| Figure 6: Constant Current Circuit.....   | 13 |
| Figure 7: Schematic of Typical PT4107 LED Drive Circuit .....                       | 13 |
| Figure 8: Transformer and Rectifier Circuit .....                                   | 14 |
| Figure 9: E Circuit Schematic.....  | 15 |
| Figure 10: F Circuit Schematic .....  | 16 |
| Figure 11: Existing Mechanical Structure .....                                      | 22 |
| Figure 12: Circuit Box .....  | 22 |
| Figure 13: Material Selection Graph.....  | 23 |
| Figure 14: Possible Materials Comparison .....                                      | 24 |
| Figure 15: 1W LED Lifespan as a Function of Junction Temperature.....               | 25 |
| Figure 16: LED Light Output as a Function of Junction Temperature.....              | 25 |
| Figure 17: Power LED Mounted on Heat Sink Cross Section.....                        | 26 |
| Figure 18: Thermal Resistance Model of Light Fixture .....                          | 27 |
| Figure 19: Factory Task Light Heat Sink Model .....                                 | 28 |
| Figure 20: Thermal Resistance of Approximation o Heat Sink Design .....             | 28 |
| Figure 21: Final Circuit Design for Stairway Light Fixture .....                    | 33 |
| Figure 22: First Prototype .....  | 35 |
| Figure 23: Second Prototype.....  | 38 |
| Figure 24: 400t Machine and Existing Light .....                                    | 39 |
| Figure 25: 400t Machine Light Prototype.....  | 39 |
| Figure 26: 400t Machine and LED Light Prototype .....                               | 40 |
| Figure 27: Existing vs. LED Prototype Factory Task Lighting Cost Over 5 Years ..... | 43 |
| Figure 28: Existing vs. LED Prototype Stairway Lighting Cost Over 5 Years .....     | 45 |
| Figure 29: Factory Task Light Beam Distribution Comparison .....                    | 47 |
| Figure 30: Factory Task Light Visual Comparison .....                               | 48 |

## Table of Tables

|   |    |
|---|----|
| Table 1: Circuit Comparison.....                            | 17 |
| Table 2: Factory Task Light Tally for Factory One.....      | 18 |
| Table 3: Illumination for 0.5 W LEDs at 3 m.....            | 31 |
| Table 4: Illumination of 1 W LEDs at 3 m.....               | 32 |
| Table 5: 0.5 W and 1 W LED Comparison.....                  | 33 |
| Table 6: Factory Task Light Prototype Cost.....             | 42 |
| Table 7: Stairway Light Prototype Cost.....                 | 44 |
| Table 8: Percent Change in Illuminance by Machine Size..... | 47 |

## Glossary of Terms

**Area of Emittance** – the surface area over which light is emitted from a light source

**Base** – a “star” shaped aluminum plate with solder points and 4 contacts for mounting, wiring, and dissipating heat from power LEDs

**Beam Angle** –  $2\Theta^{1/2}$  – the whole angle over which light is emitted from a light source

**CIS** – Central Industrial Supply - a global solutions provider specializing in electro-mechanically integrated solutions for a wide variety of industries.

**Half Angle** –  $\Theta^{1/2}$  – the angle over which light is emitted from a lamp of light fixture measured from the center of the beam to the edge of the beam

**HSV** – Hue Saturation Value – a color space used to represent points in an RGB color model

**IC** – Integrated Circuit – a miniaturized electronic circuit comprised mainly of semiconductor devices

**Illuminance** –  $E_v$  – measure of the intensity of incident light (how illuminated an object is)

**Junction** – the small area at the heart of an LED where two semiconducting materials meet and light is emitted

**LED** – Light Emitting Diode – A semiconducting diode that converts electric energy to light

**Lens** – an optical device which transmits and refracts light altering the beam angle

**Lamp** – a replaceable electric component used to produce light

**Light Fixture** – a whole device used for illumination that contains a lamp, housing, wiring and elements affecting the quality of light such as a shade or lens.

**Luminous Emittance** –  $M_v$  – measure of the intensity of emitted light from a light source

**Luminous Flux** -  $\Phi_v$  – measure of the amount of visible light emitting from a source in all directions

**Luminous Intensity** –  $I_v$  – measure of the amount of visible light emitting from a source in a particular direction per unit solid angle.

**PCB** – Printed Circuit Board – a board used to support and electrically connect electrical components

**Power LED** – A LED with a high power consumption (usually  $\geq 0.5W$ ) generally used for illumination

**CRI** – Color Rendering Index – a quantitative measure from 1 to 100 of the ability of a light source to accurately render the color of illuminated objects

**Radiant Flux** –  $\Phi$  – measure of the total amount of electromagnetic radiation emitting from a source in all directions

**Reflector** – a surface used to redirect light altering the beam angle

**Shade** – a fixture that covers parts of a lamp to block light emitted in a certain direction

**Slug** – an aluminum cylinder on which the semiconducting material of a power LED is mounted that draws heat away from the junction

## Chapter 1: Introduction

The population on this planet is constantly increasing. As time passes, these nearly seven billion people are expecting an ever increasing standard of living. This is especially true in China which claims 20 percent of the world's population and rapid industrial development that has no signs of slowing down. This all leads to a larger demand for the resources this planet has to offer, which unlike the population, are finite. The status quo is not sustainable and this is a problem. To offer a solution, the "green" movement has emerged. Green is a concept that focuses on sustainability through efficient use of energy, water, and other resources and protects the environment by reducing waste and pollution. Solutions like these can come from many places. Government regulation has addressed the problem to a certain extent but independent action from individuals and organizations is also important.

Not only is being green good for the environment, but it is also a good business decision. Reduced consumption means reduced costs and promoting a company as green is a great way to increase its public image. A Central Industrial Supply (CIS) manufacturing facility in Wuxi, China has realized this and created a green team aimed to make the facility more green. One technology that can help with this is LED lighting. Using LEDs for general illumination is an emerging field that promises to revolutionize the lighting industry by offering quality light that consumes less energy. Compact fluorescent lights have been pushed as green replacement for incandescent lamps but now LED lights rival CFLs in terms of both cost and energy consumption. Compared to CFLs though, LED lights offer many advantages and LED technology is rapidly improving making investing in LEDs a smart green decision.

Currently at CIS, incandescent lamps are used as factory task lights and fluorescent lamps are used for general lighting such as in the offices and stairway areas. Some LED lights were also installed in the stairway but over two years have dimmed to unacceptable levels. These sources of light consume more power than is necessary and the CIS green team has specified lighting as an area where improvements can be made to make the company more green.

This project aims to design LED light fixtures to replace these lamps and analyze their impact in terms of costs, energy consumption, and light quality. This project will focus on only the factory task lights and stairway lights as those are the two areas where there is the most opportunity for improvement. At its conclusion, this project will provide working prototypes that can be used by CIS in a pilot run as well as future recommendations but will not actually replace the existing factory task lights and stairway lights.

Using LEDs to provide illumination is a new and emerging trend. Their implementation has proven to be a success from a previous similar application yet resources on facilitating the changeover to LEDs is still limited. Also, products currently available on the market do not often make their efficiency or lifespan known. This is most likely because they are cheaply designed leading to low efficiencies and short life spans and are thus unsuitable for industrial applications. The challenge presented by this project is to create LED light fixtures with a high efficiency and



long lifespan for industrial applications while minimizing costs through a combination of purchased products and innovative design. The implementation of our prototypes and recommendations will make CIS more environmental friendly while saving them money. This project's most important impact, however, is that our work at CIS can be used as a model for other companies for their benefit and also to stimulate the LED industry advancing LED technology and the green movement.

We expect the application of LED light fixtures at CIS will lead to significant energy and cost savings without degrading the quality of light. We predict that in place of the existing factory task lights, LED lights will consume about one fourth of the energy. In the stairway, the savings will not be so drastic, but it is expected that LED lights will at least match the efficiency of the fluorescent lights and will certainly increase the quality of lights where previous LED applications have failed. The capital costs will undoubtedly be higher using LEDs, but the long term savings will make it a worthwhile investment. We predict a payback period of around 3 years.

## Chapter 2: Background

This chapter discusses relevant background information of the current situation at CIS, photometry necessary for understanding light, LEDs, their premature degradation, and a comparison to a similar previous MQP.

### 2.1 CIS

CIS or Central Industrial Supply is a company that offers product development, manufacturing, and deployment (CIS, 2008). They specialize in the manufacture of electromechanical components and assemblies for OEMs. CIS was founded in Texas in 1955 and now have over 25 years experience in serving the data-com, telecom, and consumer products industries. CIS's annual sales now exceed \$100 million USD and they hold over 20 patents with more pending. CIS has over 1,300 employees in five countries. They are headquartered in Tucson, Arizona, but their main manufacturing plant and integration takes place in Wuxi, China.

Some of their products include QualSlide, a precision ball bearing slider made in various sizes, functionalities, and weight ratings. It is the number one provider of ball bearing rack-mount equipment for the server and storage industry. In addition to ball bearing sliders, CIS also manufactures electromechanical assemblies including power distribution and management solutions, and antenna reflectors for the telecommunications industry. The manufacturing facility in Wuxi specializes in metal stamping operations with machines from 25 to 400 tons. They also have experience with the forming and treating of various types of metals. There is an in-house test lab where a variety of tests are conducted to assure quality.

CIS in Wuxi has a green team whose aim is to make the company greener in any way possible. One area of focus has been the office lighting. Individual on/off cords have been installed on the overhead fluorescent lighting in the offices and some of the fluorescent lights in the stairways have been replaced by LEDs

#### 2.1.1 The Problem

Despite the efforts of CIS to make the lighting more green, there are still problems and room for improvement. Some of the stairway lights were replaced by LEDs two years ago, and since then, the illuminance there has decreased significantly. The light given off by the LEDs has changed colors and some LEDs have even failed as can be seen in Figure 1.

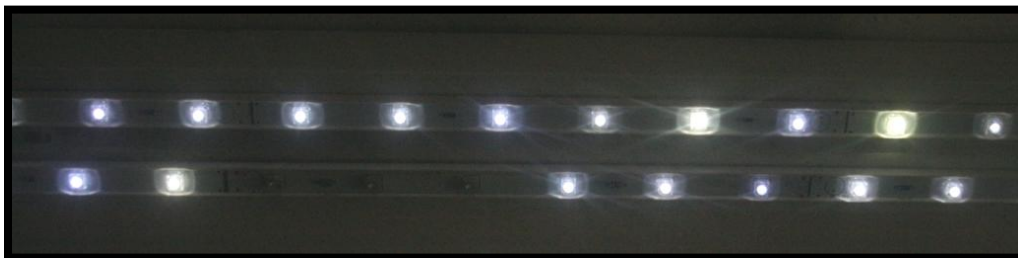

Figure 1: LED Light Fixture in Stairway

The stairway lighting only accounts for a small amount the lighting at CIS. Another area where the lighting could be improved is in the factory itself. Many machines are illuminated using small task light fixtures that use 60W incandescent bulbs. These lamps consume an unnecessary amount of power. The illumination on one machine as seen from the point of view of the operator is shown in Figure 2. The quality of the light is not that great. There are reflections, shadows, the color is yellowy, and the lamp is visible. Changing these types of lights to use LEDs could be an easy way to save energy, money, and maybe improve the quality of the lighting at the same time.



Figure 2: Existing Task Light Quality on an 80t Machine

## 2.2 Photometry

Photometry is defined as the science of measurement of light, and a good understanding of this science is necessary for designing light fixture. Light sources give off radiant energy over a wide spectrum of wavelengths, but for this project, we are only interested in the light perceived by the human eye. To measure this, a luminosity function is applied to the electromagnetic spectrum according to the sensitivity of the human eye to different wavelengths. For each radiometric quantity, there is a corresponding photometric quantity that takes the luminosity function into account. The symbols are the same but with a subscript  $v$  to indicate visible light. All these quantities are independent of time as the human eye is analogous to a video camera and not a still camera requiring different exposure times.

Luminous flux ( $T_v$ ) is a measure of the total amount of light being emitted by a source in every direction. It is measured in lumens (lm) and corresponds to the radiometric quantity, radiant flux, measured in watts. Luminous intensity ( $I_v$ ) is a measure of the intensity of a light source at a given angle. It is measured in candela (cd). It is the luminous flux per steradian (a unit solid angle ( $\Omega$ ) which is the three dimensional equivalent of a radian). Therefore the integral sum of luminous intensity over  $4\pi$  steradians (a whole sphere) is the luminous flux. Light output of lamps can be given in either lumens or candela (usually measured where the intensity is the

highest). It is impossible to convert between the two quantities without knowing how the luminous intensity varies over different angles. This information is given as a beam distribution graph.

The beam angle ( $2\Theta^{1/2}$ ) is the whole angle over which light is emitted. It is twice the half angle ( $\Theta^{1/2}$ ) which is measured from the center of the beam to the edge of the beam. These values are not exact as there is not usually a hard edge. If the luminous flux remains constant and the beam angle decreases, the luminous intensity will increase. Similarly, if the luminous intensity remains constant and the beam angle increases, the luminous flux will increase.

What we are really interested in is the illuminance ( $E_v$ ) which is the measure of incident light or how illuminated something looks. It is measured in lux (lx) and can easily be measured using a lux meter. Lux can be calculated as luminous flux per square meter. Lux varies by the distance to the light source squared. Australian Standard 1680 is one of the only sources of minimum recommended illuminances for different areas. It requires a minimum of 80 lx in stairways and warehouses but over 300 lx for offices and 400 lx or more for detail work (Rowse).

Luminous efficacy is the ratio of luminous flux to radiant flux. It measures how efficient a light source is at producing visible light. The radiant flux can be found by multiplying the forward current through an LED by its voltage drop. A summary of photometric quantities and relationships is found in Appendix A.

## 2.3 LEDs

A light-emitting diode or LED is a small semiconductor diode that emits light when a forward bias voltage is applied. This technology is relatively new, yet many varied applications have been found for LEDs. Ever increasing light output combined with decreasing costs has recently made LEDs an attractive option for general lighting as well.

### 2.3.1 History

LED history dates back to 1907 when the phenomenon of electroluminescence was first discovered by H. J. Round working at Marconi Labs while conducting experimenting with cat's whisker detectors and silicon carbide. Electroluminescence is distinct from incandescence used in electric light bulbs in that light is produced directly from an electric current as opposed to being emitted from an electrically heated filament.

The first LED emitted infrared light. It was not until 1962 that the first practical visible spectrum LED was developed by Nick Holonyak Jr. at General Electric. He is typically considered the father of the LED. The first color available was red but yellow and other colors soon followed. In 1968 LEDs became commercially available and were mass produced. They were mainly used as indicator lights. LEDs emitting white light were developed in 1995. Ever since, the light output from white LEDs has increased exponentially (Figure 3) now surpassing

that of incandescent light and rivaling fluorescent lights. A luminous efficacy of 300 lm/W achieved in a lab has been reported in 2008 (Inman, 2008).

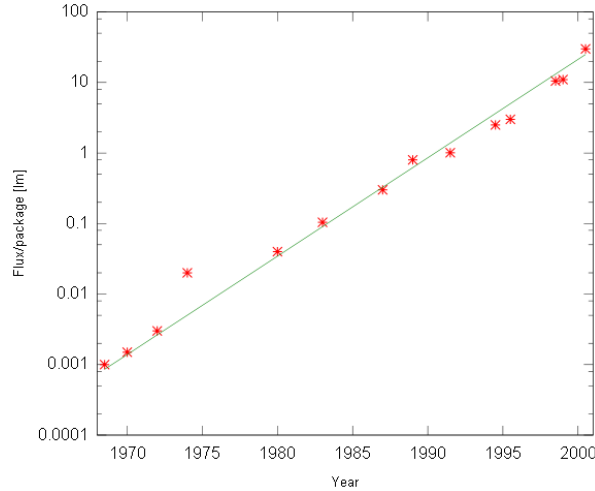

Figure 3: Increasing Light Output of LEDs Over Time

### 2.3.2 Technology

An LED like any other diode is semiconducting material doped to create a p-n junction. When forward bias voltage is applied, the electrons fill ‘holes’ at the junction. As an electron falls in a hole to a lower energy level, it releases a photon. The wavelength of the photon is determined by the band gap of the material. The Diode is covered in a dome shaped epoxy case to minimize the back-reflection of light.

White light can be produced from LEDs in a couple of different ways. The first is by using multicolored white LEDs. This method involves combining different colored LEDs (usually red, green, and blue, the primary colors of light) to give off white light. If more colors are used, a purer white can be rendered at the expense of luminous efficacy. Multi-colored white LEDs, however, lack color stability over a wide temperature range making them unsuitable for industrial applications. The second method of producing white light is from phosphor based white LEDs. This involves coating an LED (usually blue) in a phosphor that emits white light. These have a lower luminous efficacy than multicolored white LEDs due to losses from the Stokes shift. Phosphor based white LEDs’ simplicity, low cost, and color stability, though, makes them the most popular option for general LED lighting applications.

### 2.3.3 Applications

LEDs were first used for, and are still most commonly used as indicators. Their small size, fast on/off times, and low maintenance make them useful as status indicators for all kinds of equipment. The success of LEDs as indicators can be seen in traffic lights. LEDs almost completely replaced incandescent bulbs in this application saving lots of money and also improving safety as they do not burn out like incandescent bulbs causing confusion at

intersections. LEDs are also commonly used in digital displays now. They can be used as backlighting for LCD displays or different colored LEDs themselves can be used as pixels to create very large displays of any resolution.

There are also many non-visual applications for LEDs. Infrared LEDs are commonly used for digital wireless communication such as in television remote controls. In combination with a phototransistor, infrared LEDs can be used as sensors. One significant application is for pulse oximeters used to measure oxygen saturation in blood. Similarly, they can be used as motion sensors. Infrared LEDs can also provide illumination for infrared cameras while being invisible to the naked eye. This is particularly useful for nighttime surveillance cameras.

A significant application of LED and one that is just now emerging is that of using LEDs for general illumination.

### 2.3.4 LEDs for illumination

Modern advances in technology have led to brighter and less expensive LEDs and now they are starting to rival other common light sources both in terms of cost and light output. Incandescent light bulbs are cheap but they only have a luminous efficacy of around 15 lm/W and a lifespan of around 1000 hours. Fluorescent lamps are a bit more expensive but have an average luminous efficacy of about 60 lm/W and a lifespan of around 10,000 hours. Fluorescent lights have not completely replaced incandescent bulbs though because of a few drawbacks. They produce a harsher light. The color rendering index (CRI) of a light source is a measure of how well it reproduces colors of illuminated objects compared to a natural light source on a scale from one to 100. An incandescent bulb has a CRI of about 100 while it is only around 85 on average for fluorescent lights. Fluorescent lamps can also not be dimmed and have a slow on off time. Their toxic mercury content means effort must be made to dispose of them properly which is not always done.

LEDs, on the other hand, do not suffer from many of these problems. LEDs are now available with a luminous efficacy of over 100 lm/W, which is higher than those of both incandescent and fluorescent lights. An efficiency of 300 lm/W has been reported however in a study of commercially available LED lamps in 2008, the average efficiency was found to only be 31 lm/W. The lifespan of an LED is estimated to be 50,000 hours which is 50 and 5 times longer than incandescent and fluorescent lights respectively. Other advantages of LEDs include very fast on/off times and their cycling ability meaning they can be switched on and off many times without decreasing the lifespan. LEDs unlike fluorescent lights are fully dimmable via pulse width modulation which allows any brightness without affecting the color. An LED's mode of failure can also be considered an advantage. LEDs dim slowly as opposed to instantly burning out. This allows for the lamp to still be used until it can be replaced and prevents dangers where light is critical for safety.

There are still some disadvantages however. LEDs work best with a current regulated power supply. The circuitry needed to produce a constant current may lower the light's overall efficiency. LEDs are also temperature dependent and need relatively cool conditions to operate

efficiently. They can also have a CRI as low as 70 which is at the lower end of the spectrum of what is acceptable for industrial lighting. LEDs with higher CRIs are available but are more expensive. One of the main obstacles currently facing the shift to LED lighting is the high capital cost, but this will only decrease as time passes. Even with a high initial price, the payback period might only be two years as demonstrated by one company (Taub, 2008). None of these disadvantages cannot be overcome though. This surely will allow for LEDs to become the standard for all future lighting applications.

## 2.4 Premature LED Degradation

LED lighting application is now the most popular illumination technology on demand. Because of its low power consumption, accessibility, and long lifespan, more consumers demand LED lighting applications and many companies are joining in the market to fulfill this demand with variety of LED products and LED applications. Although LED application may look great on the surface, it has one critical weakness; premature LED degradation.

Many companies have joined the LED market and it is true LEDs with better performance are coming out but the problem is that the issue of premature LED degradation is not being studied enough. Companies claim their LEDs have lifespan over 100,000 hours which is approximately 10year. Common method to come up with this number is by following: light 1,000 LEDs at recommended ambient temperature with constant current for 100 hours, count number of LEDs that have failed (usually none because of short test time), then multiply number of LEDs tested by hours tested. This approximation is not the actual lifespan of LEDs. Instead, it is an approximation that says after this many hours of operation, the LED has 50% chance of failure.

One aspect of the method on how to estimate LED lifespan that is important is that the environment it was tested on was ideal. LED is a current driven solid state semiconductor device which is very sensitive to voltage change. Like all semiconductor, performance of LED degrades when overdriven. Physically, LED degradation presents itself as dimming of LED. According to the voltage vs. luminous intensity graph in the LED data sheet provided by the companies, even slight change in voltage can cause the intensity of the LED to change greatly often resulting in over driven LED and LED circuit. Intensity of LED light getting intense means more current is being passed through the LED.

There are many factors that lead to change or fluctuation of voltage: ambient temperature, device temperature, and humidity. It may be bit different depending on the LED model but it is true for all LEDs that they show linear correlation as temperature increases, voltage also increases. The normal working environmental temperature of LED should be 25 degree Celsius. Some study suggests that the temperature reaching 40 degrees may cut down LED life span to 1~2 years. With constantly working circuit and no proper cooling system, it is very easy for the LEDs to reach 40 degree. There are not many studies done on how humidity affects voltage but it has been verifies that increase in humidity does increase voltage. Also



increase in temperature and humidity not only affects LED, but they also have big impact on the whole circuit, resulting in unstable circuit.

Ultimately what cause premature LED degradation is excess current. During light emission process, the crystalline structure of LED remains unchanged but microscopic changes may occur. Over time, these microscopic changes will compile and eventually cause inevitable dimming of LED. If excess amount of current is provided to the LED, it will cause changes in crystalline structure of the LED, resulting in premature LED degradation.

## 2.5 Comparison to Previous MQPs

A similar MQP to this one was done last year for Rapid Engineering Manufacturing (REM) also in Wuxi, China. The goal was “to design and create LED factory task lights with emphasis on the following five features: efficient circuit, appropriate light head shape, functional structural frame, adequate heat dissipation, and excellent quality” (Embree, Kingsley, Lu, Guo, & Deng, 2008). Three different designs were prototyped and tested. These prototypes used large numbers of low power LEDs on PCBs and were powered directly from alternating current.

This MQP is similar in the design of the factory task lights but different in that we have the objective to determine the cause of the prematurely dimming LEDs currently used in the stairway and increase the illumination there. We also have more of an emphasis on being green and reducing long-term costs

One major area of improvement over last year’s MQP is the circuit design. LEDs must have a constant current supply in order to operate reliably. If this is not provided, they will suffer from thermal runaway which will rapidly degrade an LED’s performance and light output. This was most likely what happened at REM as after one year, neither prototype was working. In order to prevent this, more effort is put into designing a circuit that provides constant current and other protective measures.

In the year that has past, more LEDs have become available making choosing the right one a more important task. With the higher power LEDs that have been developed in the last year comes a higher concentration of heat that needs to be dissipated. Because of this, more emphasis will be placed on heat dissipation. A low junction temperature is essential for LEDs to operate efficiently.



## Chapter 3: Methodology

The essential goal of this project is to use LEDs to improve existing lighting at CIS while helping them to be green and reduce long-term costs. This goal is fulfilled by completing the following objectives:

- Design and prototype LED light fixtures to replace existing factory task lights with ones that provide more illumination, have a longer lifespan, and consume less electricity than the current ones. This will be achieved by:
  - Selecting the most suitable LEDs
  - Designing a reliable constant current supply circuit
  - Designing a structure that provides good heat dissipation
- Determine the cause of the dimming LEDs in the stairway and enhance the illumination there by providing a minimum of 80 lx.

This project is organized according to the six sigma project management strategy. Only four weeks were spent on site at CIS and that time needed to be used efficiently. The basic Gantt chart in Figure 4 was developed to keep us on track while at CIS with more detailed weekly task lists being made at the end of every week.

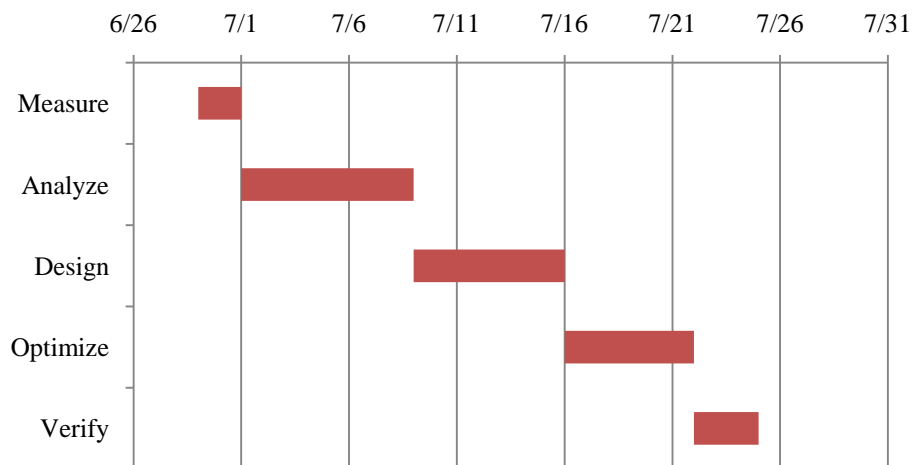

Figure 4: Gantt Chart for Time at CIS

Our project is divided into two main sections according to our objectives; the factory task lights and the stairway lights which will both share a common circuit design. The first step in our methodology after our problem was defined was to measure the existing characteristics of the lighting that are critical to quality. These characteristics we determined to be the energy consumption, costs, and light quality. Next, the initial data were analyzed and design alternatives were brainstormed. Then, design details were worked out and prototypes built. They were then tested and optimized until a suitable solution was found. Finally, the characteristics critical to quality were measured and compared to the initial measurements to verify the improvements.

### 3.1 Circuit Design

An appropriate driving circuit is probably the most important factor for creating a reliable and long lasting LED light fixture. Most electrical loads can be driven by a voltage regulated power supply and designers of cheap LED light fixtures often make the mistake of powering LEDs in the same manner using a only a current limiting resistor. This is in an unstable and potentially dangerous circuit design. Slight variances in the forward bias voltages of LEDs cannot be avoided. The tolerance for the voltage across an LED can be as high as 15%. The voltage of an LED will also decrease as temperature increases. Since LEDs, like all diodes, behave according to the Shockley diode model, a slight voltage drop can result in a large current increase with a voltage regulated power supply as seen in Figure 5.

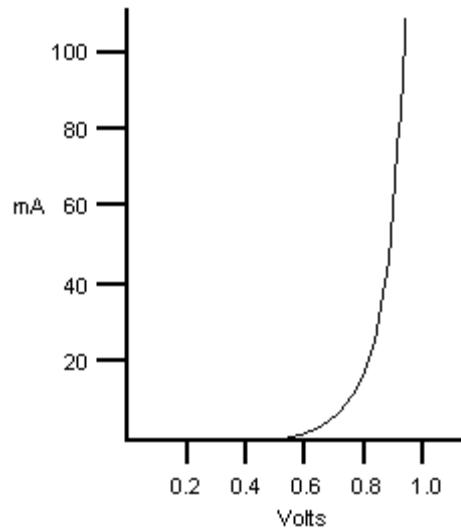

Figure 5: Typical Current-Voltage Relationship of a Diode

This will raise the junction temperature which further reduces the voltage and increases the current and temperature. This is known as thermal runaway and will rapidly degrade an LED. The effects of this include very dim LEDs emitting noticeably different colored light and a dramatically shortened lifespan.

To avoid thermal runaway, providing a constant current is essential for the circuit design. The current for our circuit also needs to be variable up to 350mA to accommodate different LEDs. The circuit needs to provide enough power to be used for both the stairway light and factory task light. This maximum power we estimate to be no more than 25 Watts. Once these conditions are met, we want a circuit that consumes as little power as possible, giving the whole light fixture a high efficiency. Other considerations include making the circuit safe, simple, and small.

The circuit in Figure 6 shows how a constant current source is achieved.

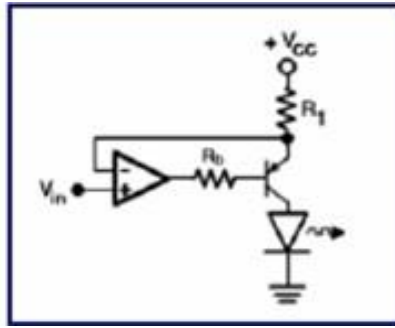

Figure 6: Constant Current Circuit

Note that the supply current is determined by the supply voltage  $V_{cc}$  minus  $V_{in}$  divided by  $R_1$ ,  $(V_{cc}-V_{in})/R_1$ . The majority of constant current source nowadays share this basic theory.

Generally, there are two applications of this theory to achieve constant current to drive LEDs. One commonly used method is to use a transformer and rectifier to convert the 220V AC from the mains to a low voltage DC supply and then use a simple circuit. The other is to use an integrated circuit powered directly by 220V AC. Since we lack the electronics knowledge to design a circuit from scratch, we reviewed other circuit designs for similar applications and compared them.

### 3.1.1 Integrated Circuit

Chip based circuits have a large advantage over simple circuits as they do not require a transformer and can get efficiencies up to 90%. Transformers can significantly decrease the efficiency of the circuit making using chips an attractive choice. There are quite a few options for chips but after a comparison, we chose PT4107 as it can provide the required power, has simple peripheral circuits and it is both cheap and efficient. It can also have advanced protections such as using a thermistor to make the current output independent of temperature. A typical LED drive circuit using this chip is seen in Figure 7.

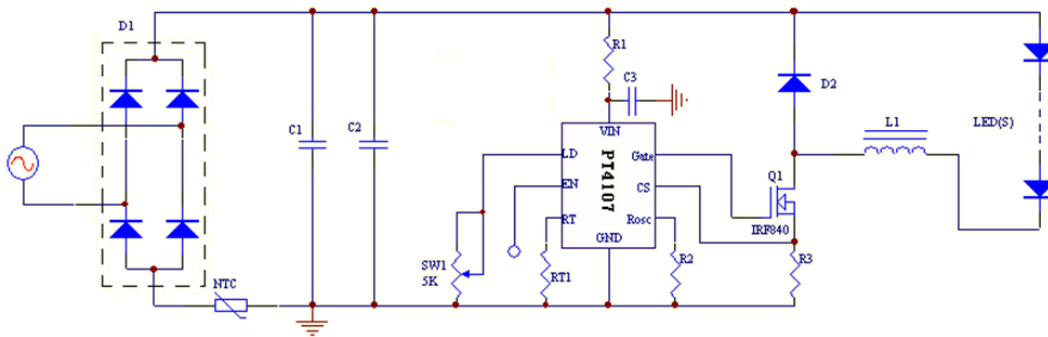

Figure 7: Schematic of Typical PT4107 LED Drive Circuit

For the simple reason that PT4107 is a chip which cannot be found in simulation software such as PROTEL99SE and MULTISIM, we calculated parameters of the components needed by hand and performed tests with the circuit built on a breadboard. The output voltage and current measured was far from what we calculated. For the 1 W LED circuit, the output voltage was 4 V instead of the expected 24 V. When we tried to measure the voltage drop between different junctions, the chip exploded. There could be numerous causes for the incorrect voltage and chip failure but the circuit was too complicated for us to troubleshoot. Its high input voltage also made testing dangerous.

### 3.1.2 Simple Circuits

Another way to create an LED driver is by using a simple circuit. First, a transformer and a rectifier are used to step down the 220 V AC to 24 V AC and convert it to DC. After, several compatible capacitors are placed which help smooth the voltage making it more stable. A schematic of this is seen in Figure 8. After this can come the simple circuit.

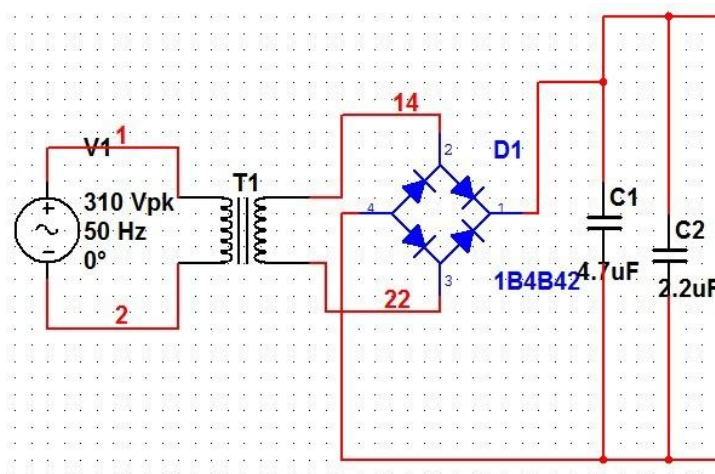

Figure 8: Transformer and Rectifier Circuit

In accordance with the basic theory of the constant current source, transistors are commonly used. There are two typical circuit types. The first uses two transistors; one to maintain constant current based on a second which forms a feedback loop with the first transistor. The second circuit type is like the first except it uses a Zener diode to maintain a constant current instead of a transistor.

After some research, two simple circuits were found that suit our needs. One we will call E circuit after its discoverer Ed and the other we will call F circuit after its discoverer Francis.

### 3.1.2.1 E Circuit

For E circuit, we used NPN silicon transistor and a MOSFET to maintain constant current. A schematic can be seen in Figure 9. Note that Q1 can help keep the voltage constant and Q2 the current. R1 is a voltage divider that provides compatible voltage to LEDs. R2 is a current controller that provides suitable current to the LEDs.

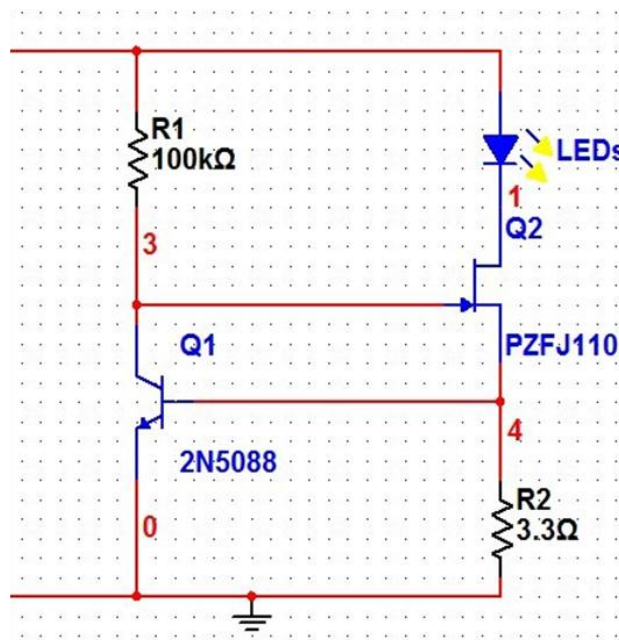

Figure 9: E Circuit Schematic

The constant current provided to the LEDs is decided by R2, which is approximately equal to  $0.5 / R2$  and the power dissipated by the resistor is approximately  $0.25 / R2$ . The resistor value R2 and power rating is dependent on the current wanted and can be calculated as follows: Assume the voltage drop between the base and emitter of Q1 is 0.5 volts

For a 150 mA LED current:

$$R2 = 0.5 / 0.15 = 3.3 \text{ ohms.}$$

$$R2 \text{ power} = 0.25 / 0.15 = 1.67 \text{ Watts. We'll need at least a 2 watt rated resistor.}$$

For 350 mA LED current:

$$R2 = 0.5 / 0.35 = 1.43 \text{ ohms.}$$

$$R2 \text{ power} = 0.25 / 0.35 = 0.74 \text{ Watts. We'll need at least a 1.5 watt rated resistor.}$$

E circuit proved to be high quality after testing. It maintained a constant current over a 6 V variation in the input signal. Choosing a current is as simple as changing R2. It could even be varied by replacing R2 with a variable resistor. This allows it to drive both 0.5 W and 1 W LEDs

requiring different currents. The circuit itself has a 90% efficiency if well managed however it still requires a transformer which will lower the efficiency.

### 3.1.2.2 F Circuit

For F circuit, a Zener diode and a transistor were used. The calculation process is almost the same as with E circuit. A schematic of this circuit can be seen in Figure 10.

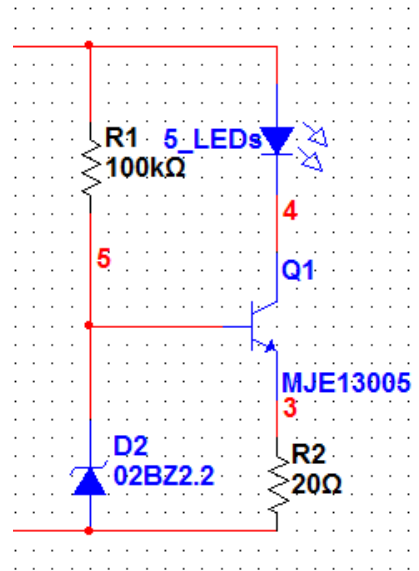

Figure 10: F Circuit Schematic

Assume that the voltage drop between the base and emitter of the transistor Q1 is 0.6 V. After we selected a 3.6 V Zener diode, we get 3 V which is constant. If we need a 150 mA current, then  $R2$  should be  $3/0.15=20\text{ohms}$ . As the output voltage can be as high as the input, we chose high power transistors (MJE13005, with  $V_{ce0}$  400 V and 700 V blocking capability) and a high power resistor R1. The circuit is capable of handling high voltages and thus the transformer is not necessary. However, high voltages would result in a large power loss in R1 lowering the efficiency even more than a transformer would so we decided to keep the transformer.

Through testing, we found the circuit performs well to maintain a constant current and has an 80% efficiency (after the transformer and rectifier). However, when trying to adjust the current to suit different needs, it could provide no more than 200 mA and some Zener diodes burnt out. The reason for this was never determined. F circuit's maximum current makes it only suitable for powering low power LEDs that are rated at 0.5 W or less.

### 3.1.3 Comparison

Table 1: Circuit Comparison

|                                  | Integrated circuit   | Simple circuit |   |
|----------------------------------|--|----------------|---|
|                                  | PT4107 application circuit   | E circuit      | F circuit   |
| <b>Transformer</b>               | No   | Yes            | Yes   |
| <b>Structure</b>                 | Complex  | Simple         | Simple  |
| <b>Safety</b>                    | Potential danger of high input voltage (400 V)<br>Potential hazard of components explosion | Safe           | Potential hazard of burning Zener diode             |
| <b>Efficiency</b>                | Up to 90%  | Up to 90%      | Up to 80%   |
| <b>Constant Current</b>          | Up to 1 A if correctly managed   | Up to 700 mA   | No more than 180 mA                                 |
| <b>Operates well in reality?</b> | No, chip explosion   | Yes            | Zener diode burns if current goes higher than 180mA |

Table 1 shows a comparison of the three circuits. The integrated circuit is theoretically the most efficient and has the advantage of being temperature independent; however, its complexity and high voltage input are a major disadvantage making it to difficult for us to troubleshoot with the resources at hand. E circuit and F circuit are similar but unlike F circuit, E circuit was slightly more efficient and worked reliably over a range of output currents making it our choice to drive both the factory task lights and stairway lights.

### 3.2 Factory Task Lights

Our first objective is to design and prototype LED light fixtures to replace existing factory task lights with ones that provide more illumination, have a longer lifespan, and consume less electricity than the current ones. We plan to achieve this by selecting the most suitable LEDs driven by the circuit we designed and by designing a structure that provides good heat dissipation.

### 3.2.1 Initial Measurements

First, we need to collect data about the existing factory task lights that we can analyze before beginning a design. These measurements are in the areas of energy consumption, cost analysis, and light quality.

#### 3.2.1.1 Energy Consumption

Factories in CIS operate under two shifts, a morning shift and a night shift which are eight hours long each so the factory task lights are on for about 16 hours every day. In general, there is no overtime and there are 22 working days per month. According to the initial measurements in factory one, there were 26 total factory task lights. All of the lights use 60 W incandescent lamps. The lights can be divided into two kinds depending on their usage. One kind is only used 16 hours per month and the other kind is used for the entirety of the working time, 352 hours per month. A tally of the lights in factory one is broken down in Table 2. There is also an array of large lights suspended from the ceiling for area lighting, but they are not included in this analysis. The total service time of incandescent lamps in factory one is 3440 hours per month.

Table 2: Factory Task Light Tally for Factory One

| Machine Size | # Machines | Lamp Type    | # Lights per Machine | Service Time per Light (hours/month) |
|--------------|------------|--------------|----------------------|--------------------------------------|
| 25t          | 5          | incandescent | 1                    | 16                                   |
| 80t          | 6          | incandescent | 1                    | 16                                   |
| 160t         | 6          | incandescent | 1                    | 16                                   |
| 200t         | 1          | incandescent | 1                    | 16 *22                               |
| 250t         | 2          | incandescent | 2                    | 16 *22                               |
| 400t         | 2          | incandescent | 2                    | 16 *22                               |
| Total        | 22         |              | 26                   | 3440                                 |

The total energy consumption of factory task lights in factory one per year is:

$$P_{inc} = 60 \cdot 10^{-3} kW \times 3440 \frac{h}{m} \times 12m = 2476.8 kWh$$

#### 3.2.1.2 Cost Analysis

The lighting costs of the factory task lights include the cost of the lamps and cost of power. When the lamps burn out, replacements are needed. Assuming installation is simple, labor costs are negligible and thus not included.



$$\text{lamp cost: } C_1 = a \times \frac{n}{N}$$

$a$  – unit price of lamp  $n$  – using time  $N$  – life span

$$\text{power cost: } C_2 = p \times t \times b$$

$p$  – power of every light  $t$  – using time  $b$  – unit price of electric power

$$\text{lighting cost: } C = C_1 + C_2$$

According to CIS the price of electric power is ¥0.875 per kWh. The average wholesale unit price of incandescent lamp is ¥0.48, and its life span is about 1000 hours. Then, the lighting cost in factory one is as follow.

$$\text{lamp cost: } C_1 = a \times \frac{n}{N} = 0.48 \times \frac{3440 \times 12 \times n}{1000} = ¥19.8n$$

$$\text{power cost: } C_2 = p \times t \times b = 0.06kw \times (3440 \times 12 \times n) h \times 0.875 / (kw * h) = ¥2167.2n$$

$$\text{lighting cost: } C_{inc} = C_1 + C_2 = ¥2187.0n$$

The current costs of using incandescent lamps for factory task lights in factory one is ¥2187 per year.

### 3.2.1.3 Light Quality

The existing light quality from the factory task lights were assessed in three ways. Measurements were taken at various machines in the factory, a survey was administered to machine operators, and detailed photometric data was collected in a lab test.

The full results of the measurements taken in the factory and the survey can be found in Appendix B. The average illumination on the factory floor due to natural light and the array of halogen lights at the ceiling was around 150 lx on a rainy day. This is an acceptable general illuminance for such a place. What is more important, though, is the illuminance of the work pieces in the machines. Due to the size and shape of the machine and the position of the operator, little of the light from the overhead lighting and windows actually falls on the work piece. The average illuminance of the work piece with the task light off was only 15 lx. With the task light on, this figure increase to 46, meaning the task light provided an addition 31 lx on average.

Machine operators were surveyed to see their opinion on the current illumination, area illuminated, color of light, and any other complaints they may have had. The results were unanimous. The illumination and area illuminated were fine, but they all complained about the glare although one mentioned it is a problem that can easily be solved by simply viewing at a slightly different angle. They also said the color was too yellow.

The procedure for the photometric tests can be found in Appendix C. The data collected and results for the existing task light fixture with a 60W incandescent bulb are found in Appendix D. The effective beam angle was found to be 140 degrees. Outside of this angle, the luminous intensity diminished more gradually for about 10 degrees due to reflections from the shade before dropping off as can be seen in the beam distribution graph (Appendix D).

The luminous flux of the light is a very difficult quantity to calculate without expensive photometry equipment as it is the integral sum of the luminous intensities at all angles. The luminous flux of a 60 W incandescent bulb was measured to be 746 lm by Olino (van der Steen, 2007). Rough equations to approximate luminous flux yielded results between 500 and 1300 lm for the existing task light. Assuming the 60 W lamp used is the same as in Olino's test and the shade is less than 100% reflective absorbing some of the light energy as heat, I estimate the luminous flux of the existing task light to be  $600 \pm 100$  lm. At 73 cm away (the average distance from the light fixture to the work piece), 600 lm should create an average illuminance of 48 lx over an area of  $12.6 \text{ m}^2$ . In our tests, the average illuminance was 31 lx which is 65% of the predicted. The color temperature was also found to be a warm orange corresponding to a hue of approximately  $28^\circ$  in HSV color space.

### 3.2.2 LED Selection

LEDs were compared among the ones offered from Luckysunny Shenzhen Opto-electric Co. as they were available at the local market in Wuxi and provided enough data for comparison. The useful data provided were color, forward current, forward voltage, color temperature, and luminous flux. Prices were not provided. The useful data for comparison are luminous efficacy which measures how energy efficient an LED is, cost per lumen which measures cost per unit of luminous flux, and beam angle which measure over what angle the luminous flux will be spread. Once an LED is chosen, the number of LEDs per light fixture can then be varied to achieve the desired luminous flux and illumination of the area of interest.

#### 3.2.2.1 LED Type

Only white LEDs were compared. Prices and beam angles were not available for all families of LEDs so the initial comparison was based on luminous efficacy. This is in line with our primary goal of helping CIS to be more green. A comparison table can be found in Appendix G. Power was calculated from typical forward voltage and current. Luminous flux and power were then used to calculate luminous efficacy. There were also two types of white LEDs; pure white, and warm white. Warm white has a higher CRI and is generally easier on the eyes but it comes at the expense of cost and luminous efficacy. The LED family with the highest luminous efficacy was found to be the pure white 1W LEDs with an efficacy of 55.6 lm/W so that were chosen. The warm white had an efficacy of only 43.7 lm/W. Every worker interviewed complained the current light was too yellow. "Pure white" LEDs would probably be a welcome change and eliminate the yellow light. A lower CRI is not of particular concern as accurate color rendering is not necessary for the machine work at CIS.

More detailed information was obtained online for the different pure white 1W LEDs. This time luminous efficacy and beam angles were compared in a table also in Appendix G.

The beam angle of the existing lights was 140 degrees, and in every case, the workers were satisfied with the area illuminated. In fact, at the average distance from the work piece, a

light with a 140 degree beam angle would illuminate an area of 12.6 m<sup>2</sup> which is much larger than the largest area which needs to be illuminated of 0.4 m<sup>2</sup> (Appendix B). Even if a luminous intensity of 70% of the maximum (within 30 degrees as seen in the beam distribution graph in Appendix D) is needed for adequate illumination, the area illuminated would still be greater than needed. However, the area of projected light is elliptical while the area to be illuminated is rectangular so a slightly larger beam angle may be necessary to sufficiently illuminate the corners.

Among the 1W white LEDs, the beam angles ranged from 100 to 165. The highest luminous efficacies were 63 lm/W for LEDs available with beam angles of 120 and 115 degrees. Only 1 LED had a narrower beam angle but with a much worse luminous efficacy. The 120 degree LED model 830CW1B was chosen because of its more versatile mechanical structure. The datasheet for this LED is in Appendix H. If the beam angle seems to be too large during testing, it can always be reduced using reflectors or lenses.

### **3.2.2.2 LED Number**

The selected LED has a luminous flux of 75 lm. The existing light has a luminous flux of around 600 lm. To create that same flux, eight LEDs are needed. At 73 cm away, this will create an average theoretical illumination of 120 lx over 5.0 m<sup>2</sup>. For the existing light, the actual average illumination was 65% of the theoretical so we can assume that with an eight LED light, the actual illumination will be 65% of 120 lx which is 78 lx. This is 2.5 times that of the existing light (which was 31 lx) due to the 20 degree narrower beam angle alone. The average existing (not from the factory task light) illuminance was measured to be 15 lx. This would provide a total illuminance of 93 lx. This should be suitable as the workers had no problems with the current illuminance however illuminances of over 300 lx are recommended for detail work so more illumination may be better (Rowse).

All this theory is useful for estimations but not much more. Light is complex and it is difficult to predict illumination, especially with complex and varying geometries such as those found on the machines at CIS. The best way to determine if the illumination is sufficient is to perform tests.

### **3.2.3 Fixture Design**

The LEDs along with the driving circuit, transformer, and controls need to be combined to create a practical light fixture that suits the needs of CIS. In agreement with our goals, the fixture should help to reduce long-term costs, improve the existing lighting, and be green. The main purpose of the fixture should be to facilitate heat dissipation which is a crucial property for operating high power LEDs and having them last for a long time. It should also protect the circuitry, be safe and easy to use, and minimize environmental impact.

Our fixture design should also incorporate as much of the existing mechanical structure as possible to reduce costs, waste, and facilitate the changeover. The current structure is comprised of a base that bolts onto the machine, a ball joint with adjustable friction, a 50 cm

long gooseneck (the bottom half of which is rigid), a standard E27 screw cap fitting with a toggle switch, and a reflector/shade as seen in Figure 11.



**Figure 11: Existing Mechanical Structure**

For these prototypes, the circuits were bulky and not included in the actual fixture design. They were instead enclosed in a box (Figure 12) to and placed on the floor next to the machine. The large size of the circuit box is not a problem in the factory as it would be for say a reading light.

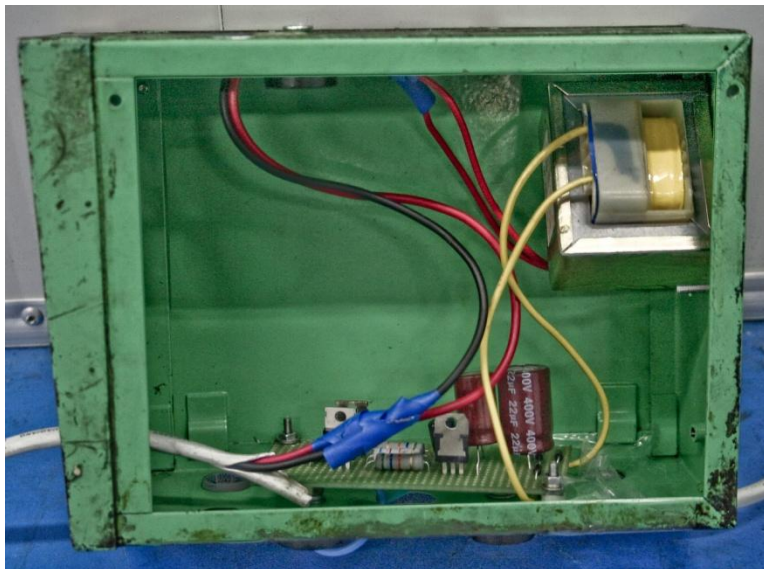

**Figure 12: Circuit Box**

Keeping the circuit separate keeps the size and weight of the light fixture down. The current of the simple circuit used is somewhat temperature dependent so keeping it far from the heat of the LEDs will make it operate more reliably. This decision also has the advantage of physically

separating the lamp from the circuit so if there is a problem with either the circuit or the lamp, it can be repaired or replaced individually.

### 3.2.3.1 Material Selection

The primary material chosen for construction of the fixture must allow for excellent heat dissipation by having a high thermal conductivity. The weight of our fixture design is also important. If we are to utilize the existing gooseneck, it must be relatively lightweight. This is a problem encountered in the MQP last year for REM towards the end of the project when it was too late to correct. CIS lacks the equipment necessary to measure the maximum moment that the gooseneck can support, so simply saying “lightweight” instead of specifying a maximum mass will have to suffice. As always, the material chosen should be cheap and green to agree with our goals. Materials were plotted against these four properties in CES EduPack (Figure 13) to get a rough idea of what some good options might be. Better choices are towards the top right.

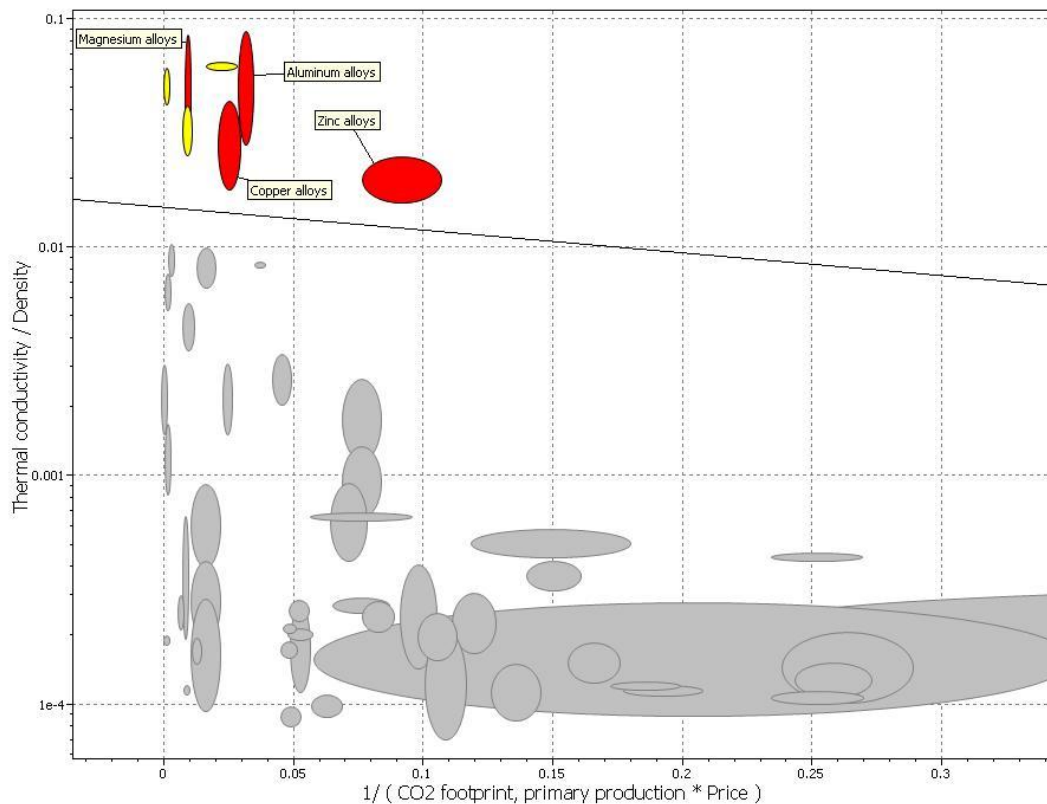
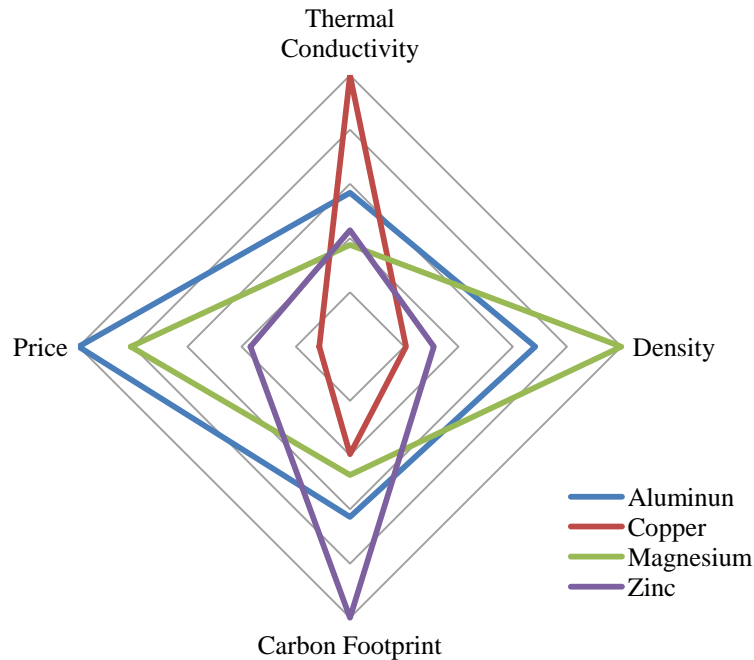

Figure 13: Material Selection Graph

Four materials that emerged as possibilities were magnesium, aluminum, copper, and zinc. Specific properties were compared in more detail using a radar plot (Figure 14). Price and Carbon Footprint are measured per unit volume. All data were normalized with better values being towards the outside of the radar plot. This data can be found in Appendix I.



**Figure 14: Possible Materials Comparison**

From this plot it can be seen that copper has the best thermal conductivity, but it is expensive, heavy, and its production has a large carbon footprint making it a bad choice. Magnesium might be the best choice if weight was highly valued and zinc would good if we were really concerned about the environment. Aluminum, however, ranks well all around and it is the cheapest. Aluminum is also readily available, easy to recycle, and has a high machinability making it the best choice for this application. Its prevalent use in existing LED light fixtures on the market confirms that it is a good choice.

### **3.2.3.2 Thermal Management**

Good thermal management is crucial for LEDs to operate efficiently and have a long lifespan. The junction temperature, that is the temperature of the p-n junction at the heart of an LED, generates a lot of heat approximately equal to the product of the voltage drop across the LED and the current through it. The portion of energy that is released as light is negligible for heat transfer calculations. As can be seen in the graph (Figure 15) of a 1W LED similar to the one selected, the lifespan of an LED decreases logarithmically with temperature (Seoul Semiconductor R&D Center, 2008). An LED's light output, though, decreases linearly as the temperature increases as seen in Figure 16 (Cree, 2006).

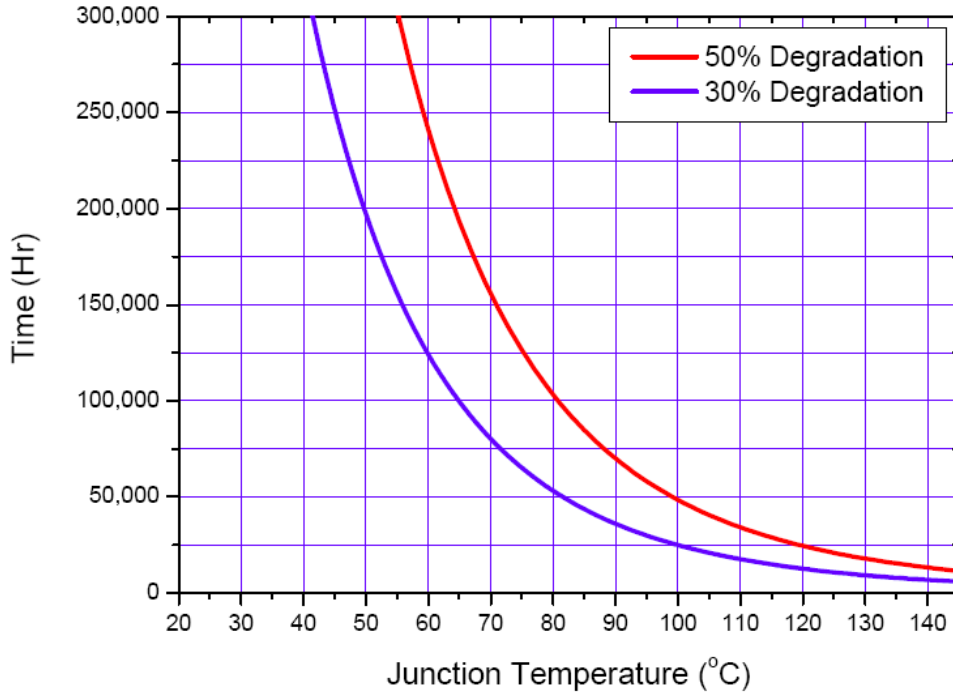

Figure 15: 1W LED Lifespan as a Function of Junction Temperature

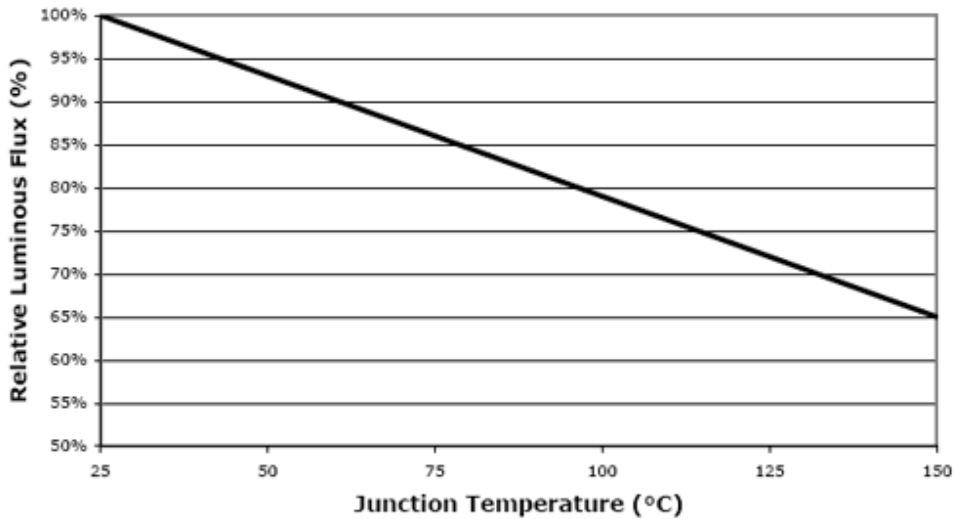

Figure 16: LED Light Output as a Function of Junction Temperature

These graphs are for power LEDs produced by a different company and don't exactly represent how the LEDs we selected will behave. We expect these graphs to still closely represent our LEDs since LED designs are very similar among different manufacturers. In any case, the importance of a low junction temperature in terms of both lifespan and efficiency are clear.



A cross section of a typical power LED mounted on a Heat Sink is shown in Figure 17. All the heat is created at the junction. The epoxy lens has a low thermal conductivity and can be considered an insulator. The junction is mounted on a metal slug which acts as small heat sink built into the LED case. Also included with the LED is a small star shaped aluminum base. This provides large solder points for connecting the LED to the drive circuit as well as acting as a slightly larger heat sink. This base can then be mounted to the aluminum light fixture whose main purpose is to act as an even larger heat sink.

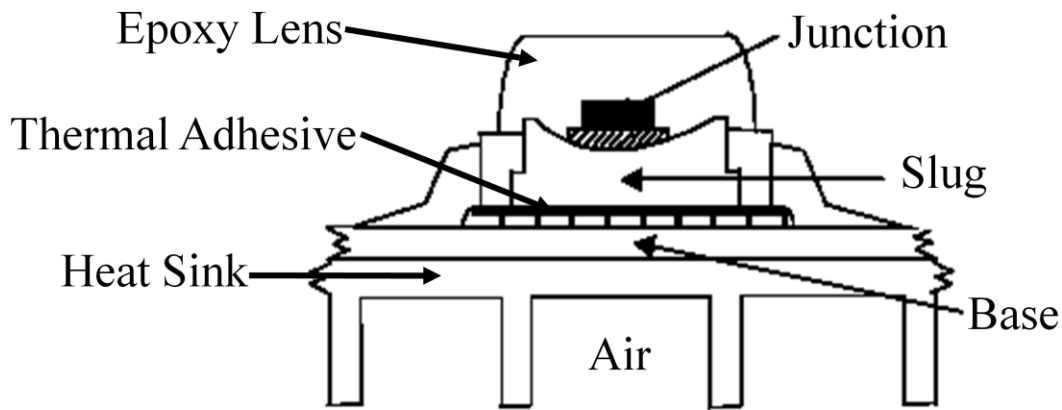

Figure 17: Power LED Mounted on Heat Sink Cross Section

It is important for the contact between the slug and the base and the base and the heat sink to be as thermally conductive as possible. Air has a very poor thermal conductivity (about  $0.025 \text{ W}/(\text{m}\cdot\text{K})$ ) so we used a thermal grease at the interfaces of these surfaces which fills in any air gaps with a material of high thermal conductivity ( $> 1.22 \text{ W}/(\text{m}\cdot\text{K})$ ). Thermal adhesive was the preferred compound as it would also securely fasten the parts, but all that was available was thermal grease. The base could be removed to eliminate one of these interfaces, but this was decided against as it would make soldering or replacing the LEDs much more difficult.

A thermal resistance model of the light fixture is shown in Figure 18.



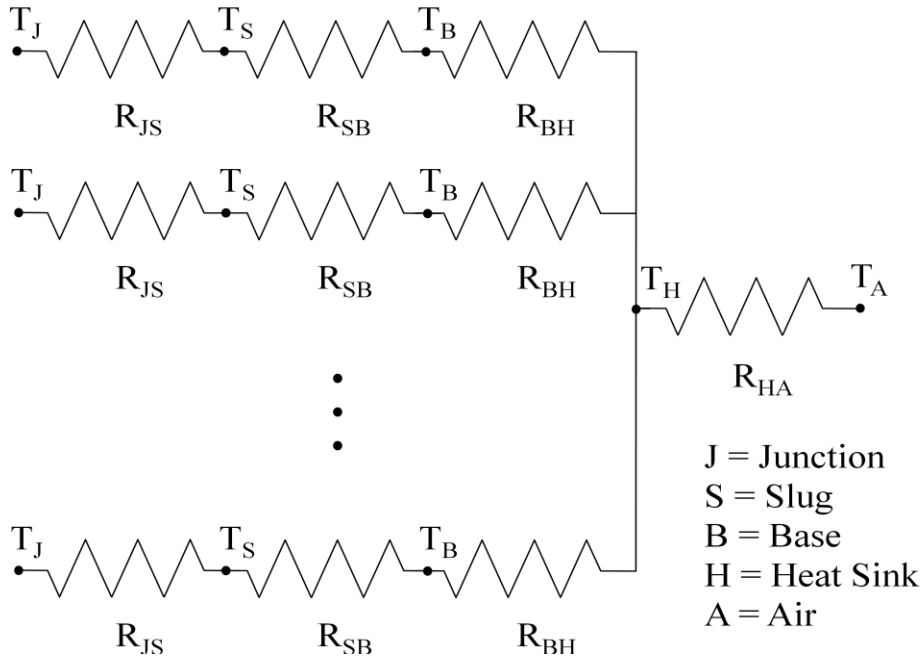

Figure 18: Thermal Resistance Model of Light Fixture

The number of arms on the left is equal to the number of LEDs used. For now, we will assume eight LEDs will be used. Unfortunately, the maximum junction temperature  $T_J$  was not provided by the manufacturer. The temperature of the slug can be measured but  $R_{JS}$  was not provided either so  $T_J$  cannot be accurately calculated.  $R_{SB}$  and  $R_{BH}$  were reduced by the use of thermal compound. Besides that, the only way to keep  $T_J$  low is to design a heat sink with a low thermal resistance  $R_{HA}$ .

The maximum operating temperature was given to be 80 °C (Appendix H). Where this should be measured is unclear but we will assume it refers to  $T_B$  since the datasheet depicts the assembly of the LED and base. We estimate the maximum ambient air temperature  $T_A$  in the factory to be no more than 40 °C. Knowing this, we can calculate the maximum  $R_{HA}$  needed to keep  $T_B$  below 80 °C using  $\dot{Q} = \frac{T_H - T_A}{R_{HA}}$  or  $R_{HA} = \frac{T_H - T_A}{\dot{Q}}$ .  $R_{BH}$  is very low (less than about 0.003 °C/W per LED), and can be ignored for this calculation. The heat transfer rate from the LEDs is approximately  $nIV = 8 \cdot 350mA \cdot 3.4V = 9.52 W$  and the temperature difference is  $T_B - T_A = 80 - 40 = 40$  °C so  $R_H = \frac{40 \text{ °C}}{9.52 W} = 4.2 \text{ °C/W}$ . This maximum thermal resistance of 4.2 °C/W is our primary design specification for the fixture.

The heat sink could utilize a fan or thermoelectric cooler to lower the thermal resistance; however, these measures both require power lowering the overall efficiency of the light and adding complexity. A suitable thermal resistance should be achievable using only a well designed heat sink.

**3.2.3.3 Heat Sink**

A well designed heat sink should have a place to mount LEDs and large surface area to maximize the convective heat transfer according to  $Q = hA\Delta T$ . We achieved this in our design by using fins. The fins we designed were 3 mm thick which was a found to be the best balance between having good conduction to the end of the fin and good convection by having them thin enough to accommodate a larger number of fins. A heat sink with radial symmetry was also logical as the light output from the LEDs is circular. A CAD model of our design is seen in Figure 19.



**Figure 19: Factory Task Light Heat Sink Model**

The exact thermal resistance is difficult to calculate but by approximating this design as a simple rectangular heat sink, we were able to get thermal resistance data from an online calculator. The graph in Figure 20 was produced from the calculator and it can be seen that with a 9.52 W heat dissipation, the thermal resistance is about 4 °C/W which is less than 4.2 so the LEDs should remain below their maximum specified operating temperature.

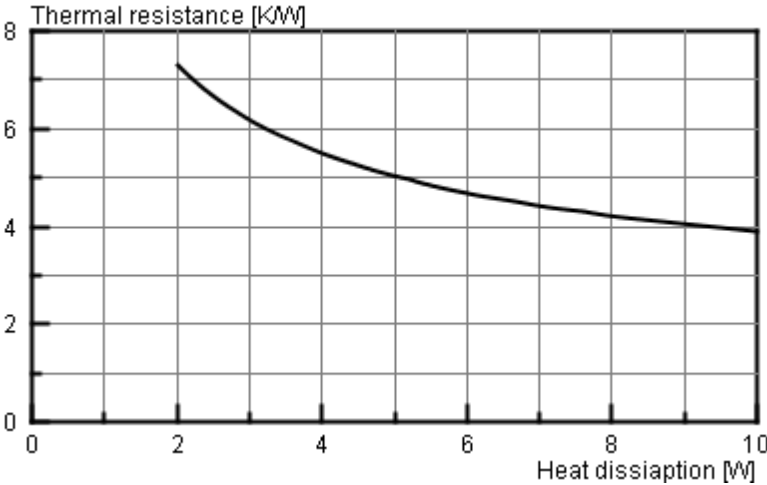

**Figure 20: Thermal Resistance of Approximation o Heat Sink Design**

### 3.3 Stairway Lights

Our second objective is to determine the causes of the premature LED degradation of already existing LED application and enhance the illumination by providing minimum of 80 lx measured on the stairs.

#### 3.3.1 Initial Measurements

Once again data was collected and analyzed concerning the lighting in the stairway. These measurements include energy consumption and a cost analysis.

##### 3.3.1.1 Energy Consumption

In the past, all of the stairways in both the CIS offices and factories have been illuminated by fluorescent lights. Some of these lights fluorescent tubes have been replaced with LED strips a couple years ago but the illumination they currently provide is too low so for this analysis, we assume all the lighting in fluorescent. A single fluorescent lamp consumes 36 watts of electricity. There are 6 factories in CIS and each has one stairway with light fixtures on the landings comprised of one or two lamps for a total of 12 fluorescent lamps per stairway. This totals 72 fluorescent lamps in the stairways of CIS. Their service time is 12 hours per day. The total energy consumption is:

$$P_{flu} = 36 \cdot 10^{-3}kW \times (12 \times 22 \times 12) \frac{h}{yr} \times 72 = 8211.5kWh$$

##### 3.3.1.2 Cost Analysis

The wholesale unit price of one 36W fluorescent lamp is ¥5 and its life span is about 6000 hours. Thus the yearly cost of lighting the stairways is:

$$\text{lamp cost: } C_1 = a \times \frac{n}{N} = 5 \times 2 \times \frac{12 \times 22 \times 12 \times n}{6000} \times 36 = \text{¥}190.1n$$

$$\text{power cost: } C_2 = p \times t \times b = 0.072KW \times (12 \times 22 \times 12 \times n) \times 36h \times 0.875/(KW * h) = \text{¥}7185.0n$$

$$\text{lighting cost: } C_{inc} = C_1 + C_2 = \text{¥}7375.1n$$

The stairway lighting cost of CIS is ¥7375.1 per year.

#### 3.3.2 Cause of Premature LED Degradation

In order to find the cause of the premature LED degradation, existing LED stairway lighting was taken down for inspection. Three criteria of inspection were considered: LED, drive circuit, and mechanical structure. For LEDs, because there were no specifications of their performance, similar low power LED was compared. The background suggested that the

capability to supply constant current is the key function of the drive circuit in order to prevent premature LED degradation and achieve long lifespan that companies advertize. The drive circuit was taken apart and analyzed by individual components and as a whole. There was no dedicated mechanical structure for the LEDs. The LEDs and drive circuit were held together by the breadboard which was directly screwed onto the fluorescent light fixture. We know one of the biggest causes of the premature LED degradation is the thermal runaway. Without a dedicated mechanical cooling device, premature LED degradation is inevitable.

With this knowledge observed, a new stairway lighting device is to be created while overcoming the problems suffered by the existing stairway lighting.

### 3.3.3 Enhance Stairway Lighting

Illuminance provided by the already existing LED application in the stairway is unknown. The device was already permanently disassembled before the lux meter was acquired. A good estimate, based on other measurements using the lux meter, is 15 lx at maximum. The goal of this work is to enhance the illuminance in the stairway to 80 lx (according to Australian Standard 1680) by creating a new light fixture with an improved drive circuit (E circuit) for the LEDs and by designing a suitable mechanical structure.

#### 3.3.3.1 LED Selection

Similar to the factory task light, LEDs were chosen based on what was available in local market and luminous efficacy. Because of the long distance between the light fixture and the stairs, LEDs capable of a high luminous intensity were necessary. Two types of LEDs with the highest luminous efficacy were chosen to be tested: 0.5W LED and 1W LED. (Appendix G)

#### 3.3.3.2 0.5W LED Test

A test was conducted on 0.5W LEDs to measure and calculate the illuminance 0.5W LEDs provide. The method chosen to conduct this test was to create a simple circuit to power the LEDs and project the light on a white wall 3 meters away in a dark room and measure the illuminance using lux meter. A 12 V AC to DC transformer with a 500 mA maximum current, provided by company, was connected to 220V AC power source. The actual output voltage of the transformer measured with a multimeter turned out to be 8.82 V. A simple circuit was created to verify the LED performance. The circuit consisted of the power supply (8.82V) in series with a current limiting resistor and LED(s).

The data sheet provided by the LED manufacturer recommended 150 mA as maximum constant current supply. First, a theoretical resistance value of the resistor was calculated using the average voltage drop of an individual LED which was 3.2 V. For a single LED, the theoretical R turned out to be 37.5  $\Omega$  (from Ohm's Law,  $V = IR$  where  $V = 8.82 - 3.2$  and  $I = 0.15$ ). The actual resistance used to achieve 150 mA was 32.5  $\Omega$  and a single LED was capable of

providing 2 lx at 3 m away. For 2 LEDs, the theoretical resistance of the resistor was  $16.1 \Omega$  ( $V=8.82-(3.2*2)$ ,  $I= 0.15$ ). The actual resistance needed to achieve 150 mA was  $16.5 \Omega$  and the two LEDs were capable of providing 4 lx at 3m away.

Unfortunately, this circuit was not sufficient to test three or more LEDs because the power source (8.82 V) was not enough to power three LEDs, which require 9.6 V. To overcome this problem, LEDs were connected in parallel. When three LEDs were connected, it provided 6 lx, and when four LEDs were connected, it provided 8 lx.

From this simple circuit test, the additive property of light was verified and we learned that a single 0.5 W can provide 2 lx at a distance of 3 meters.

### 3.3.3.3 E Circuit Application

After acquiring 1 W LEDs and components for the E circuit, a series of tests involving 0.5 W and 1 W LEDs were conducted using E circuit. They were to establish how many of each LEDs were needed to fulfill a minimum of 80 lx in the stairway and to compare and contrast 0.5 W and 1 W LED performance. The light provided by the LEDs, was projected to a white wall 3 meters away in a dark room and the illuminance was measured using lux meter. The room used for testing was not completely dark. The existing illuminance measured at the wall was 2 lx.

For the first test, the current was set to 150 mA and 0.5 W LEDs were added to the circuit one by one the illuminance was measured at 3 meters away.

Table 3: Illumination for 0.5 W LEDs at 3 m

| # of LEDs | Illuminance (lx) |
|-----------|------------------|
| 1         | 4                |
| 2         | 6                |
| 3         | 8                |
| 4         | 10               |
| 5         | 12               |
| 6         | 14               |
| 7         | 16               |
| 8         | 17               |

The results in Table 3 suggested that each 0.5W LED ran at 150mA is capable of providing 2 lx at 3 meters away. In order to achieve 80lux, at least 40 0.5W LEDs are required. Starting from the sixth LED added to the circuit, the components in the E-circuit started to get hot. This indicated that the circuit might be overloaded and energy was being wasted. From this knowledge, it was decided that it is best to only put five 0.5W LEDs in series

1W LEDs were tested in a similar manner as 0.5W LEDs. Recommended maximum constant current supply was 350mA. First, the current E circuit can sustain was tested. A single 1W LED was connect to E circuit and the resistance of R3 (Figure 9) was varied to measure the different current. A  $100 \Omega$  variable resistor replaced R3 to allow varying the resistance easily and

a 1Ω resistor was connected in series with the LED to measure the current using Ohm's Law (by measuring the voltage drop across the 1Ω resistor and dividing that by the resistance).

E circuit had no problem getting the current up to 300mA but the components in the E circuit were getting hot. A current of 245mA was the point where the components started to heat up. 220mA was chosen as safe current to run the 1W LEDs. In order to achieve 220mA, a 15Ω resistor was used for R3.

With the current set to 220mA, 1W LEDs were added one by one to test their performance under similar condition as 0.5 W LEDs.

**Table 4: Illumination of 1 W LEDs at 3 m**

| # of LEDs | Illuminance (lx) |
|-----------|------------------|
| 1         | 7                |
| 2         | 12               |
| 3         | 17               |
| 4         | 21.5             |
| 5         | 27               |
| 6         | 31.5             |
| 7         | 36               |
| 8         | 41               |

The results in Table 4 suggested that a 1 W LED run at 220 mA is capable of providing 5 lx at 3 meters away. This means at least 16 1 W LEDs are needed to achieve a minimum of 80 lx at the stairway. Similar to the 0.5 W LED test, E circuit started to heat up starting with the sixth LED added. With this knowledge, it was decided that five 1 W LEDs are the maximum number that should be put in series. Sixteen is not a multiple of five, so it was rounded up to nearest multiple of five, which was 20, to perform LED selection analysis. In the end only 15 LEDs were used, providing 75 lx by itself because the illuminance was increased to match the standard by using reflectors instead of increasing the number of LEDs to 20.

### 3.3.3.4 LED Selection Analysis

Table 5: 0.5 W and 1 W LED Comparison

|                     | 0.5 W | 1 W    |
|---------------------|-------|--------|
| # LEDs              | 40    | 20     |
| Illuminance per LED | 2lx   | 5lx    |
| Total Illuminance   | 80lx  | 100lx  |
| # Strings           | 8     | 4      |
| Forward Current     | 150mA | 220mA  |
| Total Current       | 1.2A  | 0.88A  |
| Forward Voltage     | 3.2V  | 3.4V   |
| Power               | 19.2W | 14.96W |

From Table 5, 1W LEDs are capable of providing more illumination for the power consumed. Also, since 1W LEDs are running well below 350mA, the recommended maximum constant current, the LEDs will have lower junction temperatures resulting in a longer life span. Just by looking at the LED performance, 1 W LEDs are definitely a better and more efficient choice compared to 0.5 W LEDs in the stairway lighting application.

### 3.3.3.5 Final Circuit Design

Based on testing and analysis, Figure 21 shows the final circuit design for the stairway consisting of three parallel strings of five 1 W LEDs in series

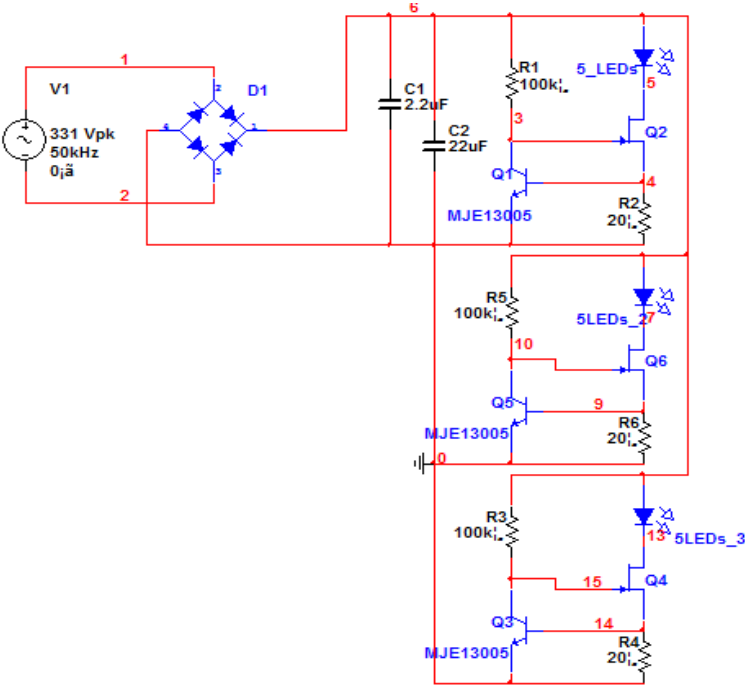

Figure 21: Final Circuit Design for Stairway Light Fixture

## Chapter 4: Results

This chapter presents the results of the project including causes of premature LED degradation, prototypes of an LED factory task light, stairway light as well as a special light for the 400 ton machines. Also included are analyses of our prototypes in terms on energy consumption, cost, and light quality.

### 4.1 Premature LED Degradation

After an investigation of the existing LED lighting in the stairway, a very simple circuit was discovered to power the LEDs. Sixteen strings were connected in parallel to each other off of an AC to DC transformer that provided 12 V at 500 mA. Each string consisted of three unknown low power LEDs in series with a 100  $\Omega$  resistor. Using a multimeter, the actual voltage measured across transformer was 8.82 V and the current measured in each string was 11.13 mA. According to background research, average low power LEDs run at 20 mA. Since current and luminous flux are directly proportional, a current lower than 20 mA will inevitably cause the LEDs to be dimmer. According to the company, the LED lights in the stairway used to be brighter. This means one or more problems caused the current to fluctuate or degrade the LEDs. The average ambient temperature measured in the stairway was approximately 32 degrees Celsius while the normal ambient operating temperature is 25 degrees Celsius for an average LED. On hot days, the temperature measured was as high as 36 degrees Celsius. This may have affected the LED junction temperature greatly, degrading the LEDs.

Mechanically, there was no cooling system for the lighting device. Without a proper cooling system, the junction temperature of LED will increase leading to thermal runaway. Also, there was no ventilation such as an open window in the stairway area so during hot summer days, the heat will be insulated and affect the ambient temperature greatly.

The driving circuit itself had a major problem of its own. There was no constant current supply. Without a constant current supply, the circuit becomes very sensitive to temperature change and the current will fluctuate leading to thermal runaway which greatly affects the LED performance.

For the altered color of LEDs, the cause is the low driving current. Compared to 20 mA, the average low power LED forward current, 11.13mA is very low. The lower the forward current, the more noticeable the color differences between LEDs become. Because the LED manufacturers are not capable of making identical LEDs, the color may differ a little bit between individual LEDs.

Lastly, what caused the three dead LEDs in a row is one dysfunctional LED. This circuit was made to have three LEDs per series string. If at least one of the LEDs fails, the whole string becomes an open circuit making the other two LEDs go out. What caused one LED to fail is unknown. Perhaps one LED was manufactured with a defect or was manufactured poorly so that it was not capable of sustaining such a high current caused by one of the reasons discussed above.



## 4.2 Prototypes

After a theoretical design, several prototypes were constructed and subsequently modified. Descriptions of these for both the factory task light and stairway light are found in this section.

### 4.2.1 Factory Task Light

The first factory task light prototype was tested on the factory floor but a couple problems were noted. A second iteration was then constructed and chosen as the final design. A special task light with a narrow beam angle was also constructed for use of the two 400 ton machines.

#### 4.2.1.1 First Prototype Test

The first prototype was constructed using seven LEDs fixed on a circular aluminum base plate. The aluminum plate was designed specifically for mounting power LEDs and was purchased at the market. The LEDs were mounted on the base using the thermal grease and then soldered which provides both a good electrical connection and holds the LEDs in place. This light fixture was designed only to test the light quality and lacks a practical housing and adequate heat sink. A photograph of this prototype not including the circuitry is shown in Figure 22. The driving circuit and transformer were mounted separately on a PCB for this test and connected to the light fixture only by wires. The forward current was measured to be 180mA.



Figure 22: First Prototype

The light fixture was used in place of the existing factory task light on various machines and its effects were observed. In particular, two problems were discovered. The first was that the light source was visible to the operator with an uncomfortably high luminous emittance and the second was that the illuminance was too low.

#### ***4.2.1.2 Problem of Bright Visible Light Source***

Thus far, we have ignored one photometric quantity and that is the luminous emittance ( $M_v$ ) of the light source defined as luminous flux per unit area of emittance. Since it is a luminous flux per unit area is also measured in lux, but it has a very different meaning and very different values than illuminance. The luminous emittance of an LED can be on the order of 1,000,000 lx. It can be thought of as a measure of how uncomfortable a light source is to look at. So far we have assumed the lamps to be a point source which is a reasonable assumption for illuminance and beam distribution purposes but not for when the light source is viewed directly. A fluorescent tube has a relatively large area of emittance (the surface area of the tube) giving it a low luminous emittance making it comfortable to look at. A laser pointer, on the other hand, has a very small area of emittance making it not just uncomfortable but also dangerous to look at directly. An LED emits light from an area of only about a few square millimeters making it appear as an uncomfortably bright spot in one's field of vision. This is only a problem if the eye falls within the beam angle of course. Looking at a laser pointer from an angle causes no discomfort.

To solve the problem of the LEDs being visible and having a high luminous emittance, four solutions were brainstormed. They follow one of two approaches; making the light source not visible to the operator, or lowering the luminous emittance by increasing the area of emittance. Following the former approach, the beam angle could be narrowed or a shade could be added. Following the later approach, a greater number of less bright LEDs could be used or a diffuser could be added.

Narrowing the beam angle is easily achievable using lenses or reflectors that are both available at the market and designed for use with power LEDs. The advantages of this method is that there is almost no loss of luminous efficacy and decreasing the beam angle will also increase the luminous intensity which will help solve the problem of low illuminance. This, of course, will decrease the area of illumination, but the area illuminated with just the LEDs was unnecessarily large so this is okay. This will only work, of course, if the lamp is viewed from outside the beam angle.

Adding a shade is an easy fix for this problem but it has some drawbacks. If the shade is reflective, it is essentially a just a large and poor reflector decreasing the beam angle. If it is not reflective, it will absorb light as heat and decrease the beam angle without any gains in luminous intensity. Either way, a lens or small reflector for each LED is a more compact and efficient method.

Using lots of low power LEDs as opposed to a few high power LEDs to get the same luminous flux will lower the luminous emittance by a factor equal to the ratio of the number of low to high power LEDs. To get a luminous emittance as low as we want may require a very large number of LEDs which would require a larger light fixture to fit them all. Having more LEDs would make manufacturing the light fixture more difficult and would increase the likelihood that an LED will fail. The 1 W power LEDs were also chosen because of their high luminous efficacy and low costs so switching to lower powered LEDs would use more energy and be more expensive.

Adding a light diffuser in front of the lamp would increase the area of emittance to the area of the diffuser. This would probably be the most pleasing to look at and it would also emit a softer light. However, it will absorb some of the light decreasing the luminous efficacy. It will also severely inhibit convective heat transfer from the front of the lamp and may widen the beam angle.

#### **4.2.1.3 Problem of Low Illuminance**

The second problem discovered from the test was simply that the illuminance of the work piece was too low. The solution, though, is straightforward. Illuminance is dependent only on the distance from the light source and the luminous intensity. Since we are using the existing gooseneck structure, the distance is fixed, so we must increase the luminous intensity. There are two ways to increase the luminous intensity; increase the number of LEDs or decrease the beam angle. Since the beam angle is wider than necessary, decreasing it is the better option. Adding more LEDs would waste energy by emitting light at wide angles that will never fall on the work piece.

The above assumes the current cannot change, however that is not the case. At the time of this test, the maximum current we could provide was only 180 mA which is far below the maximum rating of 350 mA for these LEDs. Luminous intensity increases linearly with current so a larger current would be the best solution. The circuit design was still being modified and improved at the time of this test, so for the second prototype, a higher current should be achievable. Decreasing the beam angle is a good solution for both problems encountered in the initial test so that will also be a focus of our second prototype. If problems persist after the second prototype test, other measures can be taken such as adding more LEDs and using a diffuser.

#### **4.2.1.4 Second Prototype Test**

By the time of our second prototype, a circuit capable of outputting 295 mA was created and used. This is only 84% of the absolute maximum rating of 350 mA (and thus about 84% of the maximum temperature and luminous flux) but we think this will be best as long term

reliability is important for these light fixtures and running them at below the maximum rating is a good way to increase the lifespan as is seen in Figure 15.

The main physical difference is the addition of a heat sink purchased at the market. This heat sink is meant for use with power LEDs and is similar to the one we designed. Purchasing this heat sink was much more cost and time effective than manufacturing our design. Also purchased was a plastic E27 screw cap that attaches to the back of the heat sink. This allows the light fixture to be easily mounted to the existing structure used at CIS and make use of the existing toggle switch. This whole assembly is seen in Figure 23. The heat sink also acts as a reflector and shade and may decrease the beam angle enough to solve both of the problems encountered in the first prototype test.



Figure 23: Second Prototype

After being left on for a long time, the heat sink was quite warm. The exact temperature could not be measured but it felt less than 80 °C. The base of the LEDs and the heat sink felt about the same temperature meaning the thermal resistance was low and the junction temperature of the LEDs was surely below the maximum operating temperature.

Once again, this light fixture was used in place of the existing factory task light on various machines and its effects were observed. This time, there were no problems on the 25, 80, or 200 ton machines. The light quality data collected can be found in Appendix J. The average illumination the light fixture provided was 55 lx giving a total average illumination of 63 lx. More important than numbers, the machine operators were all satisfied with the area illuminated, color, and had no complaints.

#### 4.2.2 400t Machine Light

There are also two 400 ton machines at CIS that require special lights with narrow beam angles since they cannot be mounted close to the work piece. The machine with the light

mounted on the right is seen in Figure 24. Because there were only two of these machines, we did not make it an objective to design light fixtures specifically for them, however, it proved to be an easy side project.



**Figure 24: 400t Machine and Existing Light**

Purchased at the market were lenses to narrow the beam angle and a frame that attaches to the heat sink and holds lenses in place for 6 LEDs. This is shown assembled in Figure 25.



**Figure 25: 400t Machine Light Prototype**

The light fixture with the lenses was determined to have a beam angle of 49 degrees. This is far too narrow to replace the general factory task lights, but it was perfect for the 400t machines illuminating the right sized area. The lenses also boosted the maximum luminous intensity to 975 cd, so the illumination was still sufficient despite the long distance between the



light and the work piece. Complete photometric data for this prototype can be found in Appendix F. One of the 400t machines equipped with our LED light prototype (Figure 26) is currently being used at CIS without any problems.

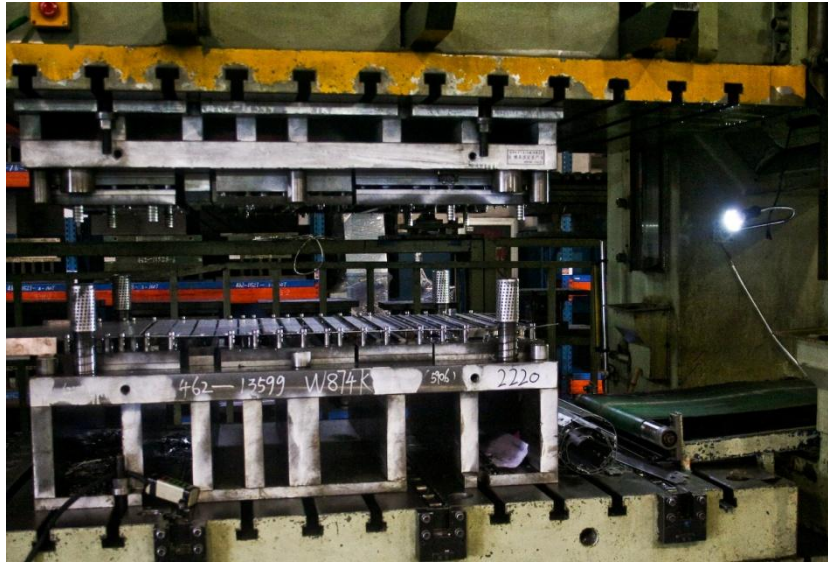

Figure 26: 400t Machine and LED Light Prototype

### 4.2.3 Stairway Light

When our prototype was first installed in the stairway, we were very satisfied and the company was also very satisfied. Later that day, the prototype was visited once more. Compared to its initial performance, one string (consisting of 5 LEDs) was very dim. The prototype was immediately taken down for an inspection. Three conditions were suspected: E circuit failure, stripped wires touching each other, or one or more individual LED failure. First, the LEDs and the circuits were taken out from the mechanical structure. All the wires were sorted out but one string was still experiencing circuit failure. Then, all individual LEDs in the string were tested using a multimeter to check if the current was being passed through the LEDs. All LEDs passed the test which meant that the problem lied in the specific E circuit which the dimmed LEDs were connected to. To verify the problem, an E circuit from a working string was connected to the specific LEDs which were dimmed. All the LEDs lit up as before, confirming that cause of the failure derived from that specific E circuit. E circuit was questioned once more whether it was suitable for this kind of LED application. Considering that other strings were working properly and the factory task light was performing well, E circuit is suitable for this type of LED application and the cause of the failure only lied within that specific E circuit. To verify this, the E circuit suffering a problem was connected to the LEDs that were working properly. Surely, the LEDs were very dim. Because all the components in the circuit were well soldered, it was impossible to test which component or components have failed. Our best guess was that because

this E circuit took part in rigorous testing of 1W and 0.5W LEDs and E circuit performance, it had already been degraded. Other E circuits used in the prototype were newly built. After replacing the failed E circuit with a newly built E circuit, the prototype was working well once again.

### 4.3 Energy and Cost Analysis

The sections below detail the energy consumption and costs for the LED factory task light and stairway light as well as the total cost savings.

#### 4.3.1 LED Factory Task Light

For our second and final LED factory task light prototype, an energy and cost analysis was performed. This analysis assumes all factory task lights in factory one would be replaced with our prototype.

##### 4.3.1.1 Energy Consumption

The power consumed by the factory task light was measured to be 8.9 W. Compared to the existing 60 W incandescent lamp, this saves a lot of energy, 85.2% to be exact.

Total energy consumption of LED factory task lights in factory one per year is:

$$P_{LED1} = 8.9 \times 10^{-3} \text{ KW} \times 3440 \times 12h = 367.392 \text{ KW} * h$$

The energy saving rate is:

$$S_1 = \frac{2476.8 - 367.392}{2476.8} \times 100\% = 85.2\%$$

This only takes into account the task lights in factory one which has to most incandescent lights. More savings could be had if incandescent lights in all six factories were taken into account.

##### 4.3.1.2 Cost Analysis

The prototype cost of the factory task light is broken down in Table 6. It totals ¥91.3. This is a little expensive because all components were purchased at retail price. If this kind of LED light is widely used, all components could be bought at wholesale prices, and the lamp cost would be reduced. The transformer is a significant percentage of the cost. If a higher power transformer is used, all of the LED lights can share it, reducing the average transformer cost per factory task light. Another option would be to develop a circuit without a transformer. This would save both capital cost and increase efficiency reducing the operating costs as well.

Table 6: Factory Task Light Prototype Cost

| Components               | Type       | Quantity | Unit price | Cost        |
|--------------------------|------------|----------|------------|-------------|
| Transformer              | 24V/20W    | 1        | 15         | 15          |
| Diodes                   | IN4007     | 4        | 0.1        | 0.4         |
| Capacitors               | 400V/100uF | 1        | 0.8        | 0.8         |
|                          | 400V/2.2uF | 2        | 0.8        | 1.6         |
| Linear Voltage Regulator | 7824       | 1        | 2          | 2           |
| Resistors                | 40K Ohm    | 3        | 0.3        | 0.9         |
|                          | 0.75 Ohm   | 2        | 0.3        | 0.6         |
| Transistor               | MJE13005   | 1        | 1.5        | 1.5         |
| MOSFET                   | IRF840     | 1        | 2.5        | 2.5         |
| LEDs                     | 3.4V/1W    | 6        | 6          | 36          |
| Lampshade                |            | 1        | 25         | 25          |
| LED light board          |            | 1        | 5          | 5           |
| <b>Total Cost</b>        |            |          |            | <b>91.3</b> |

Using the factory task light prototype, the yearly lighting cost of factory one is:

$$C_{LED1} = C_1 + C_2 = \text{¥} \left[ \left( \frac{3440 \times 12 \times n}{60000} \right) \times 91.3 + 8.9 \times 10^{-3} \text{kw} \times (3440 \times 12 \times n) \text{h} \times 0.875 / (\text{kw} * \text{h}) \right]$$

$$= \text{¥}384.3n$$

Lighting cost saving from factory one per year is:

$$\Delta C_1 = C_{inc} - C_{LED1} = \text{¥}1802.7n$$

The lighting cost can be reduced significantly by using our LED factory task light design. However, replacing incandescent lamps with our prototype will demand a high capital cost. The capital cost is higher than the cost saving in one year so we should consider the payback period and return on investment (ROI).

The capital cost is:

$$I_1 = \text{¥}91.3 \times 26 = \text{¥}2373.8$$

The payback period is:

$$\Delta C_1 = I_1 \quad \Rightarrow \quad n = 1.3 \text{ years} = 16 \text{ months}$$

The return on investment is:

$$ROI_1 = \frac{\text{annual cost saving}}{\text{total investment}} \times 100\%$$

$$= \frac{1802.7}{2373.8} \times 100\%$$

$$= 75.94\%$$



Figure 27 shows the total costs of the existing factory task lights in blue and the LED prototype in red over a five year period in factory one. The payback period is the time at which the two lines intersect (1.3 years). From that point on, the cost savings to date is simply the difference between the two lines at that time.

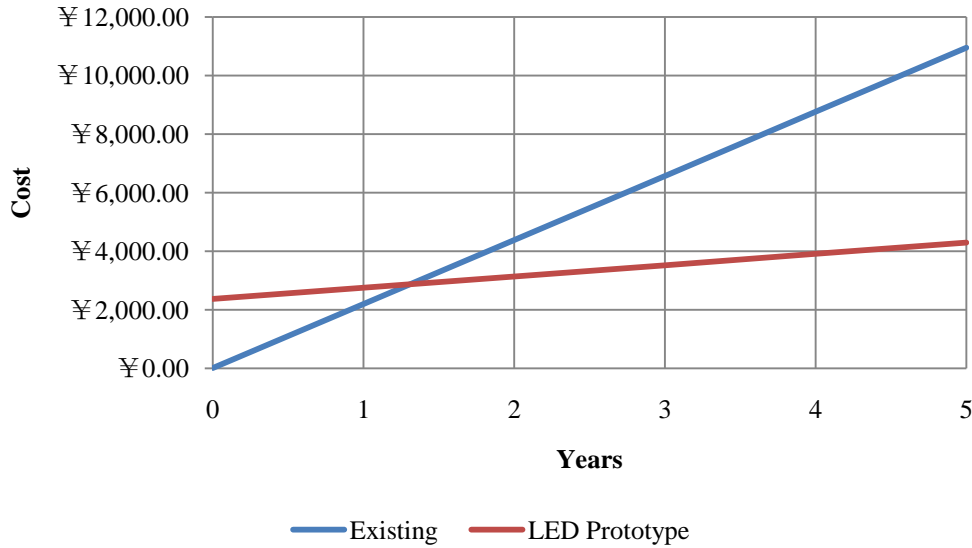

Figure 27: Existing vs. LED Prototype Factory Task Lighting Cost Over 5 Years

The above analysis shows that using LED factory task lights have many advantages. First, it is environmentally friendly (the energy saving is as high as 85.2%). Second, the payback period is only 16 months and the ROI is as high as 75.94%. Most of all, the cost saving for factory one task lighting per year is ¥1802.7.

### 4.3.2 LED Stairway Light

Similarly to the task lights, energy and cost analysis were performed assuming our LED stairway light was used in all six stairways. For the analyses, our LED stairway light is compared to fluorescent lights, not the LED strips that took the place of some fluorescent lights a couple years ago.

#### 4.3.2.1 Energy Consumption

Our Stairway LED light fixture design uses 15 1 W LEDs and only consumes 22 W. It illuminates the stairs as well yet it saves 38.9% on energy consumption. The total energy consumption using the LED stairway light prototype per year is:

$$P_{LED2} = 22 \times 10^{-3} \text{ KW} \times (12 \times 22 \times 12 \times n) h \times 72 = 5018.112 \text{ KW} * h$$

The energy saving rate is:

$$S_2 = \frac{8211.456 - 5018.112}{8211.456} \times 100\% = 38.9\%$$

### 4.3.2.2 Cost Analysis

The cost of the LED stairway light prototype is broken down in Table 7. It totals ¥144.8. This is also a high estimate of what this would cost if widely used since components were purchased at retail, not wholesale, prices. Once again, costs can be reduced if multiple lights share one transformer.

Table 7: Stairway Light Prototype Cost

| Material           | Type                | Quantity | Unit price(¥) | Cost(¥) |
|--------------------|---------------------|----------|---------------|---------|
| <b>Transformer</b> | 24V/30W             | 1        | 25            | 25      |
| <b>Diode</b>       | IN4007              | 4        | 0.1           | 0.4     |
| <b>Capacitance</b> | 400V/22uF           | 1        | 0.8           | 0.8     |
|                    | 400V/2.2uF          | 1        | 0.8           | 0.8     |
| <b>Resistance</b>  | 100K Ohm            | 3        | 0.3           | 0.9     |
|                    | 100 Ohm(adjustable) | 3        | 0.5           | 1.5     |
| <b>Triode</b>      | MJE13005            | 3        | 1.5           | 4.5     |
| <b>Mosfet</b>      | IRF840              | 3        | 2.5           | 7.5     |
| <b>LED</b>         | 3.4V/1W             | 15       | 6             | 90      |
| <b>Total cost</b>  |                     |          |               | 131.4   |

The annual cost of lighting the stairways with our LED prototype is:

$$\begin{aligned}
 C_{LED2} &= C_1 + C_2 \\
 &= \text{¥} \left[ \left( \frac{12 \times 22 \times 12 \times n}{60000} \right) \times 72 \times 131.4 + 22 \times 10^{-3} \text{KW} \times (12 \times 22 \times 12 \times n) \times 72h \times 0.875 / (\text{KW} * h) \right] \\
 &= \text{¥} 4890.4n
 \end{aligned}$$

The lighting cost saving per year is:

$$\Delta C_2 = C_{flu} - C_{LED2} = \text{¥} 2484.7n$$

The lighting cost can be reduced a lot through using stairway LED lighting instead. However, installing stairway LED lighting will demand high capital cost. The payback period and return on investment (ROI) concerning the capital cost is as follows.

The cost of installing stairway LED lighting is

$$I_2 = \text{¥} 131.4 \times 72 = \text{¥} 9460.8$$

Payback period is

$$\Delta C_2 = I_2 \quad \Rightarrow \quad n = 3.8 \text{ years} = 46 \text{ months}$$

Return on investment is

$$\begin{aligned}
 ROI_2 &= \frac{\text{annual cost saving}}{\text{total investment}} \times 100\% \\
 &= \frac{2484.7}{9460.8} \times 100\% \\
 &= 26.3\%
 \end{aligned}$$

Figure 28 shows the total costs of the existing stairway lights in blue and the LED prototype in red over a five year period. The operating costs of the two are closer than with the factory task lights as seen by the similar slopes. This is because fluorescent lights are much more efficient than incandescent bulbs. Our LED prototype is more efficient yet with a payback period of 3.8 years.

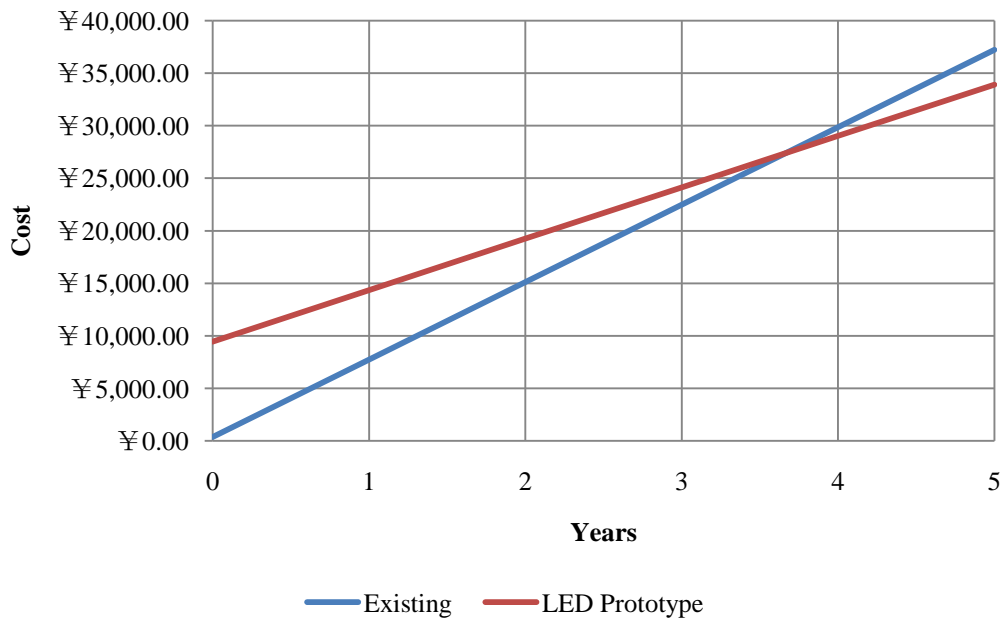

Figure 28: Existing vs. LED Prototype Stairway Lighting Cost Over 5 Years

The higher efficiency of our LED prototype is not due entirely to its luminous efficacy. In fact, the luminous efficacies of the two lights are similar but the LED prototype used this light more efficiently. A narrower beam angle was used to concentrate the light on the stairs and not waste energy unnecessarily illuminating the walls.

From the above analysis, LED lighting in the stairway has proven to both save energy and money. First, it is environmentally friendly (the energy saving is 38.9%). Second, the ROI is as high as 26.3% and the payback period is 46 months. Most of all, it will save the company ¥2484.7 a year.

#### 4.3.3 Total Lighting Cost Savings

From the cost analysis in sections 4.1.1 and 4.1.2, it follows that the total lighting cost saving for CIS every year is:

$$\Delta C = \Delta C_1 + \Delta C_2 = \text{¥}4287.4n$$

The combined payback period for the combination of both factory task lights and stairway lights is about two and half years.

Considering the time value of money, the company could put the lighting cost savings money into Bank of China with a 2.25% interest rate. Assuming that the interest rate is constant, after 10 years, the savings is:

$$\begin{aligned}
 F &= A(1+i)^{n-1} + A(1+i)^{n-2} + \dots + A \\
 &= A \frac{(1+i)^n - 1}{i} \\
 &= 4287.4 \times \frac{(1+2.25\%)^{10} - 1}{2.25\%} \\
 &= \text{¥}47,486.0
 \end{aligned}$$

Considering that the ROI and energy saving rate are high, it is environmentally friendly. If CIS changes all lights into LED lights, the lighting cost saving will be even more. From the aspect of cost saving and energy saving, it is worthwhile in the long term.

#### 4.3.4 Cost Projection

The cost analysis in 4.1.1.2 shows that the lighting cost includes the initial light fixture cost, energy costs, and the cost to replace the lamps. They are as follow.

$$\begin{aligned}
 \text{lamp cost: } C_1 &= a \times \frac{n}{N} \\
 & \quad a - \text{unit price of lamp} \quad n - \text{using time} \quad N - \text{life span}
 \end{aligned}$$

$$\begin{aligned}
 \text{power cost: } C_2 &= p \times t \times b \\
 & \quad p - \text{power of every light} \quad t - \text{using time} \quad b - \text{unit price of electric power}
 \end{aligned}$$

$$\text{lighting cost: } C = C_1 + C_2$$

With the development of LED technology, the unit price of a lamp will be decreased and the life span of an LED may be longer. This will reduce the cost of the light. In addition, predicted increases in luminous efficacy (Figure 3) will reduce the energy costs even more. Also, the unit price of electricity might also be increased over time because of the lack of energy sources. This makes LEDs a better choice over all.

#### 4.4 Light Quality

While reducing energy consumption and costs are the main focus, it is important that the quality of light not be sacrificed. The following compares the quality of light provided by the prototypes compared to the existing factory task lights and stairway lights.

##### 4.4.1 Factory Task Light

The final LED prototype was able to produce a maximum luminous intensity of about 157 cd with a beam angle of about 97 degrees. The estimated luminous flux of this light is 400 – 500 lm. During factory tests, this light was also able to provide an average illuminance of 55 lx on the work piece compared to only 31 lx provided by the existing factory task light. The percent change in illuminance that our prototype provided compared to the existing factory task light by machine size is shown in Table 8.

**Table 8: Percent Change in Illuminance by Machine Size**

| Machine Size    | From Light Only | Total       |
|-----------------|-----------------|-------------|
| 25t             | 867%            | 250%        |
| 80t             | 208%            | 160%        |
| 200t            | 227%            | 200%        |
| <b>AVERAGE:</b> | <b>434%</b>     | <b>203%</b> |

As can be seen, the average total illuminance more than doubled with the use of the LED light fixture. This seems to not make sense as the LED light fixture was not as bright as the existing incandescent one during a lab test. One probable explanation is that the existing task lights on the machine may have degraded over time emitting less light than the new one tested. Another possibility is that the existing lights were positioned in a worse place on the machine than where the LED lights were tested.

An overlay of the beam distribution graphs for the two lights (from Appendix D and E) is shown in Figure 29. It can be seen that the LED light is less intense over all angles but its light is more even as the slope is less steep. A more visual comparison of the beam distribution can be seen in Figure 30.

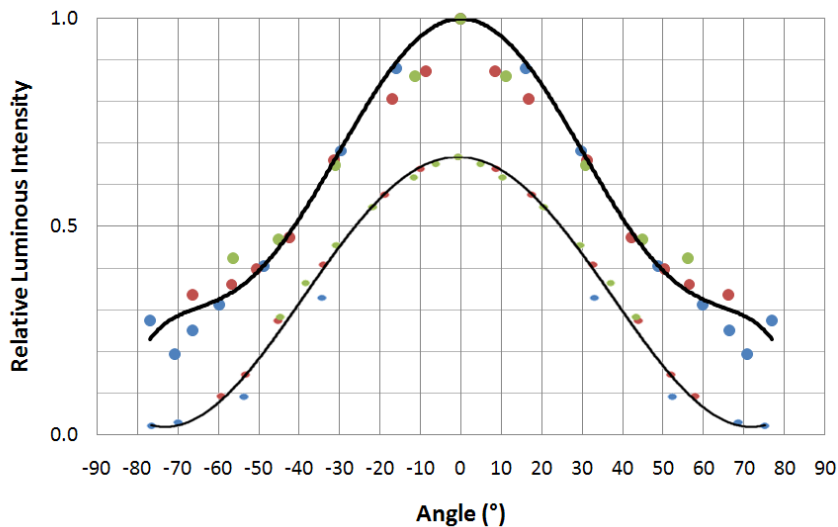

**Figure 29: Factory Task Light Beam Distribution Comparison**



**Figure 30: Factory Task Light Visual Comparison**

Even though the LED light fixture was not as bright as the existing one, the illuminance was greater and that is what actually matters. Assuming this was caused by a slight difference in positioning of the lights, it means the position is an important factor affecting the illuminance. We were told to not move the existing fixture mounts, however, if this could be done, we believe it would provide large improvements in quality of light. One of the main complaints from machine operators was the glare. The only way to reduce the glare without moving the operator would be to move the light. Our prototype not only improved the illuminance but also the color. Many operators felt the existing light was too yellow. Our prototype is closer to a pure white with a slight blue color. Everyone surveyed thought the color from the LED light was okay.

#### **4.4.2 Stairway Light**

The prototype of the LED stairway light was capable of providing 80 lx on the stairway floor in CIS compared to only a couple lux provided by the degraded LED lights currently in use. To achieve this result, 15 1W LEDs were used running at 220mA. This result was very successful because the illuminance was equal to that of the fluorescent light while consuming less power. More details of the power consumption analysis are in section 4.1.2.2.

## Chapter 5: Conclusion

This project can be considered a success as measured against our goals and objectives. An LED prototype was developed to replace the existing factory task lights which did provide more illumination. The lifespan of such a light is difficult to predict but all the measures were taken to ensure that it is as long as possible. These measures were maintaining a low junction temperature, and supplying a constant current as well as running the LEDs below their maximum rating. This prototype, like other LEDs, should last about 50 times longer than the existing incandescent task light. It has also been tested and determined to consume 85% less electricity.

The cause of the dimming LEDs in the stairway was determined to be permanent degradation due to a high junction temperature caused by a combination of a poor circuit and ambient conditions. A new design was determined to be the best way to improve the illumination so an LED light was prototyped that was able to provide 80 lx on the stairs while consuming 39% less power than the previous fluorescent lights.

From this we can conclude that, in accordance with our goal, the proper application of LEDs as factory task lights and stairway lights can be effective to make CIS more green, improve the quality of existing light, and reduce costs with savings being had after a payback period of two and a half years.

### 5.1 Future Recommendations

This project only lasted seven weeks, but there is much more work that can be done. Here are recommendations for future LED light fixture designs and how CIS should proceed with the application of LEDs to be green.

#### 5.1.1 LED Light Fixture Design

The main area of improvement for our LED light fixture design is the circuit. None of us had a strong electronics background yet the circuit ended up being one of the more important considerations. The efficiency of our circuit was low and a large contributor to this was the transformer. An alternative to a transformer that should be looked into is a switch-mode power supply such as a buck converter. They offer higher efficiencies (up to 95%) as well as a smaller size. Their use of an integrated circuit could also increase the efficiency and reliability. Other improvements include the addition of some sort of overvoltage protection in the event of a power surge. A thermistor can be used in the circuit to further regulate the current. The properties of a transistor will change with temperature therefore changing the output current, but this can be kept constant using an integrated circuit and a thermistor. Pulse width modulation (PWM) driving of LEDs is also something that should be looked into and tested. LEDs can handle a much higher current at lower duty cycles. Some claim LEDs can be run brighter and more efficiently this way. Exactly how much current and at what duty cycle an LED can handle and its effects on the lifespan are largely unknown. Predicting this would involve complicated

semiconductor physics and could be an MQP in itself. PWM (at the recommended current) can also be used to dim LEDs without affecting the color. Incorporating PWM dimming and a dimming knob on the light fixture could be an effective way to save power at times when the full brightness is not needed.

For the mechanical design, a more efficient heat sink could be designed. We lacked accurate temperature measuring equipment, but a thermocouple mounted at the LED base would be useful for experiments to test different designs. With this an, analysis could be done to see if the use of a small electric fan could allow for higher efficiencies. Also, the high luminous emittance is still a bit of a problem, but this can be solved if a high efficiency diffuser can be found and used.

### 5.1.2 Implementation at CIS

We recommend that CIS use our prototypes in a pilot run and if there are no problems after a year with either abrupt failure or dimming, replace all incandescent factory task lights and fluorescent and dim LED lights in the stairway with LEDs. CIS can either choose to construct lights like ours or purchase ones at the market designed to replace light bulbs or fluorescent tubes. The latter option is easier but one must be careful. There are a few important things to look for that many LED light fixture manufacturers are careless about. First, the LEDs should have a high luminous efficacy. This is easy to determine from the luminous flux and current and voltage ratings found on the datasheet. Second, there needs to be good heat dissipation to keep the junction cool. This can be estimated with a thermocouple or by simply touching the LEDs after they've been on for a while. Finally, there needs to be a good constant current circuit. If there is not, LED lights and circuits can be purchased separately. There are prepackaged circuits available designed specifically for powering LEDs. Things to look for in these circuits are high efficiencies, a constant yet adjustable current, and a power rating that is high enough.

After a yearlong pilot run, LED technology and efficiency will be improved and we recommend CIS reevaluate using LEDs throughout the whole facility. In the stairway, higher efficiencies were achieved because we found ways to eliminate waste light, not necessarily because of a higher luminous efficacy. There may not be this waste light to eliminate in the offices, so any possible savings would come from the cost of the light fixtures. Currently, the LED prototype would be about 5 times more expensive to install and replace compared to fluorescent tubes making fluorescent lights the best option for office lighting at the moment. It will only take slightly more efficient LEDs to make LED lights a better option than fluorescent lights and these LEDs should be a reality after a year or so.



## **Acknowledgements**

### **Karen Xu**

For sponsoring this project and helping us with project management

### **Wang Liying**

For all of her helpful comments at our weekly presentations and consistent attention

### **Mo Jianqing**

For helping to acquire instruments used and helping us to buy components in the local electronics market

### **Workers in CIS**

For their help with finding and fixing electrical and mechanical components

### **Professor Rong**

For setting up MQP in China, helpful advice on the project and, and constantly making sure we are taken care of

### **Professor Gao**

For providing us with a workplace and giving us support when we were in Wuxi

## References

- CIS. (2008). Retrieved June 2009, from Central Industrial Supply: <http://www.cisww.com>
- Cree. (2006). *Cree XLamp LED Thermal Management*. Retrieved July 2009, from <http://www.cree.com/xlamp>
- Embree, D., Kingsley, C., Lu, W., Guo, H., & Deng, Y. (2008). *Led Light Design*. Unpublished Major Qualifying Project . Worcester Polytechnic Institute.
- Inman, M. (2008, February). *Crystal Coat Warms Up LED Light*. Retrieved June 2009, from NewScientist: <http://www.newscientist.com/article/dn13266-crystal-coat-warms-up-led-light.html>
- Rowse, B. (n.d.). *How To Use a Lux Meter*. Retrieved June 2008, from Sustainability Victoria: [http://www.energy-toolbox.vic.gov.au/energy\\_toolbox/summer\\_push/how\\_to\\_use\\_a\\_lux\\_meter.html](http://www.energy-toolbox.vic.gov.au/energy_toolbox/summer_push/how_to_use_a_lux_meter.html)
- Seoul Semiconductor R&D Center. (2008, December 10). Life Time Graph of Z-Power LED.
- Taub, E. A. (2008, July 28). *Fans of L.E.D.'s Say This Bulb's Time Has Come*. Retrieved June 2008, from The New York Times: <http://www.nytimes.com/2008/07/28/technology/28led.htm>
- van der Steen, M. (2007, April). *60W Incandescent Lightbulb*. Retrieved July 2008, from OliNo Renewable Energy: <http://www.olino.org/us/articles/2009/04/07/60w-incandescent-lightbulb>

## Appendix A: Photometric Quantities and Relationships

### Quantities

| Quantity           | Symbol          | Unit    | Abbreviation |
|--------------------|-----------------|---------|--------------|
| Luminous Flux      | $\Phi_v$        | lumen   | lm           |
| Radiant Flux       | $\Phi$          | watt    | W            |
| Luminous Intensity | $I_v$           | candela | cd           |
| Illuminance        | $E_v$           | lux     | lx           |
| Luminous Emittance | $M_v$           | lux     | lx           |
| Beam Angle         | $2\Theta^{1/2}$ | degrees | °            |
| Half Angle         | $\Theta^{1/2}$  | degrees | °            |

### Relationships

$\Phi_v = \int E_v dA = \int I_v d\Omega$  where A is the area of light projection and  $\Omega$  is the solid angle.

$E_v = \frac{I_v \cos \theta}{r^2}$  where  $\Theta$  is the angle measured from the center of the beam and r is the distance from the source

Luminous Efficacy =  $\frac{\Phi_v}{\Phi} = \frac{\Phi_v}{IV}$  where I is the forward current and V is the voltage drop

### Unit Equivalents

$$lm = cd \cdot sr$$

$$lx = \frac{lm}{m^2}$$

### Luminosity Function

for photopic vision (light conditions) in black and scotopic vision (dark conditions) in green. All data used in this report corresponds to the photopic luminosity function.

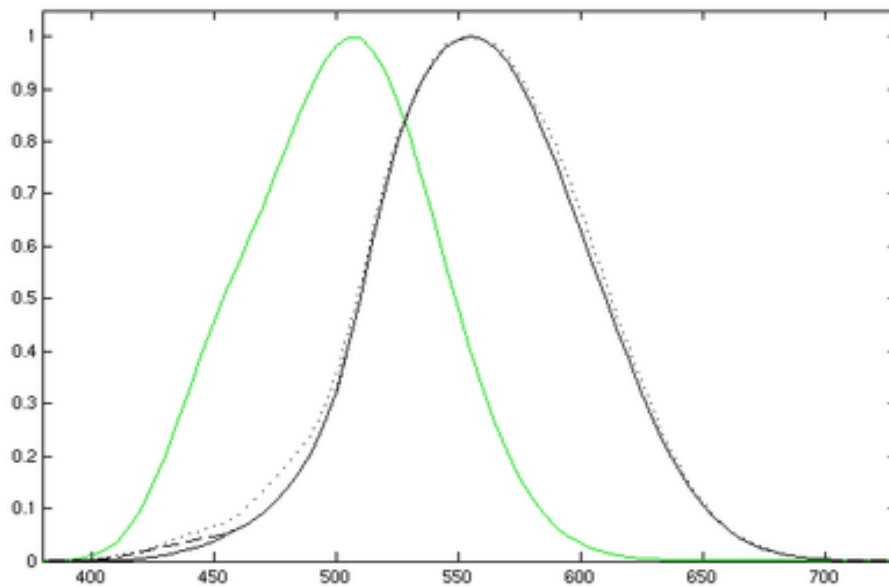

## Appendix B: Initial Factory Task Light Quality Assessment

| Machine Size | Dimensions (cm) | MEASUREMENTS                       |                        |                              |                               |                                  | SURVEY            |            |                |
|--------------|-----------------|------------------------------------|------------------------|------------------------------|-------------------------------|----------------------------------|-------------------|------------|----------------|
|              |                 | Illuminated Area (m <sup>2</sup> ) | Distance to Light (cm) | Illuminance w/ Light on (lx) | Illuminance w/ Light off (lx) | Illuminance from Light only (lx) | Area Illuminated? | Color?     | Complaints?    |
| 80t          | 40x30           | 0.12                               | 70                     | 25                           | 5                             | 20                               | good              | too yellow | too much glare |
| 80t          | 55x15           | 0.08                               | 70                     | 72                           | 42                            | 30                               | good              | too yellow | too much glare |
| 25t          | 15x20           | 0.03                               | 63                     | 12                           | 9                             | 3                                | good              | good       | too much glare |
| 200t         | 100x40          | 0.40                               | 100                    | 30                           | 8                             | 22                               |                   |            |                |
| 80t          | 40x20           | 0.08                               | 60                     | 90                           | 10                            | 80                               |                   |            |                |
|              | <b>AVERAGE:</b> | <b>0.14</b>                        | <b>73</b>              | <b>46</b>                    | <b>15</b>                     | <b>31</b>                        |                   |            |                |
|              | <b>MIN:</b>     | <b>0.03</b>                        | <b>60</b>              | <b>12</b>                    | <b>5</b>                      | <b>3</b>                         |                   |            |                |
|              | <b>MAX:</b>     | <b>0.40</b>                        | <b>100</b>             | <b>90</b>                    | <b>42</b>                     | <b>80</b>                        |                   |            |                |

Average illuminance in factory with overhead lights on, midday, raining: 150 lx

## Appendix C: Procedure for Photometric Tests

### Quantities

$d$  = perpendicular distance from light source to wall

$r$  = radial distance from center of projection to measured spot

$\Theta$  = angle to  $r$

$\Theta^{1/2}$  = half angle

$2\Theta^{1/2}$  = beam angle

$E_v$  = illuminance

$I_v$  = luminous intensity

$\Phi_v$  = luminous flux

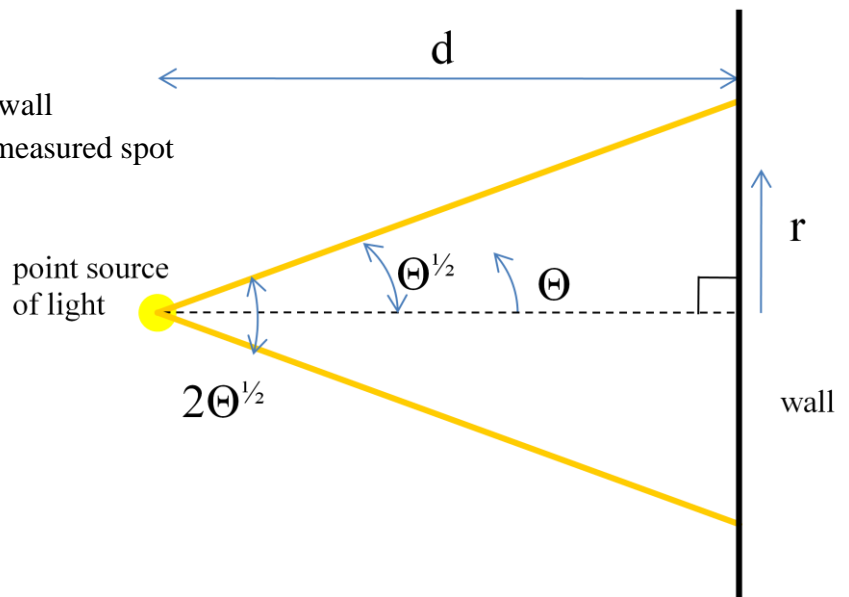

The photometric data for the light sources in Appendices D -X were obtained by using the following procedure:

The light fixture was placed a distance  $d$  from a wall in a dark a room. It was aligned perpendicular to the wall by judging how circular the project was assuming a point light source. The center of the projection was found and marked and a line was drawn radially outward on the wall. Points were marked on the line at various distances  $r$  to the edge of the projection. The illuminance at the center and seven other distances  $r$  from the center were measured using a lux meter. These seven measurements were repeated with the light source off to correct for any ambient light in the room. These illuminances with the light off were subtracted from the corresponding illuminances with the light on to get the illuminance from only the light source being measured. The procedure was repeated for 3 different distances  $d$ .

$\Theta$  was calculated as the  $\tan^{-1}(r/d)$ . Luminous intensity  $I_v$  was calculated using  $I_v = E_v(r^2 + d^2)/\cos(\Theta)$  derived from the inverse square law of light, Pythagorean theorem, and the cosine law. Relative luminous intensity is simply the ratio of the luminous intensity a given angle to the luminous intensity at  $\Theta = 0$ .  $\Theta$  versus Relative  $I_v$  was then plotted for all three tests and a trend line added to show the beam distribution characteristics of the light source.

The beam angle was calculated the same way as  $\Theta$  above where  $r$  is the radius of the projection from the center to edge of the beam. Three tests were done and the results averaged. The distance from the wall  $d$  was chosen to be small so the edge of the projection would be more defined.

Luminous flux was estimated based on an eight point integral approximation, the average luminous intensity and beam angle, and comparisons to data from similar light sources.

Color was measured using a digital camera with the light source aimed at a matte white surface. The average color was measured and the hue value extracted from HSV color space. The camera's white balance was not perfectly calibrated but the values obtained are still suitable for comparison purposes.

## Appendix D: Photometric Data of Existing Factory Task Light

### Existing Factory Task Light with 60W Incandescent Bulb

#### Beam Distribution Test Data

##### TEST 1

|                           |        |        |        |       |        |        |        |       |
|---------------------------|--------|--------|--------|-------|--------|--------|--------|-------|
| d (cm):                   | 35     |        |        |       |        |        |        |       |
| r (cm):                   | 0      | 10     | 20     | 40    | 60     | 80     | 100    | 150   |
| $\Theta$ (°):             | 0      | 15.9   | 29.7   | 48.8  | 59.7   | 66.4   | 70.7   | 76.9  |
| E <sub>v</sub> (lx):      |        |        |        |       |        |        |        |       |
| measured                  | 1850   | 1450   | 830    | 220   | 80     | 36     | 19     | 10    |
| existing                  | 4      | 5      | 5      | 6     | 6      | 6      | 6      | 4     |
| from light                | 1846   | 1445   | 825    | 214   | 74     | 30     | 13     | 6     |
| I <sub>v</sub> (cd):      |        |        |        |       |        |        |        |       |
|                           | 226.14 | 199.12 | 154.41 | 91.81 | 70.86  | 57.07  | 44.17  | 62.65 |
| Relative I <sub>v</sub> : | 1      | 0.8806 | 0.6828 | 0.406 | 0.3134 | 0.2524 | 0.1953 | 0.277 |

##### TEST 2

|                           |        |        |        |        |        |        |        |        |
|---------------------------|--------|--------|--------|--------|--------|--------|--------|--------|
| d (cm):                   | 66     |        |        |        |        |        |        |        |
| r (cm):                   | 0      | 10     | 20     | 40     | 60     | 80     | 100    | 150    |
| $\Theta$ (°):             | 0      | 8.6    | 16.9   | 31.2   | 42.3   | 50.5   | 56.6   | 66.3   |
| E <sub>v</sub> (lx):      |        |        |        |        |        |        |        |        |
| measured                  | 550    | 465    | 391    | 231    | 111    | 62     | 39     | 16     |
| existing                  | 5      | 5      | 5      | 6      | 6      | 6      | 6      | 4      |
| from light                | 545    | 460    | 386    | 225    | 105    | 56     | 33     | 12     |
| I <sub>v</sub> (cd):      |        |        |        |        |        |        |        |        |
|                           | 237.40 | 207.32 | 191.83 | 156.70 | 112.90 | 94.65  | 86.00  | 80.02  |
| Relative I <sub>v</sub> : | 1      | 0.8733 | 0.808  | 0.6601 | 0.4756 | 0.3987 | 0.3623 | 0.3371 |

##### TEST 3

|                           |        |  |        |  |        |  |        |        |
|---------------------------|--------|--|--------|--|--------|--|--------|--------|
| d (cm):                   | 100    |  |        |  |        |  |        |        |
| r (cm):                   | 0      |  | 20     |  | 60     |  | 100    | 150    |
| $\Theta$ (°):             | 0      |  | 11.3   |  | 31.0   |  | 45.0   | 56.3   |
| E <sub>v</sub> (lx):      |        |  |        |  |        |  |        |        |
| measured                  | 240    |  | 196    |  | 102    |  | 45     | 21     |
| existing                  | 5      |  | 5      |  | 6      |  | 6      | 4      |
| from light                | 235    |  | 191    |  | 96     |  | 39     | 17     |
| I <sub>v</sub> (cd):      |        |  |        |  |        |  |        |        |
|                           | 235.00 |  | 202.57 |  | 152.26 |  | 110.31 | 99.60  |
| Relative I <sub>v</sub> : | 1      |  | 0.862  |  | 0.6479 |  | 0.4694 | 0.4238 |

# Existing Factory Task Light with 60W Incandescent Bulb

## Beam Distribution Graph

Max  $I_v$ :  $\approx 233$  cd

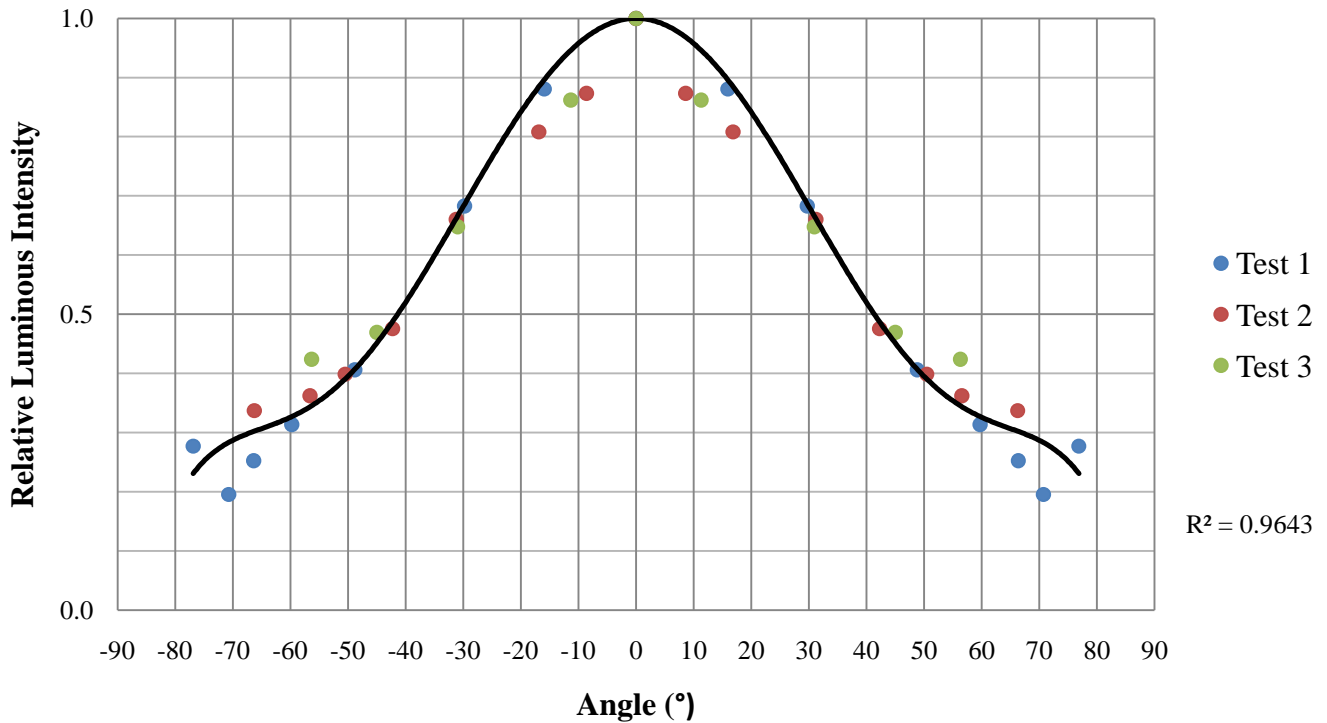

## Beam Angle

| d (cm)   | radius (cm) | $\Theta^{1/2}$ (°) | $2\Theta^{1/2}$ (°) |
|----------|-------------|--------------------|---------------------|
| 7.2      | 21.5        | 71                 | 143                 |
| 15       | 40          | 69                 | 139                 |
| 35       | 90          | 69                 | 137                 |
| AVERAGE: |             | 70                 | <b>140</b>          |

## Quantities

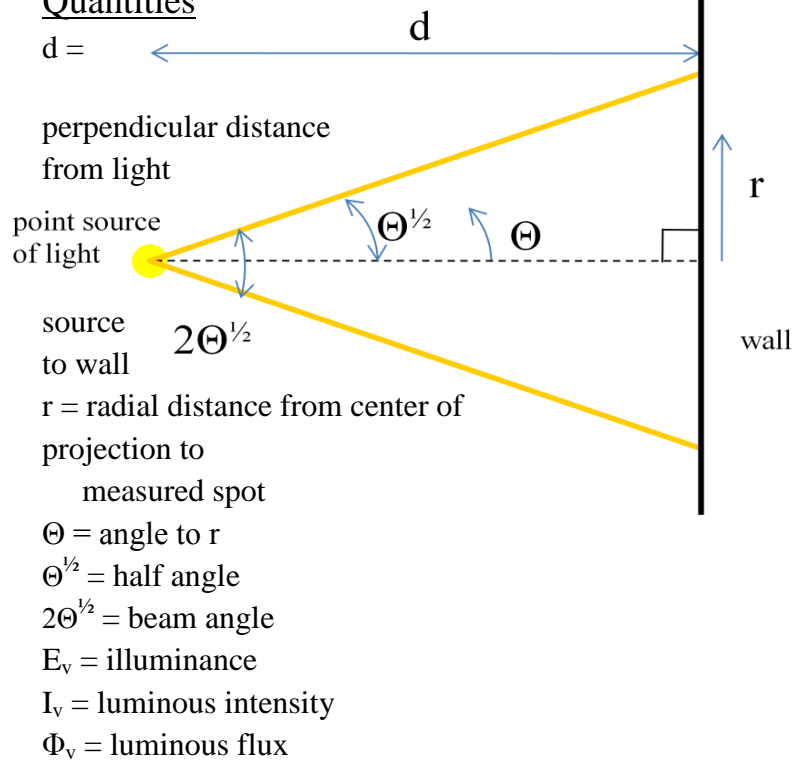

## Luminous Flux

$\Phi_v \approx 600 \pm 100$  lm

## Color

28° in HSV color space

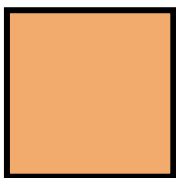

## Appendix E: Photometric Data of LED Factory Task Light Prototype

# LED Factory Task Light Prototype

### Beam Distribution Test Data

#### TEST 1

|               |        |        |        |       |        |
|---------------|--------|--------|--------|-------|--------|
| d (cm):       | 15     |        |        |       |        |
| r (cm):       | 0      | 10     | 20     | 40    | 60     |
| $\Theta$ (°): | 0      | 33.7   | 53.1   | 69.4  | 76.0   |
| Ev (lx):      |        |        |        |       |        |
| measured      | 5500   | 2200   | 385    | 46    | 16     |
| existing      | 5      | 5      | 5      | 5     | 5      |
| from light    | 5495   | 2195   | 380    | 41    | 11     |
| Iv (cd):      | 673.14 | 349.54 | 102.92 | 32.99 | 21.88  |
| Relative Iv:  | 1      | 0.5193 | 0.1529 | 0.049 | 0.0325 |

#### TEST 2

|               |        |        |        |        |        |        |        |  |
|---------------|--------|--------|--------|--------|--------|--------|--------|--|
| d (cm):       | 61     |        |        |        |        |        |        |  |
| r (cm):       | 0      | 10     | 20     | 40     | 60     | 80     | 100    |  |
| $\Theta$ (°): | 0      | 9.3    | 18.2   | 33.3   | 44.5   | 52.7   | 58.6   |  |
| Ev (lx):      |        |        |        |        |        |        |        |  |
| measured      | 466    | 440    | 382    | 237    | 135    | 60     | 33     |  |
| existing      | 5      | 5      | 5      | 5      | 5      | 5      | 5      |  |
| from light    | 461    | 435    | 377    | 232    | 130    | 55     | 28     |  |
| Iv (cd):      | 200.81 | 196.42 | 188.69 | 165.24 | 145.08 | 97.57  | 77.19  |  |
| Relative Iv:  | 1      | 0.9781 | 0.9396 | 0.8228 | 0.7224 | 0.4859 | 0.3844 |  |

#### TEST 3

|               |        |        |        |        |        |       |        |  |
|---------------|--------|--------|--------|--------|--------|-------|--------|--|
| d (cm):       | 103.5  |        |        |        |        |       |        |  |
| r (cm):       | 0      | 10     | 20     | 40     | 60     | 80    | 100    |  |
| $\Theta$ (°): | 0      | 5.5    | 10.9   | 21.1   | 30.1   | 37.7  | 44.0   |  |
| Ev (lx):      |        |        |        |        |        |       |        |  |
| measured      | 168    | 163    | 153    | 129    | 100    | 74    | 53     |  |
| existing      | 5      | 5      | 5      | 5      | 5      | 5     | 5      |  |
| from light    | 163    | 158    | 148    | 124    | 95     | 69    | 48     |  |
| Iv (cd):      | 163.00 | 158.74 | 150.74 | 132.94 | 109.81 | 87.21 | 66.74  |  |
| Relative Iv:  | 1      | 0.9738 | 0.9248 | 0.8156 | 0.6737 | 0.535 | 0.4095 |  |



# LED Factory Task Light Prototype

## Beam Distribution Graph

Max  $I_v$ :  $\approx 157$  cd

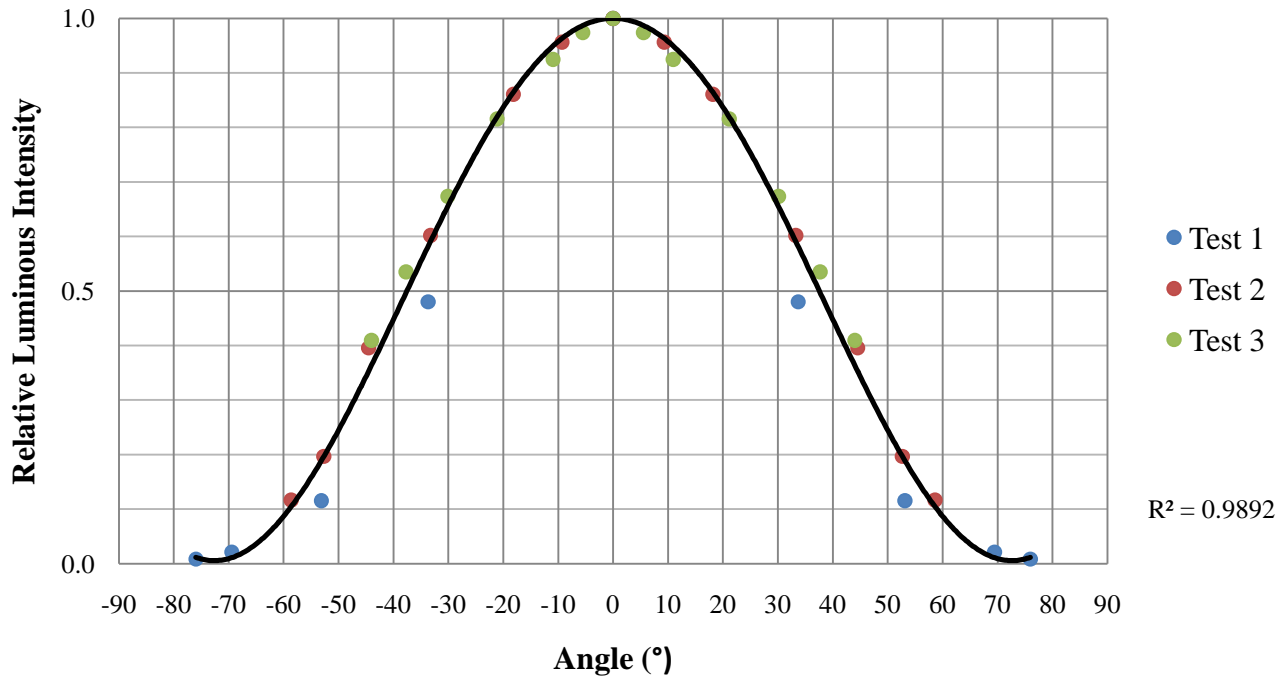

## Beam Angle

| d (cm)          | radius (cm) | $\Theta^{1/2}$ (°) | $2\Theta^{1/2}$ (°) |
|-----------------|-------------|--------------------|---------------------|
| 13.5            | 15          | 48                 | 96                  |
| 31              | 35          | 48                 | 97                  |
| 53              | 62          | 49                 | 99                  |
| <b>AVERAGE:</b> |             | 49                 | 97                  |

## Luminous Flux

$\Phi_v \approx 443 \pm 50$  lm

## Color

220° in HSV color space

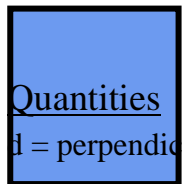

d = perpendicular distance from light source to wall

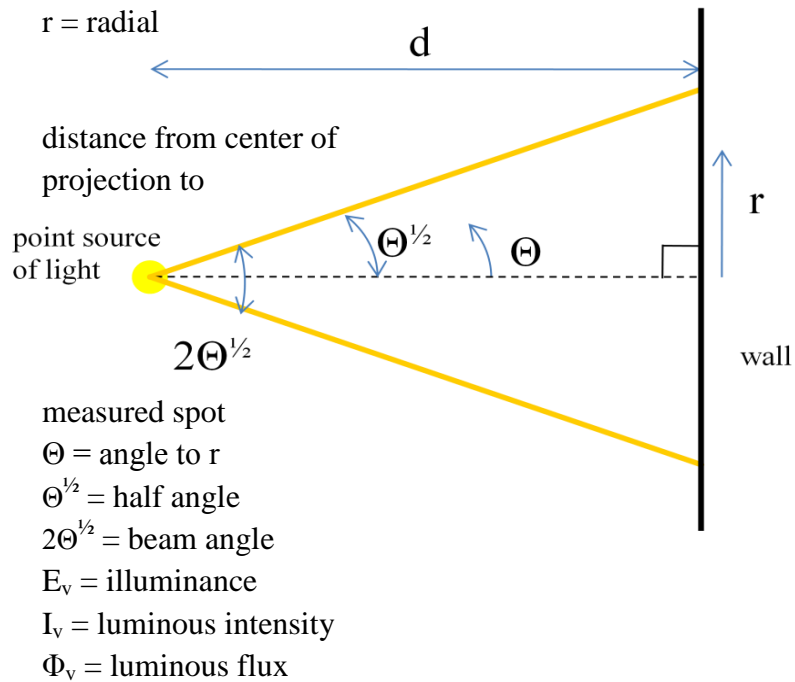

## Appendix F: Photometric Data of 400t Machine LED Factory Task Light Prototype

### 400t Machine LED Factory Task Light Prototype

#### Beam Distribution Test Data

##### TEST 1

|               |        |        |        |        |        |
|---------------|--------|--------|--------|--------|--------|
| d (cm):       | 68     |        |        |        |        |
| r (cm):       | 0      | 10     | 20     | 40     | 5      |
| $\Theta$ (°): | 0      | 8.4    | 16.4   | 30.5   | 4.2    |
| Ev (lx):      |        |        |        |        |        |
| measured      | 2080   | 1060   | 288    | 60     | 1670   |
| existing      | 5      | 5      | 5      | 5      | 5      |
| from light    | 2075   | 1055   | 283    | 55     | 1665   |
| lv (cd):      | 959.48 | 493.08 | 136.40 | 29.51  | 771.97 |
| Relative lv:  | 1      | 0.5139 | 0.1422 | 0.0308 | 0.8046 |

##### TEST 2

|               |        |        |        |        |        |
|---------------|--------|--------|--------|--------|--------|
| d (cm):       | 148    |        |        |        |        |
| r (cm):       | 0      | 10     | 20     | 40     | 60     |
| $\Theta$ (°): | 0      | 3.9    | 7.7    | 15.1   | 22.1   |
| Ev (lx):      |        |        |        |        |        |
| measured      | 445    | 403    | 285    | 110    | 41     |
| existing      | 5      | 5      | 5      | 5      | 5      |
| from light    | 440    | 398    | 280    | 105    | 36     |
| lv (cd):      | 963.78 | 873.77 | 618.89 | 238.24 | 85.09  |
| Relative lv:  | 1      | 0.9066 | 0.6421 | 0.2472 | 0.0883 |

##### TEST 3

|               |        |        |        |        |        |        |
|---------------|--------|--------|--------|--------|--------|--------|
| d (cm):       | 202    |        |        |        |        |        |
| r (cm):       | 0      | 10     | 20     | 40     | 60     | 80     |
| $\Theta$ (°): | 0      | 2.8    | 5.7    | 11.2   | 16.5   | 21.6   |
| Ev (lx):      |        |        |        |        |        |        |
| measured      | 245    | 230    | 192    | 106    | 56     | 30     |
| existing      | 245    | 5      | 5      | 5      | 5      | 5      |
| from light    | 245    | 225    | 187    | 101    | 51     | 25     |
| lv (cd):      | 999.70 | 919.21 | 766.77 | 420.12 | 217.09 | 109.72 |
| Relative lv:  | 1      | 0.9195 | 0.767  | 0.4202 | 0.2172 | 81     |

# 400t Machine LED Factory Task Light Prototype

## Beam Distribution Graph

Max  $I_v$ :  $\approx 975$  cd

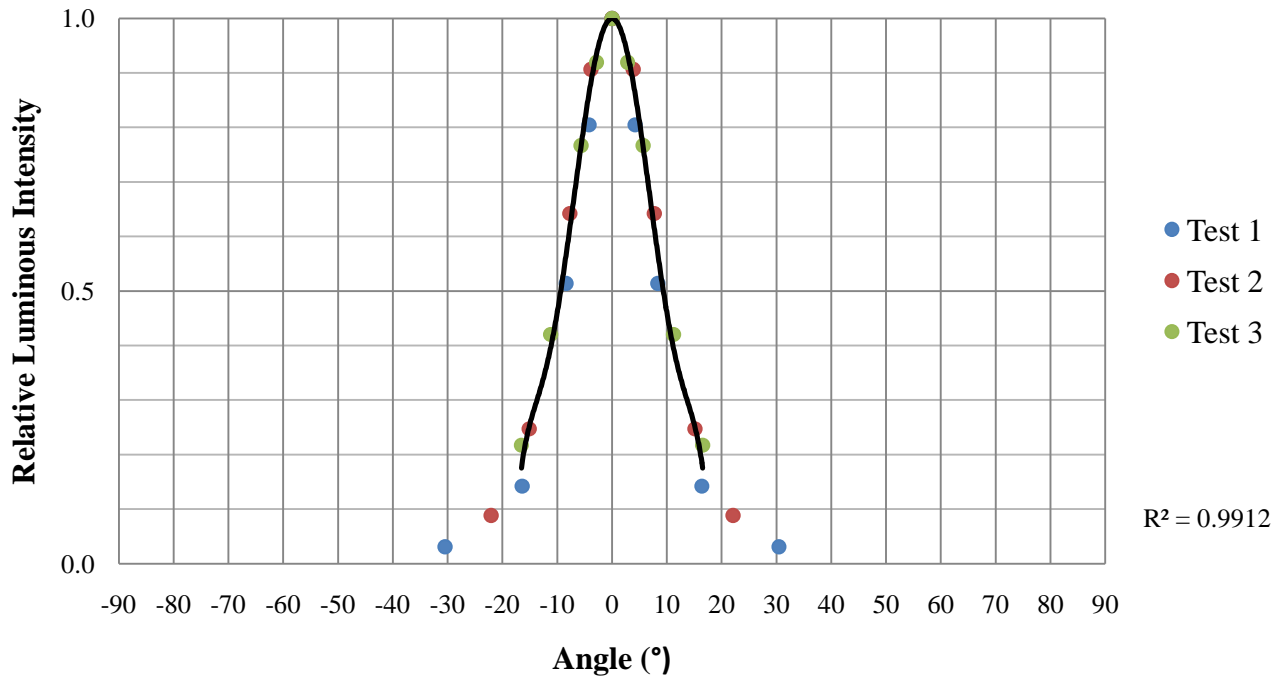

## Beam Angle

| d (cm)          | radius (cm) | $\Theta^{1/2}$ (°) | $2 \Theta^{1/2}$ (°) |
|-----------------|-------------|--------------------|----------------------|
| 19              | 10.5        | 29                 | 58                   |
| 5               | 2.5         | 27                 | 53                   |
| 89              | 30          | 19                 | 37                   |
| <b>AVERAGE:</b> |             | 25                 | 49                   |

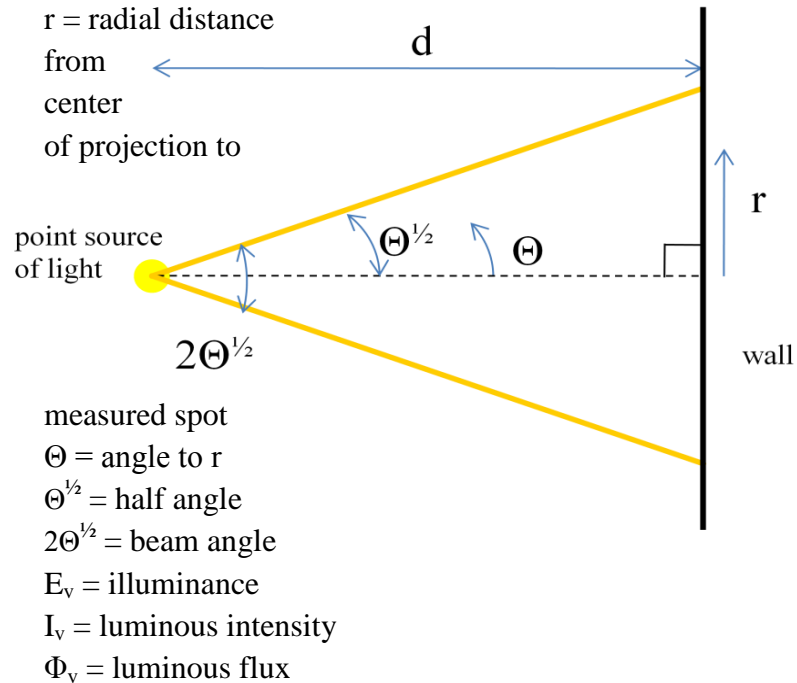

## Luminous Flux

$\Phi_v \approx 257 \pm 50$  lm

## Color

220° in HSV color space



## Quantities

$d$  = perpendicular distance from light source to wall

## Appendix G: Available LED Comparison

All data from Luckysunny Shenzhen Opto-electric Co.

| White LED Types | Color             | Typ Current (mA) | Typ Voltage (V) | Color Temp (K) | Luminous Flux(lm) | Power (mW)  | Lumious Efficacy (lm/W) |
|-----------------|-------------------|------------------|-----------------|----------------|-------------------|-------------|-------------------------|
| 0.5W            | pure white        | 150              | 3.6             | 6500           | 27                | 540         | <b>50.0</b>             |
|                 | warm white        | 150              | 3.6             | 3000           | 25                | 540         | <b>46.3</b>             |
| <b>1W</b>       | <b>pure white</b> | <b>350</b>       | <b>3.6</b>      | <b>6500</b>    | <b>70</b>         | <b>1260</b> | <b>55.6</b>             |
|                 | warm white        | 350              | 3.6             | 3000           | 55                | 1260        | <b>43.7</b>             |
| 3W              | pure white        | 900              | 3.5             | 7500           | 135               | 3150        | <b>42.9</b>             |
|                 | warm white        | 900              | 3.5             | 3350           | 100               | 3150        | <b>31.7</b>             |
| 5W              | pure white        | 700              | 7               | 7500           | 200               | 4900        | <b>40.8</b>             |
|                 | warm white        | 700              | 7               | 3050           | 180               | 4900        | <b>36.7</b>             |
| 10W             | pure white        | 1000             | 10.5            | 7500           | 500               | 10500       | <b>47.6</b>             |
|                 | warm white        | 1000             | 10.5            | 3050           | 300               | 10500       | <b>28.6</b>             |
| 50W             | pure white        | 1500             | 34              | 7500           | 2750              | 51000       | <b>53.9</b>             |
|                 | warm white        | 1500             | 34              | 3050           | 2250              | 51000       | <b>44.1</b>             |
| 100W            | pure white        | 3200             | 34              | 7500           | 5000              | 108800      | <b>46.0</b>             |
|                 | warm white        | 3200             | 34              | 3050           | 4250              | 108800      | <b>39.1</b>             |

| 1W LED Models  | beam angle (°) | Typ Current (mA) | Typ Voltage (V) | Power (mW)  | Luminous Fux (lm) | Luminous Efficacy (lm/W) |
|----------------|----------------|------------------|-----------------|-------------|-------------------|--------------------------|
| <b>830CW1B</b> | <b>120</b>     | <b>350</b>       | <b>3.4</b>      | <b>1190</b> | <b>75</b>         | <b>63.0</b>              |
| 830CW1D        | <b>165</b>     | 350              | 3.4             | 1190        | 65                | <b>54.6</b>              |
| 889CW1A        | <b>100</b>     | 350              | 3.4             | 1190        | 55                | <b>46.2</b>              |
| 201CW1B        | <b>115</b>     | 350              | 3.4             | 1190        | 75                | <b>63.0</b>              |

## Appendix H: 1W High Power LED LSP-830CW1B Datasheet

Luckysunny shenzhen opto-electronic CO.,LTD--- RUIJING OPTO Sample acknowledgement book

### ● Package Dimensions

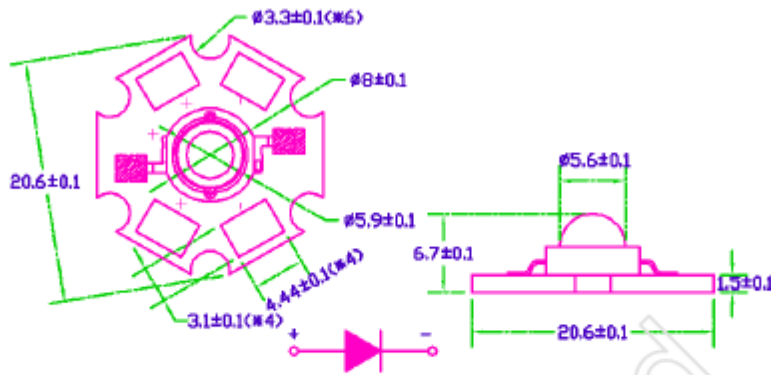

平面尺寸图 Dimension (mm)

#### Notes

1. All dimensions are in millimeters (inches).
2. Tolerance is  $\pm 0.25$ mm(0.010") unless otherwise noted
3. Protruded resin under flange is 1.0mm(0.04") max.
4. Lead spacing is measured where the leads emerge from the package.
5. Specifications are subject to change without notice.

### ● Spatial Distribution

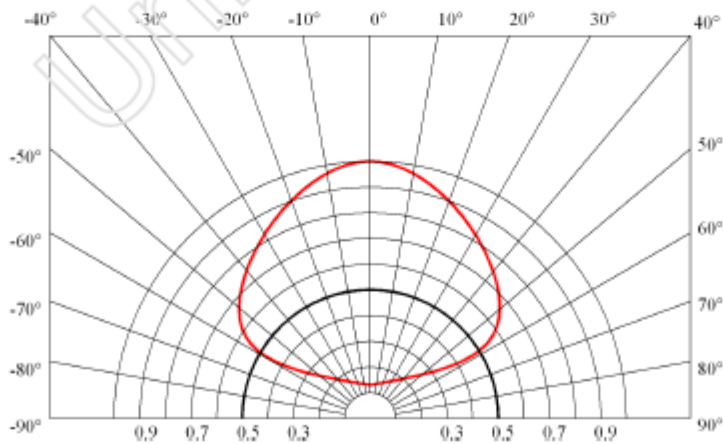

<http://www.szleds.com>

Tel:0755-27473039 27473330 Fax:29656776

mail:wonlen@163.com

● **Electrical / Optical Characteristics at TA=25°C**

| Parameter          | Symbol         | Min. | Typ. | Max. | Unit    | Test Condition |
|--------------------|----------------|------|------|------|---------|----------------|
| Luminous Intensity | $\phi$         | 70   | 75   | 80   | Lm      | IF =350mA      |
| Viewing Angle      | 2 $\theta$ 1/2 | 110  | 120  | 130  | deg     | IF =350mA      |
| DominantWavelength | TC             | 6000 | 6500 | 7000 | K       | IF =350mA      |
| Forward Voltage    | vF             | 3.2  | 3.4  | 3.6  | v       | IF =350mA      |
| Reverse Current    | IR             | 0    |      | 10   | $\mu$ A | IF =350mA      |

● **Absolute Maximum Ratings at TA=25°C**

| Parameter  | Maximum Rating      |
|--|---------------------|
| Power Dissipation  | 1W                  |
| Peak Forward Current(1/10 Duty Cycle, 0.1ms Pulse Width) | 1000mA              |
| Continuous Forward Current                               | 350mA               |
| Derating Linear From 30°C                                | 0.07mA/°C           |
| Reverse Voltage  | 5V                  |
| Operating Temperature Range                              | -20°C to + 80°C     |
| Storage Temperature Range                                | -30°C to + 100°C    |
| Lead Soldering Temperature<br>[1.6mm(.063") From Body]   | 260°C for 5 Seconds |

<http://www.szleds.com>      Tel:0755-27473039 27473330      Fax:29656776      mail:wonlen@163.com

## Appendix I: Material Comparison Data

| Material  | Thermal Conductivity (W/m*K) | Density (kg/m <sup>3</sup> ) | Carbon Footprint (kg/kg) | Price (USD/kg) | Recyclable |
|-----------|------------------------------|------------------------------|--------------------------|----------------|------------|
| Aluminum  | 156                          | 2700                         | 12.15                    | 2.64           | YES        |
| Copper    | 275                          | 8935                         | 5.82                     | 7.07           | YES        |
| Magnesium | 103                          | 1845                         | 23.6                     | 4.78           | YES        |
| Zinc      | 118                          | 5975                         | 3.45                     | 3.25           | YES        |

| Carbon Footprint (kg/m <sup>3</sup> ) | Price (USD/m <sup>3</sup> ) |
|---------------------------------------|-----------------------------|
| 32805                                 | 7128                        |
| 52001.7                               | 63170.45                    |
| 43542                                 | 8819.1                      |
| 20613.75                              | 19418.75                    |

### Normalized

| Material  | Thermal Conductivity | Density     | Carbon Footprint | Price     |
|-----------|----------------------|-------------|------------------|-----------|
| Aluminum  | 0.567272727          | 0.683333333 | 0.6283722        | 1         |
| Copper    | 1                    | 0.20649133  | 0.3964053        | 0.1128376 |
| Magnesium | 0.374545455          | 1           | 0.4734222        | 0.8082457 |
| Zinc      | 0.429090909          | 0.30878661  | 1                | 0.3670679 |

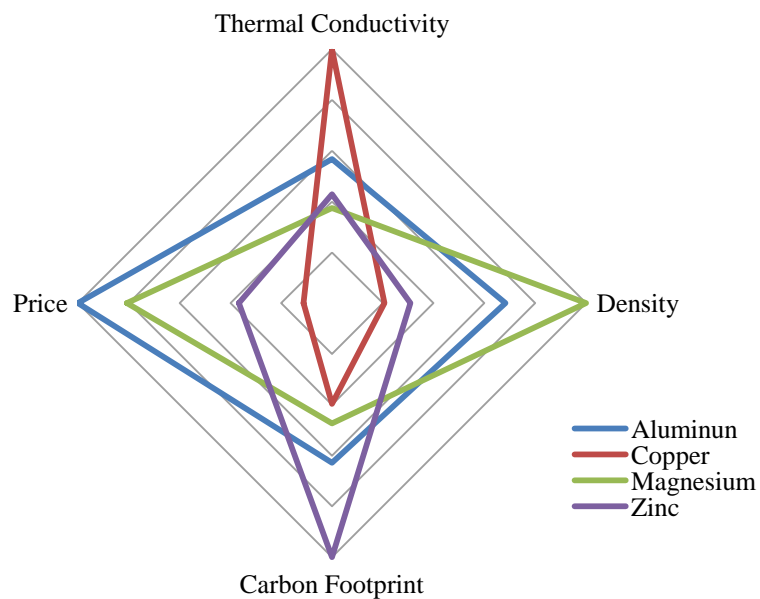

## Appendix J: Final Prototype Factory Task Light Quality Assessment

| Machine Size    | MEASUREMENTS                 |                               |                                  | SURVEY            |        |             |
|-----------------|------------------------------|-------------------------------|----------------------------------|-------------------|--------|-------------|
|                 | Illuminance w/ Light on (lx) | Illuminance w/ Light off (lx) | Illuminance from Light only (lx) | Area Illuminated? | Color? | Complaints? |
| 80t             | 100                          | 10                            | 90                               | good              | good   | none        |
| 25t             | 30                           | 4                             | 26                               | good              | good   | none        |
| 200t            | 60                           | 10                            | 50                               | good              | good   | none        |
| <b>AVERAGE:</b> | <b>63</b>                    | <b>8</b>                      | <b>55</b>                        |                   |        |             |
| <b>MIN:</b>     | <b>30</b>                    | <b>4</b>                      | <b>26</b>                        |                   |        |             |
| <b>MAX:</b>     | <b>100</b>                   | <b>10</b>                     | <b>90</b>                        |                   |        |             |

Percent Increase in Illuminance Compared to Existing Factory Task Light (Appendix B):

| Machine Size    | From Light Only | Total       |
|-----------------|-----------------|-------------|
| 25t             | 867%            | 250%        |
| 80t             | 208%            | 160%        |
| 200t            | 227%            | 200%        |
| <b>AVERAGE:</b> | <b>434%</b>     | <b>203%</b> |