

DEVELOPING A ROBOTICS OUTREACH PROGRAM

An Interactive Qualifying Project Report

submitted to the faculty of

WORCESTER POLYTECHNIC INSTITUTE

in partial fulfillment of the requirements for the

Degree of Bachelor of Science

by



Sean P. Donovan



Alexander H. Hecht

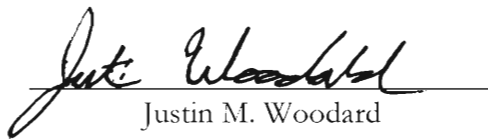

Justin M. Woodard

Date: March 2005

Approved:

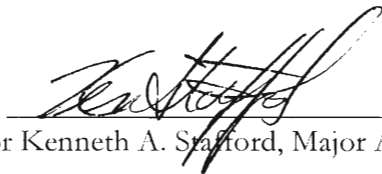

Professor Kenneth A. Stafford, Major Advisor



Brad A. Miller, Co-Advisor

Abstract

The WPI-EBOT educational robotics program was designed as a low-cost way to teach basic engineering and programming principles and to encourage high school students to pursue an education in engineering or science. The project group recruited local high schools, trained teachers at those schools, and worked directly with students to assist them in building a competitive robot. The schools' response to the project was overwhelmingly positive, and they plan to remain involved for years to come.

Table of Contents

Abstract.....	i
Table of Figures.....	v
1 Introduction	1
1.1 General Background	1
1.2 WPI-EBOT	3
1.3 Goals.....	4
1.4 Massachusetts Framework Objectives.....	6
2 Background.....	7
2.1 Overview	7
2.2 Existing competitions	9
2.2.1 FIRST	9
2.2.2 miniFIRST and Savage Soccer at WPI.....	9
2.2.3 FLL	10
2.2.4 BEST	11
2.2.5 Botball	11
2.2.6 RoboCup Junior.....	12
2.2.7 BattleBots IQ	12
2.3 Desired Traits for WPI-EBOT.....	14
3 Procedure	16
3.1 Overview	16
3.2 Early Preparation	17
3.3 Supporting Teams.....	19
3.3.1 Workshop 1: Mechanics	19
3.3.1.1 Objectives	19
3.3.1.2 Methodology.....	19
3.3.1.3 Key Points.....	21
3.3.2 Workshop 2: Programming	21
3.3.2.1 Objectives	21
3.3.2.2 Methodology.....	22
3.3.2.3 Key Points.....	23
3.3.3 Workshop 3: Advanced Topics	23
3.3.3.1 Objectives	23
3.3.3.2 Methodology.....	24
3.3.3.3 Key Points.....	25
3.3.4 Online Archives.....	25
3.3.5 In-School Mentoring.....	27
3.4 The Competition	29
3.4.1 The Kit.....	29
3.4.2 The Game	30
3.5 The Role of Mentors.....	32
4 Results	33
4.1 Survey	35
4.1.1 Objectives	35
4.1.2 Results of Survey.....	35
4.2 Interviews	37

4.2.1	South High Community School.....	37
4.2.2	Doherty Memorial High School	38
4.2.3	North High School.....	39
4.2.4	Conclusions from Interviews.....	39
4.3	Team Forum	41
5	Conclusions	43
6	Appendices	46
Appendix A:	Glossary	46
Appendix B:	Massachusetts Framework Objectives.....	48
Appendix C:	Mentoring Journals	49
C.1	Alexander.....	49
C.1.1	Spring visits with schools:.....	49
C.1.2	Fall visits with schools:	49
C.1.3	Post Fall Visits:.....	51
C.1.4	Workshops:.....	51
C.1.5	Build Season visits.....	52
C.1.6	Competition	56
C.2	Sean	58
C.2.1	Doherty	58
C.2.2	North High.....	58
C.2.3	South High.....	59
C.3	Justin.....	60
C.3.1	North High 11-21-04	60
C.3.2	South High 11-21-04	60
C.3.3	Doherty 11-24-04	60
C.3.4	North High 12-02-04	60
Appendix D:	Interview Transcripts.....	62
D.1	Doherty	62
D.2	North.....	77
D.3	South.....	78
D.4	Team Forum	88
Appendix E:	Surveys	96
Appendix F:	2004 Savage Soccer Game Rules	172
1.	Objective.....	172
2.	The Game	172
3.	The Robot	178
Appendix G:	The EBOT Kit	181
G.1	The Kit of Parts.....	181
G.2	How-To.....	183
G.2.1	Timing of the Competition Season.....	183
G.2.2	Recruiting Teams.....	183
G.2.3	Kickoff.....	184
G.2.4	Running a Tournament	185
G.2.5	Timing a Tournament	186
G.3	Workshop Materials	188
G.3.1	Workshop 1.....	188

G.3.2	Workshop 2.....	205
G.3.3	Workshop 3.....	215
Appendix H:	Bibliography	220

Table of Figures

Figure 1: Matrix of Investigated Programs.....	8
Figure 2: Summary of Survey Results.....	36

1 Introduction

1.1 General Background

Numerous studies have shown that robotics programs are an effective tool for improving science and engineering education.¹ By creating a low-cost robotics-based educational program, WPI-EBOT aimed to expose high school students to engineering and computer science, often for the first time. In the 2004-2005 academic year, WPI-EBOT established robotics teams at several Worcester area schools, created supporting materials, and provided training, technical support, and programmatic assistance throughout the project period.

WPI-EBOT aimed to create a self-sustaining, low-cost robotics program to teach basic mechanical engineering and computer programming principles, and to encourage high school students to pursue an education in engineering and science. Using the Massachusetts Academy of Math and Science's miniFIRST competition as a starting point, WPI-EBOT added educational and support components to create an end-to-end program that could be implemented by schools with minimal resources and no prior experience with student robotics. Like miniFIRST, WPI-EBOT offered students a tangible objective by culminating in an exciting tournament between many small teams.

Of the four major Worcester public high schools, North High School, South High Community School, and Burncoat High School do not have engineering programs. The

¹ "Inspiring Students," [FIRST Resource Center](http://www.usfirst.org/4vol/resourcectr/impact/Impact_Inspiring_2005.pdf), http://www.usfirst.org/4vol/resourcectr/impact/Impact_Inspiring_2005.pdf.
"Building Academic Success," [FIRST Resource Center](http://www.usfirst.org/4vol/resourcectr/impact/Impact_Success_2005.pdf), http://www.usfirst.org/4vol/resourcectr/impact/Impact_Success_2005.pdf.
"A Study of Robotics in the Classroom," [General Robotics](http://www.edurobot.com/stories/delgado.html), <http://www.edurobot.com/stories/delgado.html>.
Abhijit Nagchaudhuri et al, "LEGO Robotics Products Boost Student Creativity in Pre-College Programs at UMES," [32nd ASEE/IEEE Frontiers in Education Conference](http://fie.engrng.pitt.edu/fie2002/papers/1009.pdf), <http://fie.engrng.pitt.edu/fie2002/papers/1009.pdf>.
Alan Melchior, "Evaluation of the FIRST LEGO League," <http://www.usfirst.org/jrobotcs/2003BrandeisEvaluation.ppt>.
Elizabeth Sklar et al, "Children Learning from Team Robotics," <http://demo.cs.brandeis.edu/papers/rcj2000.pdf>.
Carlos Pomalaza-Ráez et al, "Retention 101: Where Robots Go...Students Follow," [Journal of Engineering Education](http://users.ipfw.edu/groff/09-EE015-02-2033.pdf) Jan 2003, <http://users.ipfw.edu/groff/09-EE015-02-2033.pdf>.
Stephen Bruder et al, "Robotics in the Classroom," [IEEE Robotics & Automation Magazine](http://isrg.nmt.edu/~ms/publications/f/IEEERandA2003.pdf) Sep 2003, <http://isrg.nmt.edu/~ms/publications/f/IEEERandA2003.pdf>.

fourth, Doherty Memorial High School, has a pre-engineering magnet program.² An early objective of WPI-EBOT was to recruit four teams of seven or eight students from each of the four main Worcester public high schools.

Before the competition, WPI-EBOT had to train the teachers, who would serve as mentors for their school's teams, in basic mechanical design and computer programming. In-school visits were required to analyze the effectiveness of WPI-EBOT and to help the teams with technical issues. These visits proved extremely valuable for both the schools and for the WPI-EBOT group.

For the students, WPI-EBOT was capped by the end-of-season tournament in which they tested their robots against other teams. An obvious incentive, the tournament kept the students engaged and learning. A successful tournament was vital to the future of the program, as it would leave a lasting impression. More information on the tournament can be found in Appendix G.2.

² "Engineering," Doherty Memorial High School, http://www.wpsweb.com/doherty/2003_2004/Engineering/engin.htm.

1.2 WPI-EBOT

WPI-EBOT (Education Beyond Ordinary Teaching) was created to excite high school students about science, technology, and engineering, to encourage them to pursue further education in these fields, and to provide them with skills and real-world experience that could be used throughout their lives. Participating schools were provided with everything they needed to build and program a robot, along with supporting educational materials.³ In addition to teaching fundamentals of computer science and engineering, WPI-EBOT emphasized teamwork and project management skills. Students navigated the engineering design process, worked hands-on with mechanical and electrical components, and programmed their robots. As a robot-building platform, WPI-EBOT chose the same versatile and cost effective Robovation kits used by the WPI Frontiers robotics camp.⁴ The WPI-EBOT season culminated in a citywide inter-team competition.

³ Some of the educational materials are presented in Appendix G.3.

⁴ "Areas of Study," WPI Frontiers, <http://www.admissions.wpi.edu/Frontiers/study.html>.

1.3 Goals

Through creation of an educational robotics program, the WPI-EBOT group set out to explore the relationship between education and technology.⁵ The overriding aim was to use a competitive sports format to increase interest in and improve the quality of science and engineering education at the high school level. The goal was an accessible, self-sustaining, and cost-effective program that would grow to involve many more students and schools. The chosen path to this goal was a program with three attributes:

1) *Inspiration*: Following the model of high school athletics, WPI-EBOT's goal was to offer students an entertaining, hands-on activity that rewards effort, learning, and teamwork with success in a strategy-rich competitive setting and with honor to the host school. As in athletics, ultimate success was determined by the student participants, not by the mentors and coaches. Through their exposure to the fun side of math, science, and engineering, and the opportunity to interact directly with working engineers and engineering students, it was hoped that students would be motivated to pursue an education in one of those disciplines. Equally important was for teachers and administrators to conclude that WPI-EBOT had a positive impact on their school and their students.

2) *Accessibility*: To enroll new schools and to retain existing schools, WPI-EBOT needed to be affordable and achievable. It needed to make reasonable demands on the time of teachers, students, and mentors, and its demand for facilities needed to be modest. The program had to be all-inclusive, leaving no gaps in training, support, or facilities. The kit components had to be sufficiently capable to allow inexperienced teams to build

⁵ Douglas W. Woods, "Chapter 4," *Handbook for IQP Advisors and Students*, <http://www.wpi.edu/Academics/Depts/IGSD/IQPHbook/ch4a.html>.

an effective robot, while being low cost. Training and technical support needed to be comprehensive and supported by adequate on-line and written materials. WPI-EBOT had to offer a level playing field to schools, regardless of the resources available to them. There needed to be sufficient carry-over of materials and rules from year to year to reward continued involvement, but not so much that new schools would experience insurmountable barriers to success.

3) *Educational breadth*: It was decided that the WPI-EBOT program should encompass several disciplines, including mechanical engineering and computer science, without stressing any one over the others. Autonomous operation and manual control of the robots should be balanced to ensure that students would gain equal experience in programming, mechanical design, and strategy. Interaction between robots was also seen as a positive trait, as it forces teams to be more flexible in their strategies.

1.4 Massachusetts Framework Objectives

In 2001, the Massachusetts Department of Education created a Science and Technology/Engineering Curriculum Framework that presented guidelines for science and technology/engineering education in the state's public schools.⁶ Many schools are in the process of implementing this framework, and they are looking for programs to help them fulfill its requirements. WPI-EBOT was designed to provide such a program by addressing engineering design, electrical design, and electronic communication systems. A full listing of the specific requirements met can be found in Appendix B.

⁶ David P. Driscoll, "Letter from the Commissioner," Science and Technology/Engineering Curriculum Framework, <http://www.doe.mass.edu/frameworks/scitech/2001/welcome/letter.html>.

2 Background

2.1 Overview

WPI-EBOT was born of a perception that existing educational robotics programs all have liabilities that limit their impact on the majority of schools. As shown in Figure 1 below, some are too expensive to be accessible to most schools, some provide insufficient hands-on experience, and others are too narrowly focused on programming or mechanical construction.

All of the programs that were examined focus on common themes: Showing students how classroom subjects are applied in the real world; teaching engineering through hands-on experience; and encouraging cooperation both within teams and between teams. WPI-EBOT subscribed to these same ideals.

The creators of WPI-EBOT have all participated in the nationwide FIRST Robotics Competition and the WPI/Mass Academy miniFIRST competition for a number of years. These two programs were influential as starting points for the design of WPI-EBOT.

	WPI-EBOT	FIRST	FIRST Lego League	BEST	Botball	RoboCup Junior	BBIQ	BBIQ Tabletop
Cost	\$800	\$6,000 – \$60,000	\$500+	Free for schools	\$2,500+	\$1,000+	\$1,000-\$50,000	\$1,000+
Time	4 weeks	6 weeks	8 weeks	6 weeks	7 weeks	16 – 28 weeks	Year round	16 weeks
Grade Range	9-12	7-12	4-8	9-12	7-12	6-12	7-College	9-12
Kit is Reusable	Yes	No	Yes	Partially	Yes	Yes	No	Yes
Students program robots	Yes	Yes	Yes	No	Yes	Yes	Yes	Optional
Students control robots	Yes	Yes	No	Yes	No	No	Yes	Yes
Student work with tools to construct robot	Yes	Yes	No	Yes	Optional	Optional	Yes	Yes
Most parts needed included with kit	Yes	No	Yes	Yes	No	No	No	Yes
Local workshops provided	Yes	No	No	Yes	Yes	No	No	No
Short learning curve	Yes	No	Yes	No	No	No	No	Yes
Closest tournament event	Worcester, MA	Manchester, NH	Worcester, MA	Not available in New England	Lowell, MA	Boston, MA	Orlando, FL and Minneapolis, MN	Orlando, FL and Minneapolis, MN

Figure 1: Matrix of Investigated Programs

2.2 Existing competitions

2.2.1 FIRST

One of the main goals of FIRST (For Inspiration and Recognition of Science and Technology), the largest of the nationwide high school robotics programs, is to inspire students through their interaction with adult mentors. This interaction helps the student learn what an engineer does, and teaches problem-solving skills that can be applied elsewhere.⁷

The major disadvantage of FIRST is its cost to schools. As seen in Figure 1, running a FIRST team can cost tens of thousands of dollars a year. Many public schools cannot afford a program such as this and, as a result, FIRST teams are usually a partnership between a school and a corporation or university. These partnerships can be both beneficial and constraining. While student/mentor interaction is an excellent learning tool, it is the experience of many participants that the mentors do a majority of the technical work. FIRST's highest goal is inspiration, not education, and so mentor-heavy teams are not discouraged. While there is some hands-on teaching, many students come away from the program feeling that they got little actual experience.⁸

2.2.2 miniFIRST and Savage Soccer at WPI

WPI developed the miniFIRST program as pre-season training for the Mass Academy high school members of FIRST Team 190. It introduced these students to the design challenges associated with FIRST, but on a smaller scale. It was also a team

⁷ This section is based on the WPI-EBOT group's personal experiences with FRC and the following "Vision & Theory," [FIRST Resource Center](http://www.usfirst.org/4vol/resourcectr/vision/Vision_Theory_2005.pdf), http://www.usfirst.org/4vol/resourcectr/vision/Vision_Theory_2005.pdf.
"FIRST Trifold Brochure," [FIRST Resource Center](http://www.usfirst.org/4vol/resourcectr/facts/TriFoldBrochure.pdf), <http://www.usfirst.org/4vol/resourcectr/facts/TriFoldBrochure.pdf>.
"FRC Summary," [FIRST Resource Center](http://www.usfirst.org/4vol/resourcectr/facts/FRC_Summary_2005.pdf), http://www.usfirst.org/4vol/resourcectr/facts/FRC_Summary_2005.pdf.
"Building Academic Success," [FIRST Resource Center](http://www.usfirst.org/4vol/resourcectr/impact/Impact_Success_2005.pdf), http://www.usfirst.org/4vol/resourcectr/impact/Impact_Success_2005.pdf.
⁸ Dean Kamen, "Kickoff Speech," 1998 FIRST Robotics Competition Kickoff, <http://www.huskiebrigade.com/DEKA1998.html>.

building activity, and helped introduce the students from the high school to their college mentors at WPI.⁹ Like the FIRST game, the rules of miniFIRST's Savage Soccer game change every year. Simulating the time crunch of FIRST's six-week season, the timescale of miniFIRST is very short. WPI-EBOT was originally conceived as an extension of miniFIRST.

2.2.3 FLL

An offshoot of FIRST, FIRST LEGO League (FLL) is specifically targeted towards middle school students. FLL uses the LEGO Mindstorms platform, which offers several advantages. A robot can be made out of LEGOs in a matter of minutes, making rapid development and testing easy. Furthermore, the LEGO RCX controller offers a graphical programming model with a short learning curve targeted at younger students.¹⁰

Though FLL is intended for middle school students, it does provide WPI-EBOT with an example of how rapid prototyping allows creative freedom in designing and testing robots without significant mentor help. The major drawback to FLL is that the students do not directly control the robot – it runs autonomously – and robots do not interact with each other. This model does not translate well to high school students, who are motivated by both robotic and human contact sports, and bypasses an opportunity to teach about robot-human interaction.

⁹ Savage Soccer, <http://users.wpi.edu/~savage/>.

¹⁰ This section is based on the WPI-EBOT group's personal experiences with FLL and the following:

"FLL: Sport for the Mind," FIRST LEGO League Resource Center,
http://www.usfirst.org/4vol/FLLresourcectr/facts/FLL_SportForTheMind_2005.pdf.

"FLL: At-a-Glance," FIRST LEGO League Resource Center,
http://www.usfirst.org/4vol/FLLresourcectr/facts/FLL_AtAGlance_2005.pdf.

2.2.4 BEST

The BEST Robotics Program is unique in that it is free for schools to participate. Responsibility for funding is shifted to hub organizations that supply schools with kits and host the tournaments. While this is great for the schools, few groups are willing to serve as hubs. There is quite a bit of hands-on work done by the students, but experienced mentors are still required in order for teams be successful.¹¹ Although BEST focuses heavily on the educational aspects of robot competition, it is not practical for WPI-EBOT because of the substantial financial investment required of the host of the hub.

Additionally, BEST robots are controlled remotely with no programming, restricting the educational experience to mechanical engineering.

2.2.5 Botball

Botball is similar to FLL in that the robots run autonomously. The use of the Interactive C programming language to control the robot is the focus of this program – the robot itself is almost secondary. Botball is designed for students who are interested in computer science and artificial intelligence, and requires students to have a background in programming in order to be successful.¹²

Botball is appropriate for learning programming, but it is not designed for learning engineering in general. Hands-on work is minimal, and there is very little to do once a robot is built.

¹¹ This section is based on the following:

"What is BEST?" [About BEST](http://www.bestinc.org/MVC/About/what_is_best), http://www.bestinc.org/MVC/About/what_is_best.

"Frequently Asked Questions," [About BEST](http://www.bestinc.org/MVC/About/faq), <http://www.bestinc.org/MVC/About/faq>.

"More Details..." [About BEST](http://www.bestinc.org/MVC/About/more_details), http://www.bestinc.org/MVC/About/more_details.

"History of the BEST Program," [About BEST](http://www.bestinc.org/MVC/About/history), <http://www.bestinc.org/MVC/About/history>.

¹² This section is based on the following:

"About Botball," [Botball Educational Robotics Program](http://www.botball.org/about_botball/), http://www.botball.org/about_botball/.

"General Questions and Answers," [Botball Educational Robotics Program](http://www.botball.org/about_botball/faq.html), http://www.botball.org/about_botball/faq.html.

"Getting Started with Botball," [Botball Orientation](http://www.botball.org/teams-only/home_base/getting_started/), http://www.botball.org/teams-only/home_base/getting_started/.

2.2.6 RoboCup Junior

RoboCup Junior is a spin-off of the college-level RobotCup competition. In RoboCup Junior, high school teams build robots that compete in one of three divisions. The soccer division pits robots against each other in a modified soccer game, either in one-on-one or two-on-two play. The rescue division requires robots to follow a line to “rescue” targets. In the dance division, teams choreograph and program robot performances set to music. Teams have the option of using various types of hardware and software, although most use LEGOs and the RoboLab programming platform.¹³

RoboCup Junior robots are autonomous, and a great deal of creativity goes into building robots for all three divisions. The dance division tests teams’ artistic abilities, something neglected by most robot competitions. Unlike other competitions, RoboCup’s game does not change every year. This lets the students rework their design throughout the year and from year to year, but can put new teams at a serious disadvantage.

2.2.7 BattleBots IQ

BattleBots IQ (BBIQ) capitalizes on the popularity of the televised BattleBots series to create a competition for high school students. BBIQ, like BattleBots, focuses on robotic destruction. While violent, BBIQ fosters education and teamwork. The organizers

¹³ This section is based on the WPI-EBOT group’s personal experiences at a RoboCup Junior Tournament and the following:
[RoboCup Junior Official Site](http://www.artificialia.com/RoboCupJr/), <http://www.artificialia.com/RoboCupJr/>.
Steve O’Conner, “Information,” [RoboCup Junior](http://www.tsof.edu.au/events/robocupjr/), <http://www.tsof.edu.au/events/robocupjr/>.
Suzanne Rozier, “About RCJ,” [RoboCupJunior Official Site](http://www.robocupjunior.org/about.html), <http://www.robocupjunior.org/about.html>.
Suzanne Rozier, “Soccer,” [RoboCupJunior Official Site](http://www.robocupjunior.org/soccer.html), <http://www.robocupjunior.org/soccer.html>.
Suzanne Rozier, “Rescue,” [RoboCupJunior Official Site](http://www.robocupjunior.org/rescue.html), <http://www.robocupjunior.org/rescue.html>.
Suzanne Rozier, “Dance,” [RoboCupJunior Official Site](http://www.robocupjunior.org/dance.html), <http://www.robocupjunior.org/dance.html>.

of BBIQ also created extensive educational material for use both in and out of the classroom. This material is provided to registered teams free of charge.¹⁴

BBIQ has few rule restrictions – a size and weight limit and a control system are specified, and the remaining rules focus mostly on safety. Robots can cost from a few hundred dollars more than the cost of the control system and registration to tens of thousands of dollars. However, the programming aspect of BBIQ is minimal.

BBIQ Tabletop is a smaller scale companion competition to BBIQ. It was started in late 2003, and is similar in scale to BEST or Botball. The game changes every year and, like BEST, the students remotely control the robot. Using a programmable microcontroller is optional. The kit is similar in capability and design to the kits provided by other programs, and is low-cost and reusable. The only major obstacle for high schools in the Worcester area is that the closest competitions are in Minnesota and Florida.

¹⁴ This section is based on conversations with faculty of Bay Path Regional Vocational High School and the following:
"Welcome," [BattleBots IQ](http://www.battlebotsiq.com/), <http://www.battlebotsiq.com/>.
Michael Bastoni, "Introduction," [BattleBots IQ Curriculum](http://www.battlebotsiq.com/curriculum.intro.php), <http://www.battlebotsiq.com/curriculum.intro.php>.
"About Battlebots IQ," [BattleBots IQ](http://www.battlebotsiq.com/manage.aboutbbiq.php), <http://www.battlebotsiq.com/manage.aboutbbiq.php>.

2.3 Desired Traits for WPI-EBOT

WPI-EBOT was built upon an existing low cost and reusable platform. After comparing and contrasting different educational robotics programs, the WPI-EBOT group decided on several desirable traits.

Appropriate student/mentor interaction was important. Psychologist Lev Vygotsky said that children learn best when a mentor provides support in a child's Zone of Proximal Development (ZPD), which is the area between what the child is able to do on his or her own and what the child is able to do with the help of a more capable partner or mentor. He said that effective mentoring under this model requires the mentor to help students in their ZPDs so that they can eventually do the task independently, and the mentor must reduce the level of help offered as each student progresses. Therefore, it was vital that students had mentors to guide them through the process, but that the mentors allow the students to learn on their own.¹⁵

It was decided that autonomous operation and manual control should be balanced to ensure that students would gain equal experience in programming, mechanical design, and strategy. Interaction between robots was also seen as a positive trait, as it forces teams to be more flexible in their strategy. Most of the existing programs, as seen in Figure 1, involve interaction between two or more robots, and from the personal experiences of the WPI-EBOT group, interaction makes tournaments more exciting.

Some competitions, especially those that stress the educational aspects of robotics, provide training materials to teams. In addition, the manufacturers of the FIRST

¹⁵ Barbara Rogoff et al, Learning Together: Children and Adults in a School Community.

and BBIQ control systems provide documentation and example programs to allow teams to program their robots easily.

The decision to use a different game every year was a controversial one. Having the same game every year has the advantage of allowing teams to perform iterative design and allows the same group of students to refine their designs over the course of a few years. When the game used changes every year, teams can go through fewer design iterations. However, a new game levels the playing field, and allows new teams to join without being at too much of a disadvantage.

3 Procedure

3.1 Overview

The school's major concern about participating in a robotics program was the cost. To convince schools that WPI-EBOT was worth the expense, it was necessary to demonstrate that the program was cost-effective and would produce significant results.

WPI-EBOT aimed to enroll eight teams, 56 students, and eight mentors for the first trial. The miniFIRST program, originally designed as a team-building activity for the WPI/Mass Academy FIRST Robotics Team 190, provided an additional four Mass Academy teams. It remained to enroll at least four new teams from area high schools.

3.2 Early Preparation

In the spring of 2004, the WPI-EBOT group began meeting with schools to discuss their participation in the fall. Of the three schools that were visited, Doherty Memorial, North High, and South High, all were enthusiastic about the program. Most saw raising the necessary funds, both for paying for the kits and paying teachers, as their primary obstacle. Finding a place for students to build the robots was not a problem, but the schools felt that they would have trouble finding a secure place to store the kits. North High and South High also foresaw trouble in transporting students to and from robotics meetings, as most rode school or city busses home.

Most schools plan their curricula during the winter, so by the time that WPI-EBOT approached them, it was too late for the program to be integrated into classes for the following year. In addition, typical class sizes would require schools to buy four to six kits, which would cost a significant amount of money. Most schools were eager to offer the program as an extra-curricular activity, but would not commit until they could gauge student interest in the fall.

The following fall, WPI-EBOT approached principals at the four Worcester high schools and Westborough High School. Although the principals would not be dealing with the WPI-EBOT group directly during the competition season, it was important to make sure that they knew what was going on and felt involved.

After being referred by the principals, the WPI-EBOT group met with administrators and teachers at each school. North High had identified possible funding from a local company and was going to recruit their CAD teachers for the program. South High had recruited two shop teachers to run their team, were looking to buy two or three

kits, and were eager to get involved because they were in the process of trying to start engineering programs at their school. Doherty Memorial had several teachers who had recently come from industry jobs and were willing to run their teams, but were still trying to get approval from the district to buy kits. Westborough High had found funding and several computer science teachers to participate, but the teachers seemed much less enthusiastic about the program than the administrators. Burncoat High was eager to participate in the program, but was unable to find any teachers who were available to run their team.

The schools brought up several important issues in the fall meetings. Anyone who works with students in the school district must have a background check run by the district, so the WPI-EBOT group members all had to take care of that paperwork before the season started. They also pointed out that printable resources that could be used as handouts would be much more useful than videos or other multimedia content. One thing that had not been taken into consideration was that the kit cost was not as important as the cost teachers' overtime pay.

More information on the early visits with schools can be found in Appendix C.1.

3.3 Supporting Teams

In preparation for the EBOT season, three workshops were presented to teachers. Summaries, presentations, cheat sheets, and additional materials from the workshops are presented in Appendix G.3.

3.3.1 Workshop 1: Mechanics

3.3.1.1 Objectives

The goal of the first workshop was to provide teachers and mentors with a basic overview of the mechanical components of the Robovation kit. As the kit comes, there is no manual. The manufacturer does provide a “Mechanical Reference Guide” on their web site, but that only describes the names of the various kit parts, and provides cautions about proper use of certain parts such as bearings or motors.¹⁶ Therefore, there was a need to give the schools an idea of what they can expect when they start trying to build their own robots, and to tell them what Team 190 had learned about the kits over the past years. It was also important to go over basic mechanical theory, such as gear ratios and torque, for the benefit of the teachers that were coming in with no mechanical experience. A written Mechanical Guide was created to accompany the workshop, and can be found in Appendix G.3.1.

3.3.1.2 Methodology

The first workshop was especially important in that it was the first time that the WPI-EBOT group would be interacting with the teachers as instructors, and the impressions made would affect the teachers’ attitude towards the program as a whole.

¹⁶ "EDU Mechanical Guide," [IFI Robotics](http://www.ifirobotics.com/docs/EDU_Mechanical_Guide.pdf), http://www.ifirobotics.com/docs/EDU_Mechanical_Guide.pdf.

Therefore, in order to prepare, a rough draft of the workshop was presented to a high school robotics elective class at the Mass Academy. The Academy students helped evaluate the usefulness of the material and the ability of the presentation to hold an audience's interest. Although the presentation at the Academy went well, substantial changes were made to the format of the workshop because of the feedback received from the students.

The topics covered in the presentation ranged from the very basic, such as the proper way to bend the metal components of the kit, to the complex, such as how the center of gravity of a robot affects its steering capabilities. The workshop was divided into two sections, entitled "What's in the Kit" and "Building a Robot". The first section covered the components of the kit, suggested uses for them, and the strengths and weaknesses of each part. The second section covered design considerations, including steering methods, wheel configurations, speed calculations, motor mounting, and chassis design.

Something that was not anticipated at the actual workshop was that the teachers and mentors would come in with many administrative questions, unrelated to the mechanical topics. Although the WPI-EBOT group covered this material individually with the schools, many of the details that seemed obvious were unclear to the schools. In the future, a pre-season kickoff event could be devoted to making sure that everyone understood the procedural issues, and would give the schools an earlier target date for acquiring the kits.

Not surprisingly, the adult teachers reacted quite differently to the workshop than the high school students did. Interactive elements, such as asking the audience to

calculate torques, did not go over very well with the adult group, and the adults were much less willing to interrupt with questions – frequent stops were needed to ask whether everyone understood.

3.3.1.3 Key Points

The main points covered in Workshop One were:

- The contents of the kit
- How to use the kit motors
- Skid steering
- Four-wheel drive versus two-wheel drive
- Center of Gravity
- Chain/Sprocket theory
- Speed versus torque
- Robot Speed
- How to use chain
- Wheelbase dimensions and turning
- Supporting shafts and proper use of bearings
- Building pivots
- Applications of design concepts

3.3.2 Workshop 2: Programming

3.3.2.1 Objectives

The main objective of the second workshop was to prepare the teachers and mentors for programming. The presentation covered the fundamentals of programming in C, techniques for dealing with problems, and strategies for overcoming the limitations of the hardware. The basic objective was to give teachers enough information to help their students write a program with the help of a “cheat sheet”, which listed basic commands and syntax. The presentation and “cheat sheet” for this workshop can be found in Appendix G.3.2.

Half of the group had no programming experience in the C language, but it was anticipated that they would have experience in logically breaking down problems. Therefore, it was planned to cover basic concepts of C, such as program structure, while skipping over simple logic, such as figuring out how to make a robot turn. This lack of relevant examples would prove to be problematic later.

3.3.2.2 Methodology

A simple presentation was planned that would start by running through a simple C program, progressing onto basic constructs, and then covering specific issues with the Robovation Robot Controller. This did not work. One teacher in particular did not follow the presentation, and on-the-fly reworking was necessary to make it clearer. After going over the trouble spots, the presentation continued mostly as planned, with a good deal of questions interjected.

The first part of the presentation showed the teachers a sample program to make a robot drive forward and turn. Every line of the program was explained, to give the teachers an idea of what a program looks like. This gave an overview of the basic concepts that would be covered later, and gave an idea of the application of the concepts that the teachers were about to learn.

The second part of the presentation covered constructs on the C language, from basic “if” statements to more complex “while” loops, as well as some of the high end problems associated with the particular architecture utilized in the Robot Controller. Along with the basic tutorial, this workshop presented various solutions to common problems. For instance, the Robovation Robot Controller at its most basic level is a pair of 16-bit PIC microcontrollers, which have limitations in performing basic arithmetic.

One of the simplest ways of representing data is with an *int*, which stores integer values. A problem arises when the program tries to make an *int* represent a value greater than 32767. The microcontroller is unable to represent numbers larger than that as an *int*, but some math requires it to do so. Operations like this are quite common, multiplying 200 by 200 for example, so a solution was presented for this problem while showing the tradeoffs that this solution presented.

3.3.2.3 Key Points

The main points covered in this Workshop Two were:

- Basic C syntax
- How to write a function
- “if” statements
- “while” loops
- Overflow and solutions for resolving
- Sensor control
- Sensor interpretation
- Sensor normalization
- Communication issues
- Physical programming of the robots
- Installation of the required software
- Compiling the software for the Robot Controller
- Downloading software to the Robot Controller

3.3.3 Workshop 3: Advanced Topics

3.3.3.1 Objectives

Workshop Three focused on demystifying the technology in the kits, because some of the teachers had a hard time understanding it. The workshop also focused on making sure that the class was well versed in the use of kits. The WPI-EBOT group felt it was important to show the teachers that a fully functional robot could be built in a short

amount of time, and so two complete robots were built and programmed during the two-hour presentation.

The third workshop also focused on how and why sensors are used in robotics. Different types of sensors were covered, and the benefits of each were described. The presentation went into detail on two specific sensors: proximity sensors and reflective light sensors. Proximity sensors detect how far away objects are, and are used for obstacle avoidance and positioning. Reflective sensors detect changes in color, and are primarily used for line following. The workshop covered how the sensors work, how to mount them on the robot, how to wire them, and useful applications.

3.3.3.2 Methodology

In order to give the teachers an accurate impression of the robot building process, it was decided that two robots would be built during the presentation. To avoid simple mistakes or missing parts from preventing the completion of the robots in the two-hour time slot, assembly was rehearsed beforehand. The seminar was designed so that trivial assembly tasks were performed while important information was presented. Important construction steps took place in between presented topics. This allowed the robots to be built in real time, but still provided the best use of the workshop time. Along the same lines, concept code was written with audience participation and compiled for the robots, and a second “cheat sheet” was produced. The presentation and “cheat sheet” for this workshop can be found in Appendix G.3.3.

3.3.3.3 Key Points

The highlights of Workshop Three were:

- Overview of sensor functions and uses
- Building two different robots
- Programming two different robots
- Writing a program in ten minutes
- Demonstrating that robot construction can be done in a reasonable time
- A final question and answer session

3.3.4 Online Archives

In addition to training the mentors in person and through the workshops, the WPI-EBOT group felt it was necessary to provide the schools with online resources that any student or mentor could access. Originally, the intention was to make videos of the workshops available on the web, but after meeting with schools, it was determined that this would not be sufficient. Not only did many of the schools' networks block the downloading of videos over the internet, but also most of the school computers could not play videos with sound. Furthermore, the large file size necessary to ensure that PowerPoint slides would still be legible in the videos would prevent most students from accessing the information from home, since most students did not have broadband internet connections.

When it was realized that significant amounts of written content would have to be put on the web site, it was decided that the site could also serve as a portal for information about the competition. A site was created that had links to rule updates from the tournament's web site, countdowns to events, a directory of public robotics-based curricula, and places for the WPI-EBOT group to put its own content.¹⁷

¹⁷ The EBOT website is available at <http://www.erobotics.org>

A special page was created dedicated to the workshops themselves. For each workshop, links were provided to copies of the PowerPoint presentations, written supplements, videos from the workshops, and further information about the topics that were covered. For the programming workshops, “cheat sheets” were created that listed the basic commands and syntax covered. For the mechanical workshops, which consisted mostly of showing and explaining parts and designs, a manual was written that covered the same topics. Trying to convert oral explanations into written explanations proved quite challenging, and more time was spent preparing the online supplements than preparing for the workshops themselves. However, the feedback from the teachers indicated that the students preferred having the written mechanical guide and programming “cheat sheets” to watching the videos, so the effort was justified.¹⁸

The students and mentors said in the group interviews that the website proved to be an invaluable resource for them while they were building their robots, and the WPI-EBOT group found that having all the important information consolidated in one place made it easier to assist teams. However, there were problems with schools’ ability to access the site. Because it was hosted on WPI’s servers, the main pages were not blocked by the schools’ firewalls. However, some of the workshop videos, which were hosted on other servers, were blocked. Some teams only had access to older computers, which could not properly open the Microsoft Word and PowerPoint documents that were posted, forcing the WPI-EBOT group to convert everything into a more universal format such as PDF.¹⁹ It was vital to remember that important information placed on the web site also needed to be made available to teams through other channels, including email, hard

¹⁸ Based on person conversations with the schools, as documented in Appendix C.1.2.2

¹⁹ Based on person conversations with the schools, as documented in Appendix C.1.5

copies and CD-ROM. Unlike at WPI, internet access at the schools could not be taken for granted.

3.3.5 In-School Mentoring

In order to find out exactly what the students were having problems with, and to help them solve some of these problems, the WPI-EBOT group visited the teams during their regular meetings. By observing the students, the WPI-EBOT group was able to judge the effectiveness of the program, the attitude of the students towards it, and the quality of the teacher mentoring. In addition, because the schools had little experience with previous robotic competitions, so the WPI-EBOT group found themselves helping the teams interpret the rules and answering questions about the competition itself. Teams had trouble understanding the distinction between the WPI-EBOT group and the tournament staff, and therefore had trouble understanding the procedures for submitting questions about the tournament.

Helping the students in person was useful for both the teams and the WPI-EBOT group. The students received assistance when problems arose. Most students just needed to be pointed in the right direction, and were then able to figure out most of their problems themselves. While helping the teams, the WPI-EBOT group made sure to only point out alternatives and advised teams to test each version of the robot. Because few students understood the software, direct assistance with programming was also needed.

In certain instances, the WPI-EBOT group intervened to correct certain construction and programming techniques. For instance, some teams did not use the proper washers when building a pivot and this was pointed out directly. The students quickly picked up these sorts of techniques, and applied them on their own afterwards.

At South High, the WPI-EBOT group members asked the students what they wanted the robot to do. The student programmer described the path that he wanted the robot to take. The WPI-EBOT group then wrote a simple example of how this could be done, with arbitrary values used for times and speeds of the robot. This gave the student programmer an example of how to get the robot to drive on its own. This paid off at the final competition, as this same programmer managed to write a very elegant program for both his school's teams to accomplish their goals autonomously.

The hands-on mentoring strategy was effective, as it allowed the WPI-EBOT group to see how each team was doing. The students on each team were a little different, some asking directly for help, others proposing ideas to their teammates while looking for approval from the WPI-EBOT group, and still others who tried their ideas before asking for help in fixing problems. All of these teams benefited from having the teachers there to bounce ideas off, but having the experienced members of the WPI-EBOT group there benefited everyone.

The WPI-EBOT group's notes from the in-school mentoring can be found in Appendix C.

3.4 The Competition

The motivational power of competition has been repeatedly demonstrated, and a competition format was integral to WPI-EBOT from the beginning. Students working towards a competition will be motivated to learn, because they are actively engaged in doing something they enjoy. By showing students the practical applications of subjects such as math and science, they will have a greater desire to learn this material.

3.4.1 The Kit

The competition kit restricts what materials a team may use, and thus introduces the concept of design tradeoffs. Such restrictions lead to creative solutions, such as using a specific part for an unorthodox purpose.

A common kit of parts put everyone on a level playing field. Each team had the same motors, same controller, etc., and therefore teams could not complain that another was better equipped. In addition to the kits, teams were only allowed to use a few readily obtainable additional materials, such as scrap metal, plastics, and paper. This allowed them to have greater creative freedom, while preserving the level playing field.

Innovation First's Robovation kit was chosen for its ease of use. The parts in the kit are easily assembled with simple tools, and are versatile in application. Each kit contains metal pieces, similar to Erector set pieces, and a robot controller that is capable and relatively simple to program using the "WPI Framework".

This programmability makes the kits more flexible, and allows for the possibility of full autonomous operation. For students with little programming experience, writing code for this controller is often a daunting task. The WPI Framework provides a user-

friendly programming platform with very little programming experience required, which makes it well suited for this competition.

Complete details on the kit used can be found in Appendix G.1.

3.4.2 The Game

In order for the competition to be successful, the game had to be easy to understand, have basic tasks that are easy for any robot to accomplish, and have complex tasks that requires a more involved robot design. Although WPI-EBOT was not directly responsible for game design, the game design group consulted with WPI-EBOT throughout the development of the game. The WPI-EBOT group members were heavily involved with all stages of the tournament and game planning to ensure that it met the project's specifications.

Based on the experience gained by Team 190 from running the miniFIRST competitions, three benchmarks were created for game design. To satisfy the first benchmark it must be possible to explain the game to an outside observer using a single sheet of paper. It should also be possible to explain the game verbally to the observer in about thirty seconds without any visual aids.

The second benchmark is the incorporation of a basic task simple enough to be accomplished by a remote-controlled car with no additional mechanisms. While a robot that simple would probably not win a competition, the game should allow it to be successful if it functions reliably. This allows entry level teams to compete with a robot that does little more than drive, as long as it is carefully and robustly designed and assembled.

To meet the third benchmark, the game must offer a higher-level goal that requires a mechanism or manipulator. The inclusion of the higher-level goal forces students to think creatively beyond their drivable chassis. Teams must carefully budget their time between building and designing a complex mechanism and insuring that their basic robot is reliable.

A full listing of the rules of the game used by WPI-EBOT in 2004 can be found in Appendix F.

3.5 The Role of Mentors

The mentors' job was to assist their students with design and construction problems, to maintain a safe working environment, and to ensure that students do not hurt themselves or damage equipment. Mentors should teach students the basic skills they will need, and give them a nudge, not a push, in the right direction when they need it. The mentors should help students determine the faults with their designs only after the students have had the opportunity to attempt debugging on their own.

While mentors possess the experience and knowledge needed to know which designs and strategies will or will not work, they are often more useful when they play a passive role. The ideal mentor will not explicitly tell students that their method or mechanism will not work, but instead will guide their group in the correct direction or let them realize their own mistakes. Because building and rebuilding mechanisms is fast and easy with the Robovation kits, good mentors can allow students to learn from their mistakes.

Effective mentors should also encourage proper team dynamics. Teams can be dominated by just a few students, and a good mentor will step in and try to maintain equal participation between all students.

Ineffective mentors can often dominate teams and stifle creativity. Mentors sometimes forget that the competition is designed as an educational experience for the students, and decide that winning is more important than teaching. An effective mentor lets the students make their own mistakes so that they can learn from them.

4 Results

Because the goals of WPI-EBOT involve intangible subjects such as inspiration and motivation, the only way to gauge the effectiveness of the program was through feedback from the students and schools. Surveying high school students is a difficult proposition, since they often give false information when answering questions.²⁰

Therefore, on the advice of WPI Professor Kent Rissmiller, several diverse information-gathering tools were employed. Group interviews were used to gather a majority of the data, because students in a group setting, especially in the presence of their teachers, are less likely to give flippant answers. On-site visits with the teams were performed to gain first-hand information on how students and teachers responded to the program. Surveys were given at the tournament itself, but with the expectation that the information obtained might not be entirely accurate. Finally, a “team forum” discussion was held with the teachers after the season, to help the WPI-EBOT group gauge if the teachers saw improvement in their students. The team forum was also invaluable in getting feedback on the schools’ opinions of the program.

The group interviews were the primary data-gathering tool. By getting the students in a group setting, it was possible to gauge the overall opinions of each team. In a group setting, students can elaborate on each other’s ideas and opinions of the program, and come up with insights they might not have had on their own. While students in a group setting are less likely to give false answers to try to fool the interviewers, some students may feel reluctant to voice contrary or unpopular opinions.

²⁰ Based on previous experiences of the WPI-EBOT project group in giving surveys to high school robotics students

The surveys were used to supplement the group data with individual data. Because the surveys are private, they gather input from students that is free of the influences of peer pressure. Surveys can also capture the opinions of all students, shy or outspoken.

The team forum was used to gather information from teachers about their students' reactions to the program. Teachers are best qualified to gauge their own students. They can provide valuable insight into the effectiveness of WPI-EBOT because they are there during the entire competition season and can see how their students progress. The teachers can also provide information on the schools' opinions of the program. This feedback is especially important because the schools must make the final decision to bring WPI-EBOT to their students.

4.1 Survey

4.1.1 Objectives

A survey was given on the day of the tournament to gather the students' opinions of the program. The WPI-EBOT group thought that this would be the appropriate time to gather information because the experience was still fresh in their minds. The surveys also allowed teams made up of students on FIRST teams to be compared with teams from schools that were part of the WPI-EBOT program.

The questions on the survey were selected to allow the WPI-EBOT group to gauge the effectiveness of the program. To understand the how effective the program was the survey had to encompass the wide range of disciplines addressed by the program.

As the WPI-EBOT group began to analyze the survey results, as summary of which are shown in Figure 2, it became apparent that some of the data was flawed. Certain questions asked students if they had learned mechanical, electrical, or programming skills, but failed to take into account that many students may have already possessed these skills. Although they answered that they had not learned anything, this would not be due to any deficiency of the WPI-EBOT program.

Student surveys are available in Appendix E.

4.1.2 Results of Survey

The survey results showed that the WPI-EBOT program had had a positive impact on the students involved. On a scale of 1 to 10, participants rated the WPI-EBOT program 8.5 overall. In addition, 94 percent of participants thought that the WPI EBOT program was fun, and 95 percent would participate again.

Almost 95 percent of participants felt that WPI-EBOT was an educational experience. In addition, 80 percent felt they gained teamwork skills. A majority of students said that they acquired knowledge in mechanical engineering, electrical engineering, or programming. Over 95 percent wanted to go to college.

Interestingly, 94 percent of students who came from FIRST teams found WPI-EBOT educational, versus 84 percent of students from the Worcester Public Schools. One possible explanation for this is that the Worcester Public Schools’ mentors were less experienced than the FIRST teams’ mentors, and were not able to pass on information as well. Another explanation is that students on FIRST teams might see the process as more educational because they can immediately apply the knowledge they gained to building FIRST robots.

Survey Question	No	Neutral	Yes
What is your overall opinion of the WPI EBOT program? (Average)	8.6 out of 10		
Was the WPI EBOT program a fun experience?	1.3%	8.0%	90.7%
Was the WPI EBOT program a good educational experience?	2.7%	14.7%	82.7%
Did you feel you learned mechanical skills?	14.7%	28.0%	57.3%
Did you feel you learned electrical skills?	17.3%	44.0%	38.7%
Did you feel you learned programming skills?	29.3%	41.3%	29.3%
Did you feel you gained teamwork skills?	6.7%	25.3%	68.0%
Would you participate in the WPI EBOT program again?	0.0%	6.7%	93.3%
Would you participate in other robotics program if they were offered?	0.0%	22.7%	77.3%
Do you plan to attend college?	0.0%	9.3%	90.7%

Figure 2: Summary of Survey Results

4.2 Interviews

4.2.1 South High Community School

The interview with the South High School robotics teams took place the week following the tournament. Two of the WPI-EBOT group members sat down with the nine students on the team and one of their teachers in the South High auto shop. A transcript of the interview is in Appendix D.3.

The South High teams prided themselves on themselves on the simplicity of their robot designs. At the beginning of the season, Mr. Ricardi brought in a toy robot arm and had the students try to pick up tubes with it. After seeing how long it took an arm to score, they decided on a defensive strategy. They felt that the lack of complex mechanisms on their robots made them more reliable and easier to drive, and was a major factor in both of their teams doing well at the tournament. They also kept their programming simple, and had their programmer refine a program that did nothing but drive in an arc until it worked exactly as they wanted.

All of the students at South said that they enjoyed the program and would participate again if given the opportunity. One student said that the program specifically made him want to go to WPI more. Others said that they were now interested in going into mechanical engineering or programming, and that WPI-EBOT had given them career ideas.

The students on the South teams said that the most important thing they learned from the competition was teamwork. During brainstorming, they had initially dismissed some people's ideas, but later found that those ideas were the best ones. One student said that he learned that it is important to remember that everyone's ideas count. In addition,

students said that the tournament itself was a great exercise in teamwork because their drivers, due to a lack of students, were forced to drive for both teams. Even during an elimination match where one South team faced the other, the students worked together as one big team.

4.2.2 Doherty Memorial High School

The interview with the Doherty Memorial High School teams also took place the week following the competition. Two members of the WPI-EBOT project group and one of their advisors sat down with eleven of the students and their teachers in the school library. A transcript of the interview is in Appendix D.1.

Unlike the South teams, the Doherty teams both went after complex designs. Due to a delay in ordering the kits, the Doherty teams did not get to start building their robots until the week before the tournament. They spent the first three weeks of the build season brainstorming, and both teams came up with several complicated designs. When they finally received the kits, they found that their favorite designs were not feasible, but they had other designs to fall back on because they had spent so much time brainstorming.

The Doherty students all came from the school's Engineering and Technology Academy, and as a result, many had experience in mechanical design and programming. There was a lot of initial interest in the program, and the school had to have students write application essays to prove that they were serious and willing to commit to the team.

Despite the fact that their robots did not do well, the Doherty students all enjoyed the program, and said they would participate again. The students were able to accept that this was a trial run for them, and did not feel frustrated about losing. Students felt that

having hands-on experience building a robot was useful, and put their class work to good use.

4.2.3 North High School

The WPI-EBOT group made two attempts to interview the North High School teams. On the first attempt, the teachers did not remember to tell the students to come. On the second attempt, the interviewers arrived five minutes late due to traffic and the team had already left.

4.2.4 Conclusions from Interviews

From the interviews with the teams, it was clear that the students overwhelmingly enjoyed the WPI-EBOT experience. Despite the many rough points of the season, and the many obstacles that the teams faced, all the schools and students were eager to participate again. Almost all the students said that they wanted to do more robotics, and many expressed interest in joining a team that builds larger robots, such as those for the FIRST Robotics Competition.

Students said that the program helped them with teamwork and collaboration skills. They felt that they had learned important lessons about listening to other people while brainstorming as a group. Many did not play sports, and therefore this was the first time they had worked as part of a competitive team.

Valuable feedback was also gathered on the competition itself. The students liked having a complex and multi-faceted game. The teachers liked the ease of use of the kits. Most people felt that they did not have enough time to build the robots, but were glad that the build season was not too long. While a longer season would allow the teams to build

robots that are more complex and try more designs, many expressed concern that a build season that lasted more than a month would cause students to lose interest.

Even though the program only lasted four weeks, students said that it did have an impact on them, and many said that they were now more interested in mechanical engineering and computer programming. A vast majority of the students who planned to go to college said that they would like to go to a school like WPI that specializes in science and engineering, and several said that participating in the WPI-EBOT Program had helped them to make that decision.

4.3 Team Forum

After conducting the student interviews, the WPI-EBOT group met with teachers from participating teams. Teachers from South High and Doherty Memorial attended. A transcript of the Team Forum can be found in Appendix D.4.

The team forum began with a discussion of scheduling. It was pointed out that public schools need to know details of all events a week in advance in order to notify parents and send out permission slips. Mr. Hankey from Doherty recommended a back-scheduling technique to ensure that such target dates are met. Teachers from both schools felt that the four-week build period was a little bit short, but that a much longer build season would cause students to lose interest.

The discussion then moved on to the tournament itself. Teachers felt that the requirement that seven students per team must drive was overly restrictive. Not all teams could find seven students to show up on the day of the tournament, and with the limited number of matches that each team played, most students only got one chance to drive. It was agreed that each school should decide on its own how to choose who drives. However, the teachers did like the fact that teams had to switch drivers midway through each match, and wanted to see that remain in future games.

Teacher from both schools also felt that the competition should be designed to allow for easier strategy work. They wanted to see larger areas for each team in the pits, so that they could have a place to gather all the students together and discuss the matches. In addition, all the teachers felt it would be helpful if teams were shown a breakdown of each match's score, so they can better analyze their performances.

All the teachers felt that WPI-EBOT had been a positive experience for them and their students. They felt that the workshops and online resources were very useful, and were impressed with the quality of the in-school mentoring. Mr. Ricardi from South said that he saw his students gaining problem-solving skills, and that the opportunity to build and rebuild the robots helped them to understand the complete design process. Mr. Hankey felt that the Doherty students gained an understanding of how classroom topics can apply to real life. Both were eager to participate in future competitions.

5 Conclusions

The WPI-EBOT project group set out to explore the relationship between education and technology through the creation of an educational robotics program. WPI-EBOT recruited schools from across Worcester, prepared those schools to run robotics teams, and supported them throughout the competition season. Although the WPI-EBOT group faced many hurdles, the program was still an overwhelming success.

The first goal was to create a program that provided students with an entertaining learning experience. Feedback from the students indicated that most thoroughly enjoyed the program, and feedback from the teachers indicated that the students gained valuable experience. Students took ownership of their robots, and as a result, took responsibility for their own learning. All the teachers shared WPI-EBOT's view on the role of a mentor, and let the students solve problems on their own with minimal help.²¹

The second goal was to create a program that was accessible to all schools. The WPI-EBOT group did not anticipate the level of diversity that was found between the schools involved. At Doherty Memorial, participating students came from the Engineering and Technology Academy, met in a well-equipped prototyping lab with dozens of computers, and had little trouble staying after school every day. The teachers at Doherty all had years of industry experience, and were well versed in project management, engineering, and computer programming. On the other hand, at South High, participating students came from various study periods, met in an auto shop, and most could not arrange transportation to be able to stay after school. Both teachers were shop teachers, and had no experience in programming or project management, although one

²¹ Based on interviews with students and teachers as documented in Appendix D

was a little-league coach for years. However, despite these vast differences, both schools still managed to be highly successful in the program.²²

The one school that the WPI-EBOT project was not able to serve was Westborough High School. Although the project group had anticipated schools having trouble finding money, teachers, facilities, interested students, and time, WPI-EBOT did not think that teachers' pride would be an obstacle. The teachers at Westborough felt that they did not have enough time before the season to learn how to use the kits themselves, and were reluctant to learn along with the students. Furthermore, they felt that unless they had a good chance of winning the competition, it was not worth competing. One teacher said that the thought of competing made him feel "physically ill", and another said that Westborough would not do anything where they could not be the best.²³

The third goal of WPI-EBOT was to create a program that encompassed multiple disciplines. The game featured fifteen seconds of autonomous robot operation, requiring significant programming, and required mechanisms to complete complex tasks, which required significant mechanical design. Teams divided themselves into subgroups to accomplish the various tasks, and covered disciplines ranging from engineering to project management and strategy to aesthetic design.²⁴

The original intent of WPI-EBOT was to create a program that could have a long-lasting effect on engineering and computer science education. From the feedback received, it appears that WPI-EBOT was successful in laying the groundwork for such a program. In the future, the WPI-EBOT program needs the continued support of WPI and Team 190. For many years, the miniFIRST competition was run entirely by WPI student

²² Based on personal experiences as documented in Appendix C

²³ Based on personal conversations as documented in Appendix C.1

²⁴ Taken from the team forums as documented in Appendix D.4

volunteers, and similarly, WPI-EBOT needs to find new students every year to take responsibility for running it.

WPI-EBOT would like to see other organizations become WPI-EBOT nodes in the future. These nodes would be responsible for recruiting teams and running tournaments in their areas. To assist these nodes, the WPI-EBOT project group created a handbook, which can be seen in Appendix G. Eventually, a nationwide competition could be held between nodes. The hope is that the work of the WPI-EBOT group can serve as a launching pad for a much larger program.

6 Appendices

Appendix A: Glossary

- Autonomous – controlled entirely by a computer or computer program
- BBIQ - BattleBots IQ, the high school and college offshoot of BattleBots
- Build Season – Time given to teams to build their robots
- C – A high level programming language
- CAD – Computer Aided Drafting
- EBOT – The WPI-EBOT (Education Beyond Ordinary Teaching) educational robotics program was the program created for this project.
- EBOT Node – A group of WPI-EBOT teams which hold their own competition using the WPI-EBOT program as a guideline. Usually run by a single central group, such as a college or high school
- FIRST - For Inspiration and Recognition of Science and Technology. The largest national high school robotics competition
- FLL - FIRST LEGO League, a junior high school robotics competition
- FRC – The FIRST Robotics Competition
- Function – a set of instructions in a computer program
- IFI - Innovation First, Inc., the manufacturer of the Robovation kits
- int – Data type in the C programming language used for representing integer numbers
- Kickoff – refers to the start of the robotics build season, where the game is first announced to the teams
- Mass Academy - The Massachusetts Academy of Math and Science, which is a public high school run by WPI for juniors and seniors
- Mentor – usually a teacher or college student who advises, teaches, and helps a WPI-EBOT team
- Microcontroller – a single chip computer, such as the one in the Robovation Robot Controller

- miniFIRST – The predecessor to the WPI-EBOT which is now a pre-season scrimmage for Mass Academy teams.
- PIC – The brand of microcontroller made by Microchip Inc. The Robovation Robot Controller has two PIC chips controlling various functions
- PWM – Pulse Width Modulation (PWM) is a type of control signal commonly used in hobby electronics such as servos, servo motors, and radio controls
- Radio Controller – usually a hobby radio for controlling remote controlled cars
- RCX – A robot controller created by LEGO for use in their Mindstorms Robotics Kits
- Robot Controller – The ‘brain’ of the robot. This device interfaces all the electronic parts and runs the program that is loaded onto it
- Robovation - The robotics prototyping kit made by Innovation First for the FIRST Robotics Competition, and used for the WPI-EBOT program
- Savage Soccer - The name of game played by the WPI-EBOT teams and the tournament that they attend at the end of the season
- Servo- A small motor that will move to a specific position when instructed to do so by a remote control or robot controller
- Servo motor – A small motor that will spin at a specific speed when instructed to do so by a remote control or robot controller
- WPI - Worcester Polytechnic Institute
- WPI Framework – a library of functions written for the Robovation Robot Controller that allow for easier programming
- WPI Frontiers – A summer camp for high school juniors and seniors run by WPI.
- WPS- Worcester Public Schools
- ZPD – Zone of Proximal Development, the distance between what a student can do or understand independently and what a student is capable of doing or understanding with the assistance of an adult or more capable peer.

Appendix B: Massachusetts Framework Objectives

The WPI-EBOT (Education Beyond Ordinary Teaching) program was designed to be compatible with the Massachusetts Department of Education's Science and Technology/Engineering Curriculum Framework. In the course of completing this program, students will fulfill the following requirements quoted from the Department of Education's Science and Technology/Engineering Curriculum Framework²⁵:

1. Engineering Design

1.1 Identify and explain the steps of the engineering design process, i.e., identify the problem, research the problem, develop possible solutions, select the best possible solution(s), construct a prototype, test and evaluate, communicate the solution(s), and redesign.

1.2 Interpret plans, diagrams, and working drawings in the construction of a prototype.

2. Energy and Power Technologies–Fluid Systems

2.1 Differentiate between open (e.g., irrigation, forced hot air system) and closed (e.g., forced hot water system, hydroponics) fluid systems and their components such as valves, controlling devices, and metering devices.

5. Energy and Power Technologies–Electrical Systems

5.2 Identify and explain the components of a circuit including a source, conductor, load, and controllers (controllers are switches, relays, diodes, transistors, integrated circuits).

6. Communication Technologies

6.3 Compare the difference between digital and analog communication devices.

7. Manufacturing Technologies

7.3 Explain the process and the programming of robotic action utilizing three axes.

²⁵ "Massachusetts Science and Technology/Engineering Curriculum Framework," [Massachusetts Curriculum Frameworks](http://www.doe.mass.edu/frameworks/scitech/2001/0501.pdf), <http://www.doe.mass.edu/frameworks/scitech/2001/0501.pdf>.

Appendix C: *Mentoring Journals*

C.1 Alexander

C.1.1 Spring visits with schools:

All the schools were immediately enthusiastic about the program. Most seemed to think money would be a problem. Others had issues with transportation and storage space. All schools had already set curricula for the fall when we visited, so any effort to integrate program with classes would probably need to be done the previous winter. However, no schools were willing to commit without gauging students interest in the fall.

C.1.2 Fall visits with schools:

Before meeting with the schools in the fall, I spoke with Dr. Traver at the Mass Academy, who suggested that we approach the principles first, and then have them hand us off to the appropriate person (since the principal needs to feel that they know what is going on in the school).

C.1.2.1 *North High:*

At North, we met with Nina Steinberg and Mr. Morse. They had a possible grant from EMC to sponsor a single kit, and they said there was money to arrange transportation to WPI. We never met with the teachers who would be involved, but the school was going to talk to their CAD teachers.

C.1.2.2 *South High*

At South, we met with two shop teachers (Greg Ricardi and David Bordeau) and an administrator (Mr. McFadden). Both teachers seemed very enthusiastic, although neither had any programming experience or experience working with these kinds of kits. Mr. McFadden felt that the program was important enough to warrant funding, because they currently had no engineering programs and were looking to get the started. They also stressed that if the competition would bring about good publicity for the school, it would be worth it. Surprisingly, they said that they were interested in two or three kits, since the real cost was in teacher overtime, not the kits themselves. The teachers perked

up at the mention of overtime, and mentioned that they would prefer to run the team after school instead of during class (to get overtime). There was also concern that a class would be too large. Like most public schools, their smallest classes were around 30 students, which would require them to get 4-6 kits. The teachers would be able to attend workshops after school, but the ubiquitous transportation issues would prevent any students from attending. Therefore, web resources would be very useful, although they preferred write-ups that they could print out and distribute to videos or other “multimedia” content. The school taught visual basic to a few honors students, had a PowerPoint team (!), and felt that they would mostly draw from those kids.

C.1.2.3 Doherty

At Doherty, we met with four teachers and Kathy Kambosos (an administrator). Most of the teachers had engineering experience in industry, but were new to teaching. The teachers at Doherty seemed the most concerned with the details of the competition itself, and asked many good questions. They really seemed to want to get a feel for the program before they committed. They were trying to get approval from the district to purchase three kits. Doherty brought up an important issue as well, that any person who visits the schools more than twice must have a background check done (for the Worcester Schools, this was a CORI check). Since these can take up to two weeks to get, it could present a problem unless taken care of right away.

C.1.2.4 Westborough

At Westborough, we met with Kathy Martin (an administrator) and a group of teachers from their computer science department. Kathy Martin was very excited about the program, but the teachers were less so (and seemed to resent being asked to come to the meeting). They were very concerned about the time commitment we had specified (we said 40 MAN-hours), concerned about getting to Worcester for the workshops if they were that late (they got out at 2pm), and concerned that there was not enough programming involved. Despite that, we had the assurance of Kathy Martin that they would go ahead with the program.

C.1.2.5 Burncoat

I did not visit Burncoat, but after several unreturned phone calls, we finally got an appointment, and they said that they did not have any faculty available to run the program. This is the one school that we did not talk to in the spring.

C.1.3 Post Fall Visits:

Most schools said that they would have an answer about the money in a few days, but in the end, none committed until a few days before the workshops began (almost a month after the meetings). There was a great deal of trouble getting the kits, because IFI and the other suppliers were not listed as authorized vendors for the Worcester public schools. At North and South, a principal or teacher ended up personally paying for the kits and being reimbursed. South got their kits the week before kickoff and North got theirs just after kickoff. There was a lag time of about a month between final approval and getting kits. Doherty, which went through the purchase order process, did not get their kits until just before thanksgiving (giving them a week to build their robots).

C.1.4 Workshops:

The workshops went rather well. We had assumed that the workshops would just cover the academic stuff (using the kits, programming, etc), but we found ourselves spending a lot of time answering questions about the program, competition rules, and logistics. As a result, in the future we would like to do a pre-kickoff to answer all those questions, and to give the schools a deadline for acquiring the kits (you must have them by pre-kickoff). Schools would not make that deadline, but they would probably at least get the kits before the build season started.

Getting workshop videos up was harder than we thought. In the future, I would pre-tape those at rehearsals. The printed material seemed more useful anyway, so we would probably stress those more in the future.

In the third workshop, instead of lecturing, we actually build and programmed a robot in front of the teachers. This seemed to really impress them, and give them the idea that this was easy enough for them to do. We also showed them a bunch of sample mechanism to get the thinking process started.

The only sour note of the workshops was Westborough. Westborough teachers could not attend the workshops, so we arranged with Kathy Martin to have Brad and I meet with the teachers to give them a quick private workshop. However, Brad could not make it, and Kathy Martin was called away on an emergency, which left me to be ambushed by the teachers (who were not so hot on the idea to begin with). The teachers initially expressed concern that they did not have enough time to prepare themselves with the kit (They had the kits a week before kickoff). They felt that it would take them a month or so to get familiar enough with the kit to teach it, and were appalled at the idea of learning *with* the kids. They also said that they would only have 14 school days to build their robot, which they did not feel was enough time (despite me saying that it would only take a couple days to get something driving). Their real concern was that they would not do well given their late start with the kit itself, and that not doing well would sour the students on doing any future robotics stuff. One teacher told me “This is Westborough, if we can’t do it the best, we don’t do it”. Another teacher told me that the program excited him, but the thought of competing in December made him feel physically ill. I tried to convince them that this was doable, but also fundamentally understood that they didn’t want to do this, and that having teachers who didn’t want to be there would sour the kids on doing robotics more than them not doing well would. In the end, they decided to start a robotics club, which would attend the competition but not compete (although they never showed up at the competition).

C.1.5 Build Season visits

C.1.5.1 South

Mr. Ricardi was the main instructor. He had two kits, and his teams met during his free period. Teams were made up of kids who had a study that period, mostly from the honors program. Not all kids could make every session due to the rotating schedules. Mr. Ricardi said these students, who he had never taught before, which were much “sharper” than the kids he usually dealt with in the auto shop.

The first day when he arrived, Mr. Ricardi gave a speech to the kids, saying that although there were two separate teams, he wanted to see them working together, sharing ideas, and helping each other out. He told them that there are two reasons why they were

there: to learn and to have fun. If they did that, they were winners. Without us saying anything, he had stated the principle of Gracious Professionalism. By the time they got to competition, both South teams did not have enough students, so many ended up playing for both South teams.

Before they started with the kits, Mr. Ricardi had the kids play with a robot arm to see how hard it is to pick up pieces one by one. After this, they all decided to make simple plow robots, since manipulating them was just too slow. This proved very effective in competition.

Mr. Ricardi said that he hoped to see creative thinking from the kids. Most of the students had not worked in a shop before or had to do design, and so he thought the program would be great for giving the “geeks” hands on experience.

The students divided themselves into two teams. One team seemed to immediately “get it”, and got to designing immediately. The other team seemed a lot less focused, and did not really have any idea what they were doing. The main difference seemed to be that the “better” team had one student who immediately emerged as a leader, and set a direction for the group. We encouraged the other team to choose a “team captain”, which seemed to help them later on.

Initially, both teams seemed reluctant to actually start putting pieces together. The academy teams that I have watched usually start out by experimenting with the pieces and building prototypes immediately. The South teams would lay out pieces, but never actually put them together until the second week.

We told Mr. Ricardi to encourage the kids to just try mechanisms, and when we visited later in the week, we saw that they had in fact tried a bunch of neat designs, such as homemade casters, and were able to immediately see the pros and cons.

Mr. Ricardi had no programming experience, but a couple of kids on the team had done java. We had a hard time installing the software on the school computers, but fortunately, Mr. Ricardi had a part-ordering computer that was not locked out that he could install the software on. However, the school’s firewall prevented them from downloading the updated software. In the future, we should give all the schools a CD with software, sample code, and documents.

The computers at South also had an old version of Office, and the training materials did not show up correctly. We had to convert them all to PDF for them.

South ended up with one programmer for both teams, and as a result, both teams had the same autonomous mode.

C.1.5.2 North

Mr. Mozynski was the instructor. He is a cad teacher, but had mechanical engineering experience. He seemed somewhat enthusiastic, but also a bit frustrated with the whole process.

Mr. Mozynski wanted to see the kids pick up mechanical design and programming skills, and be able to apply those to a real world problem.

North had two teams as well. The students were an interesting mix, with some clearly bored, some eager to get in a build things or write code although they had no idea what they were doing, and some kids that had a preexisting interest in robotics but had never had the opportunity to do it.

The teams met after school every day, so it was open to anyone that was interested. Unfortunately, many kids who were interested also participated in club sports, and therefore were unavailable.

Both teams had designed lifting arms, which were quite clever. Unfortunately, both teams had not read the rules properly, and as a result, the robots were both too large. Mr. Mozynski was reluctant to start cutting pieces, but did so.

Both arms had initial problems, and the students seemed unable to figure out how to troubleshoot them. If an arm did not go high enough, they would obsess over loosening their slider instead of noticing that the servo was hitting their chassis. We showed them both mechanical “debugging” techniques and software debugging techniques. In one case, the range of the controllers was smaller than the range of the servos, so I showed them how to find out what values were being sent and how to scale them. Later on, they used the same techniques in programming their auto mode.

North also had problems getting access to their computers. They were able to get one computer downgraded to Windows 98 so that they could install software, but that did not happen until two weeks into the build season.

Mr. Mozynski made the suggestion, which was to have a list of all the needed tools, which we would provide to the teams early on. He ended up having to bring things like a hacksaw from home (the school gave him a Purchase Order for RadioShack, but the Shack does not accept Purchase Orders).

I was quite impressed with the creativity of some of the kids, but I also saw many of the kids give up too easily when something did not work. Mr. Mozynski did a good job of encouraging these kids, but he sometimes did so by giving them the answers (and sometimes he gave them the wrong answer).

C.1.5.3 Doherty

Doherty was an interesting case because they did not get their kits until Thanksgiving, and therefore only had a week to build their robots.

Most of the teachers came from industry. The “head” teacher, Mr. Hanky, was only in his first year teaching.

Mr. Hanky, who had a mechanical engineering background and therefore helped with the mechanical stuff, took the approach that the kids should figure out everything themselves. He never gave the kids answers; he just “gave them a push in the right direction”.

Doherty met after school four days a week. They had asked kids to write essays about why they wanted to do robotics and what they could contribute in order to get one of the 16 spots on the team. They got 18 essays, and let all 18 kids on the team (two ended up having other commitments and dropping it).

Before the kits arrived, the teams met regularly to brainstorm and design. Unfortunately, Doherty seemed to be the WPI of EBOT, and designed an incredibly complex mechanism that could not be built from the kit parts. The kids were disappointed with the kits when they initially arrived, but were able to fall back on older, simpler designs.

Even their simple designs were very clever and complex. Very WPI.

Interestingly, Doherty divided their teams into upperclassmen and lowerclassmen. The upperclassmen seemed a lot more “on the ball”, but were also a lot more resistant to outside suggestions. I accidentally started an argument in the team when I demonstrated that chains were not the best lifting mechanism for their arm, when a couple of students

refused to abandon their design. They often sent the teachers away and refused help, wanting to figure stuff out on their own. The lowerclassmen sought out help, and often asked Mr. Hanky to just tell them the answers.

I did not deal much with their programmers, but the students and teacher both seemed to know what they were doing once I showed them the sample code. I had to walk them through making a flowchart for line following, but they were able to translate that into code.

Doherty did not have any problems accessing computers to install stuff. They had the same web proxy issues, but we were able to get around that by mirroring stuff on WPI's servers.

When we first visited Doherty, a kid approached me because he saw my WPI Robotics hat. He said that he was interested in Robotics, and had no idea that there were high school robotics teams. Because their EBOT team was full, we did not tell him about that, but did tell him about FIRST and the WPI FIRST team. This shows that there are kids out there who really want to do these types of programs but have not had the opportunity.

C.1.6 Competition

The competition went rather well, and all the kids seemed to have a great time. Unfortunately, my duties in the pits prevented me from seeing most of the competition, but from what I heard, all the teams had robots out there driving.

The simple South robots did very well, and held the high score record in the morning. They had trouble getting all the kids to WPI, and ended up with only ten kids there between the two teams. I had a hard time tracking down the South team most of the day, but it turned out that they had grabbed a classroom and were practicing there.

The north robots proved too complicated, and their grabbers too slow to be effective. I had some trouble in the pits with the students, and had to at one point physically take their radio to prevent them from interfering with a robot that was playing a match. Other people told me of similar problems. They did have one amazing driver, but he also lacked discipline.

The Doherty robots suffered from a lack of practice, which is understandable given their short build season. They spent much of their time in the pits debugging.

Both South robots got into the elimination rounds, and ended up facing each other. With the same autonomous mode, both robots performed a very nice synchronized routine. The winning robot went up against the team that ended up winning the whole competition, and could have won if they had better strategy (they discovered the winning strategy, blocking Team 10's tube sweep by driving into it, too late).

All teams were restless about waiting for the finals to end and the award ceremony to begin.

More details on the competition are in the interview transcripts in Appendix D.

C.2 Sean

C.2.1 Doherty

Early September, initial meeting

- Extremely enthusiastic
- Half a dozen people there at least. All engineering teachers
- Very friendly, not afraid to ask questions
- They like the competition aspect
- Were slightly wary of the Programming aspect, like others are, but have faculty that knows C++
- Kathy was concerned about money (as is her job)
- Want to start 2 or 3 teams, very surprised, and happy to hear

C.2.2 North High

Early September, initial meeting of the year

- Money was a large concern, however they had a good chance of getting a grant from EMC
- Programming in C is a big issue, Nina Steinberg doesn't know of any teacher who knows it
- They would like to get it integrated with a class
- Gear Up is a grant to help students get to college campuses, could possibly be used for getting to WPI
- Nina Steinberg will meet with tomorrow to discuss the program

November 26th, 2004

- Showed 2 students how to use sensors. One student knew how to already
- Showed how to connect the two connectors for the three sensors (Justin's neat wiring job)

C.2.3 South High

November 29th, 2004

- Students seem quite interested
- have redesigned each robot at least once
- no real programming as of yet
 - had to help them write something

December 2nd, 2004

- Huge issues programming the robot (with computer, not the code itself)
- “Smart” group has been testing their drive train quite a bit
- Both groups have been practicing driving extensively
- After practicing, they have been redesigning

December 3rd, 2004

- Went with Brad to program their robots with framework 1.3 using Brad’s laptop
- They were making final preparations + practicing mostly
- Teachers were making sure that students knew when and where they were supposed to be on Sunday.
- Helped kids from one team make a simple autonomous mode
- Teacher talked about how the teams were rebuilding all the time, and how much he liked it
- One team over the past 3 days had chopped their robot in half to make it turn more easily.

C.3 Justin

C.3.1 North High 11-21-04

Went to the shop helped install the software on the computer. There was one problem with installing it on the computer that was connected to the schools network. Explained the problem with the radios receivers. Programmed one robot to drive with the radio. Only one team had a driving chassis. We are supposed to return next Monday to help.

C.3.2 South High 11-21-04

One team was doing really well and had a driving robot and was working on a mechanism. The other team was working on there drive train and the hole robot did not look as promising. Alexander helped two students with programming why I tried to help with mechanical aspects of the robot. I was really impressed at one student who made a point that this in not about winning its about learning. I have to wire up the sensors and drop them off tomorrow.

C.3.3 Doherty 11-24-04

Went to Doherty today the school just got there kit in that day. They started brain storming using the parts lots of hands on work. Some really cool ideas but not all of them were feasible. They would have liked a longer build time.

C.3.4 North High 12-02-04

- We think the teacher was enjoying the program and was happy to see that some students were really getting something out of the experience.
- The teacher was concerned about the amount of time they had to build the robot and would like to see a longer build season for first year teams.
- The teacher was frustrated with the WPS systems way of handling money and worried about the getting the kits on time
- The teacher was also concerned that he would not be able to use the kits until next year do to the fact that they have to cut parts to build a robot.

- He would be interested in competing with the other Worcester public schools.
- Some of the students were not that you would not think would be building robots were doing amazing things with the kits,
- One team had a robot that was of good quality and looked like it would do well in the tournament
- The school came up with a very clever idea to make a robot turn (i.e. adding tape to the front wheels so they would slide).
- Students were having a hard time programming the robot to do tasks that they wanted.
- They needed the most help in programming and a few mechanical adjustments.
- The second team was a little disappointing most of the students were goofing off and their robot did not look to be in good condition. The robot would drive but it would not lift a tube into the 2x scoring depot.

Appendix D: Interview Transcripts

D.1 Doherty

The interview with Doherty students took place the week following the tournament and was designed to get feedback from the students before they left for winter break and forgot everything. The WPI-EBOT students met with the Doherty students and administrators in their library.

Interviewers:

Justin Woodard

Alexander Hecht

Brad Miller

Students:

Tom Blankenship, 11th grade, 16

Meenal Datta, 11th grade, 17

Justin Linnehan, 11th grade, 17

Prasant Lokinendi, 9th grade, 14

John Waters, 9th grade, 14

Endi Tollkuçi, 9th grade, 15

Egin Tollkuçi, 11th grade, 16

Matt Brennan, 10th grade, 16

Will Staruk, 11th grade, 16

Eric Rawdon, 12th grade, 18

Alexandra Markello, 11th grade, 16

Teachers and Administrators:

Mr. Hankey, teacher

Kathy Kambosos, administrator

Alexander: By a show of hands, if this program were offered again, how many would participate?

[all raise hands]

Alexander: Would you be interested in participating in other robotics programs?

[all raise hands]

Alexander: I know that you had little time to build the robot, but did you feel prepared for the competition?

Tom: Semi-prepared. Mechanically, we were all set, but programming-wise, electronically, testing issues, we weren't that ready.

Alexander: Was there any previous experience that you had had that was useful when you started building the robots?

Alex: Yes, I can speak up for the group. I know that Eric here has taken a few programming classes, so he's all set with C, and Justin is an expert in electrical engineering, so we're all set there. Basically everybody's taken Engineering, so we kind of knew how to build the robot. We've played with LEGOs before, so it's all good.

Alexander: In terms of the stuff you didn't know, how many of you found the study materials and resources that we gave you helpful? Was there more you would've liked to see?

Prasant: I think that the stuff online was pretty useful, and it was really good to watch the videos as somebody showed us how to do stuff, and the scrimmage [video] just to get some strategies and see how the other robots worked out.

Eric: I couldn't really find too much about the light sensors, because that would've helped with the programming.

Egin: Pictures of other robots would've been good to see.

Justin W: How were the kits to work with?

Egin: We had an original idea, but when we got the kits, we found out that we weren't able to build it with the kits that we had, so we had to go back to old ideas that were simpler.

Brad: What were you expecting to be in the kits that wasn't there?

Egin: We thought it would be a lot more, there would be a lot more parts, because we were running out, taking parts from the other kit.

Brad: What was the other team doing?

Egin: They didn't use them.

Justin W: There wasn't anything specific you were missing, just the lack of quantity.

Egin: Also, the gears didn't quite work at all.

Brad: The gears?

Alexander: There weren't gears in the kits, they were sprockets.

Egin: There were little gears, but we didn't know how to attach them.

Alexander: Oh, those were replacement gears for the motor.

Alex: For a chain, we only had a little chain about this big and it was plastic, and it would've been better if we had maybe a bigger one that was more sturdy and a little bit longer. We wanted to use that for a pulley device, and we ended up using string which breaks a lot and isn't that reliable. Also, a little more sheet metal, maybe different pieces and sizes.

Brad: Did you use materials other than what was in the kit?

Will: We used some small pieces of wood, some plastic sheeting for the window and roof of the robot, we used Pokemon cards for decoration.

Alexander: What was the competition like for you?

Prasant: Stressful. We didn't really expect the robot to do that bad. We had time between the rounds to work on it, so it was good they weren't all crammed up, and there was time to actually work out the problems.

Endi: It was also good that they had recharging pits near everything. We programmed, and the program wasn't working right...

Brad: So you took advantage of that, Sean was over there helping you get everything programmed?

Endi: Yeah.

Brad: And that worked out?

Endi: Yup, very well.

Brad: Was there something that you weren't expecting?

Prasant: The bump in the middle of the carpet was a surprise for us.

Endi: We couldn't get over it, that's why we were stuck there.

Alexander: Did you modify the robot during the competition?

Endi: A lot actually.

Will: We found ourselves making some heavy repairs to our robot. We had to replace our poly-cord once. We had to take out a motor, replace it, redo it in between two rounds, fix an old motor, and get it in there.

Meenal: We also had to replace the wheels when we switched the motors around, because our wheels were too large and we were using up too much of our power, so we did that in between rounds.

Brad: Did you make changes as a result of seeing the competition?

Mr. Hankey: Because we started late, these guys, I wanted to put in a plug for them, they had the kits literally a little over a week. Everyone you see in this room was here pretty much every day from that Monday to the competition. Every one of these students participated in creating their robot from scratch. They elected to come in Saturday morning at 8 o'clock and work until after 1 o'clock. Both teams just finished their assembly work and the first round of code by the end of that Saturday. They crammed a month's worth of activity into a week, and I commend them for that, but it left them on the short end of the stick come to competition time, because they were literally in debug mode as the competition unfolded. This is a room of over-achievers here. These are very bright, very talented, very aggressive students. I think that they would've been under intense pressure unless they had completely blown away the other teams that they competed with, and they competed with 12 other very strong teams of capable students as well, so of course they are going to feel a little bit of tension, a little bit of pressure, but I

didn't see anybody upset. I saw people who were really focused on the issues, and I thought I saw you guys having a really good time.

Justin W: Besides having more time to build your robots, can you think of anything else that would've improved your performance?

Endi: If we had more time to program it, we only had two or three days. But the fact is we needed not more time to build it, but to program it, but have more strategies, more than just one, to debug everything.

Alex: I wish we had more time to test, because we weren't able to do any testing and debugging, and I think if we had that and were able to get used to the controls and get really good at maneuvering the robot, we would've done ten times better.

Egin: We tested our robot for an hour on our carpet, but when we got to the real competition the carpet was bigger, so maybe if we had a sample. It worked perfectly for us, but at the competition it got stuck and didn't work at all. Maybe practice on the real playing field.

Justin W: did you do any strategy work?

Prasant: We did three full weeks of strategy, since we had nothing to do. We just, day after day, would think of different ones. Once we got the kit we found it was pretty hard to make in a week all the stuff that we wanted to do, so we had to dumb it down a little bit, make it a little more simple.

Alexander: Were there any strategies you came up with after seeing other robots at the competition?

Prasant: We saw some robots that were similar to ours, and it was like what we had wanted to do but didn't work out for us.

Alex: I thought a good idea would be to defend, because I saw some robots blocking other robots from getting to the multiplier or getting to the über tüber or something like that. A good idea was just to get in there and stop them from getting to wherever they wanted to go.

Justin W: Did you use that?

Alex: We tried to, when our robot moved.

Justin W: If you could change anything about the competition, what would you change?

Will: The music. It wasn't bad, but there were some songs that were terrible.

Prasant: Maybe more than one field to play on, for time purposes.

Mr. Hankey: Or a practice field that allows teams to refine some of their strategies.

Will: The schedule was a bit unfair, because we ended up playing the undefeated winner twice and a lot of schools didn't play them at all. I thought they could've tweaked that a bit, and it could be a big improvement to the competition. It wouldn't be fair if the Red Sox played the devil Rays every single game.

Justin: Also, in the working area, where we made our repairs and tuned up our robot, I wish that the tables were a little bit bigger. We found it really hard to work with two teams on one table.

Alexander: Tell us about some of the mechanisms you designed.

Alex: The complicated mechanism with the track was a scoop, but instead of coming in [straight forwards], it would move around a D-shaped track and come in a scoop up from

the bottom, and then when we moved over to the multiplier it would release and continue on the track.

Alexander: How about the other team?

Endi: Our team was discussing different strategies, different option. Once idea was using a forklift, using a snow plow – which we ended up using, having just one big wall, having two arms to grab tubes.

Alexander: Why did you decide not to use some of those?

Prasant: There wasn't time. Time was an issue, I think, for us because of the late arrival of the kit. We didn't really have the time that we wanted to think about it.

Justin W: How hard was it to design a robot with the two minute match time in mind?

Eric: I think it limited some of our ideas, because we right away got rid of a claw idea because it's just too slow, you can only grab one thing at a time. So basically, we were only looking for designs that could take multiple tubes at once.

Will: We also had to consider that speed is a primary factor. Our strategy was to go them as quick as we could.

Alexander: What are your thoughts about the game itself?

Tom: It was interesting, very original. I went to the competition last year, and thought it was really different. It was a good idea.

Alexander: What about the venue.

Endi: It was a bit too small in the pit area.

Justin W: What about as a spectator?

Eric: You had a pretty good view of the field. I know my parents enjoyed watching the competition, they thought it was neat. It was good as a spectator.

Alexander: Back to the robot, where did your ideas come from when you were brainstorming?

Matt: Randomly drawing stuff. For our group, we drew a bunch of unrealistic robots, and then from there we took ideas and they turned into our robot.

Justin: We looked at the field and what we could do, and just came up with the most efficient strategies that we could create. We looked at what parts we had and applied it to what we could think of. We then looked our original design set and thought “we have to remove this” or “we have to add that”, and we fine tuned what we could and changed what we could. Eventually we came up with our final product.

Alexander: What was the hardest part of building the robot?

Justin: Time was definitely a restriction. Besides that, there was also programming. We were going to use the sensors, and we spent a lot of time trying to straighten those out. Eventually, we just dropped them because we were spending too much time on that.

Tom: The program was kind of odd. The switches seemed to work to do complicated tasks, move the arm, make it go left and right, but if you wanted it to just stop, it wouldn't do that – we couldn't figure out how to do that.

Justin W: How was working as a team?

Will: I thought that our team worked together really well. We had people who were good at a bunch of different things. We had people that were really good at programming, at electronics, and at the actual construction. I think we worked together fairly well, considering all things.

Alexander: And the other team?

Matt: We had a good team.

Justin W: Did you know each other before hand?

Eric: I knew no one coming in.

Will: Yup, I knew everyone on our team except him. The rest of us applied together hoping to be on the same team, and it worked out well.

Brad: What was the process for applying?

Eric: We had to write short essays to show that we were committed enough to devote the time.

Mr. Hankey: We were looking for 16 students – six teams of eight, and we obtained 18 applications, people who submitted serious applications. We accepted all 18, but three people decided not to compete, so we wound up with 15 serious competitors, most of whom you see in this class today. There are a couple of “serious competitors” that couldn’t make it today, but all 15 of those people showed at the competition, and probably spent most of last week working together with their colleagues.

Alexander: Let’s talk about the design process a little bit more. What was the process for coming up with your design? What did you do for brainstorming.

Will: The first thing we did, the very first day after we got our team together, is we sat down and thought of all the ways we could score, and got three basic designs down on paper. A couple of people would then go off, evaluate one, and think of how we could improve it. At the end, we had a big meeting, and after a couple of days thinking about it, we all decided what the best one was. We reached a decision, and it turned out we couldn't build it, so we back to one of the other fallback ones, which we tried to build.

Prasant: We basically did the same thing as the other team. We sat down and thought of ideas. Some people thought of unrealistic ideas, like putting grenades or something like that. Then, we narrowed it down to a couple of strategies and we thought of different ways to score, how the game is played, and the rules. We then worked with that.

Justin W: Was there any area you designed first, or did you do it all at once?

Egin: At first, we thought about the most efficient way of scoring and getting the most points in the two minutes. Once we got our kits, we figured out that the best way to do that we couldn't build, because it was too complex. We did the second best thing, but we built it around the scoring.

Mr. Hankey: What if you had had the kits in your hands the first day? What process do you think you would've used to develop your design? If you didn't have the time issue, what would you have done?

Will: We probably would've done the same thing, but a couple of ideas we wouldn't have even been thinking about because we would've seen that these weren't options.

Eric: We would've come up with more realistic ideas right away rather than the more complex ones turned out not being able to work.

Alexander: Beyond the four weeks, if you had an entire year to build the robot, how would that change things?

Endi: We wouldn't be as committed because it would take too much time. The game itself is only two minutes, and to use a year of your time to build it is kind of a waste.

Prasant: I think it being a year is a little too long. I would think we would want two months or three months or something like that. With a year, people would lose interest or drop out.

Egin: I think if we had a year, then we wouldn't have gotten down to our dump truck idea, we would've had more time to figure out how to build a more complex idea and do more research on it. There's a big difference between a week and a year.

Alexander: Doherty divided the teams based on age groups. Did the older team have an advantage?

Eric: I'd say in our case it does because we're all in the engineering program, and because we're older we've all gone through more advanced stuff. If we're all juniors, they've all been through electromechanical and onto the practical with an internship now, whereas they haven't done the electromechanical or even the mechanical yet. We have more hands-on experience as well as the mathematics behind it.

Matt: We had some kids on my team that would get bored because they knew how to do the programs because that's all they did, and they'd play around with the computer at that point because they would be done with the program. I think it's the person, it doesn't really matter what age.

[unknown]: The one nice thing about having one team younger is that when they repeat this next year, and the next year, and so on, that they will have an easier time strategizing the game and building a robot.

Justin W: Do you think the experiences gained here will help you outside the competition?

Eric: I would think so. Depending on what you would pursue in college, a good hands on experience with programming or building a robot is always useful, because you learn all the theories, but a lot of the time you don't get to put them in use. This was a good way to use what we've learned.

Will: It also gave us some practice with designing and going through the process of finding out what works and what doesn't, and it was a lot of help working with other people, including some people you might not have known. It's pretty useful.

Alexander: What do you plan to do with these kits now?

Justin: Dismantle them and use them next year

Kathy Kambosos: Our next learning fair is next week, so what I was hoping is to have them on display so the parents can see what they are. I would like one of the students to briefly talk about it while all the family members and community members from this area will be at our ninth grade learning fair. One of the things that were talked about was having a robotics club, and we'll see, that's all being established or talked about at this point. But we'll definitely be using them for the following years. If you don't change them.

Justin W: Would you participate again next year?

Kathy: It's something that the kids can look forwards to.

Justin: How about another competition in the spring?

Tom: Probably more so than next year, because we already have our teams together.

Prasant: And the knowledge is already in our heads. Next year we might forget or something.

Justin W: How about competing with just the Worcester Public Schools

Will: If we got rid of the Mass Academy, I think it would be a lot more fair, amongst just the Worcester Schools. Plus you get a whole grudge match going, who's the best of the publics. Send them on against Mass Academy.

Alexander: How many of you are on Sports teams?

[about half raise hands]

Alexander: How did doing competitive robotics compare?

Eric: It shows the same teamwork skills, but it's not athletic. It shows the same working with teams. With sports, you're a little more afraid of failure, but with this it was more trial and error. I know it was my first time, and we knew that we didn't have as much time as everyone else. We just weren't as prepared for it, so I think this is more of a trial for us, we weren't really expecting to win. It wasn't as frustrating.

Will: I also think that while team sports emphasize the team, with this, it really didn't matter what one man did, it's all of us in the competition. If one man screwed up some, everyone else could fix it right away. In team sports, you each have to play a role, but in this everyone was changing roles. It really emphasized the team.

Brad: Is this the first time you've worked in teams outside of sports?

Eric: I know the senior year in engineering, we do have small classes, but up until I did my internships, we would have projects due every week and split into groups of four or three.

Alexander: How many of you are planning to go to college?

[all raise hands]

Alexander: Has this made any of you more inclined to go to WPI?

[three or four raise hands]

Eric: A lot of us already wanted to go to WPI.

D.2 North

The WPI-EBOT group made two attempts to interview the students at South High School, but both were unsuccessful. On the first attempt, Mr. Mozynski did not realize that the WPI-EBOT group wanted the students at the students interview. On the second attempt, the WPI-EBOT group was five minutes late, and the North robotics teams had given up and left.

D.3 South

The interview with the South High School students also took place the week after the competition. The WPI-EBOT group met with the students during their meeting time in the middle of the school day in the auto shop where they built their robots. Because it was held in a working auto-shop, some of the discussion could not be transcribed due to background noises.

Interviewers:

Sean Donovan

Justin Woodard

Students:

Jude Kamiri

Mark Semsenig

Aaron Ilovoci

Paul Duffy

Sean Hashem

Andrew Erickson

William Hubert

Dan Hoffman

Juan Gomez

Chris Grover

Teacher:

Greg Ricardi

Sean: First off, could we get a raise of hands from all you guys? How many of you would participate if you could do this again next year?

[everyone raises hands]

Sean: Everyone? That's always a good sign. Okay, our big question of the day for our project is: How well prepared were you for the competition?

Andrew: I think we were prepared because our robots were simple enough that we didn't have to make any major adjustments. The other teams had complex pulley and lever systems that they could break easily and they constantly made adjustments.

Jude: And if it wasn't just so, they'd have to tweak it.

Andrew: They'd have to use their other stick to control it.

Greg: The other thing I saw is that we were at a slight disadvantage. I know the playing field was open for us to go over there, but it's hard to transport students. They have jobs, no transportation at all, a lot of homework, and it's pretty hard to get over there. Mass Academy happened to have all of the top three teams, and they had the advantage that they were there all day. So I find that a disadvantage for us, going up against someone that sees the field and gets to play with the field.

Justin: So if we could design a game with an easy to build field or if we release instruction on how to construct the field so you may be able to build the field here, do you think that would help?

Greg: Either that, or just unveil the field to everybody, but have that be it, no practice on it. If you want to build your own to practice, that's fine.

William: That was one abnormally good robot

Jude: Yup. We didn't figure out autonomous mode, and what we had to do with it, until we got there and saw the field.

Sean: About that, how easy was the programming?

Dan: It was really easy.

Sean: How many times did you change that program you wrote?

Dan: At first I tried to write one that hit the multiplier, so we rewrote it four or five times. But in the end, we just had the “drive straight one” that curved just right.

Greg: Dan did a fabulous job. He tried to make it do other things, but then he went back to the just drive straight and it drove straight right into their corner. So then we went back to the drawing board and we watched the clock and we saw how long it took our robot to get partway across, and we put the turn in to catch the über-tüber. But Dan probably did it five or six times at least, and he did a heck of a job, him and mark. Good people.

Sean: Have any of you been to another robot competition

[various nos]

Justin: In that case, what did you think of the competition? Was it what you expected?

Jude: At first, when we read the rules of the game, it was really complex, but when we got there, we got the hang of it. We knew what we had to do, we had our strategy, and it worked surprisingly well.

Sean: When did you decide on your strategy?

Jude: From the beginning decided to block, and then we saw that the über-tüber was a multiplier, so we used that to gain more. Instead of working on just one tube, getting it in our color and in our box, we decided to go for a lot of tubes, no matter what color, no matter what type, in our square so we score.

Sean: Did that change at all?

Greg: We didn't have much of an option with out robot, and we also found that if we got the one with the tennis ball, both our robots could actually push that one and keep the tennis ball on top. Then it got to be a defensive game. We went back to the drawing board a few more times – it depended on the robot we were up against. Maybe if we had done some more observations and made notes on which robots were which. The only one we really sat down and strategized against was the robot that won the whole competition. All we could think of was to do a quick scramble, get in the corner, and play defense. We saw that they strategy was to hit the multiplier and scoop up all the opponent's tubes and leave theirs standing, so they got all the points for theirs standing, and put their opponent's in their zone. But you could actually see with our two robots that we actually both had to play each other, and they split the field.

Justin: So, was there anything at the competition that you didn't expect?

Andrew: Well, I didn't expect us to do so well. I starting seeing everybody else's robots, and they had lifting arms and spinning things, they had all these complicated things, and I though "Oh man, we're going to get blown out of the water". The first match we had was 56 points, and we said that the average was 17, and I thought "Wow, we are doing really well".

Sean: Why didn't you go with a complex mechanism?

Mark: It's easier to build a shovel.

Jude: The time constraints. We're only here sixth period, and then it's not every day.

William: It was sixth period for what, three weeks?

Greg: Some of them came every day, and some of these students had class, and they can't miss it. But even 42 minutes isn't a lot of time, and there isn't after school bus transportation. Plus, some of these kids have sports and jobs, and they have no way of getting home, so unfortunately, we were restricted to class time.

Justin: How would you compare this to being on a sports team?

Andrew: There are some similarities and some differences. The games require strategy and coordination. The difference is the physical content. You can tell people that were uncoordinated, they were unsure of what to do with the joystick.

Sean: How about the team atmosphere.

Juan: Teamwork? We had a lot of that. We had two teams originally, but not enough people showed up at the competition, so we were switching drivers between our two teams. It really didn't matter whether you build robot whatever, you didn't go to the other team and sabotage it. We were working as one big team. Also, another thing with sports is that it is just as competitive. There was some trash talking and some stuff. Nothing too serious, but people were saying things about how our robot was so simple.

Andrew: People were mocking it.

William: And we still won third place.

Greg: One thing I'd like to say, is that I'd like to see less mandatory drivers. We were fortunate in that we had two robots and made the finals, so that everyone got to drive three times. If we had seven drivers, and they didn't make the finals, they were there from 8-8:30 in the morning until two or three in the afternoon to just drive once for 45 seconds. I'd like to see either less drivers or more matches going at once, so you could have two fields going or three fields going, so these two can driver over here, and then over there and over there. I have to give these guys a lot of credit for staying there the

whole day and not wandering off, either they were watching the competition or going in a back room or something.

Sean: What was it like to go up against each other in the semi-finals?

All: That was fun, that was so fun. That was one of the best matches.

Justin: What would you change in the game?

Greg: You did have a lot of options to score, so people could do a lot. However, no one did things like flip over the tubes – it took too much time. You did have a lot of options, which was nice.

Sean: Back to the robot, did you guys face any major challenges in building or programming?

Aaron: Trying to decide what we should use for wheels. We tried a bunch of things, golf balls, bottle caps, casters. Just deciding what to use.

William: Two wheel drive, four wheel drive, three wheel drive.

Dan: We notice that one of the motors was slower than the other motors, so we turned left. To correct it, we put in the program stuff to correct it, so we were able to tell the other wheels to go the same speed.

Justin: How did you decide which wheels to use?

Aaron: Which ones turned good.

William: The other team tried four wheel drive, and we were going to try four wheel drive, but we saw that they couldn't turn that well, so we decided to try different wheels.

Sean: How many times did you rebuild your chassis?

William: Three times.

Aaron: Yah, three times.

Sean: Each?

Aaron: Yah.

Justin: What would you like to do with these kits now? Next year?

Greg: I would like to see school competitions with just us. I'd like to do something between the public schools. I'd also like to get some money for more kits, have a club. We'd build our own playing field, maybe have four robots.

Justin: For the students: What was your favorite part of the program?

[Multiple students]: I liked driving. Yes driving. Driving.

Sean: How much practicing did you do?

Juan: Just Thursday and Friday.

William: I honestly didn't touch the robot before the competition.

Sean: Which was your least favorite part of the program?

Andrew: When we had to redo the program twice.

Juan: That we weren't the winner. [laughs]

Sean: What was the most important thing you learned?

Aaron: We learned how to work together and not toss out other people's ideas. We initially were ignoring Mr. Bordeau's idea with the golf ball, but we later realized that that might work, so we tried it and it did.

Juan: I would've given the same answer. Everyone's idea counts.

Justin: How were the kits?

Aaron: It was nice that we didn't have to cut anything, we could just rebuild stuff.

Justin: Is there anything new you'd like to see in the kits next year?

Aaron: Motors. Different motors.

Greg: More replacement gears, since that is a weak part of the kit.

Justin: How many people here didn't know each other when you joined the team?

[most students raise hands]

Sean: What did you like about the game?

Dan: I liked how there were infinite number possibilities to score.

Jude: I liked the tubes, they were neat, how you could flip or grab them.

Sean: What would you do differently?

Aaron: A bigger field, and more playing time. Instead of two minutes, make it more.

Andrew: More things to do.

William: Yah, instead of just red and blue tubes, how about green ones worth five points, or something like that.

Sean: Did the two limit window limit your designs?

[Various yeses]

Justin: How about the build time? Should that be longer?

Greg: If you make it too long, the students would get bored with that. Four full weeks would be good.

Sean: Would having the kit beforehand, before the kickoff, would you like that?

Aaron: Yah, it would be more useful by the time we began.

Juan: If we had it before, we would have something more elaborate on the robot itself, because we could build the basic thing and see how it runs and see what its problems are, since we would have so much more time. We could have something bigger, something better, just something more.

Justin: How many of you are thinking of going to WPI?

[all but two raise their hands]

Justin: Did this at all change you opinion on going to college in general?

William: Just makes me like WPI more.

Aaron: I'm more interesting in mechanical engineering and programming.

William: Yeah, I know what you're saying.

Jude: I'm more interested in programming.

Aaron: It gives us career ideas.

Justin: Any questions?

William: How do we get involved in the big robots?

Justin: Well, you can either get a team started here at South, or you can join WPI's team. With this program, would you like to see more schools involved, with bigger tournaments or more tournaments?

[many yeses]

Sean: More, or bigger?

[many people saying both more and bigger]

Sean: All right, I guess we are done. Thank you very much.

D.4 Team Forum

The team forum was held after the tournament to get feedback from the teachers without the students there. The EBOT group and project advisors met in a conference room at WPI after school. The team forum included a lot of side discussions, and this transcript has been edited to include only relevant information.

Teachers:

Greg Ricardi (South High School)

Bill Hankey (Doherty Memorial High School)

Kevin Donohue (Doherty Memorial High School)

Project Advisors:

Ken Stafford

Brad Miller

EBOT IQP Group:

Alexander Hecht

Sean Donovan

Justin Woodard

Alexander: The point of meeting is to gain feedback from the teacher side on how the program can be improved in the future. The goal of the project is to create a product to help schools get this program started, so it is very important to get feedback on how this product could be made better.

First, to start out, we are planning on distributing a list of recommended tools next year, and that list currently includes:

- Socket wrenches
- Nut drivers
- Hacksaw

- Pliers
- Vice
- Extra Allen wrenches
- Tin snips
- Hot glue gun

Is there anything else that should be added?

Mr. Ricardi: The only thing I thought was missing was those gears that strip [in the motors].

Mr. Hankey: A list of spare parts.

Alexander: What we have listed here for suggested spare parts for the future are:

- Additional internal gear
- Spare batteries
- More long motor screws

Mr. Hankey: I don't see that you guys did anything wrong, I see that you guys did a great job putting that package together. The only thing I would add it that you might try back-scheduling, that technique. I think I mentioned that to you guys at the group interview. If you say that the competition is December 5th, local high schools in particular need at least a week's notice, so we should have the final agenda, where it's going to be, who's invited, when can the kids show up, when should spectators begin to arrive, that sort of thing. For example, we would need to know almost anything that happens almost a week before because we need to send permission slips home and arrange for transportation.

Ken: When did it come out this time?

Brad: It was a day or two before.

Mr. Hankey: There's a myriad of details that go along with making sure that the kids are safe and that they are where their parents expect them to be when they expect them to be there. There's a lot of minutiae that's our problem, that would be very helpful if we had the time to deal with and make sure that it comes together.

Alexander: So in general, one week is what you need?

Mr. Hankey: I would say that if we involve the students in any activities, we need a pretty cast in concrete schedule within five school days.

There are things you want to have piled up. You need to say "we need to send this a week before." From my project management days, we used to back schedule. You know, we have to have this up and running, we have to have this part by such and such a date, and we'd sit there and say "to do that, I have to get Marketing's approval here", and you go back through the whole thing, and all of a sudden you find out that you should've done stuff two years ago that isn't done yet.

Alexander: Back to the kit. Would having a list of field components before the season, such as 1x3 wood of a certain length or a carpet of a certain size, help?

Mr. Hankey: I think four weeks is a long time, assuming you have everything at your disposal that you are supposed to have. All the things that you throw out at the last minute, what the field looks like. You guys aren't going to change it dramatically from last year, it's going to be a similar size, so if we want to build a practice field, you can. Those kinds of things were fine.

Alexander: A big issue was getting kits to schools on times. Do you guys have any advice on making sure that new teams could get kits in time?

Mr. Hankey. First, we're hoping that you guys have a spring competition. I believe we had 15 students that participated this past weekend, we have 15 that would love to do it again, and we didn't win anything. I think we were scoring 5 points, two points, minus one. They weren't dismayed. They weren't thrilled with their score, but they were excited, they want to come back. The advice I would give is to invite other schools to send a representative or send video of the competition to other schools in the spring, and get them decide whether they want to sign up for the fall. I would not suggest that you walk in knowing as little as we knew.

Mr. Ricardi: Dealing with the city and purchase orders is not simple. We had our robots in time, that wasn't the problem. We didn't do anything with them because I didn't know what to do with them. I didn't know what to expect, and I really didn't even know what to expect until last Sunday [at the competition]. I saw the field and all, but I didn't grasp the whole thing. The only thing I would suggest is similar to what you did with the radios. If you went out and bought 10 kits, and you know you have five teams coming in, you guys have the invoices and then you give them to us. If you guys are dealing with me, or any of the Worcester schools, you're going to get your money.

I'd like to see other tournaments too. We were fortunate in that we only ended up with ten kids, but we could have those ten kids be on one team with two robots. So what I did was rotate them through, so we had the seven legal drivers, but they were driving for both teams. It didn't matter, one kid may have built this robot, but he was the driver for this one over here. With fourteen kits, each kid would've driven once for the whole match, and for a kid to sit here for six hours and only gets to drive for 45 seconds is kind of tough on a kid. We were lucky in that all my kids got to drive three times because we went on [to the finals], and we had that battle between our own guys that went three matches instead of the just two, so that was an extra one. Each one of my students go to drive three times, where as if I had brought seven kids for each team and we had been out after the first round, each kid would've driven once.

[If all students have to drive], I would like to see more than one playing field going on at once, so there are more matches.

Mr. Hankey: One thing I would suggest is that different organizations might want to structure their process differently. For example, we broke our groups into three different functions during the build and planning phase. The students seemed to really enjoy that. Some kids really enjoyed playing with the code, they were programmers, and they focused on that. Some kids that were more tactile, they had the opportunity to excel. It was our hope that the older students would be what we called “integrators”, and I expected them to be the drivers as well. We would like to see fewer drivers, but for a different reason [than Mr. Ricardi]. I would let your rules be open enough to let groups function with their own sense of creativity. I would’ve said don’t set the driving specifically, but I had guys saying “I want to be the pit crew”. If we have a mechanical problem, these are the guys who are going to be the experts. If we have a programming problem *these* are the guys who are going to do something. If we had a strategy or a logistics thing, then there would be people who be sitting there, working on that.

Mr. Ricardi: With these robot teams, you can’t have with seven kids, fourteen hands in the party. It wasn’t sophisticated to do that unless there was a longer build season and you could do more things. You mandated seven people per team, which is a lot of people for that small robot. So, for me to make mine work, I got commitments from these kids four weeks earlier, but the week leading up to it I got “oh, I can’t make it” or “we can’t go, my dad wants me to do whatever”. So now to make it work right, we need ten kids per team, and hopefully seven will show up.

Ken: So what I’m hearing is that we need to make suggestions and let the teams decide how they want to run it. We should offer a model. What do you think about the mandatory driver change period [in the middle of each match]?

Mr. Hankey: Absolutely.

Ken: Okay, lets keep that, and if you have two drivers, that's okay. Schools are different. We can provide a model what we found successful.

Alexander: Any comments on the web site?

Mr. Ricardi: It was easy to use.

Mr. Hankey: Well done.

Brad: Were they things that you wanted to do but couldn't because you didn't know how?

Mr. Donohue: A little programming section, maybe a section with-

Mr. Hankey: We structured ourselves to be specifically "these guys are on this, and those guys are on that", so segmented would be great.

Mr. Ricardi: [The project group] were a lot of help, coming up to our schools and helping us out. We really weren't that prepared for the autonomous mode, and when we came here [the morning of competition], they showed one of the kids how to program, and he jumped right in and ended up doing it three or four times that morning.

Mr. Donohue: You only change four or five times?

Mr. Ricardi: Once he put the robot backwards, so instead of going out, it went back.

Mr. Hankey: I think what I liked about these kids coming is that they did not just come and tell the kids what to do. They came, they observed. When there were questions, they gave them good directions to follow, good strategies to figure out, but they didn't tell them what to do, which is what we did not want to see. We did not want to see the

mentors – the whole process was about them learning. That’s why our fifteen were really excited, because it was theirs. Good, bad, or indifferent, it was theirs.

Alexander: Comments on the workshops?

Mr. Hankey: Everything you did at the workshops was great. Greg and I probably had different opinions, but people who get out of work at a quarter to two – I drive fifteen miles to get here – the last thing I want to do if I’m out at two o’clock is to hang till four and then do four to six.

Mr. Ricardi: Most of the high schools in the city get out at 1:45 and we get out of the building by 2:00, so we could be here at 2:30 no problem.

Alexander: Any comments on the game itself?

Mr. Hankey: I thought it was great. The one thing I wasn’t sure about is that it seemed like because you had so many teams, you had to score very quickly. It was difficult for those of us who were observing to feel like we understood how the score was calculated. When you don’t do well, if your robot works and you don’t do well, you like to sit there and say “where did I miss it? What can I do?” The whole point of the process, going back, is to close the loop. For me, it’s what I would’ve wanted to do, is have a more secure space for materials and strategies.

Mr. Ricardi: You guys had lots of ways to score, and if I had studied the rules more, I would’ve understood that.

Mr. Hankey: For me, a real big change opportunity is if we had a better understanding of how the scoring process takes place as it’s taking place. Even if there’s sheets that are filled out that say, “you have three over here” and all the categories.

Brad: Before you go, what do you think of the educational side of things? What are the kids getting out of it?

Mr. Ricardi: Problem solving. That's the big thing I try to teach my students, I'm a mechanical guy. You see what has to be done, you critical think of how to build something, and, like I said, I didn't tell them how to build it at all. They designed it, they tried it, and they redesigned and redesigned it. I never told them a thing to do, so they saw this, they came up with an idea, and they went with it. Two days before we were going to compete, Team B decided they were going to cut theirs in half, and it caused bigger problems, but they did it themselves – it was up to them. It was the complete design process.

I didn't even know any of these students before. They were all chosen out of study hall. I was lucky, I was with gifted kids. These were all bio, math, and science kids who I am not used to working with in my shop, so it was actually a treat. For my kids, they got a lot of creative learning out of it.

Mr Hankey: I teach a course in rudimentary electrical engineering to the Juniors, and when they walked away on Monday, I heard one kid say "You better listen to Mr. Hankey, because that closed-loop stuff, you really need it." It was a fun way to reinforce something, when they are saying "well, don't you know where you want to go?" I used to give them the blind man story – if you're a blind man walking down a flight of stairs, it's a lot harder than a blind man with a cane, and now I can use [the competition]. It was very interesting to hear them say that. I think during the course of the year, there will be a point or two where something else like that will happen.

We have a colleague who is showing off our robots. We have something called the Engineering Technology Academy at Doherty, and this will be featured as one of the reasons you might be interested as an incoming freshman to join this small learning community. I mean, this is not for beginners; this is not for the rank and file students. This is for people who aspire to be technocrats, as opposed to people who don't.

Appendix E: Surveys

WPI EBOT STUDENT SURVEY											
TEAM NAME: _____						GRADE: _____					
What is your overall opinion of the WPI EBOT program?											
Poor	1	2	3	4	5	6	7	8	9	10	Excellent
Comments:											
Was the WPI EBOT program a fun experience?								NO	NEUTRAL	YES	
Comments:											
Was the WPI EBOT program a good educational experience?								NO	NEUTRAL	YES	
Comments:											
Did you feel you learned mechanical skills?								NO	NEUTRAL	YES	
Comments:											
Did you feel you learned electrical skills?								NO	NEUTRAL	YES	
Comments:											
Did you feel you learned programming skills?								NO	NEUTRAL	YES	
Comments:											
Did you feel you gained teamwork skills?								NO	NEUTRAL	YES	
Comments:											
Would you participate in the WPI EBOT program again?								NO	MAYBE	YES	
Comments:											
Would you participate in other robotics program if they were offered?								NO	MAYBE	YES	
Comments:											
Do you plan to attend college?								NO	MAYBE	YES	
Comments:											
If so, what you plan to study?											
MECHANICAL ENGINEERING				ELECTRICAL/COMPTUER ENGINEERING				COMPUTER SCIENCE			
CIVIL/ENVIRONMENTAL ENG.				BIOMEDICAL ENGINEERING				PHYSICS			
CHEMISTRY				HUMANITIES/SOCIAL SCIENCES				BIOLOGY			
UNDECIDED				OTHER: _____							

1

WPI EBOT STUDENT SURVEY
TEAM NAME: WHS Bulldogs GRADE: 10

What is your overall opinion of the WPI EBOT program?
Poor 1 2 3 4 5 6 7 8 9 10 Excellent
Comments:

Was the WPI EBOT program a fun experience? NO NEUTRAL YES
Comments:

Was the WPI EBOT program a good educational experience? NO NEUTRAL YES
Comments:

Did you feel you learned mechanical skills? NO NEUTRAL YES
Comments:

Did you feel you learned electrical skills? NO NEUTRAL YES
Comments:

Did you feel you learned programming skills? NO NEUTRAL YES
Comments:

Did you feel you gained teamwork skills? NO NEUTRAL YES
Comments:

Would you participate in the WPI EBOT program again? NO MAYBE YES
Comments:

Would you participate in other robotics program if they were offered? NO MAYBE YES
Comments:

Do you plan to attend college? NO MAYBE YES
Comments:

If so, what you plan to study?
MECHANICAL ENGINEERING ELECTRICAL/COMPTUER ENGINEERING COMPUTER SCIENCE
CIVIL/ENVIRONMENTAL ENG. BIOMEDICAL ENGINEERING PHYSICS
CHEMISTRY HUMANITIES/SOCIAL SCIENCES BIOLOGY
UNDECIDED OTHER: Filmmaking

2

WPI EBOT STUDENT SURVEY

TEAM NAME: WHS GRADE: 112

What is your overall opinion of the WPI EBOT program?

Poor 1 2 3 4 5 6 7 8 9 10 Excellent

Comments:

Was the WPI EBOT program a fun experience?

NO NEUTRAL YES

Comments:

Was the WPI EBOT program a good educational experience?

NO NEUTRAL YES

Comments:

Did you feel you learned mechanical skills?

NO NEUTRAL YES

Comments:

Did you feel you learned electrical skills?

NO NEUTRAL YES

Comments:

Did you feel you learned programming skills?

NO NEUTRAL YES

Comments:

Did you feel you gained teamwork skills?

NO NEUTRAL YES

Comments:

Would you participate in the WPI EBOT program again?

NO MAYBE YES

Comments:

Would you participate in other robotics program if they were offered?

NO MAYBE YES

Comments:

Do you plan to attend college?

NO MAYBE YES

Comments:

If so, what you plan to study?

MECHANICAL ENGINEERING
CIVIL/ENVIRONMENTAL ENG.
CHEMISTRY
UNDECIDED

ELECTRICAL/COMPTUER ENGINEERING
BIOMEDICAL ENGINEERING
HUMANITIES/SOCIAL SCIENCES
OTHER: Act

COMPUTER SCIENCE
PHYSICS
BIOLOGY

3

WPI EBOT STUDENT SURVEY
TEAM NAME: WHS GRADE: 10

What is your overall opinion of the WPI EBOT program?
Poor 1 2 3 4 5 6 7 8 9 10 Excellent
Comments:

Was the WPI EBOT program a fun experience? NO NEUTRAL YES
Comments:

Was the WPI EBOT program a good educational experience? NO NEUTRAL YES
Comments:

Did you feel you learned mechanical skills? NO NEUTRAL YES
Comments:

Did you feel you learned electrical skills? NO NEUTRAL YES
Comments:

Did you feel you learned programming skills? NO NEUTRAL YES
Comments:

Did you feel you gained teamwork skills? NO NEUTRAL YES
Comments:

Would you participate in the WPI EBOT program again? NO MAYBE YES
Comments:

Would you participate in other robotics program if they were offered? NO MAYBE YES
Comments:

Do you plan to attend college? NO MAYBE YES
Comments:

If so, what you plan to study?
MECHANICAL ENGINEERING ELECTRICAL/COMPTUER ENGINEERING COMPUTER SCIENCE
CIVIL/ENVIRONMENTAL ENG. BIOMEDICAL ENGINEERING PHYSICS
CHEMISTRY HUMANITIES/SOCIAL SCIENCES BIOLOGY
UNDECIDED OTHER: _____

1

WPI EBOT STUDENT SURVEY

TEAM NAME: Bulldogs GRADE: A

What is your overall opinion of the WPI EBOT program?

Poor 1 2 3 4 5 6 7 8 9 10 Excellent

Comments:

Was the WPI EBOT program a fun experience?

NO NEUTRAL YES

Comments:

Was the WPI EBOT program a good educational experience?

NO NEUTRAL YES

Comments:

Did you feel you learned mechanical skills?

NO NEUTRAL YES

Comments:

Did you feel you learned electrical skills?

NO NEUTRAL YES

Comments:

Did you feel you learned programming skills?

NO NEUTRAL YES

Comments:

Did you feel you gained teamwork skills?

NO NEUTRAL YES

Comments:

Would you participate in the WPI EBOT program again?

NO MAYBE YES

Comments:

Would you participate in other robotics program if they were offered?

NO MAYBE YES

Comments:

Do you plan to attend college?

NO MAYBE YES

Comments:

If so, what you plan to study?

- MECHANICAL ENGINEERING
- CIVIL/ENVIRONMENTAL ENG.
- CHEMISTRY
- UNDECIDED

- ELECTRICAL/COMPTUER ENGINEERING
- BIOMEDICAL ENGINEERING
- HUMANITIES/SOCIAL SCIENCES
- OTHER: _____

- COMPUTER SCIENCE
- PHYSICS
- BIOLOGY

3

WPI EBOT STUDENT SURVEY

TEAM NAME: WHS Bulldogs GRADE: 10

What is your overall opinion of the WPI EBOT program?

Poor 1 2 3 4 5 6 7 8 9 10 Excellent

Comments:

Was the WPI EBOT program a fun experience?

NO NEUTRAL YES

Comments:

Was the WPI EBOT program a good educational experience?

NO NEUTRAL YES

Comments:

Did you feel you learned mechanical skills?

NO NEUTRAL YES

Comments:

Did you feel you learned electrical skills?

NO ~~NEUTRAL~~ YES

Comments:

Did you feel you learned programming skills?

NO NEUTRAL YES

Comments:

Did you feel you gained teamwork skills?

NO NEUTRAL YES

Comments:

Would you participate in the WPI EBOT program again?

NO MAYBE YES

Comments:

Would you participate in other robotics program if they were offered?

NO ~~MAYBE~~ YES

Comments:

Do you plan to attend college?

NO MAYBE YES

Comments:

If so, what you plan to study?

MECHANICAL ENGINEERING
CIVIL/ENVIRONMENTAL ENG.
CHEMISTRY
UNDECIDED

ELECTRICAL/COMPTUER ENGINEERING
BIOMEDICAL ENGINEERING
HUMANITIES/SOCIAL SCIENCES
OTHER: Graphic Design

COMPUTER SCIENCE
PHYSICS
BIOLOGY

6

WPI EBOT STUDENT SURVEY

TEAM NAME: WHS Bulldogs GRADE: 11

What is your overall opinion of the WPI EBOT program?

Poor 1 2 3 4 5 6 7 8 9 10 Excellent

Comments:

Was the WPI EBOT program a fun experience?
Comments:

NO NEUTRAL YES

Was the WPI EBOT program a good educational experience?
Comments:

NO NEUTRAL YES

Did you feel you learned mechanical skills?
Comments:

NO NEUTRAL YES

Did you feel you learned electrical skills?
Comments:

NO NEUTRAL YES

Did you feel you learned programming skills?
Comments:

NO NEUTRAL YES

Did you feel you gained teamwork skills?
Comments:

NO NEUTRAL YES

Would you participate in the WPI EBOT program again?
Comments:

NO MAYBE YES

Would you participate in other robotics program if they were offered?
Comments:

NO MAYBE YES

Do you plan to attend college?
Comments:

NO MAYBE YES

If so, what you plan to study?

- MECHANICAL ENGINEERING
- CIVIL/ENVIRONMENTAL ENG.
- CHEMISTRY
- UNDECIDED

- ELECTRICAL/COMPTUER ENGINEERING
- BIOMEDICAL ENGINEERING
- HUMANITIES/SOCIAL SCIENCES
- OTHER: _____

- COMPUTER SCIENCE
- PHYSICS
- BIOLOGY

7

WPI EBOT STUDENT SURVEY

TEAM NAME: WHS Bulldogs GRADE: _____

What is your overall opinion of the WPI EBOT program?

Poor 1 2 3 4 5 6 7 8 9 10 Excellent

Comments:

Was the WPI EBOT program a fun experience?

NO NEUTRAL YES

Comments:

Was the WPI EBOT program a good educational experience?

NO NEUTRAL YES

Comments:

Did you feel you learned mechanical skills?

NO NEUTRAL YES

Comments:

Did you feel you learned electrical skills?

NO NEUTRAL YES

Comments:

Did you feel you learned programming skills?

NO NEUTRAL YES

Comments:

Did you feel you gained teamwork skills?

NO NEUTRAL YES

Comments:

Would you participate in the WPI EBOT program again?

NO MAYBE YES

Comments:

Would you participate in other robotics program if they were offered?

NO MAYBE YES

Comments:

Do you plan to attend college?

NO MAYBE YES

Comments:

If so, what you plan to study?

MECHANICAL ENGINEERING

CIVIL/ENVIRONMENTAL ENG.

CHEMISTRY

UNDECIDED

ELECTRICAL/COMPTUER ENGINEERING

BIOMEDICAL ENGINEERING

HUMANITIES/SOCIAL SCIENCES

OTHER: _____

COMPUTER SCIENCE

PHYSICS

BIOLOGY

6

WPI EBOT STUDENT SURVEY
TEAM NAME: WHS Bulldogs GRADE: 11

What is your overall opinion of the WPI EBOT program?
Poor 1 2 3 4 5 6 7 8 9 10 Excellent
Comments:

Was the WPI EBOT program a fun experience? NO NEUTRAL YES
Comments: Robot difficulties

Was the WPI EBOT program a good educational experience? NO NEUTRAL YES
Comments: learning experience

Did you feel you learned mechanical skills? NO NEUTRAL YES
Comments:

Did you feel you learned electrical skills? NO NEUTRAL YES
Comments:

Did you feel you learned programming skills? NO NEUTRAL YES
Comments:

Did you feel you gained teamwork skills? NO NEUTRAL YES
Comments:

Would you participate in the WPI EBOT program again? NO MAYBE YES
Comments:

Would you participate in other robotics program if they were offered? NO MAYBE YES
Comments:

Do you plan to attend college? NO MAYBE YES
Comments:

If so, what you plan to study?
 MECHANICAL ENGINEERING
 CIVIL/ENVIRONMENTAL ENG.
 CHEMISTRY
 UNDECIDED
ELECTRICAL/COMPTUER ENGINEERING
BIOMEDICAL ENGINEERING
HUMANITIES/SOCIAL SCIENCES
OTHER: Architecture
COMPUTER SCIENCE
PHYSICS
BIOLOGY

9

WPI EBOT STUDENT SURVEY

TEAM NAME: WHS Bulldogs GRADE: 4

What is your overall opinion of the WPI EBOT program?

Poor 1 2 3 4 5 6 7 8 9 10 Excellent

Comments:

Was the WPI EBOT program a fun experience?

NO NEUTRAL YES

Comments:

Was the WPI EBOT program a good educational experience?

NO NEUTRAL YES

Comments:

Did you feel you learned mechanical skills?

NO NEUTRAL YES

Comments:

Did you feel you learned electrical skills?

NO NEUTRAL YES

Comments:

Did you feel you learned programming skills?

NO NEUTRAL YES

Comments:

Did you feel you gained teamwork skills?

NO NEUTRAL YES

Comments:

Would you participate in the WPI EBOT program again?

NO MAYBE YES

Comments:

Would you participate in other robotics program if they were offered?

NO MAYBE YES

Comments:

Do you plan to attend college?

NO MAYBE YES

Comments:

If so, what you plan to study?

MECHANICAL ENGINEERING

CIVIL/ENVIRONMENTAL ENG.

CHEMISTRY

UNDECIDED

ELECTRICAL/COMPTUER ENGINEERING

BIOMEDICAL ENGINEERING

HUMANITIES/SOCIAL SCIENCES

OTHER: _____

COMPUTER SCIENCE

PHYSICS

BIOLOGY

10

WPI EBOT STUDENT SURVEY

TEAM NAME: WHS Bulldogs GRADE: 10

What is your overall opinion of the WPI EBOT program?

Poor 1 2 3 4 5 6 7 8 9 10 Excellent

Comments:

Was the WPI EBOT program a fun experience?
Comments:

NO NEUTRAL YES

Was the WPI EBOT program a good educational experience?
Comments:

NO NEUTRAL YES

Did you feel you learned mechanical skills?
Comments:

NO NEUTRAL YES

Did you feel you learned electrical skills?
Comments:

NO NEUTRAL YES

Did you feel you learned programming skills?
Comments:

NO NEUTRAL YES

Did you feel you gained teamwork skills?
Comments:

NO NEUTRAL YES

Would you participate in the WPI EBOT program again?
Comments:

NO MAYBE YES

Would you participate in other robotics skills program if they were offered?
Comments:

NO MAYBE YES

Do you plan to attend college?
Comments:

NO MAYBE YES

If so, what you plan to study?

- MECHANICAL ENGINEERING
- CIVIL/ENVIRONMENTAL ENG.
- CHEMISTRY
- UNDECIDED

- ELECTRICAL/COMPTUER ENGINEERING
- BIOMEDICAL ENGINEERING
- HUMANITIES/SOCIAL SCIENCES
- OTHER: _____

- COMPUTER SCIENCE
- PHYSICS
- BIOLOGY

WPI EBOT STUDENT SURVEY

(10)

TEAM NAME: Westerly Bulldogs GRADE: Advisor

What is your overall opinion of the WPI EBOT program?
 Poor 1 2 3 4 5 6 7 8 9 10 Excellent
 Comments:

Was the WPI EBOT program a fun experience? NO NEUTRAL YES
 Comments:

Was the WPI EBOT program a good educational experience? NO NEUTRAL YES
 Comments:

Did you feel you learned mechanical skills? NO NEUTRAL YES
 Comments:

Did you feel you learned electrical skills? NO NEUTRAL YES
 Comments:

Did you feel you learned programming skills? NO NEUTRAL YES
 Comments:

Did you feel you gained teamwork skills? NO NEUTRAL YES
 Comments: *absolutely*

Would you participate in the WPI EBOT program again? NO MAYBE YES
 Comments:

Would you participate in other robotics program if they were offered? NO MAYBE YES
 Comments:

Do you plan to attend college? NO MAYBE YES
 Comments:

This is a great program!

- If so, what you plan to study?
- | | | |
|--------------------------|---------------------------------|------------------|
| MECHANICAL ENGINEERING | ELECTRICAL/COMPTUER ENGINEERING | COMPUTER SCIENCE |
| CIVIL/ENVIRONMENTAL ENG. | BIOMEDICAL ENGINEERING | PHYSICS |
| CHEMISTRY | HUMANITIES/SOCIAL SCIENCES | BIOLOGY |
| UNDECIDED | OTHER: _____ | |

12

WPI EBOT STUDENT SURVEY
TEAM NAME: Weston GRADE: 12

What is your overall opinion of the WPI EBOT program?
Poor 1 2 3 4 5 6 7 8 9 10 Excellent
Comments:

Was the WPI EBOT program a fun experience? NO NEUTRAL YES
Comments:

Was the WPI EBOT program a good educational experience? NO NEUTRAL YES
Comments:

Did you feel you learned mechanical skills? NO NEUTRAL YES
Comments:

Did you feel you learned electrical skills? NO NEUTRAL YES
Comments:

Did you feel you learned programming skills? NO NEUTRAL YES
Comments:

Did you feel you gained teamwork skills? NO NEUTRAL YES
Comments:

Would you participate in the WPI EBOT program again? NO MAYBE YES
Comments:

Would you participate in other robotics program if they were offered? NO MAYBE YES
Comments:

Do you plan to attend college? NO MAYBE YES
Comments:

If so, what you plan to study?
MECHANICAL ENGINEERING ELECTRICAL/COMPTUER ENGINEERING COMPUTER SCIENCE
CIVIL/ENVIRONMENTAL ENG. BIOMEDICAL ENGINEERING PHYSICS
CHEMISTRY HUMANITIES/SOCIAL SCIENCES BIOLOGY
UNDECIDED OTHER: aerospace engineering

13

TEAM NAME: WPIteriky WPI EBOT STUDENT SURVEY GRADE: 12

What is your overall opinion of the WPI EBOT program?
Poor 1 2 3 4 5 6 7 8 9 10 Excellent

Comments: Autonomous Receiver Issues...

Was the WPI EBOT program a fun experience? NO NEUTRAL YES
Comments: YES

Was the WPI EBOT program a good educational experience? NO NEUTRAL YES
Comments: YES

Did you feel you learned mechanical skills? NO NEUTRAL YES
Comments: YES

Did you feel you learned electrical skills? NO NEUTRAL YES
Comments: YES

Did you feel you learned programming skills? NO NEUTRAL YES
Comments: NEUTRAL

Did you feel you gained teamwork skills? NO NEUTRAL YES
Comments: NEUTRAL

Would you participate in the WPI EBOT program again? NO MAYBE YES
Comments: YES

Would you participate in other robotics program if they were offered? NO MAYBE YES
Comments: YES

Do you plan to attend college? NO MAYBE YES
Comments: YES

If so, what you plan to study?
~~MECHANICAL ENGINEERING~~ ELECTRICAL/COMPTUER ENGINEERING COMPUTER SCIENCE
~~CIVIL/ENVIRONMENTAL ENG.~~ BIOMEDICAL ENGINEERING PHYSICS
CHEMISTRY HUMANITIES/SOCIAL SCIENCES BIOLOGY
UNDECIDED OTHER: _____

14

WPI EBOT STUDENT SURVEY

TEAM NAME: Wesley GRADE: 10

What is your overall opinion of the WPI EBOT program?

Poor 1 2 3 4 5 6 7 8 9 10 Excellent

Comments:

Was the WPI EBOT program a fun experience?
Comments:

NO NEUTRAL YES

Was the WPI EBOT program a good educational experience?
Comments:

NO NEUTRAL YES

Did you feel you learned mechanical skills?
Comments:

NO NEUTRAL YES

Did you feel you learned electrical skills?
Comments:

NO NEUTRAL YES

Did you feel you learned programming skills?
Comments:

NO NEUTRAL YES

Did you feel you gained teamwork skills?
Comments:

NO NEUTRAL YES

Would you participate in the WPI EBOT program again?
Comments:

NO MAYBE YES

Would you participate in other robotics program if they were offered?
Comments:

NO MAYBE YES

Do you plan to attend college?
Comments:

NO MAYBE YES

If so, what you plan to study?

MECHANICAL ENGINEERING
CIVIL/ENVIRONMENTAL ENG.
CHEMISTRY
UNDECIDED

ELECTRICAL/COMPTUER ENGINEERING
BIOMEDICAL ENGINEERING
HUMANITIES/SOCIAL SCIENCES
OTHER _____

COMPUTER SCIENCE
PHYSICS
BIOLOGY

13

WPI EBOT STUDENT SURVEY

TEAM NAME: WHS Bulldogs GRADE: 11

What is your overall opinion of the WPI EBOT program?

Poor 1 2 3 4 5 6 7 8 9 10 Excellent

Comments:

Was the WPI EBOT program a fun experience?

NO NEUTRAL YES

Comments:

Was the WPI EBOT program a good educational experience?

NO NEUTRAL YES

Comments:

Did you feel you learned mechanical skills?

NO NEUTRAL YES

Comments:

Did you feel you learned electrical skills?

NO NEUTRAL YES

Comments:

Did you feel you learned programming skills?

NO NEUTRAL YES

Comments:

Did you feel you gained teamwork skills?

NO NEUTRAL YES

Comments:

Would you participate in the WPI EBOT program again?

NO MAYBE YES

Comments:

Would you participate in other robotics program if they were offered?

NO MAYBE YES

Comments:

Do you plan to attend college?

NO MAYBE YES

Comments:

If so, what you plan to study?

MECHANICAL ENGINEERING

CIVIL/ENVIRONMENTAL ENG.

CHEMISTRY

UNDECIDED

ELECTRICAL/COMPTUER ENGINEERING

BIOMEDICAL ENGINEERING

HUMANITIES/SOCIAL SCIENCES

OTHER: _____

COMPUTER SCIENCE

PHYSICS

BIOLOGY

16

WPI EBOT STUDENT SURVEY

TEAM NAME: WHS Bulldogs GRADE: 11

What is your overall opinion of the WPI EBOT program?

Poor 1 2 3 4 5 6 7 8 9 10 Excellent

Comments:

Was the WPI EBOT program a fun experience?

NO NEUTRAL YES

Comments:

Was the WPI EBOT program a good educational experience?

NO NEUTRAL YES

Comments:

Did you feel you learned mechanical skills?

NO NEUTRAL YES

Comments:

Did you feel you learned electrical skills?

NO NEUTRAL YES

Comments:

Did you feel you learned programming skills?

NO NEUTRAL YES

Comments:

Did you feel you gained teamwork skills?

NO NEUTRAL YES

Comments:

Would you participate in the WPI EBOT program again?

NO MAYBE YES

Comments:

Would you participate in other robotics program if they were offered?

NO MAYBE YES

Comments:

Do you plan to attend college?

NO MAYBE YES

Comments:

If so, what you plan to study?

- MECHANICAL ENGINEERING
- CIVIL/ENVIRONMENTAL ENG.
- CHEMISTRY
- UNDECIDED

- ELECTRICAL/COMPTUER ENGINEERING
- BIOMEDICAL ENGINEERING
- HUMANITIES/SOCIAL SCIENCES
- OTHER: _____

- COMPUTER SCIENCE
- PHYSICS
- BIOLOGY

1

WPI EBOT STUDENT SURVEY

TEAM NAME: Insect Name Here GRADE: 9

What is your overall opinion of the WPI EBOT program?

Poor 1 2 3 4 5 6 7 8 9 10 Excellent

Comments:

Was the WPI EBOT program a fun experience?

NO NEUTRAL YES

Comments:

Was the WPI EBOT program a good educational experience?

NO NEUTRAL YES

Comments:

Did you feel you learned mechanical skills?

NO NEUTRAL YES

Comments:

Did you feel you learned electrical skills?

NO NEUTRAL YES

Comments:

Did you feel you learned programming skills?

NO NEUTRAL YES

Comments:

Did you feel you gained teamwork skills?

NO NEUTRAL YES

Comments:

Would you participate in the WPI EBOT program again?

NO MAYBE YES

Comments:

Would you participate in other robotics program if they were offered?

NO MAYBE YES

Comments:

Do you plan to attend college?

NO MAYBE YES

Comments:

If so, what you plan to study?

MECHANICAL ENGINEERING

CIVIL/ENVIRONMENTAL ENG.

CHEMISTRY

UNDECIDED

ELECTRICAL/COMPTUER ENGINEERING

BIOMEDICAL ENGINEERING

HUMANITIES/SOCIAL SCIENCES

OTHER: _____

COMPUTER SCIENCE

PHYSICS

BIOLOGY

2

WPI EBOT STUDENT SURVEY
TEAM NAME: Insect Army Here GRADE: 10

What is your overall opinion of the WPI EBOT program?
Poor 1 2 3 4 5 6 7 8 9 10 Excellent
Comments:

Was the WPI EBOT program a fun experience? NO NEUTRAL YES
Comments:

Was the WPI EBOT program a good educational experience? NO NEUTRAL YES
Comments:

Did you feel you learned mechanical skills? NO NEUTRAL YES
Comments:

Did you feel you learned electrical skills? NO NEUTRAL YES
Comments:

Did you feel you learned programming skills? NO NEUTRAL YES
Comments:

Did you feel you gained teamwork skills? NO NEUTRAL YES
Comments:

Would you participate in the WPI EBOT program again? NO MAYBE YES
Comments:

Would you participate in other robotics program if they were offered? NO MAYBE YES
Comments:

Do you plan to attend college? NO MAYBE YES
Comments:

If so, what you plan to study?
MECHANICAL ENGINEERING ELECTRICAL/COMPTUER ENGINEERING COMPUTER SCIENCE
CIVIL/ENVIRONMENTAL ENG. BIOMEDICAL ENGINEERING PHYSICS
CHEMISTRY HUMANITIES/SOCIAL SCIENCES BIOLOGY
UNDECIDED OTHER: Japanese Studies

3

WPI EBOT STUDENT SURVEY

TEAM NAME: David Nam GRADE: cd

What is your overall opinion of the WPI EBOT program?
Poor 1 2 3 4 5 6 7 8 9 10 Excellent
Comments:

Was the WPI EBOT program a fun experience? NO NEUTRAL YES
Comments:

Was the WPI EBOT program a good educational experience? NO NEUTRAL YES
Comments:

Did you feel you learned mechanical skills? NO NEUTRAL YES
Comments:

Did you feel you learned electrical skills? NO NEUTRAL YES
Comments:

Did you feel you learned programming skills? NO NEUTRAL YES
Comments:

Did you feel you gained teamwork skills? NO NEUTRAL YES
Comments:

Would you participate in the WPI EBOT program again? NO MAYBE YES
Comments:

Would you participate in other robotics program if they were offered?
Comments: NO MAYBE YES

Do you plan to attend college? NO MAYBE YES
Comments:

If so, what you plan to study?
MECHANICAL ENGINEERING ELECTRICAL/COMPTUER ENGINEERING COMPUTER SCIENCE
CIVIL/ENVIRONMENTAL ENG. BIOMEDICAL ENGINEERING PHYSICS
CHEMISTRY HUMANITIES/SOCIAL SCIENCES BIOLOGY
UNDECIDED OTHER: business

4

WPI EBOT STUDENT SURVEY
TEAM NAME: Inferf Name here GRADE: 10

What is your overall opinion of the WPI EBOT program?
Poor 1 2 3 4 5 6 7 8 9 10 Excellent
Comments:

Was the WPI EBOT program a fun experience?
Comments: NO NEUTRAL YES

Was the WPI EBOT program a good educational experience?
Comments: NO NEUTRAL YES

Did you feel you learned mechanical skills?
Comments: NO NEUTRAL YES

Did you feel you learned electrical skills?
Comments: NO NEUTRAL YES

Did you feel you learned programming skills?
Comments: NO NEUTRAL YES

Did you feel you gained teamwork skills?
Comments: NO NEUTRAL YES

Would you participate in the WPI EBOT program again?
Comments: NO MAYBE YES

Would you participate in other robotics program if they were offered?
Comments: NO MAYBE YES

Do you plan to attend college?
Comments: NO MAYBE YES

If so, what you plan to study?
MECHANICAL ENGINEERING
CIVIL/ENVIRONMENTAL ENG.
CHEMISTRY
UNDECIDED
ELECTRICAL/COMPTUER ENGINEERING
BIOMEDICAL ENGINEERING
HUMANITIES/SOCIAL SCIENCES
OTHER: nuclear science
COMPUTER SCIENCE
PHYSICS
BIOLOGY

5

WPI EBOT STUDENT SURVEY

TEAM NAME: Insert name here GRADE: 10

What is your overall opinion of the WPI EBOT program?

Poor 1 2 3 4 5 6 7 8 9 10 Excellent

Comments:

Was the WPI EBOT program a fun experience?

NO NEUTRAL YES

Comments:

Was the WPI EBOT program a good educational experience?

NO NEUTRAL YES

Comments:

Did you feel you learned mechanical skills?

NO NEUTRAL YES

Comments:

Did you feel you learned electrical skills?

NO NEUTRAL YES

Comments:

Did you feel you learned programming skills?

NO NEUTRAL YES

Comments:

Did you feel you gained teamwork skills?

NO NEUTRAL YES

Comments:

Would you participate in the WPI EBOT program again?

NO MAYBE YES

Comments:

Would you participate in other robotics program if they were offered?

NO MAYBE YES

Comments:

Do you plan to attend college?

NO MAYBE YES

Comments:

If so, what you plan to study?

MECHANICAL ENGINEERING
CIVIL/ENVIRONMENTAL ENG.
CHEMISTRY
UNDECIDED

ELECTRICAL/COMPTUER ENGINEERING
BIOMEDICAL ENGINEERING
HUMANITIES/SOCIAL SCIENCES
OTHER: _____

COMPUTER SCIENCE
PHYSICS
BIOLOGY

6

WPI EBOT STUDENT SURVEY

TEAM NAME: John Waters GRADE: 09

What is your overall opinion of the WPI EBOT program?
Poor 1 2 3 4 5 6 7 8 9 10 Excellent
Comments:

Was the WPI EBOT program a fun experience? NO NEUTRAL YES
Comments:

Was the WPI EBOT program a good educational experience? NO NEUTRAL YES
Comments:

Did you feel you learned mechanical skills? NO NEUTRAL YES
Comments:

Did you feel you learned electrical skills? NO NEUTRAL YES
Comments:

Did you feel you learned programming skills? NO NEUTRAL YES
Comments:

Did you feel you gained teamwork skills? NO NEUTRAL YES
Comments:

Would you participate in the WPI EBOT program again? NO MAYBE YES
Comments:

Would you participate in other robotics program if they were offered? NO MAYBE YES
Comments:

Do you plan to attend college? NO MAYBE YES
Comments:

If so, what you plan to study?
MECHANICAL ENGINEERING ELECTRICAL/COMPTUER ENGINEERING COMPUTER SCIENCE
CIVIL/ENVIRONMENTAL ENG. BIOMEDICAL ENGINEERING PHYSICS
CHEMISTRY HUMANITIES/SOCIAL SCIENCES BIOLOGY
UNDECIDED OTHER: _____

7

WPI EBOT STUDENT SURVEY

TEAM NAME: Insert Name Here GRADE: 9

What is your overall opinion of the WPI EBOT program?

Poor 1 2 3 4 5 6 7 8 9 10 Excellent

Comments:

Was the WPI EBOT program a fun experience?

NO NEUTRAL YES

Comments:

Was the WPI EBOT program a good educational experience?

NO NEUTRAL YES

Comments:

Did you feel you learned mechanical skills?

NO NEUTRAL YES

Comments:

Did you feel you learned electrical skills?

NO NEUTRAL YES

Comments:

Did you feel you learned programming skills?

NO NEUTRAL YES

Comments:

Did you feel you gained teamwork skills?

NO NEUTRAL YES

Comments:

Would you participate in the WPI EBOT program again?

NO MAYBE YES

Comments:

Would you participate in other robotics program if they were offered?

NO MAYBE YES

Comments:

Do you plan to attend college?

NO MAYBE YES

Comments:

If so, what you plan to study?

MECHANICAL ENGINEERING
CIVIL/ENVIRONMENTAL ENG.
CHEMISTRY
UNDECIDED

ELECTRICAL/COMPTUER ENGINEERING
BIOMEDICAL ENGINEERING
HUMANITIES/SOCIAL SCIENCES
OTHER: _____

COMPUTER SCIENCE
PHYSICS
BIOLOGY

WPI EBOT STUDENT SURVEY

1

TEAM NAME: 2 bit GRADE: 11

What is your overall opinion of the WPI EBOT program?

Poor 1 2 3 4 5 6 7 8 9 10 Excellent

Comments:

Was the WPI EBOT program a fun experience?

NO NEUTRAL YES

Comments:

Was the WPI EBOT program a good educational experience?

NO NEUTRAL YES

Comments:

Did you feel you learned mechanical skills?

NO NEUTRAL YES

Comments:

Did you feel you learned electrical skills?

NO NEUTRAL YES

Comments:

Did you feel you learned programming skills?

NO NEUTRAL YES

Comments:

Did you feel you gained teamwork skills?

NO NEUTRAL YES

Comments:

Would you participate in the WPI EBOT program again?

NO MAYBE YES

Comments:

Would you participate in other robotics program if they were offered?

NO MAYBE YES

Comments:

Do you plan to attend college?

NO MAYBE YES

Comments:

If so, what you plan to study?

MECHANICAL ENGINEERING

CIVIL/ENVIRONMENTAL ENG.

CHEMISTRY

UNDECIDED

ELECTRICAL/COMPTUER ENGINEERING

BIOMEDICAL ENGINEERING

HUMANITIES/SOCIAL SCIENCES

OTHER: _____

COMPUTER SCIENCE

PHYSICS

BIOLOGY

2

TEAM NAME: 2 Bit WPI EBOT STUDENT SURVEY GRADE: 11

What is your overall opinion of the WPI EBOT program?
Poor 1 2 3 4 5 6 7 8 9 10 Excellent
Comments:

Was the WPI EBOT program a fun experience? NO NEUTRAL YES
Comments:

Was the WPI EBOT program a good educational experience? NO NEUTRAL YES
Comments:

Did you feel you learned mechanical skills? NO NEUTRAL YES
Comments:

Did you feel you learned electrical skills? NO NEUTRAL YES
Comments:

Did you feel you learned programming skills? NO NEUTRAL YES
Comments:

Did you feel you gained teamwork skills? NO NEUTRAL YES
Comments:

Would you participate in the WPI EBOT program again? NO MAYBE YES
Comments:

Would you participate in other robotics program if they were offered? NO MAYBE YES
Comments:

Do you plan to attend college? NO MAYBE YES
Comments:

If so, what you plan to study?
MECHANICAL ENGINEERING ELECTRICAL/COMPTUER ENGINEERING COMPUTER SCIENCE
CIVIL/ENVIRONMENTAL ENG. BIOMEDICAL ENGINEERING PHYSICS
CHEMISTRY HUMANITIES/SOCIAL SCIENCES BIOLOGY
UNDECIDED OTHER: _____

3

WPI EBOT STUDENT SURVEY
TEAM NAME: J-BIT GRADE: 11

What is your overall opinion of the WPI EBOT program?
Poor 1 2 3 4 5 6 7 8 9 10 Excellent
Comments:

Was the WPI EBOT program a fun experience? NO NEUTRAL YES
Comments:

Was the WPI EBOT program a good educational experience? NO NEUTRAL YES
Comments:

Did you feel you learned mechanical skills? NO NEUTRAL YES
Comments:

Did you feel you learned electrical skills? NO NEUTRAL YES
Comments:

Did you feel you learned programming skills? NO NEUTRAL YES
Comments:

Did you feel you gained teamwork skills? NO NEUTRAL YES
Comments:

Would you participate in the WPI EBOT program again? NO MAYBE YES
Comments:

Would you participate in other robotics program if they were offered? NO MAYBE YES
Comments:

Do you plan to attend college? NO MAYBE YES
Comments:

If so, what you plan to study?
MECHANICAL ENGINEERING ELECTRICAL/COMPTUER ENGINEERING COMPUTER SCIENCE
CIVIL/ENVIRONMENTAL ENG. BIOMEDICAL ENGINEERING PHYSICS
CHEMISTRY HUMANITIES/SOCIAL SCIENCES BIOLOGY
UNDECIDED OTHER: _____

2

WPI EBOT STUDENT SURVEY

TEAM NAME: 2 Bit GRADE: 11

What is your overall opinion of the WPI EBOT program?

Poor 1 2 3 4 5 6 7 8 9 10 Excellent

Comments:

Was the WPI EBOT program a fun experience?

NO NEUTRAL YES

Comments:

Was the WPI EBOT program a good educational experience?

NO NEUTRAL YES

Comments:

Did you feel you learned mechanical skills?

NO NEUTRAL YES

Comments:

Did you feel you learned electrical skills?

NO NEUTRAL YES

Comments:

Did you feel you learned programming skills?

NO NEUTRAL YES

Comments:

Did you feel you gained teamwork skills?

NO NEUTRAL YES

Comments:

Would you participate in the WPI EBOT program again?

NO MAYBE YES

Comments:

Would you participate in other robotics program if they were offered?

NO MAYBE YES

Comments:

Do you plan to attend college?

NO MAYBE YES

Comments:

If so, what you plan to study?

- MECHANICAL ENGINEERING
- CIVIL/ENVIRONMENTAL ENG.
- CHEMISTRY
- UNDECIDED

- ELECTRICAL/COMPUTER ENGINEERING
- BIOMEDICAL ENGINEERING
- HUMANITIES/SOCIAL SCIENCES
- OTHER: _____

- COMPUTER SCIENCE
- PHYSICS
- BIOLOGY

Eliza Rice

TEAM NAME: Polar Bears WPI EBOT STUDENT SURVEY GRADE: 11

6

What is your overall opinion of the WPI EBOT program?
Poor 1 2 3 4 5 6 7 8 9 10 Excellent
Comments:

Was the WPI EBOT program a fun experience? NO NEUTRAL YES
Comments:

Was the WPI EBOT program a good educational experience? NO NEUTRAL YES
Comments:

Did you feel you learned mechanical skills? NO NEUTRAL YES
Comments:

Did you feel you learned electrical skills? NO NEUTRAL YES
Comments:

Did you feel you learned programming skills? NO NEUTRAL YES
Comments:

Did you feel you gained teamwork skills? NO NEUTRAL YES
Comments:

Would you participate in the WPI EBOT program again? NO MAYBE YES
Comments:

Would you participate in other robotics program if they were offered? NO MAYBE YES
Comments:

Do you plan to attend college? NO MAYBE YES
Comments:

If so, what you plan to study?
MECHANICAL ENGINEERING
CIVIL/ENVIRONMENTAL ENG.
CHEMISTRY
UNDECIDED
ELECTRICAL/COMPTUER ENGINEERING
BIOMEDICAL ENGINEERING
HUMANITIES/SOCIAL SCIENCES
OTHER:
COMPUTER SCIENCE
PHYSICS
BIOLOGY

(2)

WPI EBOT STUDENT SURVEY

TEAM NAME: Polar Bots GRADE: 10

What is your overall opinion of the WPI EBOT program?
Poor 1 2 3 4 5 6 7 8 9 10 Excellent
Comments:

Was the WPI EBOT program a fun experience? NO NEUTRAL YES
Comments:

Was the WPI EBOT program a good educational experience? NO NEUTRAL YES
Comments:

Did you feel you learned mechanical skills? NO NEUTRAL YES
Comments:

Did you feel you learned electrical skills? NO NEUTRAL YES
Comments:

Did you feel you learned programming skills? NO NEUTRAL YES
Comments:

Did you feel you gained teamwork skills? NO NEUTRAL YES
Comments:

Would you participate in the WPI EBOT program again? NO MAYBE YES
Comments:

Would you participate in other robotics program if they were offered? NO MAYBE YES
Comments:

Do you plan to attend college? NO MAYBE YES
Comments:

If so, what you plan to study?
MECHANICAL ENGINEERING ELECTRICAL/COMPTUER ENGINEERING COMPUTER SCIENCE
CIVIL/ENVIRONMENTAL ENG. BIOMEDICAL ENGINEERING PHYSICS
CHEMISTRY HUMANITIES/SOCIAL SCIENCES BIOLOGY
UNDECIDED OTHER: _____

3

WPI EBOT STUDENT SURVEY
TEAM NAME: Polar Bots GRADE: _____

What is your overall opinion of the WPI EBOT program?
Poor 1 2 3 4 5 6 7 8 9 10 Excellent
Comments:

Was the WPI EBOT program a fun experience? NO NEUTRAL YES
Comments:

Was the WPI EBOT program a good educational experience? NO NEUTRAL YES
Comments: Some team members prevented others from working on the robot.

Did you feel you learned mechanical skills? NO NEUTRAL YES
Comments: see prev. comments

Did you feel you learned electrical skills? NO NEUTRAL YES
Comments: see prev. comment

Did you feel you learned programming skills? NO NEUTRAL YES
Comments: see prev. comment I already knew pascal

Did you feel you gained teamwork skills? NO NEUTRAL YES
Comments: Already had 'em

Would you participate in the WPI EBOT program again? NO MAYBE YES
Comments: Hell ya!

Would you participate in other robotics program if they were offered? NO MAYBE YES
Comments: Probably

Do you plan to attend college? NO MAYBE YES
Comments: Yes²

If so, what you plan to study?
MECHANICAL ENGINEERING ELECTRICAL/COMPTUER ENGINEERING COMPUTER SCIENCE
CIVIL/ENVIRONMENTAL ENG. BIOMEDICAL ENGINEERING PHYSICS
CHEMISTRY HUMANITIES/SOCIAL SCIENCES BIOLOGY
UNDECIDED OTHER: Video game programming

(7)

WPI EBOT STUDENT SURVEY
TEAM NAME: COLLAR BOTS GRADE: 11

What is your overall opinion of the WPI EBOT program?
Poor 1 2 3 4 5 6 7 8 (9) 10 Excellent
Comments:

Was the WPI EBOT program a fun experience?
Comments: NO NEUTRAL YES

Was the WPI EBOT program a good educational experience?
Comments: NO NEUTRAL YES

Did you feel you learned mechanical skills?
Comments: NO NEUTRAL YES

Did you feel you learned electrical skills?
Comments: NO NEUTRAL YES

Did you feel you learned programming skills?
Comments: NO NEUTRAL YES

Did you feel you gained teamwork skills?
Comments: NO NEUTRAL YES

Would you participate in the WPI EBOT program again?
Comments: NO MAYBE YES

Would you participate in other robotics program if they were offered?
Comments: NO MAYBE YES

Do you plan to attend college?
Comments: NO MAYBE YES

If so, what you plan to study?
MECHANICAL ENGINEERING
CIVIL/ENVIRONMENTAL ENG.
CHEMISTRY
UNDECIDED

ELECTRICAL/COMPTUER ENGINEERING
BIOMEDICAL ENGINEERING
HUMANITIES/SOCIAL SCIENCES
OTHER: _____
COMPUTER SCIENCE
PHYSICS
BIOLOGY

5

WPI EBOT STUDENT SURVEY
TEAM NAME: Polar bots GRADE: 10

What is your overall opinion of the WPI EBOT program?
Poor 1 2 3 4 5 6 7 8 9 10 Excellent
Comments:

Was the WPI EBOT program a fun experience? NO NEUTRAL YES
Comments:

Was the WPI EBOT program a good educational experience? NO NEUTRAL YES
Comments:

Did you feel you learned mechanical skills? NO NEUTRAL YES
Comments:

Did you feel you learned electrical skills? NO NEUTRAL YES
Comments:

Did you feel you learned programming skills? NO NEUTRAL YES
Comments:

Did you feel you gained teamwork skills? NO NEUTRAL YES
Comments:

Would you participate in the WPI EBOT program again? NO MAYBE YES
Comments:

Would you participate in other robotics program if they were offered? NO MAYBE YES
Comments:

Do you plan to attend college? NO MAYBE YES
Comments:

If so, what you plan to study?
MECHANICAL ENGINEERING ELECTRICAL/COMPTUER ENGINEERING COMPUTER SCIENCE
CIVIL/ENVIRONMENTAL ENG. BIOMEDICAL ENGINEERING PHYSICS
CHEMISTRY HUMANITIES/SOCIAL SCIENCES BIOLQGY
UNDECIDED OTHER: Computer Programming

6

TEAM NAME: Polar Bots WPI EBOT STUDENT SURVEY GRADE: 7

What is your overall opinion of the WPI EBOT program?
Poor 1 2 3 4 5 6 7 8 9 10 Excellent
Comments:

Was the WPI EBOT program a fun experience? NO NEUTRAL YES
Comments:

Was the WPI EBOT program a good educational experience? NO NEUTRAL YES
Comments:

Did you feel you learned mechanical skills? NO NEUTRAL YES
Comments:

Did you feel you learned electrical skills? NO NEUTRAL YES
Comments:

Did you feel you learned programming skills? NO NEUTRAL YES
Comments:

Did you feel you gained teamwork skills? NO NEUTRAL YES
Comments:

Would you participate in the WPI EBOT program again? NO MAYBE YES
Comments:

Would you participate in other robotics program if they were offered? NO MAYBE YES
Comments:

Do you plan to attend college? NO MAYBE YES
Comments:

If so, what you plan to study?
MECHANICAL ENGINEERING
CIVIL/ENVIRONMENTAL ENG.
CHEMISTRY
UNDECIDED
ELECTRICAL/COMPTUER ENGINEERING
BIOMEDICAL ENGINEERING
HUMANITIES/SOCIAL SCIENCES
OTHER: _____
COMPUTER SCIENCE
PHYSICS
BIOLOGY

①

WPI EBOT STUDENT SURVEY

TEAM NAME: The Colonel GRADE: 12

What is your overall opinion of the WPI EBOT program?

Poor 1 2 3 4 5 6 7 8 9 10 Excellent

Comments: Less is more.

Was the WPI EBOT program a fun experience? NO NEUTRAL YES
Comments:

Was the WPI EBOT program a good educational experience? NO NEUTRAL YES
Comments:

Did you feel you learned mechanical skills? NO NEUTRAL YES
Comments:

Did you feel you learned electrical skills? NO NEUTRAL YES
Comments:

Did you feel you learned programming skills? NO NEUTRAL YES
Comments:

Did you feel you gained teamwork skills? NO NEUTRAL YES
Comments:

Would you participate in the WPI EBOT program again? NO MAYBE YES
Comments:

Would you participate in other robotics program if they were offered? NO MAYBE YES
Comments:

Do you plan to attend college? NO MAYBE YES
Comments:

If so, what you plan to study?

- MECHANICAL ENGINEERING
- CIVIL/ENVIRONMENTAL ENG.
- CHEMISTRY
- UNDECIDED

- ELECTRICAL/COMPTUER ENGINEERING
- BIOMEDICAL ENGINEERING
- HUMANITIES/SOCIAL SCIENCES
- OTHER: _____

- COMPUTER SCIENCE
- PHYSICS
- BIOLOGY

2

Colnos.

TEAM NAME: Colnos WPI EBOT STUDENT SURVEY GRADE: 9

What is your overall opinion of the WPI EBOT program?
Poor 1 2 3 4 5 6 7 8 9 10 Excellent
Comments:

Was the WPI EBOT program a fun experience? NO NEUTRAL YES
Comments:

Was the WPI EBOT program a good educational experience? NO NEUTRAL YES
Comments:

Did you feel you learned mechanical skills? NO NEUTRAL YES
Comments:

Did you feel you learned electrical skills? NO NEUTRAL YES
Comments:

Did you feel you learned programming skills? NO NEUTRAL YES
Comments:

Did you feel you gained teamwork skills? NO NEUTRAL YES
Comments:

Would you participate in the WPI EBOT program again? NO MAYBE YES
Comments:

Would you participate in other robotics program if they were offered? NO MAYBE YES
Comments:

Do you plan to attend college? NO MAYBE YES
Comments:

If so, what you plan to study?
MECHANICAL ENGINEERING ELECTRICAL/COMPTUER ENGINEERING COMPUTER SCIENCE
CIVIL/ENVIRONMENTAL ENG. BIOMEDICAL ENGINEERING PHYSICS
CHEMISTRY HUMANITIES/SOCIAL SCIENCES BIOLOGY
UNDECIDED OTHER: _____

3

TEAM NAME: Colonel WPI EBOT STUDENT SURVEY GRADE: 12

What is your overall opinion of the WPI EBOT program?
Poor 1 2 3 4 5 6 7 8 9 10 Excellent
Comments:

Was the WPI EBOT program a fun experience? NO NEUTRAL YES
Comments:

Was the WPI EBOT program a good educational experience? NO NEUTRAL YES
Comments:

Did you feel you learned mechanical skills? NO NEUTRAL YES
Comments:

Did you feel you learned electrical skills? NO NEUTRAL YES
Comments:

Did you feel you learned programming skills? NO NEUTRAL YES
Comments:

Did you feel you gained teamwork skills? NO NEUTRAL YES
Comments:

Would you participate in the WPI EBOT program again? NO MAYBE YES
Comments:

Would you participate in other robotics program if they were offered? NO MAYBE YES
Comments:

Do you plan to attend college? NO MAYBE YES
Comments: WPI (1st choice)

If so, what you plan to study?
MECHANICAL ENGINEERING
CIVIL/ENVIRONMENTAL ENG.
CHEMISTRY
UNDECIDED
ELECTRICAL/COMPTUER ENGINEERING
BIOMEDICAL ENGINEERING
HUMANITIES/SOCIAL SCIENCES
OTHER: _____
COMPUTER SCIENCE
PHYSICS
BIOLOGY

4

WPI EBOT STUDENT SURVEY

TEAM NAME: The Colonel GRADE: 1st

What is your overall opinion of the WPI EBOT program?

Poor 1 2 3 4 5 6 7 8 9 10 Excellent

Comments:

Was the WPI EBOT program a fun experience?

NO NEUTRAL YES

Comments:

Was the WPI EBOT program a good educational experience?

NO NEUTRAL YES

Comments:

Did you feel you learned mechanical skills?

NO NEUTRAL YES

Comments:

Did you feel you learned electrical skills?

NO NEUTRAL YES

Comments:

Did you feel you learned programming skills?

NO NEUTRAL YES

Comments:

Did you feel you gained teamwork skills?

NO NEUTRAL YES

Comments:

Would you participate in the WPI EBOT program again?

NO MAYBE YES

Comments:

Would you participate in other robotics program if they were offered?

NO MAYBE YES

Comments:

Do you plan to attend college?

NO MAYBE YES

Comments:

If so, what you plan to study?

- MECHANICAL ENGINEERING
- CIVIL/ENVIRONMENTAL ENG.
- CHEMISTRY
- UNDECIDED

- ELECTRICAL/COMPTUER ENGINEERING
- BIOMEDICAL ENGINEERING
- HUMANITIES/SOCIAL SCIENCES
- OTHER: _____

- COMPUTER SCIENCE
- PHYSICS
- BIOLOGY

5

WPI EBOT STUDENT SURVEY

TEAM NAME: The Colonel GRADE: 10

What is your overall opinion of the WPI EBOT program?

Poor 1 2 3 4 5 6 7 8 9 10 Excellent

Comments:

Was the WPI EBOT program a fun experience?

NO NEUTRAL YES

Comments:

Was the WPI EBOT program a good educational experience?

NO NEUTRAL YES

Comments:

Did you feel you learned mechanical skills?

NO NEUTRAL YES

Comments:

Did you feel you learned electrical skills?

NO NEUTRAL YES

Comments:

Did you feel you learned programming skills?

NO NEUTRAL YES

Comments:

Did you feel you gained teamwork skills?

NO NEUTRAL YES

Comments:

Would you participate in the WPI EBOT program again?

NO MAYBE YES

Comments:

Would you participate in other robotics program if they were offered?

NO MAYBE YES

Comments:

Do you plan to attend college?

NO MAYBE YES

Comments:

If so, what you plan to study?

MECHANICAL ENGINEERING
CIVIL/ENVIRONMENTAL ENG.
CHEMISTRY
UNDECIDED

ELECTRICAL/COMPTUER ENGINEERING
BIOMEDICAL ENGINEERING
HUMANITIES/SOCIAL SCIENCES
OTHER: law enforcement

COMPUTER SCIENCE
PHYSICS
BIOLOGY

1

WPI EBOT STUDENT SURVEY
TEAM NAME: North poles GRADE: 10

What is your overall opinion of the WPI EBOT program?
Poor 1 2 3 4 5 6 7 8 9 10 Excellent

Comments: it fun

Was the WPI EBOT program a fun experience? NO NEUTRAL YES
Comments:

Was the WPI EBOT program a good educational experience? NO NEUTRAL YES
Comments:

Did you feel you learned mechanical skills? NO NEUTRAL YES
Comments:

Did you feel you learned electrical skills? NO NEUTRAL YES
Comments:

Did you feel you learned programming skills? NO NEUTRAL YES
Comments:

Did you feel you gained teamwork skills? NO NEUTRAL YES
Comments:

Would you participate in the WPI EBOT program again? NO MAYBE YES
Comments:

Would you participate in other robotics program if they were offered? NO MAYBE YES
Comments:

Do you plan to attend college? NO MAYBE YES
Comments:

If so, what you plan to study?
MECHANICAL ENGINEERING ELECTRICAL/COMPTUER ENGINEERING COMPUTER SCIENCE
CIVIL/ENVIRONMENTAL ENG. BIOMEDICAL ENGINEERING PHYSICS
CHEMISTRY HUMANITIES/SOCIAL SCIENCES BIOLOGY
UNDECIDED OTHER: _____

2

WPI EBOT STUDENT SURVEY
TEAM NAME: Northbots GRADE: 4

What is your overall opinion of the WPI EBOT program?
Poor 1 2 3 4 5 6 7 8 9 10 Excellent
Comments:

Was the WPI EBOT program a fun experience? NO NEUTRAL YES
Comments:

Was the WPI EBOT program a good educational experience? NO NEUTRAL YES
Comments:

Did you feel you learned mechanical skills? NO NEUTRAL YES
Comments:

Did you feel you learned electrical skills? NO NEUTRAL YES
Comments:

Did you feel you learned programming skills? NO NEUTRAL YES
Comments:

Did you feel you gained teamwork skills? NO NEUTRAL YES
Comments:

Would you participate in the WPI EBOT program again? NO MAYBE YES
Comments:

Would you participate in other robotics program if they were offered? NO MAYBE YES
Comments:

Do you plan to attend college? NO MAYBE YES
Comments:

If so, what you plan to study?
MECHANICAL ENGINEERING ELECTRICAL/COMPTUER ENGINEERING COMPUTER SCIENCE
CIVIL/ENVIRONMENTAL ENG. BIOMEDICAL ENGINEERING PHYSICS
CHEMISTRY HUMANITIES/SOCIAL SCIENCES BIOLOGY
UNDECIDED OTHER: _____

3

WPI EBOT STUDENT SURVEY

TEAM NAME: Northbots GRADE: 9

What is your overall opinion of the WPI EBOT program?

Poor 1 2 3 4 5 6 7 8 9 10 Excellent

Comments:

Was the WPI EBOT program a fun experience?
Comments:

NO NEUTRAL YES

Was the WPI EBOT program a good educational experience?
Comments:

NO NEUTRAL YES

Did you feel you learned mechanical skills?
Comments:

NO NEUTRAL YES

Did you feel you learned electrical skills?
Comments:

NO NEUTRAL YES

Did you feel you learned programming skills?
Comments:

NO NEUTRAL YES

Did you feel you gained teamwork skills?
Comments:

NO NEUTRAL YES

Would you participate in the WPI EBOT program again?
Comments:

NO MAYBE YES

Would you participate in other robotics program if they were offered?
Comments:

NO MAYBE YES

Do you plan to attend college?
Comments:

NO MAYBE YES

If so, what you plan to study?

- MECHANICAL ENGINEERING
- CIVIL/ENVIRONMENTAL ENG.
- CHEMISTRY
- UNDECIDED

- ELECTRICAL/COMPTUER ENGINEERING
- BIOMEDICAL ENGINEERING
- HUMANITIES/SOCIAL SCIENCES
- OTHER: _____

- COMPUTER SCIENCE
- PHYSICS
- BIOLOGY

(4)

WPI EBOT STUDENT SURVEY
TEAM NAME: Northbots GRADE: 12

What is your overall opinion of the WPI EBOT program?
Poor 1 2 3 4 5 6 7 8 9 10 Excellent
Comments:

Was the WPI EBOT program a fun experience? NO NEUTRAL YES
Comments:

Was the WPI EBOT program a good educational experience? NO NEUTRAL YES
Comments:

Did you feel you learned mechanical skills? NO NEUTRAL YES
Comments:

Did you feel you learned electrical skills? NO NEUTRAL YES
Comments:

Did you feel you learned programming skills? NO NEUTRAL YES
Comments:

Did you feel you gained teamwork skills? NO NEUTRAL YES
Comments:

Would you participate in the WPI EBOT program again? NO MAYBE YES
Comments:

Would you participate in other robotics program if they were offered? NO MAYBE YES
Comments:

Do you plan to attend college? NO MAYBE YES
Comments:

If so, what you plan to study?
 MECHANICAL ENGINEERING ELECTRICIAL/COMPTUER ENGINEERING COMPUTER SCIENCE
CIVIL/ENVIRONMENTAL ENG. BIOMEDICAL ENGINEERING PHYSICS
CHEMISTRY HUMANITIES/SOCIAL SCIENCES BIOLOGY
UNDECIDED OTHER: _____

0

WPI EBOT STUDENT SURVEY
TEAM NAME: DVDA GRADE: 11

What is your overall opinion of the WPI EBOT program?
Poor 1 2 3 4 5 6 7 8 9 10 Excellent

Comments: Play better music
Was the WPI EBOT program a fun experience? NO NEUTRAL YES ASSIGNMENT
Comments:

Was the WPI EBOT program a good educational experience? NO NEUTRAL YES
Comments:

Did you feel you learned mechanical skills? NO NEUTRAL YES
Comments:

Did you feel you learned electrical skills? NO NEUTRAL YES
Comments:

Did you feel you learned programming skills? NO NEUTRAL YES
Comments:

Did you feel you gained teamwork skills? NO NEUTRAL YES
Comments:

Would you participate in the WPI EBOT program again? NO MAYBE YES
Comments:

Would you participate in other robotics program if they were offered? NO MAYBE YES
Comments:

Do you plan to attend college? NO MAYBE YES
Comments:

If so, what you plan to study?
MECHANICAL ENGINEERING ELECTRICAL/COMPTUER ENGINEERING COMPUTER SCIENCE
CIVIL/ENVIRONMENTAL ENG. BIOMEDICAL ENGINEERING PHYSICS
CHEMISTRY HUMANITIES/SOCIAL SCIENCES BIOLOGY
UNDECIDED OTHER: Medicine

2

WPI EBOT STUDENT SURVEY

TEAM NAME: D.V.D.A. GRADE: 11

What is your overall opinion of the WPI EBOT program?
Poor 1 2 3 4 5 6 7 8 9 10 Excellent
Comments:

Was the WPI EBOT program a fun experience? NO NEUTRAL YES
Comments: I enjoyed building the robot

Was the WPI EBOT program a good educational experience? NO NEUTRAL YES
Comments: Trial and error is not the best

Did you feel you learned mechanical skills? NO NEUTRAL YES
Comments: How to build a robot

Did you feel you learned electrical skills? NO NEUTRAL YES
Comments: How polarized things worked

Did you feel you learned programming skills? NO NEUTRAL YES
Comments: I learned nothing

Did you feel you gained teamwork skills? NO NEUTRAL YES
Comments: we worked as a team

Would you participate in the WPI EBOT program again? NO MAYBE YES
Comments: It was fun

Would you participate in other robotics program if they were offered? NO MAYBE YES
Comments:

Do you plan to attend college? NO MAYBE YES
Comments: WPI would be nice.

If so, what you plan to study?
MECHANICAL ENGINEERING ELECTRICAL/COMPTUER ENGINEERING COMPUTER SCIENCE
CIVIL/ENVIRONMENTAL ENG. BIOMEDICAL ENGINEERING PHYSICS
CHEMISTRY HUMANITIES/SOCIAL SCIENCES BIOLOGY
UNDECIDED OTHER: _____

(3)

WPI EBOT STUDENT SURVEY
TEAM NAME: DVD# GRADE: 11

What is your overall opinion of the WPI EBOT program?
Poor 1 2 3 4 5 6 7 8 9 10 Excellent

Comments: I felt some rules were to strict

Was the WPI EBOT program a fun experience? NO NEUTRAL YES
Comments:

Was the WPI EBOT program a good educational experience? NO NEUTRAL YES
Comments:

Did you feel you learned mechanical skills? NO NEUTRAL YES
Comments:

Did you feel you learned electrical skills? NO NEUTRAL YES
Comments: Already have experience

Did you feel you learned programming skills? NO NEUTRAL YES
Comments: I don't like programming

Did you feel you gained teamwork skills? NO NEUTRAL YES
Comments: I have overall good skills

Would you participate in the WPI EBOT program again? NO MAYBE YES
Comments: It was fun

Would you participate in other robotics program if they were offered?
Comments: I love building things NO MAYBE YES

Do you plan to attend college? NO MAYBE YES
Comments: I want to go to WPI

If so, what you plan to study?
MECHANICAL ENGINEERING ELECTRICAL/COMPTUER ENGINEERING COMPUTER SCIENCE
CIVIL/ENVIRONMENTAL ENG. BIOMEDICAL ENGINEERING PHYSICS
CHEMISTRY HUMANITIES/SOCIAL SCIENCES BIOLOGY
UNDECIDED OTHER: _____

(4)

WPI EBOT STUDENT SURVEY

TEAM NAME: OVDA GRADE: 11

What is your overall opinion of the WPI EBOT program?

Poor 1 2 3 4 5 6 7 8 9 10 Excellent

Comments:

We got our kits the week before the competition and didn't have enough time to adequately prepare and test our robot.

Was the WPI EBOT program a fun experience?

NO NEUTRAL YES

Comments:

Play better music at the competition!

Was the WPI EBOT program a good educational experience?

NO NEUTRAL YES

Comments:

Did you feel you learned mechanical skills?

NO NEUTRAL YES

Comments:

Did you feel you learned electrical skills?

NO NEUTRAL YES

Comments:

Did you feel you learned programming skills?

NO NEUTRAL YES

Comments:

Did you feel you gained teamwork skills?

NO NEUTRAL YES

Comments:

Would you participate in the WPI EBOT program again?

NO MAYBE YES

Comments:

Would you participate in other robotics program if they were offered?

NO MAYBE YES

Comments:

Do you plan to attend college?

NO MAYBE YES

Comments:

If so, what you plan to study?

MECHANICAL ENGINEERING
CIVIL/ENVIRONMENTAL ENG.
CHEMISTRY
UNDECIDED

ELECTRICAL/COMPTUER ENGINEERING
BIOMEDICAL ENGINEERING
HUMANITIES/SOCIAL SCIENCES
OTHER: _____

COMPUTER SCIENCE
PHYSICS
BIOLOGY

5

TEAM NAME: DVDA WPI EBOT STUDENT SURVEY GRADE: 11

What is your overall opinion of the WPI EBOT program?
Poor 1 2 3 4 5 6 7 8 9 10 Excellent
Comments:

Was the WPI EBOT program a fun experience? NO NEUTRAL YES
Comments:

Was the WPI EBOT program a good educational experience? NO NEUTRAL YES
Comments:

Did you feel you learned mechanical skills? NO NEUTRAL YES
Comments: Already had them

Did you feel you learned electrical skills? NO NEUTRAL YES
Comments: Didn't do electrical work

Did you feel you learned programming skills? NO NEUTRAL YES
Comments: Didn't do programming

Did you feel you gained teamwork skills? NO NEUTRAL YES
Comments:

Would you participate in the WPI EBOT program again? NO MAYBE YES
Comments:

Would you participate in other robotics program if they were offered? NO MAYBE YES
Comments:

Do you plan to attend college? NO MAYBE YES
Comments:

If so, what you plan to study?
~~MECHANICAL ENGINEERING~~ ELECTRICAL/COMPTUER ENGINEERING COMPUTER SCIENCE
~~CIVIL/ENVIRONMENTAL ENG~~ BIOMEDICAL ENGINEERING PHYSICS
~~CHEMISTRY~~ HUMANITIES/SOCIAL SCIENCES BIOLOGY
UNDECIDED OTHER: Music performance/ Theory

(6)

TEAM NAME: ONDA WPI EBOT STUDENT SURVEY GRADE: 12

What is your overall opinion of the WPI EBOT program?
Poor 1 2 3 4 5 6 7 8 9 10 Excellent
Comments:

Was the WPI EBOT program a fun experience? NO NEUTRAL YES
Comments:

Was the WPI EBOT program a good educational experience? NO NEUTRAL YES
Comments:

Did you feel you learned mechanical skills? NO NEUTRAL YES
Comments:

Did you feel you learned electrical skills? NO NEUTRAL YES
Comments:

Did you feel you learned programming skills? NO NEUTRAL YES
Comments: *the programming was pretty easy*

Did you feel you gained teamwork skills? NO NEUTRAL YES
Comments:

Would you participate in the WPI EBOT program again? NO MAYBE YES
Comments: *But I am a senior, so I will be in college*

Would you participate in other robotics program if they were offered? NO MAYBE YES
Comments:

Do you plan to attend college? NO MAYBE YES
Comments:

If so, what you plan to study?
MECHANICAL ENGINEERING ELECTRICAL/COMPTUER ENGINEERING COMPUTER SCIENCE
CIVIL/ENVIRONMENTAL ENG. BIOMEDICAL ENGINEERING PHYSICS
CHEMISTRY HUMANITIES/SOCIAL SCIENCES BIOLOGY
UNDECIDED OTHER: possible engineering undeclared

1

TEAM NAME: TJ² WPI EBOT STUDENT SURVEY GRADE: 12

What is your overall opinion of the WPI EBOT program?
Poor 1 2 3 4 5 6 7 8 9 10 Excellent
Comments:

Was the WPI EBOT program a fun experience? NO NEUTRAL YES
Comments:

Was the WPI EBOT program a good educational experience? NO NEUTRAL YES
Comments:

Did you feel you learned mechanical skills? NO NEUTRAL YES
Comments:

Did you feel you learned electrical skills? NO NEUTRAL YES
Comments:

Did you feel you learned programming skills? NO NEUTRAL YES
Comments:

Did you feel you gained teamwork skills? NO NEUTRAL YES
Comments:

Would you participate in the WPI EBOT program again? NO MAYBE YES
Comments:

Would you participate in other robotics program if they were offered? NO MAYBE YES
Comments:

Do you plan to attend college? NO MAYBE YES
Comments:

If so, what you plan to study?
MECHANICAL ENGINEERING ELECTRICAL/COMPTUER ENGINEERING COMPUTER SCIENCE
CIVIL/ENVIRONMENTAL ENG. BIOMEDICAL ENGINEERING PHYSICS
CHEMISTRY HUMANITIES/SOCIAL SCIENCES BIOLOGY
UNDECIDED OTHER: _____

62

TEAM NAME: T5² WPI EBOT STUDENT SURVEY GRADE: 12

What is your overall opinion of the WPI EBOT program?
Poor 1 2 3 4 5 6 7 8 9 10 Excellent
Comments:

Was the WPI EBOT program a fun experience? NO NEUTRAL YES
Comments:

Was the WPI EBOT program a good educational experience? NO NEUTRAL YES
Comments:

Did you feel you learned mechanical skills? NO NEUTRAL YES
Comments:

Did you feel you learned electrical skills? NO NEUTRAL YES
Comments:

Did you feel you learned programming skills? NO NEUTRAL YES
Comments:

Did you feel you gained teamwork skills? NO NEUTRAL YES
Comments:

Would you participate in the WPI EBOT program again? NO MAYBE YES
Comments:

Would you participate in other robotics program if they were offered? NO MAYBE YES
Comments:

Do you plan to attend college? NO MAYBE YES
Comments:

If so, what you plan to study?
MECHANICAL ENGINEERING ELECTRICAL/COMPTUER ENGINEERING COMPUTER SCIENCE
CIVIL/ENVIRONMENTAL ENG. BIOMEDICAL ENGINEERING PHYSICS
CHEMISTRY HUMANITIES/SOCIAL SCIENCES BIOLOGY
UNDECIDED OTHER: _____

(3)

TEAM NAME: JJ² WPI EBOT STUDENT SURVEY GRADE: 12

What is your overall opinion of the WPI EBOT program?
Poor 1 2 3 4 5 6 7 8 9 10 Excellent 100
Comments:

Was the WPI EBOT program a fun experience? NO NEUTRAL YES
Comments:

Was the WPI EBOT program a good educational experience? NO NEUTRAL YES
Comments:

Did you feel you learned mechanical skills? NO NEUTRAL YES
Comments:

Did you feel you learned electrical skills? NO NEUTRAL YES
Comments:

Did you feel you learned programming skills? NO NEUTRAL YES
Comments:

Did you feel you gained teamwork skills? NO NEUTRAL YES
Comments:

Would you participate in the WPI EBOT program again? NO MAYBE YES
Comments:

Would you participate in other robotics program if they were offered? NO MAYBE YES
Comments:

Do you plan to attend college? NO MAYBE YES
Comments:

If so, what you plan to study?
MECHANICAL ENGINEERING ELECTRICAL/COMPTUER ENGINEERING COMPUTER SCIENCE
CIVIL/ENVIRONMENTAL ENG. BIOMEDICAL ENGINEERING PHYSICS
CHEMISTRY HUMANITIES/SOCIAL SCIENCES BIOLOGY
UNDECIDED OTHER: _____

4

TEAM NAME: TS WPI EBOT STUDENT SURVEY GRADE: 12

What is your overall opinion of the WPI EBOT program?
Poor 1 2 3 4 5 6 7 8 9 10 Excellent

Comments: I ♥ WPI

Was the WPI EBOT program a fun experience? NO NEUTRAL YES
Comments:

Was the WPI EBOT program a good educational experience? NO NEUTRAL YES
Comments:

Did you feel you learned mechanical skills? NO NEUTRAL YES
Comments: I can make a servo now

Did you feel you learned electrical skills? NO NEUTRAL YES
Comments:

Did you feel you learned programming skills? NO NEUTRAL YES
Comments:

Did you feel you gained teamwork skills? NO NEUTRAL YES
Comments:

Would you participate in the WPI EBOT program again? NO MAYBE YES
Comments:

Would you participate in other robotics program if they were offered? NO MAYBE YES
Comments:

Do you plan to attend college? NO MAYBE YES
Comments:

If so, what you plan to study?
MECHANICAL ENGINEERING ELECTRICAL/COMPTUER ENGINEERING COMPUTER SCIENCE
CIVIL/ENVIRONMENTAL ENG. BIOMEDICAL ENGINEERING PHYSICS
CHEMISTRY HUMANITIES/SOCIAL SCIENCES BIOLOGY
UNDECIDED OTHER: _____

(5)

TEAM NAME: TJ WPI EBOT STUDENT SURVEY GRADE: 12

What is your overall opinion of the WPI EBOT program?
Poor 1 2 3 4 5 6 7 8 9 10 Excellent

Comments: Need to explain rules more

Was the WPI EBOT program a fun experience? NO NEUTRAL YES
Comments:

Was the WPI EBOT program a good educational experience? NO NEUTRAL YES
Comments:

Teach us good skills
Did you feel you learned mechanical skills? NO NEUTRAL YES
Comments:

Did you feel you learned electrical skills? NO NEUTRAL YES
Comments:

Did you feel you learned programming skills? NO NEUTRAL YES
Comments: Did not participate in Program's

Did you feel you gained teamwork skills? NO NEUTRAL YES
Comments:

Worked well together
Would you participate in the WPI EBOT program again? NO MAYBE YES
Comments: It's quite fun!

Would you participate in other robotics program if they were offered? NO MAYBE YES
Comments:

Do you plan to attend college? NO MAYBE YES
Comments:

If so, what you plan to study?
MECHANICAL ENGINEERING ELECTRICAL/COMPTUER ENGINEERING COMPUTER SCIENCE
CIVIL/ENVIRONMENTAL ENG. BIOMEDICAL ENGINEERING PHYSICS
CHEMISTRY HUMANITIES/SOCIAL SCIENCES BIOLOGY
UNDECIDED OTHER: _____

6

TEAM NAME: T5² WPI EBOT STUDENT SURVEY GRADE: 12

What is your overall opinion of the WPI EBOT program?
Poor 1 2 3 4 5 6 7 8 9 10 Excellent
Comments:

Was the WPI EBOT program a fun experience? NO NEUTRAL YES
Comments:

Was the WPI EBOT program a good educational experience? NO NEUTRAL YES
Comments:

Did you feel you learned mechanical skills? NO NEUTRAL YES
Comments:

Did you feel you learned electrical skills? NO NEUTRAL YES
Comments:

Did you feel you learned programming skills? NO NEUTRAL YES
Comments:

Did you feel you gained teamwork skills? NO NEUTRAL YES
Comments:

Would you participate in the WPI EBOT program again? NO MAYBE YES
Comments: If I could

Would you participate in other robotics program if they were offered? NO MAYBE YES
Comments:

Do you plan to attend college? NO MAYBE YES
Comments:

If so, what you plan to study?
MECHANICAL ENGINEERING ELECTRICIAL/COMPTUER ENGINEERING COMPUTER SCIENCE
CIVIL/ENVIRONMENTAL ENG. BIOMEDICAL ENGINEERING PHYSICS
CHEMISTRY HUMANITIES/SOCIAL SCIENCES BIOLOGY
UNDECIDED OTHER: _____

7

TEAM NAME: TJ2 WPI EBOT STUDENT SURVEY GRADE: 12

What is your overall opinion of the WPI EBOT program?
Poor 1 2 3 4 5 6 7 8 9 10 Excellent
Comments:

Was the WPI EBOT program a fun experience? NO NEUTRAL YES
Comments:

Was the WPI EBOT program a good educational experience? NO NEUTRAL YES
Comments:

Did you feel you learned mechanical skills? NO NEUTRAL YES
Comments:

Did you feel you learned electrical skills? NO NEUTRAL YES
Comments:

Did you feel you learned programming skills? NO NEUTRAL YES
Comments:

Did you feel you gained teamwork skills? NO NEUTRAL YES
Comments:

Would you participate in the WPI EBOT program again? NO MAYBE YES
Comments:

Would you participate in other robotics program if they were offered? NO MAYBE YES
Comments:

Do you plan to attend college? NO MAYBE YES
Comments:

If so, what you plan to study?
MECHANICAL ENGINEERING ELECTRICAL/COMPTUER ENGINEERING COMPUTER SCIENCE
CIVIL/ENVIRONMENTAL ENG. BIOMEDICAL ENGINEERING PHYSICS
CHEMISTRY HUMANITIES/SOCIAL SCIENCES BIOLOGY
UNDECIDED OTHER: _____

①

WPI EBOT STUDENT SURVEY

TEAM NAME: Tobiasova GRADE: 12

What is your overall opinion of the WPI EBOT program?
Poor 1 2 3 4 5 6 7 **8** 9 10 Excellent
Comments:

Was the WPI EBOT program a fun experience? NO NEUTRAL **YES**
Comments:

Was the WPI EBOT program a good educational experience? NO NEUTRAL **YES**
Comments:

Did you feel you learned mechanical skills? NO **NEUTRAL** YES
Comments:

Did you feel you learned electrical skills? NO **NEUTRAL** YES
Comments:

Did you feel you learned programming skills? **NO** NEUTRAL YES
Comments:

Did you feel you gained teamwork skills? NO **NEUTRAL** YES
Comments:

Would you participate in the WPI EBOT program again? NO MAYBE **YES**
Comments:

Would you participate in other robotics program if they were offered? NO MAYBE **YES**
Comments:

Do you plan to attend college? NO MAYBE **YES**
Comments:

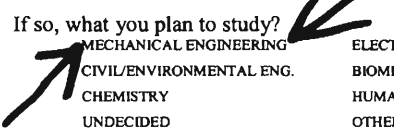
If so, what you plan to study? 
MECHANICAL ENGINEERING ELECTRICAL/COMPTUER ENGINEERING COMPUTER SCIENCE
CIVIL/ENVIRONMENTAL ENG. BIOMEDICAL ENGINEERING PHYSICS
CHEMISTRY HUMANITIES/SOCIAL SCIENCES BIOLOGY
UNDECIDED OTHER: _____

2

WPI EBOT STUDENT SURVEY

TEAM NAME: to bonotua GRADE: 11

What is your overall opinion of the WPI EBOT program? (8) 9 10 Excellent
Poor 1 2 3 4 5 6 7 8 9 10 Excellent
Comments:

Was the WPI EBOT program a fun experience? NO NEUTRAL YES
Comments:

Was the WPI EBOT program a good educational experience? NO NEUTRAL YES
Comments:

Did you feel you learned mechanical skills? NO NEUTRAL YES
Comments:

Did you feel you learned electrical skills? NO NEUTRAL YES
Comments:

Did you feel you learned programming skills? NO NEUTRAL YES
Comments:

Did you feel you gained teamwork skills? NO NEUTRAL YES
Comments:

Would you participate in the WPI EBOT program again? NO MAYBE YES
Comments:

Would you participate in other robotics program if they were offered? NO MAYBE YES
Comments:

Do you plan to attend college? NO MAYBE YES
Comments:

If so, what you plan to study?
MECHANICAL ENGINEERING ELECTRICAL/COMPTUER ENGINEERING COMPUTER SCIENCE
CIVIL/ENVIRONMENTAL ENG. BIOMEDICAL ENGINEERING PHYSICS
CHEMISTRY HUMANITIES/SOCIAL SCIENCES BIOLOGY
UNDECIDED OTHER: _____

I couldn't
make it
to a lot
of the
team
meetings

3

WPI EBOT STUDENT SURVEY

TEAM NAME: TOBACCO GRADE: 12

What is your overall opinion of the WPI EBOT program?

Poor 1 2 3 4 5 6 7 8 9 10 Excellent

Comments:

Was the WPI EBOT program a fun experience?

NO NEUTRAL YES

Comments:

Was the WPI EBOT program a good educational experience?

NO NEUTRAL YES

Comments:

Did you feel you learned mechanical skills?

NO NEUTRAL YES

Comments:

Did you feel you learned electrical skills?

NO NEUTRAL YES

Comments:

Did you feel you learned programming skills?

NO NEUTRAL YES

Comments:

Did you feel you gained teamwork skills?

NO NEUTRAL YES

Comments:

Would you participate in the WPI EBOT program again?

NO MAYBE YES

Comments:

Would you participate in other robotics program if they were offered?

NO MAYBE YES

Comments:

Do you plan to attend college?

NO MAYBE YES

Comments:

If so, what you plan to study?

- MECHANICAL ENGINEERING
- CIVIL/ENVIRONMENTAL ENG.
- CHEMISTRY
- UNDECIDED

- ELECTRICAL/COMPUTER ENGINEERING
- BIOMEDICAL ENGINEERING
- HUMANITIES/SOCIAL SCIENCES
- OTHER: _____

- COMPUTER SCIENCE
- PHYSICS
- BIOLOGY

4

WPI EBOT STUDENT SURVEY

TEAM NAME: Tobanotva GRADE: 11

What is your overall opinion of the WPI EBOT program?

Poor 1 2 3 4 5 6 7 8 9 10 Excellent

Comments:

Was the WPI EBOT program a fun experience?

NO NEUTRAL YES

Comments:

Was the WPI EBOT program a good educational experience?

NO NEUTRAL YES

Comments:

Did you feel you learned mechanical skills?

NO NEUTRAL YES

Comments:

Did you feel you learned electrical skills?

NO NEUTRAL YES

Comments:

Did you feel you learned programming skills?

NO NEUTRAL YES

Comments:

Did you feel you gained teamwork skills?

NO NEUTRAL YES

Comments:

Would you participate in the WPI EBOT program again?

NO MAYBE YES

Comments:

Would you participate in other robotics program if they were offered?

NO MAYBE YES

Comments:

Do you plan to attend college?

NO MAYBE YES

Comments:

If so, what you plan to study?

- MECHANICAL ENGINEERING
- CIVIL/ENVIRONMENTAL ENG.
- CHEMISTRY
- UNDECIDED

- ELECTRICAL/COMPTUER ENGINEERING
- BIOMEDICAL ENGINEERING
- HUMANITIES/SOCIAL SCIENCES
- OTHER: _____

- COMPUTER SCIENCE
- PHYSICS
- BIOLOGY

6

WPI EBOT STUDENT SURVEY
TEAM NAME: Tobano tUA GRADE: 11

What is your overall opinion of the WPI EBOT program?
Poor 1 2 3 4 5 6 7 8 9 10 Excellent
Comments:

Was the WPI EBOT program a fun experience? NO NEUTRAL YES
Comments:

Was the WPI EBOT program a good educational experience? NO NEUTRAL ~~YES~~
Comments:

Did you feel you learned mechanical skills? NO NEUTRAL YES
Comments:

Did you feel you learned electrical skills? NO NEUTRAL YES
Comments: Nothing new, already knew it for previous experiences

Did you feel you learned programming skills? NO NEUTRAL YES
Comments:

Did you feel you gained teamwork skills? NO NEUTRAL YES
Comments:

Would you participate in the WPI EBOT program again? NO MAYBE YES
Comments:

Would you participate in other robotics program if they were offered? NO MAYBE YES
Comments:

Do you plan to attend college? NO MAYBE YES
Comments:

If so, what you plan to study?
MECHANICAL ENGINEERING ELECTRICAL/COMPTUER ENGINEERING COMPUTER SCIENCE
CIVIL/ENVIRONMENTAL ENG. BIOMEDICAL ENGINEERING PHYSICS
CHEMISTRY HUMANITIES/SOCIAL SCIENCES BIOLOGY
UNDECIDED OTHER: _____

1

WPI EBOT STUDENT SURVEY
TEAM NAME: The Pink GRADE: 11

What is your overall opinion of the WPI EBOT program?
Poor 1 2 3 4 5 6 7 8 9 10 Excellent
Comments:

Was the WPI EBOT program a fun experience? NO NEUTRAL YES
Comments:

Was the WPI EBOT program a good educational experience? NO NEUTRAL YES
Comments:

Did you feel you learned mechanical skills? NO NEUTRAL YES
Comments:

Did you feel you learned electrical skills? NO NEUTRAL YES
Comments:

Did you feel you learned programming skills? NO NEUTRAL YES
Comments: Didnt have time to program autonomous

Did you feel you gained teamwork skills? NO NEUTRAL YES
Comments:

Would you participate in the WPI EBOT program again? NO MAYBE YES
Comments:

Would you participate in other robotics program if they were offered? NO MAYBE YES
Comments:

Do you plan to attend college? NO MAYBE YES
Comments:

If so, what you plan to study?
MECHANICAL ENGINEERING ELECTRICAL/COMPTUER ENGINEERING COMPUTER SCIENCE
CIVIL/ENVIRONMENTAL ENG. BIOMEDICAL ENGINEERING PHYSICS
CHEMISTRY HUMANITIES/SOCIAL SCIENCES BIOLOGY
UNDECIDED OTHER: _____

2

WPI EBOT STUDENT SURVEY

TEAM NAME: ~~120~~ The Pink GRADE: 11

What is your overall opinion of the WPI EBOT program?
Poor 1 2 3 4 5 6 7 8 9 10 Excellent
Comments:

Was the WPI EBOT program a fun experience? NO NEUTRAL YES
Comments:

Was the WPI EBOT program a good educational experience? NO NEUTRAL YES
Comments:

Did you feel you learned mechanical skills? NO NEUTRAL YES
Comments:

Did you feel you learned electrical skills? NO NEUTRAL YES
Comments:

Did you feel you learned programming skills? NO NEUTRAL YES
Comments:

Did you feel you gained teamwork skills? NO NEUTRAL YES
Comments:

Would you participate in the WPI EBOT program again? NO MAYBE YES
Comments:

Would you participate in other robotics program if they were offered? NO MAYBE YES
Comments:

Do you plan to attend college? NO MAYBE YES
Comments:

If so, what you plan to study?
MECHANICAL ENGINEERING ELECTRICAL/COMPTUER ENGINEERING COMPUTER SCIENCE
CIVIL/ENVIRONMENTAL ENG. BIOMEDICAL ENGINEERING PHYSICS
CHEMISTRY HUMANITIES/SOCIAL SCIENCES BIOLOGY
UNDECIDED OTHER: _____

♡ Mentor! ♡

③

WPI EBOT STUDENT SURVEY

TEAM NAME: The Pink! GRADE: Soph. College

What is your overall opinion of the WPI EBOT program?

Poor 1 2 3 4 5 6 7 8 9 10 Excellent
Comments:

Was the WPI EBOT program a fun experience?

NO NEUTRAL YES

Comments: yes, it's great to see the kids get together + learn!

Was the WPI EBOT program a good educational experience?

NO NEUTRAL YES

Comments: yes, the students go from having hands-on

almost no experience to having a basic knowledge in electronics + mechanics.

Did you feel you learned mechanical skills?

NO NEUTRAL YES

Comments: we can always learn for working in a shop

Did you feel you learned electrical skills?

NO NEUTRAL YES

Comments: yes. ~~it's~~

Did you feel you learned programming skills?

NO NEUTRAL YES

Comments: it's great having autonomous.

Did you feel you gained teamwork skills?

NO NEUTRAL YES

Comments: every opportunity to work w/ new people = new skills

Would you participate in the WPI EBOT program again?

NO MAYBE YES

Comments: I ♡ Mentoring / Coaching

Would you participate in other robotics program if they were offered?

NO MAYBE YES

Comments: WPI Robotics!

Do you plan to attend college?

NO MAYBE YES

Comments: like Duh!

If so, what you plan to study?

- MECHANICAL ENGINEERING
- CIVIL/ENVIRONMENTAL ENG.
- CHEMISTRY
- UNDECIDED

- ELECTRICAL/COMPTUER ENGINEERING
- BIOMEDICAL ENGINEERING
- HUMANITIES/SOCIAL SCIENCES

- COMPUTER SCIENCE
- PHYSICS
- BIOLOGY

OTHER: Management

(4)

WPI EBOT STUDENT SURVEY
TEAM NAME: The Pink GRADE: 11

What is your overall opinion of the WPI EBOT program?
Poor 1 2 3 4 5 6 7 8 9 10 Excellent
Comments:

Was the WPI EBOT program a fun experience? NO NEUTRAL YES
Comments:

Was the WPI EBOT program a good educational experience? NO NEUTRAL YES
Comments:

Did you feel you learned mechanical skills? NO NEUTRAL YES
Comments:

Did you feel you learned electrical skills? NO NEUTRAL YES
Comments:

Did you feel you learned programming skills? NO NEUTRAL YES
Comments:

Did you feel you gained teamwork skills? NO NEUTRAL YES
Comments:

Would you participate in the WPI EBOT program again? NO MAYBE YES
Comments:

Would you participate in other robotics program if they were offered? NO MAYBE YES
Comments:

Do you plan to attend college? NO MAYBE YES
Comments:

If so, what you plan to study?
MECHANICAL ENGINEERING ELECTRICAL/COMPTUER ENGINEERING COMPUTER SCIENCE
CIVIL/ENVIRONMENTAL ENG. BIOMEDICAL ENGINEERING PHYSICS
CHEMISTRY HUMANITIES/SOCIAL SCIENCES BIOLOGY
UNDECIDED OTHER: _____



WPI EBOT STUDENT SURVEY

TEAM NAME: The Perk GRADE: 11

What is your overall opinion of the WPI EBOT program?

Poor 1 2 3 4 5 6 7 8 9 10 Excellent

Comments: more success

Was the WPI EBOT program a fun experience?
Comments:

NO NEUTRAL YES

Was the WPI EBOT program a good educational experience?
Comments:

NO NEUTRAL YES

Did you feel you learned mechanical skills?
Comments:

NO NEUTRAL YES

Did you feel you learned electrical skills?
Comments:

NO NEUTRAL YES

Did you feel you learned programming skills?
Comments:

NO NEUTRAL YES

Did you feel you gained teamwork skills?
Comments:

NO NEUTRAL YES

Would you participate in the WPI EBOT program again?
Comments:

NO MAYBE YES

Would you participate in other robotics program if they were offered?
Comments:

NO MAYBE YES

Do you plan to attend college?
Comments:

NO MAYBE YES

If so, what you plan to study?

- MECHANICAL ENGINEERING
- CIVIL/ENVIRONMENTAL ENG.
- CHEMISTRY
- UNDECIDED

- ELECTRICAL/COMPTUER ENGINEERING
- BIOMEDICAL ENGINEERING
- HUMANITIES/SOCIAL SCIENCES
- OTHER: _____

- COMPUTER SCIENCE
- PHYSICS
- BIOLOGY

6

WPI EBOT STUDENT SURVEY

TEAM NAME: Pink GRADE: fd

What is your overall opinion of the WPI EBOT program?
Poor 1 2 3 4 5 6 7 8 9 10 Excellent
Comments:

Was the WPI EBOT program a fun experience? NO NEUTRAL YES
Comments:

Was the WPI EBOT program a good educational experience? NO NEUTRAL YES
Comments:

Did you feel you learned mechanical skills? NO NEUTRAL YES
Comments:

Did you feel you learned electrical skills? NO NEUTRAL YES
Comments:

Did you feel you learned programming skills? NO NEUTRAL YES
Comments:

Did you feel you gained teamwork skills? NO NEUTRAL YES
Comments:

Would you participate in the WPI EBOT program again? NO MAYBE YES
Comments:

Would you participate in other robotics program if they were offered? NO MAYBE YES
Comments:

Do you plan to attend college? NO MAYBE YES
Comments:

If so, what you plan to study?
MECHANICAL ENGINEERING ELECTRICAL/COMPTUER ENGINEERING COMPUTER SCIENCE
CIVIL/ENVIRONMENTAL ENG. BIOMEDICAL ENGINEERING PHYSICS
CHEMISTRY HUMANITIES/SOCIAL SCIENCES BIOLOGY
UNDECIDED OTHER: _____

7

TEAM NAME: The Pink WPI EBOT STUDENT SURVEY GRADE: Mentor

What is your overall opinion of the WPI EBOT program?
Poor 1 2 3 4 5 6 7 (8) 9 10 Excellent
Comments:

Was the WPI EBOT program a fun experience? NO NEUTRAL YES
Comments:

Was the WPI EBOT program a good educational experience? NO NEUTRAL YES
Comments:

Did you feel ^{the kids} you learned mechanical skills? NO NEUTRAL YES
Comments:

Did you feel ^{they} you learned electrical skills? NO NEUTRAL YES helped
Comments:

Did you feel you learned programming skills? NO NEUTRAL YES
Comments:

Did you feel ^{they} you gained teamwork skills? NO NEUTRAL YES
Comments:

Would you participate in the WPI EBOT program again? NO MAYBE YES
Comments:

Would you participate in other robotics program if they were offered? NO MAYBE YES
Comments:

Do you plan to attend college? NO MAYBE YES
Comments:

If so, what you plan to study?
MECHANICAL ENGINEERING
CIVIL/ENVIRONMENTAL ENG.
CHEMISTRY
UNDECIDED
ELECTRICAL/COMPTUER ENGINEERING
BIOMEDICAL ENGINEERING
HUMANITIES/SOCIAL SCIENCES.
OTHER: ANALYTICS
COMPUTER SCIENCE
PHYSICS
BIOLOGY
Shop so the robot's ready to do a mechanical stuff (like a robot)
also, the motors kept breaking and that was really design to deal with

①

TEAM NAME: Sporck WPI EBOT STUDENT SURVEY GRADE: 13th (Major)

What is your overall opinion of the WPI EBOT program?
Poor 1 2 3 4 5 6 7 8 9 10 Excellent
Comments:

Was the WPI EBOT program a fun experience? NO NEUTRAL YES
Comments:

Was the WPI EBOT program a good educational experience? NO NEUTRAL YES
Comments:

Did you feel you learned mechanical skills? NO NEUTRAL YES
Comments:

Did you feel you learned electrical skills? NO NEUTRAL YES
Comments:

Did you feel you learned programming skills? NO NEUTRAL YES
Comments:

Did you feel you gained teamwork skills? NO NEUTRAL YES
Comments:

Would you participate in the WPI EBOT program again? NO MAYBE YES
Comments:

Would you participate in other robotics program if they were offered? NO MAYBE YES
Comments:

Do you plan to attend college? NO MAYBE YES
Comments:

If so, what you plan to study?
MECHANICAL ENGINEERING ELECTRICAL/COMPTUER ENGINEERING COMPUTER SCIENCE
CIVIL/ENVIRONMENTAL ENG. BIOMEDICAL ENGINEERING PHYSICS
CHEMISTRY HUMANITIES/SOCIAL SCIENCES BIOLOGY
UNDECIDED OTHER: _____

Mentor!

2

WPI EBOT STUDENT SURVEY

TEAM NAME: Spark GRADE: 14th

What is your overall opinion of the WPI EBOT program?

Poor 1 2 3 4 5 6 7 **8** 9 10 Excellent

Comments:

Was the WPI EBOT program a fun experience?

NO NEUTRAL **YES**

Comments: Zip ties are awesome

Was the WPI EBOT program a good educational experience?

NO NEUTRAL **YES**

Comments:

Did you feel you learned mechanical skills?

NO NEUTRAL YES

Comments:

Did you feel you learned electrical skills?

NO NEUTRAL YES

Comments:

Did you feel you learned programming skills?

NO NEUTRAL YES

Comments:

Did you feel you gained teamwork skills?

NO NEUTRAL **YES**

Comments:

Would you participate in the WPI EBOT program again?

NO MAYBE **YES**

Comments:

Would you participate in other robotics program if they were offered?

NO MAYBE **YES**

Comments:

Do you plan to attend college?

NO **MAYBE** YES

Comments: I hope I don't fail out of here

If so, what you plan to study?

MECHANICAL ENGINEERING

CIVIL/ENVIRONMENTAL ENG.

CHEMISTRY

UNDECIDED

ELECTRICAL/COMPTUER ENGINEERING

BIOMEDICAL ENGINEERING

HUMANITIES/SOCIAL SCIENCES

OTHER: _____

COMPUTER SCIENCE

PHYSICS

BIOLOGY

6

WPI EBOT STUDENT SURVEY
TEAM NAME: MARIO (Mentor) GRADE: Freshman

What is your overall opinion of the WPI EBOT program?
Poor 1 2 3 4 5 6 7 8 9 10 Excellent
Comments:

Was the WPI EBOT program a fun experience? NO NEUTRAL YES
Comments:

Was the WPI EBOT program a good educational experience? NO NEUTRAL YES
Comments:

Did you feel you learned mechanical skills? NO NEUTRAL YES
Comments:

Did you feel you learned electrical skills? NO NEUTRAL YES
Comments:

Did you feel you learned programming skills? NO NEUTRAL YES
Comments:

Did you feel you gained teamwork skills? NO NEUTRAL YES
Comments:

N/A
(Mentor)

Would you participate in the WPI EBOT program again? NO MAYBE YES
Comments:

Would you participate in other robotics program if they were offered?
Comments: would depend on meeting times NO MAYBE YES

Do you plan to attend college? NO MAYBE YES
Comments: Already in college

If so, what you plan to study?
MECHANICAL ENGINEERING ELECTRICAL/COMPTUER ENGINEERING COMPUTER SCIENCE
CIVIL/ENVIRONMENTAL ENG. BIOMEDICAL ENGINEERING PHYSICS
CHEMISTRY HUMANITIES/SOCIAL SCIENCES BIOLOGY
UNDECIDED OTHER: _____

2

WPI EBOT STUDENT SURVEY

TEAM NAME: MARFO GRADE: Mass Academy

What is your overall opinion of the WPI EBOT program?
Poor 1 2 3 4 5 6 7 8 9 10 Excellent
Comments:

Was the WPI EBOT program a fun experience? NO NEUTRAL YES
Comments:

Was the WPI EBOT program a good educational experience? NO NEUTRAL YES
Comments:

Did you feel you learned mechanical skills? NO NEUTRAL YES
Comments: Previous experience

Did you feel you learned electrical skills? NO NEUTRAL YES
Comments: Previous experience

Did you feel you learned programming skills? NO NEUTRAL YES
Comments: Previous experience

Did you feel you gained teamwork skills? NO NEUTRAL YES
Comments:

Would you participate in the WPI EBOT program again? NO MAYBE YES
Comments:

Would you participate in other robotics program if they were offered?
Comments: NO MAYBE YES

Do you plan to attend college? NO MAYBE YES
Comments:

If so, what you plan to study?
MECHANICAL ENGINEERING ELECTRICAL/COMPTUER ENGINEERING COMPUTER SCIENCE
CIVIL/ENVIRONMENTAL ENG. BIOMEDICAL ENGINEERING PHYSICS
CHEMISTRY HUMANITIES/SOCIAL SCIENCES BIOLOGY
UNDECIDED OTHER: Aero Eng

3

WPI EBOT STUDENT SURVEY

TEAM NAME: MARU (6) GRADE: 12

What is your overall opinion of the WPI EBOT program?

Poor 1 2 3 4 5 6 7 8 9 10 Excellent

Comments:

Was the WPI EBOT program a fun experience? NO NEUTRAL YES
Comments:

Was the WPI EBOT program a good educational experience? NO NEUTRAL YES
Comments:

Did you feel you learned mechanical skills? NO NEUTRAL YES
Comments:

Did you feel you learned electrical skills? NO NEUTRAL YES
Comments:

Did you feel you learned programming skills? NO NEUTRAL YES
Comments:

Did you feel you gained teamwork skills? NO NEUTRAL YES
Comments:

Would you participate in the WPI EBOT program again? NO MAYBE YES
Comments:

Would you participate in other robotics program if they were offered? NO MAYBE YES
Comments:

Do you plan to attend college? NO MAYBE YES
Comments:

If so, what you plan to study?

- | | | |
|-------------------------------|---------------------------------|------------------|
| <u>MECHANICAL ENGINEERING</u> | ELECTRICAL/COMPTUER ENGINEERING | COMPUTER SCIENCE |
| CIVIL/ENVIRONMENTAL ENG. | BIOMEDICAL ENGINEERING | PHYSICS |
| CHEMISTRY | HUMANITIES/SOCIAL SCIENCES | BIOLOGY |
| <u>UNDECIDED</u> | OTHER: _____ | |

5

WPI EBOT STUDENT SURVEY
TEAM NAME: Mano GRADE: 11th

What is your overall opinion of the WPI EBOT program?
Poor 1 2 3 4 5 6 7 8 9 10 Excellent
Comments:

Was the WPI EBOT program a fun experience? NO NEUTRAL YES
Comments:

Was the WPI EBOT program a good educational experience? NO NEUTRAL YES
Comments:

Did you feel you learned mechanical skills? NO NEUTRAL YES
Comments:

Did you feel you learned electrical skills? NO NEUTRAL YES
Comments:

Did you feel you learned programming skills? NO NEUTRAL YES
Comments:

Did you feel you gained teamwork skills? NO NEUTRAL YES
Comments:

Would you participate in the WPI EBOT program again? NO MAYBE YES
Comments: Students should be able to work on the bot at home without mentor supervision

Would you participate in other robotics programs if they were offered? NO MAYBE YES
Comments:

Do you plan to attend college? NO MAYBE YES
Comments:

If so, what you plan to study?
~~MECHANICAL ENGINEERING~~ ELECTRICAL/COMPTUER ENGINEERING COMPUTER SCIENCE
CIVIL/ENVIRONMENTAL ENG. BIOMEDICAL ENGINEERING PHYSICS
CHEMISTRY HUMANITIES/SOCIAL SCIENCES BIOLOGY
UNDECIDED OTHER: _____

5

WPI EBOT STUDENT SURVEY

TEAM NAME: Mario GRADE: 11

What is your overall opinion of the WPI EBOT program?
Poor 1 2 3 4 5 6 7 8 9 10 Excellent
Comments:

Was the WPI EBOT program a fun experience? NO NEUTRAL YES
Comments:

Was the WPI EBOT program a good educational experience? NO NEUTRAL ~~YES~~
Comments:

Did you feel you learned mechanical skills? NO NEUTRAL YES
Comments:

Did you feel you learned electrical skills? NO NEUTRAL YES
Comments:

Did you feel you learned programming skills? NO NEUTRAL YES
Comments:

Did you feel you gained teamwork skills? NO NEUTRAL YES
Comments:

Would you participate in the WPI EBOT program again? NO MAYBE YES
Comments:

Would you participate in other robotics program if they were offered? NO MAYBE YES
Comments:

Do you plan to attend college? NO MAYBE YES
Comments:

If so, what you plan to study?
MECHANICAL ENGINEERING ELECTRICAL/COMPTUER ENGINEERING COMPUTER SCIENCE
CIVIL/ENVIRONMENTAL ENG. BIOMEDICAL ENGINEERING PHYSICS
CHEMISTRY HUMANITIES/SOCIAL SCIENCES BIOLOGY
UNDECIDED OTHER: _____

① x 7

WPI EBOT STUDENT SURVEY

TEAM NAME: Total PUNNAGE GTD GRADE: 11-12

What is your overall opinion of the WPI EBOT program?
Poor 1 2 3 4 5 6 7 8 9 10 Excellent
Comments:

Was the WPI EBOT program a fun experience? NO NEUTRAL YES
Comments:

Was the WPI EBOT program a good educational experience? NO NEUTRAL YES
Comments:

Did you feel you learned mechanical skills? NO NEUTRAL YES
Comments:

Did you feel you learned electrical skills? NO NEUTRAL YES
Comments: We learned how not to do things

Did you feel you learned programming skills? NO NEUTRAL YES
Comments:

Did you feel you gained teamwork skills? NO NEUTRAL YES
Comments:

Would you participate in the WPI EBOT program again? NO MAYBE YES
Comments:

Would you participate in other robotics program if they were offered? NO MAYBE YES
Comments:

Do you plan to attend college? NO MAYBE YES
Comments:

If so, what you plan to study?
// MECHANICAL ENGINEERING // ELECTRICAL/COMPTUER ENGINEERING COMPUTER SCIENCE
CIVIL/ENVIRONMENTAL ENG. BIOMEDICAL ENGINEERING PHYSICS
CHEMISTRY HUMANITIES/SOCIAL SCIENCES BIOLOGY
8// UNDECIDED OTHER: _____

Appendix F: 2004 Savage Soccer Game Rules

1. Objective

To design and build a radio-controlled robot that will defeat your opponent in competition.

The winner is the team that wins the finals at the end of the tournament.

2. The Game

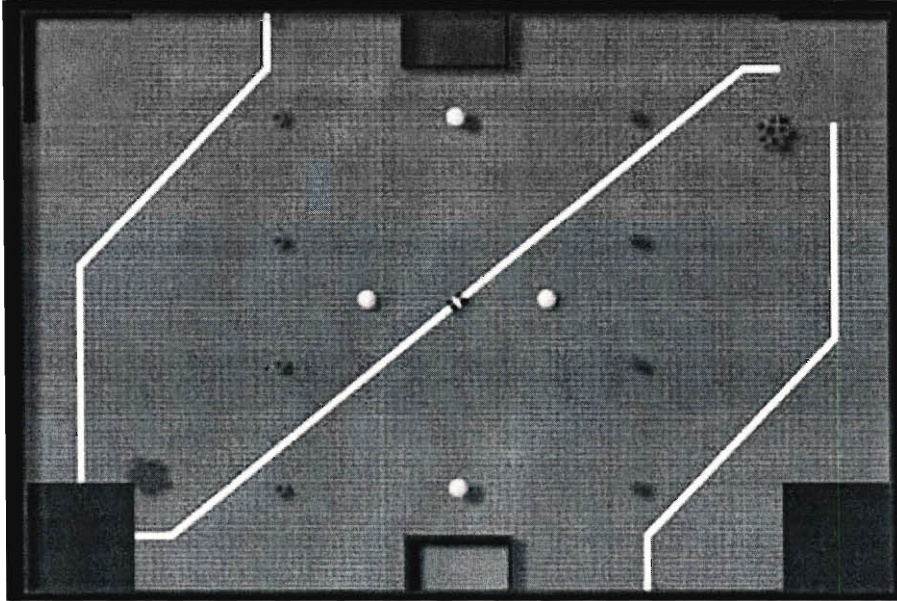

- 2.1 Field Description
 - 2.1.1 The field is roughly 8' x 12'. The outer boundaries of the playing area and walled scoring areas are formed by a wooden frame that is approximately 3" in height and $\frac{3}{4}$ " in thickness. The surface of the playing area is gray, "high-traffic" carpet.
 - 2.1.2 Robots will begin the match in one of the two colored starting areas which are 18" by 18" in size, and located in opposing corners of the field. Teams will be designated as either "Red" or "Blue" on a match-by-match basis as noted on the Match List. The starting areas will be marked by colored tape.
 - 2.1.3 Three types of scoring objects are located throughout the playing field:
 - 2.1.3.1 Tubes: There will be 20 regular tubes on the playing field at the start of the match as shown in the Field Drawing. One end of each tube is painted red and the other end is painted blue. Tubes

will start the match standing on end, with ten of each color up as shown in the Field Drawing.

- 2.1.3.1.1 Tube Dimensions: approximately 1-5/8 I.D. PVC tubing cut to 3" length. On each end of the tube there is a 3/16" thick lip which is 1/2" in length. Each team will be supplied with a standard tube for practice.
- 2.1.3.2 Tennis Balls: Four standard tennis balls will be located in the playing field at the start of the match. Two will be located on the floor and two will be sitting on top of upright tubes as designated in the Field Drawing.
- 2.1.3.3 Über-tüber: One tube will be made similar to the regular tubes but will have an extra gold ring painted around the center of the tube designating it as the über-tüber. It will begin each match laying on its side in the center of the playing field.
 - 2.1.3.3.1 Über-tüber Dimensions: The über-tüber is the same size as the regular tube. It is different only in an extra band of gold paint in the center.
- 2.1.4 All field dimensions should be considered to be +/- .5"
- 2.2 There are two scoring areas of each color located on the field:
 - 2.2.1 Field Scoring Area (FSA): There is one FSA each for Red and Blue located on the field as shown in the Field Drawing. FSAs are 18" x 18" in size and the outer borders of the scoring areas are marked by Red or Blue colored duct tape. For purposes of differentiating these areas from the robot starting areas, FSAs will have a colored X through center made with duct tape.
 - 2.2.2 Walled Scoring Area (WSA): There is one WSA each for Red and Blue located on the field as shown in the Field Drawing. WSAs are 9" x 18" in size and bounded by the same wooden boards that form the outer border of the field.
- 2.3 Match Scoring
 - 2.3.1 All scoring will occur at the end of each two-minute match, after all robots and scoring objects have come to rest.
 - 2.3.2 A tube is considered to be in a scoring position if any part of the tube is contained within a scoring area and is supported by only the floor of the playing area, the borders of the WSA, and/or other scoring objects considered being in scoring position.
 - 2.3.3 A tennis ball is considered to be in scoring position if supported only by a tube standing on end.
 - 2.3.4 If a team's robot is in contact with any of their scoring objects, either tennis balls or tubes, those objects will not be counted. Opposing robots in contact with the other team's scoring objects will not negate points for

either team except if it is in violation of Section 2.3.2 and the scoring object is supported by the robot.

- 2.3.5 At the end of the match, when all scoring objects and robots have come to a full and complete stop, each team will receive points based on the following criteria:
 - 2.3.5.1 One point for each tube standing upright anywhere in the field with your color up.
 - 2.3.5.1.1 A tube is considered "upright" if the complete lip on one side is completely in contact with the carpet.
 - 2.3.5.2 One point for each tube, irrelevant of orientation, in a scoring area.
 - 2.3.5.3 Seven points for each tennis ball sitting on the end of a standing tube. The points for the tennis ball will be given to the team whose color is up on the tube. It does not matter which team places the ball on top of the tube or where the tube is located in the playing area.
- 2.3.6 Multipliers
 - 2.3.6.1 The point value for any objects in the Walled Scoring Area will be doubled.
 - 2.3.6.2 The point value for any objects in the same scoring area as the über-tüber will be doubled. The über-tüber also counts as a regular tube for scoring purposes.
 - 2.3.6.3 The Real-Time Varying Multiplier (RTVM): There will be two color-coded buttons located on the field as noted in the Field Drawing.
 - 2.3.6.3.1 Once one of the buttons is hit, it locks in a multiplier for the team whose button is hit. It does not matter which team hits the button.
 - 2.3.6.3.2 The buttons are only active during autonomous mode.
 - 2.3.6.3.3 If a button is activated during the first half of autonomous mode, it will lock in a multiplier of 2. If it is activated during the last half of the autonomous mode, it will lock in a multiplier of 1.5.
 - 2.3.6.3.4 The RTVM multiplies any and all points scored during the match.
 - 2.3.6.4 Teams may score and compound more than one multiplier during any given match.

- 2.3.7 Tie Breakers

In the event of a tie, the winner of the match will be determined by the following criteria, in this order:

 - Most tubes of your color upright
 - Most objects in the Walled Scoring Area
 - Über-tüber upright with your color up
 - Flip of a coin, where Red is assigned heads and Blue is assigned tails
- 2.4 Match Schedule & Ranking
 - 2.4.1 The competition will consist of Qualifying Matches followed by Elimination Matches.
 - 2.4.2 Qualifying Matches
 - 2.4.2.1 All teams will play in the same number of Qualifying Matches. The number of qualifying matches at each event will be determined by the length of the event and the number of teams competing.
 - 2.4.2.2 Teams will be given their schedule of qualification matches no later than the start of the first match of that day's event. The qualification match schedule will show the match number, the two teams competing in each match, and the color they are assigned for that match.
 - 2.4.2.3 At the end of each qualifying match, the total number of points scored by each team will be considered their Qualification Points.
 - 2.4.3 Ranking:

At the end of the qualifying matches, teams will be ranked from 1 to N (N being the total number of teams present) based on the following:

 - Total number of Qualification Points first, then
 - Most wins, then
 - Most matches with the Über-tüber counting towards your score, then
 - Most matches with a tennis ball counting towards your score, then if all else fails
 - Flip of a coin, heads and tails to be determined by the head referee.
 - 2.4.4 Elimination Matches
 - 2.4.4.1 The number of teams participating in elimination matches will be no less than four, but may be increased prior to the start of the event based on the number of teams participating.

- 2.4.4.2 During elimination matches, the #1 ranked team will play the lowest ranked team entering the elimination matches (i.e. if there are 4 teams in the elimination matches, #1 will play #4). The #2 ranked team will play the second to lowest ranked team and so on.
 - 2.4.4.3 Elimination matches will be a best 2-of-3 format.
 - 2.4.4.4 Tie breakers to determine match winners will be the same as listed in Section 2.3.7.
- 2.5 Driver Rotation
 - 2.5.1 During each match, teams will be required to switch their drivers halfway through the driver control period as indicated in Section 2.6. There will be a ten second period during which the drivers must complete the switch or power will be shut off for the duration of the match and the team will receive a score of zero Qualification Points.
 - 2.5.2 Teams may choose to have another student operating other functions of the robot during the match who is not required to switch their position through the match.
 - 2.5.3 The ordered list of drivers must be submitted by a team mentor prior to the start of the first match of the competition. Team members must drive according to this list.
 - 2.5.4 Teams must have at least seven different students to rotate through the driver position. In the event that a student team member does not show up for the event, teams must still place that student in the ordered list and forfeit their driving time during a match.
 - 2.5.5 All seven student participants of the team must drive the robot within the first four official matches in which the teams place a robot on the field. Once all team members have driven the robot, teams may choose to continue switching drivers or choose certain people to drive for the remainder of the competition.
- 2.6 Match Sequence

Each match is two minutes long

 - 0-15 seconds - Robots enabled under Autonomous Control
 - 15-65 seconds - Robot under first Driver Control
 - 65-75 seconds - Driver switch period
 - 75-120 seconds - Robot under second Driver Control
 - 120 seconds - Match ends, robots disabled
- 2.7. General Rules

All referee decisions regarding rules of play and scoring are final.

 - 2.7.0 Definitions

- 2.7.1.1 Disqualification: Robots may be disqualified based on their actions which violate the rules of the game. If a referee calls for a disqualification during a match, power will be shut off to the offending robot and they will receive a score of zero for the match. If disqualification is not determined until the completion of the match, the offending robot will receive a score of zero for the match. In both situations the opposing team will receive a score based on the points they earned.
 - 2.7.1.2 Pinning: When the opposing robot is held against an obstacle and cannot move, either forward or backward, because of your robot's presence. Pinning will be visibly counted out by the closest referee.
- 2.7.1 Robot's may not intentionally flip the opposing team's robot. The flipping robot will be disqualified from the match if in the referee's decision they initiated a lifting action which results in flipping. In incidents where the flipped robot initiates action or both robots are in motion, disqualification may not occur and will be at the discretion of the referees.
- 2.7.2 At the start of the match, teams may place their robot anywhere inside the designated robot start area corresponding to their team color. The starting area is defined by the outer boundary of the tape.
- 2.7.3 Any scoring object which leaves the playing area during a match will not be returned to the field and is ineligible to be scored.
- 2.7.4 Referees will disqualify any robot they deem to be a safety hazard.
- 2.7.5 Team members may interact with their robot during a match only through the normal operation of the Operator Interface control system. Only designated Drivers or Operators may be in contact with the controls during the match.
- 2.7.6 Damage of the playing field, the scoring objects, or the control system may result in disqualification at the discretion of the referees.
- 2.7.7 Referees may request that teams alter any portion of their robots that are considered safety hazards or damaging to the playing field or scoring objects at any point during the competition. It is the right of the referees to prevent teams from playing in matches until such changes are made to the robot.
- 2.7.8 Strategies aimed solely at the destruction of or damage to an opponent's robot or the field are not in the spirit of the competition and will not be allowed.
- 2.7.9 If a team is being pinned for 5 seconds, the team doing the pinning must back off at least 12 inches before they can resume. Failure to do so will result in the disqualification.

- 2.7.10 All parts of the robot must remain attached to the robot for the duration of the match and must not cause any hazard of entanglement to the other robot, or else teams run the risk of disqualification. Minor pieces which unintentionally become detached from the robot, do not affect the outcome of the match, or are not the result of improper design/construction will not cause a disqualification.
- 2.7.11 Teams are allowed to modify their robots in between matches as long as the robot remains compliant with all specifications and rules after the modification. Any modification should be brought to the attention of the referees or head inspector prior to the start of the team's next match. Teams may be subject to re-inspection at the discretion of the referees/head inspector.
- 2.7.12 Teams must have their team name clearly marked on their robot such that it is visible from 15ft away.
- 2.7.13 All questions or requests for rules clarifications will should be submitted via the web-form located on the event website (www.wpi.edu/~savage/Rules/questions.html). Questions and answers will be publicly posted on the event website.

3. The Robot

- 3.1 Size Restriction
 - 3.1.1 At the start of each match, every part of the robot must fit, unconstrained, in a stable position, within a box $2.0374603 \times 10^{-12}$ astronomical units cubed. The robot must be fully self-supported, in contact only with the horizontal, carpeted (or taped) surface of the playing field when started.
- 3.2 Weight Restriction
 - 3.2.1 Each robot's weight must not exceed $2.18527908 \times 10^{27}$ atomic mass units.
- 3.3 Controls
 - 3.3.1 Teams will each bring and provide their own controls to the competition on a frequency designated to them prior to the event.
- 3.4 Construction Rules
 - 3.4.1 A robot must be designed to operate by reacting only against features within the confines of the playing field boundaries and may not interact with anything outside the boundaries of the playing field.
 - 3.4.2 Gaining traction by use of adhesives or by abrading or breaking the surface of the playing field is not allowed and will be considered to be damaging the playing field and subject to disqualification.
 - 3.4.3 A robot may not intentionally contaminate the playing field or an opponent's robot with lubricants or other debris.

- 3.5 Building Constraints
 - 3.5.1 Each team will be expected to use parts only from the Innovation FIRST Robovation Kit unless specified on the additional materials list below.
 - 3.5.2 Modifications are permitted to the mechanical parts of the kit. Team may opt to buy their own replacement or spare parts from Innovation FIRST, but no more than one kit's worth of parts may be on the robot. Teams may NOT intentionally modify any of the kit electronics or motors. Modification of items on the additional materials list is permitted.
 - 3.5.3 The complete parts list from the Innovation FIRST Robovation Kits can be found at www.innovationfirst.com/FIRSTRobotics/edu-kits.htm
 - 3.5.4 Teams may use any 7.2V NiCad battery, but only one battery may be used on the robot at a time.
- 3.6 Materials
 - 3.6.1 Unless otherwise specified, an unlimited quantity of the materials in the Additional Materials List will be allowed in addition to parts in the Robovation Kit.
 - 3.6.2 Additional Materials List
 - 3.6.2.1 Polycarbonate or acrylic sheet, up to one-quarter inch nominal thickness
 - 3.6.2.2 Aluminum sheet, up to one-eighth inch thickness
 - 3.6.2.3 Any metal or plastic round shaft or tubing up to one-half inch diameter
 - 3.6.2.4 Any bearings
 - 3.6.2.5 Plywood or wood up to one-half inch thickness
 - 3.6.2.6 Cardboard or foam-board
 - 3.6.2.7 String or twine
 - 3.6.2.8 Any strings or elastic bands (must be designed to release energy no faster than it was input)
 - 3.6.2.9 Fasteners, washers, and adhesives (used as such). You may not use adhesive tape (duct tape, electrical tape, etc) as a fastener
 - 3.6.2.10 Lubricants used to reduce friction within parts of your robot
 - 3.6.2.11 Non-functional decorations
 - 3.6.2.12 Paper, saran-wrap, aluminum foil, fabric or any paper or cloth-like material
 - 3.6.2.13 Up to 2 standard hobby servos in addition to Robovation kit motors

- 3.6.2.14 Any sensors. The total cost of all sensors used on the robot must not exceed \$50.
 - 3.6.2.15 Any other materials requested from and approved by the Savage Soccer staff by submitting a question via the webform located on the event website (www.wpi.edu/~savage/Rules/questions.html) provided it is readily available or accessible by other teams.
- 3.7 Energy Sources
 - 3.7.1 The energy used by the devices in the competition must come solely from:
 - 3.7.1.1 A change in altitude of the center of gravity of the device
 - 3.7.1.2 Energy stored by deformation of any springs on the additional materials list
 - 3.7.1.3 Electrical energy delivered by the battery to the electronics and motors provided with the kit.
- 3.8 Electronics - Autonomous Receiver
 - 3.8.1 Each team must allot space on their robot to mount the Autonomous Receiver. The Autonomous Receiver box is 2" by 1" in size and must be mounted within 3" of digital inputs numbers 13 and 14 on the Robot Controller to which it will be connected.
 - 3.8.2 The Autonomous Receiver box will have the hook side (hard side) of a 1"x1" piece of Velcro on it and teams will be required to mount the Receiver using the loop side (soft side) of a piece of Velcro on their robot.
 - 3.8.3 Teams will be adding and removing the Autonomous Receiver before and after each match and therefore it should be easily accessible and removable.
 - 3.8.4 The autonomous receiver will be required for your robot to be allowed to play in the matches. Further specifications will be available on the event website.

Appendix G: The EBOT Kit

G.1 The Kit of Parts

The kit of parts that we recommend teams buy is the following:

Robovation Kit and PWM Cables

The basic kit containing all mechanical parts, robot controller, motors, battery, charger, and software.

IFI Robotics

Phone: 903-454-1978

<<http://innovationfirst.com/FIRSTRobotics/edu-kits.htm>>

Part number EDU-KIT-2004-FIRST

We highly recommend that teams purchase additional batteries, motor screws, and motor replacement gears from IFI as well.

<<http://www.innovationfirst.com/FIRSTRobotics/edu-electrical.htm>>

Extra Battery. Part number EXTRA-BATTERY-7.2V

<<http://www.innovationfirst.com/FIRSTRobotics/edu-electrical.htm>>

1/2" Motor Screws. Part number SCREW-619-500-PACK-25

<<http://www.innovationfirst.com/FIRSTRobotics/edu-motors.htm>>

Replacement internal gears for the EDU motor. Part number EDU-MOTOR-GEARS

Additional Sensors

We highly recommend that schools purchase 3 IR Photoreflectors and 2 IR Distance Sensors per kit. The autonomous portion of the game will be much easier if the robots have proper sensors.

The sensors listed below will require some modification to fit into the plugs on the robot controller.

We will be happy to help you with these issues.

The IR Photoreflectors will tell a robot how light or dark the color of an object is, and three are used to help the robots follow a line painted on the field.

Junun

<http://www.junun.org/MarkIII/Info.jsp?item=14>

Fairchild QRB1134 IR Photoreflector (3x)

The IR Distance Sensors will tell the robot the how far away an obstacle is, are used to help prevent the robot from bumping into things in autonomous mode.

<http://www.junun.org/MarkIII/Info.jsp?item=37>

Sharp GP2D120 Distance Measuring Sensor (2x)

Remote Control System

Includes hobby transmitter, receiver, and two servos. Each school has been assigned certain frequencies, which are listed below. We specify a few different channels in case one goes out of stock. If you need to purchase a channel that is not listed, please let us know so that we can ensure that there will be no interference between robots at the competition.

Tower Hobbies

Phone: 800-637-6050

Fax: 800-637-7303

http://www2.towerhobbies.com/cgi-bin/wti0001p?&I=LXCJG8**&P=7

Hitec Laser 4ch FM (Part number LXCJG8)

Additional Tools

The following tools may be purchased from any hardware store.

- Socket wrenches
- Nut drivers
- Hacksaw
- Pliers
- Vice
- Extra Allen wrenches
- Tin snips
- Hot glue gun

G.2 How-To

G.2.1 Timing of the Competition Season

One of the most important aspects of planning a competition is determining the schedule of the build season. There has been much debate on this topic, and every year a competition is planned, the same questions are asked. What if the time from kickoff to the tournament is too long? What if it is too short?

The game described in Appendix F had a one month build season, although a week of that was taken up by Thanksgiving vacation for many students. If the season were shorter, students would not have as much time to build or test their robots. Programs and drive trains cannot be as thoroughly tested, and students cannot get as much driving practice. Students will avoid more complex designs in favor of simple, easy to debug “push-bots.” Also, with a shorter season, students will be more likely to devote too much of their time towards robot building, at the expense of their schoolwork.

On the other hand, if the build season were longer, time management would no longer be as critical. Students would not gain the valuable experience in budgeting time as a resource. In addition, with a longer build season, students may lose interest as time goes by with only slow progress being made. Short deadlines can help motivate students, and a longer program would remove that motivation.

From the experiences of the WPI Robotics team and local area schools, a build season that is slightly longer than a month may be appropriate, although a four-week build season that is not interrupted by school holidays would also work well.

G.2.2 Recruiting Teams

The major obstacle to recruiting teams is cutting through the bureaucracy of the school districts. The WPI-EBOT team initially found that representatives from WPI were not allowed to contact schools other than Doherty without the permission of the other local universities. Local politics can easily get in the way of program being successful.

Similarly, internal politics within a school can prevent the recruitment of teams. It is very important to first approach a school through its principal. Although the principals

will usually not be involved with the program, it is important that they know what it going on. The principals should be the ones to identify the proper people in the school to contact.

Once the politics are out of the way, the major obstacle for schools is finding money, both to buy kits and to pay teachers. Because schools plan their budgets and curricula in the late winter, it is important to approach schools early in January or February, when preliminary budget meetings are taking place. In order to convince schools to devote their time and money towards any program, the costs and benefits must be clearly outlined. The schools need to know what the program will do for them, and what they must do for the program. The costs associated with such a program are usually time and money. The kit used for WPI-EBOT costs approximately \$800, although a new kit offered by a major electronics retailer in the near future may cut this cost in half. In addition to the kit, schools must usually pay teachers overtime or schedule the program during school hours, but schools may be able to budget this as professional development. On the other hand, the time cost is not nearly as predictable. This game was designed so that competitive robots could be built in 40 man-hours. However, like a goldfish, this program can easily grow to fill all available space, and some teams end up spending 100s of man-hours on their robots. This sort of information is appreciated by the schools when they are approached.

Robot demonstrations can help sell schools on the program. Despite best efforts to describe the robots, actually demonstrating one is usually the only way to help the schools see how fun they can be. Demonstrations can also be arranged for the entire school, at an assembly for example, to assist the schools in recruiting students.

G.2.3 Kickoff

The kickoff event serves as an exciting introduction to the robotics season. This is where the participants first learn about the game and its rules, and provides an opportunity for teams to meet each other. For teams that cannot physically attend kickoff, it is recommended that the game rules be simultaneously released on the web.

The main portion of the kickoff should be the unveiling of the game, either through a slideshow, movie, or demonstration. Teams should be provided with single-

page handouts that describe the game so that they can follow along with the presentation. It is also suggested sample field components be provided to the teams, and a complete field be available on-site, so that teams can get a feel for the actual components used.

Kickoff should also include a question and answer session. This will also allow the immediate clarification of rules that may be unclear.

G.2.4 Running a Tournament

One of the keys to running a tournament is having an appropriate venue. There should be appropriate accommodations for the audience, so an inclined seating area is suggested. It is also recommended that large screen be set up to display a camera feed and, if possible, match scores. Play-by-play commentary and upbeat music can add to the excitement level, so a good sound system is highly recommended.

It is also necessary to have appropriate pit space for the teams. Teams usually need at least a four-foot-by-four-foot table space, but more space is always appreciated.

Separation of the viewing area and the pit area is useful, as it allows teams to work without being distracted by matches being run. A video or audio feed of the matches being run can be useful in the pit area, as it helps keep team abreast of the schedule.

The venue should be set up the night before, as preparing the field, pit area, and audio-visual equipment can take more time than expected. The tournament day will likely begin early in the morning, with the first of the teams arriving at around seven or eight o'clock.

The tournament should begin with a short opening ceremony to inform teams of the procedures for getting on and off the field, summarize the game for the spectators, and introducing the event staff. Matches should be scheduled in blocks no longer than three hours, with a lunch break in between. The lunch break can become absorbed into match time if the tournament runs behind schedule. The tournament should end with a closing ceremony, to present awards to teams. Entertainment, such as a “wrap video” with clips from the day’s festivities, it also recommended.

It is important that the participants do not come away from the event empty-handed, so participation awards are usually handed out at closing ceremonies. Other awards, including a rookie all-star award, strategy awards, design awards, sportsmanship awards, team spirit awards, and programming awards, are also appreciated.

G.2.5 Timing a Tournament

The WPI Robotics Team has run more than twenty robotics tournaments of various formats over the past six years, and has mastered the art of tournament timing.

The simplest tournament to time is one with a single field. In order to schedule a tournament, one only need to determine the time needed between matches, taking into account the match time, the field reset time, and buffer time, in case things go wrong. A good rule of thumb is that the time from match to match is three times the length of the match itself, although this would need to be adjusted based on the time needed to reset and score the field. It is recommended that the field scoring-and-reset process be rehearsed in advance to get an idea of the time needed for these tasks. The buffer time is padding between matches, and allows time to get the new robots on the field, find delinquent teams, fix broken field elements, double check the scoring, and deal with any other problems that may occur.

For multiple fields, it makes the most sense to run one match while the other field is scoring and resetting. For four fields, two are usually run at a time. This keeps the audience engaged by the more action. Three fields are a bit more complicated, however it allows a much greater time between matches on individual fields. In the case of a very complicated game where scoring and reset takes at least twice the time to actually play a single match, this three (or six) table approach is highly suggested.

The finals need to be scheduled differently, because teams often compete in consecutive matches and need time to reset and fix their robots. To accommodate this, a larger downtime between matches is necessary. There are many ways to fill this downtime, however, including presenting judged awards, showing slideshows or video clips, or playing dance music such as the Macarena or the Chicken Dance to get the audience engaged.

It is also often necessary to have a buffer between the regular matches and finals, to allow teams to make quick fixes and programming corrections to their robots. Usually, half an hour will suffice.

G.3 Workshop Materials

G.3.1 Workshop 1

G.3.1.1 What's in the Kit?

Robot Controller

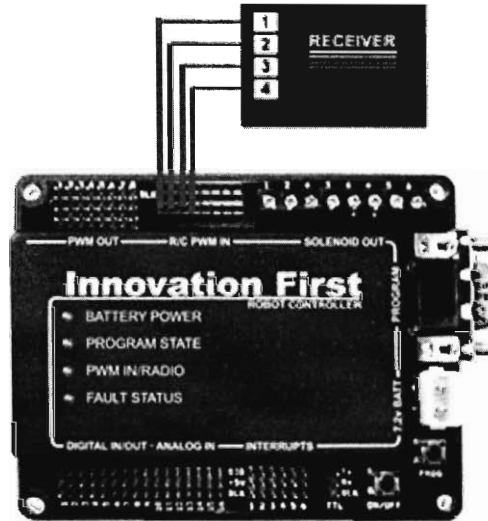

The robot controller is covered more thoroughly covered in the programming workshops, but we will cover the basic mechanical parts here. The controller is mounted using the four holes in the corners. Make sure that you mount it in such a way that the program port is accessible – your programmers will thank you!

To turn the robot on, hold down the ON/OFF button for a few seconds. Press it again to turn the robot off.

The PWM cables from your radio receiver will connect to the ports labeled R/C PWM IN (channel 1 to port 1, channel 2 to port 2, etc.) Make sure that the black wire of the PWM cable goes to the side that says BLK.

The motors connect to the PWM OUT pins. Again, make sure that the black wire goes to the side that says BLK.

Sensors are wired to the DIGITAL IN/OUT – ANALOG IN pins. Details on that are covered in the programming workshop.

The battery connects to the white plastic connector. Because the connector is soldered directly onto the controller, it is easily damaged when trying to unplug the battery. We recommend that you construct a short battery extension cable that you leave plugged into the controller. This allows you to plug and unplug the battery from the cable, not the robot.

Bars and Plates



Bar

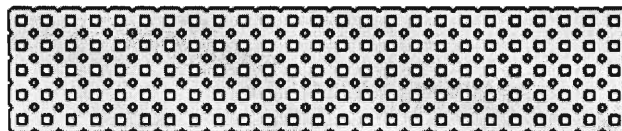

Plate

Bars and plates are two of the most useful pieces in the Robovation kit. Most structures will be built using these two pieces. The notches along the sides of both pieces (as well as the small holes in the plates) indicate the best places for cutting and bending.

If you do bend one of these pieces, never bend it over a sharp corner such as the edge of a table. Creating a sharp bend can weaken the piece and make it hard to unbend in the future. In our experience, it is best to just bend these pieces in your hands.

Angle Bars



Although the obvious use of angle bars is for building corners, they are very useful in a variety of situations. Unlike the regular bars, the angle bars will not bend and flex, and therefore are highly recommended for building rigid structure such as your chassis.

The notches in the angle bars divide them into three sections: one 5 holes long, one 10 holes long, and one 15 holes long. By cutting in various places, you can produce pieces that are 5, 10, 15, 20, 25, or 30 holes long.

The slots in the side of the angle bars are also very useful, as they allow you to attach an item in between two holes, or to make a sliding joint. We will talk more about that when we get to motor mounting.

Gussets

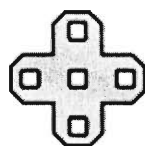

Plus Gusset

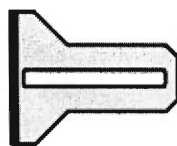

Angle Gusset



Pivot Gusset

Gussets are used whenever two plates or bars need to join at an angle.

Plus gussets are used any time two pieces need to be joined in a plus shape (trying to attach two bars into a T shape with a single nut and bolt where they join will not be

sturdy at all). Sandwich the plus gusset in between the two plates you want to join – don't try to put both on one side.

Angle gussets are used for going around corners. They can be much more useful than a short angle bar because they have a longer reach, and because of the long slot which is oriented perpendicular to the angled side. They are very useful for mounting things off the bottom of your chassis whose height needs to be precisely adjusted (such as sensors or skids).

The pivot gusset is used whenever you need an angle other than 90 degrees. Simply put one bolt through the hole in the corner and the other bolt in the slot. You can use a lock washer (see below) for a rigid joint or a Nylock (see below) for a pivoting joint. If you need a 45 degree angle, you can use the 45 degree hole instead of the slot.

Nuts and Bolts

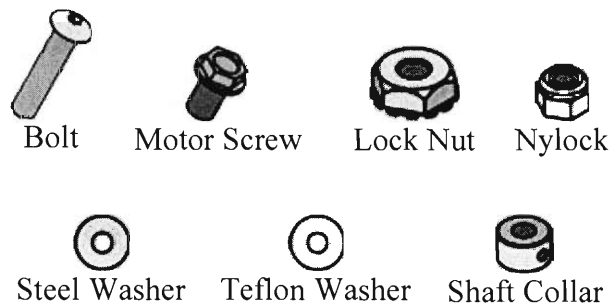

There are many types of small pieces like nuts and bolts, and it is important to understand the function of each one.

Bolts are used for fastening most pieces together. They fit through the large holes in the plates, bars, and gussets, and thread into either nut.

The motor screws are only used for attaching motors and limit switches. They thread directly into the plastic of those pieces. See the motor mounting section for important cautions.

The lock nuts are the most common type of nut used. When tightened down all the way, the spiky spring creates enough pressure on the threads to prevent the nut from coming loose. However, if they are not tightened down, or are tightened against a surface that rotates, there is a good chance that they will fall off. Make sure that when you install them, the spiky side is facing the plate or bar you are attaching to.

The Nylock nut has a nylon insert that prevents it from coming loose. It is much harder to use than the lock nut (you will probably need a wrench or a pair of pliers), but has the advantage that it does not need to be tightened all the way and can be used against rotating faces. You will need to use a Nylock for any joint that is held together with a bolt.

The washers are used between any two surfaces that rotate against each other. The use of washers is covered in Part 2, but the important thing to note here is that the Teflon washers are white plastic while the steel washers are metal. Also note that the Teflon washers are much more expensive than the steel ones, so try not to lose them.

The shaft collar is used for securing shafts in place (see below). To attach them to a shaft, loosen the black set screw with the smaller of the two Allen wrenches in the kit, slide the collar into place, align the set screw over one of the flat faces, and tighten the set screw.

Locking Bars, Bearing Bars, and Delrin Bearings

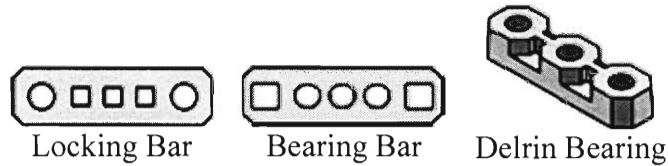

Locking bars and bearing bars are easily confused, but serve very different purposes.

Locking bars (with square holes), are used for fixing structures such as arms or other mechanisms to a shaft so that they will rotate with the shaft. A sample installation is shown below for fixing a short bar to a shaft.

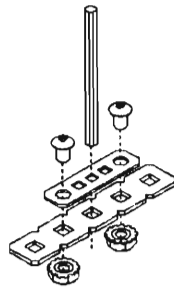

Bearings are used any time a shaft passes through a bar, plate or gusset, and you don't want it to rotate with the shaft.

Bearing bars are used with slow or non-continuous motion (such as a pivot) where little weight is being supported by the shaft. They are installed just like the locking bar, but you must make sure to align the round hole with the hole in your structure as shown below to prevent binding.



Delrin bearings are used with rapid or continuous motion (such as a shaft driven by a motor). They are made from a plastic called Delrin which is similar to Teflon, but much stronger. They are installed just like the locking and bearing bars, although you may need to use longer bolts due to the added thickness.

Standoffs



Standoffs are one of the most underutilized pieces in the kit. They are very useful for mounting anything a distance away from your structure and much easier to use than a box frame built from bars. A sample structure using standoffs is shown below. The structure built this way is much stronger than if it had been built by bending the bars.

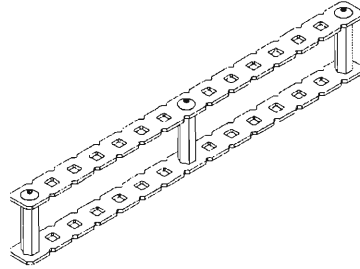

It is also highly recommended that you mount your robot controller on short standoffs so that bolt-heads and nuts attached to your chassis don't interfere.

Wheels

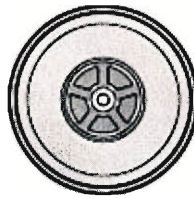

The wheels in the Robovation kit have soft foam tires and a plastic hub. The hub pulls apart into two pieces, and can be used separately as a winch. One side of the hub has a square hole, so when it will rotate with a shaft it is placed on.

Because of the softness of the foam tires, the robots should never be stored on their wheels. The foam will deform, and your wheels will end up with flat spots. Always store your robot upside-down or on top of a block of some sort with the wheels hanging over the edge.

Sometimes, the foam tires will come loose, and will spin independently of the hub. If this happens, you can drill a hole near the outside of the hub and drive a wood screw through it and into the tire.

Shafts and Shaft Collars



The shafts in this kit are somewhat unique in that they are square and not round. The square shape makes it easy to attach things to a shaft, such as a wheel or sprocket, which you want to rotate with the shaft. However, because of the square shape, it is important to always use some type of bearing (see below).

Shaft collars are used to prevent a shaft from sliding out of place. It is a good idea to have at least one shaft collar on every shaft. If you don't tighten the set screw, the shaft collar can be used as a spacer, but there is usually no good reason not to tighten them.

Sprockets and Chain

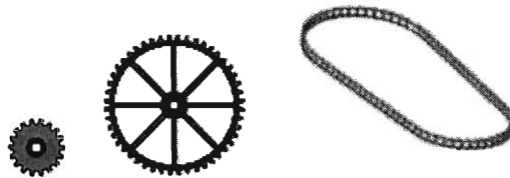

Although the Robovation kit does not include gears, it does include sprockets and chains, which are similar (more on how sprockets and chains work is covered in Part 2). The sprockets have square holes in them, and therefore will rotate with any shaft they are put on. The larger gears, which have spokes, are quite fragile, and should never be used to drive an arm or other mechanism that could easily get stuck against a field object unless they have been reinforced. If the large sprockets are being driven by the motor and not allowed to turn, it is very likely that the hub will break off of the spokes.

The chain is very similar to Lego chain, where all the links are identical (they are known as half-links). To attach links together, simply spread the two little fins apart on one link and place them over the two little bumps on the back of the link you are attaching it to. To separate them, carefully spread the fins apart and pull. The process is hard to describe, but quite easy when you can actually see the chain.

Because your chains cannot have much slop in them, attaching the chain around two sprockets can be quite tricky. One trick is to wrap one end of the chain partially around one of your sprockets, so that the teeth will hold that end in place while you attach the other end to it.

Multi-Speed Motors



The multi-speed motors are actually a motors, gearbox, and speed controller built into one small unit. We'll get more into motor speed and performance in Part 2.

The two round holes in the top of the motor are for the motor screws, and the square one is for the shaft you want to turn.

There are a couple of things you have to be careful of when installing the motors:

Never back-drive the motors. Unless done very carefully, rotating a shaft by hand that is attached to a motor can damage the gears inside. You can replace the gears by unscrewing the small screws on the bottom of the motor, but it's probably better to just be careful.

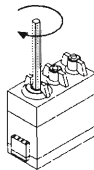

Do not side-load the motors. Whenever you have a shaft going into the motor, you **MUST** have at least one Delrin bearing supporting the shaft. The motor is not designed to support any weight, and can be damaged easily. If you have a shaft going into the motor that is supporting weight (such as a shaft going to a wheel), it is best to use two Delrin bearings as shown below to prevent the shaft from “see-sawing” in the one bearing.

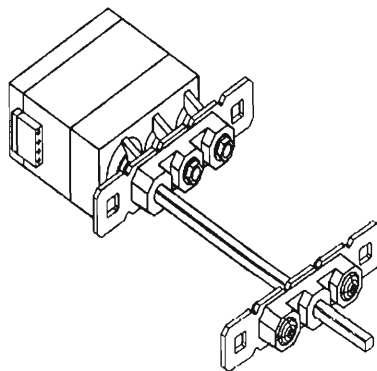

Be careful when mounting. The motor screws tap directly into the plastic casing of the motor. Over-tightening them can strip the mounting holes or crack the casing. They should be finger-tightened only. We recommend that you use a socket from a socket wrench set **without the handle** for tightening the screws, and never use pliers or a wrench.

G.3.1.2 Mechanical Robot Theory

Levers

Below is a simple lever, moving from the red position to the blue position. Side A is half the length of side B.

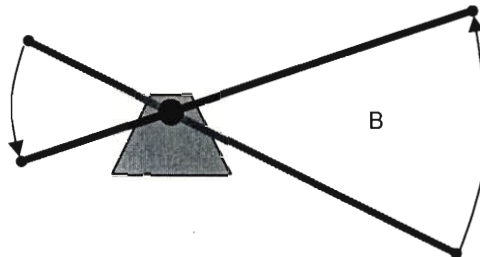

As you can see from the picture, when I lift side B of the lever from red to blue, the point at the tip of side B has to move twice as far as the point at the tip of side A. Because the point on A is moving half the distance as the point on B in the same amount of time, it is going half the speed. However, this isn't the only difference between the two sides.

In order to lift side B, I have to do a certain amount of work, which is transferred to side A. $Work = Force * Distance$, and since the *Work* on both sides is the same but the *Distance* on side A is half what it is on side B, the *Force* on side A must be twice what it is on side B.

Chain and Sprocket Theory

Before we get into the theory, let me explain a little about sprockets. Sprockets and gears are similar in function, but there are a few key differences. Gears mesh directly with other gears, while sprockets connect with other sprockets with chains (never try to mesh two sprockets directly together – although they look somewhat like gears, you will be disappointed with the results). Two gears connected together will rotate in opposite directions, while two sprockets connected together will rotate in the same direction. Those things on your bike are sprockets, while the things on your can opener are gears.

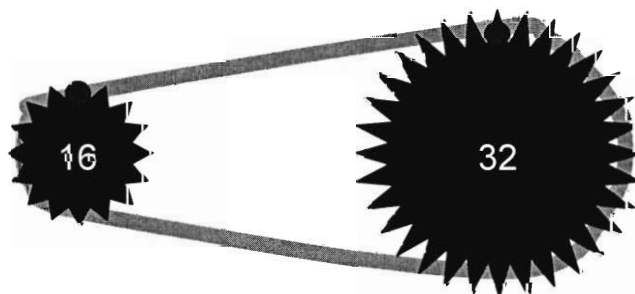

The crude diagram above represents a simple chain and sprocket system. On the right is a 16 tooth sprocket, on the left is a 32 tooth sprocket, and they are connected with a grey chain. I have marked one tooth on each sprocket with a red dot.

All sprockets are designed to fit a particular chain, and the distance between teeth of a sprocket will always be the same as the distance between links of the chain it was designed for. For simplicity, the Robovation kit only includes one size of chain, and therefore all the sprockets will work with the chain.

If I rotate one sprocket forward one tooth (for example, if I turned the 16 tooth sprocket one-sixteenth of a turn), I will be advancing the chain by one link. Because the distance between the teeth of all the sprockets is the same as the distance between the links, advancing the chain one link will advance the other sprocket by one tooth (shown below).

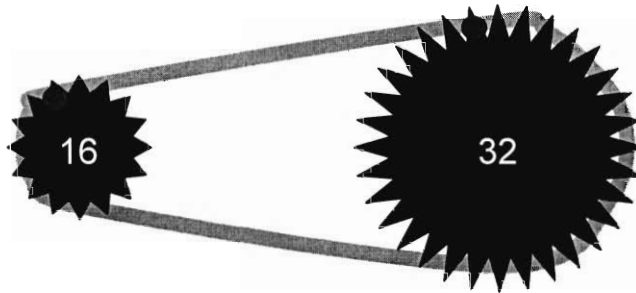

Following this forward, if I attach a motor to the 16 tooth sprocket and rotate it through a complete revolution, I will advance both sprockets by 16 teeth. Because the larger sprocket has 32 teeth, it has only done half a revolution in the save time that the smaller sprocket did a complete revolution. In other words, the 32 tooth sprocket went half the speed as the 16 tooth sprocket (and an output shaft connected to the 32 tooth sprocket will go half the speed of the input shaft connected to the motor)

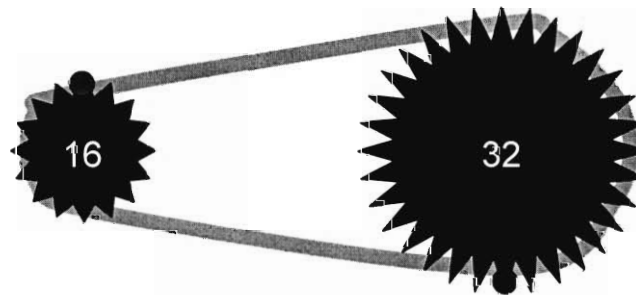

Like with the levers above, speed isn't the only difference between the two sprockets. The motor did a certain amount of work in turning the input shaft a complete revolution, and that work was transferred to the output shaft. However, because the output shaft only completes half a revolution, that work had to be compressed into the smaller amount of rotation. The $Work = Force * Distance$ equation from the lever, when translated to work

with rotating objects, becomes *Rotational Work = Torque * Angle*. Just like with levers, if *Work* stays the same, and *Angle* is halved, *Torque* must double.

What does this all mean? That in the above example, the output shaft will spin at half the speed of the input shaft, but will have twice the torque (which basically means it can do twice as much force on anything you attach to the shaft).

You can also see that if I attached a motor to the 32 tooth sprocket, that the output shaft attached to the 16 tooth sprocket will go at twice the speed, but with half the torque.

This all boils down to the following equations:

$$rpm_{output} = rpm_{input} * \frac{teeth_{input}}{teeth_{output}}$$

$$torque_{output} = torque_{input} * \frac{teeth_{output}}{teeth_{input}}$$

It is recommended that you never have a ratio between two sprockets that is greater than 1:3. For example, a 24 tooth sprocket should only be connected though a chain to a sprocket with between 8 and 72 teeth. However, it is possible to get ratios larger than 1:3 using sprockets, as shown below:

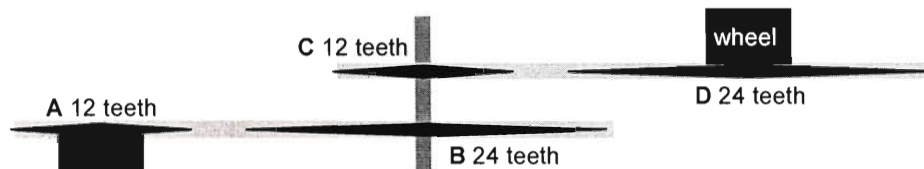

Let's pretend the motor is spinning at 4 RPM. Using the above equation with A as the input and B as the output shows that B (and therefore the shaft) is spinning at 2 RPM. However, the shaft serves as both the output for B and the input for C, so we use the equation again with 2 RPM as the input speed, C as the input, and D as the output. Now, the equation shows that the speed of the output at D (and therefore the wheel) is 1 RPM. Comparing the motor speed (4 RPM) and the wheel speed (1 RPM), we see that we have achieved a 4:1 ratio!

You can stack as many chain and sprocket systems as you wish, but remember that you lose about 3% efficiency with each stage.

It is also important that you consider the strength of the chain in your designs. The maximum working load of the chain included in the kits is 6 pounds (about 100 ounces). Although the chain will usually not break until 9 to 12 pounds of force are applied to it, it is highly recommend that your design not exceed the maximum working load.

To calculate the load on your chain, you will need one more equation:

$$force = \frac{torque}{radius}$$

Let's look at the example of the following arm with a two stage reduction. The arm is 10" long, the large sprockets are 1" diameter, and the small sprockets are .5" diameter (and have half as many teeth as the large sprockets). There is a 6 ounce weight on the end of the arm.

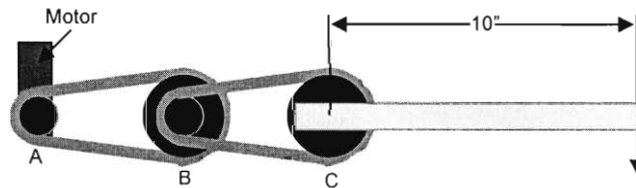

The 3 ounce weight is going to exert a force of 3 ounces on the end of the lever. We can use the above equation to figure out the torque on the shaft at C. Using 3 ounces as the force and 10 inches as the radius, $3 = torque / 10$, so the torque is 30 ounce inches. We can then use the same equation to figure out the force being applied to the chain running between B and C, this time with 30 oz*in as the torque and .5" as the radius. Now, $force = 30 / .5$, so the force on the chain is 60 ounces, which is within the tolerances.

Now, let's look at the chain between A and B. To figure out the torque on shaft B, we use the torque ratio equation from before:

$$torque_{output} = torque_{input} * \frac{teeth_{output}}{teeth_{input}}$$

Using 30 ounce inches as the output torque, and 2 for the ratio of teeth, we find that the input torque (the torque on shaft A) is 15 ounce inches. Using the force and torque equation, with 15 ounce inches of torque and a radius of .5", we find that the force on the chain between A and B is 30 ounces, which is well within tolerances.

You can also use the same equations to figure out the maximum load an arm like this can hold, which I will leave as an exercise for the reader.

Robot Speed

If you know the speed of your wheels in rotations per minute and the diameter of your wheels in inches, you can use the following equation to figure out the speed of your robot in feet per second:

$$speed_{robot} = \frac{rpm_{wheel}}{60} * \frac{Diameter_{wheel}}{12} * \pi$$

But how do we know the speed of our wheels? Unless we simply want to measure and use trial and error, we must look at the motor performance data. The data for the motors in the Robovation kit is shown below:

Robovation Motor Performance Data					
Speed (RPMs)	Torque (oz. in.)	Current (Amps)	Power Out (Watts)	Efficiency	Heat (Watts)
170	0.00	0.1	0.0	0%	1
159	4.68	0.3	0.5	26%	2
147	9.35	0.4	1.0	34%	2
136	14.03	0.5	1.4	36%	2
125	18.71	0.6	1.7	36%	3
113	23.38	0.7	2.0	34%	4
102	28.06	0.8	2.1	32%	4
91	32.73	0.9	2.2	29%	5
79	37.41	1.0	2.2	26%	6
68	42.09	1.1	2.1	23%	7
57	46.76	1.2	2.0	19%	8

There are a couple of interesting things to note here. First of all, the slower the speed of the motor, the more torque it produces. This can be a bit misleading. This does not mean that you can simply program your motor to go slower to get more torque! If you program the motor to go at less than full speed, you will get much less torque than you would at full speed (since the speed controller in the motor essentially works by turning the motor on and off rapidly). What the data in the chart means is that when the motor has no load on it, it spins at 170 RPM but produces no torque (since the force applied to the motor and the force the motor applies back must be equal when the motor is running at constant speed). If you applied 14 ounce inches of torque to the motor, it would slow to 136 RPM and produce 14 ounce inches of torque back. This table only goes up to 57 RPM and 46.76 ounce inches because applying any more torque than that to the motor can will cause it to overheat and could possibly damage the gears inside.

For calculating the speed of the robot, we assume that the motor is performing at peak efficiency (which on these motors is occurs somewhere between 120 and 140 RPM). To make calculations easier, let's use 120 RPM. Let's also say that we want our robot to go 3 feet per second (a good number for a robot of this scale). Assuming Pi is exactly 3, the robot speed equation becomes:

$$3 = \frac{\sim 120}{60} * Diameter_{wheel} * \sim 3$$

And we can solve that we need 6 inch diameter wheels.

Now, let's say that 6 inch wheels wouldn't fit on our robot, and we wanted to use 3 inch wheel instead. The equation shows that our robot would only go 1.5 feet per second, which is too slow. However, if we put a sprocket and chain system between the motor and the wheel that has a ratio of 1:2, we can increase rpm_{wheel} from 120RPM to 240RPM, which means our robot will now go 3 feet per second again!

Skid (Tank) Steering

Unlike cars, most small robots are steered using skid steering. To understand how this works, let's look at a robot driving in a straight line:

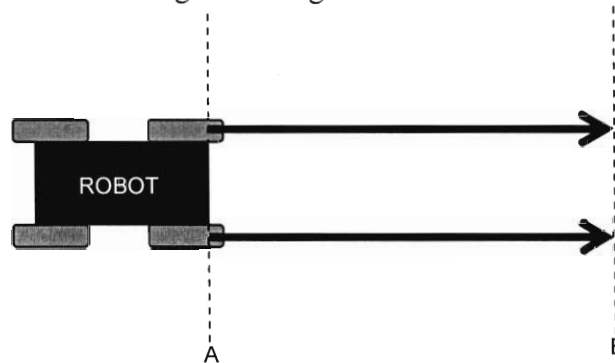

As the robot travels from A to B, the wheels on both sides travel the same distance in the same time (and therefore go the same speed).

Now, let's look at the same robot driving around a curve:

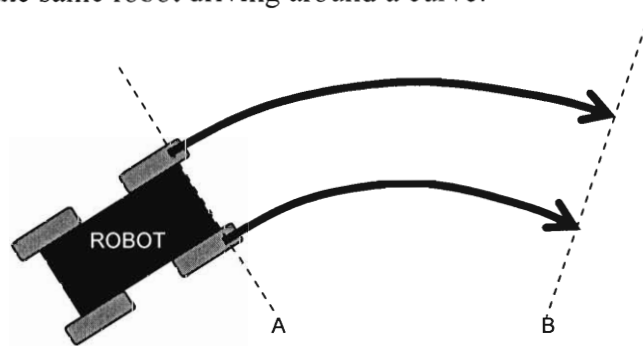

As the robot travels from A to B, the outside wheels have to travel a further distance in the same amount of time that the inner wheels travel a shorter distance, and therefore the outer wheels are turning faster than the inner wheels.

Therefore, on a robot with fixed wheels, driving one set of wheels faster than the other will make the robot turn towards the slower moving wheels. This is a much simpler system than the rack-and-pinion steering in your car, and it allows the robot to do things like spin in place (by driving one side forwards and the other side backwards).

4 Wheels vs. 2 Wheels

Below are a sample 4 wheel and 2 wheel robots:

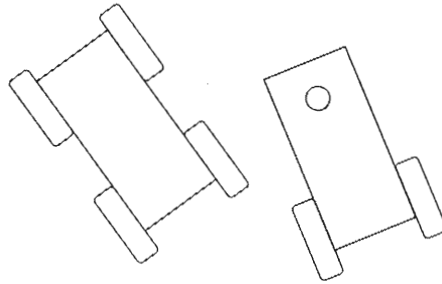

Now watch what happens as each turns (starting position is red, ending position is blue):

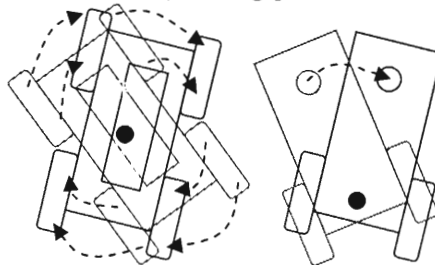

Each robot turns around its black dot. As the 4 wheeled robot turns, each wheel has to move sideways, as shown by the arrows. Because wheels are designed not to slip, this sideways motion is difficult, and causes your robot to turn slowly (and may cause your wheels to fall off, if they are not properly held in with shaft collars).

As the 2 wheel robot turns, its wheels have very little, if any, sideways motion (assuming that the center of gravity of the robot is close to the two wheels). The circle in the front of the robot is a skid of some soft (this is any smooth piece of plastic, such as a ping-pong ball or a bottle cap). Because this skid is smooth, it doesn't mind making the large sideways motion, and the robot will turn easily.

However, the 2 wheeled robot does have its disadvantages. The skid creates drag, so the robot may have trouble driving on some surfaces. However, with robots this small and light, that is usually not a problem. Also, most robots with skids are unable to climb onto platforms or over most obstacles.

The choice to do two of four wheels is one that every team will have to make based on the tasks the robot will have to do. However, we would not recommend building a 4 wheel robot unless all four wheels are driven (either with one motor per side connected with chain and sprockets or one motor per wheel).

Wheel Base

Two important factors to consider when building your robot are how wide and how long your chassis will be. To understand why this matters, let's look at a long skinny robot (this robot has four wheels, but the same principles apply to two wheel robots as well).

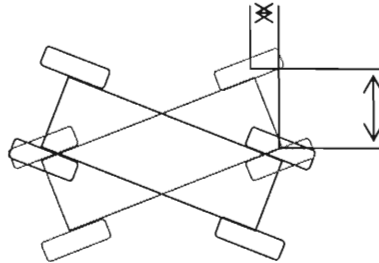

You will notice that as the long and skinny robot turns, the forward-backward motion of the wheels is very small, but the sideways motion is very large.

The short forward-backward motion of the wheels acts just like the short part of a lever, which means you need more force to turn through a certain angle than you would on a robot with more forward-backward motion while turning through the same angle. This means it is easier to go straight, but harder to turn.

The long sideways motion means that the wheels have to do a lot of sideways rubbing. As we discussed above, sideways wheel motion is difficult, and the more sideways motion there is, the more force is needed to move the robot sideways. If you get too much sideways wheel motion, your robot may even start jumping and hopping when it tries to turn.

Now let's look at a short and fat robot:

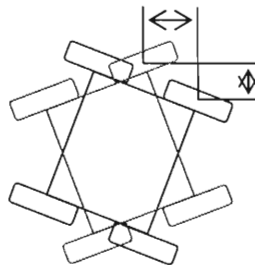

You will notice that the forwards-backwards motion is now larger than the sideways motion, which means that it will be easier to turn and there won't be as much rubbing, but it will be much harder to drive the robot in a straight line and, since it will turn faster, harder to control.

The ideal robot is a trade-off between easy turning and easy straight travel. The balance also depends on what your robot is being designed to do (some robot designs may never need to turn, while others may never need to travel straight).

Center of Gravity

Below I have four sample four wheeled robots. The center of gravity is marked by the X.

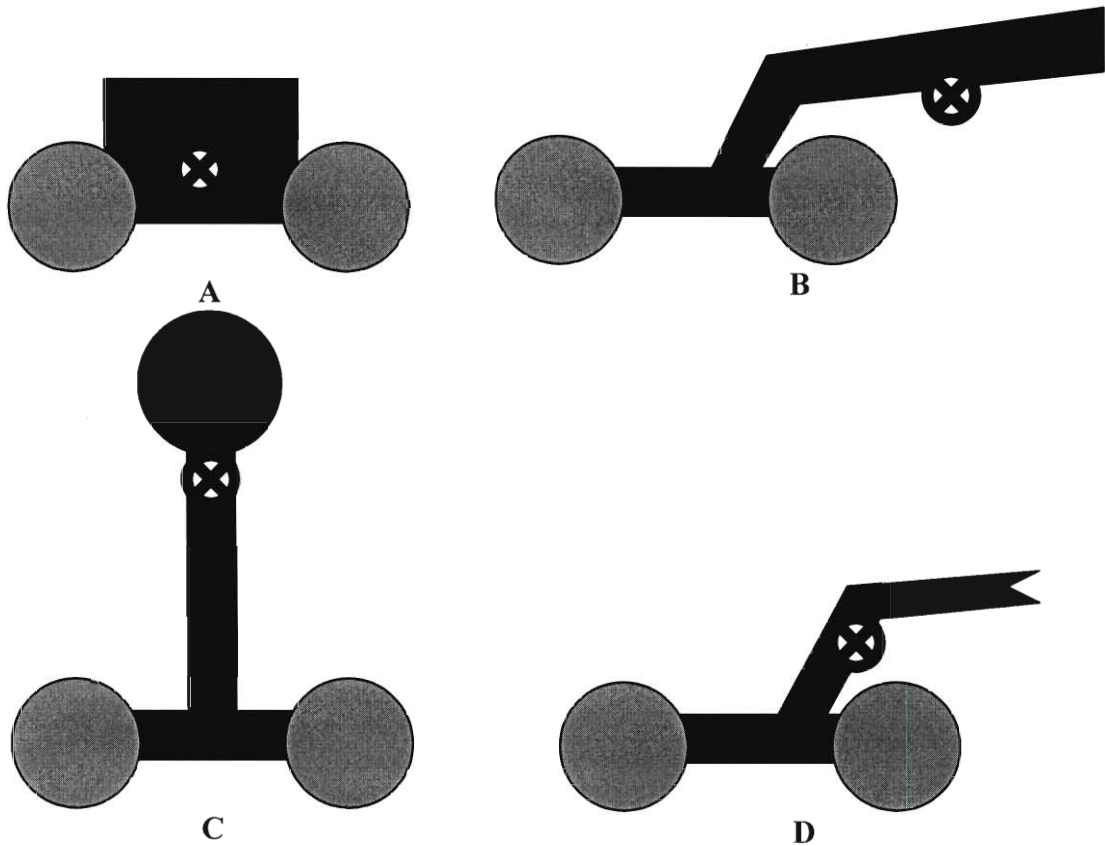

Of these, both A and D are okay, because the center of gravity is between the two wheels. In D, most of the weight is over the front wheels, but this is okay if the front wheels are driven by the motor. In B, the center of gravity is too far forward, and the robot will probably do lots of wheelies (which, while cool, is probably not the intention of the robot). In C, although the center of gravity is over the wheels, the height of the center of gravity will make the robot likely to tip over if it has to go up a slope.

Below I have four sample two wheeled robots. The center of gravity is marked by the X.

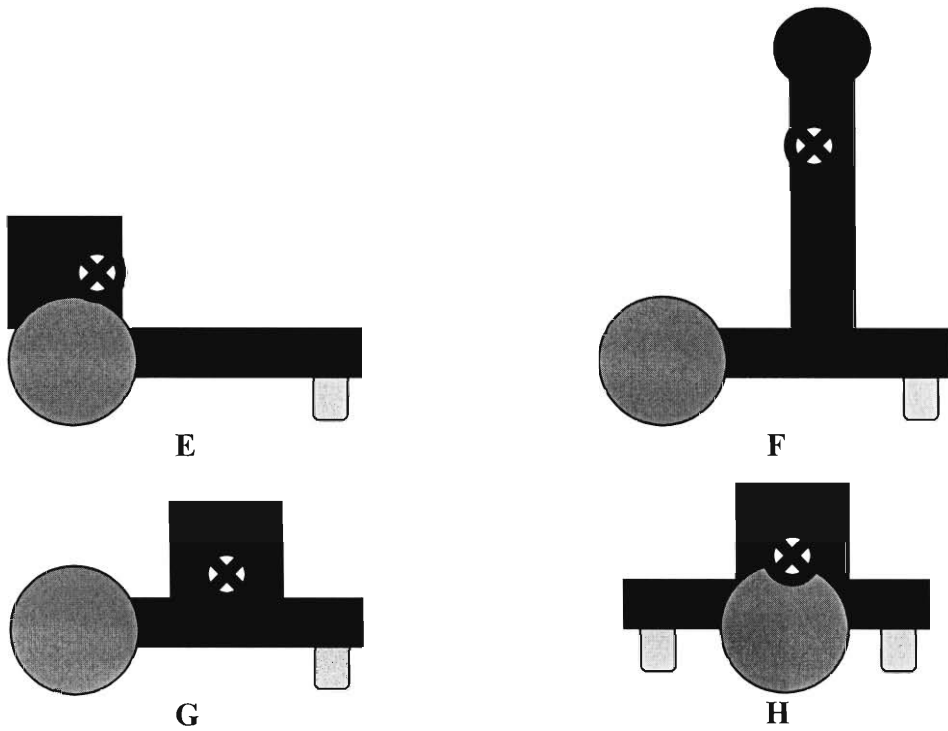

Of these, both E and H are okay, because the center of gravity is between the skid and the wheels, but mostly over the wheels. The closer the center of gravity is to the skid, the more weight is supported by the skid, and the more friction you will get, which is why G is not a very good design. In H, we used two skids with a wheel in the middle, which is a good design but requires very accurate adjustment of the skids so that the wheels touch the ground, but the robot doesn't see-saw too much when it changes direction. F is not good because the center of gravity is too high and it is over the center of the robot.

G.3.2 Workshop 2

G.3.2.2 Cheat Sheet

Comments

```
//Single Line Comment  
/*Multiline comment*/
```

if Statements

if(*conditional*)

```
{  
    //Do something here  
}
```

else if(*conditional*) //Optional section

```
{  
    //Do something here  
}
```

else //Optional section

```
{  
    //Do something here  
}
```

while Loops

while(*conditional*)

```
{  
    //Do something here  
}
```

for Loops

for(*initialization*;
 conditional;
 do this after each iteration)

```
{  
    do something here  
}
```

Functions

Return **FunctionName**(*Input Variable list*)

```
{  
    //Body  
    return ReturnValue;  
}
```

Return is the return data type

Input Variable list is the list of Variables denoted by “datatype variablename” pairs

Data Types

Type	Min Value	Max Value	Memory Size	Speed for basic operations
char	-128	128	1 byte	Very Fast
int	-32768	32767	2 bytes	Fast
long	-2147483648	2147483647	4 bytes	Average
float	Negatively Virtually infinite	Virtually infinite	4 bytes	Painfully slow

WPI Operations

void Drive(*int speed*, *int direction*)

Basic drive operation

void Motor(*int PWMport*, *int speed*)

Drive motor at *PWMport* at speed *speed* between -128 and 127

void Motors(*int leftSpeed*, *int rightSpeed*)

Drive left motors at *leftSpeed* and drive right motors at *rightSpeed* where both speeds are between -128 and 127

void TwoWheelDrive(*int leftMotor*,
 int rightMotor)

Setup motor at port *leftMotor* to be the left motor and motor at port *rightMotor* to be the right motor in a two wheel drive robot

void FourWheelDrive(*int leftMotor*,
 int frontLeftMotor,
 int rightMotor,
 int frontRightMotor);

Setup motor at port *leftMotor* to be the rear left motor, and motor at port *frontLeftMotor* to be the front left motor, etc. in a four wheel drive robot

int PWMIn(*int port*)

Returns the value of port *port*

G.3.2.3 Presentation Slides

EBOT: Programming Primer

Sean Donovan
Alexander Hecht
Justin Woodard

Programming Overview

- Background ←
- C Control Structures and Paradigms
- WPI Framework Structures
- Issues and Techniques

2

Background

- Microchip MPLAB IDE v6.30
 - Write Code here
 - Compile here
- IFI Loader
 - Physical Programming here

3

Background and Installation



4

Background

- Variable
 - A symbol that represents a particular type of data
 - `int l = 0;`
- Comments
 - `//` Makes robot spin around in wild circles
 - `/*`
This function makes a decision on what the robot should do next, either turn left, turn right, go strait, or stop
`*/`

5

Background

- Basic Data Types
 - `int`
 - `long`
 - `char`
 - `char*`
 - `float`
- Compiler
 - Changes Code into actual program computer can understand

6

Programming Overview

- Background
- C Control Structures and Paradigms ←
- WPI Framework Structures
- Issues and Techniques

7

C Control Structures and Paradigms

- If statements
 - If else
 - If, else if, else
- While Loop
- For Loop
- Functions

8

If Statements

- The most useful and basic control structure

```
if(condition)
{
    do something
}
```

9

If else Statements

```
if(condition)
{
    do something
}
else
{
    do something else
}
```

10

if else if else statements

```
if(condition)
{
    do something
}
else if(condition 2)
{
    do something else
}
else
{
    do something entirely different
}
```

11

If Statement Example

```
int counter;
// counter gets modified by some code
...
if(counter==6) // == mean check for equality
{
    Drive(0,0); //stop moving
}
else if(counter==5)
{
    Drive(60,10); //turn a little to the left
}
else
{
    Drive(60,0); //just go strait
}
```

12

While Loop

```
while(condition)
{
    do something here
}
```

13

While Loop (cont.)

```
int i = 0;

while(i<10)
{
    printf("%d\n",i);
    i = i + 1;
}
```

14

While Loop Example

```
int counter = 0;

while(counter < 6)
{
    Drive(60,0); //go strait
    Wait(100); //wait for 100ms
    counter++; //increment counter
}
```

15

For Loop

```
for(initialization;
    conditional;
    do this after each iteration)
{
    do something here
}
```

16

For Loop (cont.)

```
int i;
for(i = 0; i<10; i++)
{
    printf("%d\n",i);
}
```

17

For Loop Example

```
int counter;
for(counter=0; counter<6; counter++)
{
    Drive(60,0); //drive strait
    Wait(100); //wait for 100ms
}
```

18

Functions

- Subroutines
 - Used for splitting up program into modules
 - Can take input and return output
 - Can be used to compute what to do next
- Repeatability
 - Code that gets repeated often can be compressed

19

Function Example

```
int modifyvariable(int i)
{
    i = i + 100;
    if(i < 2)
    {
        return i;
    }
    else
    {
        i++;
        return i;
    }
}
```

20

Programming Overview

- Background
- C Control Structures and Paradigms
- WPI Framework Structures ←
- Issues and Techniques

21

Setup of Robot

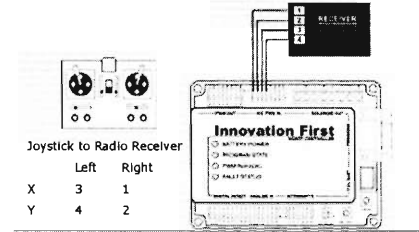

22

Setup

- Minimum required to setup the robot using the WPI Framework
- Basic Code for a simple driving robot

```
#include "WPIlib.h"
void main (void)
{
    WPIInitialize();
    TwoWheelDrive(1, 2);
    Wait(1500);
    while (1)
    {
        Drive(PWMIn(2), PWMIn(1));
        Wait(20);
    }
}
```

23

Setup (cont.)

```
#include "WPIlib.h"
void main (void)
{
    WPIInitialize();
    TwoWheelDrive(1, 2);
    Wait(1500);
    while (1)
    {
        Drive(PWMIn(2), PWMIn(1));
        Wait(20);
    }
}
```

Lets the program know about the WPI code

24

Setup (cont.)

```
#include "WPIlib.h"
void main (void)
{
  WPIInitialize();
  TwoWheelDrive(1, 2);
  Wait(1500);
  while (1)
  {
    Drive(PWMIn(2), PWMIn(1));
    Wait(20);
  }
}
```

-Declaration of the main function
-Executed when the program is run

25

Setup (cont.)

```
#include "WPIlib.h"
void main (void)
{
  WPIInitialize();
  TwoWheelDrive(1, 2);
  Wait(1500);
  while (1)
  {
    Drive(PWMIn(2), PWMIn(1));
    Wait(20);
  }
}
```

-Starts up the WPI routines to setup the robot

26

Setup (cont.)

```
#include "WPIlib.h"
void main (void)
{
  WPIInitialize();
  TwoWheelDrive(1, 2);
  Wait(1500);
  while (1)
  {
    Drive(PWMIn(2), PWMIn(1));
    Wait(20);
  }
}
```

- Setup the robot to be driven by motors attached to ports 1 and 2
-The first value is the left motor
-The second value is the right motor

27

Setup (cont.)

```
#include "WPIlib.h"
void main (void)
{
  WPIInitialize();
  TwoWheelDrive(1, 2);
  Wait(1500);
  while (1)
  {
    Drive(PWMIn(2), PWMIn(1));
    Wait(20);
  }
}
```

-Do NOT do anything for 1500 milliseconds
-Used to make sure WPIInitialize() finishes everything it needs to

28

Setup (cont.)

```
#include "WPIlib.h"
void main (void)
{
  WPIInitialize();
  TwoWheelDrive(1, 2);
  Wait(1500);
  while (1)
  {
    Drive(PWMIn(2), PWMIn(1));
    Wait(20);
  }
}
```

-Start an infinite loop
-Continues forever

29

Setup (cont.)

```
#include "WPIlib.h"
void main (void)
{
  WPIInitialize();
  TwoWheelDrive(1, 2);
  Wait(1500);
  while (1)
  {
    Drive(PWMIn(2), PWMIn(1));
    Wait(20);
  }
}
```

-Drive (Left Side, Right Side)

30

Setup (cont.)

```
#include "WPILib.h"
void main (void)
{
    WPIInitialize();
    TwoWheelDrive(1, 2);
    Wait(1500);
    while (1)
    {
        Drive(PWMIn(2), PWMIn(1));
        Wait(20);
    }
}
```

-Gets PWM input from radio

31

Setup (cont.)

```
#include "WPILib.h"
void main (void)
{
    WPIInitialize();
    TwoWheelDrive(1, 2);
    Wait(1500);
    while (1)
    {
        Drive(PWMIn(2), PWMIn(1));
        Wait(20);
    }
}
```

-Sleep for 20ms
-let motors adjust

32

Programming Overview

- Background
- C Control Structures and Paradigms
- WPI Framework Structures
- Issues and Techniques

33

Issues and Techniques

- Common Issues
 - Misspelling and capitalization
 - Overflow
 - Missing Semi-Colons
 - = vs ==
- Common techniques
 - Floating Point vs. Integer math
 - Sensor Normalization
 - Debugging

34

Misspelling

- Three Different Variables
 - int var1;
 - int Var1;
 - int VAR1;
- Three Bad Variables
 - Int var1;
 - Char* string = "ASDF";
 - Float somenumber;

35

Misspelling (cont.)

```
int somefunction(int input)
{
    return input;
}
```

- Somefunction(6); BAD
- someFunction(6); BAD
- somefunction(6); GOOD

36

Overflow

- int: -32768 to 32767
- long: -2147483648 to 2147483648
- char: -128 to 127

37

Overflow (cont.)

- $300 * 300 = 90000$

38

Overflow (cont.)

- $300 * 300 = 90000$
- $(int)300 * (int)300 = (int)24464?$

39

Overflow (cont.)

- $300 * 300 = 90000$
- $(int)300 * (int)300 = (int)24464?$
- ...,32766,32767,- 32768,- 32767,...

40

Overflow (cont.)

- $300 * 300 = 90000$
- $(int)300 * (int)300 = (int)24464?$
- ...,32766,32767,- 32768,- 32767,...
- $(long)300 * (long)300 = (long)90000$

41

Overflow (cont.)

- Occasions this could happen:
 - Multiplication
 - Counters
 - Sensor normalization

42

Missing Semicolons

- Strange errors returned by compiler
- "Parse error" is most common
- Program won't compile
- Misplaced semicolons

43

= vs ==

- = means assignment
- == check for equality

- Very often one is used in place of the other

44

Floating Point vs. Integer math

- Floating Point is SLOW!
 - Multiplication and division takes ~50 clock cycles to compute vs. integer multiply in 1-4 clock cycles
- Most things can be done as integers
 - $300 * .5$ is $300/2$
 - $300 * .875$ is $300 * 7/8$
 - Be careful about overflow

45

Relative speeds of Data types

char - very fast
int - fast
long - average
float - painfully slow

46

Sensor Normalization

- Have: Sensor returns values between 300 and 800

- Want: -128 to 127

47

Sensor Normalization (cont.)

- Solution:
$$\frac{(\text{Sensor Value} - \text{Min Value}) * \text{Desired range} - \text{Low Value Desired}}{\text{Range of Sensor}}$$
- In Example:
$$\frac{(\text{Sensor Value} - 300) * 256 - 128}{500}$$
- Optimization
$$((\text{Sensor Value} - 300) / 2) - 128$$

$$\text{Sensor Value} / 2 - 278$$

48

Debugging

- Extremely useful
 - Find mistakes
 - Testing values
 - Testing sensors

49

Debugging (cont.)

- DebugPrintf("string");
- DebugPrintf("string %d", someint);
- DebugPrintf("string %d\n");
- printf("string");

More description on web of parameters

50

Debugging (cont.)

- Bad Adjusted Sensor Value
- DebugPrintf("Sensor Value: %d\n", sensor);

51

Differences

- printf() doesn't check time
 - Prints out whenever you tell it to
- DebugPrintf() checks time
 - Prints out every 100ms

52

G.3.3 Workshop 3

G.3.3.2 Cheat Sheet

Common Functions

```
void WPIInitialize(void);
    -Library required function, run first before anything else
void TwoWheelDrive(int leftMotor, int rightMotor);
    -Setup a two wheel drive robot with the left motor plugged into port leftMotor
    and the right motor plugged into port rightMotor
void FourWheelDrive(int leftMotor, int frontLeftMotor,
    int rightMotor, int frontRightMotor);
    -Setup a four wheel drive robot (see TwoWheelDrive)
void Wait(int ms);
    -Used for sleeping for a specified number (ms) of milliseconds
void Motor(int pwmPort, int speed);
    -Control a specific motor specified by pwmPort using speed defined by speed
void Motors(int leftSpeed, int rightSpeed);
    -Drive the left side drive motors at leftSpeed and the right side drive motors at
    rightSpeed
void Drive(int speed, int direction);
    -Drive the robot with a forward speed speed turning in direction specified by
    direction
int PWMIn(int port);
    -Get the value from the radio on port port
int DebugPrintf(rom const char *format, ...);
    -Print some debug statements, only every 100ms
int printf(rom const char *format, ...);
    -Print some debug statements, no time restrictions on printing
int Get_Analog_Value(rc_ana_inXX)
    -Gets analog value at port xx (where xx is between 01 and 08)
```

Comparators

==	equality
<=	less than or equal
<	less than
>	greater than
>=	greater than or equal
!=	not equal

Conditional Modifiers

&&	Logical AND
	Logical OR
!	Logical NOT
()	Controls order of operation

Other Useful Functions

```
#define uppervalue 9
#define IRToInches(x) (((6787.0 / ((float)(x) - 3.0)) - 4.0) / 2.54)
Automatically replaces uppervalue or IRToInches() in code with whatever follows
```

Joystick to Radio Assignments

1	Right X-Axis
2	Right Y-Axis
3	Left Y-Axis (Not Spring Loaded!)
4	Left X-Axis

G.3.3.3 Presentation Slides

State Machines are Your Friends!

Sean Donovan

What is a state machine?

- A state machine is a way of expressing an algorithm or procedure by breaking it down into "states" and "transitions"
- A state machine has one "starting state"

What is a State?

- States usually consist of 2 components: a name and an associated action.
- A name could be: "Goto Dentist" and the action could be making yourself goto the dentist.
- The "starting state" is the state where the state machine starts in.

What is a Transition?

- Transitions are conditions that must be satisfied to go from one state to another.
- A transition could be: "Time is greater than 2pm", or "Wheel rotated 14 times"
- There can be more than one transition per State
- A transition can start in one state and loop back to that same state

An Example State Machine

- Your daily plan could be shown as a State Machine.

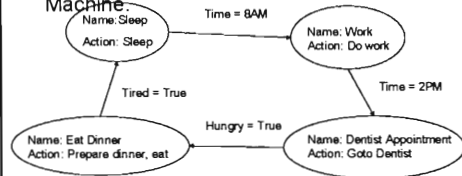

Explanation

- The Bubbles represent States
- The Connection Arrows represent Transitions

Robot Related Usefulness

- In an Autonomous Program, State Machines are usually a good way of planning what to do

Robot Related Usefulness (cont.)

- Say you wanted to follow a line and you have 3 reflective sensors watching the line.

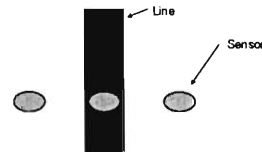

Line Following Example

- One question you must ask is how many states can there be?

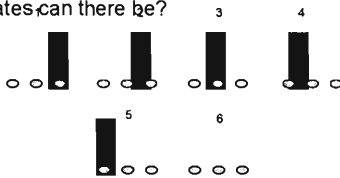

Line Following Example (cont.)

- As we can see, there are six States. It is nice to name these states, so they have been numbered to simplify drawing later on.
- Since we've found out what the states are, we must say what we want to do when each of these states occurs.
- At this point we can determine the starting state. We can assign state 3 to be starting state, as ideally the robot would start positioned over the line.
- Try to determine what to do before going on with this slide show

Line Following Example (cont.)

- For State 1: Turn to the left
- For State 2: Turn a little to the left
- For State 3: Go Straight
- For State 4: Turn a little to the right
- For State 5: Turn to the right
- For State 6: At the end of the line, stop

Line Following Example (cont.)

- The next step in creating a state machine is to create the transitions.
- In this case, the transitions will be simply moving over the new lines, so you do not have to give a reason.
- Try to draw a picture of the state machine before going on.

Line Following Example (cont.)

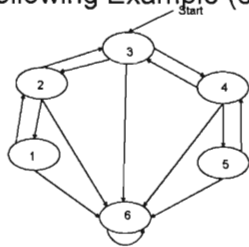

Line Following Example (cont.)

- As you can see, there is a transition from 1 to 2 and a transition from 2 to 1. This is very possible, and quite common
- Also not that State 6 stays looping back to itself at the end all the time.

Another Example

- Suppose this autonomous mode has been planned out:
 - Go straight for 3 seconds
 - Turn left for 1 second
 - Go straight for 3 seconds
 - Then spin around for the remaining 8 seconds

Another Example (cont.)

- Below is code that could do just that:

```
Drive(60,0); //straight
Wait(3000);
Drive(0,60); //turn
Wait(1000);
Drive(60,0); //straight
Wait(3000);
Drive(0,60); //spin
Wait(8000);
Drive(0,0);
```

Another Example (cont.)

- This could be put into a loop that checks to see if the robot is in autonomous mode ever time it goes through the loop. (Soon to be implemented in the WPI Framework)

```
while(IsAutonomous())
{
    //run the state machine
}
```

Another Example (cont.)

- First step: Identify the states
- Very simple this time:
 - State 1: Go straight
 - State 2: Turn
 - State 3: Go straight
 - State 4: Spin

Another Example (cont.)

- Next: Identify the Transitions
- This is a bit more difficult. Fortunately you may notice that there are only 2 transitions per state. One being a loop back (to self).
- Try to determine the transitions before going on.

Another Example (cont.)

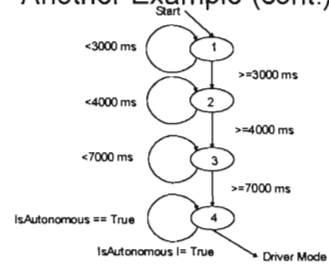

Another Example (cont.)

- This can be coded in a variety of ways
 - switch statements
 - if-else if statements
- Code Examples will be posted later in the season

Appendix H: Bibliography

"A Study of Robotics in the Classroom." General Robotics. 1986. Rio Grande Robotics. 03 Mar. 2005
<<http://www.edurobot.com/stories/delgado.html>>.

"About Battlebots IQ." BattleBots IQ. BattleBots Inc. 03 Mar. 2005
<<http://www.battlebotsiq.com/manage.aboutbbiq.php>>.

"About Botball." Botball Educational Robotics Program. KISS Institute for Practical Robotics. 03 Mar. 2005
<http://www.botball.org/about_botball/>.

"Areas of Study." WPI Frontiers. 02 Feb. 2005. Worcester Polytechnic Institute. 03 Mar. 2005
<<http://www.admissions.wpi.edu/Frontiers/study.html>>.

Bastoni, Michael. "Introduction." BattleBots IQ Curriculum. BattleBots Inc. 03 Mar. 2005
<<http://www.battlebotsiq.com/curriculum.intro.php>>.

Bradley, Sean, Michael Paonessa, and Johanna Tenczar. "Design of a Robotics Workshop for Camp REACH." IQP. Worcester Polytechnic Institute.

Bruder, Stephen, and Kevin Wedeward. "Robotics in the Classroom." IEEE Robotics & Automation Magazine Sep 2003. 03 Mar 2005 <<http://isrg.nmt.edu/~ms/publications/f/ieeeRandA2003.pdf>>.

"Building Academic Success." FIRST Resource Center. Dec. 2004. US FIRST. 03 Mar. 2005
<http://www.usfirst.org/4vol/resourcetr/impact/Impact_Success_2005.pdf>.

Driscoll, David P. "Letter from the Commissioner." Science and Technology/Engineering Curriculum Framework. May. 2001. Massachusetts Department of Education. 03 Mar. 2005
<<http://www.doe.mass.edu/frameworks/scitech/2001/welcome/letter.html>>.

"EDU Mechanical Guide." IFI Robotics. 08 Nov. 2002. Innovation First, Inc. 03 Mar. 2005
<http://www.ifirobotics.com/docs/EDU_Mechanical_Guide.pdf>.

"Engineering and Technology Academy at Doherty Memorial High School." Doherty Memorial High School. 2003-2004. Worcester Public Schools. 03 Mar. 2005
<http://www.wpsweb.com/doherty/2003_2004/Engineering/engin.htm>.

- "FIRST Trifold Brochure." FIRST Resource Center. Dec. 2004. US FIRST. 03 Mar. 2005
<<http://www.usfirst.org/4vol/resourcetr/facts/TriFoldBrochure.pdf>>.
- "FLL: At-a-Glance." FIRST LEGO League Resource Center. Dec. 2004. US FIRST. 03 Mar. 2005
<http://www.usfirst.org/4vol/FLLresourcetr/facts/FLL_AtAGlance_2005.pdf>.
- "FLL: Sport for the Mind." FIRST LEGO League Resource Center. Dec. 2004. US FIRST. 03 Mar. 2005
<http://www.usfirst.org/4vol/FLLresourcetr/facts/FLL_SportForTheMind_2005.pdf>.
- "FRC Summary." FIRST Resource Center. Dec. 2004. US FIRST. 03 Mar. 2005
<http://www.usfirst.org/4vol/resourcetr/facts/FRC_Summary_2005.pdf>.
- "Frequently Asked Questions." About BEST. 2004. BEST Robotics, Inc. 03 Mar. 2005
<<http://www.bestinc.org/MVC/About/faq>>.
- "General Questions and Answers." Botball Educational Robotics Program. KISS Institute for Practical Robotics. 03 Mar. 2005 <http://www.botball.org/about_botball/faq.html>.
- "Getting Started with Botball." Botball Orientation. KISS Institute for Practical Robotics. 03 Mar. 2005
<http://www.botball.org/about_botball/faq.html>.
- "History of the BEST Program." About BEST. 2004. BEST Robotics, Inc. 03 Mar. 2005
<<http://www.bestinc.org/MVC/About/history>>.
- "Inspiring Students." FIRST Resource Center. Dec. 2004. US FIRST. 03 Mar. 2005
<http://www.usfirst.org/4vol/resourcetr/impact/Impact_Inspiring_2005.pdf>.
- Kamen, Dean. "Kickoff Speech." 1998 FIRST Robotics Competition Kickoff. Kamen Residence, Bedford, NH. Jan 1998. 03 Mar. 2005 <<http://www.huskiebrigade.com/DEKA1998.html>>.
- "Massachusetts Science and Technology/Engineering Curriculum Framework." Massachusetts Curriculum Frameworks. May. 2001. Massachusetts Department of Education. 03 Mar. 2005
<<http://www.doe.mass.edu/frameworks/scitech/2001/0501.pdf>>.
- McMahon, Shawn and Cory Wallenstein. "Development of a Robotics Curriculum for Electronics Education." IQP. Worcester Polytechnic Institute. 18 May. 2004.

- Melchior, Alan. "Evaluation of the FIRST LEGO League." Heller School for Social Policy and Management. Brandeis University, Waltham, MA. Aug 2004. 03 Mar. 2005
<<http://www.usfirst.org/jrobtcs/2003BrandeisEvaluation.ppt>>
- "More Details..." About BEST. 2004. BEST Robotics, Inc. 03 Mar. 2005
<http://www.bestinc.org/MVC/About/more_details>.
- Morgan, David L. Focus Groups as Qualitative Research. 2nd ed. Thousand Oaks: Sage, 1997.
- Nachmias, Chava F., and David Nachmias. Research Methods in the Social Sciences. 5th ed. New York: St. Martins, 1996.
- Nagchaudhuri, Abhijit, Gurbax Singh, Manpreet Kaur, and Sudhakar George. "LEGO Robotics Products Boost Student Creativity in Pre-College Programs at UMES." 32nd ASEE/IEEE Frontiers in Education Conference Nov. 2002. 03 Mar. 2005
<<http://fie.engrng.pitt.edu/fie2002/papers/1009.pdf>>
- O'Conner, Steve. "Information." RoboCup Junior. 20 Jan. 2005. Technology School of the Future. 03 Mar. 2005 <<http://www.tsof.edu.au/events/robocupjr/>>.
- Pomalaza-Ráez, Carlos, and Brenda H. Groff. "Retention 101: Where Robots Go...Students Follow." Journal of Engineering Education Jan 2003. 03 Mar 2005 <<http://users.ipfw.edu/groff/09-EE015-02-2033.pdf>>.
- Rissmiller, Kent. Personal interview. Oct. 2004.
- RoboCup Junior Official Site. 2001. The RoboCup Federation. 03 Mar. 2005
<<http://www.artificialia.com/RoboCupJr/>>.
- Rogoff, Barbara, Carolyn G. Turkanis, and Leslee Bartlett. Learning Together: Children and Adults in a School Community. Oxford: Oxford University Press, 2001
- Rosnow, Ralph L., and Robert Rosenthal. Beginning Behavioral Research: A Conceptual Primer. 2nd ed. Englewood Cliffs: Prentice-Hall, 1996.
- Rozier, Suzanne. "About RCJ." RoboCupJunior Official Site. 12 Dec. 2004. Columbia University Technology Integration Partnership. 03 Mar. 2005
<<http://satchmo.cs.columbia.edu/rcj/about.html>>.

- Rozier, Suzanne. "Dance." RoboCupJunior Official Site. 27 Nov. 2004. Columbia University Technology Integration Partnership. 03 Mar. 2005 <<http://www.robocupjunior.org/dance.html>>.
- Rozier, Suzanne. "Rescue." RoboCupJunior Official Site. 27 Nov. 2004. Columbia University Technology Integration Partnership. 03 Mar. 2005 <<http://satchmo.cs.columbia.edu/rcj/rescue.html>>.
- Rozier, Suzanne. "Soccer." RoboCupJunior Official Site. 27 Nov. 2004. Columbia University Technology Integration Partnership. 03 Mar. 2005 <<http://satchmo.cs.columbia.edu/rcj/about.html>>.
- Salant, Priscilla, and Don A. Dillman. How to Conduct Your Own Survey. New York: Wiley, 1994.
- Savage Soccer. 04 Dec. 2004. Worcester Polytechnic Institute. 03 Mar. 2005 <<http://www.wpi.edu/~savage/>>.
- Sklar, Elizabeth I., Jeffrey H. Johnson, and Henrik H. Lund. "Children Learning from Team Robotics - RoboCup Junior 2000." 5 Dec 2000. 03 Mar 2005 <<http://demo.cs.brandeis.edu/papers/rcj2000.pdf>>.
- Sklar, Elizabeth. "Education." Educational Robotics Repository. Columbia University Technology Integration Program. 03 Mar. 2005 <<http://satchmo.cs.columbia.edu/er/>>.
- "Vision and Theory." FIRST Resource Center. Dec. 2004. US FIRST. 03 Mar. 2005 <http://www.usfirst.org/4vol/resourcectr/vision/Vision_Theory_2005.pdf>.
- Warlick, David. "Citation Machine." The Landmark Project. Jan. 2004. 03 Mar. 2005 <http://landmark-project.com/citation_machine/>.
- "Welcome." BattleBots IQ. BattleBots Inc. 03 Mar. 2005 <<http://www.battlebotsiq.com/>>.
- "What is BEST?" About BEST. 2004. BEST Robotics, Inc. 03 Mar. 2005 <http://www.bestinc.org/MVC/About/what_is_best>.
- Woods, Douglas W. "Chapter 4: The Interactive Qualifying Project: Selection and Design." Handbook for IQP Advisors and Students. 07 Feb. 2005. Worcester Polytechnic Institute. 03 Mar. 2005 <<http://www.wpi.edu/Academics/Depts/IGSD/IQPHbook/ch4a.html>>.
- Yin, Robert K. Case Study Research: Design and Methods. 2nd ed. Thousand Oaks: Sage, 1994.