



March 7, 2015

Renewable Energy Resources:

Tidal and Jet stream Energies

An Interactive Qualifying Project Report completed in partial fulfillment of
the Bachelor of Science degree at Worcester Polytechnic Institute.

Submitted by:

Dale LaPlante

Iordanis Kesisolgou

Yuchen Wang

Submitted to:

Worcester Polytechnic Institute (WPI)

Professor: Mayer Humi

Mathematical sciences

Abstract

This report examines various energy resources to ensure that humanity has ample supplies for future use. Fossil fuels are forecast to be depleted within a century, and the world's search for new technologies and sources (such as fracking) continues to negatively impact the environment. This report outlines various alternative energy sources available with focus on jet stream and tidal energy. Our goal is to survey the current state of the world's energy basket and develop visionary suggestions for the future.

Table of Contents

Abstract.....	2
Table of Contents.....	3
Graphs and Figures.....	6
Executive Summary.....	14
Chapter 1: Fossil fuels.....	16
1.1 Natural Gas.....	16
1.1.1 Cost, consumption, and supply.....	16
1.1.2 Environmental Impact.....	19
1.1.3 Conclusion.....	21
1.2: Oil.....	23
1.3 Coal.....	32
Chapter 2: Renewable energy.....	36
2.1 Nuclear energy.....	36
2.2: Helium 3.....	38
2.2.1 What is Helium 3.....	38
2.2.2 Supply and price of Helium 3.....	43
2.2.3 Demand of Helium 3.....	45
2.2.4 Uses.....	47
2.3 Solar Energy.....	48
2.3.1 Introduction.....	48
2.3.2 Data analysis of the current solar energy usage.....	49
2.3.3 The cost of solar energy.....	53
2.3.4 New technology and better use of solar energy.....	55

Interactive Qualifying Project

2.3.5 Conclusion and summary	56
2.4 Bio-Fuel.....	57
2.4.1 Definition.....	57
2.4.2 How to grow algae and make it fuel.....	63
2.4.3 The cost of bio-fuel from Algae	63
2.4.4 Environmental Impact	71
2.4.5 Case Study	74
2.5: Others	76
2.5.1 Heat Engines.....	76
2.5.2 The Stirling engine	80
2.5.3 Hydroelectric	86
Chapter 3: Proposed energy source.....	92
3.1 Jet Stream	92
3.2 Tidal Energy	107
3.2.1 Introduction	107
3.2.2 Tidal Steam Generator.....	107
3.2.3 Tidal Barrage	110
3.2.4 Dynamic Tidal Power.....	113
3.2.5 Tidal Energy Project in the Bay of Fundy	119
3.2.6 Sihwa Tidal Power Plant	126
3.2.7 La Rance Tidal Power Plant	131
3.2.8 Swansea Bay Tidal Lagoon	137
3.2.9 Tidal Energy Potential in the World.....	144
3.3 Current Energy	148
3.3.1 Overview of Resources.....	148

Interactive Qualifying Project

3.3.2 Resources In-Depth	152
3.3.3 Turbines	156
3.3.4 Theoretical Modeling	159
3.3.5 Conclusions	163
3.4 Social implication.....	166
Chapter 4: Conclusion.....	180
4.1 Conclusion.....	180
4.2 Recommendation for future IQP.....	182
4.3 References	184

Graphs and Figures

Chapter 1: Fossil fuels	16
1.1 Natural Gas.....	16
1.1.1 Cost, consumption, and supply.....	16
Figure 1.1.1: U.S Natural Gas production from 1990 to 2035 showing an increasing shale gas ¹	16
Table 1.1.1: World’s total gas reserves: 6,846 trillion cubic feet ²	17
Figure 1.1.2: World’s total gas reserves: 6,846 trillion cubic feet ²	17
Figure1.1.3: Natural Gas Cost per Bushel of Corn Processed at Iowa Ethanol Plants ³	18
1.1.2 Environmental Impact	19
Figure 1.1.4: U.S Natural Gas Total Consumption ⁴	20
Figure 1.1.5: Natural Gas Consumption 1965-2011 ⁶	20
1.1.3 Conclusion.....	21
Figure 1.1.6: The Gas and Oil consumption in Europe ⁷	21
Figure 1.1.7: EU-Natural Gas Production, Consumption and Net Imports 1970-2009 ⁸ ...	22
1.2: Oil.....	23
Figure 1.2.2: Evolution of the diesel and gasoline demand in the EU ¹¹	24
Figure 1.2.3: Global demand by product for the years 2006 and 2030 ¹²	24
Figure 1.2.4: Oil and Natural Gas Import reliance of major economies projected to change rapidly in 2014	25
Figure 1.2.5: International Energy Outlook by the U.S 2013 ¹³	26
Figure 1.2.6: Crude oil supply and demand since 1994 to present day ¹⁴	27
Figure 1.2.7: Yearly percentage change of oil demand from 1987 to present day ¹⁴	28
Figure 1.2.8: The US production and import of crude oil ¹⁷	31

Interactive Qualifying Project

1.3 Coal	32
Table: 1.3.1: Reserves per Country.....	32
Figure 1.3.1 Usage and future perspective of fossil fuel ¹⁸	33
Chapter 2: Renewable energy	36
2.1 Nuclear energy	36
Figure 2.1.1: Reactor flow simulation ²⁰	37
2.2: Helium 3.....	38
2.2.1 What is Helium 3.....	38
Table 2.2.1: Comparison of neutronicity of reactions ²¹	41
Figure 2.2.1: The reaction rate of He-3 with different temperature ²²	42
2.2.2 Supply and price of Helium 3.....	43
Figure 2.2.2 Size of Helimu-3 stockpile, 1990-2010 ²³	44
2.2.3 Demand of Helium 3	45
Figure 2.2.3 Projected Helium-3 Demand, 2009-2018 ²³	46
2.2.4 Uses	47
2.3 Solar Energy.....	48
2.3.1 Introduction	48
2.3.2 Data analysis of the current solar energy usage	49
Figure 2.3.1 Total U.S electricity generation by energy source in billion kilowatt hours ²⁵	50
Figure 2.3.2 Additions to electricity generation capacity in the commercial sector in two cases in Gigawatts ²⁵	51
Figure 2.3.3: Electricity generation from solar power in eight cases in billion kilowatt hours ²⁵	53
2.3.3 The cost of solar energy.....	53

Interactive Qualifying Project

Figure 2.3.4 Falling price of utility-scale solar photovoltaic projects ²⁶ 54

2.3.4 New technology and better use of solar energy..... 55

2.3.5 Conclusion and summary 56

2.4 Bio-Fuel..... 57

2.4.1 Definition..... 57

Figure 2.4.1: The production of biodiesel in block diagram form. ³¹ 57

Figure 2.4.2: Schematic of energy production in the form of gas from biodiesel 58

Figure 2.4.3: Comparison of Bioethano/Corn and Petrol Oil Prices over the years (1975-2010). ³⁴ 60

Figure 2.4.4: Nm Vs Rpm of Diesel Cons in Biofuel ³⁵ 61

Figure 2.4.5: Power Vs engine speed between different Biofuels and Diesel Oil ³⁵ 61

Table 2.4.1: Physical and chemical specifications of the vegetable oil fuels used ³⁶ 62

2.4.2 How to grow algae and make it fuel..... 63

Figure 2.4.6: Algae oil production system ³⁷ 63

2.4.3 The cost of bio-fuel from Algae 63

Figure 2.4.7: Details of biofuel harvesting cost. ³⁹ 64

Figure 2.4.9: DOE projections of costs for biofuel from MTG, pyrolysis, and FT routes. ⁴⁰ 66

Figure 2.4.10: Projected cost reductions for biofuel from pyrolysis oil. ⁴⁰ 67

Figure 2.4.11: Baseline costs for algal fuel. ⁴⁰ 68

Figure 2.4.12: Projected future algal fuel costs. ⁴⁰ 69

Table 2.4.2: Overall Average Fuel Price ⁴¹ 70

Table 2.4.3: Oil Yield in Gallons per Crop ⁴² 70

Table 2.4.4: Algae has far greater oil yield per acre than conventional crops, making it ideal for land-scarcity ⁴³ 71

Interactive Qualifying Project

2.4.4 Environmental Impact	71
Figure 2.4.13: Algae-based ethanol has a far smaller carbon footprint than most other fuels. ⁴⁶	72
Figure 2.4.14: Algae takes nutrients from waste as well as bacteria and uses it to grow..	73
2.4.5 Case Study	74
Figure 2.4.15: A 1-acre algae pond in Karratha, Western Australia. ⁵⁰	74
2.5: Others	76
2.5.1 Heat Engines.....	76
Figure 2.5.1: Heat engine ⁵²	76
Figure 2.5.2: Heat exchanger	77
Figure 2.5.3 Thermal and Hydraulic machine equations ⁵³	79
Figure 2.5.4: Heat Engines ⁵⁴	79
2.5.2 The Stirling engine	80
Figure 2.5.5: Electric Power Generation By external Combustion engine (Stirling Engine) ⁵⁵	80
Figure 2.5.6 Stirling Engine ⁵⁶	81
Figure 2.5.7: Naming the parts of the device.....	82
Figure 2.5.8: Charging our now using a Stirling device	82
Figure 2.5.9: Temperature of Ocean water ⁵⁸	84
Figure 2.5.10: How much energy can a Stirling device produce? ⁵⁶	85
Figure 2.5.11: Sea water Stirling Device Model.....	86
2.5.3 Hydroelectric	86
Figure 2.5.12: Levelized cost of various energy sources. ⁵⁹	88
Figure 2.5.13: Wave/tidal pipeline capacity for 2010-2015 ⁶¹	90
Figure 2.5.14: Hydroelectric power sources and their estimated/actual power output. ⁵⁸ .	91

Interactive Qualifying Project

Figure 2.5.15: Energy Pie in EU ⁶²	91
Chapter 3: Proposed energy source.....	92
3.1 Jet Stream	92
Figure 3.1.1: The four Jet streams flow paths 2 subtropical and 2 Polar.....	92
Figure 3.1.2: Photo on the Temperature difference around the globe and the Jet streams. ⁶⁴	93
Figure 3.1.3: The cycle of a flight of the kite with its eight shaped cycles ⁶³⁷	94
Figure 3.1.4: The parts of the STEM and its pulleys	95
Figure 3.1.5: The carousel ⁶⁹	97
Figure 3.1.6: Graph of the density of the air Vs its Kinetic energy extraction rate	100
Figure 3.1.7: Usage of a kite for making long journeys more economically. ⁷²	101
Figure 3.1.8: The flying wind turbines. ^{73, 74, 75}	102
Figure 3.1.9: Image of Magenn rotating helium filled balloon.....	103
Figure 3.1.10: Floating Wind Turbines detailed schematic. ⁷⁷	104
Figure 3.1.11: “Pushing” air down to the earth	104
Figure 3.1.12: Schematic of a turbine lifted in the sky with the use of a kite	106
3.2 Tidal Energy	107
3.2.1 Introduction	107
3.2.2 Tidal Steam Generator.....	107
Figure 3.2.1: The world’s first commercial-scale and grid connected tidal stream generator ⁸¹	108
3.2.3 Tidal Barrage	110
Figure 3.2.2: An artistic impression of a tidal barrage. ⁸¹	111
3.2.4 Dynamic Tidal Power.....	113
Figure 3.2.3: Top-down view of a DTP dam. ⁸¹	114

Interactive Qualifying Project

Figure 3.2.4: Schematic of a way that tidal energy can be converted into useful energy. ⁸²	115
Figure 3.2.5: The Push Plates	116
Figure 3.2.7: The THAWT device	117
Figure 3.2.8: The “Searaser Pistons”	119
3.2.5 Tidal Energy Project in the Bay of Fundy	119
Figure 3.2.9: Hopewell Rocks, Bay of Fundy, New Brunswick, Canada ⁸⁸	120
Figure 3.2.10: High and low tide at Bay of Fundy ⁸⁸	121
Figure 3.2.11: Turbine used by Altantis ⁸⁹	122
Figure 3.2.12 Design proposed by Minas Basin Pulp and Power Co. Ltd. ⁸⁹	123
Figure 3.2.13: Illustration of the turbine proposed by Open Hydro ⁸⁹	124
Figure 3.2.14: Illustration of the generator from Black Rock Tidal Power ⁸⁹	125
3.2.6 Sihwa Tidal Power Plant	126
Figure 3.2.15 Location of Sihwa Tidal Energy Plant ⁹⁰	127
Figure 3.2.16: Design of the Sihwa tidal plant 1 ⁹¹	129
Figure 3.2.17: Design of the Sihwa tidal plant 2 ⁹¹	129
Figure 3.2.18: The tidal bulb design for Sihwa tidal power plant . ⁹¹	130
3.2.7 La Rance Tidal Power Plant	131
Figure 3.2.19: Location of La Rance Tidal Power Plant ⁹³	131
Figure 3.2.20: La Rance estuary ⁹⁴	132
Figure 3.2.21: Design of La Rance Tidal Power plant 1 ⁹³	133
Figure 3.2.22: Design of La Rance Tidal Power plant 2 ⁹³	133
Figure 3.2.23: Design of La Rance Tidal Power plant 3 ⁹³	134
Figure 3.2.24: Design of the powerhouse for La Rance Tidal Power Plant ⁹³	134
Figure 3.2.25: Illustration of simple effect ebb generation ⁹³	135

Interactive Qualifying Project

3.2.8 Swansea Bay Tidal Lagoon	137
Figure 3.2.27: Location of Swansea Bay Tidal Energy Plant ⁹⁵	138
Figure 3.2.28: Air view map of Swansea tidal energy plant ⁹⁵	139
Figure 3.2.29: Construction of bund for tidal lagoon ⁹⁵	140
Figure 3.2.30: The structure of powerhouse for tidal lagoon ¹¹⁸	141
3.2.9 Tidal Energy Potential in the World.....	144
Figure 3.2.33: Worldwide ocean power installed capacity ⁹⁸	145
3.3 Current Energy	148
3.3.1 Overview of Resources.....	148
Figure 3.3.1: Strongest ocean currents worldwide. ⁹⁹	149
Figure 3.3.2: Ocean currents with power densities greater than 0.5 kW/m ² at 50m depth ¹⁰⁰	150
Table 3.3.1: Average power per area information for each region. ¹⁰⁰	151
3.3.2 Resources In-Depth	152
Figure 3.3.3: Average power density of each region in relation to depth. ¹⁰⁰	152
Figure 3.3.4: Areas with power density higher than 0.5 kW/m ² in relation to distance from nearest land ¹⁰⁰	153
Table 3.3.2: Percent of ocean area that have a given bottom depth for areas of 0.5 and 1.5 kW/m ²	153
Figure 3.3.5: Areas with power density higher than 0.5 kW/m ² in relation to sea floor depth ¹⁰⁰	154
Figure 3.3.6: Short-term cost of selective ocean current turbine. ⁹⁹	155
Figure 3.3.7: Long-term cost of tidal/stream power in UK, with comparisons. ¹⁰¹	155
3.3.3 Turbines	156
Table 3.3.3: Most feasible ocean turbines based on capacity and status ^{128, 131, 130, 121, 129, 124}	159

Interactive Qualifying Project

3.3.4 Theoretical Modeling	159
Table 3.3.4: Maximum number of Deep Green turbines that can be placed at given depths/currents	161
Table 3.3.5: United States subsidies for energy in 2007 and 2010 ¹⁰⁶	163
3.3.5 Conclusions	163
Figure 3.3.8 Illustration of Gulf Stream speeds	165
Figure 3.3.9: Illustration of Gulf Stream speeds given geographic location and depth. ¹¹²	165
3.4 Social implication.....	166
Table 3.3.1: Estimated construction costs for existing and proposed tidal barrages.	168
Table 3.5.2: Cost Comparison Summary ¹³⁹	169
Figure 3.5.1: Regional Net Gross Value Added for South West of England and Wales (£ billion) across high, central and low scenarios for each scheme ¹¹⁶	170
Table 3.5.3: Summary of regional jobs created for each scheme, central scenario ¹¹⁶	171
Figure 3.5.2: Net jobs per scheme for the construction phase realized in the region ¹¹⁶	174
Table 3.5.4: GVA and employment impacts during lagoon operation ¹⁰²	176
Table 3.5.5: Summary of GVA and employment impacts ¹⁰²	177
Chapter 4: Conclusion.....	180
4.1 Conclusion.....	180
4.2 Recommendation for future IQP	182
4.3 References	184

Executive Summary

The current state of energy in the world has been a source of growing concern among many economists, environmentalists, governments, and citizens. It is no secret that the majority of the world has grown alarmingly dependent on fossil fuels over the years. With evidence of global warming and other adverse environmental effects rising, our dependency on these energy sources has come into question, and people are seeking answers. Moreover, fossil fuels are finite resources. We are discovering reserves at a rate that will satisfy the energy needs of the world for years to come, however it is crucial that we prepare an infrastructure for renewable energy before these reserves run out. If we fail to do so, the transitional period will undoubtedly be chaotic and perhaps even fatal.

This report investigates a number of different energy supplies. First, it outlines consumption and supply of fossil fuels in the world today, as well as the technology used to retrieve this fuel and the cost of doing so. It then looks into a number of alternative energy solutions that have been proposed or implemented all around the world, and analyzes their cost, effectiveness, and overall feasibility. It also selects two significant energy sources and goes into great detail to show how they could be used to solve future energy needs, or at the very least contribute to the solution. These two sources are jet stream wind energy and current/tidal ocean energy.

Tidal and current energy are highly plausible resources for future energy needs. The ocean contains a massive amount of energy that humanity has barely tapped into so far. There is enough energy in the ocean to meet the world's energy needs, however the majority of this is inaccessible. This is due to many limiting factors of the ocean such as massive depths and great distances to shore (making installation, maintenance, and power transfer difficult). Despite these difficulties, there is still a large amount of ocean energy attainable. By selecting the most desirable locations and concentrating installation there, the energy taken from ocean currents and tides is not only feasible but also extremely affordable. Turbines do come at a high installation

Interactive Qualifying Project

cost, however these investments almost always pay off with the competitively priced, clean energy they produce.

The jet stream is a layer of the atmosphere that holds high velocity wind currents. These streams have been used for years by pilots to assist them in flying, giving them powerful winds to ride on. These winds can also be used to harvest energy. Unlike normal wind energy, the jet stream is unusually high up, requiring specialized turbines in order to reach it. These have been in testing for many years now and the results are extremely promising. Like the ocean, the jet stream has enough theoretical potential energy to supply the world's energy needs. However this is again limited by our ability to gather such energy, as it is in such an inconvenient location. Despite the challenges the jet stream provides, some experimental turbines have reported obtaining energy at a very cost effective rate. This means that, like ocean energy, jet stream energy could be gathered at competitive prices while keeping the Earth clean.

Our conclusions for this project are that both ocean and jet stream energy are highly feasible alternative energy resources. We suggest both governments and private sectors to begin making the switch to these energies over fossil fuels, as they could easily provide clean, renewable energy without any real change to price. While there are obstacles to overcome, we have already seen commercial ocean energy operations successfully providing electricity at prices competitive with fossil fuels. While jet stream energy is still primarily non-commercial at the moment, it has the potential to become a prevalent contributor to the world's energy basket. The energy in these resources is plentiful, available, and affordable. It is now only a matter of investment and time before we make some real progress with renewable energy.

Chapter 1: Fossil fuels

1.1 Natural Gas

1.1.1 Cost, consumption, and supply

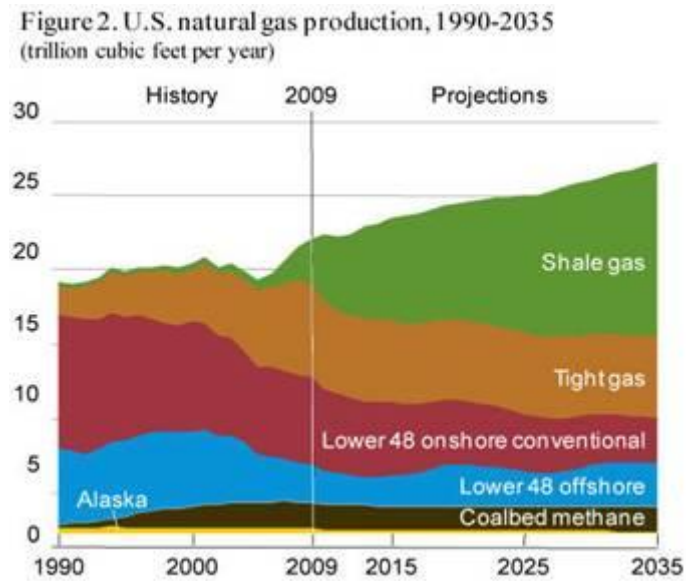

Figure 1.1.1: U.S Natural Gas production from 1990 to 2035 showing an increasing shale gas¹

Country	% Gas reserves
Russia	25
Iran	15.6

Interactive Qualifying Project

Qatar	13.4
Turkmenistan	3.95
Saudi Arabia	3.92
United states	3.64

Table 1.1.1: World's total gas reserves: 6,846 trillion cubic feet²

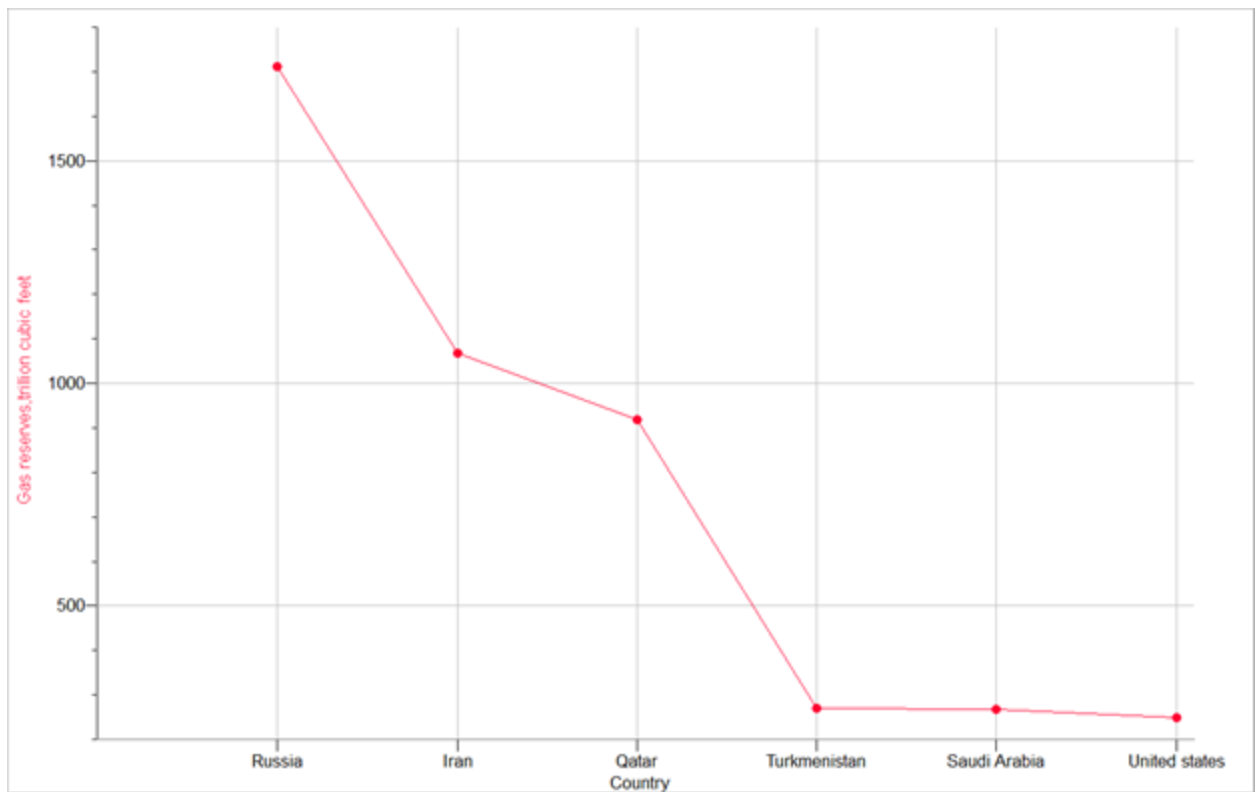

Figure 1.1.2: World's total gas reserves: 6,846 trillion cubic feet²

New technology allows us to extract more gas out, such a process is called horizontal drilling hydraulic fracturing or fracking.

Figure 3. Natural Gas Cost per Bushel of Corn Processed at Iowa Ethanol Plants, 01/27/07- 02/10/2011

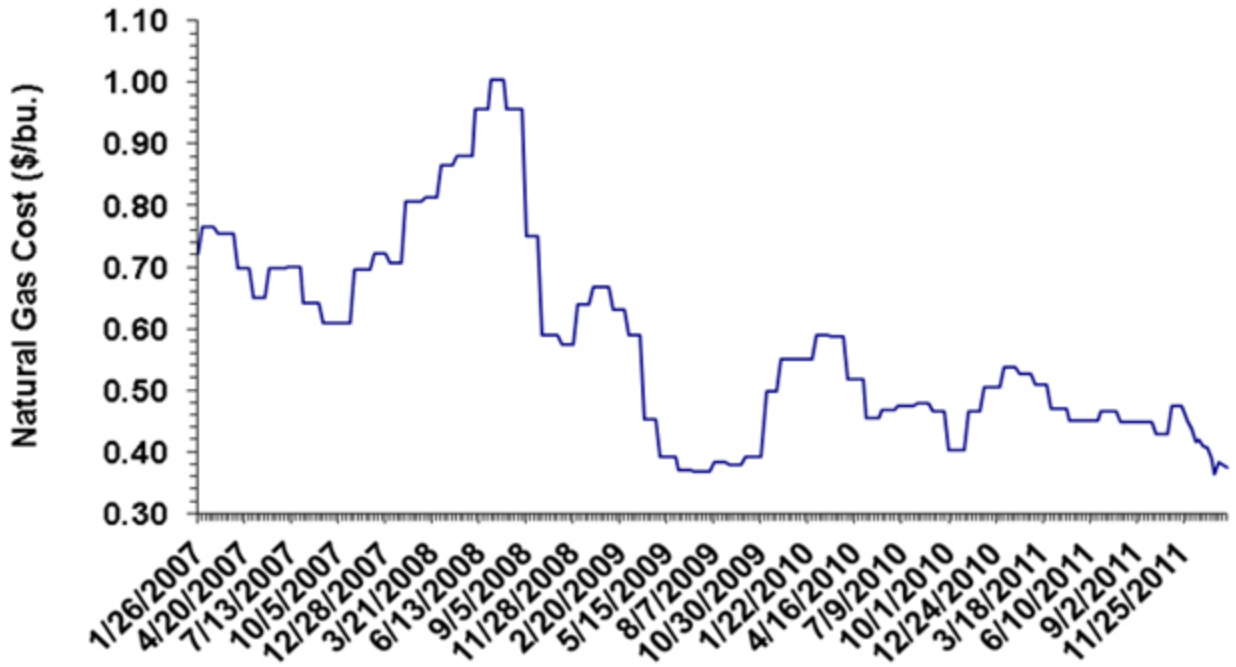

Figure1.1.3: Natural Gas Cost per Bushel of Corn Processed at Iowa Ethanol Plants³

“According to EIA natural gas in the US will last for 92 more years. If we think that US is one of the biggest countries we can assume that similar results will apply for the rest of the world.”⁴

This gives a hope for a system based on these resources of energy to be created in the future. In such a system gas can be used as an electricity additive. This would be important in order to sustain a constant electric output as the renewable energy resources are not available all the time; such as solar energy during the night.

“The low cost of gas can increasingly substitute oil and coal until we switch completely towards renewable energy resources. Other people are scared that such a cheap solution will prevent a move towards the more expensive renewable energy resources. Nevertheless, their costs have been decreasing as time passes as many times local governments finance loan

programs for the “cheaper “ construction of these structures and in the same way people can apply for relevant low-interest loans.”⁵

1.1.2 Environmental Impact

Gas has lower CO₂ emissions compared to coal and oil; Up to 49% for NO_x and up to 90% for particulates fewer emissions than gasoline. Thus, there is a great need to start substituting coal and oil with gas especially for transportation. Natural gas can be used as a fuel for cars in its liquid form when liquefied (LNG) or if compressed instead of oil. But having gas in the car creates another great problem; in case of a car accident the gas tank may explode creating even greater pollution and greater probability for life losses. In addition, methane is a significant greenhouse gas, can leak from gas pipes and lead to even greater pollution to the environment at a rate 2.4% according to EPA measurements.

Fracking is used with both oil and natural gas to increase the amount of recovery by extracting gas and oil from “rock formation at great depth in the Earth up to 20,000 ft and in formations not previously economically feasible like shale” ‘which is the least economically attainable due to its low energy density. Due to fracking the gas reserves of USA have doubled in the last decade’.

Fracking can cause pollution of the water close to the surface as it disposes “chemical additives and the waste water has highly corrosive salts, carcinogens like benzene, and other naturally occurring radioactive elements, like radium found deep in Earth”. EPA (2010) and MIT verifies such claims. In addition, there is a good belief that these chemicals can penetrate the shallow fresh water zones but nothing is verified. In addition, the use of fossil fuels has good fatality and health costs.

Interactive Qualifying Project

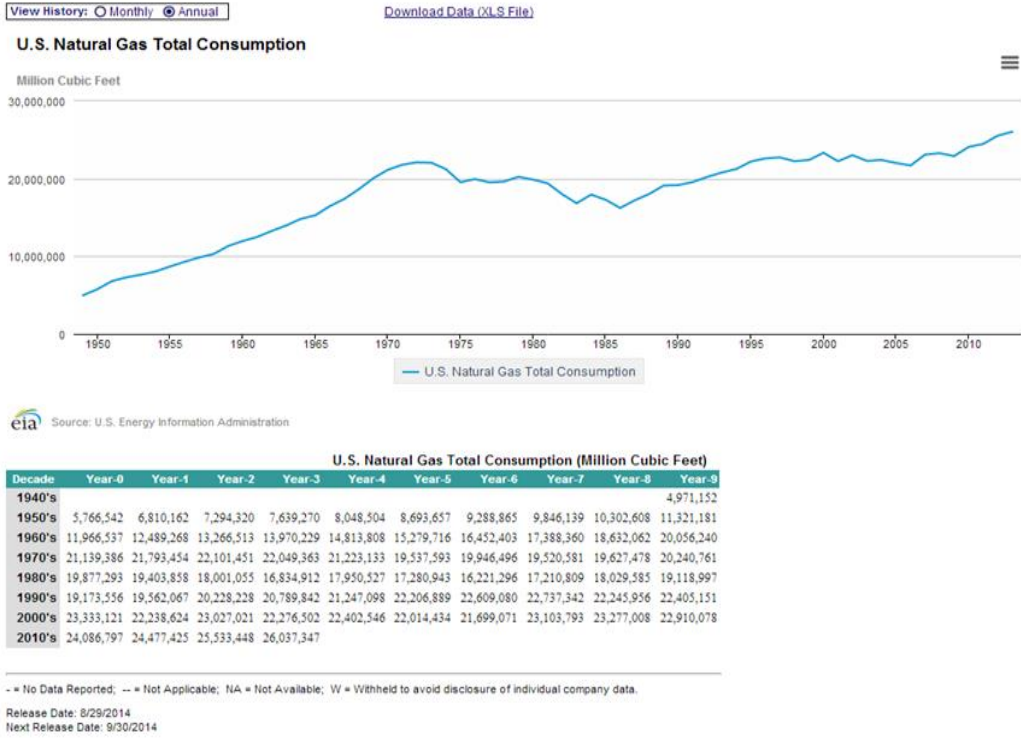

Figure 1.1.4: U.S Natural Gas Total Consumption⁴

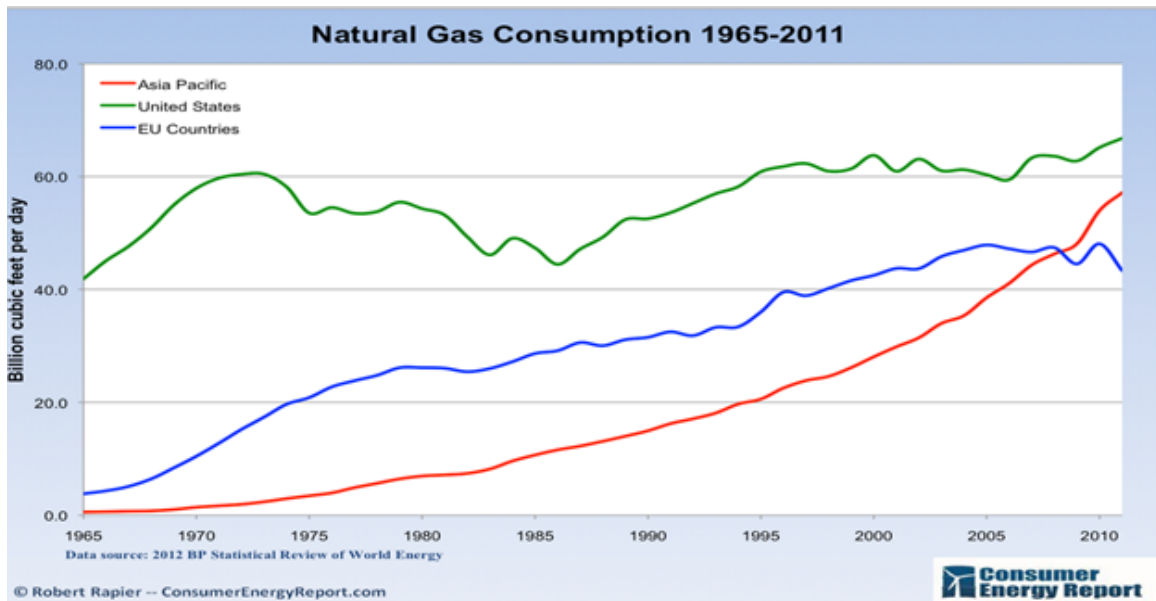

Figure 1.1.5: Natural Gas Consumption 1965-2011⁶

1.1.3 Conclusion

We need to realize that we cannot use the same technology and energies sources we need to change. The technology has reached appoint where energy resources of higher energy is demanded. As we move towards over consumption of these non-renewable resources we pollute and distract the life on Earth. The Gas of the lower cost of production and of lower pollution rate is just a temporary solution. The renewable resources though of lower energy efficiency cannot be a totally used to cover our needs yet. For this reason, we need to improve the technology more so that we can utilize these resources at a much higher degree and be able to have an energy basket of renewable resources that can possibly complement each other; when one is out of availability the other to be in abundance. Another important issue is the ability to store energy for a long period of time by either converting it to other forms or be able to reallocate fast enough.

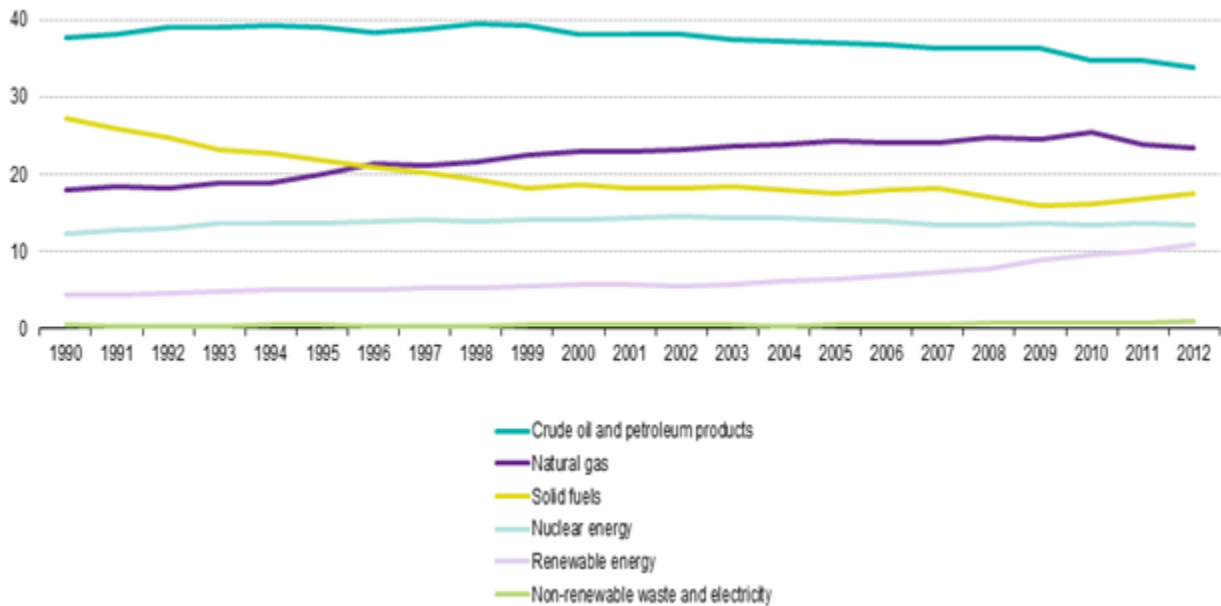

Figure 1.1.6: The Gas and Oil consumption in Europe⁷

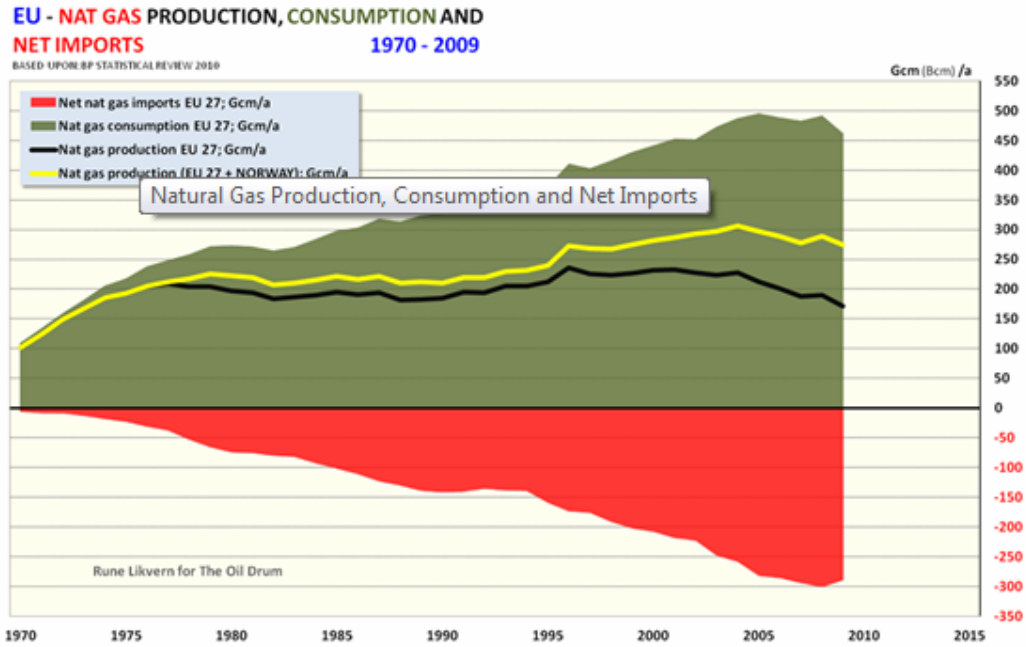

Figure 01: The diagram shows developments in EU's natural gas consumption, net imports (inclusive of imports from Norway) and production from EU and EU + Norway.

Figure 1.1.7: EU-Natural Gas Production, Consumption and Net Imports 1970-2009⁸

June 4, 2012

Russia Still Has Most Gas, U.S. Second, China Third

By Editors

Figure 2.1 ▷ Remaining recoverable gas resources in the top fifteen countries, end-2011

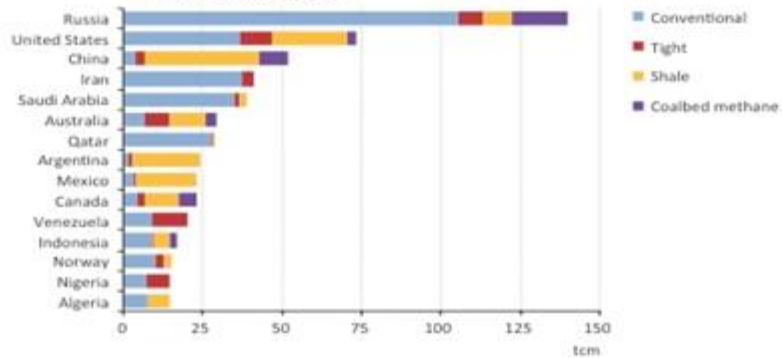
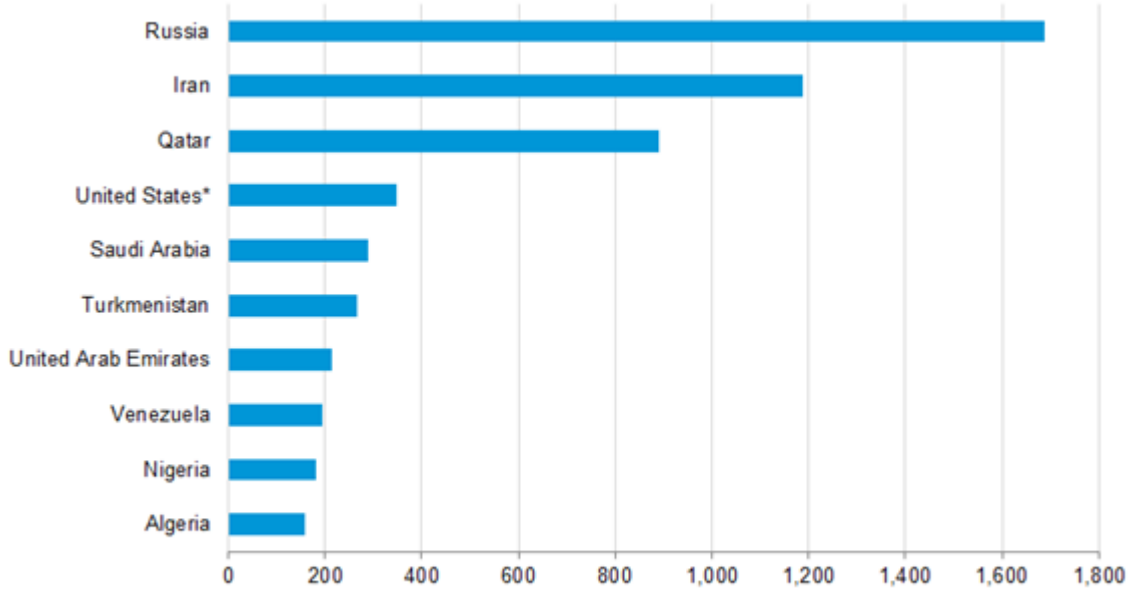

Figure 1.1.8: World's Gas reserves 06/04/2012⁹

Largest proven natural gas reserves holders
trillion cubic feet



 Note: The United States reserves are wet gas reserves as of December 2011
Source: United States: U.S. Energy Information Administration; Other Countries: Oil and Gas Journal 2013

Figure 1.1.9: World’s Gas reserves 2013, fracking is not taken under account¹⁰

1.2: Oil

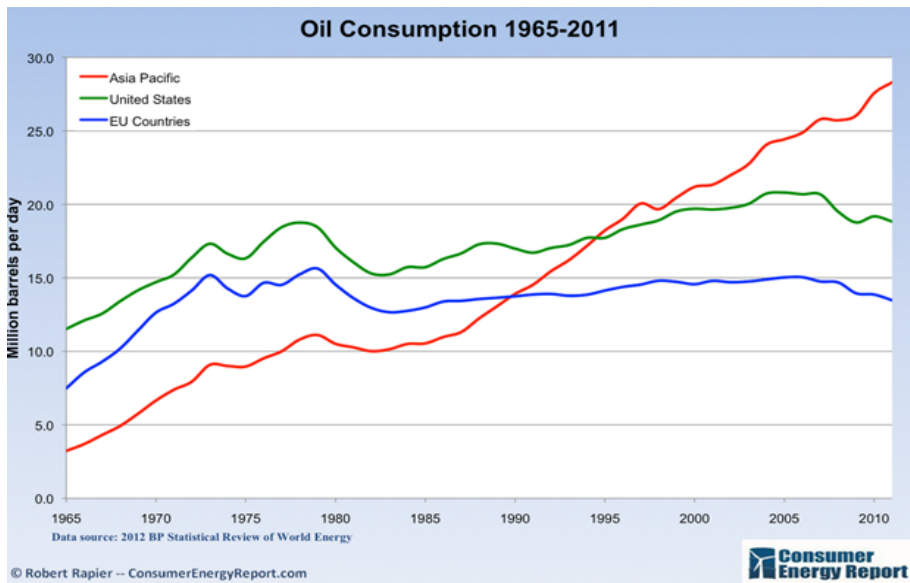

Figure 1.2.1: Oil production in Asia US and EU¹⁰

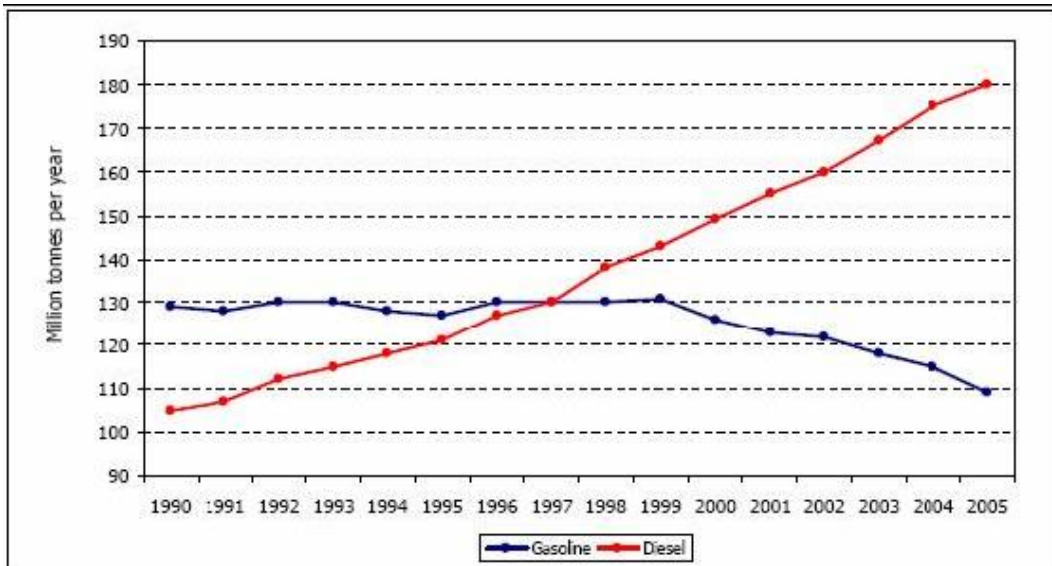

Figure IV. Evolution of the diesel and gasoline demand in the EU
 Source: Eurostat (historical data)

Figure 1.2.2: Evolution of the diesel and gasoline demand in the EU¹¹

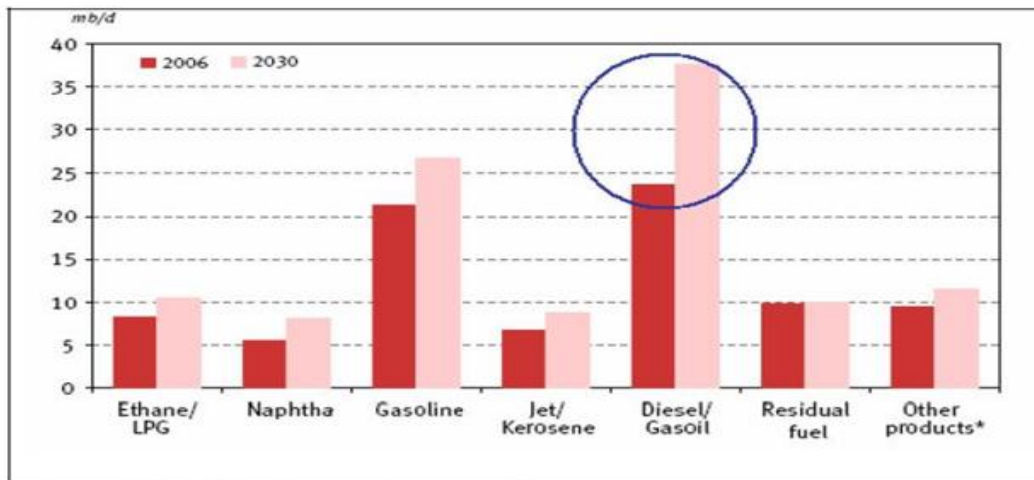
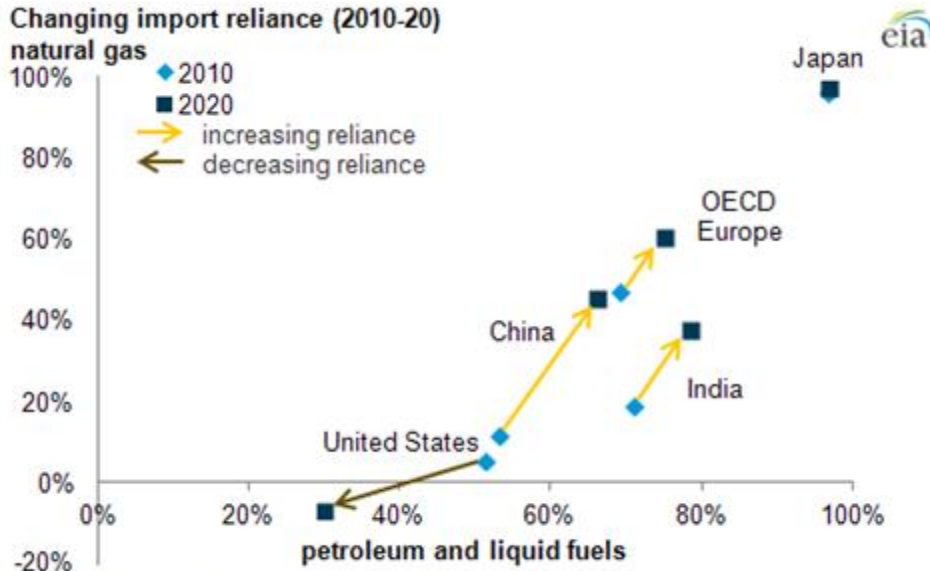

Figure VII: Global demand by product
 Source: OPEC World Oil Outlook, 2008

Figure 1.2.3: Global demand by product for the years 2006 and 2030¹²

JANUARY 22, 2014

Oil and natural gas import reliance of major economies projected to change rapidly



Source: U.S. Energy Information Administration, 2013 International Energy Outlook (IEO) and 2014 Annual Energy Outlook (AEO) Early Release for U.S. projections

Note: Import reliance is expressed as (imports-exports)/consumption for the United States and (consumption-production)/consumption for other countries and regions as we do not project gross import/export values in the IEO. While this analysis focuses on the mid-term 2020 timeframe, IEO projections extend to 2040. Chart recreated based on a Bloomberg New Energy Finance graphic using International Energy Agency data.

Republished September 9, 2014, updated to include OPEC Africa oil production.

Figure 1.2.4: Oil and Natural Gas Import reliance of major economies projected to change rapidly in 2014

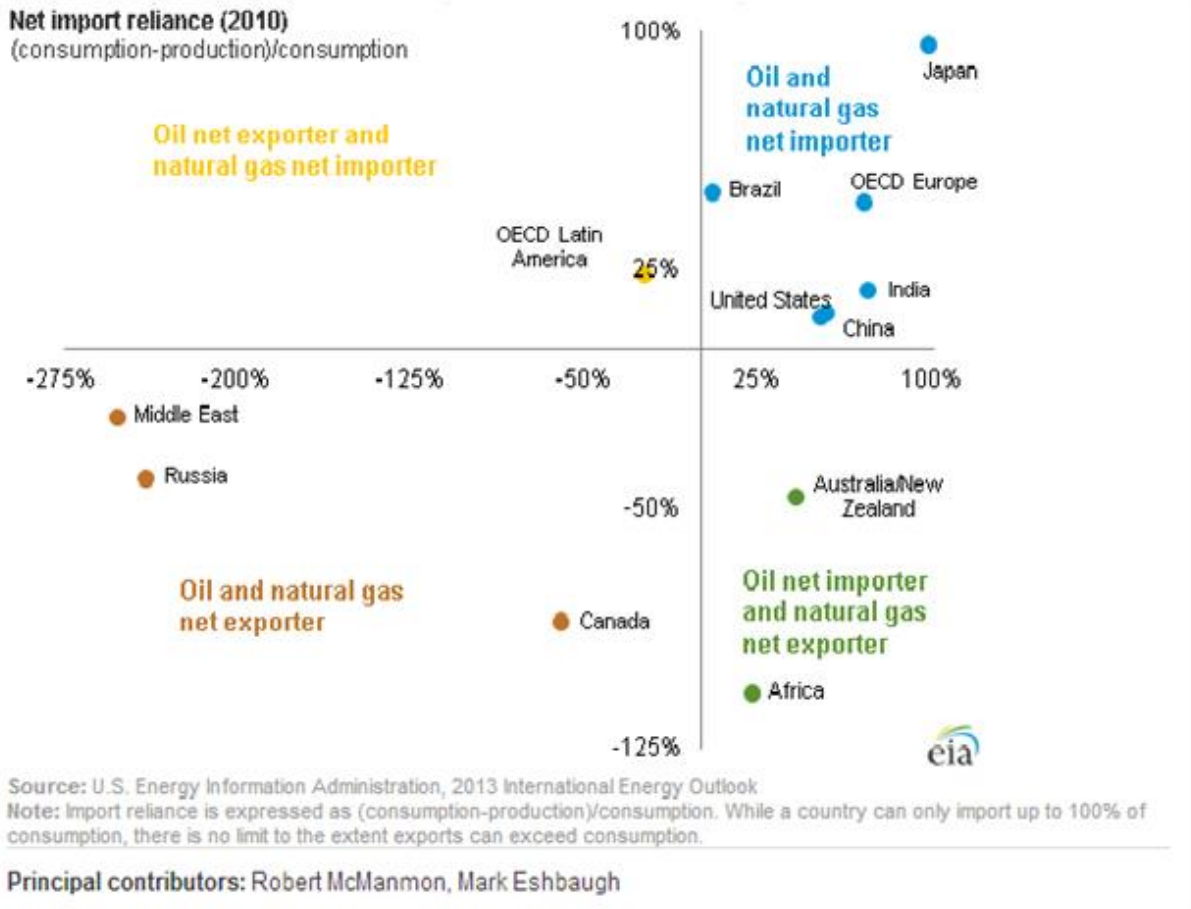

Figure 1.2.5: International Energy Outlook by the U.S 2013¹³

World oil demand has been steadily increasing in a linear fashion since 1994. Fortunately, supply has increased in a similar fashion so as to accommodate the growing need. In 1994 the Oil Market Intelligence (OMI) placed the global demand for oil at about 68 million barrels a day. At the same time, they estimated the global supply for oil to be around 66 million barrels a day. These numbers vary slightly from the US Department of Energy's estimates, but by no more than about 1 million barrels. Since 1994, the demand and supply for oil has increased by nearly 50%. As of July this year, the global demand for oil (as measured by the OMI) has reached nearly 93 million barrels per day, with the supply being around 90 million¹⁴.

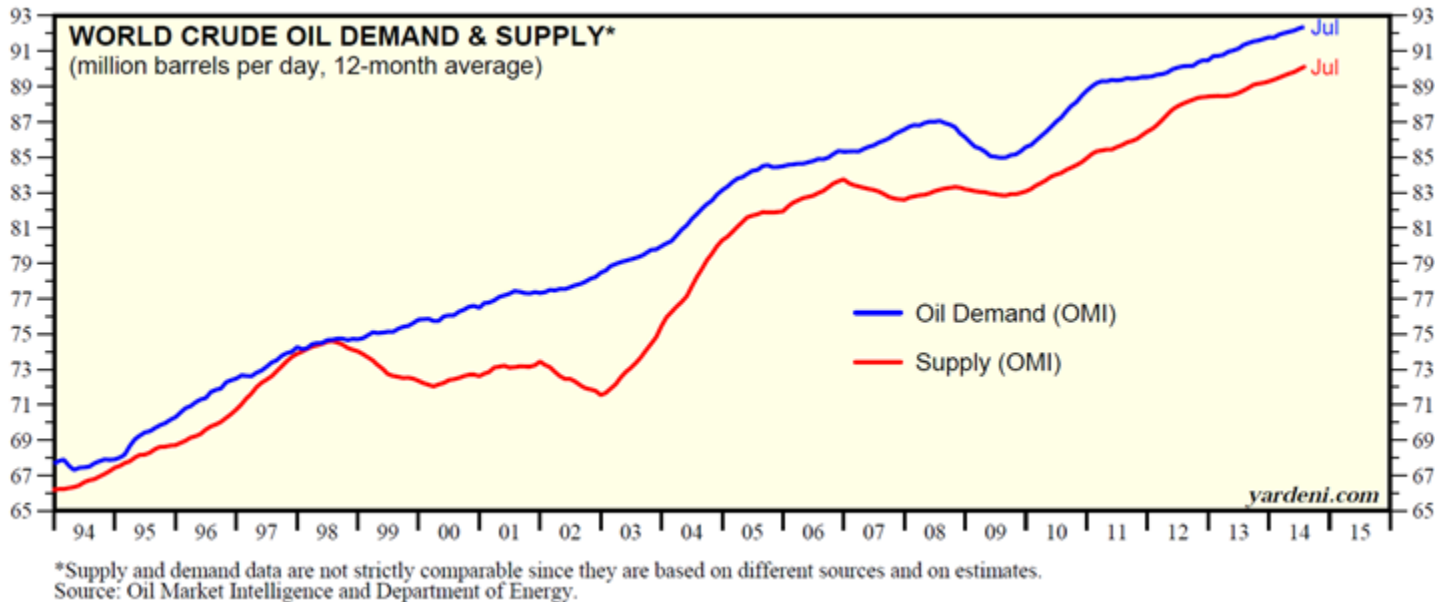

Figure 1.2.6: Crude oil supply and demand since 1994 to present day¹⁴

The rate of growth appears relatively constant over this span of time, however the actual yearly percentage change (at least in the demand for oil) varies drastically year to year. For example, beginning in 1987 the yearly percentage increase was about 3.5%, though this decreased slightly until 1991, when the percent change went negative for about one year. From 1987 to 2014 there were only three periods of time when the overall demand decreased, the largest of which was seen in 2009. None of these, however, lasted much more than a year. The percent change fluctuates from large spikes of about 4% increase to moderate periods of about 1-2%, with the exceptional negative percent changes as described. As of 2013 we find ourselves in a modest point of increasing demand (roughly 1.25% increase yearly). It is unclear what how this percentage will change in the immediate future, given the recent drop we experienced in 2009 followed by a large spike in 2011. Given the trend, however, it is safe to say that this type of behavior will continue for coming decades as we see the demand for oil fluctuate, though go up overall¹⁴. This, of course, assumes technology progresses at its current rate. With renewable energy becoming more and more important in the world, it is unclear whether alternative energy sources will become prevalent in the future and therefore lead to lowering the demand for oil. Additionally population growth has become a growing concern for energy consumption and

has no clear end in sight. It has been seen in the past to cause shortages of resources and will likely be an important factor in the demand for oil¹⁵.

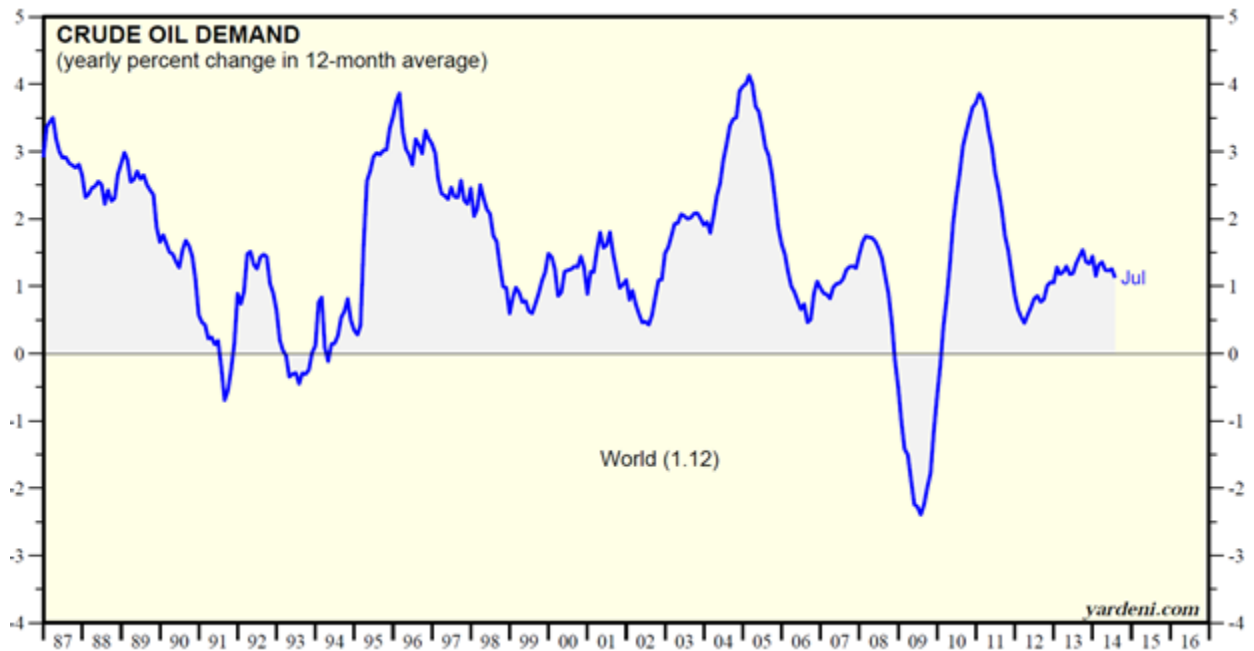

Figure 1.2.7: Yearly percentage change of oil demand from 1987 to present day¹⁴.

With an average behavior being apparent, and assuming all else remains the same, predicting future oil demand is possible. Assuming this trend continues, demand should increase at an overall steady rate. However the International Energy Agency claims that this growth will be overshadowed by the growth in production, causing the two to diverge. This is due in part to the US's recent surge in oil production¹⁶. Under the Obama administration, the US production of oil skyrocketed from about 5 million barrels a day to about 8 million. As of 2014, US oil production has surpassed its imports of oil for the first time since 1995¹⁷. This has come about mainly from new technology (tight oil in Texas and North Dakota, ultra-deepwater oil, and oil sands¹⁸). Despite the seeming rise in oil production, however, there are still many organizations predicting a rapid decrease in oil production in the coming years. Therefore it is unclear what to expect from oil production, as some predict the supply to increase for decades to come while others predict it plummeting within the next few years². This largely depends on the current size of reservoirs and future discoveries of them. It is logical to predict that we will continue discovering

Interactive Qualifying Project

similarly sized reservoirs at the pace we have been, however it is also reasonable to assume we have been searching optimally and therefore future reservoirs may be few and far between.

“U.S. decrease its imports in gas and oil due to an increase of domestic production from tight oil and shale plays. “U.S. liquid fuels net imports as a share of consumption is projected to decline from a high of 60% in 2005, and about 40% in 2012, to about 25% by 2016. The United States is also projected to become a net exporter of natural gas by 2018. China, India, and OECD Europe will each import at least 65% of their oil and 35% of their natural gas by 2020—becoming more like Japan, which relies on imports for more than 95% of its oil and gas consumption. In China and India, oil demand growth from emergent middle classes will likely outpace domestic production, while OECD Europe will likely become more import reliant as a result of declining oil production in the North Sea.

Here are reasons why EIA is projecting increasing import reliance in many countries, from the 2013 International Energy Outlook (IEO) report:

China. As noted in the 2013 IEO, China will experience the largest absolute growth in liquid fuels consumption, growing by about 46% by 2020 and doubling by 2040 from 2010 levels, as it moves from an industrial manufacturing economy to a more service-oriented economy with greater automobile saturation. China will also experience the largest growth in natural gas demand because the government is promoting gas as a preferred fuel to help alleviate air pollution. From 2010 to 2020, EIA projects natural gas consumption to rise at an average rate of 7.5% per year, while production will grow by an average of 2.4% per year, with growing shares from coalbed methane and shale gas coming on line by 2020.

India. EIA expects India to have the fastest growth rate in liquid fuels consumption from 2010 to 2020 (3.0% per year) and the second-largest absolute growth (behind China), primarily driven by diesel fuels used in transportation, irrigation, manufacturing, and electricity generation. EIA projects India's natural gas consumption to grow on average by 1.5% annually from 2010 to 2020, while production decreases by an average of 1.1% per year during that time period.

OECD Europe. EIA expects demand for oil products in OECD Europe to plateau as most countries will see their population remain flat. Oil output from the North Sea, the largest source of European production and the location of the Brent International price benchmark, reached its

Interactive Qualifying Project

peak production level in 1996, and EIA expects an average annual decline of 2.9% from 2010 to 2020. EIA projects overall natural gas production to decline about 2.6% annually from 2010 to 2020 before returning to 2010 levels in 2040. European natural gas consumption will grow at a modest 0.3% per year from 2010 to 2020.

While the discussion above focuses on economies that are net importers of both oil and natural gas, many economies are net exporters of one or both of these fuels, as shown in the quadrant diagram below. Economies in the Middle East (most of which are members of the Organization of the Petroleum Exporting Countries), Russia, Africa, and Canada are net exporters of both oil and natural gas (bottom left in graph). The Middle East, Russia, and Africa all export more than 2.4 times their domestic oil consumption.

Less common are countries that are net importers of one fuel and net exports of the other. OECD Latin America (top left, consisting of Mexico and Chile) is an overall oil exporter but relies on imported natural gas (primarily from U.S. pipelines to Mexico). Brazil will also join this group in the near future when it ramps up production in its offshore oil fields. Finally, Australia/New Zealand (bottom right) consume more oil than they produce but export natural gas. Australia's natural gas export market is projected to increase markedly as planned LNG export terminals come on line.”

Our optimal form of searching will likely evolve in the future, which may be able to offset this depletion of rich search areas. Finally, with limited space on Earth, it is only a matter of time until we hit a hard limit to the areas we can search and the oil we can find. With the number of variables involved and our uncertainty surrounding them, it becomes clear why predictions fluctuate as much as they do.

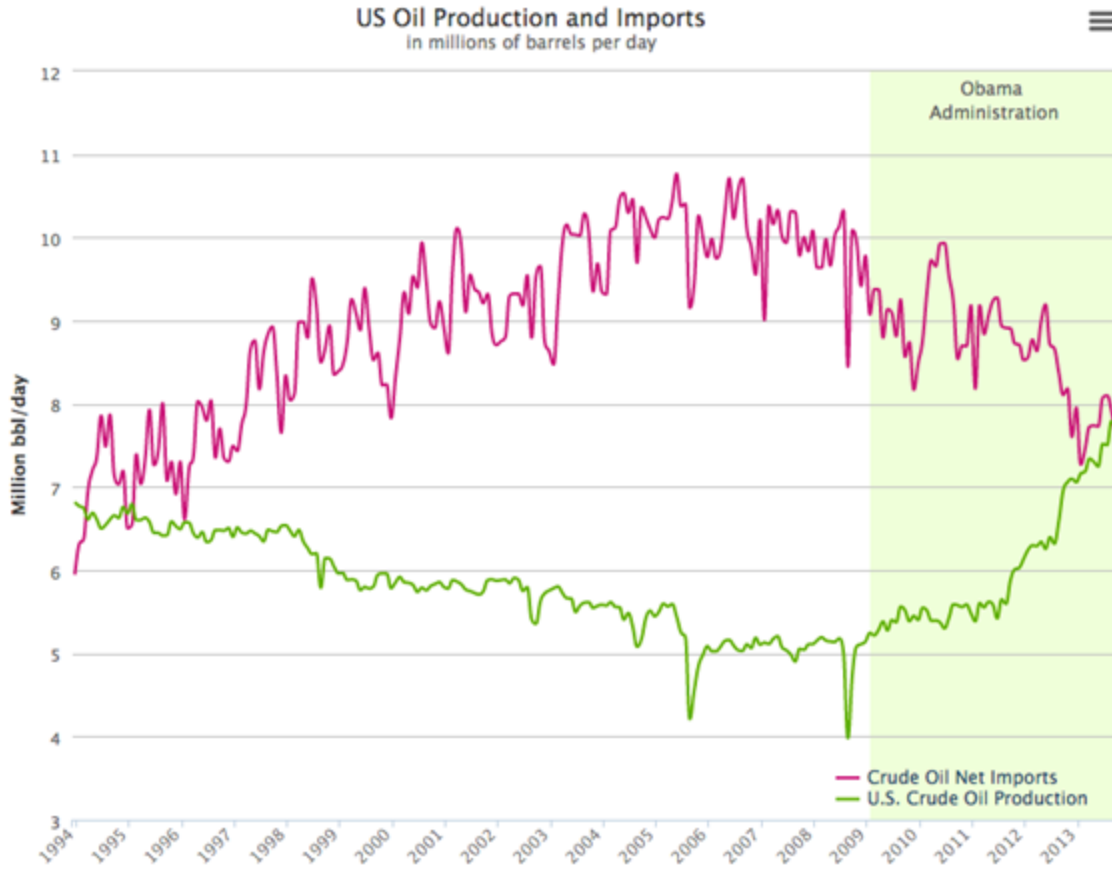

Figure 1.2.8: The US production and import of crude oil¹⁷.

1.3 Coal

The amount of the production and consumption of fossil fuel is mostly increasing recently while the total quantity of these resources are a fixed amount. Therefore to figure out the remaining and consumption rate and get a big picture of how long people can keep on use those resources, we did an information research focus on one of the main category of fossil fuel which is coal. The main issue of this report is to use the data from different reliable sources i.e. government announcement, statistics from professional organization to form a big picture of the current coal usage and to analysis a rough estimation of the time to keep on using coal as an energy source. Although there are many reports and prediction of the coal consumption but we should focus on more factors related to the increasing of the coal consumption. The goal of this project is to analyze the data of coal usage, figure out some hidden factor that can affect its increment and finally conclude an estimation of how long people can use coal as an energy source.

In this chapter I begin with a brief overview of general conditions of the coal production. Then I will provided with statistics of coal consumption. Finally, I will provide some research and prediction of the coal usage from government branches and professional organization.

Coal has been estimated to provide 2.9×10^{20} kJ in total but most of which is not economically exploitable.

Country	USA	Russia	China	Australia	India	Germany	Ukraine	Kazhakstan	South Africa
Coal reserves percentage	22.6%	14.4%	12.6%	8.9%	7.0%	4.7%	3.9%	3.9%	3.5%

Table: 1.3.1: Reserves per Country

Interactive Qualifying Project

China now produces and uses roughly half of world's coal output. China mainly used for electricity generation which fuels 69% of all its electric power. China and the United States together produced 63% of the world's coal as of 2011².

Energy Demand (quadrillion BTUs)						Average Annual Change			% Change			Share of Total			
	1990	2000	2010	2025	2040	2010	2025	2040	2010	2025	2040	2010	2025	2040	
Energy by Type – World															
Primary	361	418	523	654	710	1.5%	0.5%	1.0%	25%	9%	36%	100%	100%	100%	
Oil	137	158	178	206	221	1.0%	0.5%	0.7%	15%	7%	24%	34%	31%	31%	
Gas	72	89	115	159	190	2.2%	1.2%	1.7%	38%	19%	64%	22%	24%	27%	
Coal	86	93	133	158	133	1.1%	-1.1%	0.0%	19%	-16%	0%	26%	24%	19%	

Figure 1.3.1 Usage and future perspective of fossil fuel¹⁸

This graph is about the energy demand from fossil fuel of the whole world and also an outlook of future energy usage. It is clear that coal is still main source of energy, however the growth of coal consumption is decreasing in the long term.¹⁸

The world's energy consumption of coal is about 3730.1 Mtoe and of which the top3 country of coal consumption is China (50.2%) United States (11.7%) and India (8.0%). The consumption of China and India is increasing 6.1% and 9.9% compared to that of 2011 and the consumption of the United States is decreasing 11.9%. (Top 10 countries)

There are two internationally recognized methods for assessing world coal reserves. One is produced by the German Federal Institute for Geosciences and Natural Resources (BGR) and is used by the IEA as the main source of information about coal reserves. The second one is produced by the World Energy Council (WEC) and is used by the BP Statistical Review of World Energy. And according to BGR there are 1038 billion tons of coal reserves left, equivalent to 132 years of global coal output in 2012. Coal reserves reported by the BP are much lower - 861 billion tons, equivalent to 109 years of coal output.¹⁹

First of all I want to decides the reserve of the world's coal resource and there is obvious obstacles which is different data sources with different estimation provides different values that have approximately 15% differences. This is reasonable because first it is hard to detect all the usable coal source and also with different method can gives different approximation.

Interactive Qualifying Project

Furthermore, there are new reserves been detected each year. Therefore I decided to take a more positive stand and use the most recent data from World Coal association which is there are 1038 billion tons of coal left at 2012.

Then I would like to find the change of consumption rate each year. By looking at the data of world's annual production and the data of some main country such as U.S. China EU and India, I find that although the world's coal consumption is increasing but the increasing rate is decreasing. For developed countries the rate is decreasing because burning coal results in the most pollution among all the fossil fuels. Most of the developing country like China and India the rate is increasing mostly due to the development in industry. The total amount consumed by China is more than 50% of that of the whole world the India's increasing is faster. According to 2014 Outlook of Energy report made by Exxon Mobil the increase rate of coal consumption is about 1.1% from 2010 to 2025 and slowly decrease to -1.1% from 2025 to 2040. But according to a report by Reuters refereeing to an research institute called Wood Mackenzie that China's coal consumption will double that of 2012 which counts to an annual growth of 3.9% and considering China's large fraction of world coal consumption, I decided to take the annual increase rate of 2.0% given by World Coal Association until 2030 and the assumption of the increasing rate goes back to 0% to about 2050.

With the estimated rate of change and the data of 2012 world's coal consumption which is 7830Mt, I calculate the total amount of coal used till 2050 to be about 456 billion tones and then the consumption amount to be about 16617 Mt and then the rest of the coal could use another 35 years which leads to the results that current coal can be used for about another 78 years, even lesser than that of the BP Statistical Review of World Energy says.

Conclusion and recommendation

The purpose of this report is to give provide a big picture of current coal usage and make a prediction of how long could we still using them. With the data collected I find that for 2012 the reserve of world's coal is 1038 billion tones and the world's consumption was about 7830 million tones. The average growth of coal is about 2.9% and it is decreasing. Therefore the estimated remaining time of coal usage is about another 78 years.

Interactive Qualifying Project

Since the model used in the report is rough and the data used in the report needs more examination, I recommend building a more complex model to track the change of increasing rate and put in other factors such as the more usage of alternative source, the peak of coal production etc.

Chapter 2: Renewable energy

2.1 Nuclear energy

The energy from the nuclei of radioactive materials is produced using ^{238}U (Uranium) with the following fission reaction.

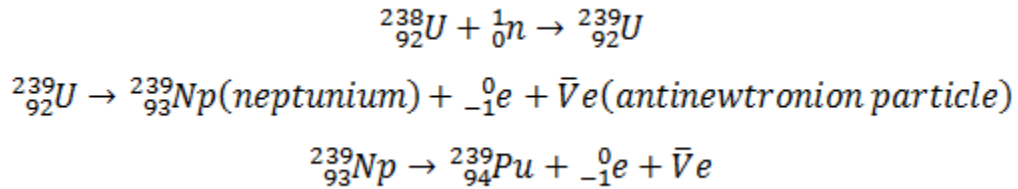

The above fission reaction takes place with fast moving neutrons and it is called reprocessing as it produces plutonium that can be used in fast breeder reactor. In general Uranium 235 is the most important isotope for nuclear fuels but it only appears at about 1% in the natural ore. All nuclear fuel must therefore be enriched before it can be used. Fuel enrichment is the process by which the % composition of ^{235}U is increased as to sustain nuclear fission. Nuclear fission:

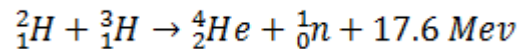

Produces energy but the energy required to create the hot plasma (mixture of positive nuclei and electrons) is more than the produced one. If cold fusion is achieved then the energy problem around the world will be solved as the fuel required is hydrogen and the by-products are not as radioactive as the waste from fission (mostly water vapor).

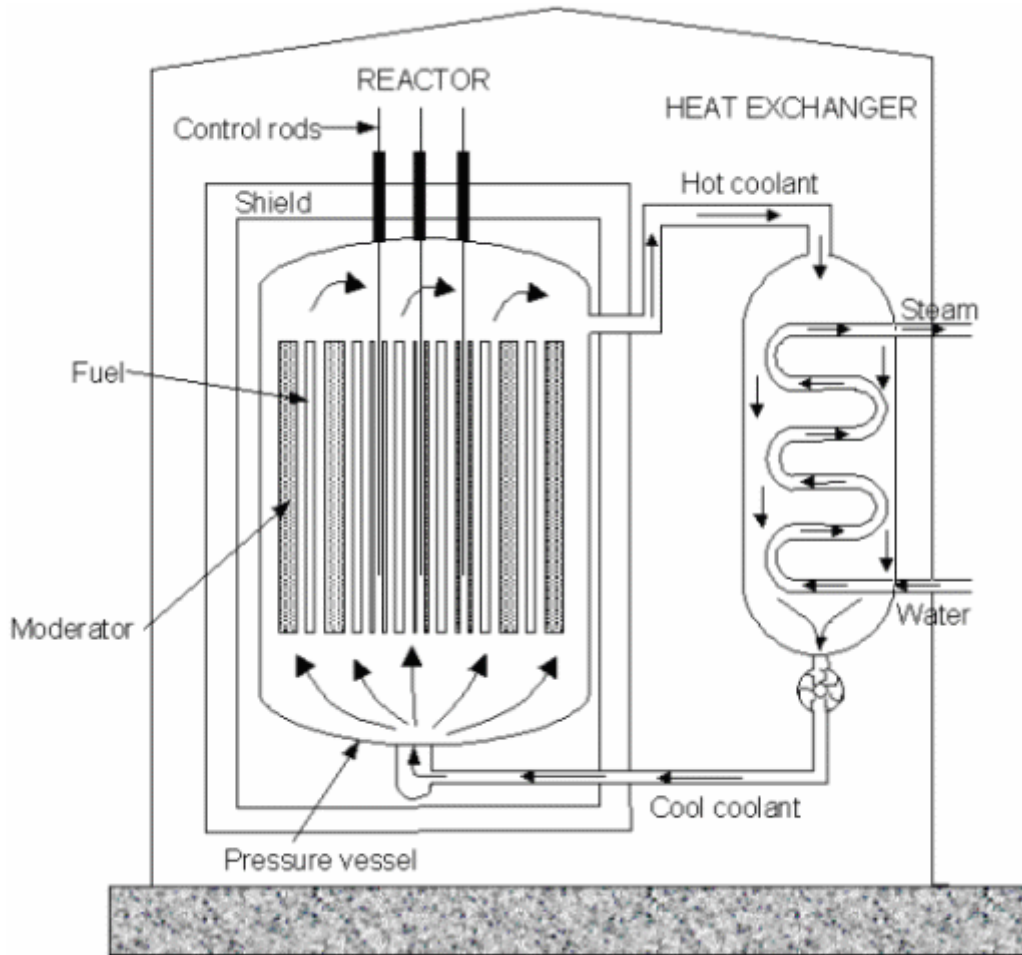

Figure 2.1.1: Reactor flow simulation²⁰

2.2: Helium 3

2.2.1 What is Helium 3

Helium-3 (He-3) is a light, non-radioactive isotope of helium with two protons and one neutron. It is rare on Earth, and it is sought for use in nuclear fusion research. The abundance of helium-3 is thought to be greater on the Moon (embedded in the upper layer of regolith by the solar wind over billions of years), though still lower in quantity (28 ppm of lunar regolith is helium-4 and from one to 50 ppb is helium-3) than the solar system's gas giants (left over from the original solar nebula).

The hellion, the nucleus of a helium-3 atom, consists of two protons but only one neutron, in contrast with two neutrons in common helium. Its hypothetical existence was first proposed in 1934 by the Australian nuclear physicist Mark Oliphant while he was working at the University of Cambridge Cavendish Laboratory. Oliphant had performed experiments in which fast deuterons collided with deuteron targets (incidentally, the first demonstration of nuclear fusion).

Helium-3 was hypothesized to be a radioactive isotope until hellions were also found in samples of natural helium, which is mostly helium-4, taken both from the terrestrial atmosphere and from natural gas wells. This was done by Luis W. Alvarez and Robert Cornog in cyclotron experiments at the Lawrence Berkeley National Laboratory in California in 1939.

Although helium-3 was found to be about 10,000 times rarer than helium-4 in the helium from the gas wells, its significant presence in underground gas deposits implied that either it did not decay, or else it had a very long half-life – billions of years. Hydrogen-1 and helium-3 are the only stable nuclides that contain more protons than neutrons.

Helium-3 is proposed as a second-generation fuel for nuclear fusion in hypothetical fusion power plants, but such plants are still very early in their development—especially since first generation reactors have not yet entered into service. Helium-3 can be used in instruments for the detection of free neutrons, such as neutrons leaking from nuclear reactors.²¹

Physical properties

Interactive Qualifying Project

Because of its lower atomic mass of 3.02 atomic mass units, helium-3 has some physical properties different from those of helium-4, with a mass of 4.00 atomic mass units. Because of the weak, induced dipole–dipole interaction between helium atoms, their macroscopic physical properties are mainly determined by their zero-point energy (ground-state kinetic energy). Also, the microscopic properties of helium-3 cause it to have a higher zero-point energy than helium-4. This implies that helium-3 can overcome dipole–dipole interactions with less thermal energy than helium-4 can.

The quantum mechanical effects on helium-3 and helium-4 are significantly different because with two protons, two neutrons, and two electrons, helium-4 has an overall spin of zero, making it a boson, but with one fewer neutron, helium-3 has an overall spin of one half, making it a fermion.

Helium-3 boils at 3.19 K compared with helium-4 at 4.23 K, and its critical point is also lower at 3.35 K, compared with helium-4 at 5.2 K. Helium-3 has less than one-half of the density when it is at its boiling point: 59 gram per liter compared to the 125 gram per liter of helium-4— at a pressure of one atmosphere. Its latent heat of vaporization is also considerably lower at 0.026 kilojoule per mole compared with the 0.0829 kilojoule per mole of helium-4.¹³⁸

^3He can be used in fusion reactions by either of the reactions $2\text{D} + ^3\text{He} \rightarrow ^4\text{He} + \text{p} + 18.3 \text{ MeV}$, or $3\text{He} + ^3\text{He} \rightarrow ^4\text{He} + 2 \text{p} + 12.86 \text{ MeV}$.

The conventional deuterium + tritium ("D-T") fusion process produces energetic neutrons which render reactor components radioactive with activation products. The appeal of helium-3 fusion stems from the aneutronic nature of its reaction products. Helium-3 itself is non-radioactive. The lone high-energy by-product, the proton, can be contained using electric and magnetic fields. The momentum energy of this proton (created in the fusion process) will interact with the containing electromagnetic field, resulting in direct net electricity generation.

Because of the higher Coulomb barrier, the temperatures required for $2^1\text{H} + ^3\text{He}$ fusion are much higher than those of conventional D-T fusion. Moreover, since both reactants need to be mixed together to fuse, reactions between nuclei of the same reactant will occur, and the D-D reaction ($2^1\text{H} + ^1\text{H}$) does produce a neutron. Reaction rates vary with temperature, but the D- ^3He reaction rate is never greater than 3.56 times the D-D reaction rate (see graph). Therefore

Interactive Qualifying Project

fusion using D-3He fuel may produce a somewhat lower neutron flux than D-T fusion, but is by no means clean, negating some of its main attraction.

The second possibility, fusing ^3He with itself ($^3\text{He} + ^3\text{He}$), requires even higher temperatures (since now both reactants have a +2 charge), and thus is even more difficult than the D-3He reaction. However, it does offer a possible reaction that produces no neutrons; the protons it produces possess charges and can be contained using electric and magnetic fields, which in turn results in direct electricity generation. $^3\text{He} + ^3\text{He}$ fusion has been demonstrated in the laboratory and is thus theoretically feasible and would have immense advantages, but commercial viability is many years in the future.

The amounts of helium-3 needed as a replacement for conventional fuels are substantial by comparison to amounts currently available. The total amount of energy produced in the $2^1\text{H} + ^3\text{He}$ reaction is 18.4 MeV, which corresponds to some 493 megawatt-hours ($4.93 \times 10^8 \text{ W}\cdot\text{h}$) per three grams (one mole) of ^3He . If the total amount of energy could be converted to electrical power with 100% efficiency (a physical impossibility), it would correspond to about 30 minutes of output of a gigawatt electrical plant per mole of ^3He . Thus, a year's production would require 52.5 kilograms of helium-3. The amount of fuel needed for large-scale applications can also be put in terms of total consumption: electricity consumption by 107 million U.S. households in 2001[14] totaled 1,140 billion kW·h ($1.14 \times 10^{15} \text{ W}\cdot\text{h}$). Again assuming 100% conversion efficiency, 6.7 tons per year of helium-3 would be required for that segment of the energy demand of the United States, 15 to 20 tons per year given a more realistic end-to-end conversion efficiency.

Interactive Qualifying Project

Reactants		Products	Q	n/MeV
First-generation fusion fuels				
21H + 21H (D-D)	→	${}^3_2\text{He} + {}^1_0\text{n}$	3.268 MeV	0.306
21H + 21H (D-D)	→	31H + ${}^1_1\text{p}$	4.032 MeV	0
21H + 31H (D-T)	→	42He + ${}^1_0\text{n}$	17.571 MeV	0.057
Second-generation fusion fuel				
21H + ${}^3_2\text{He}$ (D- ${}^3\text{He}$)	→	42He + ${}^1_1\text{p}$	18.354 MeV	0
Third-generation fusion fuels				
${}^3_2\text{He} + {}^3_2\text{He}$	→	42He + $2{}^1_1\text{p}$	12.86 MeV	0
${}^{11}_5\text{B} + {}^1_1\text{p}$	→	3 42He	8.68 MeV	0
Net result of D burning (sum of first 4 rows)				
6D	→	2(4He + n + p)	43.225 MeV	0.046
Current nuclear fuel				
235U + n	→	2 FP + 2.5n	~200 MeV	0.001

Table 2.2.1: Comparison of neutronicity of reactions ²¹

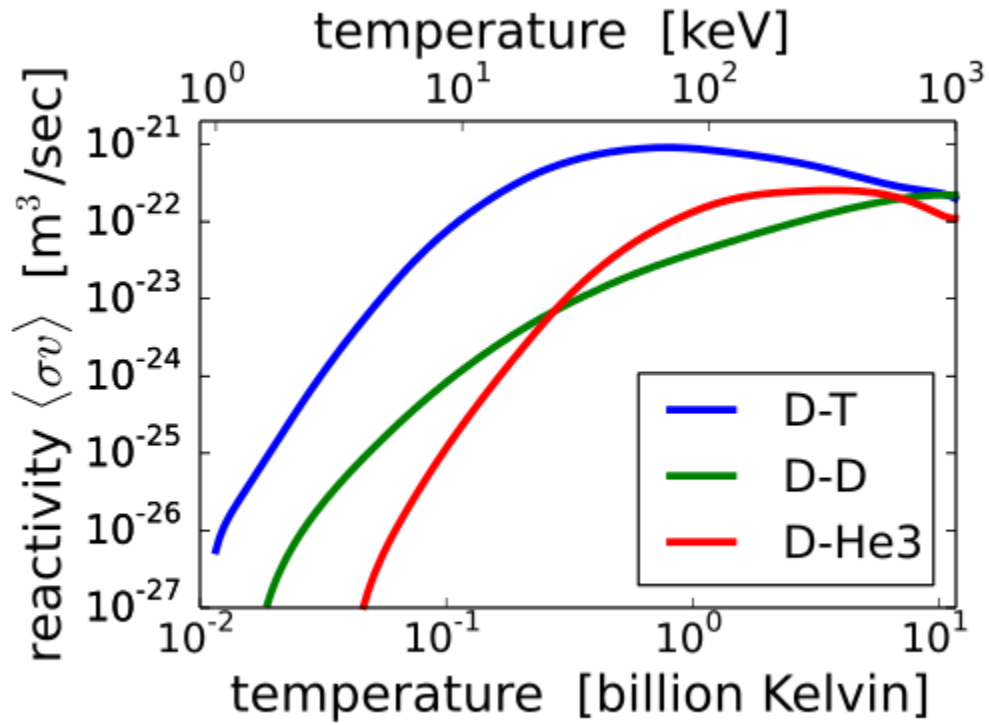

Figure 2.2.1: The reaction rate of He-3 with different temperature ²²

The fusion reaction rate increases rapidly with temperature until it maximizes and then gradually drops off. The DT rate peaks at a lower temperature (about 70 keV, or 800 million kelvins) and at a higher value than other reactions commonly considered for fusion energy.

Supply and demand of Helium3

2.2.2 Supply and price of Helium 3

At present, helium-3 is only produced as a byproduct of the manufacture and purification of tritium for use in nuclear weapons. The supply of helium-3 therefore derives mostly, perhaps entirely, from two sources: the U.S. and Russian governments. Other potential sources of helium-3 do exist, but using these sources would present varying degrees of technical and policy challenges. Congress has several options for increasing the supply of helium-3, either from conventional sources or by encouraging the development of new sources. Among the important characteristics of all these potential sources are their likely cost and the amount of helium-3 they could potentially supply. The potential annual production of helium-3 from alternative sources is uncertain. This uncertainty results from incomplete characterization of the sources, variability in helium-3 content, and other factors, such as the willingness of public or private entities to invest in infrastructure to enable production at a particular scale. Even for potentially large sources, producing helium-3 from these sources may be impractical on cost grounds.

The main source of helium-3 in the United States is the federal government's nuclear weapons program. For many years, the National Nuclear Security Administration (NNSA) and its predecessor agencies have produced tritium for use in nuclear warheads. Over time, tritium decays into helium-3 and must be replaced to maintain warhead effectiveness. The NNSA recycles the mixture of tritium and helium-3 that results from this decay process and reuses the resulting pure tritium. From the perspective of the weapons program, the extracted helium-3 is a byproduct of maintaining the purity of the tritium supply. This means that the tritium needs of the weapons program, not the demand for helium-3 itself, determine the amount of helium-3 produced.

Until 2001, helium-3 production by the weapons program exceeded demand, and the program accumulated a stockpile. To recoup some of the cost of purifying recycled tritium, the program transferred helium-3 from the stockpile to the DOE Office of Isotope Production and Research for sale at auction. Despite these sales, the helium-3 stockpile grew from roughly 140,000 liters in 1990 to roughly 235,000 liters in 2001. Since 2001, however, helium-3 demand has exceeded production. By 2010, the increased demand had reduced the stockpile to roughly 50,000 liters. See Figure 1. Note that these amounts do not account for helium-3 imports and exports, or helium-3 supplies held by other agencies or the private sector.

Figure I. Size of the Helium-3 Stockpile, 1990-2010

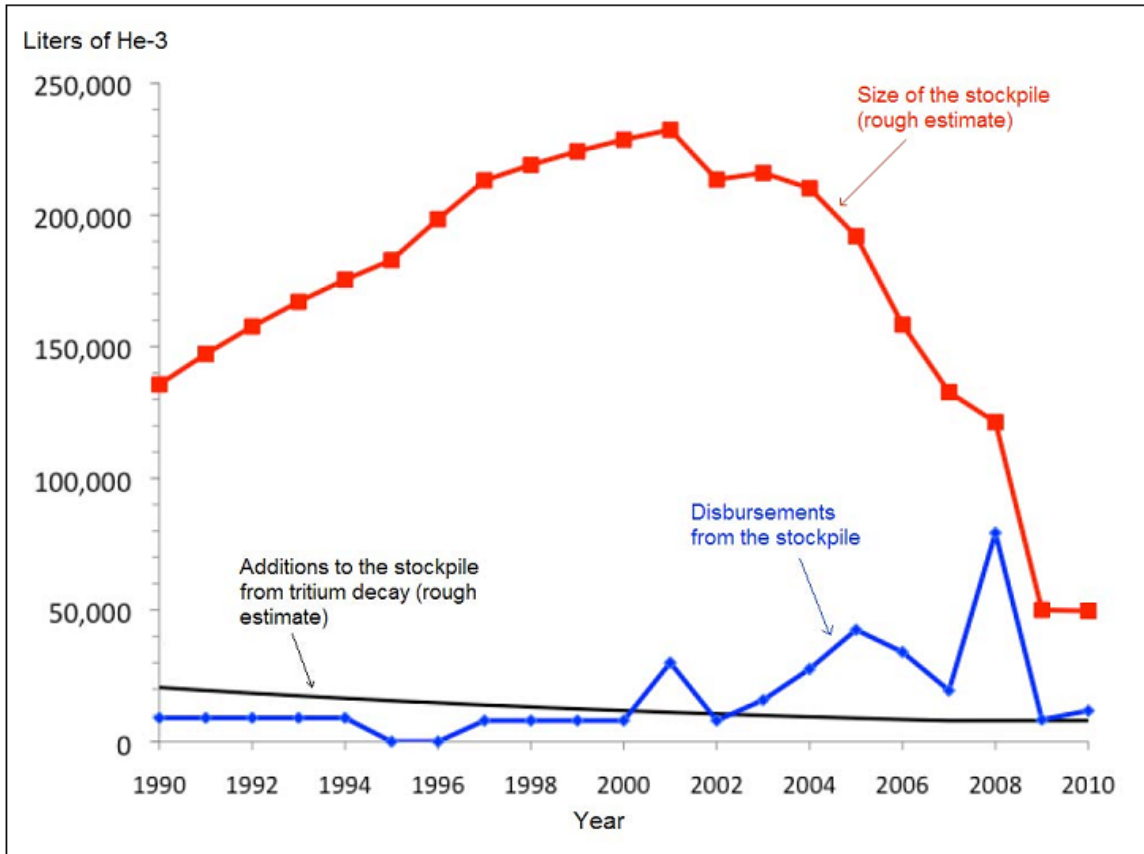

Source: Adapted from Steve Fetter, Office of Science and Technology Policy, "Overview of Helium-3 Supply and Demand," presentation at the American Association for the Advancement of Science Workshop on Helium-3, April 6, 2010.

Figure 2.2.2 Size of Helimu-3 stockpile, 1990-2010 ²³

The U.S. weapons program currently produces tritium by irradiating lithium in a light-water nuclear reactor. Before 1988, the program used heavy-water reactors at the DOE Savannah River Site in South Carolina. In 1988, the last operating Savannah River Site reactor, the K reactor, was shut down for safety reasons. For the next several years, reductions in the nuclear weapons stockpile meant that tritium recycling met the weapons program's needs without additional tritium production. Over time, as the tritium produced before 1988 decayed into helium-3, the total amount of remaining tritium decreased. The annual rate of helium-3 production from the remaining tritium declined commensurately. The DOE restarted tritium production for the weapons program in 2003 using the commercial Watts Bar reactor in

Tennessee, operated by the Tennessee Valley Authority (TVA). The tritium production process used there is new and involves irradiation of lithium-containing Tritium-Producing Burnable Absorber Rods (TPBARs). The DOE also built the Tritium Extraction Facility to extract tritium from irradiated TPBARs. This facility, located at the Savannah River Site, became operational in 2007. The NNSA plans to begin irradiating TPBARs at the TVA's two Sequoyah reactors in FY2012. Currently, TVA irradiates only a small number of TPBARs, and tritium production is limited.

As shown in Figure 1, the decay of tritium held by the U.S. nuclear weapons program currently generates approximately 8,000 liters of new helium-3 per year. Historically, the price of helium-3 has been \$100 to \$200 per liter, with commercial prices rising to \$2,000 per liter or more after the discovery of the shortage.

2.2.3 Demand of Helium 3

The demand for helium-3 has increased dramatically since 2001. Prior to 2001, the demand was approximately 8,000 liters per year, which was less than the new supply from tritium decay. After 2001, the demand increased, reaching approximately 80,000 liters in 2008. Projections show demand continuing at above the available new supply for at least the next several years. See Figure 2. These projections contain many variables and therefore considerable uncertainty. Some estimates project much higher non-governmental demand, perhaps more than 100,000 liters in FY2011 and FY2012. Some estimates appear to measure helium-3 quantities at nonstandard pressures. Because liters are a volume measure, and all gases change volume depending on their pressure, inconsistency in measurement has the potential to create confusion when amounts projected by different analysts are added. Perhaps most important, given such a large mismatch between supply and demand, users are likely to seek out alternative technologies, reschedule planned projects, and make other changes that reduce demand below what it would be in the absence of a shortage. It is unclear whether the available estimates reflect (or indeed, could reflect) these likely changes. Similarly, it is unclear whether federal agencies and the private sector can reduce demand sufficiently to match the current helium-3 supply and still meet priorities for security, science, and other applications.

Figure 2. Projected Helium-3 Demand, FY2009-FY2018

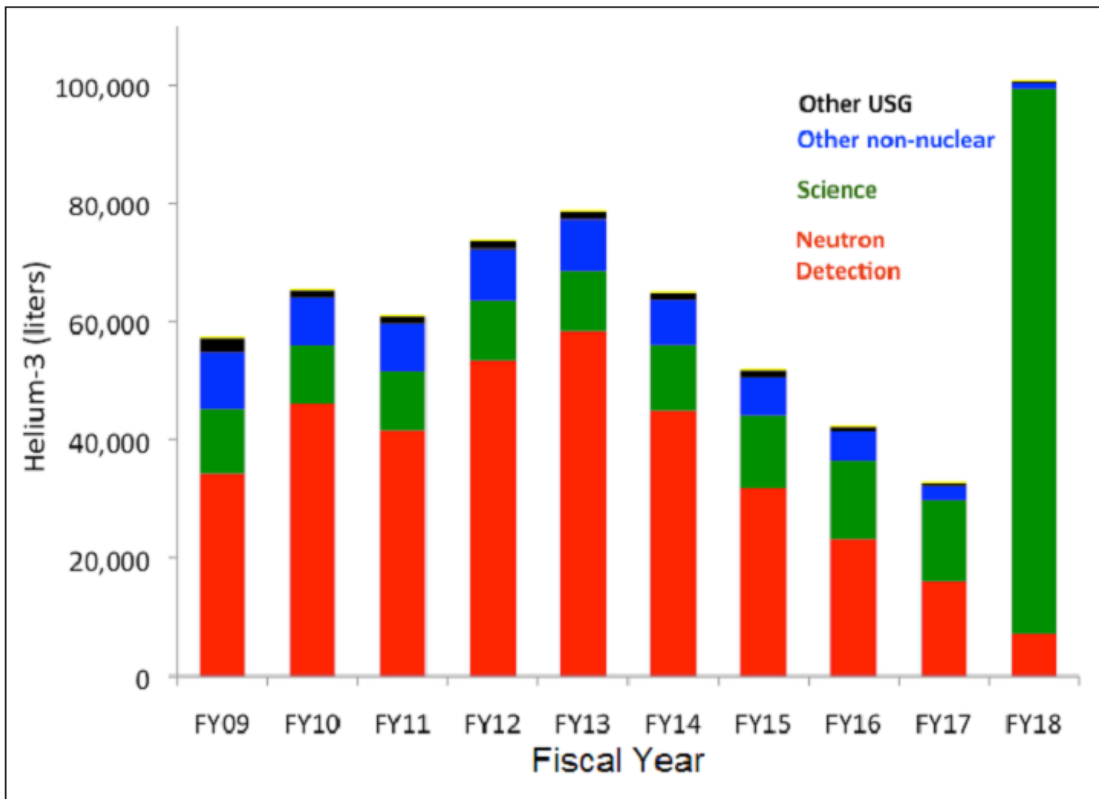

Source: Adapted from Steve Fetter, Office of Science and Technology Policy, “Overview of Helium-3 Supply and Demand,” presentation at the American Association for the Advancement of Science Workshop on Helium-3, April 6, 2010.

Note: USG = U.S. Government. Science includes both research activities and large laboratory facilities. Another allotment to the Spallation Neutron Source underlies the increase in scientific demand in FY2018.

Figure 2.2.3 Projected Helium-3 Demand, 2009-2018 ²³

Neutron detection applications in national and homeland security are the largest users of helium-3, but scientific research, medicine, and industry are also significant.

The demand for helium-3 for national and homeland security purposes falls into two main categories: the detection of smuggled radiological and special nuclear material and the monitoring of known special nuclear material to ensure its security. The Department of Defense, Department of State, NNSA, and DHS all have deployed radiation detection equipment to detect smuggled radiological and nuclear material. Through programs such as Cooperative Threat Reduction, the Second Line of Defense, and the Radiation Portal Monitor program, these agencies have deployed thousands of radiation portal monitors both domestically and overseas.

Interactive Qualifying Project

Each portal uses approximately 50 liters of helium-3 as the basis for its neutron detection capability. Some of the programs have been in place since before 2001.

Others, such as those operated through DHS, were established later. The broad expansion of these deployments has provided the greatest demand for helium-3 and been the largest drain on the helium-3 stockpile. The Department of Defense and NNSA also use helium-3 in neutron detectors to ensure that stores of special nuclear material are fully accounted for. Accurate neutron counting over long time periods is one way to monitor the continued presence of materials such as plutonium. In addition, the United States contributes helium-3 to meet the nuclear security and monitoring needs of the International Atomic Energy Agency (IAEA). Department of Defense guidance and navigation systems for munitions, missiles, aircraft, and surface vehicles include ring laser gyroscopes that use helium-3. Testing and qualification are under way on an alternative gas for this purpose.²³

2.2.4 Uses

Scientific uses of helium-3 are diverse, ranging from neutron detection to cryogenics, laser physics, and research on the properties of helium-3 itself. Large-scale government research facilities, such as the DOE Spallation Neutron Source at Oak Ridge National Laboratory in Tennessee, may use tens of thousands of liters. Numerous smaller, laboratory-scale users are in academia and elsewhere. Although individual university researchers use smaller quantities, their ability to pay the currently high price for market-rate helium-3 may be limited. Although they are part of the private sector, their research is often funded by federal agencies. The United States also participates in international science projects that require helium-3, such as ITER (originally called the International Thermonuclear Experimental Reactor), currently under construction in France. The United States, as well as engaging directly in scientific activities that require helium-3, has historically been a major source of helium-3 for the international scientific community. Some foreign scientists may depend on U.S.-supplied helium-3 for their research. Although some of these foreign scientists may work independently, many of them are likely colleagues and collaborators of U.S. scientists.

The development of a polarized medical imaging technique contributed to an expansion of demand for helium-3 in the late 1990s. This technique depends on patients inhaling polarized gas so that imaging of the gas using MRI provides a visualization of lung function.

Industry

In industrial applications, a neutron-emitting material is coupled with a helium-3 neutron detector to make density measurements based on the number of neutrons reflected back to the detector. This technique is used for oil and gas well logging and to determine the density of road construction. ²³

2.3 Solar Energy

2.3.1 Introduction

This report is an outlook of solar energy, with a introduction of solar energy, a data analysis of recent solar energy usage and some new aspect and technology about solar energy. The main goal of this report is to provide a big picture of the recent condition of the solar energy with data analysis and point out a prospective of solar energy usage in the future.

Information about solar energy

Energy from the sun

Solar energy is the sun's rays (solar radiation) that reach the Earth. This energy can be converted into other forms of energy, such as heat and electricity. Radiant energy from the sun has powered life on Earth for many millions of years. Solar energy can be used for heat and electricity. When converted to thermal (or heat) energy, solar energy can be used to:

Heat water — for use in homes, buildings, or swimming pools.

Heat spaces — inside homes, greenhouses, and other buildings.

Heat fluids — to high temperatures to operate a turbine to generate electricity.

Interactive Qualifying Project

Solar energy can be converted to electricity in two ways: Photovoltaic (PV devices) or “solar cells” change sunlight directly into electricity. Individual PV cells are grouped into panels and arrays of panels that can be used in a wide range of applications ranging from single small cells that charge calculator and watch batteries, to systems that power single homes, to large power plants covering many acres.

Solar thermal/electric power plants generate electricity by concentrating solar energy to heat a fluid and produce steam that is used to power a generator. In 2012, solar thermal-power generating units were the main source of electricity at 12 power plants in the United States: 11 in California and one in Nevada.

The main benefits of solar energy are: Solar energy systems do not produce air pollutants or carbon-dioxide, and when located on buildings, they have minimal impact on the environment. Two limitations of solar energy are: The amount of sunlight that arrives at the Earth's surface is not constant, and it varies depending on location, time of day, time of year, and weather conditions. Because the sun doesn't deliver that much energy to any one place at any one time, a large surface area is required to collect the energy at a useful rate.²⁴

2.3.2 Data analysis of the current solar energy usage

In the AEO2014 Reference case, renewable electricity generation grows by 69% from 2012 to 2040, including an increase of more than 140% in generation from non-hydro-power renewable energy sources. Renewable sources are collectively the fastest-growing source of electricity generation in the projection, with annual growth rates that exceed the growth rate for natural gas-fired generation. However, because renewable sources start from a relatively low 12% market share of total generation, their contribution to U.S. total electricity generation is just 16% in 2040 in the Reference case, well below the natural gas and coal shares of 35% and 32%, respectively.

Figure IF7-1. Total U.S. electricity generation by energy source, 2012 and 2040 (billion kilowatthours)

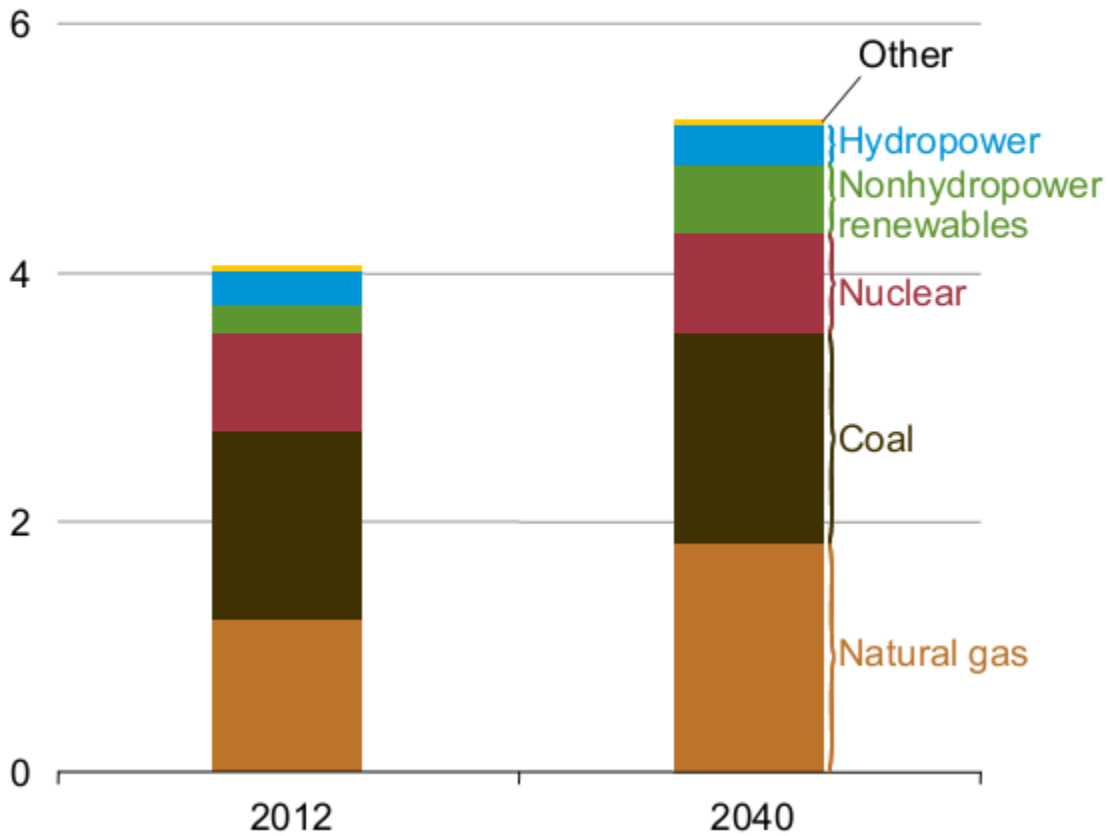

Figure 2.3.1 Total U.S electricity generation by energy source in billion kilowatt hours ²⁵

Renewable energy sources, chiefly solar photo-voltaic and wind, continue to dominate new commercial distributed generation capacity in the AEO2014 Reference case, accounting for 62.3% of commercial capacity in 2040. Lower prices for photo-voltaic inverters and panels, decreasing installation costs, federal investment tax credits, and state and utility rebates all contribute to growth in commercial photo-voltaic capacity, which increases by 5.7%/year from 2012 to 2040 in the Reference case. The current 30% federal investment tax credit continues through 2016, after which it reverts to 10%. In the No Sunset case, with investment tax credits for all distributed generation technologies extended through 2040, photo-voltaic capacity increases by an average of 7.0%/year. To conclude, the solar photo-voltaic contributes to more

than 60% of the energy gained from renewable energy source and that percentage is till increasing annually.

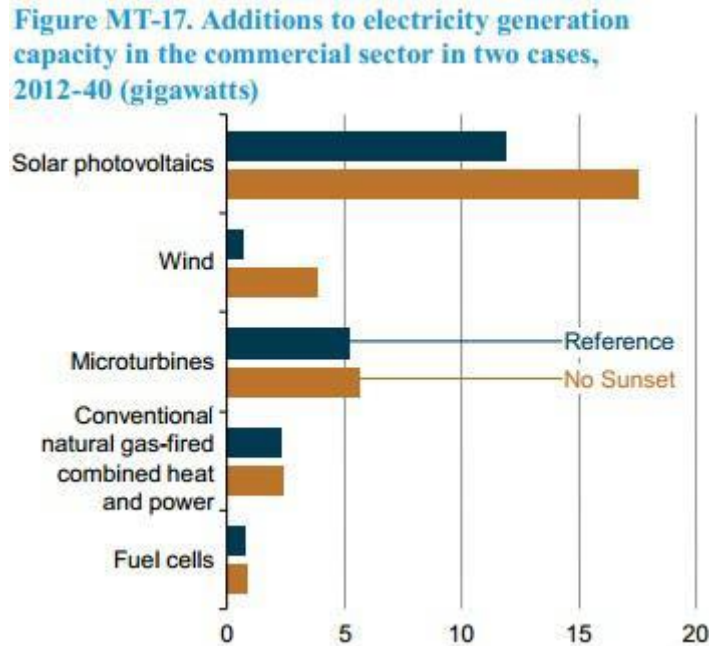

Figure 2.3.2 Additions to electricity generation capacity in the commercial sector in two cases in Gigawatts ²⁵

This graph shows the electricity generation from solar power in eight different cases in year 2012, 2020, 2030 and 2040. When compared the amount of electricity generation in different years it is clearly that the amount is growing each year. But for different condition the amount could be difference at about 300%, for example the amount of no sunset condition and low economic growth condition in year 2040. In all the growth of total amount is closely related with economic condition and the price of oil and gas. Right now in year 2014 the global annual amount of electricity generate by solar energy is about 40 billion kilowatt hours. And in the worst case when there is low economic growth it still going to increase to 60 billion kilowatt hours in 2040 and in the most optimistic case it will grow to 280 billion kilowatt hours per year.

Interactive Qualifying Project

The Low Renewable Technology Cost case assumes that renewable technology capital costs are 20% lower than in the Reference case. The No Sunset case assumes the extension of existing federal energy policies that contain sunset provisions—in particular the production and investment tax credits for certain renewable electricity generation technologies. The GHG25 case assumes a policy that applies a fee on carbon dioxide emissions (in 2012 dollars) starting at \$25 per metric ton in 2015 and escalating by 5% per year to about \$85 per metric ton in 2040. The High Oil and Gas

Resource case adjusts oil and gas resource and productivity assumptions that result in natural gas prices to the electric power sector in 2040 that are 37% lower than in the Reference case. The Low Oil and Gas Resource case adjusts assumptions about oil and gas resources that result in natural gas prices to the electric power sector in 2040 that are 33% higher than in the Reference case. The High Economic Growth and Low Economic Growth cases assume higher and lower levels of real GDP growth from 2012 to 2040 than in the Reference case.²⁵

Figure IF7-4. Electricity generation from solar power in eight cases, 2012, 2020, 2030, and 2040 (billion kilowatthours)

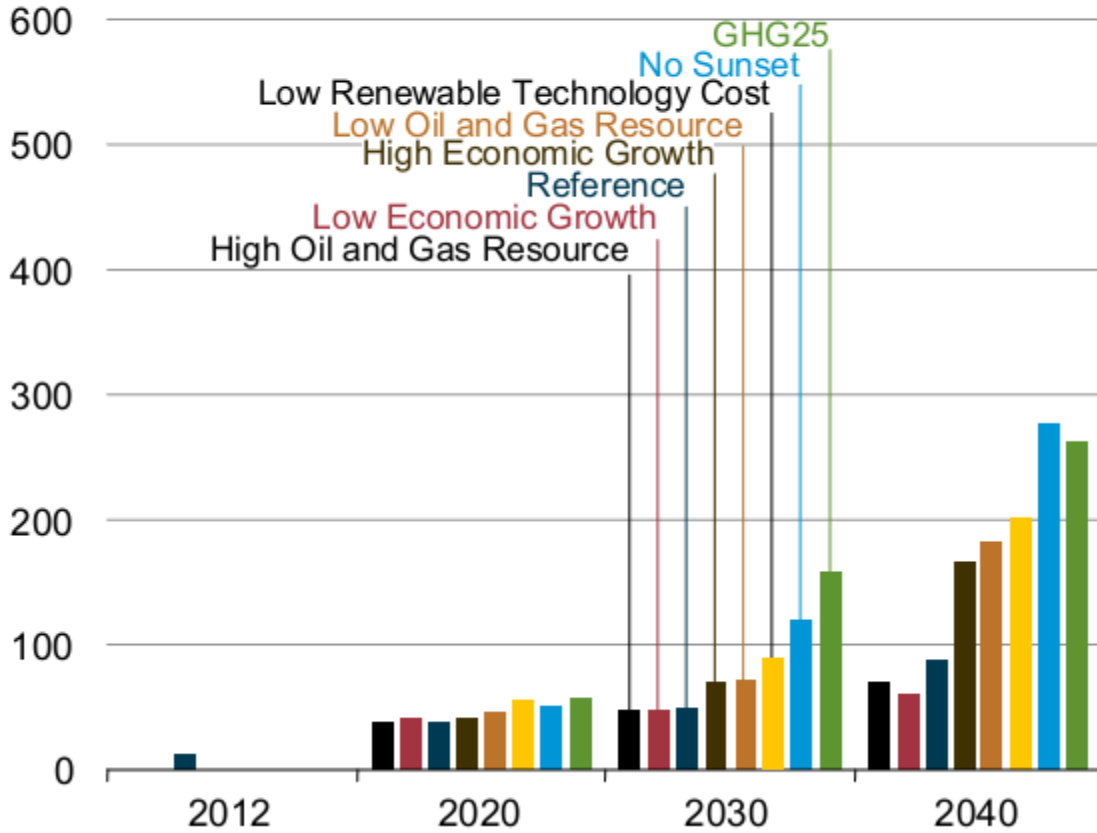

Figure 2.3.3: Electricity generation from solar power in eight cases in billion kilowatt hours ²⁵

2.3.3 The cost of solar energy

The SunShot Initiative aggressively supports development of low-cost, high-efficiency photo-voltaic (PV) technologies in order to make solar electricity cost-competitive with other sources of energy by 2020. As of February 2014, only three years into the decade-long SunShot Initiative, the solar industry is already more than 60% of the way to achieving SunShot’s cost target of \$0.06 per kilowatt-hour for utility-scale PV (based on 2010 baseline figures). The technology they try to use is CSP technologies. CSP technologies are deployed primarily in four system configurations: parabolic trough and linear Fresnel focus sunlight in a linear fashion

whereas dish engines and power towers (also known as central receivers) focus sunlight to a point. Though CSP systems use different configurations to focus the sunlight, they share similar components such as collectors, receivers, power block, and thermal storage. DOE funds CSP research and development focused on developing the component technologies to achieve the technical and economic targets of the SunShot goal. The program also funds systems analysis on all of the CSP technologies to assess performance, longevity, and cost.

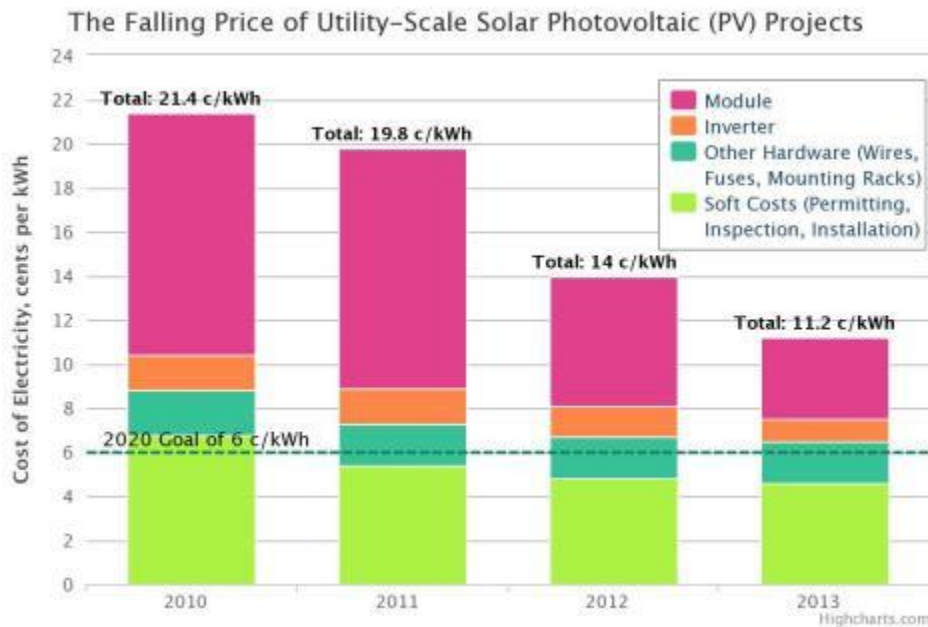

Figure 2.3.4 Falling price of utility-scale solar photovoltaic projects²⁶

The price of solar energy is kept falling in recent years due to the development of new technology and mostly reduced price is the cost of module while the soft cost falls the second fastest. The total price falls about 50% in this three years but the goal is to reduce the price to 6c/kWh in 2020. Consider the average electricity price which is 10.47 c/kWh that cost in pretty satisfying.²⁶

2.3.4 New technology and better use of solar energy.

Stanford researchers say new materials could help lower the cost of producing fuel with solar energy.

By making a solar photo-voltaic material more resilient, researchers may have found a way to make artificial photosynthesis—that is, using sunlight to make fuel—cheap enough to compete with fossil fuels.

If you want hydrogen to power an engine or a fuel cell, it's far cheaper to get it from natural gas than to make it by splitting water. Solar power, however, could compete with natural gas as a way to make hydrogen if the solar process were somewhere between 15 and 25 percent efficient, says the U.S. Department of Energy. While that's more than twice as efficient as current approaches, researchers at Stanford University have recently developed materials that could make it possible to hit that goal. The work is described in the journal *Science*.

One way to make hydrogen using sunlight is to use a solar panel to make electricity and then use that electricity to power a commercial electrolyzer that splits water, forming hydrogen and oxygen. But combining the solar panel and the electrolyzer in one device might be cheaper and more efficient. The electrons produced when light hits a photo-voltaic material could facilitate chemical reactions, and the capital costs of one machine would likely be lower than the cost of two.

For some time now researchers have known that you could approach 15 to 25 percent efficiency if you combined two solar cell materials in such a system. One solar cell would power half of the water-splitting reaction—forming hydrogen. The other could form oxygen.²⁷

Use Solar Energy at Night

Near Granada, Spain, more than 28,000 metric tons of salt is now coursing through pipes at the Andasol power plant. That salt will be used to solve a pressing if obvious problem for solar power: What do you do when the sun is not shining and at night? The answer: store sunlight as heat energy for such a rainy day.

Part of a so-called parabolic trough solar-thermal power plant, the salts will soon help the facility light up the night—literally. Because most salts only melt at high temperatures (table salt,

for example, melts at around 1472 degrees Fahrenheit, or 800 degrees Celsius) and do not turn to vapor until they get considerably hotter—they can be used to store a lot of the sun's energy as heat. Simply use the sunlight to heat up the salts and put those molten salts in proximity to water via a heat exchanger. Hot steam can then be made to turn turbines without losing too much of the original absorbed solar energy.

The salts—a mixture of sodium and potassium nitrate, otherwise used as fertilizers—allow enough of the sun's heat to be stored that the power plant can pump out electricity for nearly eight hours after the sun starts to set. "It's enough for 7.5 hours to produce energy with full capacity of 50 megawatts," says Sven Moormann, a spokesman for Solar Millennium, AG, the German solar company that developed the Andasol plant. "The hours of production are nearly double [those of a solar-thermal] power plant without storage and we have the possibility to plan our electricity production." ²⁸

2.3.5 Conclusion and summary

The solar energy is in the major source of renewable energy although renewable energy only take about 10% in the total energy supply. Solar energy usage is growing rapidly recently and its growth is closely related to economic growth, government policy support, the supply of fossil fuel, and the cost of the solar energy. The most optimistic estimation is the total amount of energy provided but solar energy will be 20 time that of right now. Right now solar power provide us about 40GW annually. The price of the solar power is twice as high as average price of electricity now but the goal is to make it half that of the electricity price now. There are many new technology to enhance solar power's efficiency and reduce its price basically through finding method to make use of solar power at night and bad weather, developing more efficient solar plate and finding ways to use solar power to produce hydrogen and oxygen as fuel.

2.4 Bio-Fuel

2.4.1 Definition

Biodiesel is a non-petroleum based alternative fuel for compression ignition engines. Biodiesel is defined as an ethyl or methyl ester derived through a transesterification reaction, from animal fat, vegetable oil, or algae. ²⁹

Transesterification is a catalyzed reaction that converts the raw material, such as vegetable oil, into usable biodiesel. ³⁰ The reaction occurs at low temperatures (approximately 150°F) and pressures (approximately 20 psi) and has a high recovery rate of about 98% so there is minimal waste. The glycerin that is produced as a by-product can then be used in other product such as soap.

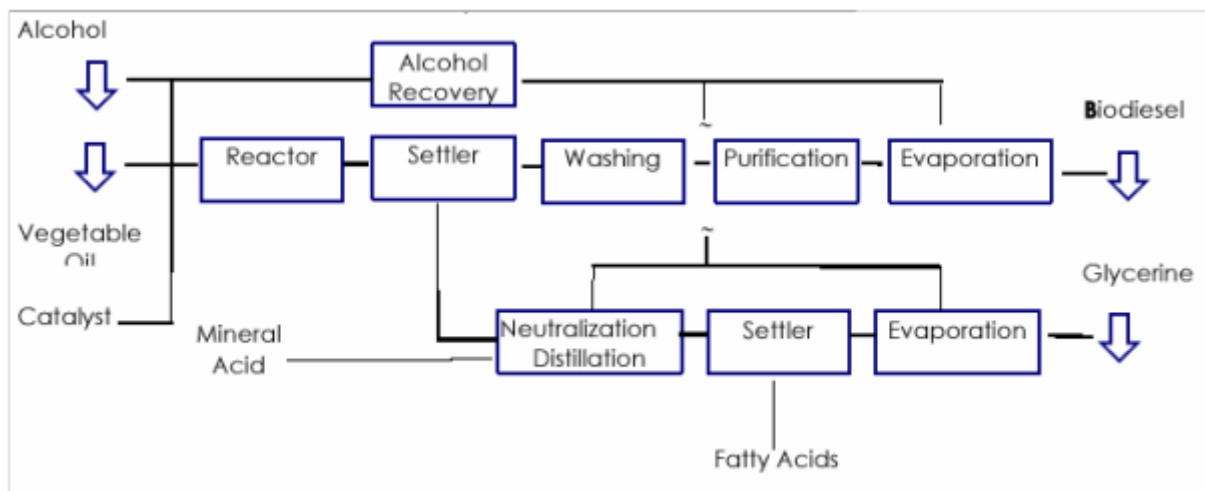

Figure 2.4.1: The production of biodiesel in block diagram form. ³¹

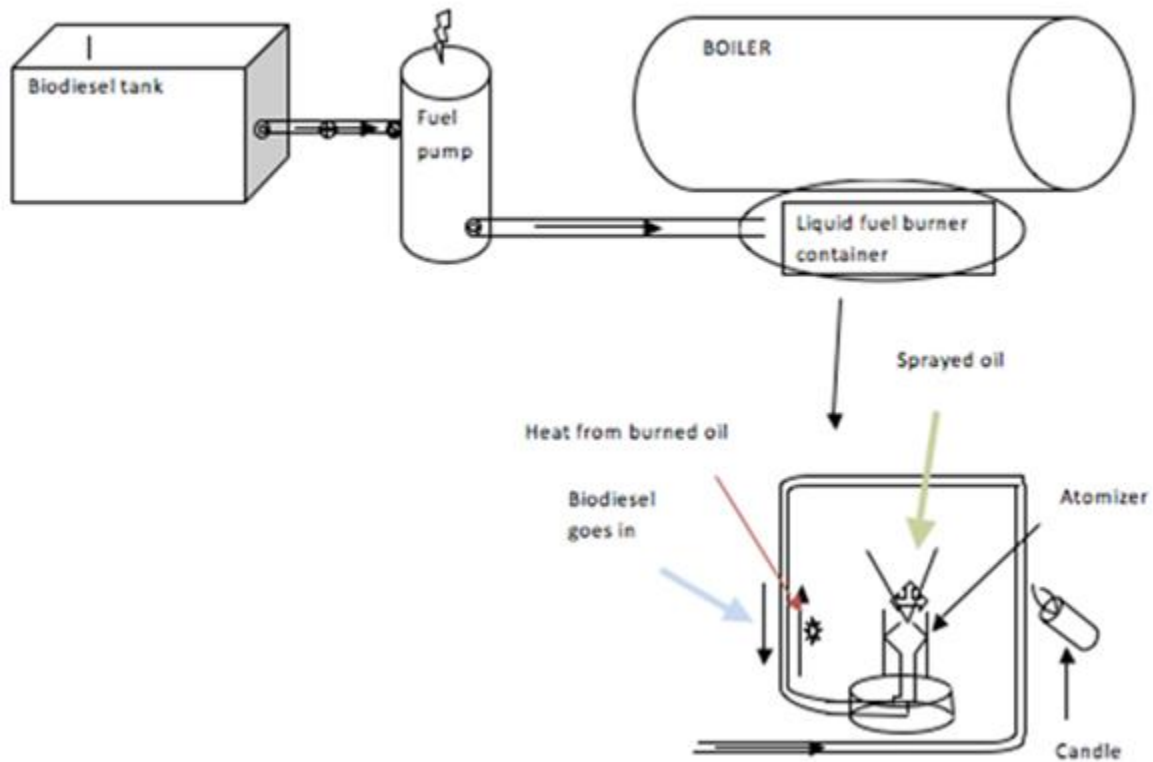

Figure 2.4.2: Schematic of energy production in the form of gas from biodiesel

Once biodiesel has been created it is placed in the biodiesel tank shown at the far left of the sketch above. An electric pump then pulls the biodiesel from the tank and pushes it through a network of PVC pipes as shown in the above diagram. Once the fuel reaches the liquid fuel burner, it is pushed through to the atomizer, which sprays the biodiesel to a fine mist. A pilot light or spark then ignites the atomized fuel, which creates thermal energy for the water boiler. Biodiesel has better lubricity than current low-sulfur petroleum diesel. The presence of oxygen in biodiesel improves combustion and therefore reduces hydrocarbon, carbon monoxide, and particulate emissions; but oxygenated fuels also tend to increase nitrogen oxide emissions. Engine tests have confirmed the expected increases and decreases of each exhaust component from engines without emissions controls. Biodiesel users also note that the exhaust smells better than the exhaust from engines burning conventional diesel.

Interactive Qualifying Project

That isn't unusual: anything with a diesel engine -- plane, boat, and motorcycle -- can run on diesel, SVO or biodiesel. SVO is a broad term, and covers a range of materials beyond vegetable oil including animal fats (chicken, tallow, lard and byproducts of omega-3 fatty acid from fish oil) and algae. SVO can be from virgin feedstock, meaning crops grown specifically as a fuel source, or recycled from other uses, such as used cooking oils (WVO for waste vegetable oil). Biodiesel is considered nontoxic, biodegradable, renewable and domestically produced.³²

Little or no modifications are needed to make a compression ignition engine (diesel engine) run on biodiesel (performance 10% less than that of regular diesel). And higher lubricity than regular diesel which increases the engine's life.

That's the basics: diesel engine originally designed to run on vegetable oil; no modification needed to run a diesel engine on biodiesel; heating mechanism needs to be added to run engine on SVO.

There are two basic choices for dealing with the viscosity of SVOs: add a heating mechanism to the fuel line or tank, or process the oils. I do both. I use SVO -- always in the form of local WVOs -- in a second fuel tank in the trunk of the car where the SVO is heated by a coil running from the radiator. The second option, modifying the oil, means using biodiesel. Biodiesel is made through a process called transesterification, a fairly simple process that uses lye to remove the coagulating properties of the oils. The byproduct of biodiesel processing is simple glycerin, used in soaps and other products).”³³

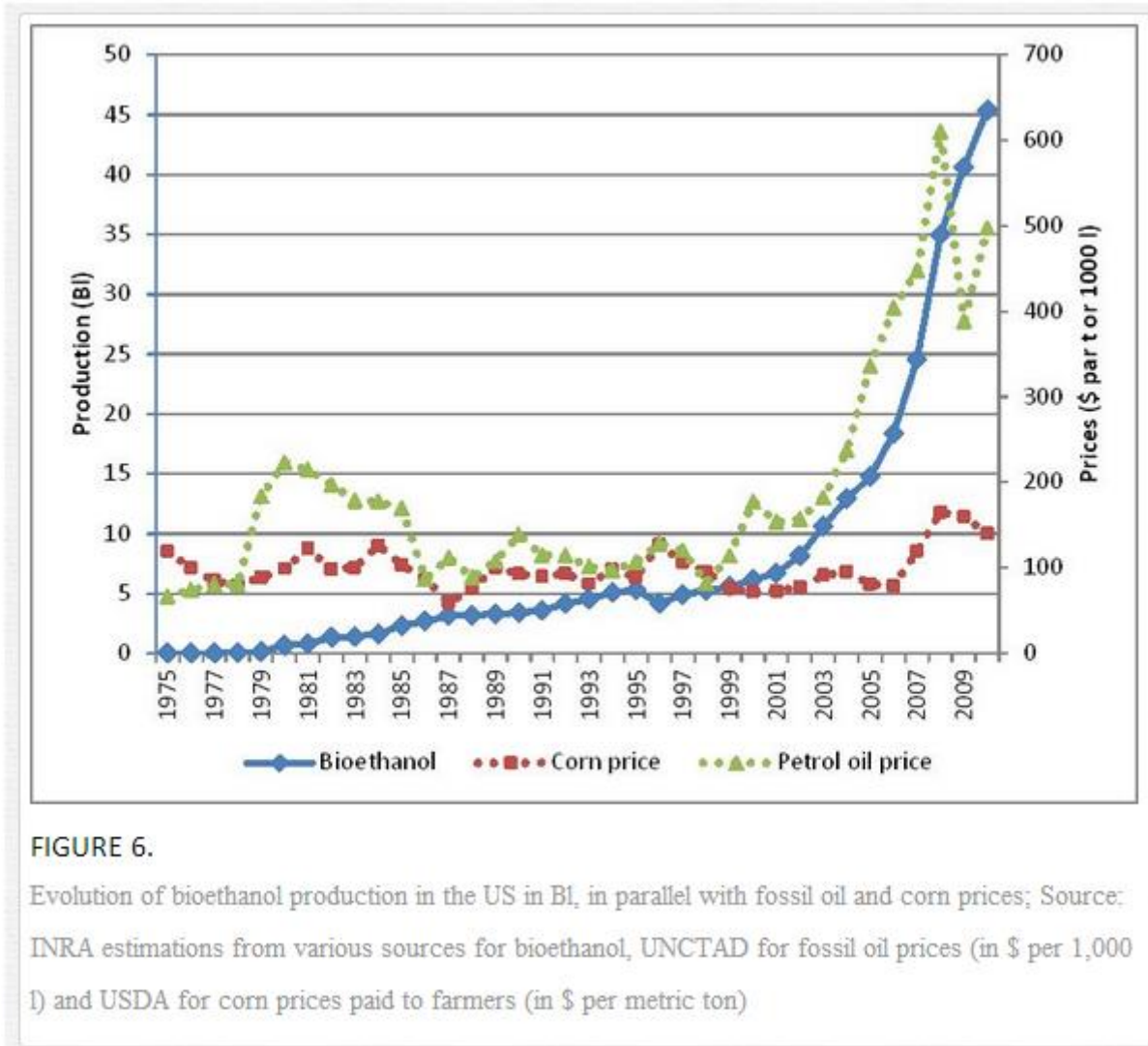

Figure 2.4.3: Comparison of Bioethano/Corn and Petrol Oil Prices over the years (1975-2010).³⁴

Research about machinery efficiency of % of biodiesel gives the following tables

Investigations have been carried out by the authors using different blends of biodiesel and diesel oil (i.e. 100%, 80%, 70%, 50%, 30%, 20% and 0% volume of biodiesel).

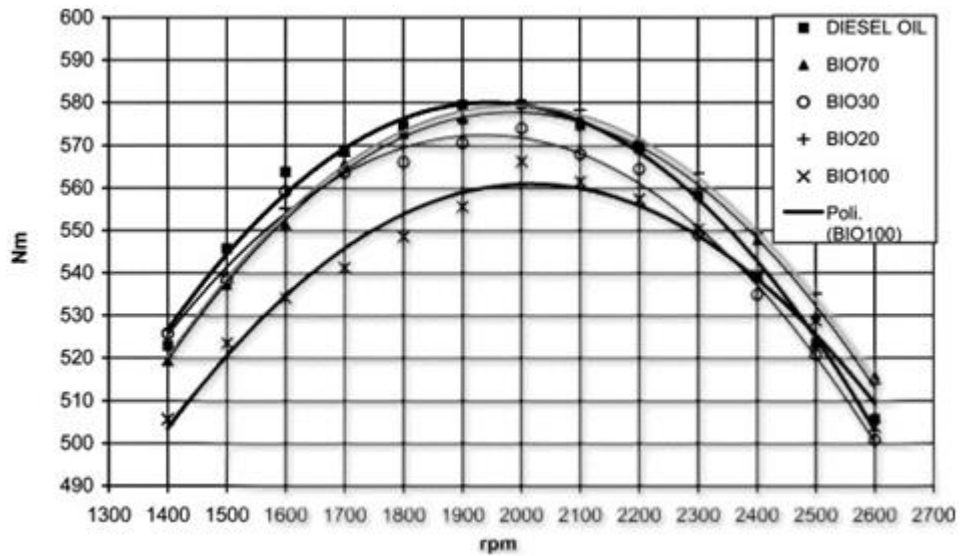

Figure 2.4.4: Nm Vs Rpm of Diesel Cons in Biofuel ³⁵

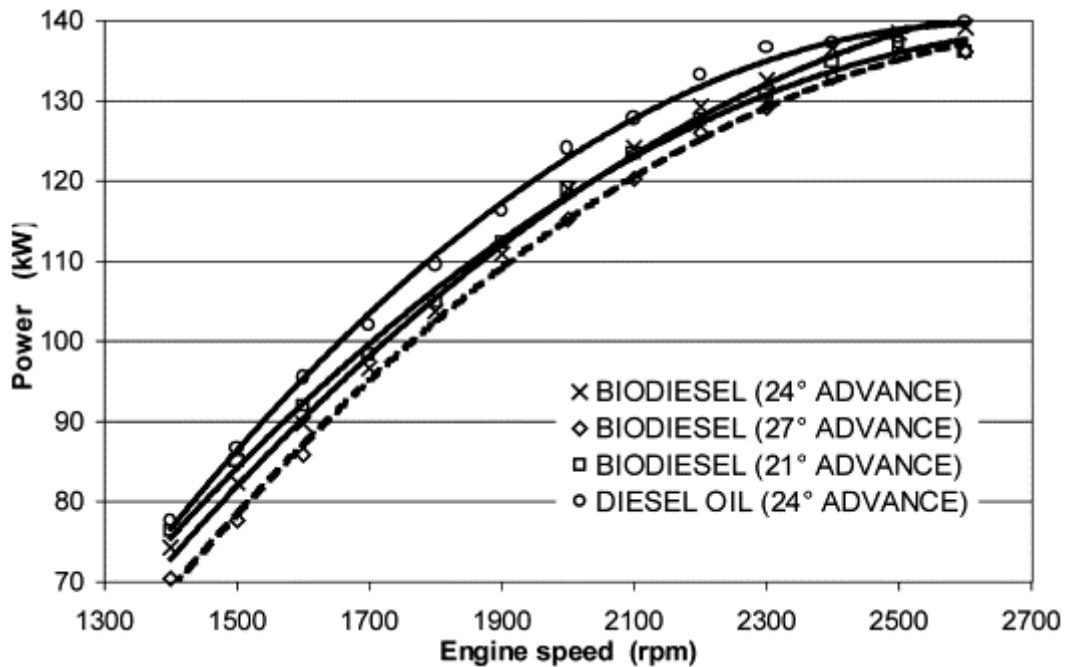

Figure 2.4.5: Power Vs engine speed between different Biofuels and Diesel Oil ³⁵

Fuel type	Calorific value (kJ/kg)	Density (g/dm ³)	Viscosity (mm ² /s)		Cetane number	Flame point (°C)	Chemical formula
			27°C	75°C			
Diesel fuel	43 350	815	4.3	1.5	47 ^a	58	C ₁₆ H ₃₄
Raw sunflower oil	39 525	918	58	15	37.1 ^a	220	C ₅₇ H ₁₀₃ O ₆
Sunflower methyl ester	40 579	878	10	7.5	45–52	85	C ₅₅ H ₁₀₅ O ₆
Raw cottonseed oil	39 648	912	50	16	48.1 ^a	210	C ₅₅ H ₁₀₂ O ₆
Cottonseed methyl ester	40 580	874	11	7.2	45–52	70	C ₅₄ H ₁₀₁ O ₆
Raw soybean oil	39 623	914	65	9	37.9 ^a	230	C ₅₆ H ₁₀₂ O ₆
Soybean methyl ester	39 760	872	11	4.3	37	69	C ₅₃ H ₁₀₁ O ₆
Corn oil	37 825	915	46	10.5	37.6 ^a	270–295	C ₅₆ H ₁₀₃ O ₆
Opium poppy oil ^a	38 920	921	56	13	–	–	C ₅₇ H ₁₀₃ O ₆
Rapeseed oil ^b	37 620	914	39.5	10.5	37.6 ^a	275–290	C ₅₇ H ₁₀₅ O ₆

Table 2.4.1: Physical and chemical specifications of the vegetable oil fuels used ³⁶

2.4.2 How to grow algae and make it fuel

Algae oil production system: the algae is harvested from the growing process as algae paste. Then we take off the water in the algae either by heat drying or de-watering presses.

Centrifuges are also another way in which the algae past can be de-watered.

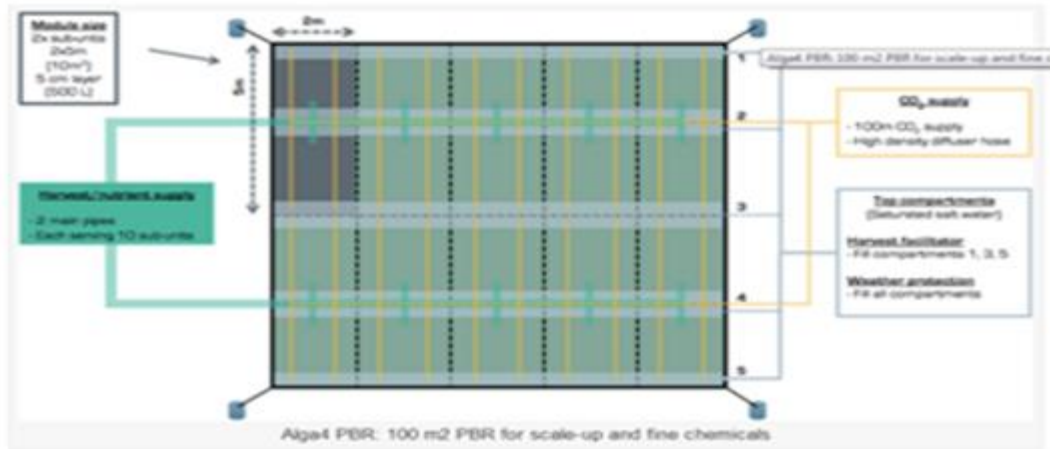

Figure 2.4.6: Algae oil production system³⁷

The oil is then separated from the paste wither by a chemical process or by pressing in a high pressure device such as a screw press. The finished product is algae oil in a form that is then suitable for use in the transesterification process to make biodiesel fuel.³⁸

2.4.3 The cost of bio-fuel from Algae

A number of methods are being used for harvesting microalgae and more are being experimented. We have provided the indicative capital and operating costs for the most common methods for microalgae harvesting.

Interactive Qualifying Project

Cost of Drum Filtration

Capital Cost	Operating Cost 1	Operating Cost 2
Approximately \$0.2 per 1000 annual gallons	Approximately \$100 per million gallons.	Approx \$120 per million gallons

Note: A 1,000,000 l / hr drum filtration system costs about \$ 400,000 (drum filter, pumps and measuring equipments)

Cost of Open and closed ponds:

Indicative Costs for Open Ponds

Capital Cost	Operating Cost 1	Operating Cost 2
\$125,000-\$150,000 per hectare	\$15,000-20,000 per hectare per annum	\$27,000-35,000 per hectare per annum

Closed Ponds

Capital Cost	Operating Cost 1	Operating Cost 2
\$200,000 per hectare per annum	\$20,000-25,000 per hectare per annum	\$40,000-45,000 per hectare per annum

Cost of Extraction Using Oil Press:

Capital Cost	Operating Cost 1	Operating Cost 2
0.5 \$ per annual gallon	\$ 35 / T (approx 12 c per gal)	\$50/T (approx 17 c per gallon)

Figure 2.4.7: Details of biofuel harvesting cost. ³⁹

Biomass gasification and combustion technologies are evolving fast and as a result the capital and operating costs for gasification vary widely. For costs specific to your requirements, it is best to consult with suppliers of individual systems. Some indicative data are reported here.

Interactive Qualifying Project

Gasification / Pyrolysis & Catalytic Synthesis

Capital Cost	Operating Cost 1	Operating Cost 2
<p>→ Large gasification + Large FT: varies between 2400 \$/T to 1400 \$/T annual diesel output, for diesel output capacities of ranging from 0.5-2.5 million T per annum</p> <p>→ Small gasification + Small FT: varies between 9000 \$/T to 8500 \$/T annual diesel output, for diesel output capacities of ranging from 0.5-2.5 million T per annum</p>	<p>Approx \$0.8 per gallon of fuel produced</p>	<p>For large gasification + large FT: \$1.5 per gallon of fuel produced</p> <p>For small gasification + small FT: \$3.3 per gallon of fuel produced.</p>

Figure 2.4.8 Cost of Gasification / Pyrolysis & Catalytic Synthesis ³⁹

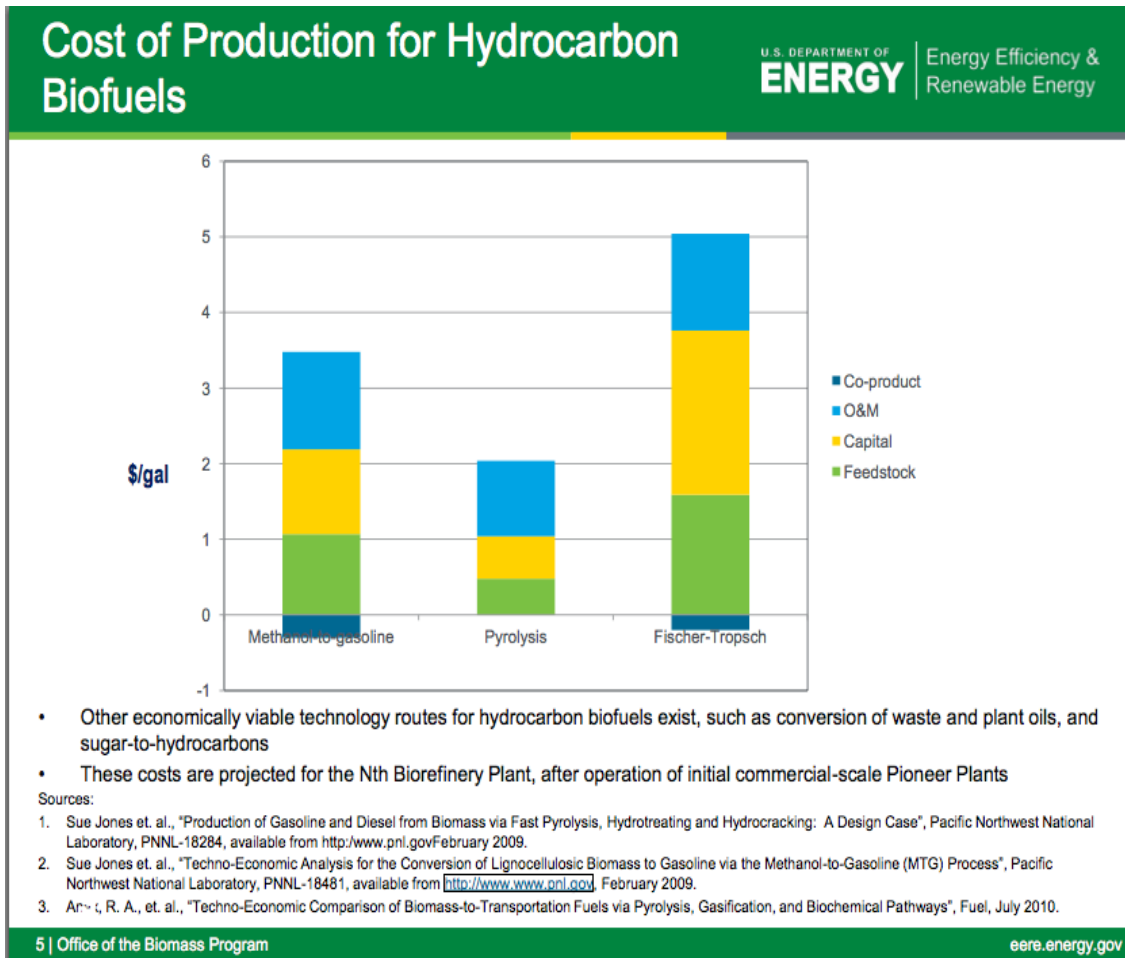

Figure 2.4.9: DOE projections of costs for biofuel from MTG, pyrolysis, and FT routes. ⁴⁰

This slide projects a future best case scenario of about \$3.50/gallon for the MTG route, \$2/gallon for the pyrolysis route, and \$5/gallon for the FT route.

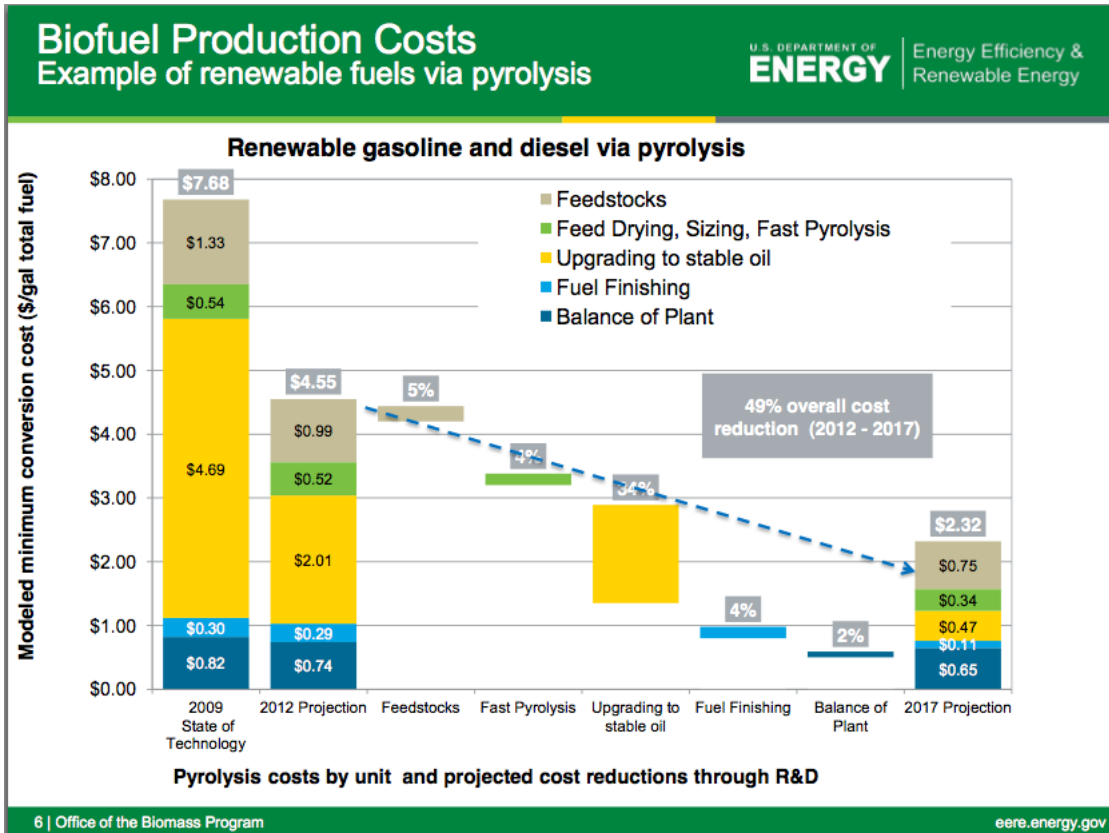

Figure 2.4.10: Projected cost reductions for biofuel from pyrolysis oil. ⁴⁰

This slide shows that in 2009 they were estimating costs of production for biofuel based on pyrolysis of \$7.68/gallon. By this year (2012) they projected the cost dropping to \$4.55, and then over the next 5 years they project costs will fall to \$2.32 (again, the Nth plant cost for pyrolysis was projected at \$2.00/gallon). They project that the largest savings will come from the upgrading step.

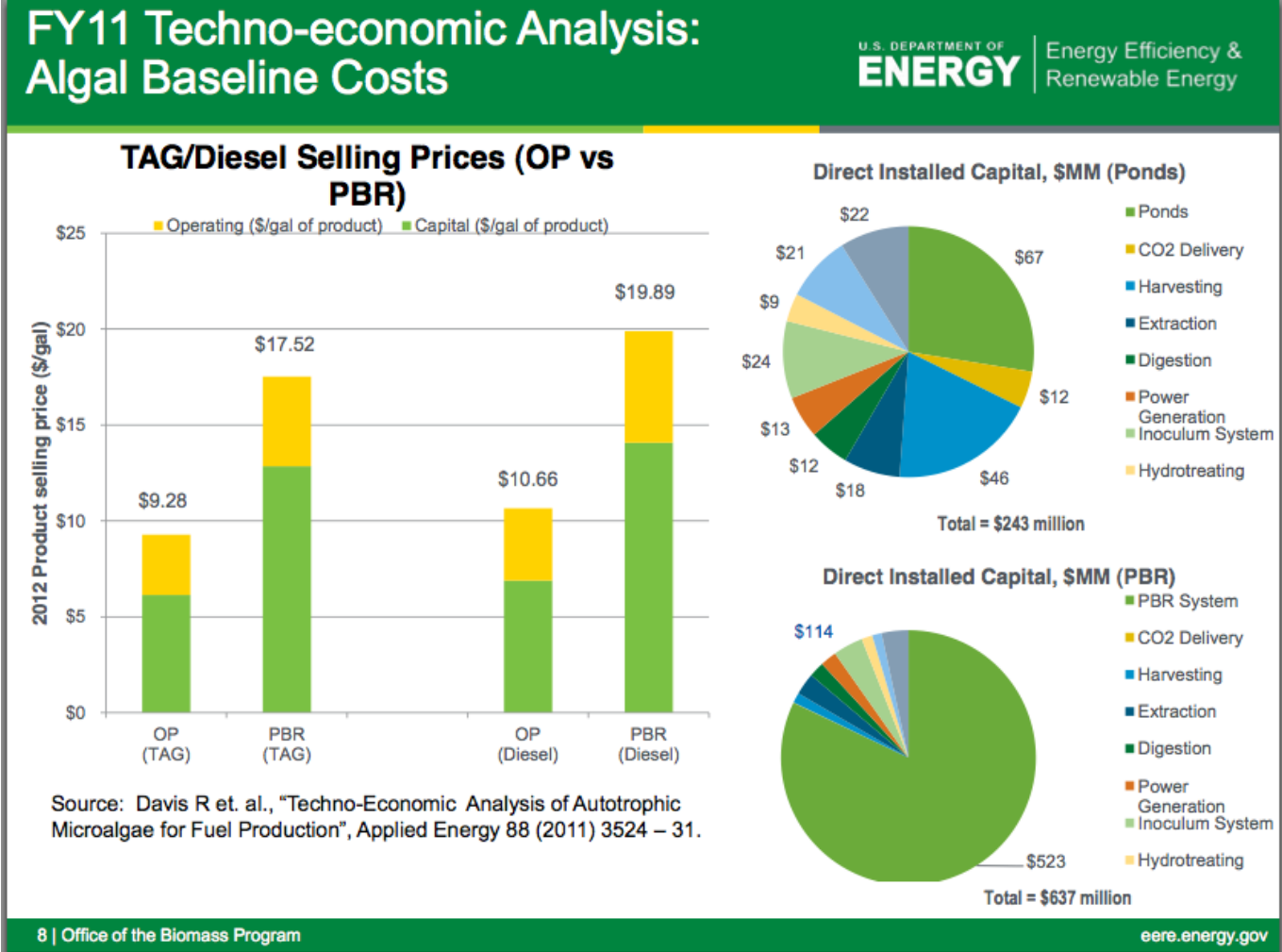

Figure 2.4.11: Baseline costs for algal fuel. ⁴⁰

This slide shows the 2012 selling price for algal products in four categories: Triglycerides (TAG) from open ponds (OP) at \$9.28/gallon and from photo bioreactors (PBR) at \$17.52/gallon, and then the finished diesel (which requires hydro treating the TAG) at \$10.66 from OPs and \$19.89 from PBRs.

The following slide projects future algal fuel costs under a number of different scenarios:

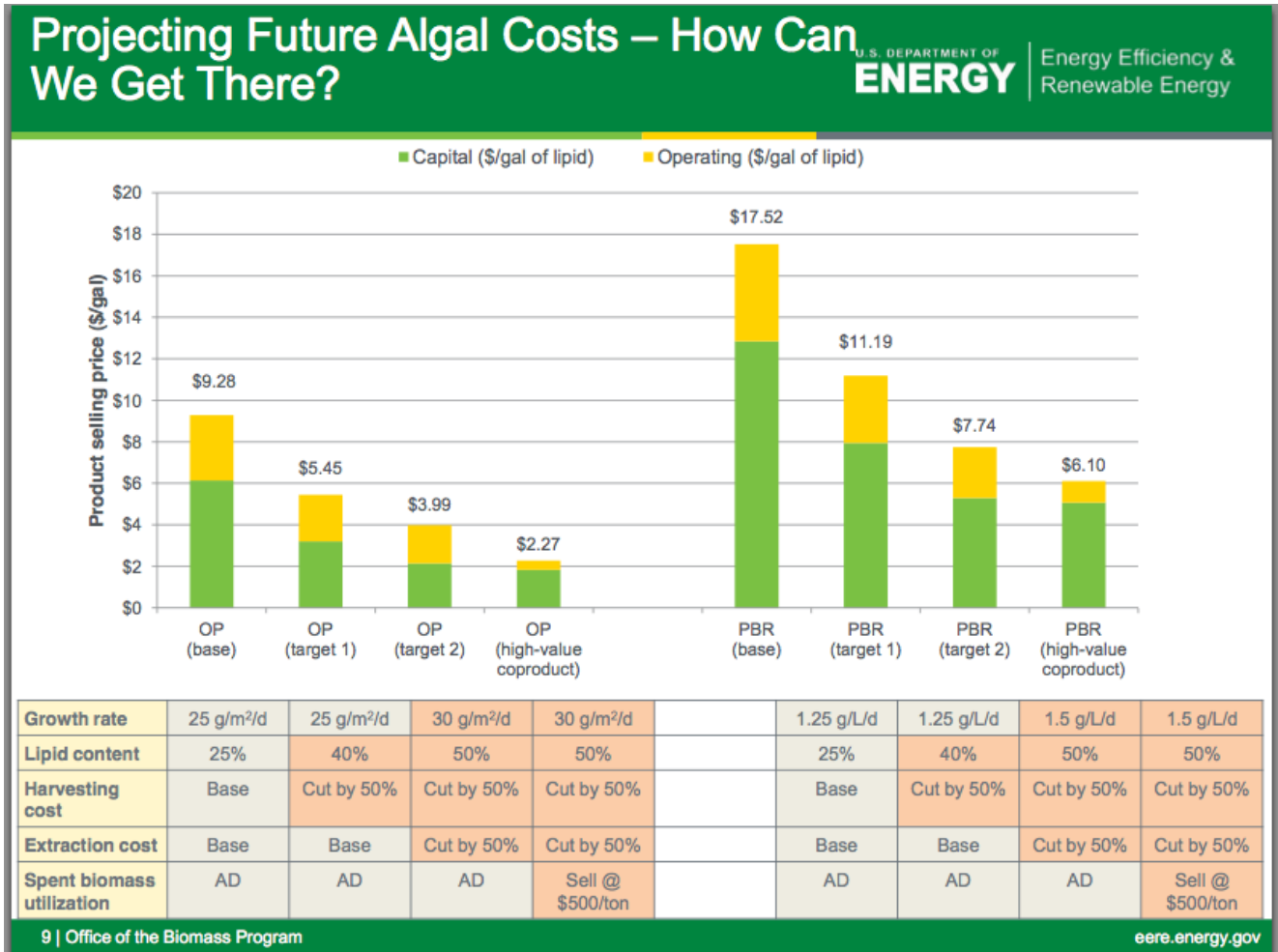

Figure 2.4.12: Projected future algal fuel costs. ⁴⁰

The production cost of the algal oil depends on many factors such as the yield of biomass from the culture system, the oil content, the scale of production systems, and the cost of recovering oil from algal biomass. Currently, algal oil production is still far more expensive than petroleum diesel fuels. For example, Chisti (2007) estimated the production cost of algae oil from a photo bioreactor with an annual production capacity of 10,000 tons per year. Assuming the oil content of the algae to be around 30 percent, the author determined a production cost of \$2.80/L (\$10.50/gallon) of algal oil. This estimation did not include the costs of converting algal oil to biodiesel, or the distribution and marketing cost for biodiesel and taxes. At the same time, the petroleum diesel price was \$2.00 to \$3.00 per gallon.

Interactive Qualifying Project

Table 1. Overall Average Fuel Prices*

	<i>Nationwide Average Fuel Price July 2014</i>	<i>Nationwide Average Fuel Price April 2014</i>	<i>Change in Price April – July 2014</i>	<i>Units of Measurement</i>
Gasoline (Regular)	\$3.70	\$3.65	\$0.05	per gallon
Diesel	\$3.91	\$3.97	(\$0.06)	per gallon
CNG	\$2.17	\$2.15	\$0.02	per GGE
Ethanol (E85)	\$3.23	\$3.41	(\$0.18)	per gallon
Propane**	\$3.07	\$3.31	(\$0.24)	per gallon
Biodiesel (B20)	\$3.98	\$4.01	(\$0.03)	per gallon
Biodiesel (B99-B100)	\$4.24	\$4.23	\$0.01	per gallon

*Includes private and public stations

**Includes primary and secondary stations

Table 2.4.2: Overall Average Fuel Price ⁴¹

Table 2. July 2014 Average Fuel Prices on Energy-Equivalent Basis*

	<i>Nationwide Average Price in Gasoline Gallon Equivalents (\$/GGE)</i>	<i>Nationwide Average Price in Diesel Gallon Equivalents (\$/DGE)</i>	<i>Nationwide Average Price in Dollars per Million Btu (\$/MBtu)</i>
Gasoline	\$3.70	\$4.13	\$32.07
Diesel	\$3.51	\$3.91	\$30.40
CNG	\$2.17	\$2.42	\$18.80
Ethanol (E85)	\$4.56	\$5.09	\$39.56
Propane**	\$4.24	\$4.72	\$36.71
Biodiesel (B20)	\$3.63	\$4.05	\$31.48
Biodiesel (B99-B100)	\$4.18	\$4.66	\$36.22

*Includes public and private stations

**Includes primary and secondary stations

Table 2.4.3: Oil Yield in Gallons per Crop ⁴²

Algae is an important source of Biofuel but its costs are too high to compete the other energy sources. Just the cultivation of algae is from 17 to 26\$ per gallon, thus the companies that want to invest in algae for the production of biofuel see a 30\$ cost per gallon.

Crop	Oil Yield Gallons/acre
Corn	18
Cotton	35
Soybean	48
Mustard seed	61
Sunflower	102
Rapeseed/Canola	127
Jatropha	202
Oil palm	635
Algae (10 g/m²/day at 15% TAG)	1,200
Algae (50 g/m²/day at 50% TAG)	10,000

Table 2.4.4: Algae has far greater oil yield per acre than conventional crops, making it ideal for land-scarcity ⁴³

2.4.4 Environmental Impact

One environmental concern with biofuels is the utilization of land and water resources. Unlike fossil fuels or certain renewable energy (such as wind and solar), biofuels require resources to grow that may be needed for other purposes and can impact the environment they are chosen to grow in. However algae can be grown on arid lands, as well as with salt water, making it extremely conservative with the scarce resources needed for agriculture. This makes algae very appealing due to not requiring a drain on other resources such as drinking water or high-yield farm land ²⁷. Because it is not impacting significant ecological systems, it would have little impact on overall biodiversity as well. Additionally, algae doesn't require the use of insecticides or herbicides, meaning there would be no additional chemical pollution to the environment ⁴⁴. One problem with algae production, however, is that it requires a large amount

of resources to maintain. Unlike corn and other biofuels, algae takes nutrients from its environment without putting much else back, and once harvested algae is stripped from the environment entirely. Because of this algae requires fertilizer and other resources to grow it that may not be needed with conventional crops. This results in having a less maintainable system than other biofuels, as algae cannot be cyclically grown with other crops as normal.⁴⁵

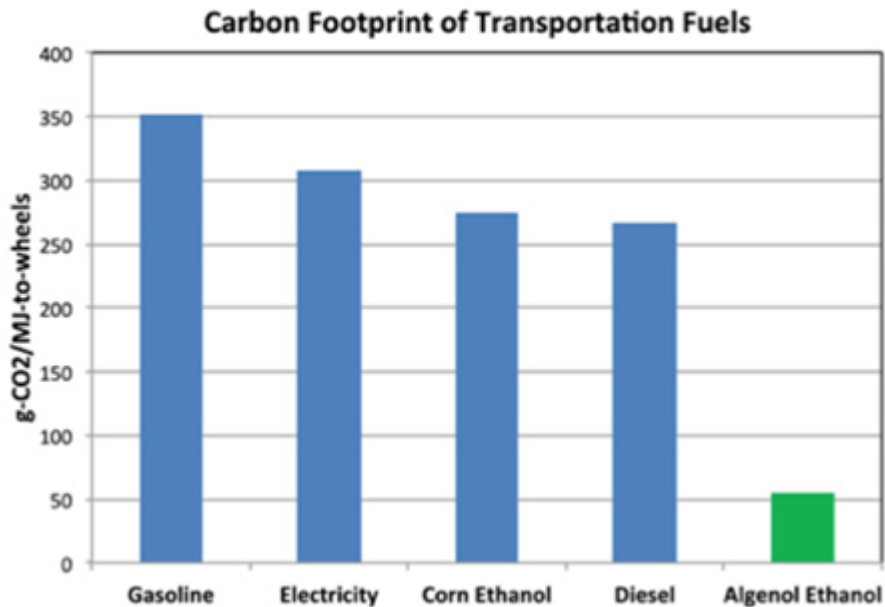

Figure 2.4.13: Algae-based ethanol has a far smaller carbon footprint than most other fuels.⁴⁶

Algae fuel is also very appealing in terms of its emissions as well. The combustion of algae fuel produces less carbon monoxide, unburned hydrocarbons, and harmful pollutants compared to diesel and petroleum, as well as emits no sulfur oxides.⁴⁴ It has also been shown that replacing fossil fuels with algae could reduce CO2 emissions by up to 80%. While this seems like an incredible improvement, it should be noted that this is a result of algae's consumption of CO2 during production. When burned, the CO2 will be released again into the atmosphere, resulting in a net increase of CO2 emissions. Therefore, while algae does have the benefit of consuming CO2, it should not be seen as a way to decrease the amount of CO2 in the atmosphere but instead as a means to maintain it.⁴⁷

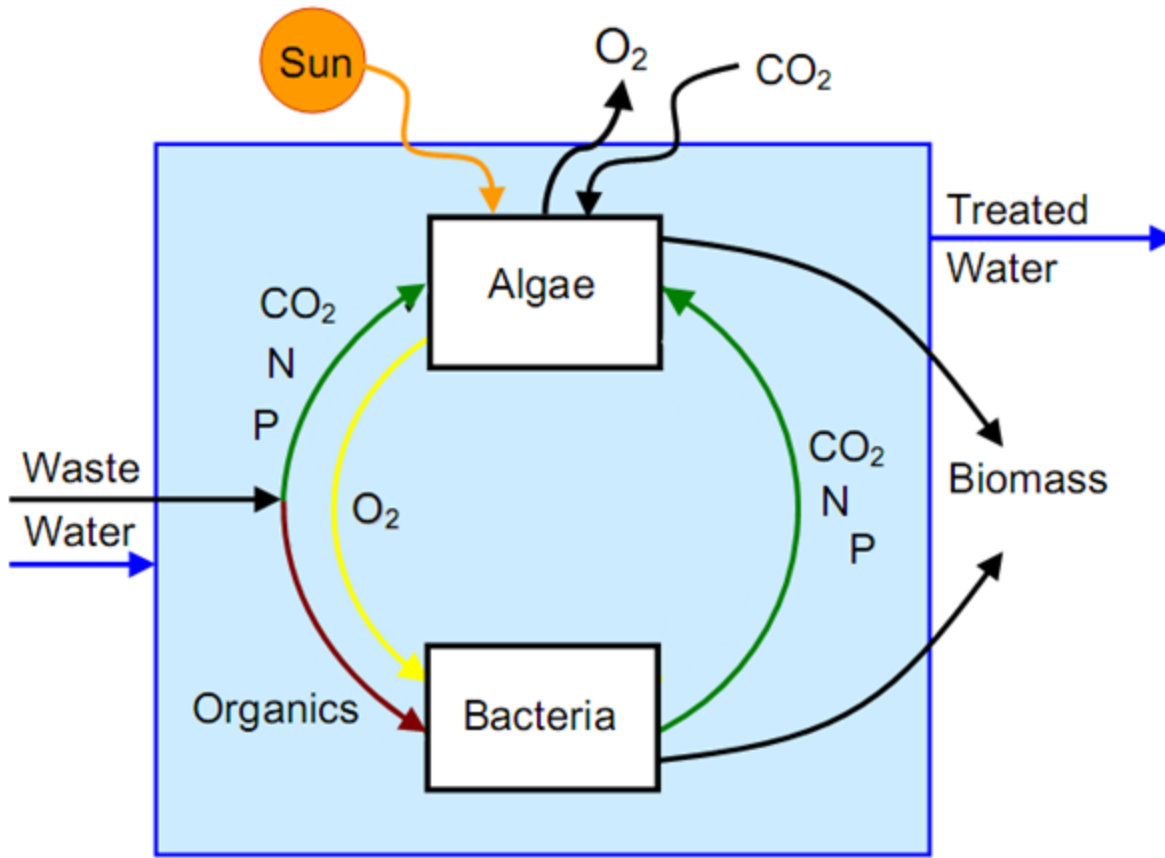

Figure 2.4.14: Algae takes nutrients from waste as well as bacteria and uses it to grow.

Additionally, microalgae has a strong impact on waste water as well. Systems for producing microalgae have the unique ability of being able to use saline waste, as well as CO₂ streams, as an energy source.⁴⁴ This is because the algae from microalgae bioreactors is capable of capturing organic compounds and heavy metal contaminants in wastewater.⁴⁸ As a result, the production of algae has the side effect of being able to recycle formerly unusable water. In fact, not only does this process clean waste water but it also recovers phosphorus from it. Phosphorus is a highly limited resource, so much so that the last reserves of phosphorus are estimated to have already been depleted.⁴⁹

2.4.5 Case Study



Figure 2.4.15: A 1-acre algae pond in Karratha, Western Australia. ⁵⁰

One company utilizing algae for a number of purposes is Aurora, Inc. They began in 2006 and now have an algae-farming facility in Karratha, Western Australia that spans nearly 1,000 acres. Karratha was chosen by Aurora for very specific reasons: the region is consistently hot and has little precipitation, and as a result has an abundance of arid land that is unsuitable for conventional farming. Additionally, Western Australia has a large amount of industrialization due to these conditions, making CO₂ emissions abundant. Aurora uses these emissions as feedstock for the algae, doing away with the majority of external nutrients needed. In fact the system they developed is highly successful, capturing over 90% of the carbon dioxide given to

the algae. When implemented in their commercial scale facility in Maitland (fifty 5-acre ponds), this was estimated to consume 40 tons of CO₂ per day.⁵⁰

Aurora's method of growing, harvesting, and processing algae is what they claim has made their business a revolutionary success for algae production. In Karratha they have 38 microponds (approximately 2 m²) used for researching optimization of growth parameters, automated harvest and nutrient feed, and a number of other methods to be decided upon before moving on to larger scale models. This is important because all of operations dealing with the algae are automatically controlled, including growing, harvest, nutrition, temperature, pH levels, turbidity, and more. When the strain of algae is believed to have been fully evaluated, Aurora moves on to their four 50 square meter and four 400 square meter inoculation ponds to produce the algae cultures. These cultures are used to seed six 1-acre production ponds, which all together produce around 15 tons of algae biomass per month. When the pond reaches a certain population density, a portion of the algae is moved to a flocculation tank to undergo dissolved air flotation (DAF) for separation. While this may seem like a large amount of water, keep in mind that the algae is actually being grown in seawater. Brackish, farm-filtered water is then used to harvest and process the algae. In total this results in the amount of water required being less than 1 percent of the water used to grow soy. Between this and the CO₂ consumption of the algae, Aurora is able to produce bioenergy with a facility footprint 5% the size of cellulosic technologies.⁵⁰

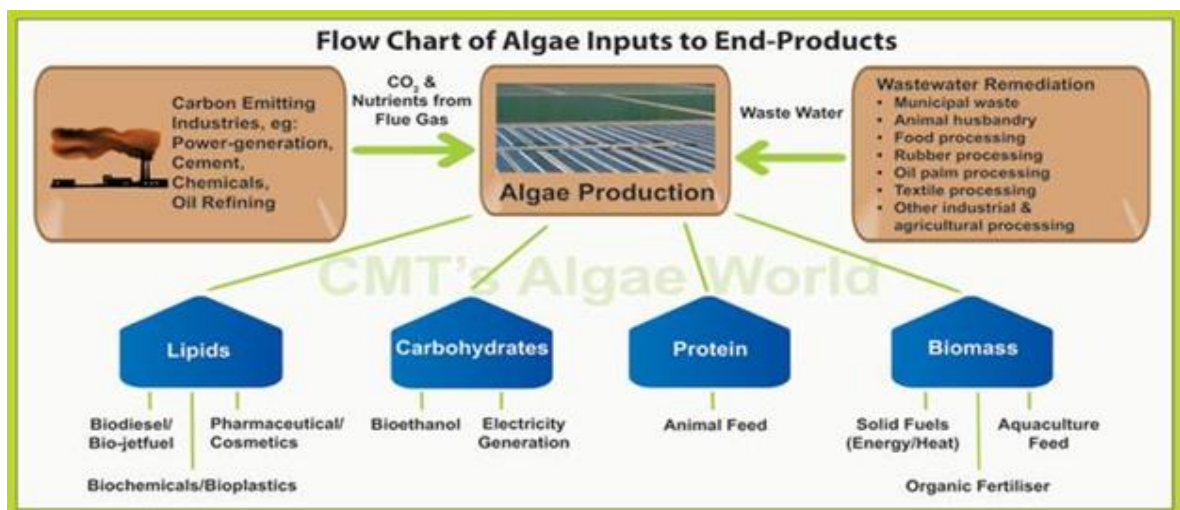

Figure 2.4.16: Processing algae has a number of different applications. 51

Interactive Qualifying Project

In addition to being environmentally friendly with both water and CO₂ consumption, Aurora claims to use all components of their algae to completely eliminate waste. They produce pharmaceuticals and health supplements due to the Omega-3 fatty acids produced by algae as well as the algal oil containing 65% EPA (a recognized treatment for lipid management, anti-inflammation, depression, and other diseases), food/beverages from the Omega-3 along with protein extracts, fish feed from algal biomass and nutrients, and lastly biodiesel from algal oil. Any remaining constituent is recycled into their system for nutrients, creating zero net waste.

2.5: Others

2.5.1 Heat Engines

These use energy in the form of heat in order to produce work and dump the rest of the heat that couldn't be converted into work. Thus a heat engine cannot convert the heat from a hot reservoir into an equal amount of work (such a thing could be done only by machines of second generation (doesn't exist))

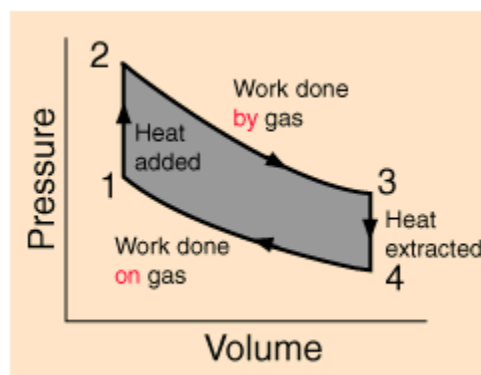

Figure 2.5.1: Heat engine ⁵²

Its efficiency is given by:

$$E_f = 1 - T_c/T_h = 1 + Q_c/Q_h = W_{\text{cycle}}/Q_h$$

Thus the efficiency of a system increases as the T_c goes closer to absolute zero (0 Kelvin)

Interactive Qualifying Project

Here are some examples that will help us solve possible questions concerning the energy production and the work done.

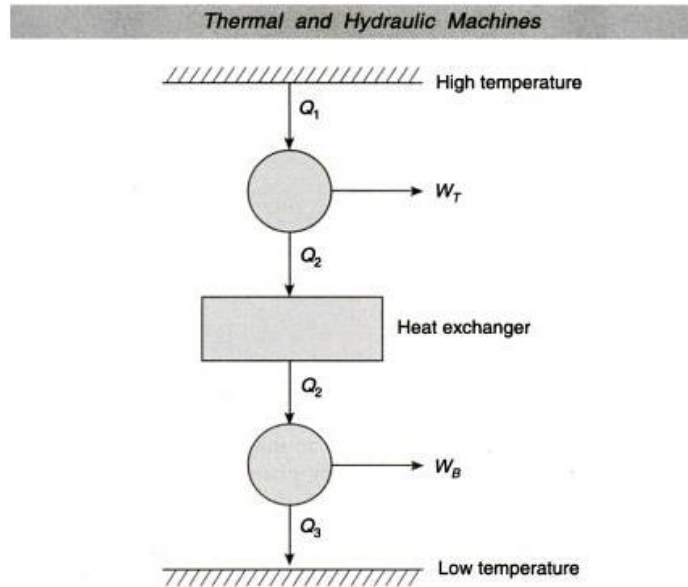

FIGURE 3.18 Two cycles coupled in series (Problem 24).

Figure 2.5.2: Heat exchanger

These are just two examples which can help us determine the heat losses based on work and temperature difference in each case. In addition there is a categorization of the two different kinds of heat engines used.

- 12.** Determine energy or unavailable energy if a heat engine is working between the temperature limit of 1000 and 300 K. Heat delivers to engine is 1000 J and work output is 400 J.

$$\Delta S = \frac{Q_1}{T_1} + \frac{Q_2}{T_2}$$

Here

Q_1 = heat supplied to the engine

Q_2 = heat rejected by the engine

$$Q_1 - Q_2 = W$$

or

$$\begin{aligned} Q_2 &= Q_1 - W \\ &= 1000 - 400 = 600 \text{ J} \end{aligned}$$

$$\Delta S = \frac{-1000}{1000} + \frac{600}{300}$$

$$= 1 \text{ J/K}$$

$$\therefore \text{Unavailable energy} = T_2 \times \Delta S$$

$$= 300 \times 1$$

$$= 300 \text{ J}$$

14. A reversible heat engine operated between two reservoirs at temperatures of 600°C and 40°C (Figure 3.15). The engine drives a reversible refrigerator which operates between reservoirs at temperature of 40°C and -20°C. The heat transfer to the heat engine is 2000 kJ and net work output of the combined engine-refrigerator plant is 300 kJ. Evaluate the heat transfer to the refrigerator and the net heat transfer to the reservoir at 40°C.

(UPTU: Dec. 2005)

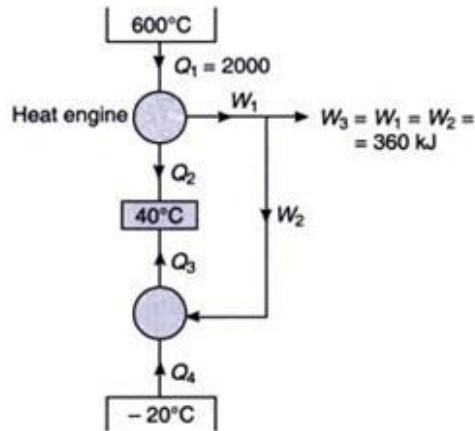

FIGURE 3.15 A reversible heat engine system (Problem 14).

$$T_1 = 600 + 273 = 873 \text{ K}$$

$$T_2 = 40 + 273 = 313 \text{ K} = T_3$$

$$T_4 = -20 + 273 = 253 \text{ K}$$

$$T_4 = -20 + 273 = 253 \text{ K}$$

$$\eta_{\text{HE}} = \frac{T_1 - T_2}{T_1}$$

$$= \frac{873 - 313}{873} = \frac{560}{873}$$

$$\frac{W_1}{Q_1} = \eta_{\text{HE}} = 0.641$$

$$W_1 = 0.641 \times 2000 = 1283 \text{ kJ}$$

$$W_2 = W_1 - W_3 = 1283 - 360 = 923 \text{ kJ}$$

$$Q_2 = Q_1 - W_1 = 2000 - 1283 = 717 \text{ kJ}$$

$$\text{COP}_{\text{ref}} = \frac{T_4}{T_3 - T_4} = \frac{253}{313 - 253}$$

$$= \frac{253}{60} = 4.22$$

$$\text{COP} = \frac{Q_4}{W_2} = 4.22$$

$$\therefore Q_4 = 923 \times 4.22 = 3895 \text{ kJ}$$

$$Q_3 = W_2 + Q_4 = 923 + 3895$$

$$= 4818 \text{ kJ}$$

\therefore Heat transfer to the refrigerator (Q_4) = 3895 kJ
 Heat transfer to the reservoir at 40°C = $Q_3 + Q_2 = 5535$ kJ

Figure 2.5.3 Thermal and Hydraulic machine equations ⁵³

The two different types of heat engines:

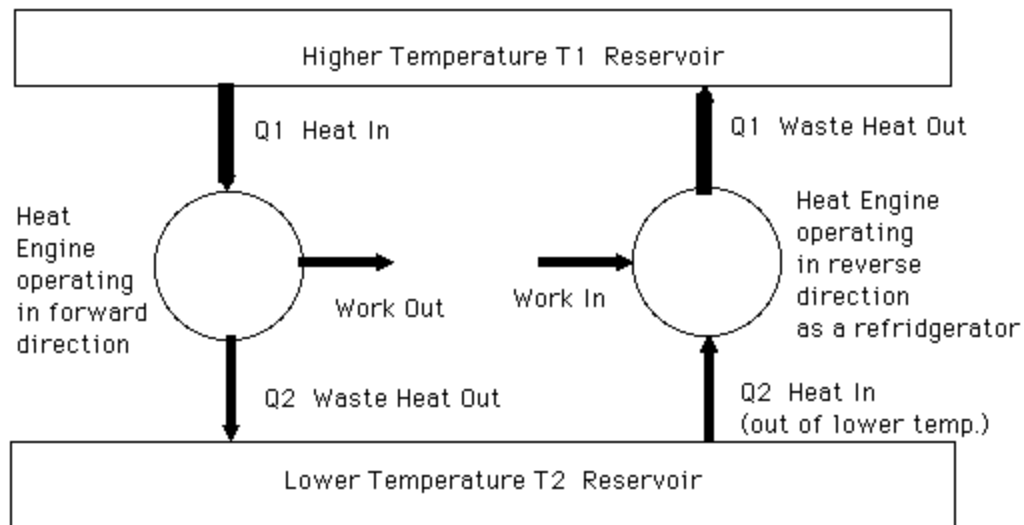

Figure 2.5.4: Heat Engines ⁵⁴

2.5.2 The Stirling engine

Invented in 1816 by Roberst Stirling who tried to create a safer steam engine that wouldn't explode due to their boilers. A Schematic of such a device is the following:

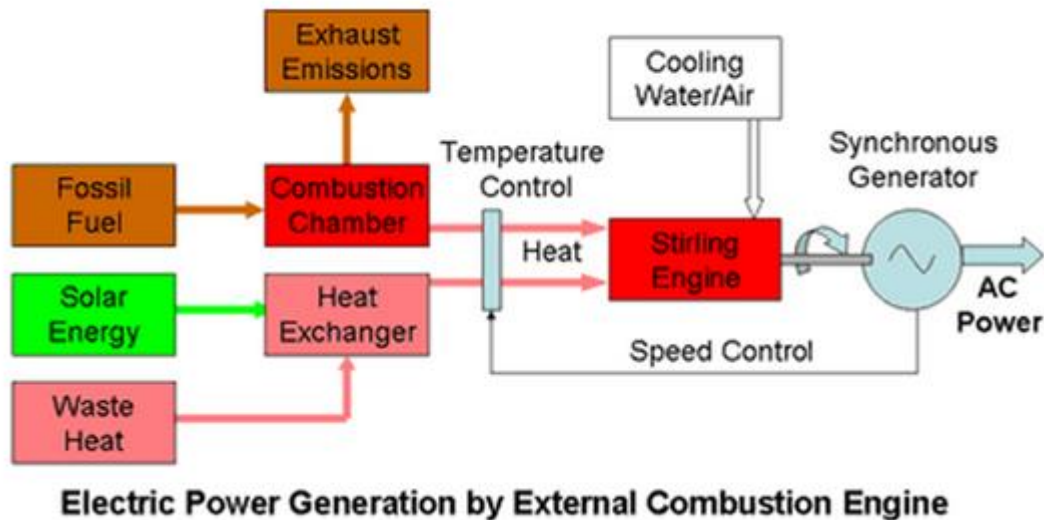

Figure 2.5.5: Electric Power Generation By external Combustion engine (Stirling Engine) ⁵⁵

It is a closed (only heat can transfer no mass) cycle heat engine. It is totally sealed from the outside environment and it works using the expansion and compression of gas (i.e. air, helium or hydrogen or a combination which will allow a maximization of expansion and compression difference) that is trapped in this engine. The one side is heated and the other I is cooled causing the gas to be compressed and expanded cycles. So if we see the energy conversion we have: Heat to work/ kinetic energy.

Stirling engines working on low temperature differences are called LTD that can create work only from the heat of our hand or coffee.

There are two aluminum plates where one is hot and one is cold. Since the machine can work in reverse so we can heat either side. The displacer takes the gas to the hot and to the cold location. When the displacer is at the hot location the gas is pushed to the cold location as it is expanded and it is pushed back to the hot side as it is compressed.

Interactive Qualifying Project

“As we add heat to the system through the bottom plate, the temperature of the air increases, therefore increasing the pressure between the lower plate and the displacer. The displacer is pushed upwards by this pressure which moves the flywheel, directly turning the energy from the heat into rotational mechanical energy. As the flywheel turns it moves a small piston on the other side downward, increasing the pressure on the top of the plate pushing the displacer down. Now the air has been pushed into the space above the displacer and below the cold plate. The air is cooled by the cold plate and drops, further pushing the displacer down. This in turn moves the piston the opposite direction which moves air below the displacer that this process may repeat itself.”

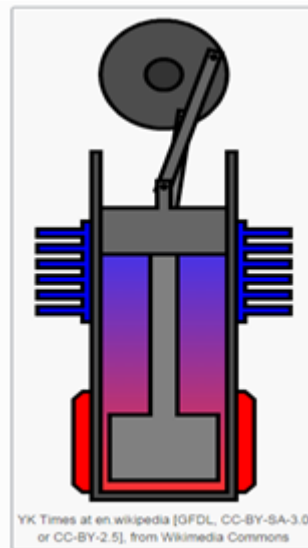

Figure 2.5.6 Stirling Engine ⁵⁶

Interactive Qualifying Project

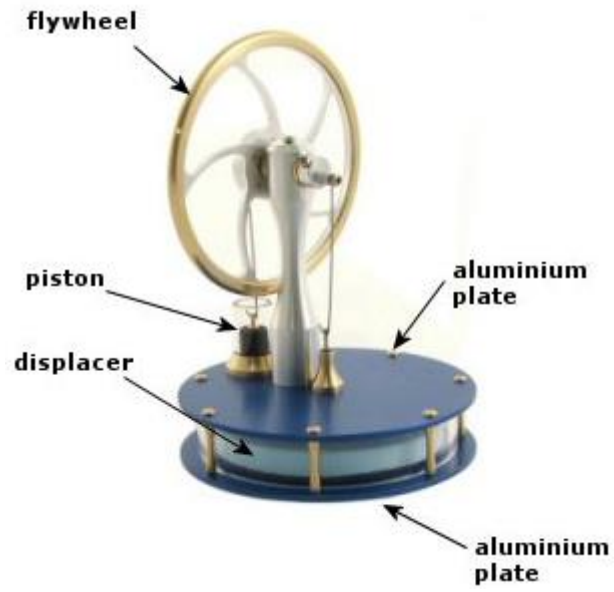

Figure 2.5.7: Naming the parts of the device



Figure 2.5.8: Charging our now using a Stirling device

Interactive Qualifying Project

Epiphany labs created a stirling engine (epiphany onE puck) which works by heating or cooling down a fluid that it is held in the device. They support that if u heat the one side or cool the other then it can create a charge of 5W which can charge most of the smartphones. (Successfully funded on April 6 2013).²

Radiofrequency generator machine can release the hydrogen and oxygen form saltwater and create a lot of energy (flame) if we place a bulb in-between it lights and that is a way how we could heat the one side of the pipe much more! The energy needed will be supplied from the initial T difference between the two plates in the ocean. However, it is inefficient thus; easy thermal energy could really help.

But since there are great heat loses maybe an idea of perfecting it is by isolating the whole system again. The hot water going in should not be allowed to be disposed without gaining from it most of its heat thus we would need to have sensors that would open and close valves allowing the water to go in and out but we should keep the cold reservoir as cold as possible thus it should be open from the bottom. How to heat the water up to the point we need. We would use a radiofrequency machine to heat the water to higher T in order to increase the energy produced. The energy form this machine will be supplied from the engine and that is a restriction as in the beginning it will take more time for the supply of energy to increase. So, what should be the seawater difference in temperature?

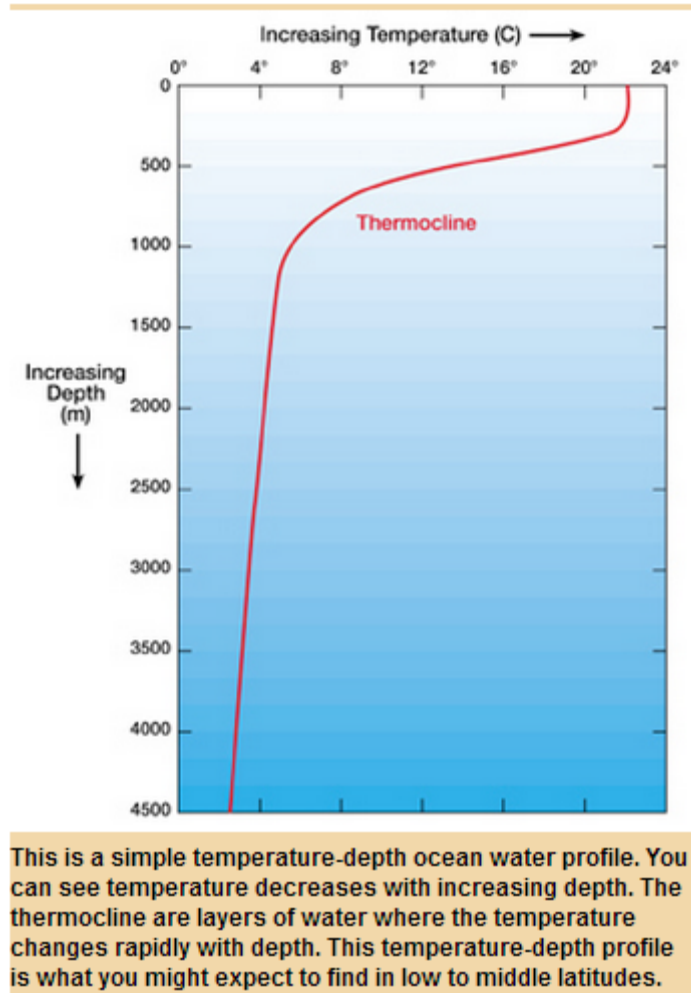

Figure 2.5.9: Temperature of Ocean water ⁵⁸

But we need to take under consideration that the T changes between summer and winter and also changes depending from which place around the world we are.

ΔW is the total mechanical work:

$$\Delta W = W_{12} + \Delta W_{34} = -nR(T_2 - T_1) \ln \frac{V_2}{V_1}$$

So finally the efficiency is

$$\eta = \frac{T_2 - T_1}{T_2 + \frac{C_V(T_2 - T_1)}{nR \ln V_2/V_1}} < \eta_C.$$

Figure 2.5.10: How much energy can a Stirling device produce? ⁵⁶

Thus assuming the CV (heat capacity) of water to be around 74 J/ (K*mol) and we assumed that the volume of the water when heat (v2) is twice as when it is cold(v1) and 1 mole of sea water and a ΔT of 16 degrees Celsius we get an efficiency of 3% but if we use the firstly stated equation which takes into account only the ΔT then we get a 5% efficiency. Under the same condition the amount of work done is -92 J.

There are no data about such a construction yet thus further team research is needed. Hopefully with the correct assumptions and work we can give you a correct approximation of the total cost of such a machine working independently in the ocean.

Using the Thomson Coefficient theory μ . It states that if μ is greater than 0 then the gas when expanded it is cooled. Also if μ is less than 0 then the gas when expanded it is heated.

Thus the new question is what kind of gas do we need, and should it be bimolecular unimolecular or other.

My opinion is that we need to find a unimolecular Substance that is heated when expanded. The reason for the second reason is because the ocean can't be that hot so the greater the heat produced the more beneficial is for us.

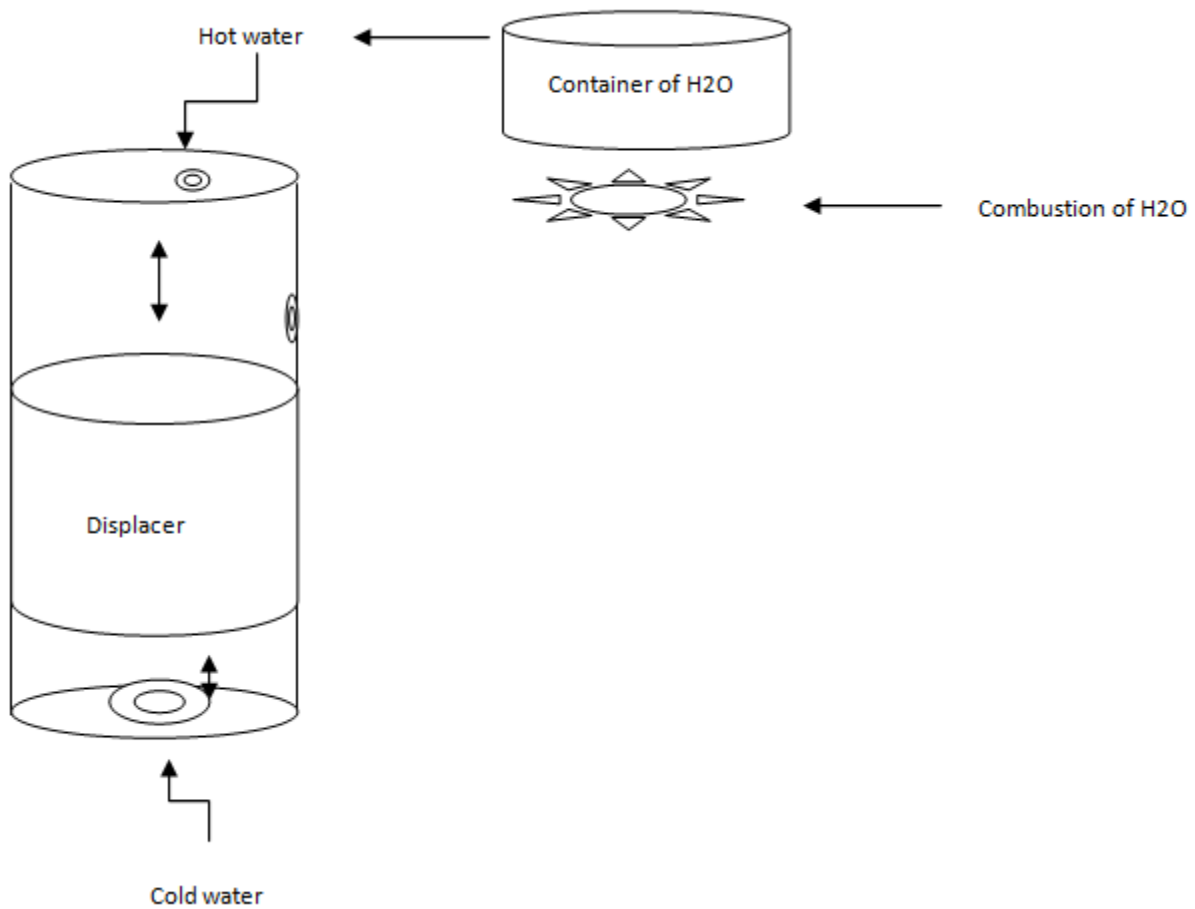

Figure 2.5.11: Sea water Stirling Device Model

2.5.3 Hydroelectric

One form of alternative/renewable energy that will contribute to future energy needs is hydroelectric. This is the process of capturing energy from flowing water and turning it into electricity. It is currently the largest supplier of energy of any renewable resource, as well as the most efficient method of harvesting energy out of any resource. Hydroelectric power is most commonly seen in dam, however they are far from the only source of hydroelectric power. Turbines can be implemented in flowing bodies of water (such as rivers/streams) to channel energy without the need of a reservoir (known as run-of-the-river hydroelectricity). They can also be implemented within man-made conduits to gather energy from water being transferred (known as conduit hydroelectricity). Lastly, marine power is energy taken from the ocean

Interactive Qualifying Project

through a variety of resources. These include marine current power, ocean thermal energy conversion, osmotic power, tidal power, and wave power.²

Dams are placed on a river or other medium sized body of water to create a reservoir. This reservoir releases water through a turbine, which is spun by the water and powers a generator. Dams and similar constructs also have a variant known as a pumped storage plant, which uses pumps (consuming energy) to move water from a lower reservoir/water source to a higher one, which can then flow back through the turbines to reproduce the energy. As the name suggests, this method is a way for hydroelectric power sources to store energy until it is needed. Dams have been shown to be particularly harmful to their surrounding ecosystem, however, causing shifts in sediment depositories, flooding surrounding land, and killing some of the wildlife that travels through them. Despite this, it is the world's largest renewable energy resource, generating 654 GW. There is an estimated 4,000 GW potential to be harvested, however only 1,000 GW is estimated to be feasibly obtainable.⁵⁸

While hydroelectric power from freshwater sources often has a detrimental effect on the environment, its usage is undeniable. This is due in part to the relative cost-efficiency of such systems. Below is a graph that demonstrates the levelized cost of various sources of energy. This cost is calculated based on the initial start-up cost, maintenance costs, operational/fuel costs, and government incentive programs. Because of this last variable, the chart cannot be taken as a pure representation of each source's relative cost. However the insight it provides shows why hydropower is such an appealing resource right now.

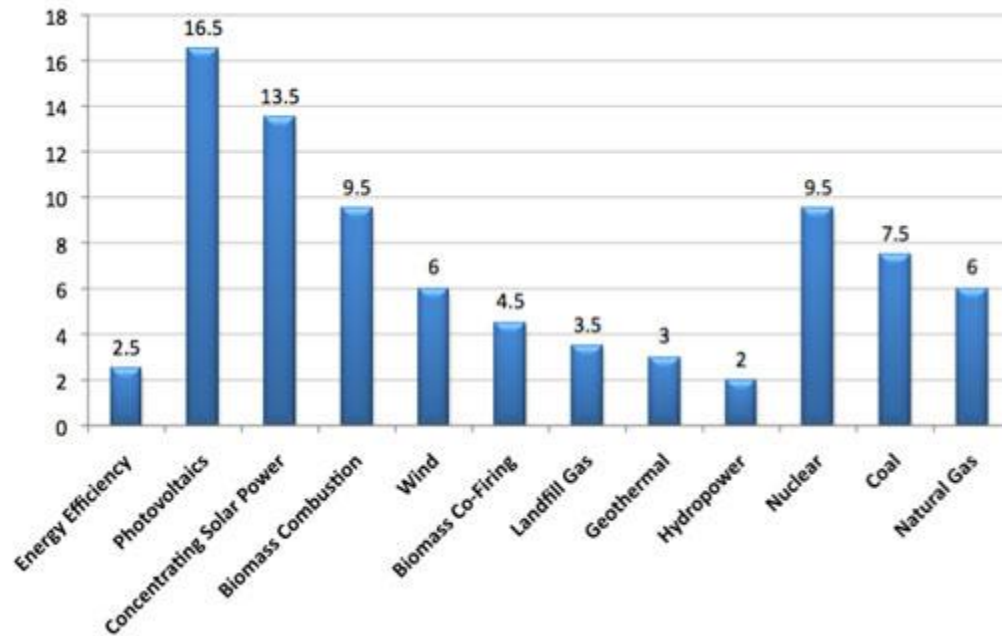

Figure 2.5.12: Levelized cost of various energy sources. ⁵⁹

Ocean waves are formed from the interaction of long-lasting wind and surface water. The momentum of these waves can be captured in order to retrieve and energy. There are a number of different devices/models that can be used to capture this energy, however there are still very few ever produced or in actual use today. The “Salter’s duck” is one such device, which uses a floating body anchored to the sea bed (or cliffs) by various lines. These lines have devices on them such that when the floating body pulls on them (when moving over a wave), the devices will gather mechanical energy from the tension. This was found to extract 90% of the energy in waves during tests, however was never put into production. Another, the “Anaconda”, is a suspended rubber “snake” that works by sucking in water during a pressure difference brought on by a wave. This water evens out the pressure of the snake by running through the middle of it, past a turbine, and the out the other end. Wave energy has been estimated to have a potential of generating 1,000-10,000 GW, with a practical estimate being 500-2,000 GW. To date, however, only 2.5 GW are being harvested. ⁵⁸ This is due in part to the large cost associated with the development, installation, and maintenance of the machines required to harvest the energy, as

Interactive Qualifying Project

well as the risk of storms destroying them. The Anaconda is currently one of the best candidates however, due to its potential to be able to withstand severe conditions during storms.²

Tides are caused primarily by the gravitational pull of the sun and moon on Earth's bodies of water. Because of this, tidal strength varies greatly depending on location as well as the time of year. Tidal current below the water's surface can be harnessed using turbines, however this often doesn't produce very much energy due to the small area of effect. The advantage of this method is that the machines needed are low cost, have minimal impact on the environment, and don't require further infrastructure. Another way to harvest tidal energy is with a "tidal barrage" (known as impoundment tidal energy), which uses a dam built beneath the water that utilizes tides to gather water. This then water flows through the dam and powers turbines. These dams have a moderate environmental impact however, leading to the alternative "tidal lagoon". These lagoons are built near bodies of water that will be brought in by the tide to fill them. The water can then flow back into the body of water and power turbines on its way out. Because they don't need to be directly in bodies of water, tidal lagoons are more environmentally friendly. Finally, dynamic tidal power is a way to make normally unusable tides practical. It involves building a bent T-shaped dam out from a coast, and then allowing a head to form on either side of the dam due to tidal shifts from the moon. These would power bi-directional turbines as they leveled out, resulting in a reliable source of energy. This is, however, one of the most expensive forms of tidal energy leading it to be less practical. There is an estimated 2,500 GW of energy to be gathered from tides, 1,000 GW of which would be practical. To this day only 59 GW of energy is being harnessed.⁵⁸ This is due, in part, to tidal power's steep cost of implementation, requiring unusually strong tides in order to be affordable. These tides do exist, however only in certain areas around the globe, making tidal power limited to these areas for the time being. Though the availability and cost make tidal power unappealing, it does offer the advantage of predictability which is a valuable attribute in renewable energy.²

The current costs to implement wave and tidal powered hydroelectric systems is too high to be effective. This is due in part to the large initial cost to implement these systems, however also because of the dramatic change in efficiency based on location. Currently, the leveled cost of wave energy is estimated to be between 10 and 30 cents per kWh. Tidal energy is estimated to be between 8 and 12 cents per kWh. Future development however will see a steady decline to

these costs, bringing wave energy down to 5-6 cents/kWh and tidal to 4-6 cents/kWh. ⁶⁰ These are only estimates for the time being, so it is unclear whether they will come to fruition. Still, the potential for localized markets is very real and will most likely be acted upon in the future.

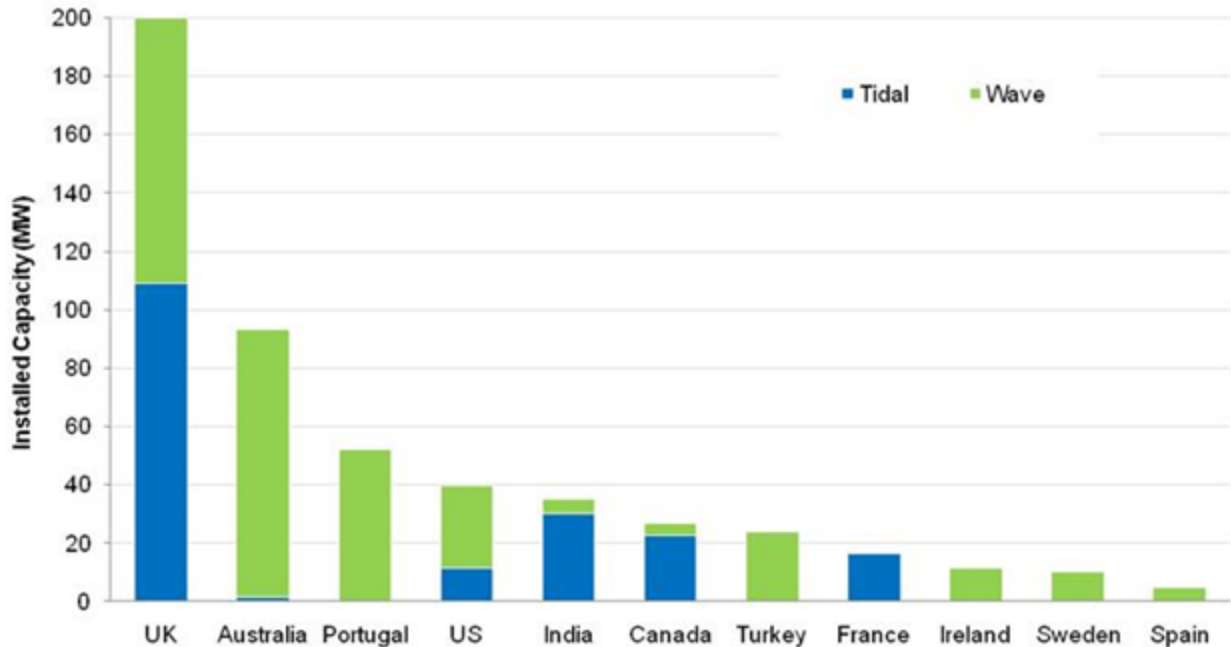

Figure 2.5.13: Wave/tidal pipeline capacity for 2010-2015 ⁶¹

Lastly, ocean thermal energy conversion (OTEC) is a proposed system of gathering energy from the heat difference between surface and deep ocean water. A heat engine would be used to connect the surface to the bottom (or sufficient depth) and produce energy based on the differing temperature. This difference would be very small, resulting in a small amount of efficiency (about 6-7%). Despite this, however, the available locations worldwide where this system could be implemented makes it extremely attractive. The estimate energy potential is 200,000 GW, with the feasibly gatherable energy being around 10,000. ⁵⁸ There are currently no large-scale OTEC systems in place today, and will probably not be for the foreseeable future. This is largely due to the financial aspect of the system, both for installation and maintenance (running water throughout the system). Because there are no systems currently in place, it is

unclear what the actual cost-per-MWh of OTEC would be. It is rumored that the cost could be as low as 7 cents, however there isn't substantial data to support this.²

	Potential (GW)	Feasible (GW)	Current (GW)
Freshwater	4,000	1,000	654
Wave	1,000-10,000	500-2,000	2.5
Tidal	2,500	1,000	59
OTEC	200,000	10,000	0

Figure 2.5.14: Hydroelectric power sources and their estimated/actual power output.⁵⁸

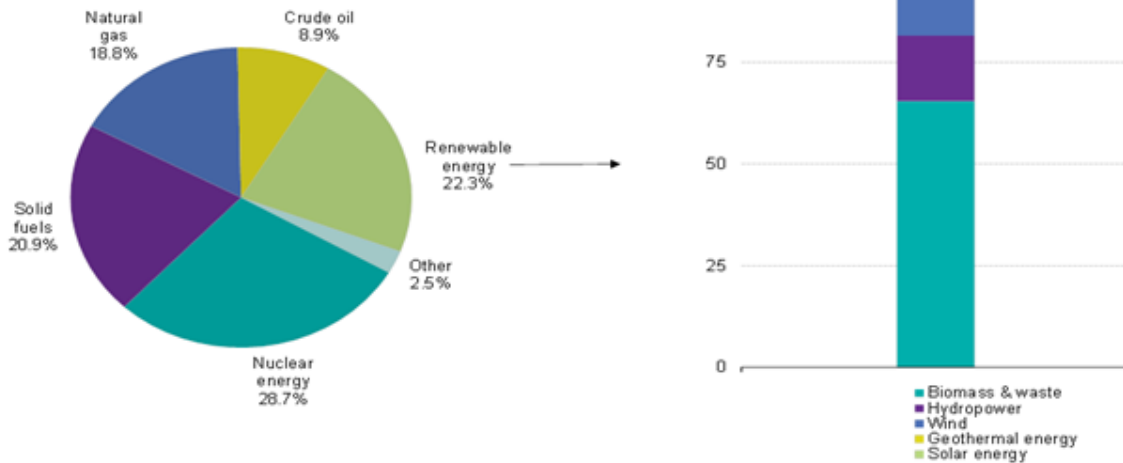

Source: Eurostat (online data codes: ten00080, ten00077, ten00079, ten00078, ten00081 and nrg_107a)

Figure 2.5.15: Energy Pie in EU⁶²

Chapter 3: Proposed energy source

3.1 Jet Stream

Fast flowing and narrow air currents in the atmosphere of Earth. They are at the altitude of troposphere and stratosphere. The strongest are the polar jets. They are found at the upper levels of the atmosphere 10-12 km from sea level. The weaker subtropical jets are around 10-16 km from the sea level. The current is thousand kilometers long, few hundred Km wide and a few Km thick. Each hemisphere has a pair of each jet stream. The north polar jet stream flows over Asia, Europe and North America where at the south they flow around Antarctica all year long.”⁶³

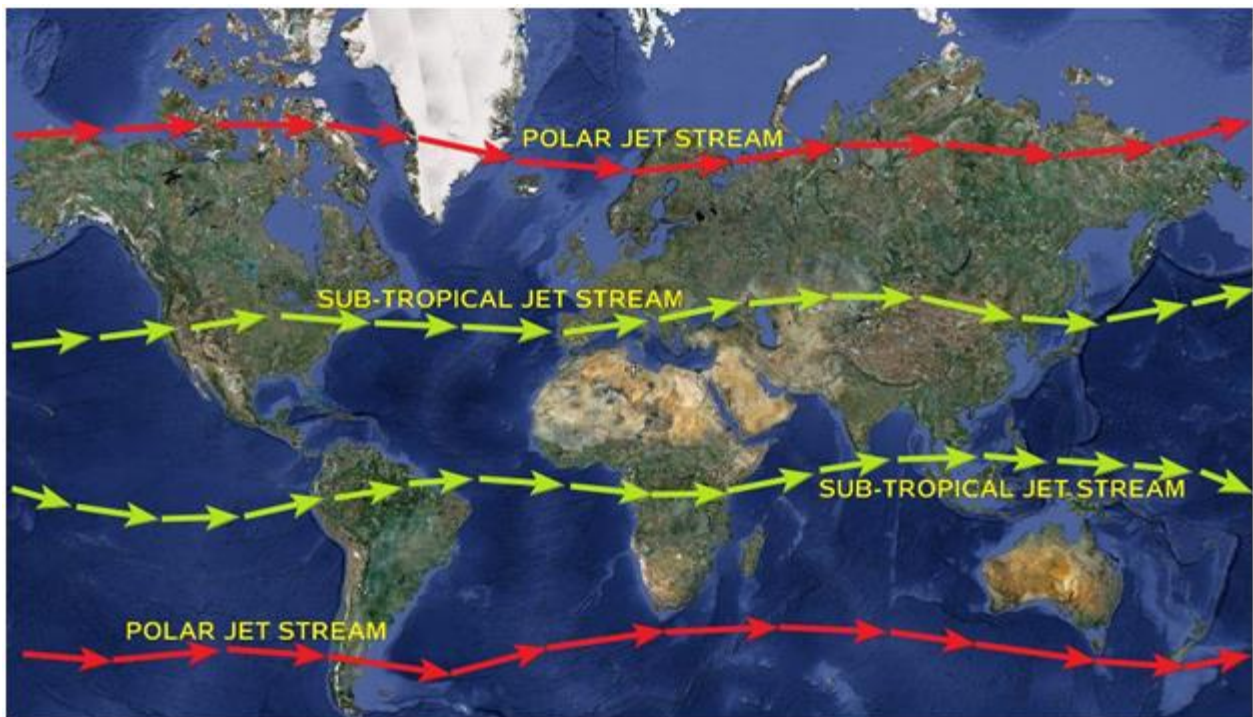

Figure 3.1.1: The four Jet streams flow paths 2 subtropical and 2 Polar

The air Wind speed is sometimes over 200 mph.

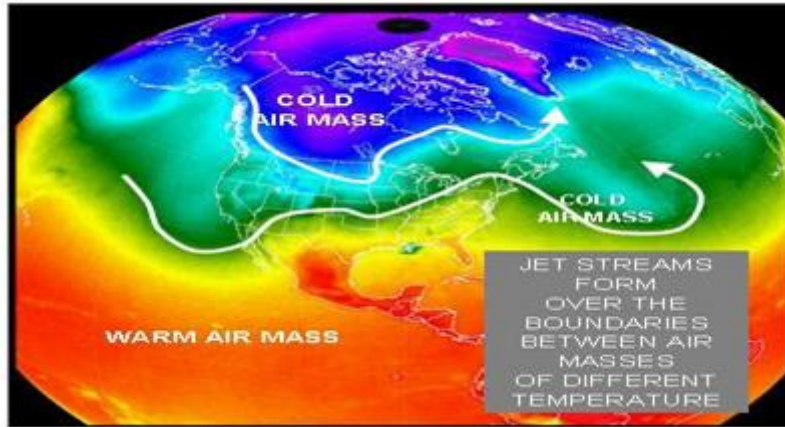

Figure 3.1.2: Photo on the Temperature difference around the globe and the Jet streams. ⁶⁴

The main reason of the existence of the jet stream is the temperature difference of the Warm and the cold air masses. Warmer clouds are less dense than the colder air creating an air pressure difference at any altitude. This temperature difference is exactly the reason why during the winter months the Arctic and tropical air masses create a much stronger jet stream; when in the summer months the stream is not that strong. Another point is that although the jet stream wants to go from high to lower pressure point the rotation of the Earth doesn't allow so causing it to flow to the right in air masses around the Earth. It is important to state that Jet streams don't affect the weather of different areas. In addition, this airflow difference can move air masses thus people can predict towards where different air masses will move i.e. colder masses or the ones that are more humid will move. How important the Jet streams are, was found in WW2 when the American bombers could not go fast enough against the strong winds when moving from east to west. Nowadays airplane companies take the jet streams under account in order to have cheaper and faster flights. ⁶⁴

"The total wind energy in the jet streams is roughly 100 times the global energy demand," writes Cristina L. Archer and Ken Caldeira in a 2009 edition of the journal *Energies*.

Two ways of harvesting The Jet stream:

- The Italian company Kite Gen has the idea of producing energy form the strongest wind flows using a kite; The idea as the president of the company described it Mr Massimo

Interactive Qualifying Project

Ippolito “Just like a fishing rod has a fish pulling it and spins the string, now instead of fish, we have a kite that pulls the wire with the help of the wind creating energy by adding an alternator to the reel.” Each kite measures around 50 m^2 where they imagine of lofting kites to be tree times this size. ⁶⁵ The turbines produce enough wind in order for the kite to be elevated to a higher altitude. Then the kite makes the eight shape cycles increasing in altitude every after each finished cycle. At some point, it reaches a maximum altitude and the kite falls off the sky. (At that point one of the cables on the end of the kite pulls back down for 20 seconds and then release it back to the wind for 2 more minutes.) The machine pulls the wire until the kite reaches a lower airflow that will lift it again higher in the sky (lifting flight restart point). The energy is produced every time the kite is pulling the wire away from the machine. ⁶⁶

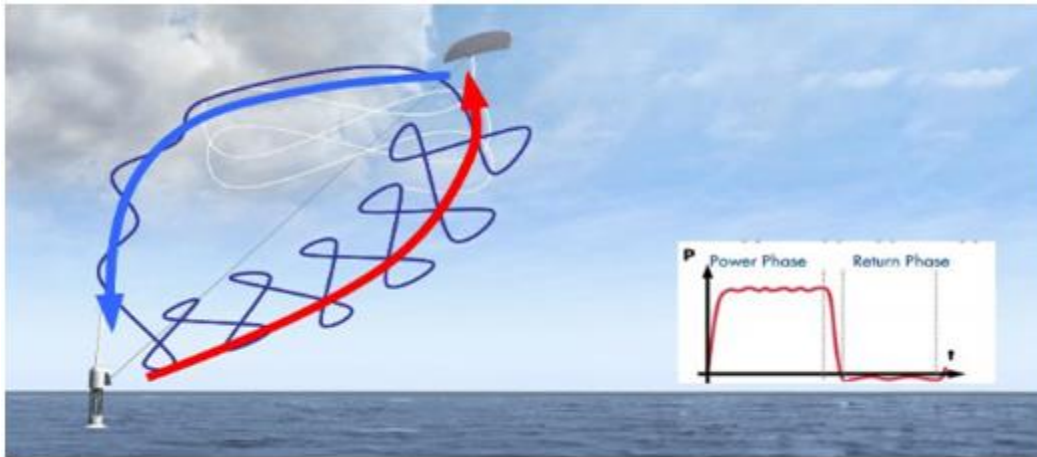

Figure 3.1.3: The cycle of a flight of the kite with its eight shaped cycles ⁶³⁷

Ippolito says “we have proven the concept” as the company has numerous successful trials in Sommariva Perno (Italy) which is placed at almost 1312 ft. above sea level. The company is testing different kite fabrics. It has been used Nylon and Dacron until now, but more fabrics will be tested, as a stronger and lighter fabric will be better for the project’s efficiency. The STEM system has pulleys and manipulators (two parts that pull on the kite strings from its

ends from a long rod) and a high-tech IT system which has many sensors and software that determines and keeps the kite at the optimum altitudes and angles.

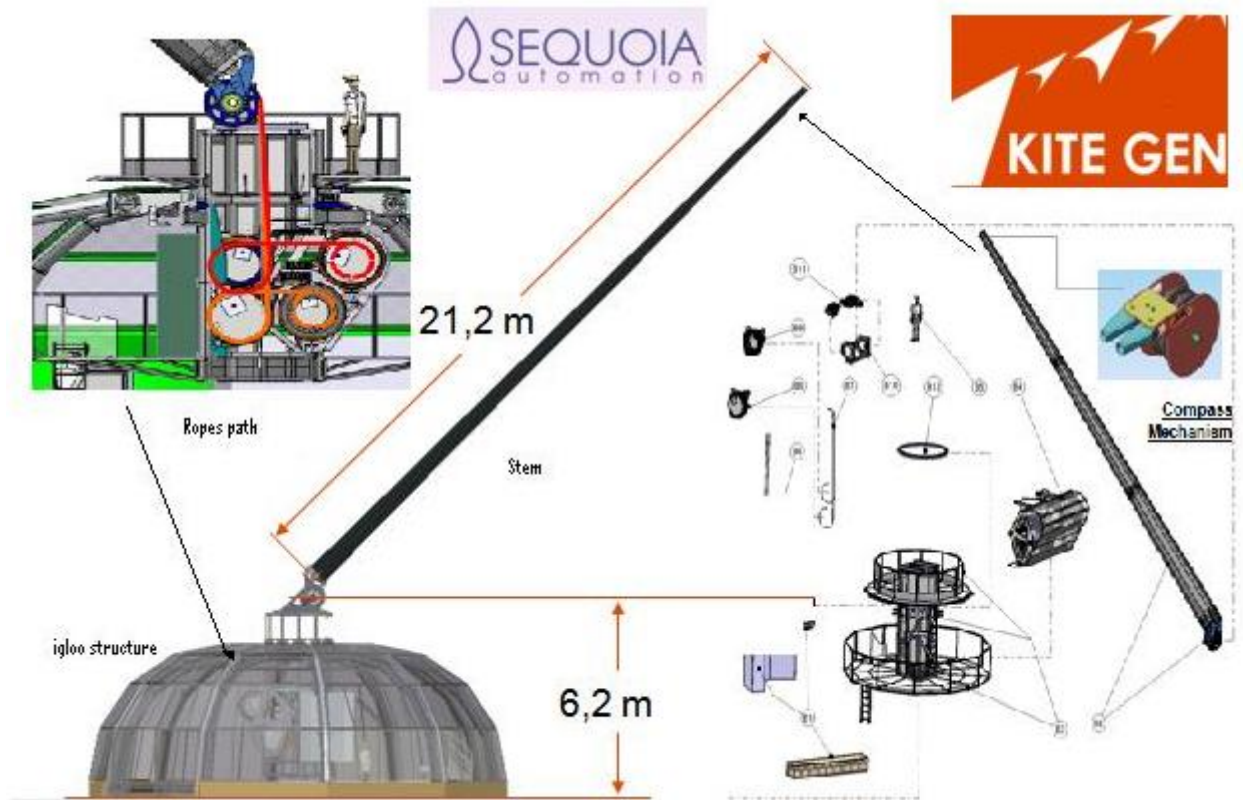

Figure 3.1.4: The parts of the STEM and its pulleys

How many years will it take for these sources to be done? How much of the world demand of energy can they cover? How much would they cost?

The project idea was initiated in 2003. It has earned 20 dissertations an ENI Award in 2010 many patents and even more innovating awards signifying the importance of the project towards new paths for sustainable energy, it is recognized by over 150 countries and has property protection of 2.5 million Euros. Through this project we have the creation of innovative ideas and a point of gaining “free” energy that we hadn’t till now though about. In 2006 a prototype of 30 kW was tested, later in 2012 a prototype of 3 MW was tested. We see that for a company to

keep finding new patterns and keep being distinguished means that it does something correctly and that it is efficient. The total costs of the activities and costs of production of the project till now is around 10 million euro. From this money, 95% comes from private resources and 5% from EU for research and development. Activities of development and of industrialization include an 1800 square meters of office and 8000 square meters of workshop in S. Mauro Torinese. In addition a partnership with Saudi Arabian Basic Industries Company (SABIC), aimed to provide the energy needed for the operation of the world biggest capture and purification of CO₂. The company has earned people's respect and that is exactly the reason why they do it.

Is it feasible in the future?

Additional funds could well help Kite Gen get rid of its engineering barriers and then the company could create something that will satisfy our energy needs or it just might be the end of a good start; According to Ippolito.

If we assume that an area runs completely with these units then the need of electric power storage is required. This is for whenever weather conditions (no wind or storm) don't allow the production of energy or when the energy produced isn't sufficient.

Power efficiency, places etc.:

At high altitudes the wind is much more constant and faster than the ones closer to the surface of the earth at an average of 6000 hours/year compared to 1500 hours/year respectively for ground wind turbines use. Any increase in the wind flow velocity will increase the power generated three times according to the formula: where ρ is the density, A is the area and v is the velocity. Scientist Ken Caldeira from the Carnegie Inst for science at Stanford University stated that "the raw power of the jet stream is between 10,000-30,000 watts/m²"⁶⁸. The journal Nature Climate Change in September 2012 estimated that the power extractable from tropospheric wind without any significant changes of climate is close to 1800 TW. This amount is almost 100 times more than the total humanity's energy needs which is 16-18 TW. On a flow over Italy the power was found to be around 100 TW. Even if we are able to extract 0.1% of that energy (100 GW) this number would correspond to 800 TWh/year. This number is equal to the amount of Italy's wealth production in a year (60 billion euro).

Interactive Qualifying Project

The KiteGen has created two configurations, the yoyo or stem, and now in an advanced stage Sommariva Perno, is the configuration of carousel. In the yoyo or stem, the wing moves along the wind and along the anchor to the ground generators. This is the speed and strength that is transmitted along the cables and finally rotating the generators;

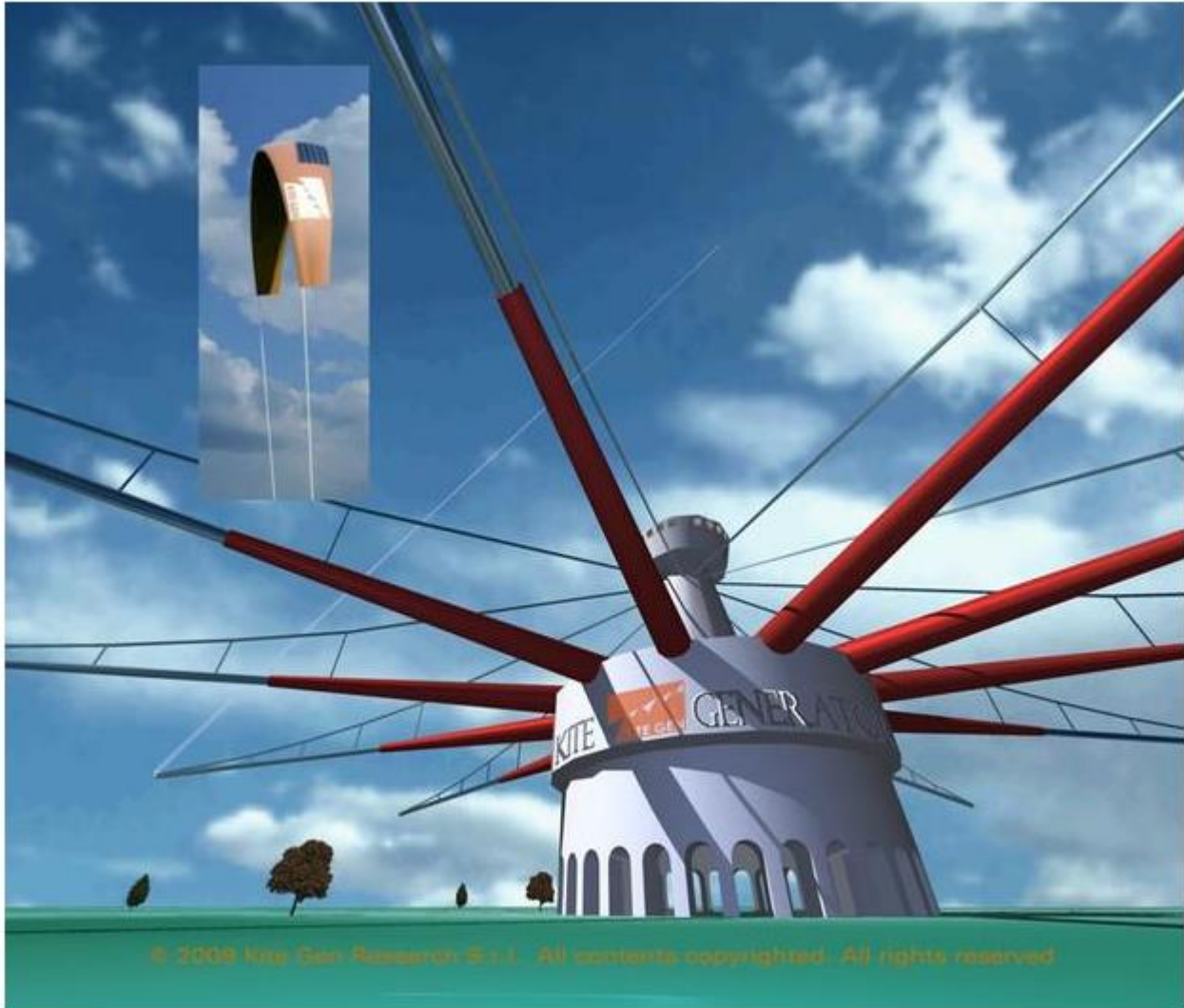

Figure 3.1.5: The carousel ⁶⁹

“In the case of the carousel, the speed and the strength are almost aligned with the direction of the shift to the beam below the kite. There is not the performance of the cables for

Interactive Qualifying Project

the production of energy. The aerodynamic forces cause the rotation of a ring to which is connected generators.

Thus, we see the two great differences. The first project named Stem can produce energy from wind of much lower intensity. The carousel cannot be thought below a certain size (few hundred meters in the diameter of the ring). Thus the “training ground “ in Sommariva Perno is just a test of how big and what kind of other technologies can be applied in the future for the better and maybe bulk conversion of wind energy into power i.e. the carousel.”

“From an initial 150 MW farm carries a cost per kWh equal to the average price on the electricity market. If we take into consideration that there is still research and development on this field to be done we can improve its performance up to 3400 hours in 2020 (which is only half of the theoretical maximum). At the same time if we assume that there will be 100% annual growth in the installations then we can predict a production 65 TWh in 2020 without any modifications to the network.”

Such a technology would create many jobs positions and at the same time it will be environmental friendly.

The energy produced would allow:

- 1) The goal of SEN+60 TWh of renewable energy will be reached without any increase in the amount spent.
- 2) A network of KiteGen farms and by monitoring the wind flow at high altitude will allow us to predict and efficiently distribute the amount of energy produced.
- 3) It will allow Italy to reduce its electricity imports by 5 TWh.
- 4) Reduce even more the import of gas and oil
- 5) Reduce the CO2 emissions”

But let’s compare the KiteGen STEM plant with a wind turbine:

KiteGen their plant life is of about 20 years, the factor productivity at a rate of 5000 MWh / MW and the rated power at 3MW. The traditional wind tower has s plant life of about 20 years, a factor productivity of a value of 2500 MWh / MW and a rated power of 3MW. The

Interactive Qualifying Project

visual impact in STEM is limited because the dome is only 6 meters high and the arm is additional 20 meters long plus it is thin. The cables are not easily noticeable and when they are up to kilometers off the ground it is even harder to be noticed. If we neglect the tower of the wind turbine and the dome for the Stem, the area of the blades that are 44 m and thus 6082 square meters the stem kite is 150 square meters. Thus it is shown that the new project occupies even less space than the previous created wind turbines. Thus the amount of bird deaths/ impact are even less. First reason is the fact that the new project does not occupy that much space. The second is because the sail is up to the troposphere where not many birds use to be if any. If we think about any danger-associated with the cables we can say that they move fast only close to the ground where again not many birds fly.

Assuming that we use the more advanced project of the KSU named carousel, the amount of noise that it produces is similar to that of a railway station at low speed. The reason is the fact that the rotation of the generator is of 70 km / h. The only noise created from the Stems is the ones from the sails and the cables. The machinery inside the dome may be avoided by using a soundproof dome.

STEM is one of the most important parts of the project. It is a robotic arm with a number of sensors made of light materials (aluminum or carbon fiber). It is allowed to move 360 degrees and placed onto the supporting structure (dome) by means of a fifth wheel.

The stem is not a decorative element. The main problems associated with lifting the kite takes place during the initial takeoff, which are associated with the destruction of the kite. The stem being allows a kite takeoff at an altitude of 20 m. In addition at that height the wind is much more intense allowing an easier take off compared to one from the ground. As a robotic arm is operating at a high degree of freedom, it can be programmed for rapid movements (maneuvers). This rapid motion can generate enough wind for the sail to be raised even when the currents are not that strong. In addition, the stem allows the output cables to remain aligned to several meters reducing fatigue and vibration. Multiple sensors are placed along the Stem which allows us to gain information about the position of the arm and the mechanical deformations that take place. Such sensors are: 9 nanogauge (strain sensors) and encoders that measure the angles of rotation of the arm with respect to the horizontal plane and vertical. “When the sail is hit by strong wind the stem is the first component that realizes this force. The strain sensors send information to the

Interactive Qualifying Project

control that, if too intense bursts are detected, is able to respond appropriately with maneuvers designed to remove the sail from the window of power by reducing the mechanical stress. During the processing time and the reaction of the central control, which however short is not null, the stem allows it to absorb the mechanical stress by means of a suitable elastic deformation, while maintaining the fine mechanics". The hand mounted on the top of the stem, the degree of freedom and the two "fingers" assist the Stem to avoid any plots/twists.

"Given the success of the trial will begin the construction of farm tropospheric wind farms totaling 600 MW, or 200 units KiteGen stem from 3 MW, intended to supply the complex of Portovesme providing electricity at a cost of less than 25 € / MWh considered competitive by Alcoa. The blue line is attributable to KiteGen, the red line is due to wind turbines. The vertical axis indicates the size of the surface that intercepts the wind, compared with the rate of extraction of kinetic energy on the abscissa."

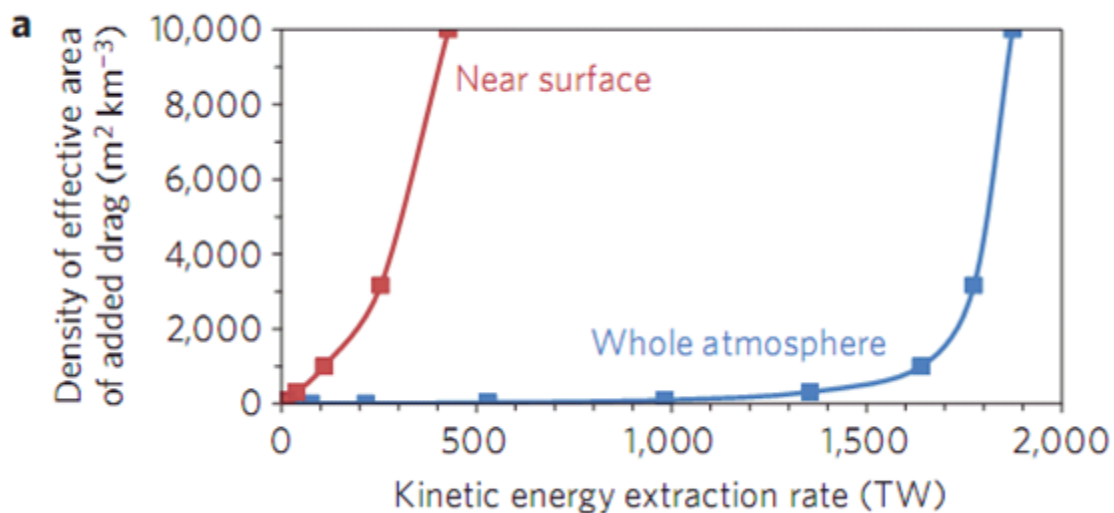

Figure 3.1.6: Graph of the density of the air Vs its Kinetic energy extraction rate

The idea can be applied worldwide under the circumstance that strong streams are over that area. Many sensors will allow us for a better distribution of energy as they will inform where the stream will be stronger. Thus, energy can be distributed more evenly. The natural effects movement can be bitterly followed as they move from one area to another due to the jet streams.

Interactive Qualifying Project

Furthermore, a greater analysis of these interesting winds will be allowed and an algorithm/formula of its sequence can be created. Results will be for the world to increase the CO₂ absorption capability and at the same time decrease the amount produced, as these kind of companies will start taking over and substituting the old energy sources. Also they can contribute in ways for “purifying” the atmosphere. An idea is for the government to sponsor people/ companies to contribute to this goal.^{70,71} Ships can use higher altitudes (about 200 meters) winds energy in order to be more efficient in their trips. The efficiency can reduce the costs of fuels up to 10-50% as the company Sky sails states. The development of this project took more than 4 years and the costs of the system varies from 380,000- 3.2 million depending on the size of the ship that it is needed to be pulled. Skysail system is composed by a big kite that is lifted up in the sky and a navigation software that allows the ship to use the most economical way through to points by maximizing the existing wind energy. This technology is designed and tested for ships (cargo ships/ yachts) which are at least 79 feet. The ships should use their engines to initiate and end the trip; the kites can be used only during the trip. If there is a need for higher speeds, the engines can assist. The restrictions that exist are that this cannot be done if the weather is not good and if the wind is towards the opposite direction.



Figure 3.1.7: Usage of a kite for making long journeys more economically.⁷²

Interactive Qualifying Project

The second Company that tries to take advantage of the Jet streams is:

- Sky Wind power; A company at San Diego “Sky Wind Power” decided to use helices to get the machine up to the sky using their own power. When the machine reaches the optimum level where the flow is stronger, the helices are then turned off and they are turned into generators which are turned by the wind power. The aluminum conductor machine would take the electricity through the wire to the earth and distribute it. Due to low wind intensity, these wind farms can only operate at their peak capacity 19-35% of the time. They do not have to be settled at a fixed location, we can just move them from place to place depending on our needs and wind intensity fluctuations. One flying Windmill of 240kW with a rotor of 35 ft. can generate power for less than 2 cents per KWh.



Figure 3.1.8: The flying wind turbines. ^{73, 74, 75}



Figure 3.1.9: Image of Magenn rotating helium filled balloon.

Magenn was invented by Fred Ferguson. The balloon is filled with helium. The idea is that this balloon can rotate and produce energy at the generators attached to the balloon which is then sent to ground. As the wind gets stronger, the number of rotations increases as well. Their cost of production by the Ottawa-area company is in the order of 10 thousand dollars and it can produce 4 kW. This technology can produce a cheaper electrical energy compared to the wind power systems. It has an efficiency of 40-50 % which means that as the amount of energy produced decreases its costs of production even more. They can be placed wherever we want. It is a great idea for isolated areas where energy is vital and difficult to be sent. Magenn air Rotors can operate to wind flows down to 1m/s and up to 28 m/s where is it full capacity. It is operating at altitudes of 400-1000 ft. above ground level without the need of any expensive infrastructure. There is high mobility which allows emergency deployment. The only issue

Interactive Qualifying Project

concerning the countryside is that they are visible and not that nice to the eye especially in big cities. ⁷⁶ It is safer for birds and planes as they are easily visible and softer than other technologies.

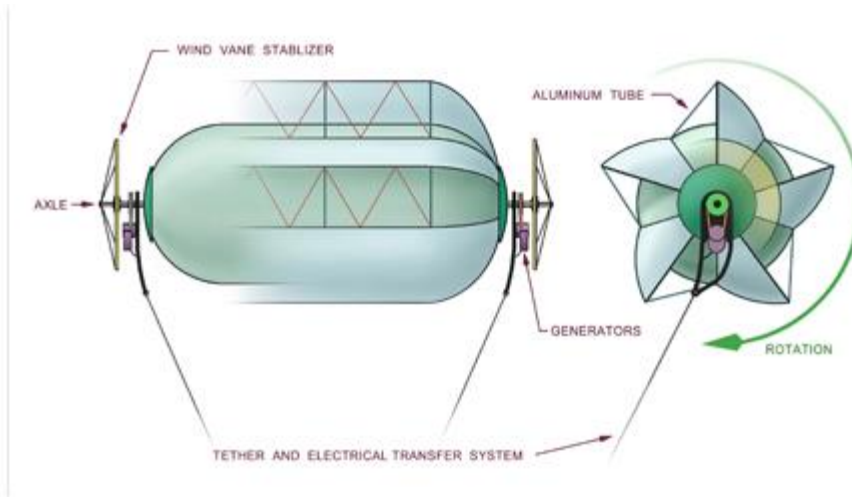

Figure 3.1.10: Floating Wind Turbines detailed schematic. ⁷⁷

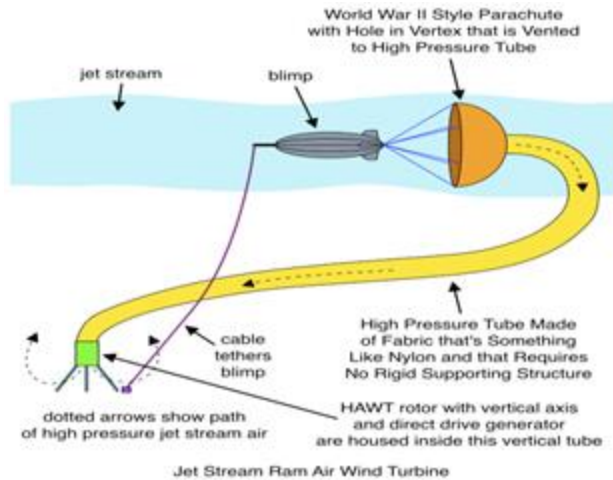

Figure 3.1.11: "Pushing" air down to the earth

Interactive Qualifying Project

The idea is of placing a blimp to tie a blimp with a rope and at its end tie a WW2 style parachute with a hole at the middle. The hole will be connected to a pipe made of elastic materials. The air would be lead to a grounded motor generating in this way energy.⁷⁸ Problems with affecting/ creating “dams” for the stream is that we can change the temperature of the areas where the stream used to pass by and of the new ones where it is going to pass by. In addition the Jet streams are not air dense causing a decreased ability to generate enough energy.⁷⁹



US 20100026007A1

(19) **United States**
 (12) **Patent Application Publication** (10) **Pub. No.: US 2010/0026007 A1**
 Bevirt (43) **Pub. Date: Feb. 4, 2010**

(54) **APPARATUS AND METHOD FOR HARVESTING WIND POWER USING TETHERED AIRFOIL.**

(76) **Inventor: Joeben Bevirt, Santa Cruz, CA (US)**

Correspondence Address:
MICHAEL A. GUTH
2-2905 EAST CLIFF DRIVE
SANTA CRUZ, CA 95062 (US)

(21) **Appl. No.: 12/456,694**

(22) **Filed: Jun. 19, 2009**

Related U.S. Application Data

(60) **Provisional application No. 61/073,996, filed on Jun. 19, 2008.**

Publication Classification

(51) **Int. CL**
F03D 9/00 (2006.01)
B64C 31/06 (2006.01)
F03D 5/00 (2006.01)
 (52) **U.S. CL.** 290/55; 244/155 A; 244/154; 244/153 R
 (57) **ABSTRACT**

A wind energy generator for employment in the jet stream or other wind conditions is described herein. The craft comprises a "kite" configured with an airfoil and tethered to a ground based power generator. The craft and tether are configured to pull on the tether during a flight pattern calculated to pull on the tether that is connected to the generator to enable power generation. Also, an aerodynamically stable tether configuration is used and can be supplemented with a number of periodically spaced control surfaces arranged at various points along the tether. These control surfaces can be selectively actuated to stabilize and position the tether. The tether can comprise a two-stage tether having an inelastic portion attached to a pool and an elastic portion that connects with the kite. Also, the invention contemplates a system of wind detection devices that identify the local wind variations and through control systems enable the optimal positioning of the kite.

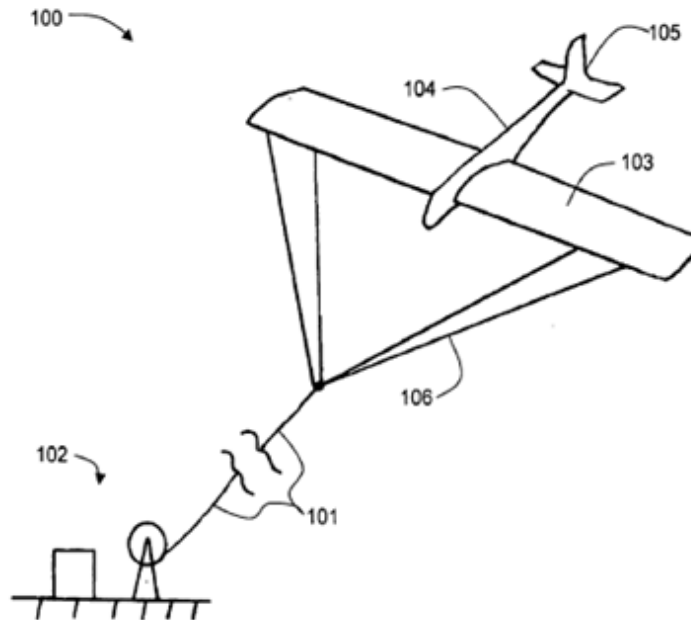

Figure 3.1.12: Schematic of a turbine lifted in the sky with the use of a kite

Here is a similar idea where it has been thought of having a turbine lifted up with a “kite” generating energy directly from the wind. The Issues with this project is how can a turbine that light could be manufactured so that it can flow in the jet streams for days.⁸⁰

3.2 Tidal Energy

3.2.1 Introduction

Tidal power, also called tidal energy, is a form of hydro-power that converts the energy of tides into electricity or other useful forms of power. The first large-scale tidal power plant (the Rance Tidal Power Station) started operation in 1966.

Although not yet widely used, tidal power has potential for future electricity generation. Tides are more predictable than wind energy and solar power. Among sources of renewable energy, tidal power has traditionally suffered from relatively high cost and limited availability of sites with sufficiently high tidal ranges or flow velocities, thus constricting its total availability. However, many recent technological developments and improvements, both in design (e.g. dynamic tidal power, tidal lagoons) and turbine technology (e.g. new axial turbines, cross flow turbines), indicate that the total availability of tidal power may be much higher than previously assumed, and that economic and environmental costs may be brought down to competitive levels.

Tidal power traditionally involves erecting a dam across the opening to a tidal basin. The dam includes a sluice that is opened to allow the tide to flow into the basin; the sluice is then closed, and as the sea level drops, traditional hydro-power technologies can be used to generate electricity from the elevated water in the basin. In this report, there are three ways of using tidal power, which is tidal stream generator, tidal barrage and dynamic tidal power.

3.2.2 Tidal Stream Generator

A tidal stream generator is a machine that extracts energy from moving masses of water, or tides. These machines function very much like underwater wind turbines, and are sometimes referred to as tidal turbines.

Tidal stream generators are the cheapest and the least ecologically damaging among the three main forms of tidal power generation.



Fig. 1. The world's first commercial-scale and grid-connected tidal stream generator.

Figure 3.2.1: The world's first commercial-scale and grid connected tidal stream generator ⁸¹

Since tidal stream generators are an immature technology, no standard technology has yet emerged as the clear winner, but large varieties of designs are being experimented with, some very close to large scale deployment. Several prototypes have shown promise with many companies making bold claims, some of which are yet to be independently verified, but they have not operated commercially for extended periods to establish performances and rates of return on investments.

Various turbine designs have varying efficiency and therefore varying power output. If the efficiency of the turbine " η " is known the equation below can be used to determine the power output of a turbine. The energy available from these kinetic systems can be expressed as:

$$P = \frac{\xi \rho A V^3}{2}$$

Where:

ξ = the turbine efficiency

P = the power generated (in watts)

ρ = the density of the water (seawater is 1025 kg/m³)

A = the sweep area of the turbine (in m²)

V = the velocity of the flow

Relative to an open turbine in free stream, depending on the geometry of the shroud shrouded turbines are capable of as much as 3 to 4 times the power of the same turbine rotor in open flow.

While initial assessments of the available energy in a channel have focus on calculations using the kinetic energy flux model, the limitations of tidal power generation are significantly more complicated. For example, the maximum physical possible energy extraction from a strait connecting two large basins is given to within 10% by:

$$P = 0.22 \rho g \Delta H_{\max} Q_{\max}$$

Where ρ = the density of the water (seawater is 1025 kg/m³), g = gravitational acceleration (9.81 m/s²), ΔH_{\max} = maximum differential water surface elevation across the channel, Q_{\max} = maximum volumetric flow rate through the channel.

3.2.3 Tidal Barrage

A Tidal barrage is a dam-like structure used to capture the energy from masses of water moving in and out of a bay or river due to tidal forces. Instead of damming water on one side like a conventional dam, a tidal barrage first allows water to flow into the bay or river during high tide, and releasing the water back during low tide. This is done by measuring the tidal flow and controlling the sluice gates at key times of the tidal cycle. Turbines are then placed at these sluices to capture the energy as the water flows in and out.

The barrage method of extracting tidal energy involves building a barrage across a bay or river that is subject to tidal flow. Turbines installed in the barrage wall generate power as water flows in and out of the estuary basin, bay, or river. These systems are similar to a hydro dam that produces Static Head or pressure head (a height of water pressure). When the water level outside of the basin or lagoon changes relative to the water level inside, the turbines are able to produce power. The basic elements of a barrage are caissons, embankments, sluices, turbines, and ship locks.

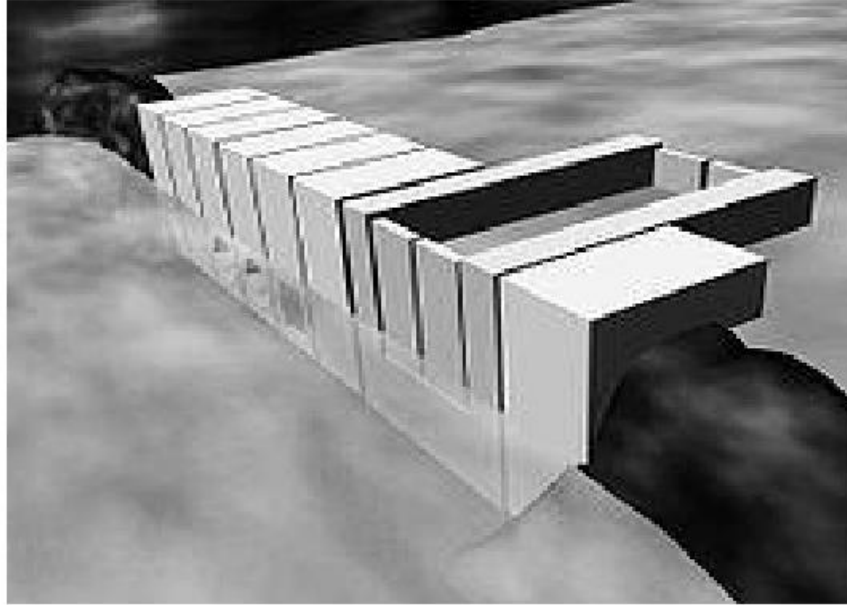

Fig. 2. An artistic impression of a tidal barrage, including embankments, a ship lock and caissons housing a sluice and two turbines.

Figure 3.2.2: An artistic impression of a tidal barrage. ⁸¹

Ebb generation

The basin is filled through the sluices until high tide. Then the sluice gates are closed. (At this stage there may be "Pumping" to raise the level further). The turbine gates are kept closed until the sea level falls to create sufficient head across the barrage, and then are opened so that the turbines generate until the head is again low. Then the sluices are opened, turbines disconnected and the basin is filled again. The cycle repeats itself. Ebb generation (also known as outflow generation) takes its name because generation occurs as the tide changes tidal direction.

Flood generation

The basin is filled through the turbines, which generate at tide flood. This is generally much less efficient than ebb generation, because the volume contained in the upper half of the basin (which is where ebb generation operates) is greater than the volume of the lower half (filled first during flood generation). Therefore the available level difference — important for the

turbine power produced — between the basin side and the sea side of the barrage, reduces more quickly than it would in ebb generation.

Rivers flowing into the basin may further reduce the energy potential, instead of enhancing it as in ebb generation. Of course this is not a problem with the "lagoon" model, without river inflow.

Pumping

Turbines are able to be powered in reverse by excess energy in the grid to increase the water level in the basin at high tide (for ebb generation). This energy is more than returned during generation, because power output is strongly related to the head. If water is raised 2 ft. (61 cm) by pumping on a high tide of 10 ft. (3 m), this will have been raised by 12 ft. (3.7 m) at low tide. The cost of a 2 ft. rise is returned by the benefits of a 12 ft. rise. This is since the correlation between the potential energy is not a linear relationship, rather, is related by the square of the tidal height variation.

Two-basin schemes

Another form of energy barrage configuration is that of the dual basin type. With two basins, one is filled at high tide and the other is emptied at low tide. Turbines are placed between the basins. Two-basin schemes offer advantages over normal schemes in that generation time can be adjusted with high flexibility and it is also possible to generate almost continuously. In normal estuarine situations, however, two basin schemes are very expensive to construct due to the cost of the extra length of barrage. There are some favorable geography, however, which are well suited to this type of scheme.

Tidal lagoon power

Tidal pools are independent enclosing barrages built on high level tidal estuary land that trap the high water and release it to generate power, single pool, around 3.3W/m². Two lagoons operating at different time intervals can guarantee continuous power output, around 4.5W/m². Enhanced pumped storage tidal series of lagoons raises the water level higher than the high tide, and uses intermittent renewable for pumping, around 7.5W/m² i.e. 10 x 10 km delivers 750MW constant output 24/7. These independent barrages do not block the flow of the river and are a viable alternative to the Severn Barrage.

The energy available from a barrage is dependent on the volume of water. The potential energy contained in a volume of water is:

$$E = \frac{1}{2} A \rho g h^2$$

Where h is the vertical tidal range A is the horizontal area of the barrage basin, ρ is the density of water = 1025 kg per cubic meter (seawater varies between 1021 and 1030 kg per cubic meter) and g is the acceleration due to the Earth's gravity =9.81 meters per second squared. The factor is half due to the fact that the basin flows empty through the turbines; the hydraulic head over the dam reduces. The maximum head is only available at the moment of low water, assuming the high water level is still present in the basin.

3.2.4 Dynamic Tidal Power

Dynamic tidal power or DTP is a new and untested method of tidal power generation. It would involve creating large dame like structure extending from the coast straight to the ocean, with a perpendicular barrier at the far end, forming a large 'T' shape. This long T-dam would interfere with coast-parallel oscillating tidal waves which run along the coasts of continental shelves, containing powerful hydraulic currents.

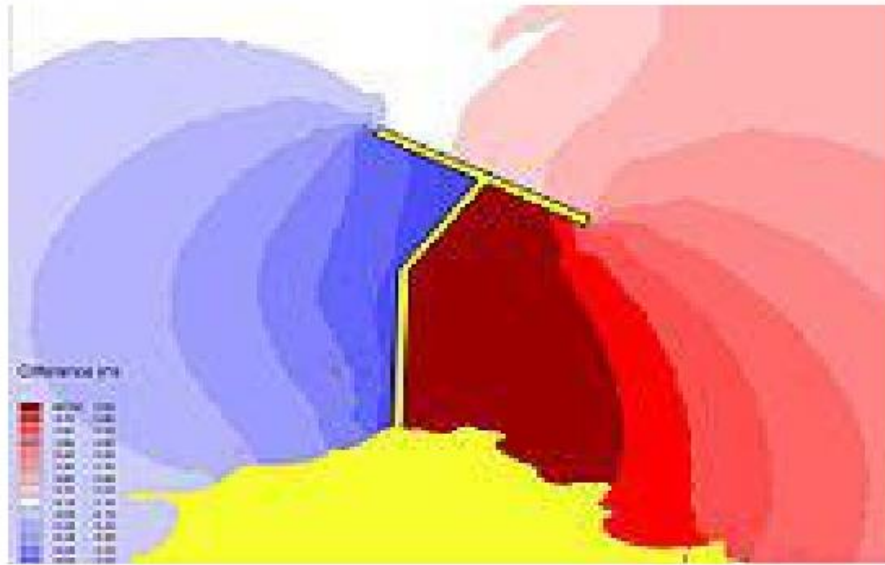

Fig. 3. Top-down view of a DTP dam. Blue and dark red colors indicate low and high tides, respectively.

Figure 3.2.3: Top-down view of a DTP dam. ⁸¹

A DTP dam is a long dam of 30 to 60 km which is built perpendicular to the coast, running straight out into the ocean, without enclosing an area. The horizontal acceleration of the tides is blocked by the dam. In many coastal areas the main tidal movement runs parallel to the coast: the entire mass of the ocean water accelerates in one direction, and later in the day back the other way. A DTP dam is long enough to exert an influence on the horizontal tidal movement, which generates a water level differential (head) over both sides of the dam. The head can be converted into power using a long series of conventional low-head turbines installed in the dam.

A single dam can accommodate over 8 GW (8000 MW) of installed capacity, with a capacity factor of about 30%, for an estimated annual power production of each dam of about 23 billion kWh (83 PJ/yr). To put this number in perspective, an average European person consumes about 6800 kWh per year, so one DTP dam could supply energy for about 3.4 million Europeans. If two dams are installed at the right distance from one another (about 200 km apart), they can complement one another to level the output (one dam is at full output when the other is not generating power). Dynamic tidal power doesn't require a very high natural tidal range, so more sites are available and the total availability of power is very high in countries with suitable

conditions, such as Korea, China, and the UK (the total amount of available power in China is estimated at 80 - 150 GW).

A major challenge is that a demonstration project would yield almost no power, even at a dam length of 1 km or so, because the power generation capacity increases as the square of the dam length (both head and volume increase in a more or less linear manner for increased dam length, resulting in a quadratic increase in power generation). Economic viability is estimated to be reached for dam lengths of about 30 km. Other concerns include shipping routes, marine ecology, sediments, and storm surges. Amidst the great number of challenges and few environmental impacts the method of utilizing tidal power to generate electricity has great potential and is certainly a technology most of the countries will try to harness in near future.⁸¹

The “tidal lagoon”: waves go in the capture chamber and push the air upwards. Then the air passes through a turbine generating energy. As the tidal falls water goes downwards and air is forced through the turbine and energy is again generated.

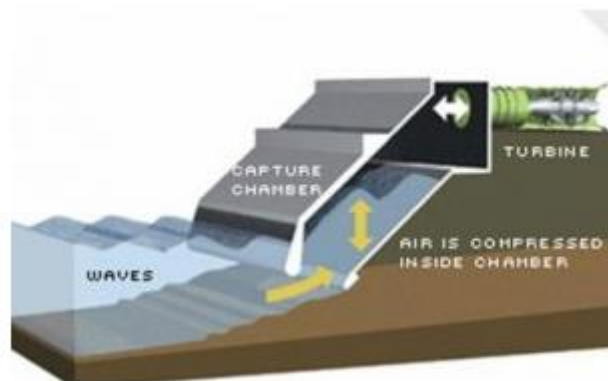
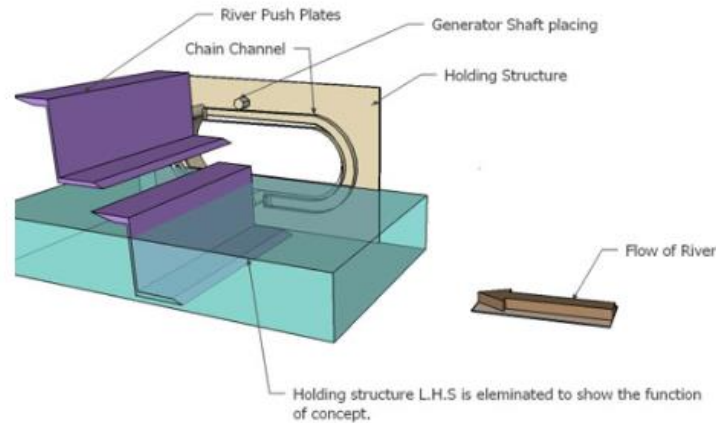

Figure 3.2.4: Schematic of a way that tidal energy can be converted into useful energy.⁸²

Interactive Qualifying Project



How System Works:

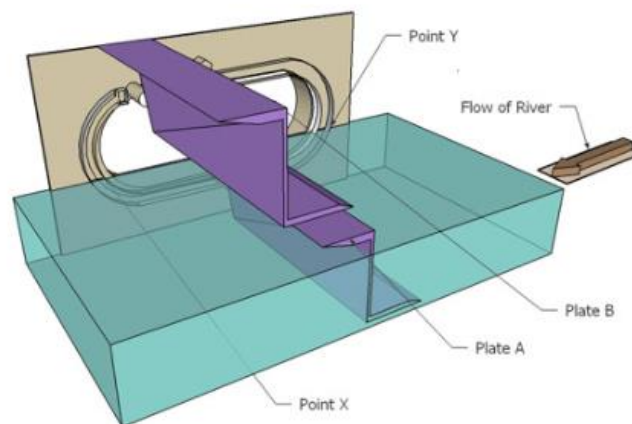

Figure 3.2.5: The Push Plates

The plates are connected with a chain which is gripped with the oval channel shape shown. As the water flows in, it pushes plate A by the time plate A reaches point X plate B is moved to point Y and the process is repeated. This motion converts work into energy. It can be used in narrow rivers and in general narrow water canals. An improvement would be not to allow water pass by the edges by having a solid dam around the machine. In addition depending of the average amount of water coming through the canal appropriate gears must be used. ⁸³

The “THAWT” (transfer horizontal axis water turbine) machine ⁸⁴

The machine has a similar idea of wind power energy machines but it is used for water energy motion harvesting. As the water passes through the machines comes into contact with two sets of blades one at the frond and one at the back of the machine.

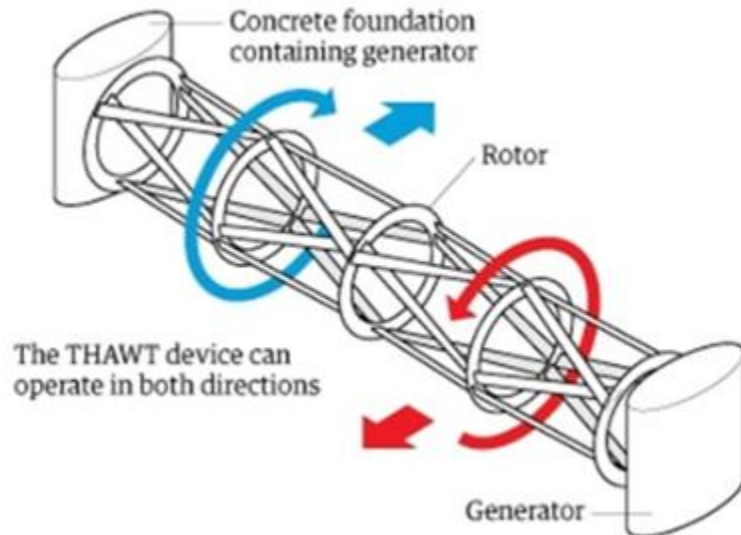

Figure 3.2.6: The THAWT device

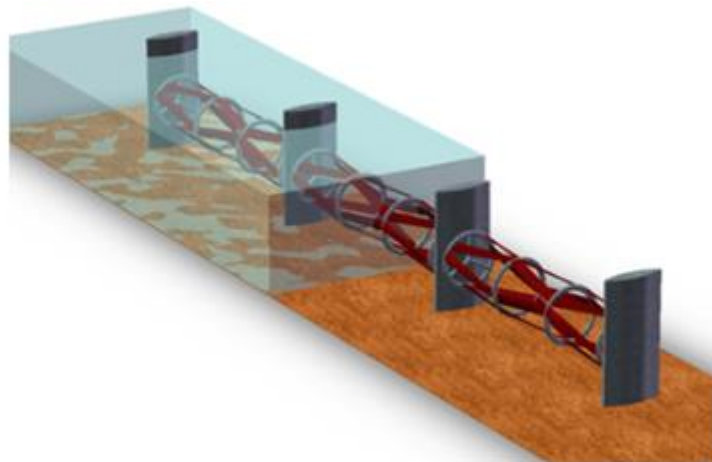

Figure 3.2.7: The THAWT device

The blades are designed so that the power to be distributed evenly across the blades and thus increasing the life cycles to failure. The costs of production are significant lower compared to

Interactive Qualifying Project

other projects (by 60%) and similarly are the maintenance costs (40% lower). It is 50% more efficient than any other turbine/propeller model used under the same conditions. Its production costs are low as it has:

- Only two turbines
- A “central direct drive generator”
- Four supporting legs
- Three ground bases

This allows lower weight compared if we had a system of turbines. A turbine rotor used will be around 10 m in diameter, 60 m long and for an average depth of 20 m. When tests were made on a full-scale model of 10 m diameter and 125 m length unit that required one generator and two turbines it was found that when the water velocity was 2m/sec then the amount of electricity produced was about 4.4 MW. When the water velocity was 2.5 m/sec the amount of energy produced was around 5.3 MW. Another advantage of the unit is that it can operate efficiently even at small in scale water velocities. ^{84, 85}

How are the water flows being created?

The surface currents are created mainly from the wind. Deep Ocean currents are due to water density difference. This phenomenon is known as thermohaline circulation. Density has to do with how close are the particles are to each other at certain temperatures and it is expressed as mass per unit volume. As the temperature increases, the volume of its molecule increases as well causing a decrease in its density. Thus, we will have a flow of higher density water downwards and lower density water upwards. When this energy is sufficient, the water molecules break their bonds and turn into gas molecules. i.e. when we boil water. The water freezes at the north and south poles of Earth. Due to the fact that the water is salty it doesn't freeze that easily. Thus, large amounts of dense cold water move towards the seafloor. This movement causes the water masses that were already there to move, and cycle repeats itself. This exact motion causes the ocean currents all around the world. ⁸⁶

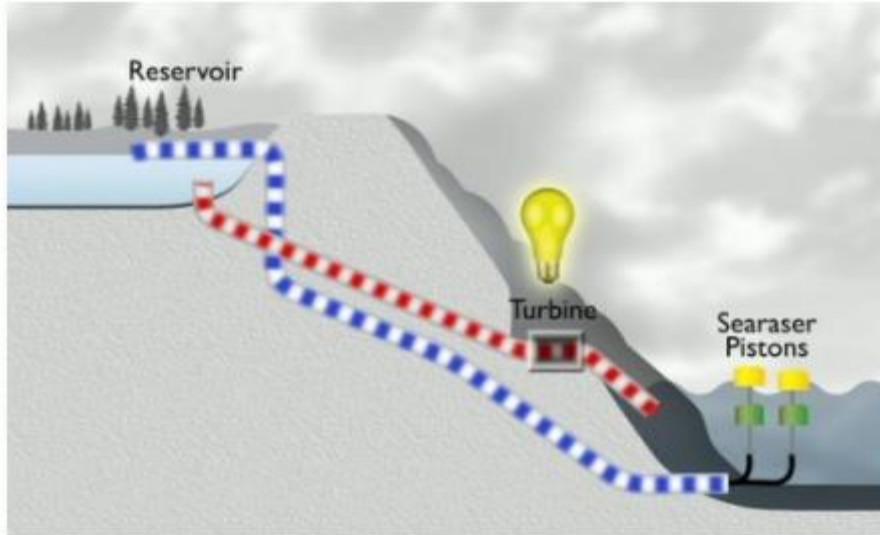

Figure 3.2.8: The “Searaser Pistons”

As there are waves these “balloons are making a periodic up and down movement. They pump in this way water to an elevated reservoir. Then we can convert its potential energy into kinetic and using a turbine create energy. It a clear and inexpensive source of energy.⁸⁷

3.2.5 Tidal Energy Project in the Bay of Fundy

On a flood tide, 160 billion tons of seawater flows into the Bay of Fundy — more than four times the estimated combined flow of all the world’s freshwater rivers during the same 6-hour interval.



Figure 3.2.9: Hopewell Rocks, Bay of Fundy, New Brunswick, Canada ⁸⁸

The vertical tidal range can be over **16 meters** — giving the Bay of Fundy the highest tides in the world. The horizontal range can be as much as **5 kilometers**, exposing vast areas of ocean floor. The tidal currents in the Bay of Fundy are fast, reaching **10 knots (5.1 m/s)** at peak surface speed. Research from California-based Electric Power Research Institute (EPRI) identifies the Bay of Fundy as potentially the best site in North America for tidal power generation, with a world-class resource close to an existing electricity grid. In the Minas Passage alone, EPRI estimated a nearly **300 megawatt** potential (equal to enough power for about 100,000 homes).



Figure 3.2.10: High and low tide at Bay of Fundy ⁸⁸

More recent research suggests there is more than **7,000 megawatts** of potential in the Minas Passage, 2,500 megawatts of which can be extracted without significant effects. Models indicate upwards of 50,000 megawatts of energy exists in the entire Bay of Fundy.

The Guinness Book of World Records states the world's highest average tides are in the Bay of Fundy, where the mean spring range in the Minas Basin is 14.5 meters (47.6 feet). The highest tide on record in the Bay was **21.6 meters (70.9 feet)** in 1869.

The primary cause of the immense tides of The Bay of Fundy is a resonance of the Bay of Fundy/Gulf of Maine system. The system is effectively bounded at its outer end by the edge of the continental shelf with its approximately 40:1 increase in depth. The system has a natural period of approximately 13 hours, a Q-value (efficiency) of about 5, and is driven near resonance, not directly by the Moon, but by the dominant semidiurnal tides of the Atlantic Ocean.

Interactive Qualifying Project

The gentle Atlantic tidal pulse pushes the waters of the Bay of Fundy/Gulf of Maine basin at nearly the optimum frequency to cause a large vertical range of the tide in the Bay of Fundy, particularly at its eastern end in Minas Basin.⁸⁸

The Fundy Ocean Research Center for Energy (FORCE) was incorporated in 2009 as a not for profit corporation with two roles. The first was to operate a tidal turbine demonstration facility; and the second was to enable public and private research into tidal energy extraction and its effects. Establishing FORCE was a requirement of the request for proposals issued in 2007 by the Province of Nova Scotia for the demonstration of tidal turbines. The project will permit, construct and operate a facility in the Minas Passage of the Bay of Fundy where devices will be demonstrated by up to four Berth Holders.

FORCE is Canada's leading test center for in-stream tidal energy technology. FORCE works with developers, regulators, and researchers to study the potential for tidal turbines to operate within the Bay of Fundy environment. FORCE provides a shared observation facility, submarine cables, grid connection, and environmental monitoring at its pre-approved test site. FORCE receives funding support from the Government of Canada, the Province of Nova Scotia, Encana Corporation, and participating developers.⁸⁹



Figure 3.2.11: Turbine used by Altantis⁸⁹

Atlantis, which announced its listing on the London Stock Exchange in February 2014, has been working with Lockheed Martin and Irving Shipbuilding on a project that will see the company's state of the art AR-1500 turbine deployed at FORCE, supported by a \$5 million grant from Sustainable Development Technology Canada.

Atlantis' new **1.5-megawatt tidal turbine**, the AR1500, is designed to facilitate operation in highly energetic tidal locations. The AR1500 turbine will be one of the largest single rotor turbines ever developed and will have active rotor pitch and full nacelle yaw rotation. The increased capability and integrated, advanced functionality will help bring commercial tidal energy to reality, and will initially support the MeyGen project in Scotland's Pentland Firth and deployment in Canada's Bay of Fundy.

The Singapore-headquartered company has deployed and operated a similar 1MW turbine in the North Atlantic off Orkney, Scotland.

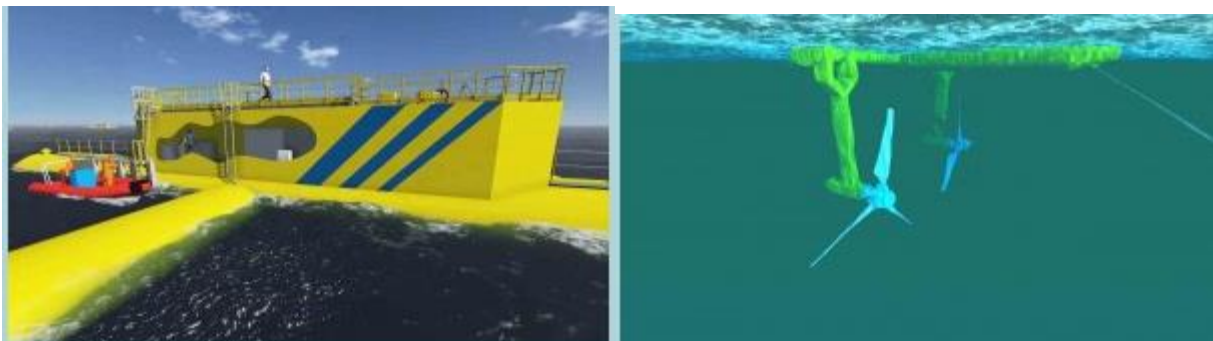

Figure 3.2.12 Design proposed by Minas Basin Pulp and Power Co. Ltd. ⁸⁹

In January 2008, the Nova Scotia Provincial Government awarded Minas Basin Pulp and Power Co. Ltd. (now Minas Energy) the right to construct the FORCE tidal energy demonstration and research facility. Minas Basin is a privately owned company, based in Hantsport, Nova Scotia, which has a strong commitment to being part of the greening of Canada's energy sector. Minas Energy has partnered with Marine Current Turbines Ltd. (MCT, owned by Siemens) to test its technology at FORCE.

Minas Energy and MCT will be installing an axial horizontal flow turbine with pitch controlled rotors. MCT's "SeaGen" – one of the largest working prototypes in the world – is presently installed in Strangford Narrows, Northern Ireland. The SeaGen rotors are 16 meters in diameter and sweep 200 square meters of flow. The rotor blades can be pitched through 180 degrees allowing for operation in both the ebb and flood tides.

Interactive Qualifying Project

SeaGen has proven its capabilities in the fast moving tidal waters of Strangford Narrows. It is now being modified to take on the challenge only the Bay of Fundy can offer. Marine Current Turbines Ltd. (MCT), a Siemens company, and Bluewater Energy Services B.V. (Bluewater) have agreed to jointly develop a **2 megawatt floating tidal current turbine**, called SeaGen F. This turbine will be the first of its kind to be installed in Canada's Bay of Fundy, in cooperation with Nova Scotian project developer Minas Energy. The turbines will produce enough clean and reliable energy to supply up to **1,800 Nova Scotian households**. Plans are under development to build-out a commercial multi-megawatt array at the tidal energy facilities of FORCE.



Figure 3.2.13: Illustration of the turbine proposed by Open Hydro ⁸⁹

OpenHydro has been selected by the Nova Scotia Department of Energy for a second tidal energy demonstration project at the FORCE test site.

OpenHydro, a DCNS company, will proceed with plans for the deployment of a fully grid connected **4MW tidal** array to be in place later in 2015. The array will consist of two 16m (2.0MW) commercial scale turbines. On successful completion, this project has the potential to be the world's first multi-megawatt array of interconnected tidal turbines, providing energy to **over 1,000 customers in Nova Scotia**. OpenHydro's 16 meter tidal turbine has already been successfully deployed and is currently operating off the coast of France. A group led by OpenHydro together with Nova Scotia-based energy company Emera, will deliver the project. The project's key local industrial partners are Irving Shipbuilding, Irving Equipment and Atlantic Towing. The group has ambitious future plans for tidal energy in the region and are looking to

Interactive Qualifying Project

use this initial demonstration project as the first phase of a commercial scale project in the Bay of Fundy, which subject to regulatory approvals, will see the array grow to **300MW**.

OpenHydro is committed to establishing a local manufacturing hub in the Bay of Fundy area using local skills and predict that 950 direct and indirect jobs will be created as the project moves to commercial scale. It is OpenHydro's strategy to develop local manufacturing hubs in regions located close to major areas of tidal resource. OpenHydro and its industrial partners will progress work schedules and engage with the procurement cycle before mobilization and deployment in 2015.

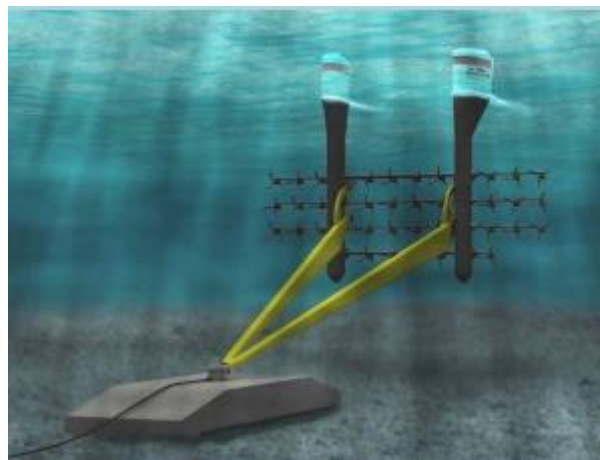

Figure 3.2.14: Illustration of the generator from Black Rock Tidal Power ⁸⁹

Founded in 2013 and located in Halifax, Black Rock Tidal Power is a privately-owned company offering tailor-made tidal energy converter systems and related services for the Bay of Fundy, as well as other tidal and river applications.

BRTP is a system-integrator that delivers cost-effective, turn-key solutions of in-stream tidal power generation. It is specialized in the development and implementation of TidalStream Triton platforms that carry a multitude of SCHOTTEL STG tidal turbines. BRTP is collaborating with a team of experienced Nova Scotia experts to demonstrate the technical and economic feasibility of the technology at the Fundy Ocean Research Center of Energy (FORCE). Most of the existing tidal current energy systems that have been deployed to date are single turbines designed to rest on the seabed.

Interactive Qualifying Project

The single turbine approach leads to enormous machines. Besides the high capital expenses for these huge machines, the operating expenses are significantly driven by the necessity to transport the devices to a maintenance base, requiring heavy gear, expensive vessels and suitable onshore infrastructure. BRTP is directly addressing these cost drivers with a unique approach that combines the innovative TRITON platform developed by Tidal Stream, which is semi-submerged, floating and freely rotates to the flow, with inexpensive small and robust STG tidal turbines made by SCHOTTEL. A gravity base foundation is used to anchor the platform system and lowered down to the seabed prior to the final installation. The whole structure is assembled at shore and then towed out to the installation location. TRITON S36 supports 36 lightweight horizontal axis SCHOTTEL STG turbines and related electrical power conversion equipment for the autonomous production of **2.5MW** of electrical power in high tidal flow velocities.⁸⁹

3.2.6 Sihwa Tidal Power Plant

Country: South Korea

Location: Sihwa Lake, Gyeonggi Province

Coordinates: 37.31306°, 126.612778°

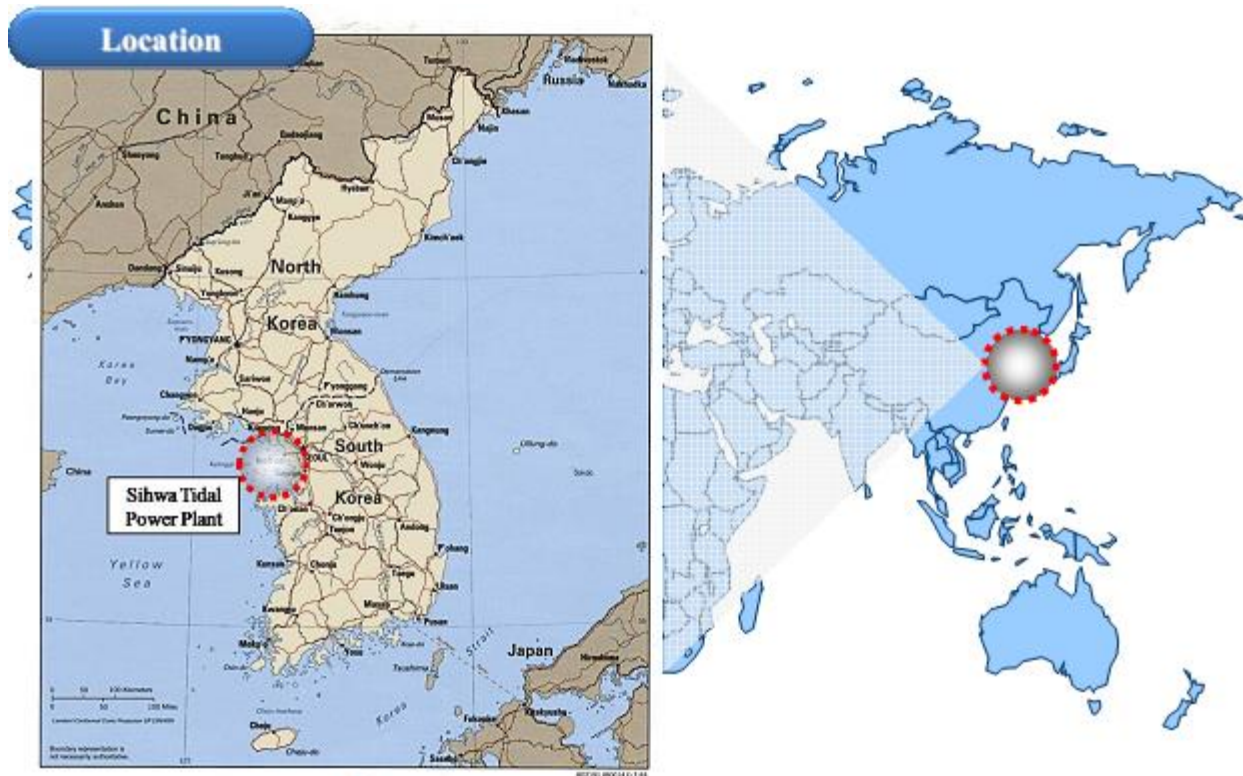

Figure 3.2.15 Location of Sihwa Tidal Energy Plant ⁹⁰

Timeline

- 1994.01. Completion of Sihwa Tide Embankment (11.2 km)
- 2000.12. Lake use plan was changed (Freshwater Lake→ Seawater Lake)
- 2002.12. Sihwa Tidal Power Plant Project decided
- 2004.12. Commencement of Construction ¹²³

Purpose

- To develop clean, renewable energy supplies
- To improve the water quality of Sihwa Lake
- Annual oil substitution Effect: 862,000 barrel
- Annual reduction of CO 2 emission: 315,000 ton

Interactive Qualifying Project

Project Summary

Employer: Korea Water Resources Corporation

EPC Contractor: Daewoo Engineering & Construction Co., Ltd.

Mean Tidal Range: 5.6m

Spring Tidal Range: 7.8m

Basin Area: 43km²

Generation Type: Single-Effect Flood Generation Type

Capacity: 254MW (25.4MW per turbine, 10 units)

Annual Generation: 552.7GWh

Water Gate: 8 Sluice Gates (Culvert Type)

Project Period: 2003~2010

Project Cost: US\$ 355.1 million

Completion: 2009⁹⁰

Design

The Sihwa tidal power plant use single direction units and the direction is from sea to basin.

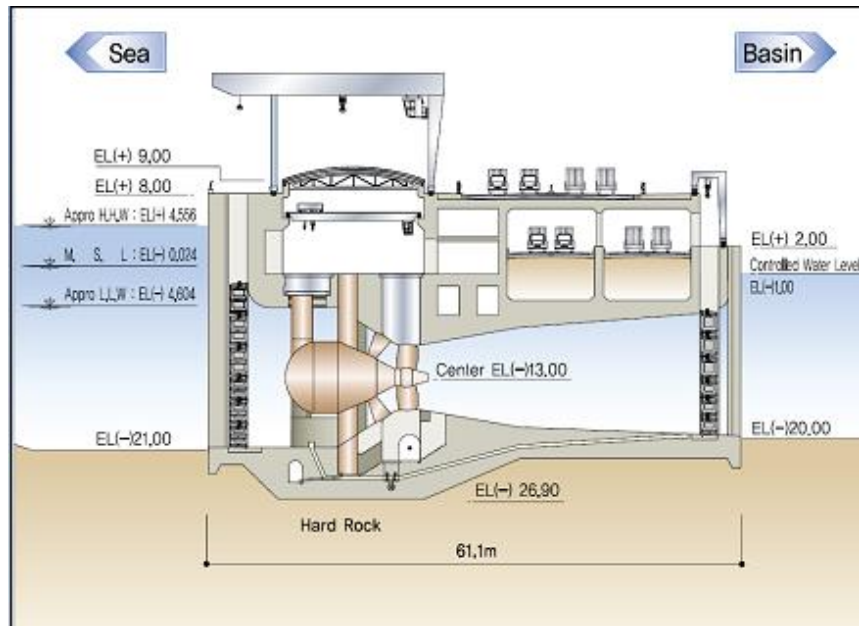

Figure 3.2.16: Design of the Sihwa tidal plant 1⁹¹

Capacity: 254M (25.4MW x 10 units). Structure provides 2 level road

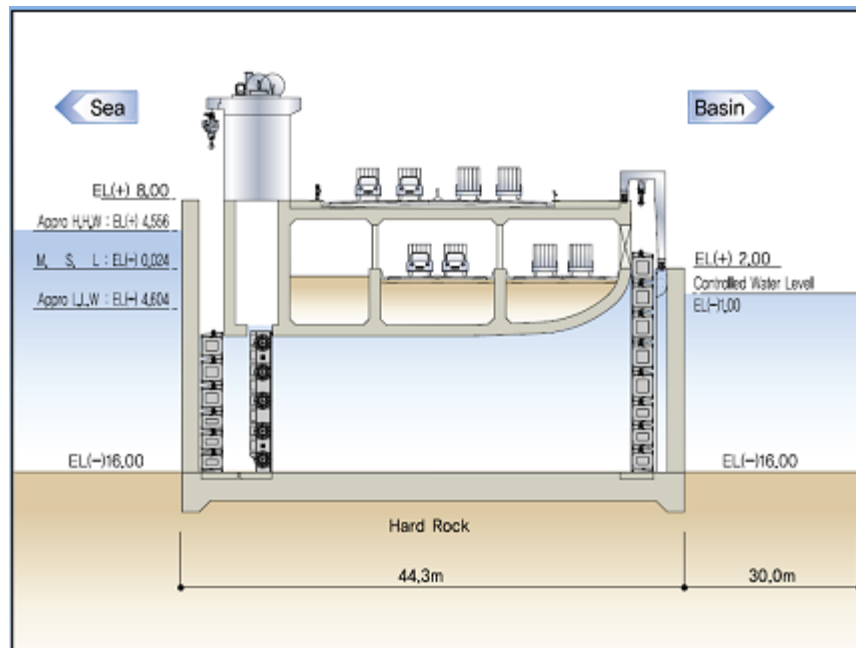

Figure 3.2.17: Design of the Sihwa tidal plant 2⁹¹

Culvert Type, 8 units

Dimension :B19.3m× H24.0m× L44.3m

Max. discharge : 1,098m³ /sec

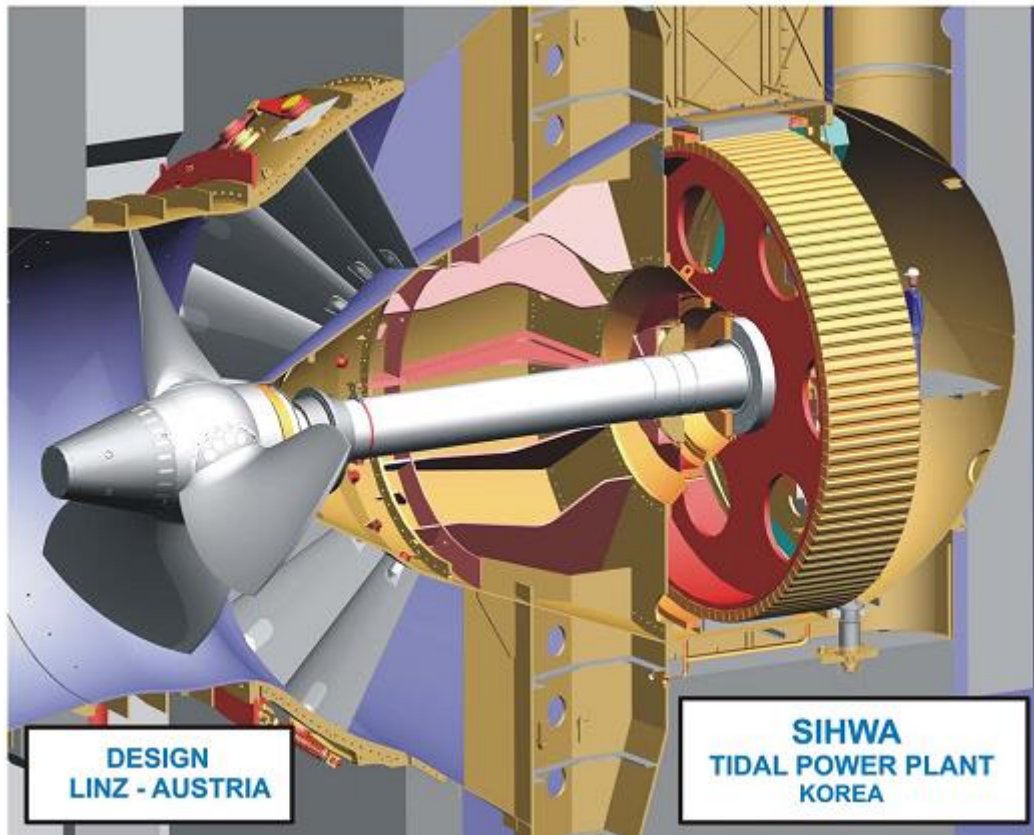

Figure 3.2.18: The tidal bulb design for Sihwa tidal power plant .⁹¹

The turbine is made of stainless steel and the frame is made of carbon steel all with cathodic protection. After the seawall was built, severe pollution built up in the newly created Sihwa Lake reservoir, making its water useless for agriculture. In 2004, seawater was reintroduced in the hope of flushing out contamination; inflows from the tidal barrage are envisaged as a complementary permanent solution. The tidal power station is providing indirect environmental benefits as well as renewable energy generation. During commissioning of the project a diffusion of pollutants to the sea was expected. To reduce this effect a gradual increase in power generation was implemented as part of commissioning procedures.

It is also expected to play a big role in restoring the Lake Sihwa ecosystem and water quality through the continuing circulation of sea water. The plant is to open the existing dam to allow the circulation and exchange of water between the Lake Sihwa and the sea. The tidal plant will improve the lake by circulating 60 billion tons of seawater annually.⁹²

3.2.7 La Rance Tidal Power Plant



Figure 3.2.19: Location of La Rance Tidal Power Plant⁹³

La Rance Barrage is the world's first tidal power station. The facility is located on the estuary of the Rance River, in Brittany, France.

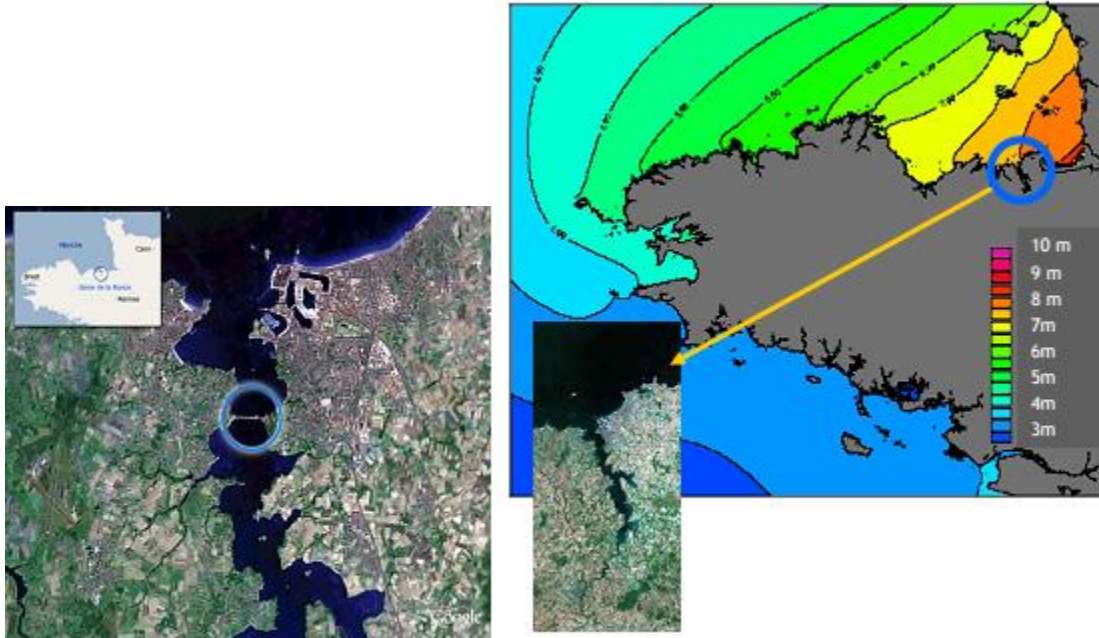

Figure 3.2.20: La Rance estuary ⁹⁴

Highest tidal range in France: average 8.2m - maximum 13.5m

A large reservoir: 184,000,000 m³ , spread over more than 20km upstream (22km² basin area)

Only a 750m wide estuary to be cut off

1.3 Data of La Rance Tidal Power Plant

Studied between 1943 and 1961, built between 1961 and 1966

- Equipped with 24 bulb-units rated 10MW
- Total installed capacity: 240 MW
- Generation: 540,000,000 kWh/year
- 20,000 boats/year passing the ship lock
- 30,000 up to 60,000 vehicles/ day on the road crossing the estuary
- 70,000 visitors per year

Interactive Qualifying Project

- EDF Staff: 28 employees for operation and routine maintenance
- Construction cost: €95m (1967) – about €580m (2009) ⁹⁴

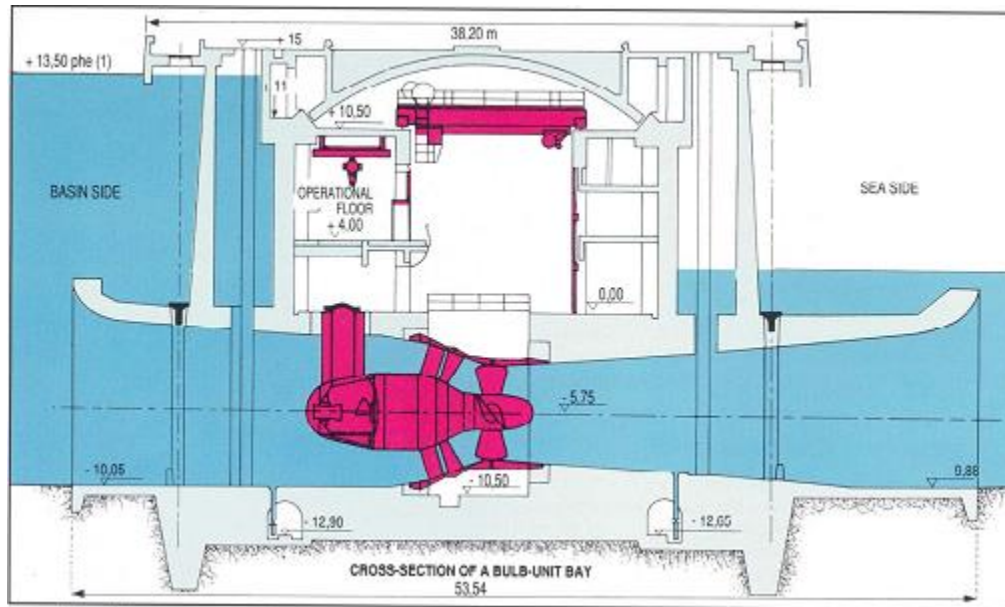

Figure 3.2.21: Design of La Rance Tidal Power plant 1 ⁹³

It is a cross-section of a bulb-unit bay with length: 332.5m. Note: +0 is the reference of the LAT level

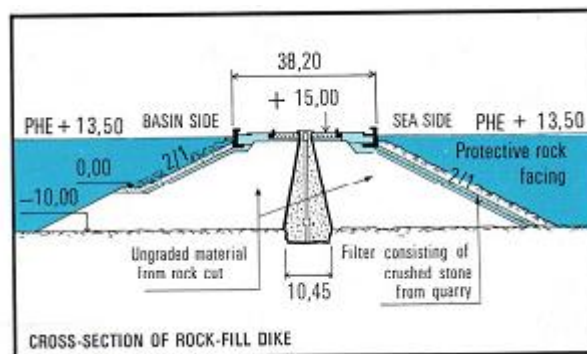

Figure 3.2.22: Design of La Rance Tidal Power plant 2 ⁹³

Dyke has a length of 163.6m. Initial Project: 16 additional turbines!

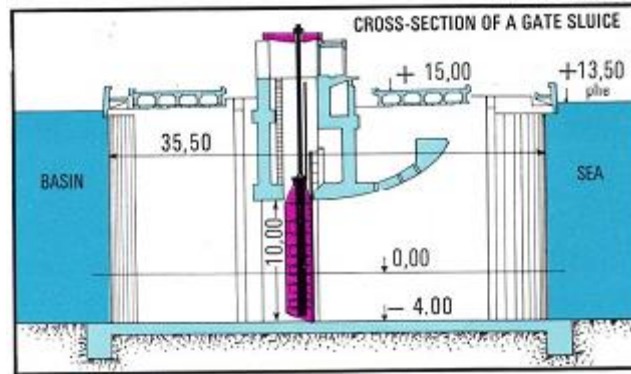

Figure 3.2.23: Design of La Rance Tidal Power plant ⁹³

Barrage has a length of 145.1m and there are 6 gates (H: 10m * W: 15m; fixed wheel gates « Wagon »). The maximum flow is 9,600m³ /s

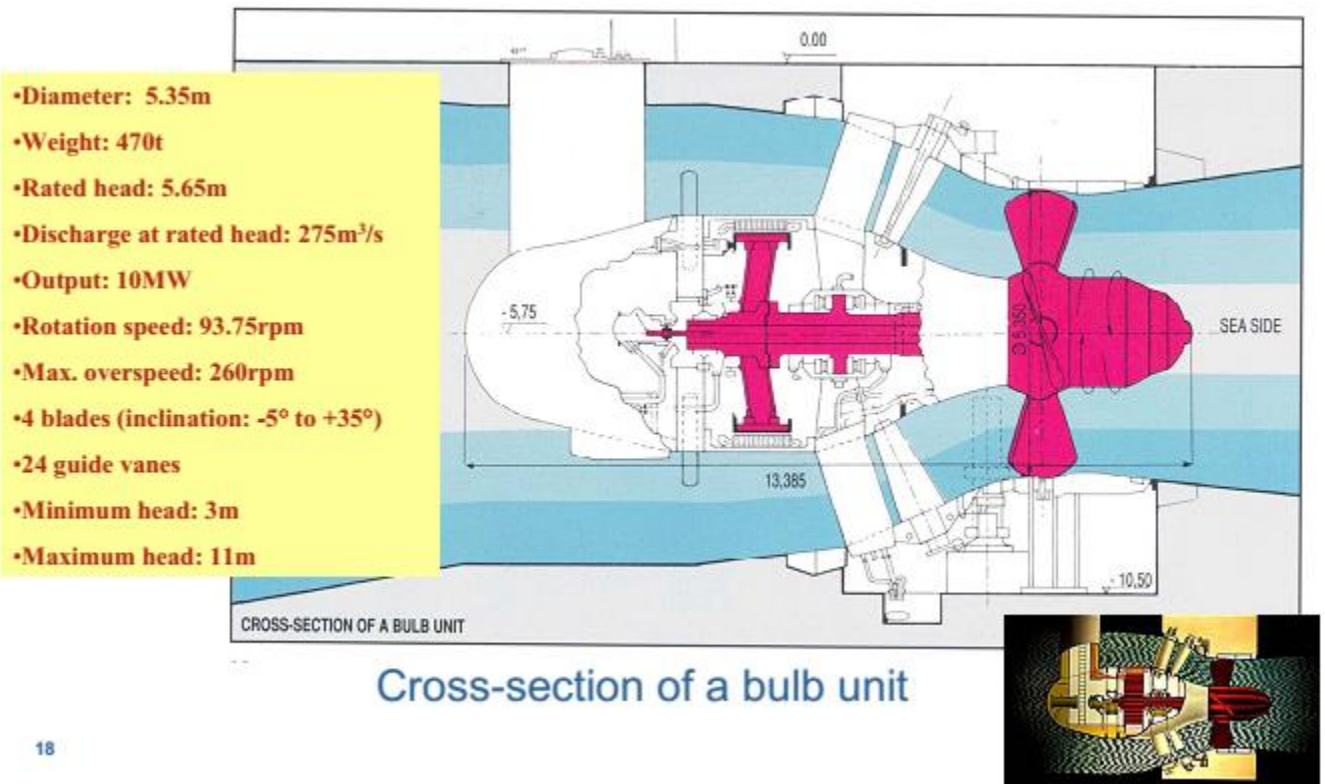

Figure 3.2.24: Design of the powerhouse for La Rance Tidal Power Plant ⁹³

24 x 10 MVA alternators operating in air under 2bar (28.44psi) absolute pressure; AI3.5kV

Interactive Qualifying Project

- 6 x operational units (« assembly ») comprising 4 bulb-units each: ancillary components in common + turbine adjustment and alternator energizing purposes
- 3 transformers units (3.5/3.5/225kV): 80MVA power, cooled by oil and blown-air circulation
- Connection to the 225kV station by oil-filled cables under pressure ⁹³ Operation

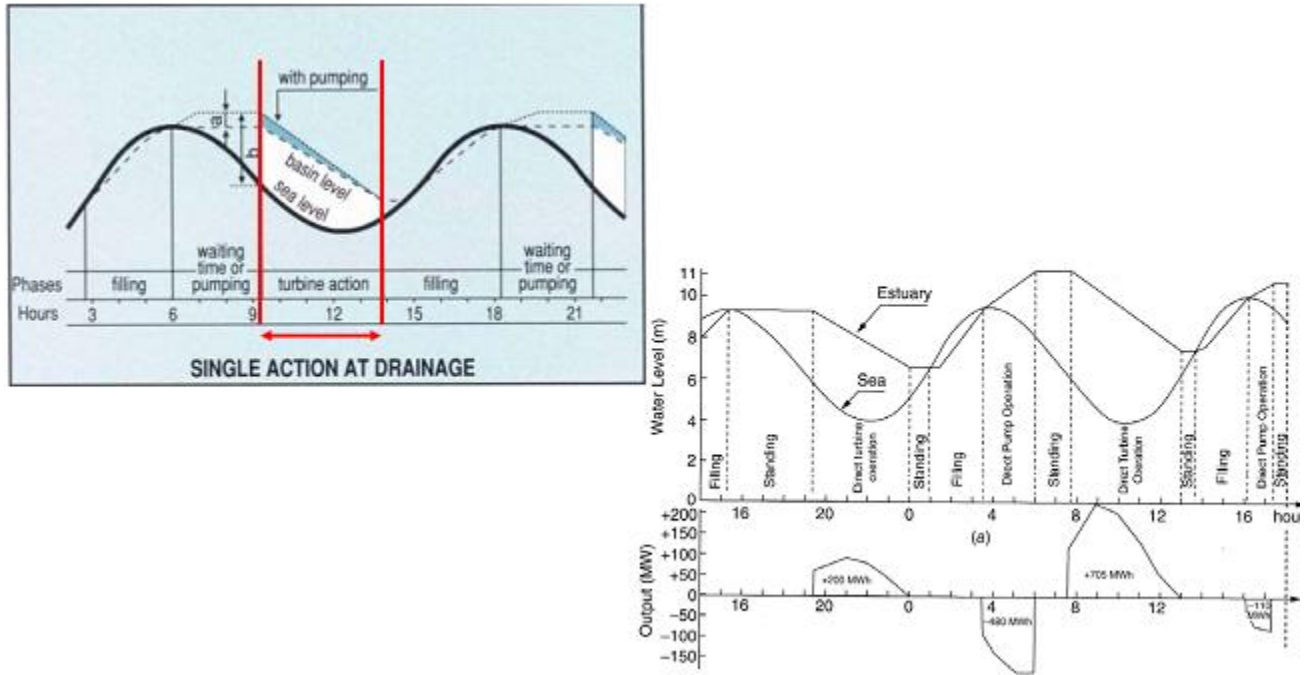

Figure 3.2.25: Illustration of simple effect ebb generation ⁹³

Minimum head for turbines (ebb generation): 1.20m – Maximum reservoir level increased by pumping: +1.75m

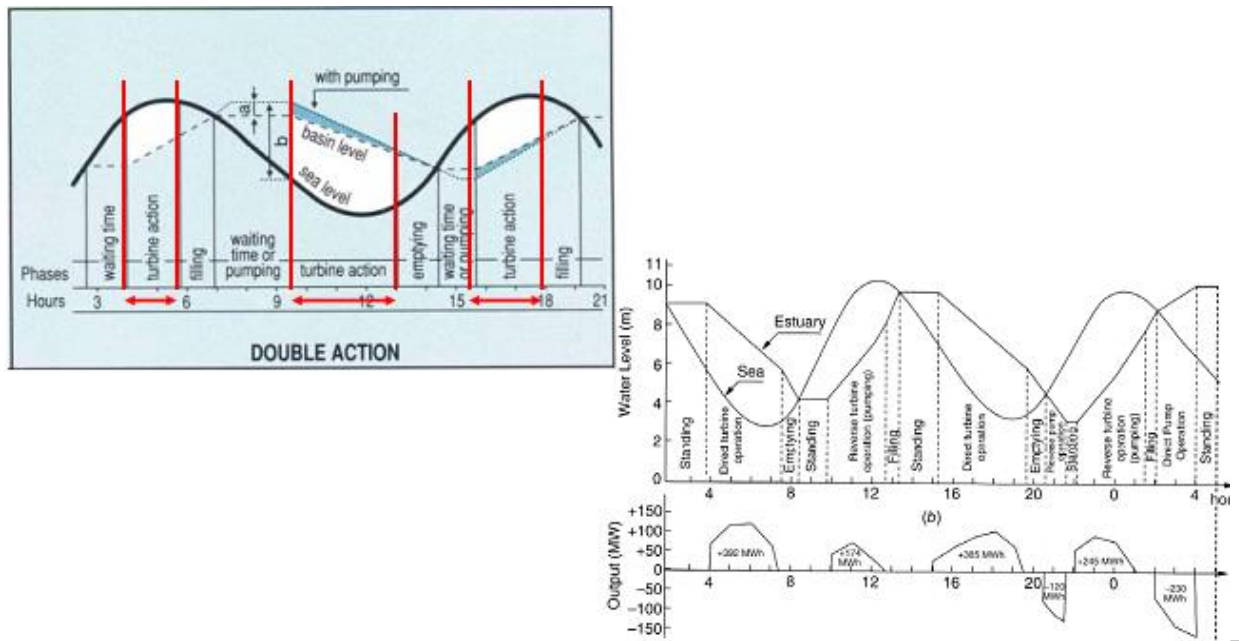

figure 3.2.26: Illustration of double effect ebb generation ⁹³

Minimum head for turbines (flood generation): 1.70m

La Rance average operation

- Ebb generation (direct turbinning): 60%
- Reverse pumping (reservoir towards sea): 0%
- Flood generation (reverse turbinning): 2 to 6%
- Direct pumping (sea towards reservoir): 15 to 20%
- Free flow through the turbines orifices (mainly sea towards reservoir): 20% (when $0.3 \text{ m} < \text{Head} < 1.2 \text{ m}$)
- No pumping required when tidal range is above 7 or 10 m

Now, flood generation only during high tides (tidal range $> 12\text{m}$) and maximum pumping capacity 56MW (according to contract with RTE)

Significant impact during the 3-year construction phases and closing of the estuary: disappearance of marine flora & fauna due to salinity fluctuations, heavy sedimentation and accumulation of organic matter in the basin

- By 1976, the Rance estuary was considered again as richly diversified: a new biological equilibrium was reached and aquatic life was flourishing again...
- By 1980, the basin was providing a habitat for 110 worm species, 47 crustacean species and 70 fish species. Enhancement of fish species and invertebrates abundance
- 2.5m rise of the mean level water and reduction of the hydrodynamic regime within the upstream estuary
- New fishery activities: scallops and now Belon oysters

Impact on birds

- Bird species variety is the same than before (120 species)
- A well-developed communities of fish-eating birds (gulls, guillemots, shags...)
- Birds adaptation: decrease of sand area (intertidal area)
- Birds can also find food in the other Bays (mudflats) ⁹⁴

3.2.8 Swansea Bay Tidal Lagoon

Swansea Bay (Welsh: Bae Abertawe) is a bay on the Bristol Channel on the southern coast of Wales. Places on the bay include Swansea and Port Talbot. The River Neath, River Tawe, River Afan, River Kenfig and Clyne River flow into the bay.



Figure 3.2.27: Location of Swansea Bay Tidal Energy Plant ⁹⁵

Swansea Bay Tidal Energy Plant is a 240MW tidal lagoon generating 420GWh net annual output. It can provide electricity for 120,000 homes (more than Swansea's annual domestic use). An extremely reliable electricity source offering predictable, zero carbon, electricity for 100 years. Saving over 200,000 tonnes CO₂ p.a. based on DEFRA guidelines.

World's first man-made lagoon capable of generating electricity 16 hours a day using both ebb and flood tides. It can be used for an iconic education, sports and art amenity, and an opportunity to develop a tidal range industry for the UK, centered on Wales. Low risk adaptation of proven components. Project is comprised of UK standard sand core breakwater & bulb hydro turbines mounted inside concrete turbine housings. Tidal power connected to the National Grid by 2020, as other power stations are closed down



Figure 3.2.28: Air view map of Swansea tidal energy plant ⁹⁵

Statistics for the planning

Wall length 9.5km Area 11.5km²

Rated capacity 240MW (@4.5m head)

Annual output (net) 400GWh

Design life 50-100yrs Height of wall 5-20m

Wall above low water 12m Wall above high water 3.5m

Interactive Qualifying Project

Tidal range Neaps 4.1m Tidal range Springs 8.5m

Lagoon wall is built using sandy materials gained from the sea bed inside the lagoon, hydraulically filled into geotextile casings known as Geotubes®. On top of these Geotubes and compact sand fill we place small rocks, and on top of this the larger rock armour. The construction has been modelled to withstand local sea/climate conditions, and to account for sea-level change.



Figure 3.2.29: Construction of bund for tidal lagoon ⁹⁵

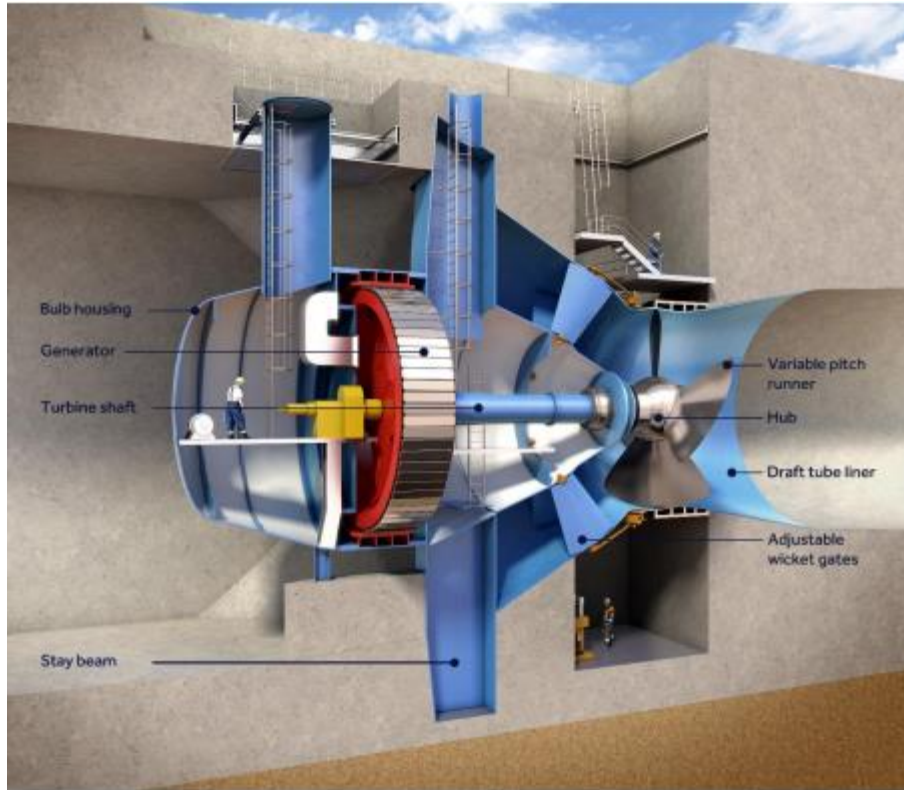

Figure 3.2.30: The structure of powerhouse for tidal lagoon ¹¹⁸

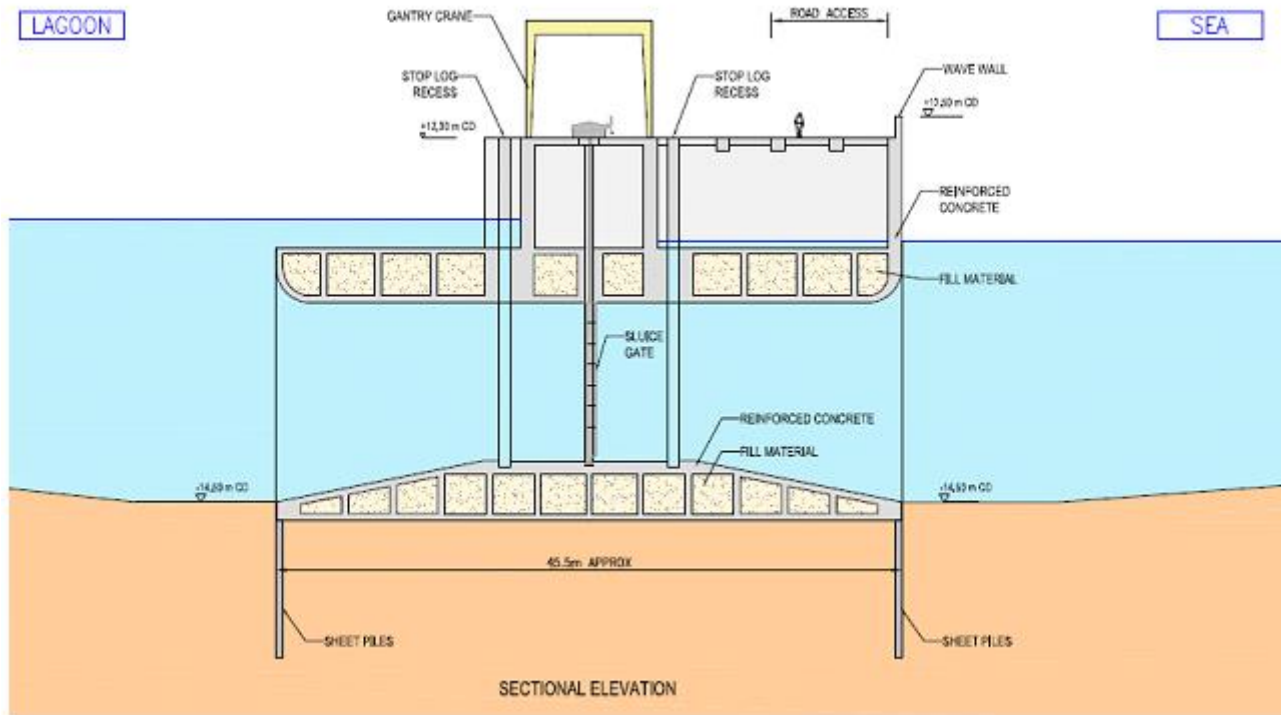

Figure 3.2.31: Sectional drawing of the sluice for Swansea lagoon. ⁹⁵

There are two designated bathing beaches within Swansea Bay (Aberafan Sands and Swansea Bay), which the Project avoids so as to preserve these amenities. Studies suggest there will be no impact on bathing beaches outside Swansea Bay. The site selected for the lagoon is on an intertidal area, which is not a designated bathing area, and which is predominantly backed by the Swansea docklands. We hope visitors to the lagoon will swim and enjoy watersports within its walls where access was previously difficult or unsafe.

Swansea Bay faces complex water quality issues related to its major rivers, waste water facilities and industrial heritage for example. Water quality within the Bay is key to the enjoyment of the area and the local economy, and to our ambitions for leisure use of the lagoon. It is important to us that our development has minimal adverse impact on water quality in the Bay, as well as surrounding areas. The lagoon's effect on water quality during construction, operation and decommissioning is a key part of the Environmental Impact Assessment (EIA), and the following areas have been assessed:

Interactive Qualifying Project

- Water quality at the designated bathing beaches in the Bay and surrounding area
- Water quality at the designated shellfish monitoring points and shellfish waters, and
- Water quality with respect to the objectives of the EU Water Framework Directive.

The EIA used a water quality model already approved for use in Swansea Bay by Dwr Cymru Welsh Water. An independent team of experts has applied the model to the 14 lagoon designs, and to various options for water quality treatment. As for other parts of the EIA, the results were communicated to our engineering team who adjusted the design to minimize the impact where possible. Results presented in our ES show that, with installation of additional storm water storage and/or treatment at Swansea Waste Water Treatment Works, we may have a net positive impact on water quality in the Bay. ⁹⁶

Although not a major fishing port, commercial and recreational fishing is important to local residents as well as to the local economy – and many people are concerned about ecology for its own sake. Direct and indirect impacts on fish and marine mammals have been assessed for the construction, operation and decommissioning phases of the lagoon. We have consulted experts and local-interest groups to gain further input into our assessment approach and ensure we have considered all possible impacts.

Assessments including noise/vibration disturbance, changes in habitat and changes in water quality were carried out to understand the impact. The significance of these potential impacts has been presented in our ES, and where possible we have identified measures to minimize any potential impacts.

Detailed fish computer modelling was undertaken for key species, including behavior modelling (the likelihood of the various fish species coming into the lagoon area) and entrainment modelling (the effect on any fish that pass through the turbines). The size of the turbines (7-8m in diameter) mean that there will be large gaps through which fish can pass, and the modelling has been carried out to understand the extent of this. Furthermore, the use of sluice gates will allow free passage of fish in and out of the lagoon in the latter part of the tidal cycle.

There will be some disruption to local fishermen, especially to any who ‘pot’ within the Project area. During operation, the lagoon would not be accessible to any fishing vessels which currently

use this area of the Bay and therefore this would result in a loss of some fishing grounds within the lagoon footprint.⁹⁶

3.2.9 Tidal Energy Potential in the World

Worldwide, the technically harvestable tidal energy resource from those areas close to the coast is estimated by several sources at 1 terawatts (TW). The potential for tidal current technologies is larger than for tidal range. Total tidal range deployment in 2012 was around 514 MW, and around 6 MW for tidal current (of which 5 MW is deployed in the UK). Extensive plans exist for tidal barrage projects in India, Korea, the Philippines and Russia adding up to around 115 gigawatts (GW). Deployment projections for tidal current up to 2020 are in the range of 200 MW.

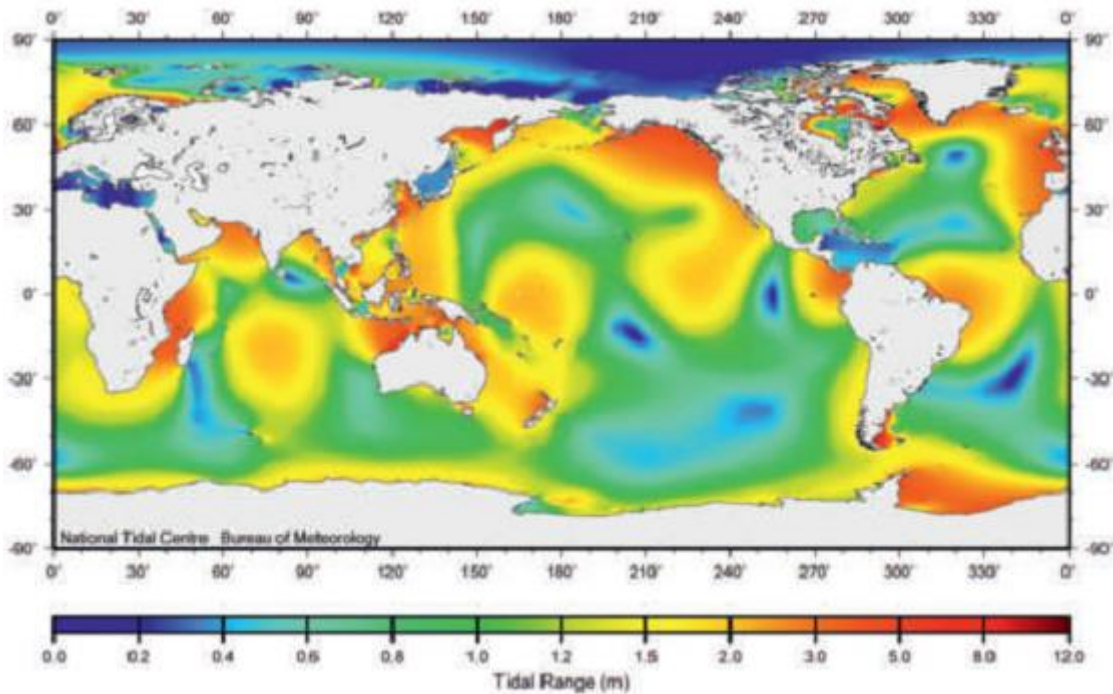

Source: Bureau of Meteorology, Australian Government

Figure 3.2.32: Illustration of the global tidal range⁹⁷

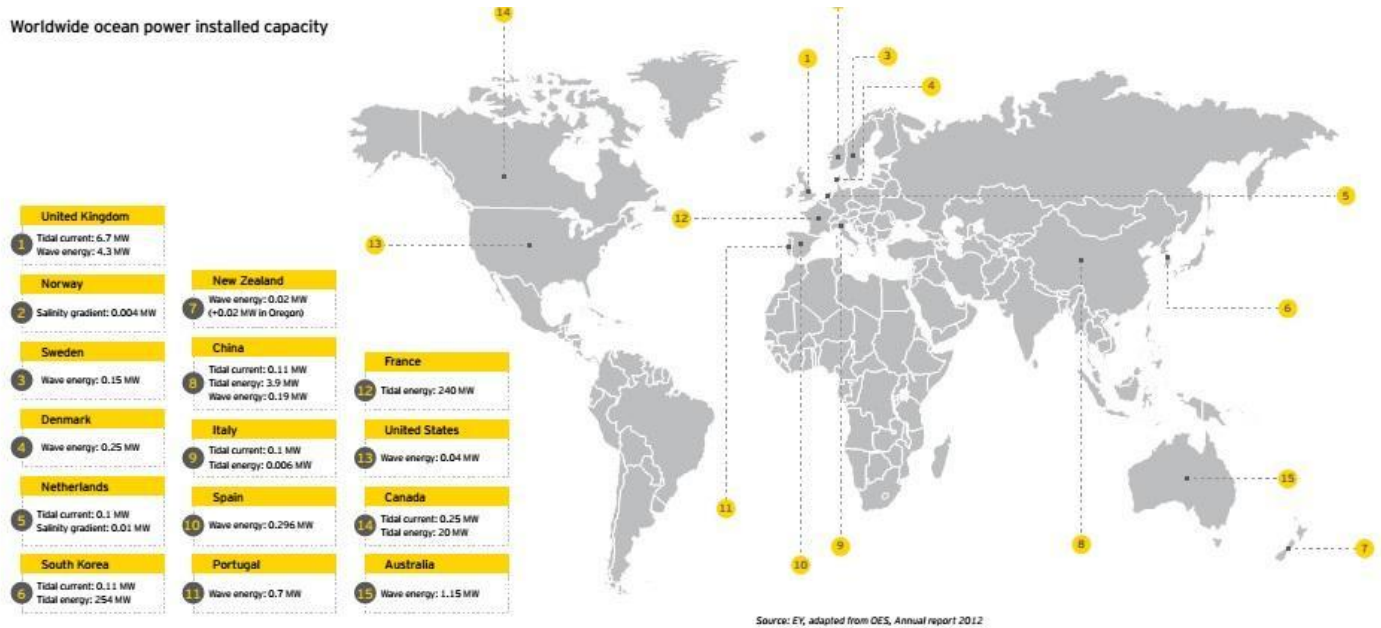

Figure 3.2.33: Worldwide ocean power installed capacity⁹⁸

Ocean energies can be extracted with a large variety of technologies that exploit the composition of the water or the power obtained from the kinetic energy of large bodies of moving water. These include tidal range, wave and tidal current technologies, thermal and salinity gradient technologies, and floating wind turbines.

To date, ocean energies represent only 0.01% of electricity production from renewable sources. Except for the tidal range technology, no technology is widely deployed as most of them are still at an early stage of development. According to Ocean Energy Systems (OES), the international technology collaboration initiative on ocean energy under the International Energy Agency (IEA), total worldwide installed ocean power was about 530 MW in 2012, of which 517 MW from tidal range power plants. Technologies to exploit tidal range power are today the only ones to have reached commercialization stages in the ocean energy group although they also involve high investment costs and considerable environmental impacts. Only four tidal range power plants exist in the world: two major plants, one in South Korea (254 MW) and one in France (240 MW), and two smaller plants, one in Canada (20 MW) and one in China (3.9 MW).

This technology could also undergo further developments as several projects are under development in the UK (Severn tidal) and especially in South Korea.

The development of other forms of ocean energy (tidal current, wave, thermal, and salinity gradient and flatting wind technologies) has accelerated in the past five years, and some of them could reach commercial maturity by 2020. Wave power devices are currently being demonstrated, and underwater tidal turbines driven by currents are close to commercialization. Overall, 22 MW of wave and tidal current devices were installed in 2012. OES estimates a worldwide potential of up to 337 GW of wave and tidal energy capacity by 2050, and possibly a similar contribution from ocean thermal energy conversion. The European Ocean Energy Association estimates a European potential of 188 GW by 2050, which would satisfy 15% of European electricity demand and, in some countries, up to 20% of national demand.

Several countries have recently developed national strategies to support the ocean energy sector. For instance, after various supporting programs, such as the Marine Energy Accelerator of the Carbon Trust, the UK Government established a new marine energy program in 2011 that is focusing on enhancing the UK marine energy sector's ability to develop and deploy wave and tidal energy devices on a commercial scale. In June 2011, the UK Department of Energy and Climate Change (DECC) announced it was investing up to £20m in wave and tidal power to help develop marine energy technologies to support the Marine Energy Array Demonstrator (MEAD) Scheme. The DECC also supports these developments through feed-in tariffs: the UK and Scottish

Governments confirmed in July 2012 the incentives for wave and tidal energy at 5 ROCs per MWh for projects up to 30 MW capacity that are installed and operational prior to 1 April 2017. In 2012, Scotland also produced its Marine Energy Action Plan detailing key elements around which it would further develop and support the marine renewables industry.

The last two years also saw other countries launch various initiatives aimed at developing the ocean energy sector: a new Danish strategy for development of wave energy was initiated in 2011; Japan established its Ocean Energy Technological Development Research Center, which aims to promote ocean renewable energy; and the Spanish Government officially approved the Renewable Energy Plan 2011–2020. In 2012, the French Government presented a roadmap for

the development of tidal energy. Canada is also investing in the sector, especially the Nova Scotia region, which put in place a demonstrator site for tidal energy in the Bay of Fundy and released its Marine Renewable Energy Strategy in 2012. The US, China and Korea have also developed specific strategies targeting marine energy. Private actors are also investing in marine energy technologies. Investments have become more sustained in recent years with the positioning of multinational companies in this sector. Since 2011, an increasing number of acquisitions have taken place. This is the case in France, with Alstom's acquisition of shares in AWS Ocean Energy Ltd. in May 2011 and of Rolls-Royce Tidal Generation Limited in January 2013, as well as the finalization of DCNS's acquisition of Open Hydro Group Ltd., to be finalized in 2013. Siemens AG also reinforced its participation in Marine Current Turbines Ltd. by acquiring a 55% additional stake in this Bristol-based tidal stream technology developer in February 2012. In March 2012, Andritz Hydro GmbH acquired a 22.1% stake in Hammerfest Strom AS, a Norway-based developer of marine current turbines. Investments in the ocean energy sector also involve fund-raising. For instance, in December 2012, Scotrenewables Tidal Power Ltd., an Orkney Island-based renewable energy research company for the wind, wave and tidal energy sectors, raised £7.6m (US\$12.3m) in a private equity funding round. ABB, the global power and automation technology group, also led a US\$12m investment in this company in March 2013 through its venture capital unit, ABB Technology Ventures (ATV). This recent development of marine energy should expand in coming years. Indeed, the IEA believes that ocean energy technologies could start playing a sizable role in the global electricity mix around 2030. According to the agency's technology initiative OES, ocean energy may experience similar rates of rapid growth between 2030 and 2050 as offshore wind has achieved in the last 20 years. The IEA estimates the worldwide potential power of each type of energy as follows:

- Wave power: 29,500 TWh/year
- Tidal range power: 1,200 TWh/year
- Ocean thermal energy: 44,000 TWh/year
- Salinity gradient power: 1,650 TWh/year

Future developments could create about 1.2 million direct jobs by 2050, according to OES. For instance, tidal energy could potentially create 10 to 12 direct and indirect jobs per MW

installed, and wave energy could potentially create about 8 to 9 direct and indirect jobs per MW installed. Regarding recent developments and demonstrators actually being tested, tidal and wave energy should be the first emerging ocean technologies to be commercialized in coming years.

A public consultation held in September 2012 by the European Commission showed strong consensus over the potential of ocean energy. The European Commission has identified “blue energy” as one of the first focus areas that could deliver sustainable long-term growth and jobs in the “blue economy.” The same consultation also highlighted the constraints that need to be addressed to allow further development, such as the length and complexity of authorization, certification and licensing procedures in individual Member States. A large majority of respondents also think that there should be a specific policy supporting ocean energy development at the EU level, as well as long-term visibility. Regarding technical barriers to grid connection, the lack of agreed standards and technical specifications and of construction and installation vessels were the barriers most frequently cited by stakeholders to the development of ocean energy. A large-scale deployment of ocean energy will thus depend on the sector’s ability to address these technological and economic challenges.¹⁴⁰

3.3 Current Energy

3.3.1 Overview of Resources

Global ocean currents possess a huge, relatively untapped potential. There have been a number of estimates about the total energy potential held by them, however these evaluations vary largely from study to study. Many of these also don’t look into a number of feasibility factors involved with extracting energy from ocean currents. One study reports that there’s about 450 GW of potential energy (Ocean Current Energy), while another reports 5,000 GW.⁹⁹ Clearly, with this level of disagreement, it would be more helpful to observe individual characteristics of potential current-energy sites, rather than just their potential energy.

Below is a diagram of the main ocean currents worldwide. It should be noted that these exist primarily along coasts, or more specifically, along headlands and islands. This is to be expected, as the locations are natural bottlenecks for water and therefore produce stronger current.

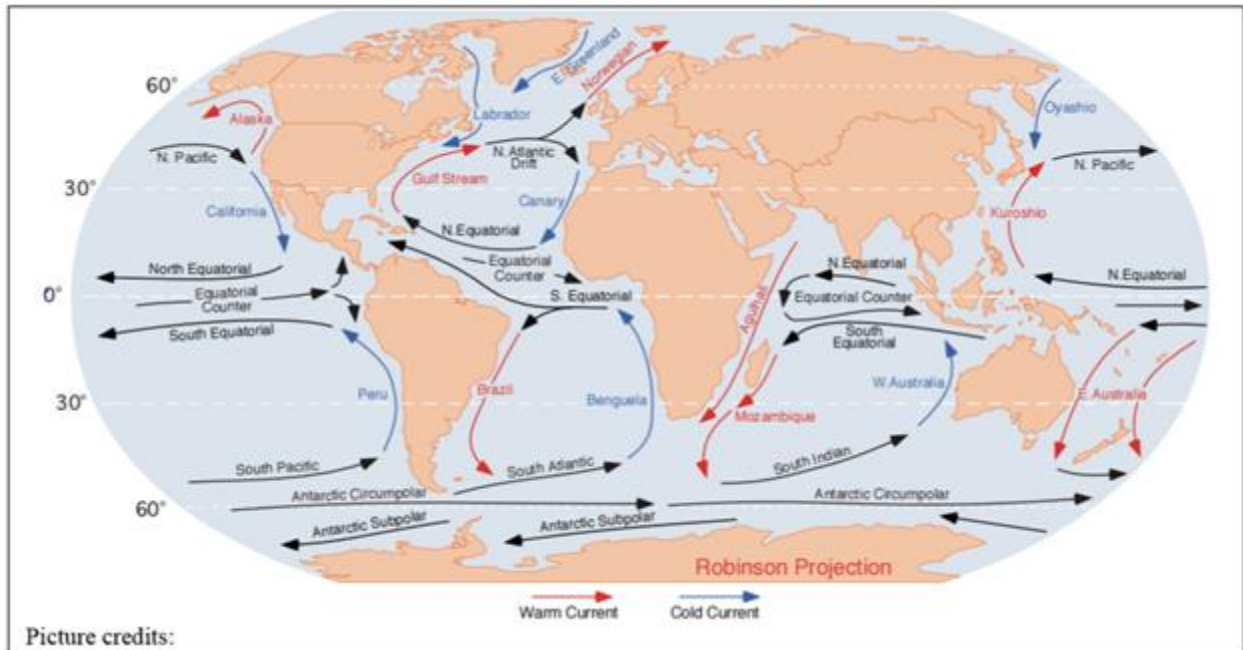

Figure 3.3.1: Strongest ocean currents worldwide. ⁹⁹

Of course, not all of these currents are feasible for installing turbines. Some factors that impact this feasibility is distance from shore (meaning more costly cable infrastructure), seafloor depth (too deep will cause vastly more expensive turbines), and average power density (there needs to be enough space and power for a turbine farm). The following locations have been selected for observation and show promising power densities, so we will concentrate on them for now: South East U.S., Japan, South Africa, Indonesia, Somalia, Brazil, Madagascar, and Australia. Each of these locations have been found to have average power densities greater than 0.5 kW/m^2 at depths of 50m (explained below). ¹⁰⁰

Interactive Qualifying Project

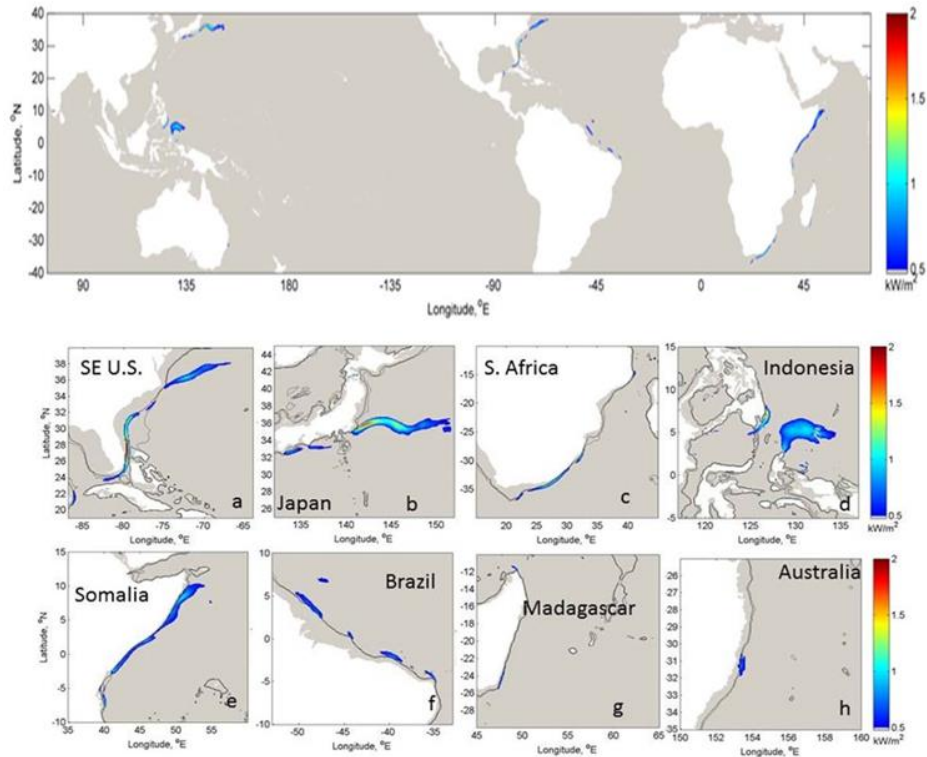

Figure 3.3.2: Ocean currents with power densities greater than 0.5 kW/m² at 50m depth ¹⁰⁰

The power density was calculated using the equation $P = \frac{1}{2}\rho V^3$, where P is the power density per unit area, ρ is the density of seawater, and V is free-stream current magnitude. The table below represents several pieces of information for each location. It contains spatial averages over a 3-year time period (P_{Avg}), maximum power densities (P_{Max}), normalized standard deviations ($\sigma\sqrt{P}$), area with average power density over 0.5 kW/m² ($A_{0.5}$), area with average power density over 1.0 kW/m² ($A_{1.0}$), and area with average power density over 1.5 kW/m² ($A_{1.5}$). These are all assuming a depth of 50m. In total, nearly 836,000 km² of the ocean has an average power density over 0.5 kW/m², about 10% of this area possesses 1.0 kW/m², and only 2% of it has 1.5 kW/m². ¹⁰⁰

Interactive Qualifying Project

Region	Associated Current	\bar{P}_{Avg} (kW/m ²)	σ_P/\bar{P}	\bar{P}_{Max} (kW/m ²)	$A_{0.5}$ (km ²)	$A_{1.0}$ (km ²)	$A_{1.5}$ (km ²)
Southeast US (Fig. 2a)	Gulf Stream	0.776	0.949	1.93	144,830	25,871	7,537
Japan (Fig. 2b)	Kuroshio	0.792	1.34	1.78	173,401	37,309	5,840
South Africa (Fig. 2c)	Agulhas (South)	0.764	1.09	1.66	68,055	12,987	225
Indonesia (Fig. 2d)	Equatorial Currents	0.744	2.18	1.57	196,518	8,696	681
Somalia (Fig. 2e)	Agulhas (North)	0.661	1.79	1.34	182,827	2,425	0
Brazil (Fig. 2f)	North Brazil Current	0.598	1.15	1.08	57,338	169	0
Madagascar (Fig. 2g)	Mozambique	0.645	0.979	0.86	8,570	0	0
Australia (Fig. 2h)	Eastern Australian	0.582	1.20	0.73	4,365	0	0
Total	-	0.696¹	1.34¹	1.369¹	835,904	87,457	14,283

¹ Mean of values above

Table 3.3.1: Average power per area information for each region. ¹⁰⁰

The depth of 50m was chosen because it is the average cut-off point for most of these regions before they begin dramatically decreasing in power. It is also an acceptable depth in relation to most commercial (boating or otherwise) traffic. The average power for all of the regions in relation to depth was 0.696 kW/m². This has higher power density compared to wind/solar given normal conditions (10 m/s wind and average atmospheric conditions/solar insolation), which yield 0.6 kW/m² kinetic energy density for wind and 0.432 kW/m² of solar radiation a day for solar. ¹⁰⁰

3.3.2 Resources In-Depth

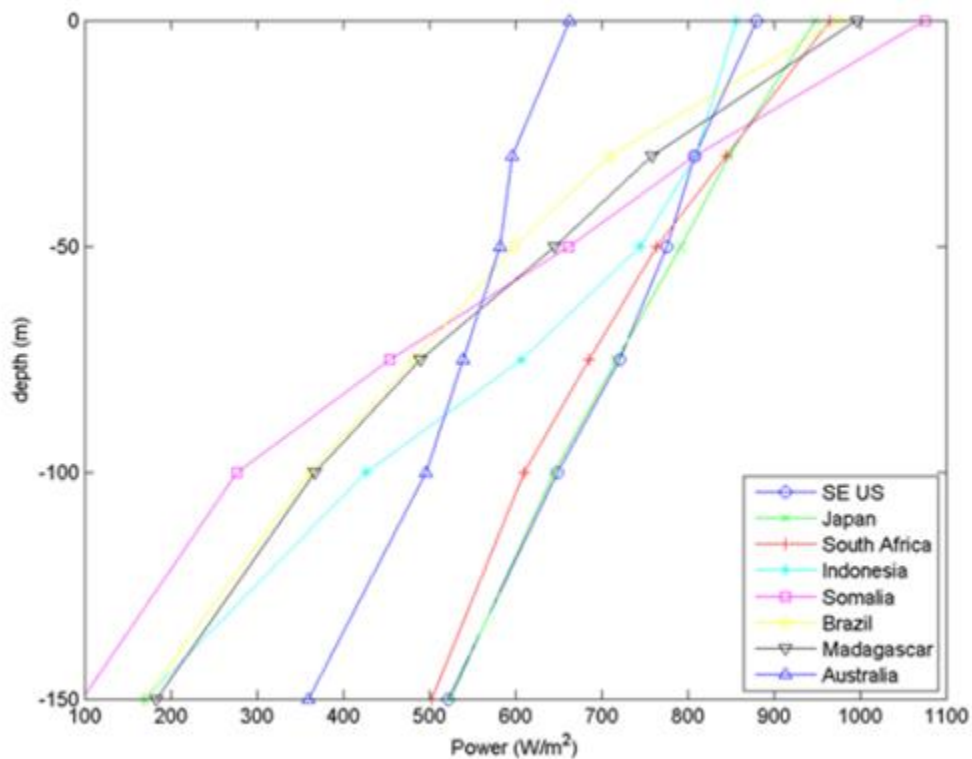

Figure 3.3.3: Average power density of each region in relation to depth. ¹⁰⁰

The next factor we looked into was distance from shore. This is important because the further the turbines are from the shore, the higher overall costs (infrastructure, maintenance, and energy collection). While there is an abundance of energy as seen above, only a small percentage of it is within a reasonable distance from land. Of the regions with energy densities higher than 0.5 kW/m², only about 2% (1.67×10^4 km²) are within 25 km of shore, about 18% (1.5×10^5 km²) are within 50 km, 33% (3.68×10^5 km²) are within 75 km, and 44% (4.91×10^5 km²) are within 100 km. Despite this making it seem that the majority of power is far from land, the areas with average power density higher than 1.5 kW/m² are actually closer overall. 75% of them (1.07×10^4 km²) are within 100 km. ¹⁰⁰

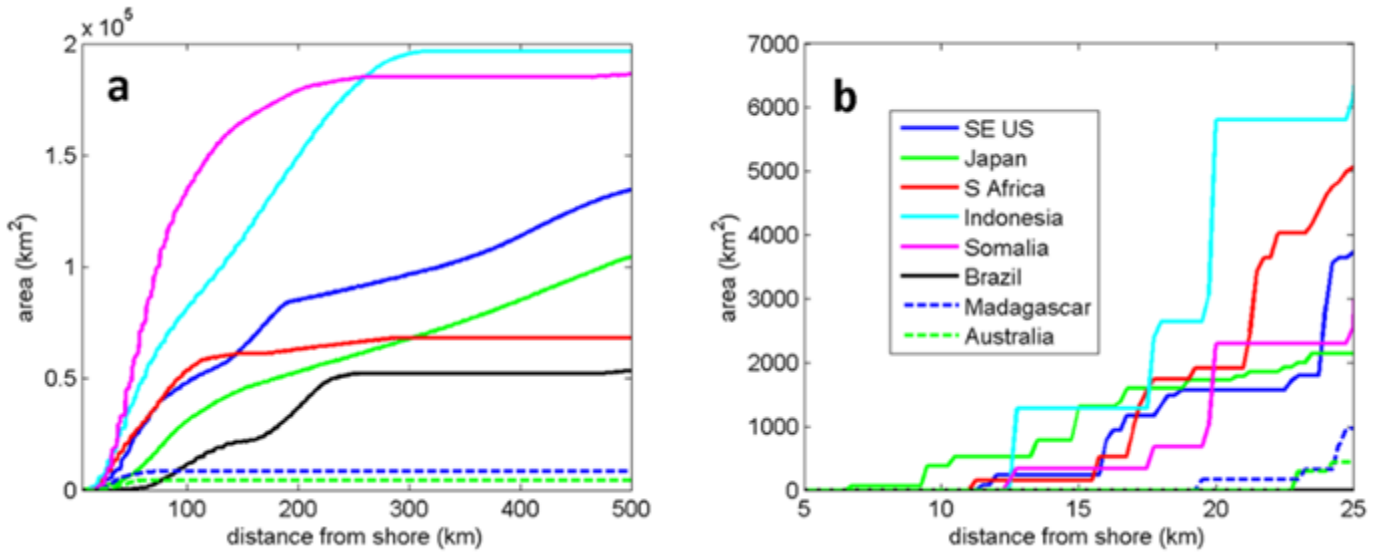

Figure 3.3.4: Areas with power density higher than 0.5 kW/m² in relation to distance from nearest land ¹⁰⁰

Finally, we looked at the depth of the ocean floor in these areas. This was to get an idea of how costly it would be to build, install, and maintain turbines in these areas. Keep in mind that the average optimal depth to install turbines would be around 50m. The findings for seafloor depth were very similar to the data regarding distance to shore. The majority (67%) of the areas of interest were found to have seafloor depths of over 2000 m. However, again, areas with more significant power densities (over 1.5 kW/m²) had a more reasonable seafloor depth, the majority of which (54%) being between 400 and 800m. ¹⁰⁰

Bottom Depth (m)	$A_{0.5}$ (%)	$A_{1.5}$ (%)
< 200	0.5	0.5
200-400	2.7	2.1
400-600	4.8	35
600-800	6.1	19
800-1,000	4.0	1.5
1,000-2,000	15	6.8
> 2,000	67	35

Table 3.3.2: Percent of ocean area that have a given bottom depth for areas of 0.5 and 1.5 kW/m² ¹⁰⁰

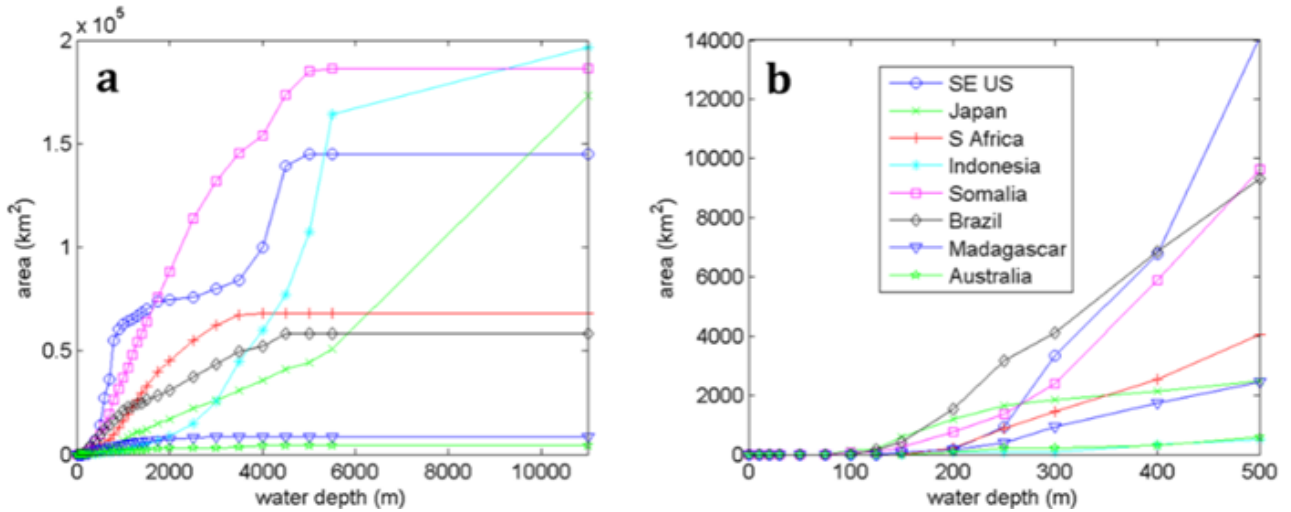

Figure 3.3.5: Areas with power density higher than 0.5 kW/m² in relation to sea floor depth ¹⁰⁰

The factors described above play a pivotal part in determining the feasibility of ocean current energy as a renewable resource. Another major factor, of course, is cost. Manufacturing/installation costs tend to be the highest factor for ocean current technology, however maintenance plays a large part as well (as with most ocean technology, strong currents and deterioration of material can be very costly). Below is a chart showing the cost of three different ocean current energy technologies and their corresponding short-term costs. We would like to emphasize the “short-term” part of this, as this does not include the cost of maintenance. However just looking at the short-term cost, these turbines appear to be cheaper than wind systems: wind costing around \$4,800-\$6,500/kW. Below this chart is diagram illustrating the cost of ocean current/tidal energy in the UK, where it has been implemented on a large scale more than any other region. The diagram also compares costs to wind energy and the ongoing reduction of renewable energy costs across major regions.

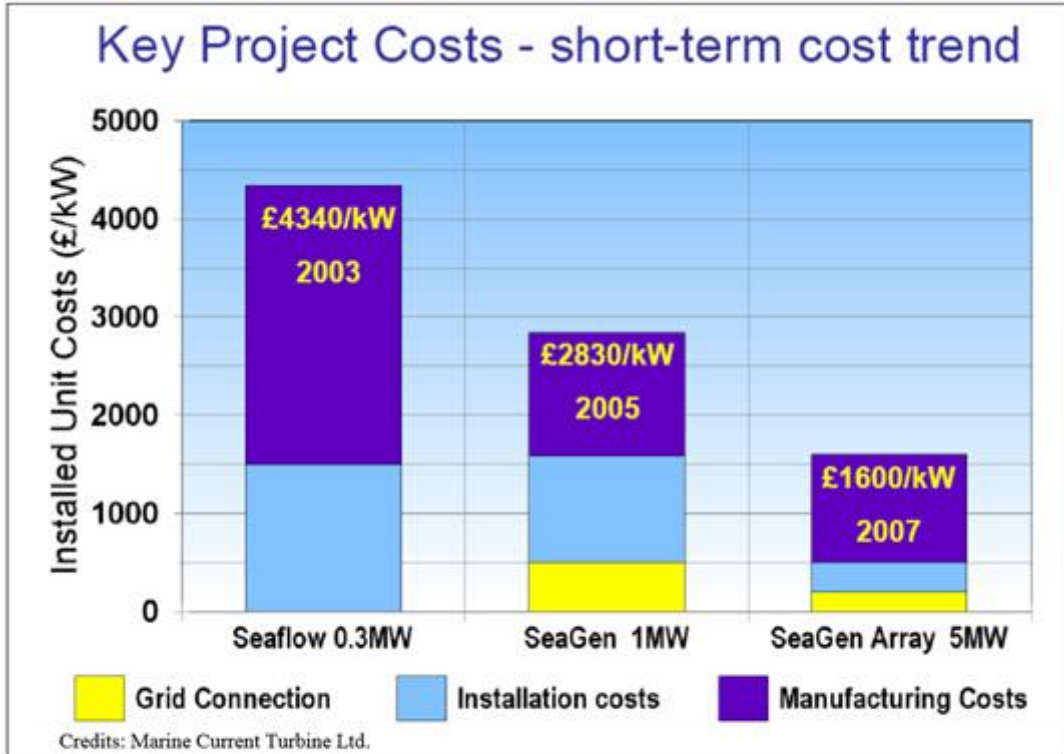

Figure n°21: The costs of ocean current real project in different situation. This diagram comes from the Seaflow project feedback on experience so far by Peter Fraenkel (Cf. Bibliography).

Figure 3.3.6: Short-term cost of selective ocean current turbine. ⁹⁹

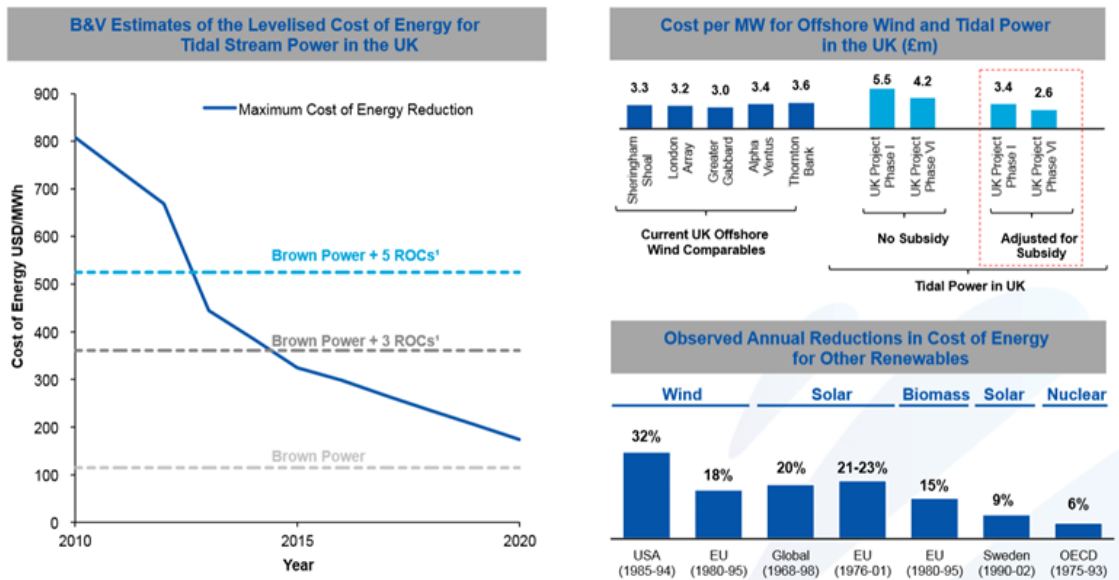

Figure 3.3.7: Long-term cost of tidal/stream power in UK, with comparisons. ¹⁰¹

3.3.3 Turbines

Now that we have outlined relevant factors, we look to the current technology to see what is feasible. Below is a table of the most practical turbines to date (chosen primarily on the basis of capacity and readiness for deployment). Each device has its associated capacity, cost, conditions for rated capacity, cut-in speed (minimum speed the turbine will produce usable energy), size, and status (current state of the device), though some fields may be missing (namely cost, as many of the devices are not yet commercially available). We will use these turbines as our reference for the feasibility of the locations described above as potential energy sources, how much energy they may produce, and how much it may cost.

Device Name	Capacity	Cost	Rated Conditions	Cut-in Speed	Size	Status
Orca 7	1MW+	N/A	Current of 3.5 m/s and 40m+ depth	0.5-1.5m/s	20m height and 13m diameter	Scale model sea trials
AK-1000	1MW	\$7.5 million per unit	2.65 m/s current speed	0.5-1.5m/s	22.5m height and 18m diameter	Commercial use
HS1000	1MW	Estimated \$4 million per unit	1.8-4 m/s current and depths up to 100m	N/A	30.5m height and 23m diameter	Full scale sea trials
SeaGen	1.2MW	\$2,500/kW small	2.4 m/s	0.7	16m	Commercial

Interactive Qualifying Project

		scale, \$1,500/kW large scale (estimates)	current and depths up to 30m	m/s – 100 kW	diameter	use
Deep Green	0.5MW	\$0.089/kWh	1.2-2.5 m/s and depths of 40-120 meters	1 m/s – 150 kW	8-14m long	Scale model sea trials
Pulse- Stream	1.2MW- 5MW	\$1.5 million per scaled prototype	18-35m depth, 2.5m/s	0.5- 1.5m/s	10m tall, 13m wide, 45m long	Scale model sea trials
DeltaStream	1.2MW	N/A	3 m/s	0.8m/s	36m diameter	Scale model sea trials
DEEP Gen IV	1MW	N/A	2.7 m/s current	1 m/s	22m long, 18m diameter	Full scale sea trials
Triton	3MW	~\$3,323/kW, ~\$0.2/kWh	35-55m depth	Less than 1 m/s	20m diameter	Full scale prototype
Voith HyTide 1000-16	1MW	N/A	30m+ depth and 3m/s current speed	0.5- 1.5m/s	16m diameter	Full scale sea trials

Interactive Qualifying Project

AR1000	1MW	N/A	2.65	N/A	18m diameter and 22.5m tall	Full scale sea trials
Kawasaki 1MW Tidal Turbine	1MW	N/A	2.5 m/s	N/A	N/A	Full scale prototype
Open-Centre Turbine	0.3-1.5MW	N/A	1.5MW at 2.57m/s and seabed-mounted	0.7 m/s	10-16m diameter	Full scale sea trials
TidEl	1MW	\$0.09/kWh large scale (estimate)	2.3 m/s	0.7 m/s	2 18.5m rotors separated by 22m long beam	Full scale sea trials
Underwater Electric Kite	0.4MW	\$1,200/kW for installation and manufacturing of moderately-sized sites (3MW or larger). \$0.0203 per kilowatt hour delivered for annual maintenance and	3 m/s	1.5 m/s	6.2m diameter, 5m height	Commercial use

Interactive Qualifying Project

		operation.				
RTT 2000	2MW	\$1,500/kW	3.1m/s and 10m depth	1 m/s	32m height, 30.5m length	Commercial use

Table 3.3.3: Most feasible ocean turbines based on capacity and status ^{128, 131, 130, 121, 129, 124}

Now that we have modern day turbine data as well as the largest current energy sources worldwide, we can determine the ocean current energy potential based on this data. Table 3.3.1 displays the power of currents in kW/m², however the turbines require currents of certain velocities (m/s). The equation $P = \frac{1}{2}\rho V^3$ can now be used to figure out what the velocities of these currents actually are. ρ , the density of sea water, is about 1040 kg/m³. With this in mind, some simple math will show that areas with power equal to 0.5 kW/m² have a velocity of about 0.99 m/s, areas with 1 kW/m² will run at about 1.25 m/s, and areas with 1.5 kW/m² flow at about 1.42 m/s. These are clearly lower than just about all of the turbines' rated velocities, however that's ok. These velocities only indicate what the turbine requires to reach its rated capacity. What's important is that these speeds are well above most of the turbines' cut-in speed, which is the minimum speed, required to generate usable electricity. With this in mind, we will determine a rough estimate of the electricity provided (as well as the cost) if these turbines were to be installed in the described areas.

3.3.4 Theoretical Modeling

We will use Deep Green to estimate the amount of power that can be extracted from these currents. This is because it is one of the only two that have public data available detailing what power is generated at their cut-in speeds. Deep Green is chosen over Seagen due to its cut-in speed being closer to the velocity associated with 0.5 kW/m², which is what all of the given areas have a minimum of. Therefore we can determine the minimum amount of power generated, though not the maximum. Because the current speeds will vary, and therefore larger turbines

Interactive Qualifying Project

may be desirable in areas with higher speeds, we will assume a mean size of the turbine at 11m length. Finally we must determine how many turbines can be fit into a given area of water. This varies greatly based on the turbine, for example standard horizontal axis turbines can be spaced based on their rotor diameter, while multiple Deep Green turbines may need to be spaced apart based on their tether length. With this in mind, we will be assuming spacing based on the needs of Deep Green. These turbines are required to be one tether length apart, meaning they must be spaced apart roughly the depth of the seafloor. This number will vary based on location from below 200 meters to above 2000 meters. Note that this number does not take into consideration unusable seafloor. In these cases we will assume either the amount of spacing between turbines will compensate for that or that this is a potential source of error. Finally, the turbines are assumed to have a minimum lifespan of about 20 years, though this is only taken from the known lifespan of the kite's wing.¹⁰²

Given that there is 835,905km² area of ocean that has a power of 0.5kW/m² or higher, this results in a total of 1,356,620 turbines that can be placed. This number assumes that turbines can be placed at *any* seabed depth, given a large enough cable length. This has been confirmed with Minesto however has not been confirmed with mooring companies (as some of these depths are considered to be deep-sea). Minesto has stated that each turbine must be spaced one cord length apart, which has given us the needed information to calculate just how many turbines can be placed in the area stated above given its varying depths. Table 3.3.2 outlines the percentage of this area that occupies each range of depth, so we assumed a mean cord length for each bucket and calculated the max number of turbines. Table 3.3.2 also shows how much of these depths have a power of 1.5 kW/m² or greater, allowing us to further refine our calculations of the minimum power generated. Table 3.3.4 below shows the number of turbines that can be placed at a given depth and current power. From these numbers we can calculate the minimum amount of power generated, which comes out to be around 210 GW.

Interactive Qualifying Project

Depth (m)	Cord Length (m)	Number of turbines possible in water of 0.5-1.5 kW/m ²	Number of turbines possible in water of 1.5+ kW/m ²
<200	100	523325	9097
200-400	300	315208	4245
400-600	500	178977	25472
600-800	700	125507	7055
800-1000	900	52248	336
1000-2000	1500	70439	121
2000+	4000	44192	398
Total:	500 Average	1309896	46724

Table 3.3.4: Maximum number of Deep Green turbines that can be placed at given depths/currents

To put this number into perspective, the United States used approximately 3,700,000,000,000 kWh in electricity for the year of 2013 (Electricity 2014). Because these ocean currents are a constant force, they will be able to provide energy year-round at a constant rate. This means that the 210GW of power provided by the turbines can generate approximately 1,800,000,000,000 kWh a year. This would account for nearly **half** of all of the United States' electricity needs. This is very obviously an important renewable energy resource, so the next question is, how much would this cost?

Interactive Qualifying Project

Unfortunately Minesto cannot disclose the cost of their turbines, as this is business-sensitive information. They have, however, said in the past that an array of two of these turbines would cost about \$2.2-2.5 million to manufacture and install.¹⁰³ We can use this number to approximate the cost of implementing this system, however there will be two main sources of error. The first will be the unusual mooring depth. Deep Green is normally moored in waters up to 120m deep, however as we can see in table 3.3.4, the average depth these would be moored at would be 500m. This is bound to cost more for additional and perhaps stronger cable, as well as the extra cost of mooring a platform at such depth. The second source of error is the discount that would be involved with buying these in bulk, since it can be assumed that buying over one million of these turbines would cost less per turbine than buying two of them. With these sources of error in mind, we will assume that the cost is (according to Minesto's statement) \$1.2 million per turbine. This means the overnight capital cost of each turbine would be about \$2400/kW. This is less than the overnight capital cost of coal plants (which can range from \$2934/kW to \$6599/kW) however is still more expensive than natural gas (ranging from \$676/kW to \$7108/kW).¹⁰⁴ When we factor in maintenance and fuel costs as well, we arrive at the cost per kWh. Deep Green can produce electricity at \$0.089/kWh, coal electricity costs \$0.0956/kWh at its cheapest, and gas costs \$0.0663/kWh at its cheapest.²⁵ This gives heavy indication that ocean current technology is economically feasible to take the place of coal power plants however would still cost more than gas.

At \$1.2 million per turbine, producing 1,356,620 turbines would cost about \$1.6 trillion for manufacturing and installation. A number such as this, however, usually has little meaning to the general tax payer. To help get perspective on this, let's look at two aspects of the United States' federal budget. The first thing we will look at is its GDP (Gross Domestic Product), which accounts for all of the money the U.S. "makes" in a year. The GDP of 2014 was about 17 trillion dollars.¹⁰⁵ This is not the actual budget of the federal government; however it is where their budget is derived from. Looking at this, \$1.6 trillion doesn't seem to be an absurd amount of money if it means providing half of all of the electricity needed for the country. However let's look at another part of the federal budget. The table below shows the amount of money in subsidies the U.S. government has given to energy production in the years of 2007 and 2010. We are only interested in the electricity subsidies of this, however the other energy subsidies are

interesting because they give us further perspective. As you can see, electricity production was only subsidized about \$12 billion in 2010, which is only 0.75% of the money needed for the turbines.

Table ES1. Value of energy subsidies by major use, FY 2007 and FY 2010 (million 2010 dollars)

Subsidy and Support Category	FY 2007	FY 2010
Electricity-Related	7,663	11,873
Fuels and Technologies Used for Electricity Production	6,582	10,902
Transmission and Distribution	1,081	971
Fuels Used Outside the Electricity Sector	6,246	10,448
Conservation, End Use and LIHEAP	3,987	14,838
Conservation	369	6,597
End-Use	1,342	3,241
LIHEAP	2,276	5,000
Total	17,895	37,160

Notes: Totals may not equal sum of components due to independent rounding.

Note that the 2007 values reported here are inflated to 2010 dollars and reflect final 2007 data estimates. The values provided in this table also represent the average of the low and high values of more detailed estimates provided in the body of the report.

Sources: Office of Management and Budget, *Analytical Perspectives*, Budget of the United States Government, Fiscal Year s 2012 and 2009. Joint Committee on Taxation, *Estimates of Federal Tax Expenditures for Fiscal Years 2010-2014*, JCS-3-10 (Washington, DC, December 2010), Table 1, and budget documents from the Departments of Energy, Agriculture, Transportation, Treasury, Health and Human Services, Housing and Urban Development, the Environmental Protection Agency and the General Services Administration.

Table 3.3.5: United States subsidies for energy in 2007 and 2010 ¹⁰⁶

3.3.5 Conclusions

In conclusion, ocean currents show huge promise as a potential renewable energy resource. The Deep Green model has shown that a minimum of 210GW be provided, and Minesto claims this energy to cost around 8-9 cents per kWh. This is highly competitive with the current average cost of electricity in the United States which is about 13 cents per kWh (note this takes into consideration all sources of electricity, including renewables like solar and wind which tend to be higher than fossil fuels). ¹⁰⁷ This could possibly provide up to half of the United States' electricity needs, however would come at a steep price to implement and does not include the cost to maintain. Further research into ocean current technology should include turbines that

Interactive Qualifying Project

work at larger depths (due to the majority of ocean being too deep to moor to efficiently), such as innovative mooring solutions or turbine design.

The California Current is not feasible for ocean current energy, as the highest speed the current flows at is about 0.5 m/s (0.125-0.25m/s on average, or 0.05-0.1 for undercurrents) ¹⁰⁸ . Not enough information could be found for the Alaska Current to qualify it either. It is said to have speeds up to 1.7 m/s, however this is only a maximum and so it is not clear what the actual average of the currents is. ¹⁰⁹

The Gulf Stream, however, is a perfectly viable source. The Gulf Stream is a considerably strong Atlantic Ocean current that travels from the tip of Florida up along the eastern coast and then branches out across the Atlantic. It has been estimated that tapping just 0.1% of the Gulf Stream's power would be able to supply a third of Florida's energy needs. ¹¹⁰ This is a valuable energy resource for one important reason: consistency. While solar and wind energy sources tend to fluctuate depending on the time of day/year and weather conditions, ocean current energy is incredibly reliable. On average, the Gulf Stream flows at around 8 billion gallons per minute. ¹¹¹ This constant flow of energy results in the capacity factors of turbines placed in it being very high. In fact, these capacity factors are usually in the range of 75 to 95 percent, nearly equivalent to the capacity factors of many fossil-fuel plants. ¹¹⁰ Of course this is assuming that these turbines are placed at the right locations (where the Gulf Stream will be consistently strong enough to reach such capacity factors). These locations are illustrated on the charts below.

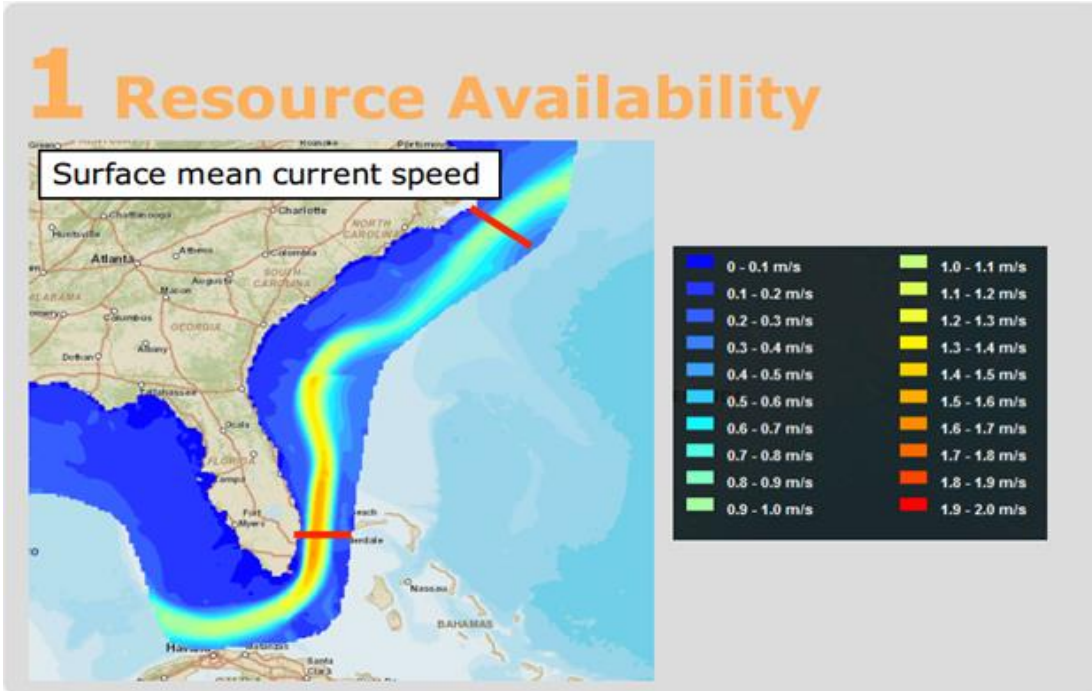

Figure 3.3.8 Illustration of Gulf Stream speeds

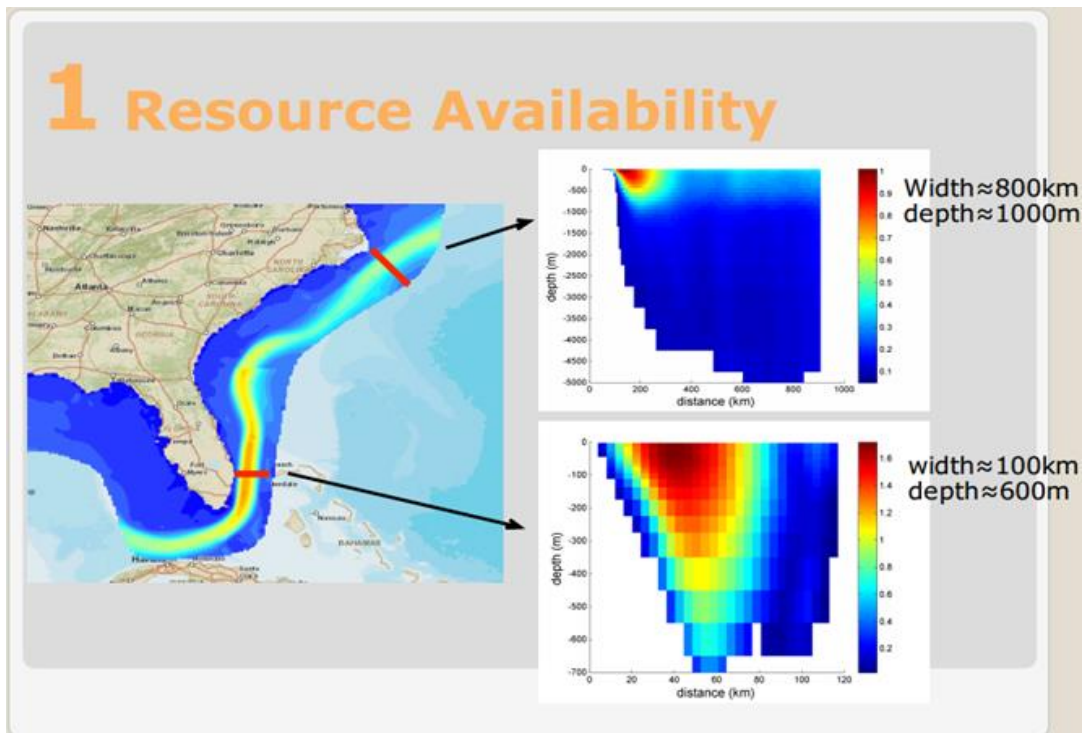

Figure 3.3.9: Illustration of Gulf Stream speeds given geographic location and depth. ¹¹²

One concern about harvesting energy from the Gulf Stream is its environmental impact. This can be broken up into two sections: the impact harvesting energy will have on the Gulf Stream's heat supply to Northern Europe and the impact placing turbines will have on marine life. The expected theoretical maximum energy dissipation from the Gulf Stream through the use of turbines is estimated to be between 20 and 60 GW, well below the Gulf Stream's total energy.¹¹² As a result, there isn't expected to be any problem with climate change given modern turbine technology. According to the Bureau of Ocean Energy Management as well, there would be "minimal environmental impact". Even the most optimistic research shows that less than one-third of the Gulf Stream's energy would be harvested.¹¹¹ How these turbines would affect marine life, however, is largely unknown. Because of this, Florida Atlantic University has been given a lease to test underwater turbines' effects on marine life. This will also act as a testing area for full-scale turbines to see their cost-effectiveness. FAU has also offered their testing site to private companies for field testing their own models, such as Deep Green. Testing for the impact on marine life is important for many reasons, one of which is the large number of endangered species found in the Gulf Stream. For example, 16 populations of sea turtles found off of Florida's coast are endangered.¹¹¹ Additionally there is concern for what is called a "Cuisinart effect". This is when a number of aquatic animals go near a turbine (out of curiosity or otherwise) and end up being chopped up by their rotors. The remains of these animals could then attract larger animals to feed off them, which then in turn get killed by the rotors.¹¹¹ This process could eventually cause a major problem for underwater life in the Gulf Stream. It is therefore a priority to research how ocean current turbines can affect marine life before implementing them full-scale.

3.4 Social implication

Tidal range power generation is dominated by two large plants in operation, the 'La Rance' barrage in France and the 'Sihwa dam' in South Korea. The construction costs for 'La Rance' were around USD 340 per kilowatt (/kW) (2012 value; commissioned in 1966), whilst the Sihwa barrage was constructed for USD 117/kW in 2011. The latter used an existing dam for the construction of the power generation technology. The construction cost estimates for proposed tidal barrages range between USD 150/kW in Asia to around USD 800/kW in the UK, but are very site specific. Electricity production costs for 'La Rance' and 'Sihwa Dam' are EUR

0.04 per kilowatt-hour (/kWh) and EUR 0.02/kWh, however these costs are very site specific. Tidal range technologies can be used for coastal protection or water management, which would reduce the upfront costs. On the other hand, additional operational costs may occur due to the control, monitoring and management of the ecological status within the impoundment.

Tidal current technologies are still in the demonstration stage, so cost estimates are projected to decrease with deployment. Estimates from across a number of European studies for 2020 for current tidal technologies are between EUR 0.17/kWh and EUR 0.23/kWh, although current demonstration projects suggest the level listed cost of energy (LCOE) to be in the range of EUR 0.25-0.47/kWh. It is important to note that costs should not be considered as a single performance indicator for tidal energy. For example, the costs for both tidal range and tidal stream technologies can fall by up to 40% in cases where they are combined and integrated in the design and construction of existing or new infrastructure.

Tidal range energy has already been commercially applied since the late 1960s in Canada, China and France, and most recently in South Korea. With regard to the tidal range, the upfront costs associated with installation are high, however, they hold good pay-back properties over the longer term. Many of the installations from the 1960s and 1970s are still operational without many problems.

There is, however, little economic data available. This is partly due to the fact that the cost are very site specific. The two main cost factors are: the size of the barrage (length and height) determining the capital costs, and the difference in height between high and low tide determining the electricity production. Some estimates taken from web based sources, for the largest and oldest tidal range installation in La Rance, indicate that costs range from EUR 0.04 to EUR 0.09-0.12/kWh. ¹¹³ The Sihwa power plant in South Korea, is the largest tidal range installation in the world, is estimated to have cost around USD 300 million and produce electricity for USD 0.024/kWh. ¹¹³

Table 1 - Estimated construction costs for existing and proposed tidal barrages.

Barrage	Country	Capacity (MW)	Power generation (GWh)	Construction costs (million USD)	Construction costs per kW (USD/kW)
Operating					
La Rance	France	240	540	817	340
Sihwa Lake	Korea	254	552	298	117
Proposed/planned					
Gulf of Kutch	India	50	100	162	324
Wyre barrage	UK	61.4	131	328	534
Gerorim Bay	Korea	520	950	800	154
Mersey barrage	UK	700	1340	5741	820
Incheon	Korea	1320	2410	3772	285
Dalupiri Blue	Philippines	2200	4000	5054	138
Severn barrage	UK	8640	15600	36085	418
Penzhina Bay	Russia	87000	200000	528000	377

Note: ^a Cost equivalent for 2012
Based on Wyre Energy Ltd., 2013.

Table 3.3.1: Estimated construction costs for existing and proposed tidal barrages.

The construction costs, however, do not necessarily need to be assigned to power production. In the case of La Rance, the construction also functions as a highway, reducing travel distance by 30 km for up to 60 000 vehicles per day.⁹³ Similarly, the Sihwa lake tidal barrage is constructed on top of an existing dam.

Besides the upfront costs, other considerable costs may be the control, monitoring and management of the ecological status within the impoundment. The costs for both tidal range and tidal stream technologies can fall up to 40% in the case where construction is combined and integrated in the design and realization of new infrastructure (e.g., sea defense, water quality measures or roads) as was noted from the study undertaken by the Norwegian Ministry of Road Administration (2012). Additionally, such an integrated approach that combines the planning and realization of coastal defenses and bridges with the realization of tidal energy installations can greatly reduce the maintenance and operation costs of devices. The development of commercial arrays of tidal current technologies is still in the demonstration phase, so liveliest costs of electricity (LCOE) are in the range of EUR 0.25-0.47/kWh with the lower range LCOE estimates

Interactive Qualifying Project

based on high capacity factors and low capital cost estimates. ¹¹⁴ The Carbon Trust indicates that the highest current costs, are related to installation (35%), the structure (15%), and maintenance and operation (15%), with installation costs varying greatly according to the location. ¹¹⁵

Costs are projected to come down with deployment levels and resource quality as the important determinants. Furthermore, technology developers are working hard to increase the capacity factor of arrays from around 25% to 40% and availability factor from 70% to 90% by 2020 (ETI/UKERC, 2014). If deployment is in the order of 200 MW by 2020, SI Ocean estimates an LCOE with a central range of EUR 0.21-0.25/kWh. ¹¹⁴ These estimates are similar to a study by the Carbon Trust, which estimated that the costs for tidal current devices will be around EUR 0.17-0.23/kWh in 2020 ¹¹⁵. Deployment in high or low quality resource area can increase this range to EUR 0.16-0.30/kWh (SI Ocean, 2013a). Scaling up to around 2-4 GW – assumed to be possible by 2030 – could bring LCOE below EUR 0.20/kWh ^{114,115}

Cost Comparison Summary

Technology	Costs in cents per delivered Killowatt Hour				Estimates shown with question mark?		
	Capital Cost	Capacity Factor	O&M Cost	Fuel Cost	Direct Costs	Indirect Social Costs	Total Costs
Coal	0.72	95%	1	2.14	3.14	6.43	10.29
Nuclear	0.9	95%	1.4	0.76	2.16	0.25	3.31
Natural Gas	0.42	95%	0.5	4.9	4.95	2.27	8.09
Solar	17.12	15 - 20%	1	none	18.12	not quantified	18.12
Wind	2.45	25 - 35%	1	none	3.14	not quantified New England	3.45 6 - 7
Tidal Barrage / Low Dam	7 - 10?	12 - 18%?	1?	none	8 - 11?	not quantified	8 - 11?
Free-Flow Current	5 - 8?	30 - 50%	2?	none	7 - 10	not quantified	7 - 10
Tidal Fence	6 - 9?	35 - 40%	2?	none	8 - 11?	not quantified	8 - 11?
Submerged Array	5 - 7?	40 - 60%?	1.5?	none	6.5 - 8.5?	not quantified	6.5 - 8.5?

10

Table 3.5.2: Cost Comparison Summary ¹³⁹

Tidal power plant could have significant impact to the local community such as Severn tidal power plant. The overall benefit to the regional economies of the South West of England and Wales of a Severn tidal power scheme is estimated to be positive in terms of gross value added (GVA) and employment. GVA measures the contribution of an industry, sector or people to the economy – in this case the GVA relates to the benefits and costs to regional economies from a Severn tidal power scheme. It is difficult to predict exactly what would happen so a number of possible outcomes have been tested which are reflected in the ranges around the figures presented. These represent best and worst case scenarios around a central estimate. The figure below shows the impact each scheme would have on GVA in low, central and high scenarios.

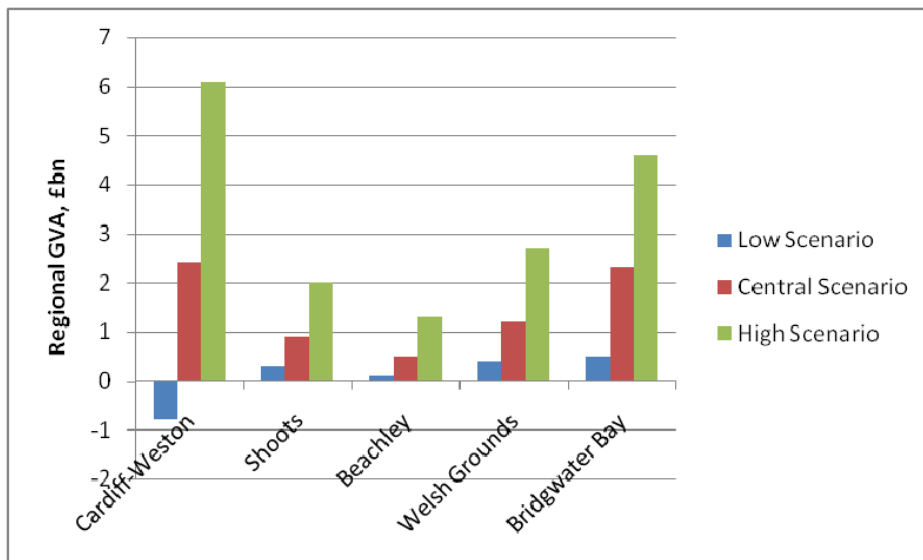

Figure 10: Regional Net Gross Value Added for South West of England and Wales (£ billion) across high, central and low scenarios for each scheme

Figure 3.5.1: Regional Net Gross Value Added for South West of England and Wales (£ billion) across high, central and low scenarios for each scheme ¹¹⁶

A major source of value to the regional economy would be the several thousand jobs created in construction and support services, of which some (between 20-40%) will be taken up by those living in the region. A supply chain study (published alongside this report) has informed what adjustments should be made to these figures to provide an estimate of how many of those

Interactive Qualifying Project

jobs would be realized in Wales and the South West of England. Results show that an annual average of 3,000 additional construction and associated services jobs would be created in these areas (with a range of 2,000 to 7,000) as a result of a Cardiff-Weston scheme. The difference in gross and regional job figures reflects the expectation that given there is no UK hydro-manufacturing facility, turbines are likely to be sourced from world-wide manufacturers.

	Cardiff-Weston	Shoots	Beachley	Bridgwater Bay	Welsh Grounds
Construction Period	9 years	5 years	4 years	6 years	6 years
Gross construction phase jobs created	15,500 (12,000 – 38,000)	5,500 (3,000 – 12,000)	4,500 (3,000 – 11,000)	13,000 (7,000 – 30,000)	6,500 (3,000 – 15,000)
Regional construction phase jobs created	3,000 (2,000 – 7,000)	1,500 (1,000 – 4,000)	1,000 (1,000 – 2,000)	3,500 (2,000 – 7,000)	2,000 (1,000 – 5,000)
Regional operational phase jobs created	1,000 (500 – 1,500)	200 (100 – 250)	100 (50 – 150)	450 (250 – 700)	200 (100 – 250)

Table 5 : Summary of regional jobs created for each scheme, central scenario (high and low scenarios in brackets)

Table 3.5.3: Summary of regional jobs created for each scheme, central scenario ¹¹⁶

Maintaining and operating schemes would also generate regional employment. For the largest barrage this is centrally estimated as 1,000 annual average jobs created in the South West of England and Wales (with a range of 500 – 1500) and 100 (with a range of 50-150) for Beachley, figures for the other schemes are presented in table 5. Although not quantified, there are also likely to be further regional employment opportunities through tourism and consequential development that a scheme might attract.

However, the benefits described above must be balanced against potential job losses in the region that would result from the impact schemes would have on the Severn estuary and the businesses that use it. These include the estuary’s ports, aggregate extraction and commercial

fisheries, also existing tourism around the Severn Bore may be impacted. The ports in the Severn estuary handle a significant proportion of UK trade and support a large number of regional jobs. This sector, and in particular the ports at Bristol, Cardiff, Newport and Sharpness might be significantly affected by a tidal power scheme. Barrage options have the greatest impact on ports upstream of them as port traffic would be required to pass through locks to access port facilities. Changed water levels as a result of schemes, including the Bridgewater Bay lagoon, would also affect the access opportunities for vessels.

For the ports a scheme could therefore mean:

- Longer timescales for ships to reach them if they have to pass through locks.
- Fewer opportunities for vessels to travel up the estuary as the higher tides that the larger ships need to reach the ports are reduced.
- Sediment may collect in navigation channels which would need to be regularly dredged.
- Potentially greater impacts on larger ships which bring the most value to the ports.

Provision of locks and dredging would reduce the impact of the schemes on ports. These have been included in scheme design and costs. For example, the inclusion of a lock and dredging navigation channels for the Cardiff-Weston scheme is around £2.4 billion (excluding optimism bias) and for a smaller scheme like the Shoots barrage £220 million (excluding optimism bias). Although locks and dredging would largely mitigate the navigational impacts presented by barrages, port customers may still consider possible delays as a risk, thus potentially impacting on the competitiveness of the ports.

In a scenario where a power scheme displaced 60% of port activity, job losses at the ports in the Severn estuary could rise to a peak of 3,900 during the nine year construction period for Cardiff-Weston. This means that in a typical construction year port-associated employment could be 2,100 (1,400 – 3,500) lower than it would otherwise have been (ranges represent 40% and 100% displacement). For a Bridgewater Bay lagoon displacement is assumed to be lower and average losses are centrally estimated to be 200 (0 – 1000) and for the other schemes 200 (0 – 400).

Interactive Qualifying Project

The Bristol Port Company (BPC) have recently been granted consent for a major new DeepSea Container Terminal Development (a £600 million investment). If these expansion plans are realized the figures on benefits and jobs for Cardiff-Weston are likely to change. We estimate that the net benefit to the region is reduced to £1.9bn (£-1.5bn - £5.5bn) GVA for a Cardiff-Weston barrage since job losses during the construction period are estimated to be 2,500 (1,600 – 4,100).

The marine aggregates industry is another important commercial activity in the Severn estuary supporting around 1,100 regional jobs. Like the ports this sector would be affected by the impact of schemes on water levels, how sediment is moved and deposited and the necessity to pass through locks. The Welsh Grounds lagoon and Cardiff-Weston barrage would affect access to currently licensed areas and access to landing ports could result in annual average employment being 90 and 180 (respectively) lower than it would have otherwise been.

Commercial and other employment generating fishing and angling in the estuary and surrounding rivers within the study area are estimated to support around 100 jobs. Any tidal power scheme has the potential to significantly disrupt both nursery areas and the passage of fish up the estuary which for some species may lead to the collapse of the associated fisheries. For all schemes around 60 fisheries jobs are expected to be lost. The impact that a development might have on offshore fisheries is un-quantified. The figure below shows the net job impact on the region²³ taking into account both jobs created in the construction sector and those that could be lost in the ports, aggregates and fisheries sectors for low, central and high scenarios. ²³ Note that the net job impacts for the UK economy as a whole are uncertain because, for example, jobs created in one region could displace jobs in another region.

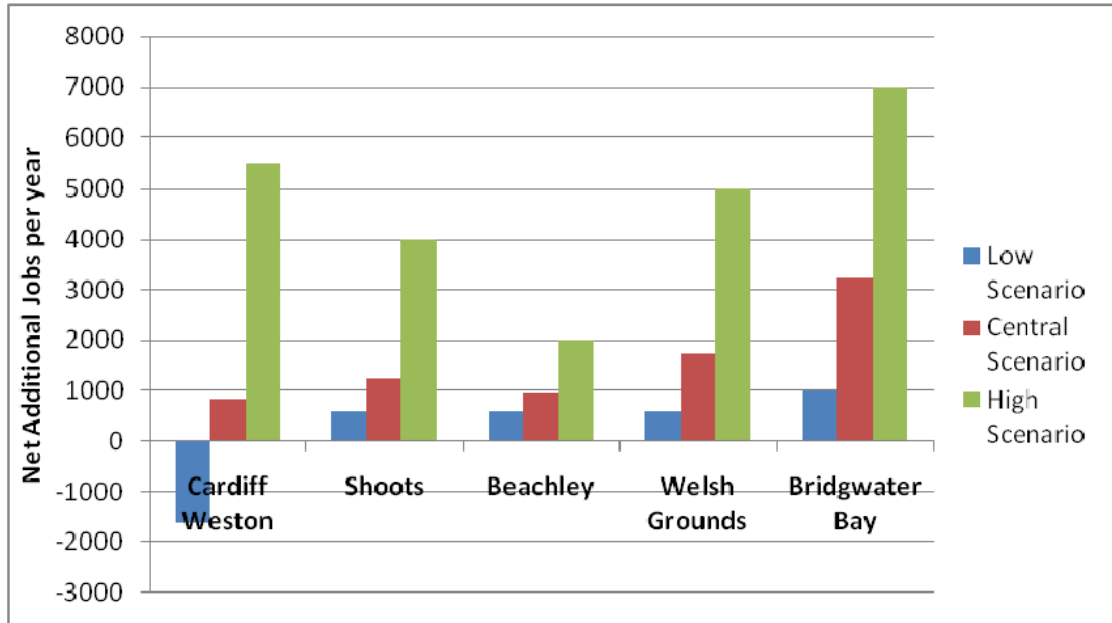

Figure 11: Net jobs per scheme for the construction phase realised in the region (low, central and high scenarios)

Figure 3.5.2: Net jobs per scheme for the construction phase realized in the region ¹¹⁶

More detail on the employment and GVA impacts can be found in the Regional Economic Impacts Study which follows on from a study by DTZ commissioned early in the feasibility study and which was subsequently peer reviewed. Infrastructure and services

The SEA has considered how schemes could affect other activities and the people that live around the Severn estuary and particularly those close to the possible scheme landfall points. Any of the schemes would change the estuary landscape both as a result of the structure itself and the consequential impacts on the environment such as water levels. It is possible however that any structure could become an accepted, and appreciated, part of the landscape/seascape – like the second Severn crossing or the La Rance barrage in France. There would be an increase in heavy goods vehicle traffic during the construction phase of all schemes despite the large quantities of materials required to build schemes being brought to site on ships or via the rail network. The Highways Agency agrees with the study’s conclusion that this would not have a significant effect on the motorways and main roads in the South West of England but has flagged possible impacts on smaller local roads. Impacts on local road traffic congestion, noise and air

quality would be managed through transport planning and consultation with local authorities and community groups.

In-migration of population is expected as a result of all schemes as some incoming temporary construction workers are likely to settle in the area with their families. This is not expected to have a significant effect on the population characteristics, the housing market or access to facilities and services in those areas as the numbers are low compared to the existing population. For a Cardiff-Weston barrage, which as the largest scheme would have the largest impact; the number of people anticipated to settle in the region from both construction Page 36 of 75 and operation would be less than 0.5% of the current population – which is estimated to be 2.2 million in 2017.

All of the schemes have the potential to have both a positive and negative influence on sustainable estuary based tourism through a reduced sediment supply to sandy pleasure beaches as well as increasing mud deposition at these sites. The extent of this effect is likely to be greatest for a Cardiff-Weston barrage, with beaches located along the Bristol Channel coastline potentially at risk. Effects to pleasure beaches such as Brean from the remaining schemes are considered to be less and are largely restricted to those sites in the Severn estuary and Bridgwater Bay. Any reduction in beach sediment supply could be countered through a coordinated program of beach replenishment although this has not been quantified. All three barrage schemes are likely to prevent the formation of a ‘surfable’ Severn Bore. All schemes are expected to provide an opportunity for development within the local area.

Barrage schemes would result in calmed water conditions upstream of the structure and, for lagoon schemes, within the lagoon itself. The resulting increased potential for water-based recreation could benefit the 30 boat clubs (with a membership of around 9,000) around the estuary and increase the wider tourism potential of the estuary.

The Severn estuary and Bristol Channel are important for marine waste disposal. The estuary contains a number of waste disposal sites, a large number of sewage and industrial discharges are made using the dilution and dispersion driven by the high tidal range and a number of power stations (Hinkley, Oldbury, Uskmouth and Aberthaw) abstract and discharge

cooling water. All options would disrupt this activity to varying degrees and may require a reassessment of the current consents to discharge.

Also take the Swansea tidal lagoon as an example since it has a significant effect to Walsh’s economy:

The first tidal lagoon to be built in the UK will be located at Swansea Bay and will involve an investment of £1,046 million (2014 prices). Close to half of this investment will be retained within the Welsh economy with Wales-based companies heavily involved in construction of the lagoon. This is expected to have a significant impact on the Wales economy – which can be measured using a regional input-output model. This section specifically focusses on the economic benefits of the construction and operation of the Swansea Bay lagoon on GVA and employment within the Welsh economy.

It is estimated that the overall impact on annual Welsh GVA from construction of Swansea Bay tidal lagoon could amount to £316 million during the construction program. This would result in an estimated boost to Welsh GVA ranging from 0.02% to 0.23% over the construction period. The construction program will also generate significant number of jobs in Wales, not just in employment on site but also from purchases of goods and services from Welsh based companies. This will amount to approximately 1,900 jobs at the height of the construction programmer. A summary of construction GVA and employment impact from the Swansea Bay lagoon on the Welsh economy are presented in Table 3.3.4.

Table 11: Summary of GVA and employment impacts of construction of Swansea Bay tidal lagoon on the Welsh economy, 2014 prices

Metric	Unit	2015	2016	2017	2018	Total
GVA	£m	9	124	84	99	316
Employment	Jobs (FTE)	191	1,922	1,305	1,584	
% Contribution to Welsh GVA	£m	0.02%	0.21%	0.14%	0.17%	

Source: Cebr analysis

Table 3.5.4: GVA and employment impacts during lagoon operation ¹⁰²

Interactive Qualifying Project

It is estimated that the annual overall impact on Welsh GVA of the Swansea Bay tidal lagoon during operation could amount to approximately £76 million per year (2014 prices) over the 120 year design lifespan of the power station. This would result in an estimated annual boost to Welsh GVA of 0.14%. Annual operation of the tidal lagoon will also generate direct, indirect and induced jobs for the Welsh economy. This would amount to approximately 181 full-time equivalent (FTE) jobs each year. A summary of construction GVA and employment impact from operation of the Swansea Bay lagoon on the Welsh economy are presented in Table 12.

Table 12: Summary of GVA and employment impacts from operation of the Swansea Bay tidal lagoon on the Welsh economy, 2014 prices

Metric		2020
Employment	Jobs (FTE)	181
GVA	£m	76
% Contribution to Welsh GVA	% of Welsh GVA	0.14%

Source: Cebr analysis

Table 3.5.5: Summary of GVA and employment impacts ¹⁰²

It is understood that the ecological purity of a TPP is relative, since its construction and operation, like any of human intrusions in nature, could not remain without repercussions. TPP are distinguished, however, by the fact that these repercussions are minimal as compared with other types of power plants. Moreover they also have positive sides: the creation of favorable recreational conditions; protection of shorelines from wave action; reduction in the turbulence of the water masses and their purification, which is favorable to flora and fauna. The floating method of construction carried out at the Kislaya Guba TPP makes it possible to transfer basic work associated with construction of TPP from an uninhabited region of a readily injured nature to an existing coastal industrialized center, avoid the destructive cessation of water exchange between the basin and sea during construction, while the model for use of a single-basin tidal plant, which has been developed in Russia and gained world-wide recognition, does not disturb the natural rhythm of power generation. All presently known impacts of a TPP on the environment may be generally summed up as follows:

Interactive Qualifying Project

- 1- Construction of the TPP barrage brings about an inevitable attenuation of the natural water exchange between the bay and the seas by 5÷75% depending on the types of models and regimes.
- 2- Distribution of water velocities in the bay area and seawards of the barrage is changed since the water motion after the bay enclosure occurs only through the water conduits. Because of this, high velocities will be maintained in the area adjacent to the central part of the barrage (the power house), while on the flanks of the water-retaining barrage a substantial decrease in water velocities occurs.
- 3- Attenuation of the water exchange and the alternation in overall hydrodynamic pattern result in the re-distribution of bottom deposits within a wide coastal zone of the bay - just those water area zones that are richest in bottom fauna and flora.
- 4- Restructuring of sediment deposits from conductive to alteration of the major part of the bay ecosystems. The duration of the alteration process is some 10 years. The ecosystems' ability for self-renewal after this period is completely dependent on the TPP operation and this needs to be considered while analyzing the possible impacts of any TPP on the environment.
- 5- Attenuation of water exchange between the TPP basin and the sea enhances the dependence of the water area separated from the sea on the terrestrial processes (fresh water run-off, heat exchange etc.) and reduces its stability. Principally this can result in a certain desalinization of the water body in the process of spring ice melting and in the periods of heavy rainfall in the summer.
- 6- The experience gained during operation of the Rance TPP shows that as the result of attenuation of wave action and decrease of water turbidity in the TPP basin, mariculture can be successfully developed in the basin. Some ecosystems proved to be richer than before the TPP construction and compared with neighboring estuaries. In addition the protection of the TPP basin against storms favors navigation, aquatic sports and tourism.

Interactive Qualifying Project

- 7- One further consequence of the decrease of water exchange and utilization of a portion of the tide energy is the decrease of the tidal range in the basin; this results in lowering of the tidal level, i.e. degeneration of the exposed zone upper part into a terrestrial biotope.
- 8- Lowering of the upper level of the tide can in turn bring about a change of the ground water level in the lowland territories immediately adjacent to the basin of the future TPP. Under certain conditions this can be detrimental for the vegetation and the ecosystem of marshes.
- 9- The barrage stands in the way of anadromous fish migration. Some of the migrating adult fishes can be injured while passing through the turbines ¹¹⁷ .

Chapter 4: Conclusion

4.1 Conclusion

Over the decades we have seen the stubbornness of people staying in the same “safe” energy sources such as coal, gas, and oil. These high energy density, non-renewable sources have started reaching the end of their reserves, causing many deaths and environmental pollution over the years. This notion has gradually led more and more people to invest time and money into renewable energy resources such as solar, wind and tidal energy. The issue associated with these sources is their high initial costs and their low energy densities. This implies that a good amount of effort is required for an affordable production of energy. Although fossil fuels cause pollution and have an end date, people vouch for them due to their consistency. They know that they can produce valuable energy at any point in time.

In contrast, most renewable energy sources are not consistent; solar energy can be produced solely during the day when it’s not cloudy, wind energy can be produced only when there are strong wind currents, and so on. For this exact reason we recommend that a transition from fossil fuels to fully renewable energy sources will be attained only by the proposal of an energy basket which will include a variety of renewable energies. The two most prevalent and, in contrast to most renewable energies consistent, are jet streams and tidal energies. These sources are already in use, however just barely. It is our hope that they will be large contributors to the world’s future energy basket, and that our transition to them begins as soon as possible.

Current, tidal, and jet stream energy appear to be highly appealing for the world’s future energy needs. Current and tidal already have commercial applications under way while high-altitude wind farms are currently in testing. While these tests are very promising, suggesting that there is more than enough energy available in jet streams to supply the world’s electricity needs at prices competitive with the cost of electricity now, the technology still requires time to mature. Current and tidal operations have already proven they can provide renewable electricity at competitive prices, however it is not without problems.

Undersea generators are notoriously troublesome when it comes to repairs. This is due to their requirement tethered/attached to the ocean floor in some way and operating at depths below

Interactive Qualifying Project

modern marine vessels (though not always exclusively at these depths). There are a few models that can resurface remotely, allowing for quick maintenance and possibly even deployment. These however are still in testing so it is uncertain what we can expect from them. The ocean is a harsh environment for technology to survive in; between constant abrasion and occasional storms, many generators have a lifespan of less than 20 years. This, combined with the severe operating depths, can also cause cleanup to be a problem when necessary. As the world has seen with the Pacific garbage patch and BP's oil spill, cleaning the ocean once it is soiled is a near impossible task. Should underwater turbine farms be implemented on a massive scale world-wide, debris within the ocean could also scale with them. This is a lesser concern when compared with the world's treatment of the ocean (in regards to garbage and other debris), however still a valid one. A larger concern is the effect that these turbines will have on tidal/current-dependent climates. An example of this is the possible consequence extracting energy from the Gulf Stream could have on Western Europe, which receives a large amount of energy from the Gulf Stream's current. These effects are completely unknown, and therefore any serious extraction of energy from the ocean will have to be monitored for possible side-effects. Finally, the effect these turbines could have on marine life is little, but still very real, as seen with the Cuisinart effect. It can be minimized by studying the behavior of marine life around given turbines as well as minimizing base platform sizes.

Turbines capable of reaching the jet stream also come with problems. Namely, if a given model cannot be extended high enough, the jet stream becomes far less constant and therefore the energy supply would be less reliable. Jet stream turbines are also considerably less efficient than tidal/current turbines, often less than half. This, again, means that these turbines will be more volatile in terms of their ability to produce a consistent source of electricity. These also have the problem of effecting aerial life, however not in the way that traditional wind farms do. These will be too tall to directly interfere with birds, however it is unclear how they will affect the jet stream. Because of this, underlying wind currents could be affected as well and, as a result, the migratory patterns of birds could be in danger. In addition to birds being affected, these changes to the jet stream could cause unpredictable changes to temperature/airflow of surrounding regions.

Interactive Qualifying Project

Given the problems stated above, and the current state of technology, current and tidal energy appears to be a more viable energy source. This, however, could very easily change in the near future as jet stream turbines go commercial. Even considering all of these difficulties, however, both sources of energy are highly appealing. Their environmental effects would be insignificant compared to the fossil fuels they would replace, and the potential each of them holds is enough to supply the world with affordable energy for the foreseeable future. Unfortunately many technological advances will need to be made to make extracting a large amount of this energy feasible, as currently the majority of energy is not affordable to extract. Still, the energy that is attainable from these two sources is affordable, reliable, and clean.

4.2 Recommendation for future IQP

Our recommendations for future IQP research is: first to explore other renewable energy sources that we were not able to cover in detail such as geothermal, hydrogen, etcetera. All of these sources have the potential to contribute to the world's energy basket and also have their own limitation. Some sources may be easy to obtain but have a relatively low efficiency and others may provide a significant amount of energy but have some major impact to the local environment. We suggest that future IQP groups focus on other sources and research their pros and cons, further exploring what resources would be reasonable for future energy needs.

Second we think that the future IQP groups could focus on some new technologies for extracting traditional fossil fuels, such as fracking. Due to the development of these new technologies, the oil supply is surging and thus the price for oil lowering. With more supply and lower price, the traditional sources will keep their dominant position in the energy basket. This will have a huge impact on the development of renewable sources. In fact, due to the oil price drop by the time this report was completed, some research on renewable energy has been suspended. We suggest more effort be put into finding out how these new technologies will affect the energy supply. Additionally, while we do not wish to extend our dependency on fossil fuels, we would still like to recommend future students to investigate alternative ways of extracting these fuels. This is because of the extreme environmental impact current methods (such as fracking) have, which we need to put an end to one way or another.

Interactive Qualifying Project

Last but not the least we recommend students pay more attention to the social impact of individual energy sources. In other words, future research should focus more on economic effects/climate both locally and globally, as well as environmental effects when researching energy sources. Questions like why a specific energy source will be practical and how it will change the local and global community are just as important as what kind of technology we will use to attain it.

We sincerely hope that future IQP groups doing this topic will get a more expansive picture of energy supplies and provide some insight into new energy sources, giving a new perspective of future renewable energy sources.

4.3 References

- 1) NaturalGas.org. Retrieved September 9, 2014, from <http://naturalgas.org/overview/resources/>
- 2) Ehrlich, Robert. *Renewable Energy A First Course*. Boca Raton: Taylor & Francis Group, 2013. Print.
- 3) Farmdocdaily: The Truly Amazing Continuing Story of Natural Gas Prices.. Retrieved September 10, 2014, from http://www.farmdocdaily.illinois.edu/2012/02/the_truly_amazing_continuing_s.html
- 4) EIA Gas US reserves. Retrieved September 10, 2014, from <http://www.eia.gov/tools/faqs/faq.cfm?id=58&t=8>)
- 5) Retrieved September 10, 2014, from http://www1.eere.energy.gov/wip/solutioncenter/pdfs/nclsl_property_tax_financing_legis_brief.pdf)
- 6) World Energy Consumption Facts, Figures, and Shockers. (n.d.). Retrieved September 15, 2014, from <http://www.energytrendsinsider.com/2012/06/28/world-energy-consumption-facts-figures-and-shockers/>
- 7) Retrieved September 14/ 2014 From: [http://epp.eurostat.ec.europa.eu/statistics_explained/index.php/File:Gross_inland_consumption,_EU-28,_1990%E2%80%932012_\(%25_of_total_consumption\)_YB14.png](http://epp.eurostat.ec.europa.eu/statistics_explained/index.php/File:Gross_inland_consumption,_EU-28,_1990%E2%80%932012_(%25_of_total_consumption)_YB14.png)
- 8) Europe Faces Tough Choices Over Natural gas. (n.d.). Retrieved September 15, 2014, from <http://oilprice.com/Energy/Natural-Gas/Europe-Faces-Tough-Choices-Over-Natural-Gas.html>
- 9) RealClearEnergy - Russia Still Has Most Gas, U.S. Second, China Third. (n.d.). Retrieved September 14, 2014, from http://www.realclearenergy.org/charticles/2012/06/04/russia_still_has_most_gas_us_second_china_third_106582.html

Interactive Qualifying Project

- 10) U.S. Energy Information Administration - EIA - Independent Statistics and Analysis. (n.d.). Retrieved September 15, 2014, from <http://www.eia.gov/countries/cab.cfm?fips=rs>
- 11) Oil Peak. Retrieved September 15, 2014, from <http://www.endofcrudeoil.com/2011/04/widening-europe-diesel-deficit.html>
- 12) Retrieved September 15, 2014, from <http://www.endofcrudeoil.com/2011/04/widening-europe-diesel-deficit.html>
- 13) EIA: Retrieved September 23, 2014, from <http://www.eia.gov/todayinenergy/detail.cfm?id=14691>
- 14) Yardeni, Edward, and Debbie Johnson. "Energy Briefing: Global Crude Oil Demand & Supply." *Yardeni*. Yardeni Research, 2 Sept. 2014. Web. 3 Sept. 2014. <http://www.yardeni.com/pub/globdemsup.pdf>.
- 15) Zabel, Graham. "Peak People: The Interrelationship between Population Growth and Energy Resources." *Resilience*. Energy Bulletin, 20 Apr. 2009. Web. 3 Sept. 2014. <http://www.resilience.org/stories/2009-04-20/peak-people-interrelationship-between-population-growth-and-energy-resources>.
- 16) "Supply Shock from North American Oil Rippling through Global Markets." *Iea*. International Energy Agency, 14 May 2013. Web. 3 Sept. 2014. <http://www.iea.org/newsroomandevents/pressreleases/2013/may/name,38080,en.html>
- 17) "Fossil." *Energy.gov*. Department Of Energy, 2014. Web. 3 Sep. 2014. <http://energy.gov/science-innovation/energy-sources/fossil>.
- 18) Walsh, Bryan. "The IEA Says Peak Oil Is Dead. That's Bad News for Climate Policy." *Time* 15 May 2013. Print.
- 19) World Coal Association's Coal Facts 2013. (2013, January 1). Retrieved October 1, 2014.
- 20) Retrieved 09/16/14 from <http://astarmathsandphysics.com/ib-physics-notes/energy/ib-physics-notes-the-roles-of-the-moderator-control-rods-and-heat-exchanger-in-a-nuclear-reactor.html>
- 21) Helium-3. (2010.). Retrieved February 15, 2015, from <http://en.wikipedia.org/wiki/Helium-3>
- 22) File:Fusion rxnrate.svg. (2009, August 1). Retrieved February 15, 2015, from http://commons.wikimedia.org/wiki/File:Fusion_rxnrate.svg

Interactive Qualifying Project

- 23) Shea, D., & Morgan, D. (2010, October 1). The Helium-3 Shortage: Supply, Demand, and Options for Congress. Retrieved from www.crs.gov
- 24) Solar - Energy Explained, Your Guide To Understanding Energy - Energy Information Administration. (n.d.). Retrieved February 15, 2015, from http://www.eia.gov/energyexplained/index.cfm?page=solar_home
- 25) Annual Energy Outlook 2014 (2014, May 7). Retrieved December 5, 2014, from http://www.eia.gov/forecasts/aeo/electricity_generation.cfm
- 26) The SunShot photovoltaic (PV) technologies. (n.d.). Retrieved February 15, 2015, from <http://energy.gov/eere/sunshot/photovoltaics>
- 27) Bullis, Kevin. "Algae-Based Fuels Set to Bloom." *MIT Technology Review* (2007). Web. Bullis, K. Cheap Hydrogen from Sunlight and Water. Retrieved February 15, 2015, from <http://www.technologyreview.com/news/521671/cheap-hydrogen-from-sunlight-and-water/>
- 28) Biello, D. (n.d.). How to Use Solar Energy at Night. Retrieved February 15, 2015, from <http://www.scientificamerican.com/article/how-to-use-solar-energy-at-night/>
- 29) Biodiesel Basics - Biodiesel.org. (n.d.). Retrieved September 10, 2014, from <http://www.biodiesel.org/what-is-biodiesel/biodiesel-basics>
- 30) Biodiesel. (n.d.). Retrieved September 10, 2014, from <http://www.cyberlipid.org/glycer/biodiesel.htm>
- 31) Retrieved 09/16/14 Biodiesel in block Retrieved February 20, 2015, from http://www.biodiesel.org/pdf_files/Production.PDF
- 32) "Arbor Biofuels | Biodiesel." *Arbor Biofuels | Vancouver, WA Biofuel*. N.p., n.d. 9.Sepr. 2012 <<http://www.arborbiofuels.com/Biodiesel.html>>.
- 33) Retrieved September 25, 2014, from <http://www.mnn.com/green-tech/transportation/questions/do-you-have-to-modify-a-diesel-engine-to-run-it-on-vegetable-oil>
- 34) Guyomard Hervé, Forslund Agneta and Dronne Yves. Chapter 7. Retrieved September 16, 2014, from <http://www.intechopen.com/books/economic-effects-of-biofuel-production/biofuels-and-world-agricultural-markets-outlook-for-2020-and-2050>

Interactive Qualifying Project

- 35) [C. Carraretto](#), [A. Macor](#), [A. Mirandola](#), [A. Stoppato](#), [S. Tonon](#) Efficiency, Costs, Optimization, Simulation and Environmental Impact of Energy Systems. Retrieved September 25, 2014, from <http://www.sciencedirect.com/science/article/pii/S0360544204001215>
- 36) Energy Conversion and Management. [Recep Altına](#), [Selim Çetinkayab](#), [Hüseyin Serdar Yücesuc](#) Retrieved September 25, 2014, from <http://www.sciencedirect.com/science/article/pii/S0196890400000807>
- 37) Energy Conversion and Management. [Recep Altına](#), [Selim Çetinkayab](#), [Hüseyin Serdar Yücesuc](#) Retrieved September 25, 2014, from <http://www.sciencedirect.com/science/article/pii/S0196890400000807>
- 38) Algae Production Systems. (n.d.). Retrieved September 26, 2014.
- 39) Comprehensive Oilgae Report. (2013, January 1). Retrieved December 1, 2014, from www.oilgae.com
- 40) Current and Projected Costs for Biofuels from Algae and Pyrolysis. (n.d.). Retrieved February 16, 2015, from <http://www.energytrendsinsider.com/2012/05/07/current-and-projected-costs-for-biofuels-from-algae-and-pyrolysis/>
- 41) Clean Cities Alternative Fuel Price Report. (2014, July 1). Retrieved December 1, 2014.
- 42) Investing in Algae Biofuel. Retrieved September 15, 2014, from <http://www.greenchipstocks.com/articles/investing-algae-biofuel/253>
- 43) Hodge, Nick. "Investing in Algae Biofuel." *Green Chip Stocks*. 1 July 2008. Web. 26 Sept. 2014.
- 44) Hemaiswarya, S., Rathinam Raja, Isabel Carvalho, R. Ravikumar, Vasudeo Zambare, and Debmalya Barh. "An Indian Scenario on Renewable and Sustainable Energy Sources with Emphasis on Algae." *Applied Microbiology and Biotechnology* 96.5 (2012): 1125-135. Web.
- 45) Clarens, Andres, Eleazer Resurreccion, Mark White, and Lisa Colosi. "Environmental Life Cycle Comparison of Algae to Other Bioenergy Feedstocks." *Environmental Science & Technology* 44.5 (2010): 1813-819. Web.
- 46) Ezell, Chase. "Is Algae the Future of Fuel?" *Earth911*. 8 Sept. 2014. Web. 26 Sept. 2014.

Interactive Qualifying Project

- 47) Fernández, F., C. González-López, J. Sevilla, and E. Grima. "Conversion of CO₂ into Biomass by Microalgae: How Realistic a Contribution May It Be to Significant CO₂ Removal?" *Applied Microbiology and Biotechnology* 96.3 (2012): 577-86. Web.
- 48) Smithemail, Val, Belinda Sturm, Frank DeNoyelles, and Sharon Billings. "The Ecology of Algal Biodiesel Production." *Trends in Biotechnology* 25.5 (2010): 301–309. Web.
- 49) Kumar, Amit, Sarina Ergas, Xin Yuan, Ashish Sahu, Qiong Zhang, Jo Dewulf, F. Malcataemail, and Herman Langenhove. "Enhanced CO₂ Fixation and Biofuel Production via Microalgae: Recent Developments and Future Directions." *Trends in Biotechnology* 28.7 (2010): 371–380. Web.
- 50) *Aurorainc.* Aurora Algae, 1 Jan. 2014. Web. 29 Sept. 2014.
- 51) Luu, Catherine. "A Truly Green Alternative: Algal Biofuels." *Microbiology Fall 2010*. 9 Dec. 2010. Web. 26 Sept. 2014.
- 52) Heat Engine Cycle. Retrieved February 19, 2015, from <http://hyperphysics.phy-astr.gsu.edu/hbase/thermo/heaeng.html>
- 53) THERMAL AND HYDRAULIC MACHINES. (n.d.). Retrieved February 19, 2015, from [http://books.google.com/books?id=LwVsAKrctL8C&pg=PA102&lpg=PA102&dq=energy machine taking energy due to difference in temperature&source=bl&ots=8-RnH0HJKM&sig=i9iseDt_nNdQv77z8JNi9gjZ-4M&hl=en&sa=X&ei=DxEwVMqNO4WsyAStk4LYAQ&ved=0CCoQ6AEwAg#v=onepage&q&f=false](http://books.google.com/books?id=LwVsAKrctL8C&pg=PA102&lpg=PA102&dq=energy+machine+taking+energy+due+to+difference+in+temperature&source=bl&ots=8-RnH0HJKM&sig=i9iseDt_nNdQv77z8JNi9gjZ-4M&hl=en&sa=X&ei=DxEwVMqNO4WsyAStk4LYAQ&ved=0CCoQ6AEwAg#v=onepage&q&f=false)
- 54) Heat Engines. Retrieved February 19, 2015, from <http://aether.lbl.gov/www/classes/p10/heat-engine.html>
- 55) Battery and Energy Technologies. Retrieved February 19, 2015, from http://www.mpoweruk.com/stirling_engine.htm
- 56) Efficiency of Stirling engine and Carnot's theorem. (n.d.). Retrieved February 19, 2015, from <http://physics.stackexchange.com/questions/78915/efficiency-of-stirling-engine-and-carnots-theorem>

Interactive Qualifying Project

- 57) Epiphany OnE Puck Turns Heat to Electricity: World's Most Useful Coaster. (n.d.). Retrieved February 19, 2015, from <http://technabob.com/blog/2013/02/11/epiphany-one-coaster/>
- 58) Temperature of Ocean Water. (n.d.). Retrieved February 19, 2015, from <http://www.windows2universe.org/earth/Water/temp.html>
- 59) "Hydropower is Affordable." *National Hydropower Association*. 2015. Web. 18 Sept. 2014. <<http://www.hydro.org/why-hydro/affordable>>.
- 60) "Wave and Tidal." *Renewable Northwest*. Renewable Northwest Project, Mar. 2007. Web. 18 Sept. 2014. <<http://www.rnp.org/node/wave-tidal-energy-technology>>.
- 61) *Global Ocean Energy Market Study 2010-2030*. Cambridge: IHS Emerging Energy Research, 2010. Print.
- 62) Energy production and imports. Retrieved March 3, 2015, from http://ec.europa.eu/eurostat/statistics-explained/index.php/Energy_production_and_imports
- 63) Retrieved September 14/11/ 2014 [The four Jet streams Retrieved February 19, 2015, from http://geoconceicao.blogspot.com/2013/05/correntes-de-jato.html](http://geoconceicao.blogspot.com/2013/05/correntes-de-jato.html)
- 64) Weather Questions & Answers. Retrieved February 20, 2015, from http://www.weatherquestions.com/What_causes_the_jet_stream.htm
- 65) Kite Energy - Leveraging The Jet Stream For Renewable Power. (n.d.). Retrieved February 20, 2015, from http://www.science20.com/mark_halper/kite_energy_leveraging_jet_stream_renewable_power-93059
- 66) KiteGen. Retrieved February 20, 2015, from <http://kitegen.com/>
- 67) The cycle of a flight: Retrieved February 20, 2015, from <http://www.engineering.com/Portals/0/BlogFiles/tlombardo/KitePower/SkySailCycles.JPG>
- 68) Kite Energy - Leveraging The Jet Stream For Renewable Power. (n.d.). Retrieved February 20, 2015, from http://www.science20.com/mark_halper/kite_energy_leveraging_jet_stream_renewable_power-93059

Interactive Qualifying Project

- 69) Harnessing the jet stream for wind turbines | ZDNet. (n.d.). Retrieved February 20, 2015, from <http://www.smartplanet.com/blog/intelligent-energy/harnessing-the-jet-stream-for-wind-turbines/>
- 70) Kite Energy -Leveraging The Jet Stream For Renewable Power. (n.d.). Retrieved February 20, 2015, from http://www.science20.com/mark_halper/kite_energy_leveraging_jet_stream_renewable_power-93059
- 71) KiteGen. (n.d.). Retrieved February 20, 2015, from <http://kitegen.com/>
- 72) LOW-TECH MAGAZINE. Retrieved February 20, 2015, from <http://www.lowtechmagazine.com/2007/09/sailing-ship-re.html>
- 73) Flying Wind Turbines. (n.d.). Retrieved February 20, 2015, from <http://www.interactivearchitecture.org/flying-wind-turbines.html>
- 74) FLYING WIND TURBINES. (n.d.). Retrieved February 20, 2015, from <http://inhabitat.com/flying-wind-turbines/>
- 75) Harnessing the jet stream for wind turbines | ZDNet. (n.d.). Retrieved February 20, 2015, from <http://www.smartplanet.com/blog/intelligent-energy/harnessing-the-jet-stream-for-wind-turbines/>
- 76) Magenn Air Rotors: Floating Wind Turbines. (n.d.). Retrieved February 20, 2015, from <http://www.treehugger.com/renewable-energy/magenn-air-rotors-floating-wind-turbines.html>
- 77) Magenn Air Rotors: Floating Wind Turbines. (n.d.). Retrieved February 20, 2015, from <http://www.treehugger.com/renewable-energy/magenn-air-rotors-floating-wind-turbines.html>
- 78) Salient White Elephant. (n.d.). Retrieved February 20, 2015, from <https://salientwhiteelephant.wordpress.com/category/airborne-wind-turbine/>
- 79) Max Planck Institute for Biogeochemistry PublicRelations/Single. (n.d.). Retrieved February 20, 2015, from <http://www.bgc-jena.mpg.de/pmwiki.php/PublicRelations/Single?userlang=en&id=1343821030>

Interactive Qualifying Project

- 80) Turbine lifted in the sky Retrieved February 20, 2015, from http://worldwide.espacenet.com/publicationDetails/originalDocument?CC=US&NR=2010026007A1&KC=A1&FT=D&date=20100204&DB=EPODOC&locale=en_EP
- 81) Tousif, S., & Taslim, S. (2011). Tidal Power: An Effective Method of Generating Power. *International Journal of Scientific & Engineering Research*, 2(5), ISSN 2229-5518.
- 82) Tidal Wave Energy. (n.d.). Retrieved February 20, 2015, from <http://www.renewableenergyspot.com/tidal-wave-energy/>
- 83) *Alternative Energy*. (n.d.). Retrieved February 20, 2015, from http://www.alternative-energy-news.info/harnessing-tidal-wave-energy-with-push-plates/#disqus_thread
- 84) The THAWT device Retrieved February 20, 2015, from <http://keplerenergy.co.uk/about.html.php>,
- 85) Mechanical Engineering. (n.d.). Retrieved February 20, 2015, from <http://www.mechanicalengineeringblog.com/tag/thawt-tidal-turbine/>
- 86) Horton, J. Retrieved February 20, 2015, from <http://science.howstuffworks.com/environmental/earth/oceanography/ocean-current3.htm>
- 87) Ecotricity's SeaRaser Tidal Power Generator Could be the World's Cheapest Method Of Producing Electricity. (n.d.). Retrieved February 20, 2015, from <http://inhabitat.com/ecotricitys-searaser-tidal-power-generator-could-be-the-worlds-cheapest-method-of-producing-electricity/>
- 88) Bay of Fundy. (n.d.). Retrieved February 18, 2015, from http://en.wikipedia.org/wiki/Bay_of_Fundy
- 89) *Fundy Force*. (n.d.). Retrieved February 18, 2015, from <http://fundyforce.ca>
- 90) DEAWOO E&C. (2010, October 1). SIHWA TIDAL POWER PLANT PROJECT.
- 91) Schneeberger, M. (2008, September 1). SIHWA TIDAL –TURBINES AND GENERATORS FOR THE WORLD'S LARGEST TIDAL POWER PLANT.
- 92) Park, N. (2007, May 1). Sihwa Tidal Power Plant: A success of environment and energy policy in Korea.
- 93) De Laleu, V. (2009, October 1). La Rance Tidal Power Plant 40-year operation feedback – Lessons learnt. De Laleu, V. (2011), "Chapter 7. Production of Tidal Range Energy", in B. Multon

Interactive Qualifying Project

- 94) AELBRECHT, D. (2014, October 1). La Rance Tidal Power Plant: Past, present and future.
- 95) Tidal Lagoon Swansea Bay Project introduction. (2014, February 1). Retrieved December 1, 2014. Tidal Lagoon Power Ltd.(2014, July)The Economic Case for a Tidal Lagoon Industry in the UK
- 96) THE SWANSEA TIDAL ENERGY PROJECT. (n.d.). Retrieved February 19, 2015, from <http://www.tidallagoonswanseabay.com/faqs.aspx>
- 97) Bureau of Ocean Energy Management, and Office of Renewable Energy Programs. "Lease Issuance for Marine Hydrokinetic Technology Testing on the Outer Continental Shelf Offshore Florida." *Bureau of Ocean Energy Management*. U.S. Department of the Interior, 1 Aug. 2013. Web. 1 Jan. 2014.
- 98) Rising tide Global trends in the emerging ocean energy market. (2014, January 1). Retrieved December 1, 2014.
- 99) Moreno, N., Sallent, R., Espi, A., Bao, D., & Teillent, Y. (2008). Ocean Current's Energy. *Project 2008*. Retrieved November 4, 2014, from <http://www.exergy.se/goran/hig/re/08/ocean.pdf>
- 100) VanZwieten, J., Smentek-Duerr, A., Alsenas, G., & Hanson, H. (2013). GLOBAL OCEAN CURRENT ENERGY ASSESSMENT: AN INITIAL LOOK. *Proceedings of the 1st Marine E Nergy Technology Symposium*. Retrieved November 4, 2014, from http://www.globalmarinerenewable.com/images/global_ocean_current_energy_assessment_an_initial_look.pdf
- 101) Atlantis Analysis. (2011, September 26). Retrieved November 19, 2014, from http://www.globalmarinerenewable.com/images/stories/2012Presentations/Atlantis_RESOURCES_DELIVERING_COMMERCIAL_TIDAL_POWER_Joseph_Fison.pdf
- 102) Tidal Lagoon Power Ltd.(2014, July)The Economic Case for a Tidal Lagoon Industry in the UK
- 103) Carrington, M. (2011, March 2). Underwater kite-turbine may turn tides into green electricity. Retrieved December 5, 2014, from <http://www.theguardian.com/environment/damian-carrington-blog/2011/mar/02/underwater-kite-turbine-green-electricity>

Interactive Qualifying Project

- 104) Capital Cost for Electricity Plants (2013, April 12). Retrieved December 5, 2014, from <http://www.eia.gov/forecasts/capitalcost/>
- 105) Fiscal Year 2015 Budget Of The U.S. Government. (2014). Retrieved December 5, 2014, from <http://www.whitehouse.gov/sites/default/files/omb/budget/fy2015/assets/budget.pdf>
- 106) Direct Federal Financial Interventions and Subsidies in Energy in Fiscal Year 2010 (2011, August 1). Retrieved December 5, 2014, from <http://www.eia.gov/analysis/requests/subsidy/>
- 107) Electricity (2014). Retrieved December 5, 2014, from <http://www.eia.gov/electricity/>
- 108) Schwartzlose, R., & Reid, J. (1972). Near-Shore Circulation In The California Current. *CalCofi*, 16, 57-65. Retrieved December 11, 2014, from http://www.calcofi.org/publications/calcofireports/v16/Vol_16_Schwartzlose_Reid.pdf
- 109) Volume transport in the Alaska Coastal Current. (1989). *Continental Shelf Research*, 9(12), 1071-1083. Retrieved December 11, 2014, from <http://www.pmel.noaa.gov/pubs/outstand/schu0984/schu0984.shtml>
- 110) Robson, John. "Gulf Stream Energy Compared To Wind." *The Gulf Stream Turbine*. Gulf Stream Turbines LLC, 1 Jan. 2010. Web. 7 Oct. 2014.
- 111) Allen, Greg. "Harnessing the Power of the Gulf Stream." *NPR*. 3 Dec. 2007. Web. 7 Oct. 2014.
- 112) Yang, Xiufeng, Kevin Haas, and Hermann Fritz. "Ocean Current Energy Assessment for the Gulf Stream." New England Marine Renewable Energy Center. 4th Annual Marine Renewable Energy Technical Conference, 30 Oct. 2012. Web. 7 Oct. 2014.
- 113) Wyre Energy Ltd. (2013), Comparisons of tidal power stations around the World, Wyre Energy Ltd.
- 114) SI Ocean (2013a), "Ocean Energy: Cost of Energy and Cost Reduction Opportunities", SI Ocean, May, http://si-ocean.eu/en/upload/docs/WP3/CoE%20report%203_2%20final.pdf.
- 115) Carbon Trust (2012), "Technology Innovation Needs Assessment Marine

Interactive Qualifying Project

Energy: Summary Report”, August, www.carbontrust.com/media/168547/tina-marine-energy-summary-report.pdf.

- 116) SEVERN TIDAL POWER (2010,October) Feasibility Study Conclusions and Summary Report
- 117) Usachev, I. (2008). ENVIRONMENTAL PROTECTION AND SOCIAL ASPECTS OF TIDAL ENERGY (Vol. 2). Encyclopedia of Life Support Systems (EOLSS).
- 118) Tidal Lagoon Swansea Bay Project introduction. (2014, February 1). Retrieved December 1, 2014.
- 119) "Experimental Ocean Current Turbine." *Southeast National Marine Renewable Energy Center*. 1 Jan. 2013. Web. 7 Oct. 2014.
- 120) Marine Renewable Energy Handbook, (Ed.), Hermes Science Publications, pp. 173-218.
- 121) Irizarry-Rivera, A., & Colucci-Ríos, J. (2008, October 1). Achievable Renewable Energy Targets. Retrieved November 20, 2014, from http://www.uprm.edu/aret/docs/Ch_3_Ocean.pdf
- 122) Landberg, Magnus. "Deep Green Technology." *Minesto*. Web. 7 Oct. 2014.
- 123) Lee, K. (2006, May 1). Tidal and Tidal Current Study in Korea.
- 124) Mehmood, N., Liang, Z., & Khan, J. (2012). Harnessing Ocean Energy by Tidal Current Technologies. *Research Journal of Applied Sciences, Engineering and Technology*, 4(18), 3476-3487. Retrieved November 21, 2014, from <http://maxwellsci.com/print/rjaset/v4-3476-3487.pdf>
- 125) Ocean Current Energy. (n.d.). Ocean Energy Council. Retrieved November 4, 2014.
- 126) Robson, John. "The Gulf Stream Turbine: Plus Two Ideas For Dependent Patents." *The Gulf Stream Turbine*. Gulf Stream Turbines LLC, 1 Jan. 2010. Web. 7 Oct. 2014.
- 127) Sagastume, Patricia. "Gulf Stream Gold: Mining Green Energy from Atlantic Currents." *Al Jazeera America*. 14 July 2014. Web. 7 Oct. 2014.

Interactive Qualifying Project

- 128) Tidal device principles (device classification by EMEC). (2012, January 1). Retrieved November 19, 2014, from <http://decarboni.se/publications/marine-energy-uk-state-industry-report-2012/51-tidal-device-principles-device-classification-emec>
- 129) Tidal Energy Report. (2011, July 20). Retrieved November 20, 2014, from <http://www.tzcb.org.uk/wp-content/uploads/2011/12/TZCB-Tidal-Energy-Report-Rev-1.pdf>
- 130) Tidal In Stream Energy Conversion (TISEC) Devices. (2005, November 9). Retrieved November 20, 2014, from <http://storage.globalcitizen.net/data/topic/knowledge/uploads/2011041018587705.pdf>
- 131) Wave and Tidal Energy in the UK. (2011). *RenewableUK*. Retrieved November 19, 2014, from http://www.google.com/url?sa=t&rct=j&q=&esrc=s&source=web&cd=3&cad=rja&uact=8&ved=0CDAQFjAC&url=http://www.renewableuk.com/download.cfm/docid/BA730B9F-8319-4759-A8A5A59BBBE64F4F&ei=u0piVKzmDIz-yQTd94I4&usg=AFQjCNE6DIUJf_EnwJnuDeKBvSnR593uKg&sig2=JMyc55ZBFLqY YznX6kJnmQ
- 132) Welsh Baccalaureate Resource.(2014, April 1). Tidal Lagoon Swansea Bay. Retrieved December 1, 2014.
- 133) ("U.S.Natural Gas Total Consumption (Million Cubic Feet)." *U.S.Natural Gas Total Consumption (Million Cubic Feet)*. Web. 5 Sept. 2014.)
- 134) World Energy Consumption Facts, Figures, and Shockers. (n.d.). Retrieved September 15, 2014, from <http://www.energytrendsinsider.com/2012/06/28/world-energy-consumption-facts-figures-and-shockers/>
- 135) Buying A Car - Do I choose petrol or diesel? (n.d.). Retrieved September 23, 2014, from <http://www.whatcar.com/car-advice/buying/do-i-choose-petrol-or-diesel-/3485068>
- 136) Despite lower carbon dioxide emissions, diesel cars may promote more global warming than gasoline cars :10/02. (n.d.). Retrieved September 23, 2014, from <http://news.stanford.edu/pr/02/jacobsonJGR1023.html>

Interactive Qualifying Project

- 137) "Naming the parts" Retrieved February 19, 2015, from http://ffden-2.phys.uaf.edu/212_fall2009.web/Isaac_Hebert/Stirling_Cycle.html
- 138) Teragon's Summary of Cryogen Properties(2005) Teragon Research Retrieved October 17, 2014.
- 139) Jack Pare, Tabular comparisons of the costs of various electric generation technologies presented in Tidal Power Technology(February 23, 2007), Retrieved January 20, 2015.
- 140) Rising tide Global trends in the emerging ocean energy market. (2014, January 1). Retrieved December 1, 2014.