

# The Feasibility of LED Lighting for Commercial Use

A Major Qualifying Project Report:

Submitted to the Faculty

of the

Worcester Polytechnic Institute

In partial fulfillment of the requirements for the

Degree of Bachelor of Science in

Management Engineering

by

---

**Michael S. Horgan**

---

**Daniel J. Dwan**

Date: April 1<sup>st</sup>, 2014

Approved:

---

Professor Helen G. Vassallo, Major Advisor

## Table of Contents

Table of Figures.....	2
List of Tables .....	3
Abstract.....	4
Executive Summary.....	4
1.0 Introduction and Problem Statement.....	5
2.0 Materials and Methods.....	6
2.1 Literature Review .....	6
2.2 Market Analysis.....	6
2.3 Cost/Benefit Analysis .....	6
2.4 Behavioral Analysis .....	7
3.0 Results.....	7
3.1 Market Analysis.....	7
3.1.1 Market Size and Segmentation .....	7
3.1.2 Competition .....	9
3.1.3 Growth and Recent Market Trends .....	9
3.1.4 SWOT Analysis.....	11
3.2 Cost Benefit Analysis - LED vs. Incandescent, CFL, Linear Fluorescent.....	12
3.2.1 Incandescent Light Bulbs .....	12
3.2.2 Compact Fluorescent Bulbs .....	14
3.2.3 LED Light Bulbs .....	15
3.2.4 Linear Tube Lighting – Fluorescent vs. LED.....	15
3.3 Cost-Benefit Analysis – Phi Gamma Delta Fraternity House.....	16
3.4 Survey Results .....	17
4.0 Discussion.....	20
4.1 Literature Review .....	20
4.1.1 Brief History of Lighting .....	20
4.1.2 Mechanisms of Incandescent Lighting.....	21
4.1.3 Mechanisms of Fluorescent Lights.....	22
4.1.4 Mechanisms of LED Lights.....	22
4.1.5 Current Trends in the lighting and LED market .....	24
4.2 Market Analysis.....	26
4.3 Cost Benefit Analysis: LED vs. Incandescent, CFL, Linear Fluorescent.....	26

4.3.1 Standard Bulb Comparison: Incandescent, CFL, LED .....	27
4.3.2 Tube Lighting Comparison – T8 Linear Fluorescent, T8 Linear LED .....	28
4.4 Cost Benefit Analysis - Phi Gamma Delta Fraternity House.....	28
4.5 Survey Discussion Table .....	32
5.0 Conclusions and Recommendations .....	33
5.1 Conclusions .....	33
5.2 Recommendations .....	35
6.0 References .....	36
7.0 Appendix .....	38
7.1 Survey Appendices .....	38
7.1.1 Distributed survey and number of responses.....	38
7.1.2 Survey Results .....	38
7.1.3 Graphs of Survey Questions.....	41
7.2 Cost Benefit Analysis Appendices .....	45
7.2.1 Energy Audit.....	45
7.2.2 Floor Plan of Phi Gamma Delta .....	45
7.3 Project Contributions.....	47

## Table of Figures

Figure 1 Annual Electricity Consumption by Sector and Type of bulb.....	8
Figure 2 World Market for Lamps by Technology .....	10
Figure 3 Forecasted Retail price for all Replacement LED lamps.....	11
Figure 4 SWOT analysis of LED lighting.....	11
Figure 5 . Breakdown of Incandescent Bulb <sup>19</sup> .....	21
Figure 6 Breakdown of Fluorescent bulb <sup>21</sup> .....	22
Figure 7 Composition of LED Semiconductor <sup>22</sup> .....	22
Figure 8 Sketch of output for typical laser diode as a function of drive current for three separate temps. <sup>22</sup> .....	23
Figure 9 Sketch of Semiconductor laser light <sup>22</sup> .....	23
Figure 10. Breakdown of components in a LED light bulb .....	24
Figure 11 Newly Enforced Government Standards for Incandescent Lightin <sup>30</sup> .....	25
Figure 12 Advancements of different lighting technologies.....	25
Figure 13 Survey taken by Respondents.....	38
Figure 14 Survey Results with Statistical Analysis .....	39
Figure 15 Pie Chart of answers from Survey Question 1 .....	41
Figure 16 Pie Chart of answers from Survey Question 2 .....	42
Figure 17 Pie Chart of answers from Survey Question 3 .....	42

Figure 18 Pie Chart of answers from Survey Question 4 .....	43
Figure 19 Pie Chart of answers from Survey Question 5 .....	43
Figure 20 Pie Chart of answers from Survey Question 6 .....	44
Figure 21 Average of Answers from Survey Question 7 and the variance of answers .....	44
Figure 22 Basic Floor plan of Basement .....	45
Figure 23 Basic Floor plan of the first floor .....	46
Figure 24 Basic Floor plan of the second floor .....	46
Figure 25 Basic Floor plan of the third floor .....	47

## List of Tables

Table 1 Summary of Energy Audit.....	16
Table 2 LED Lights replacing traditional light forms .....	17
Table 3 Survey Results .....	19
Table 4 Cost of LED Lighting.....	28
Table 5 Replacement costs of LED light bulbs .....	29
Table 6 Total annual cost of bulbs .....	30
Table 7 Potential Cost Savings of LED bulbs .....	30
Table 8 Survey Discussion Table .....	32
Table 9 Table of the energy audit raw data used to perform calculations.....	45

## Abstract

Recent developments in light-emitting diode technology have allowed LED lighting products to penetrate the commercial lighting market with enormous potential for growth. Our team developed several conclusions forecasting the future of LED lighting in the commercial market and made recommendations for a business' strategic entry into the commercial lighting market with LED products. Our team's conclusions and recommendations were based on our own market, cost-benefit, and behavioral analyses pertaining to the viability of LED lighting products for widespread adoption in the commercial sector.

## Executive Summary

Light Emitting Diodes (LEDs) have recently entered the lighting market as an energy efficient alternative to traditional light sources such as incandescent and fluorescent bulbs. These lights still have an enormous amount of room for technological growth and offer various advantages over all other forms of lighting. Having just recently entered the lighting market, LEDs have faced many barriers to entry and are struggling to obtain a market share over the traditional forms of lights.

A combination of a literature review and industry tests were performed to determine the feasibility of LEDs for widespread use. The literature review and industry interviews were used to determine the major differences in the major forms of lighting as well the future trends of LEDs. A market analysis was conducted to define the current status of the lighting market and where LED lights currently stand. A cost benefit analysis was performed on incandescent, compact fluorescent and LED bulbs as well as fluorescent tubes to determine the cost saving potential of certain lights. An energy audit was also conducted on a commercial building for a real world scenario on the effects of switching to LED lights. Finally a survey was completed by nearly 400 respondents in order to gauge the public's knowledge of LED and other forms of lighting as well as the factors that influence a buyers purchasing decisions.

The results revealed that LEDs are nearing the end of the introduction phase product life cycle, ready to penetrate the growth phase. LEDs offer a variety of advantages over other bulbs as well as major cost savings but the major barrier to being accepted into the market is the high price of the product. Businesses who are looking to enter the LED market must ensure to not only have an innovative product but more importantly offer it at a competitive price.

## 1.0 Introduction and Problem Statement

A universal trend toward the progressive development of an environmentally sustainable society has brought about a substantial demand for innovative, energy-efficient technology. As these new technologies are developed, they must be evaluated and compared to existing products in order to determine whether the new technology will be more suitable to serve its intended purpose. This evaluation must take into account a number of factors including, but not limited to, energy-efficiency, cost-efficiency, ability to perform the intended task(s), and degree of innovation in the new technology.

One area in need of new technological advancement is the commercial lighting industry. Commercial buildings, including stores, offices, restaurants, hospitals, and schools, account for approximately twenty percent of the United States' total energy consumption. Thirty-eight percent of this energy consumption is in the form of lighting. Current widely-utilized lighting methods include linear fluorescent, compact fluorescent, high-intensity discharge, and incandescent. Commercial buildings primarily use fluorescent lighting<sup>1</sup>. These methods of lighting have been used for a number of years without the emergence of any truly competitive alternatives. Generally, these traditional lighting methods are considered "mature technologies," meaning they are considered to have little room for advancement in performance<sup>2</sup>.

The prospect of improving lighting technology is currently being investigated. Such improvements may include energy-efficiency, light depreciation, lifetime, light output and distribution, color quality, color shift, and dimmability<sup>3</sup>. Recent advancement in light-emitting diode (LED) technology has made the widespread commercial use of LED lighting a very realistic possibility for the near future. New LED lights offer many advantages when compared to fluorescent or incandescent lights. First, the latest LED bulbs last up to five times longer than traditional fluorescent bulbs, and nearly 50 times longer than incandescent bulbs. Additionally, new LED light bulbs use half the electricity that compact fluorescent bulbs use in the same allotted time, and less than a quarter of the electricity used by incandescent bulbs. The major drawback to buying the most current LED light bulbs is the price; LED light bulbs cost nearly 10 times the price of a CFL bulb, and 30 times that of an incandescent bulb. However, users of LED light bulbs can recover this high overhead cost in energy savings over time, saving money in the long run<sup>4</sup>. The goal of this project was to address the need for an alternative commercial lighting method by evaluating the prospect of LED lighting for widespread use.

## 2.0 Materials and Methods

In order to evaluate the feasibility of Light-Emitting Diode technology as an efficient and cost-effective alternative to traditional technologies for commercial lighting, we conducted extensive research, in the form of a literature review, market analysis, cost-benefit analysis, and a behavioral analysis involving stakeholder interviews and a survey.

### 2.1 Literature Review

A comprehensive literature review of material relating to LED lighting technology was a vital element of this project. This involved a research focus on the development of the commercial lighting market, including traditional technologies and the emergence of new innovations in LED technology. We reviewed applicable data provided by the U.S Department of Energy and the U.S. Census Bureau, and research studies previously conducted by private organizations and consulting firms. This literature review provided a strong background and factual basis for our market analysis and cost-benefit analysis.

### 2.2 Market Analysis

A market analysis studies the attractiveness and opportunity of a particular market within an industry. In this analysis, our team was able to use data and market trends to project the near future of LED lighting and the level of opportunity available for a business entering this market. Our project's focus was on the commercial lighting market, rather than residential or industrial lighting. In narrowing our focus, we aimed to gain a more complete and detailed understanding of the commercial lighting market as it pertains to LED lighting technologies. Research for our market analysis involved statistical data provided by market research organizations, the U.S. Department of Energy, and the U.S. Census Bureau. In addition to market size and segmentation, our analysis included the market's overall trends, a description of recent growth, projections for future growth, and a SWOT analysis, including strengths, weaknesses, opportunities, and threats involved in venturing into the commercial lighting market with innovative LED technologies.

### 2.3 Cost/Benefit Analysis

A cost-benefit analysis is a business process used to evaluate the benefits of a project or decision against its' financial costs. Our cost benefit analysis involved a comparison of LED lighting with traditional forms of commercial lighting in terms of financial costs, energy usage, product lifetime, and product performance. The necessary data and information came from our literature review and research. Useful sources of data included the U.S. Department of Energy, private research and consulting firms, and scholarly articles published in technical journals.

Our team performed a case study of our residence building, the Phi Gamma Delta Fraternity House (FIJI), which is considered a commercial building. This case study involved an analysis weighing the costs and benefits of the possible decision to implement innovative LED lighting in place of the more traditional fluorescent lighting currently being used. After collecting all necessary observational data and calculating costs and benefits, we were able to draw conclusions regarding the decision of FIJI whether to switch to LED lighting.

## 2.4 Behavioral Analysis

In order to gain a better perspective of LED technology's emergence into the commercial lighting market, we conducted a behavioral analysis, including a first-hand examination of stakeholders' points-of-view in the form of interviews with informed individuals such as members of the construction industry, commercial building owners, LED lighting manufacturers, scholars with an applicable area of expertise, employees of electric companies, private consultants, and property managers. All interviews were analyzed and used to draw conclusions regarding expert and stakeholder perspectives of the commercial LED lighting market. We also used a survey to gauge the public's general knowledge of the current LED lighting market. This survey was useful in determining what factors influence consumers into purchasing specific forms of lighting.

## 3.0 Results

Our team conducted a market analysis, a theoretical cost-benefit analysis, a practical cost-benefit analysis, and a behavioral analysis (survey). In this section, we have displayed summarized our data for each analysis, and displayed our calculations and major findings.

### 3.1 Market Analysis

The results of our analysis of the commercial lighting market as it relates to LEDs was based on extensive research and existing statistical data. Our findings include information regarding the market's size and segmentation, level of existing competition, and growth and recent market trends. Our team also performed a SWOT analysis to display the strengths, weaknesses, opportunities, and threats that exist for a company planning on entering the commercial lighting market with innovative new LED products.

#### 3.1.1 Market Size and Segmentation

Energy consumption in the United States falls under four sectors; residential, commercial, industrial, and transportation. Together, residential homes and commercial buildings comprise 40% of the United States' total energy consumption. Commercial buildings, including schools, stores, and



businesses, make up 18.6% of this total energy consumption, mainly in the form of electricity<sup>1</sup>. As of 2010, approximately 5.5 million commercial buildings existed in the United States averaging nearly 15,000 square feet of floor area per building<sup>5</sup>. These buildings use 38% of their electricity specifically for lighting. Annually, the U.S. consumes 700 TWh of electricity in the form of lighting, 19% of the country's total energy consumption. The commercial sector comprises 349 TWh, nearly half of the U.S.' lighting energy consumption<sup>5</sup>. From these facts, it is apparent that commercial lighting accounts for a huge portion of United States' energy consumption and encompasses a vast share of the lighting market.

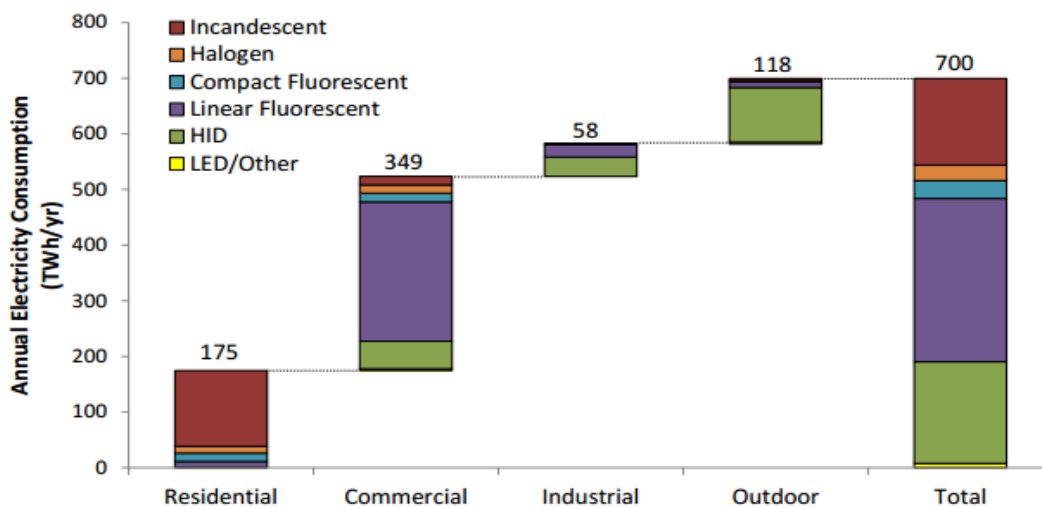

Figure 1 Annual Electricity Consumption by Sector and Type of bulb

Compared to the other market sectors, LED lights have great potential to penetrate the commercial market effectively. In 2010 a total of 67,015,000 LED lamps were used, over half of which (38,029,000 lamps) for commercial purposes. It is important to note, however, that nearly 80% of these LED lamps purchased by the commercial sector were merely used in exit signs. Despite this fact, LED lighting has seen a significant increase in commercial non-exit sign applications. In 2001, only 37,000 non-exit sign lamps were being used for commercial purposes. By 2010, 7.5 million non-exit sign LED bulbs were in use in the commercial sector<sup>5</sup>. The potential for widespread adoption of LED lighting is arguably the highest in the commercial market segment not only because the commercial sector accounts for nearly half of the U.S. total lighting energy consumption, but also because it represents the sector in which the greatest number of lumens are produced. This can be attributed mainly to the long operating hours of commercial building compared to, for example, a residential building<sup>5</sup>. The commercial market segment is extremely poised for the increased adoption of LED lighting technology.

### 3.1.2 Competition

Within the commercial lighting market, there are several competing types of lighting technology. Compact fluorescent, linear fluorescent and incandescent lighting are more traditional light sources to be mass produced and optimized for widespread use. In 1997, white LED lights hit the market and have since then begun to find their way into all sectors of the market. Figure 1 displays the breakdown of the number of lamps used by each sector in 2010. The total commercial lamp inventory for the U.S. in 2010 was 2,069,306,000 lamps. In comparison, only 38,029,000 commercial lamps used in 2010 were LED lights, a mere 1.8% market share in commercial lighting. Linear fluorescent lamps dominated the commercial lighting market with nearly 80% of the market share, while compact fluorescents (CFLs) accounted for 10% of commercial lighting. Incandescent lamps represented a 4% market share in commercial lighting, while halogen and high-intensity discharge accounted for 2.3% and 1.8%, respectively<sup>5</sup>. Despite the fact that LEDs currently control a very small market share in commercial lighting, as the technology evolves, its potential to gain a greater market share increases dramatically.

Today's lighting industry is controlled by a handful of major competitors making it hard for new companies to enter into the market. General Electric, Siemens and Philips Electronics control a combined 84.8% of this market. With fluorescent and incandescent lighting reaching their efficiency and life expectancy limits, these major players in the lighting industry are looking towards LED lights to maintain a competitive edge over one another.

### 3.1.3 Growth and Recent Market Trends

Currently, LED light bulbs are enduring the early adoption phase of the product life cycle. However, continued technological advancement in LED lighting have poised these products to enter and excel through the growth phase. In recent years, the LED lighting market as a whole has been undergoing significant growth. The LED lighting market, measured at \$4.8 billion in 2012, is projected to reach \$42 billion by 2019, with a growth rate of 45% each year<sup>6</sup>. Figure 2 depicts IMS Research growth projections for different segments of the overall world lighting market. The research firm predicts the LED market begin to surpass all other lighting types in revenue in 2013<sup>7</sup>. A 2012 report from Pike Research predicted LED lighting's share of the commercial lighting market to exceed 50% by 2021<sup>8</sup>. Less efficient incandescent and fluorescent bulbs will gradually be phased out, allowing innovative new LED products to move in and capture the commercial lighting market.

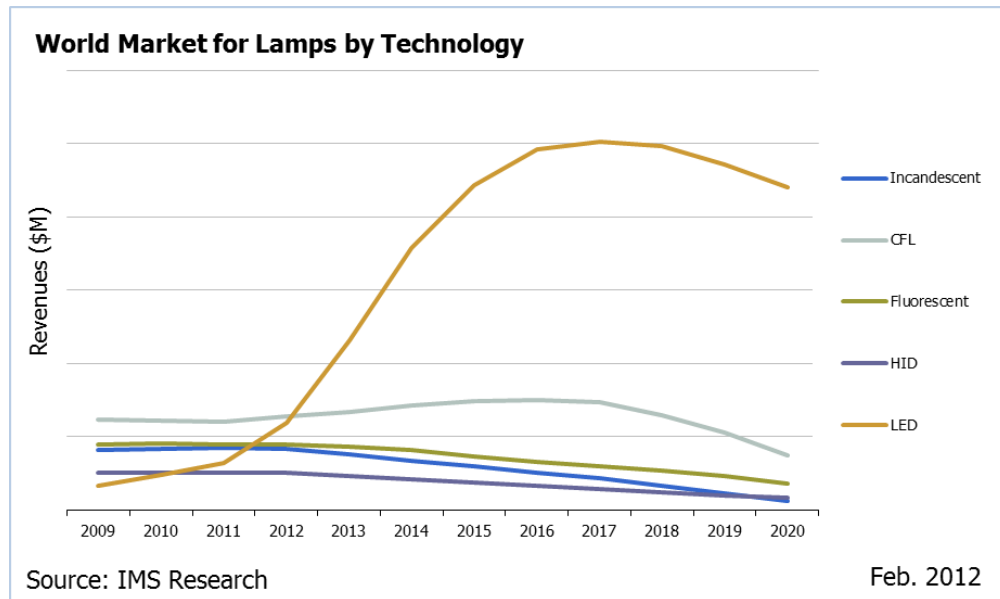

Figure 2 World Market for Lamps by Technology

There are several reasons behind these optimistic predictions. To understand the reasons for these growth projections, we look back to the major drawbacks of LED lighting that have deterred consumers in the past. First, LED light bulbs, regardless of their energy-saving potential, have been significantly more expensive than traditional incandescent and fluorescent bulbs. High initial costs of LED bulbs have scared away potential buyers for some time now. However, recent advancement in LED lighting technology has vastly increased the potential for significantly more affordable LED bulbs to reach the market. In 2009, LED bulbs could be purchased for upwards of \$70. As of 2012, the price for a 40-watt equivalent LED light bulb averaged around \$20, still nearly ten times the price of a CFL bulb at the time. In the past year, technological advancements have given way to similar LED products only costing about \$10<sup>9</sup>.

Following recent trends in LED light bulb innovation, the retail price of LED bulbs is expected to decrease in the near future. Figure 3 depicts the forecasted price<sup>8</sup> of a typical LED bulb (40-60 Watt equivalent) for each year through 2020. These projections show an exponential decrease in the retail price of LED bulbs. IMS Research projected in 2012 that by 2014 the average selling price of an LED bulb (40-60 Watt equivalent) will fall below \$10. A ban on incandescent bulbs in the United States, expected to be imposed in the next year, is predicted to cause a major surge in LED light bulb sales. As LED technology advances, manufacturers will be able to offer products at lower prices. Furthermore, as sales increase, manufacturers will produce more, driving costs down, therefore lowering retail prices even further. While it is necessary for manufacturers in emerging markets to strive to lower their prices, LED manufacturers must also prioritize the quality of their products. As compact fluorescent bulbs emerged

in the 1990's, low price products that sacrificed products hindered the product's uptake in the market. A good balance of low price and high quality is essential for any product designed to enter the commercial LED lighting market<sup>8</sup>.

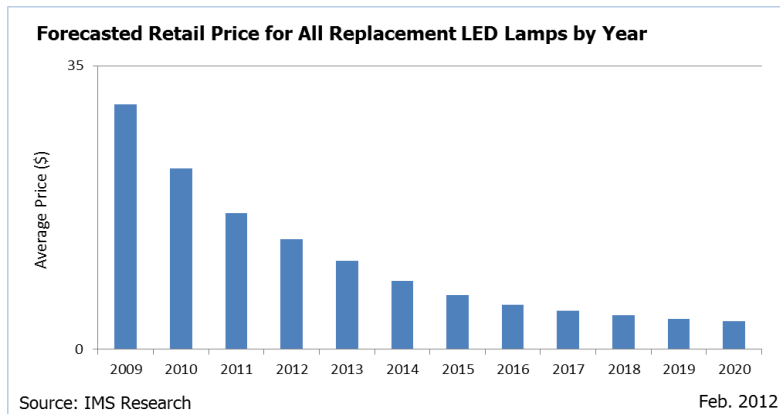

Figure 3 Forecasted Retail price for all Replacement LED lamps

### 3.1.4 SWOT Analysis

When attempting to enter a new market, it is essential for a business to first gain a full perspective of the market's situation as it exists at that time. Figure 4 depicts a SWOT analysis which identifies the strengths, weaknesses, opportunities, and threats involved in entering the commercial lighting market with the latest LED products.

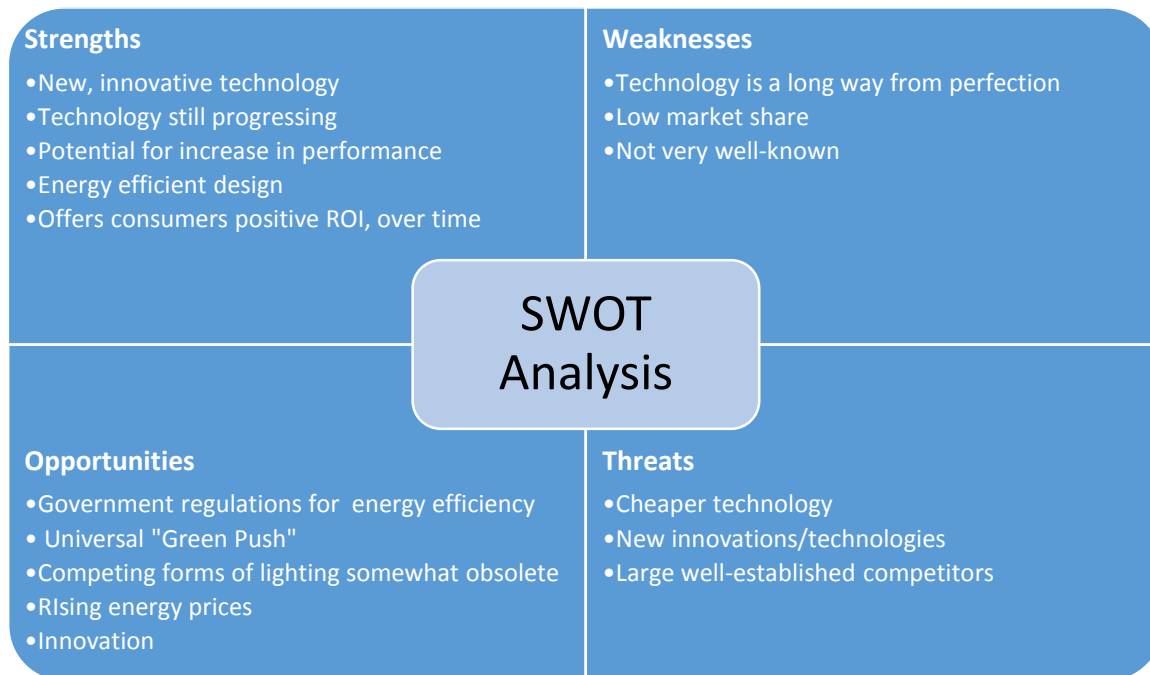

Figure 4 SWOT analysis of LED lighting

### 3.2 Cost Benefit Analysis - LED vs. Incandescent, CFL, Linear Fluorescent

The commercial lighting market is currently dominated by four major types of lighting: Linear fluorescent, compact fluorescent, incandescent, and light-emitting diode. Incandescent, the oldest of the four technologies, although popular for some time, is losing market share and well into its decline. Linear fluorescent light bulbs dominate the commercial market, currently holding an 80% market share. Compact fluorescents are also popular, with a 10% market share<sup>5</sup>. On the other hand, LED lighting is still an emerging technology, leaving a strong potential for change in the market. In order to understand the magnitude of this potential, we have conducted an analysis of LED lighting technology as it compares to linear fluorescent, compact fluorescent, and incandescent lighting technology in terms of the costs and benefits of each choice.

In order to properly compare these different types of light bulb, our team examined bulbs which output equivalent amounts of light. Certain types of light bulbs are able to produce light of comparable magnitude and quality to the light using significantly less power than other bulb types<sup>4</sup>. For this reason, we were required to linearize our data in order to compare the different bulbs side by side. To do this, we decided to evaluate each bulb type over a given time period of commercial use. Since certain light bulb types last significantly longer than incandescent bulbs, we chose a long period of time, fifteen years, which is quite realistic in a commercial setting. Collectively, light bulbs used in the commercial sector operate for an average of 11 hours per day<sup>5</sup>. Under the assumption that commercial buildings operate 300 days per year, accounting for holidays and certain weekend days, light bulbs are in use for approximately 49,500 hours over fifteen years in a typical commercial setting.

#### 3.2.1 Incandescent Light Bulbs

We began our cost benefit analysis by examining the oldest of the commercial lighting technologies currently in widespread use, incandescent. We elected to analyze a typical 60-watt light bulb (Sylvania), as this bulb is the most commonly used type of incandescent lighting in the commercial sector<sup>5</sup>. First, we investigated the typical monetary costs of incandescent lighting. The overhead cost per 60W incandescent bulb is about \$1<sup>4</sup>. The cost of energy, which is measured in kilowatt hours, must also be factored into our analysis. In 2013, the average energy cost for the commercial sector was 10.25 cents per kilowatt hour<sup>10</sup>. Cents per kilowatt hour (c/kWh) does not directly measure monetary cost, rather cost per energy used over time. To measure the actual cost of running an incandescent bulb, we took into account the typical lifespan of an incandescent bulb, 1,200 hours<sup>4</sup>. To calculate the total energy cost of running one 60 W incandescent bulb for its lifespan, we multiplied 10.25 cents (\$0.1025)

by 60 watts (.06 KW) by 1,200 hours. The total energy cost of running this bulb is \$7.38. After a \$1.00 overhead cost of the bulb is factored in, the total cost of one incandescent bulb is \$8.38.

After considering the total cost of purchasing and using one incandescent bulb, our team determined the cost of using this type of bulb over a long period of time, fifteen years, or 49,500 hours of usage. Bearing in mind the 1200-hour lifespan of the 60-watt incandescent bulb, a facility would need to use 42 bulbs consecutively to last 49,500 hours. The total cost of purchasing and using 42 of these bulbs equates to \$351.96. However, commercial buildings use more than just one incandescent bulb at a time; the average commercial building contains fourteen incandescent light bulbs in use<sup>5</sup>. To calculate the average total cost of using fourteen 60-watt incandescent bulbs over a fifteen-year period in a commercial facility, we multiplied the fifteen-year cost of using just one bulb at a time (\$351.96) by fourteen. The average total cost of using these incandescent bulbs in a typical commercial building over a fifteen-year period is \$4,927.44.

In addition to the monetary cost of an incandescent bulb, we also considered the non-monetary costs of using this product. Incandescent bulbs are highly breakable, lowering their potential value<sup>4</sup>. This fragility also entails danger for those required to clean up a broken bulb; when glass shatters and brings about high potential for injury. Although it is impossible to determine the monetary cost of the incandescent bulb's breakability, it is important to consider this downside.

After considering the various costs involved in choosing incandescent lighting for commercial use, we investigated the benefits of this technology. One positive attribute of incandescent bulbs is that they do not contain any toxic material, e.g. mercury<sup>11</sup>. Additionally, the ability to mimic natural light is very high. This attribute is measured by the color rendition rating, which for incandescent bulbs is between 98 and 100 out of 100. This can be compared to some fluorescent bulbs which are rated between 50 and 90 out of 100<sup>12</sup>.

It is clear that incandescent bulbs have distinct positive and negative attributes. Incandescent bulbs have long since reached their innovative peak, as there have been no recent advancements in the technology. Furthermore, although incandescent bulbs present the advantage of a high color rendition rating, newer alternative products feature the same benefit<sup>12</sup>. While the overhead cost per bulb is extremely low, the energy costs involved with running incandescent bulbs are less than ideal. U.S. congress put forth a law in 2007 that called for the phasing out of light bulbs that use especially high amounts of much energy. The restrictions have been executed in phases: a ban on 100-Watt bulbs went into effect in 2012 and 75-Watt bulbs were banned in January of 2013. The third phase of the policy goes into effect in 2014; 60-Watt bulbs will be outlawed. However, the policy has been strongly

criticized by those who value the low cost of traditional incandescent bulbs over the potential savings of energy efficient alternatives, and Congress has voted to defund the enforcement of the bans. Despite this fact, societal trends favoring energy conservation and efficiency render the eradication of high-wattage bulbs inevitable<sup>13</sup>.

### 3.2.2 Compact Fluorescent Bulbs

After evaluating the incandescent bulb, it was necessary for our team to understand the costs and benefits of choosing a compact fluorescent light (CFL) bulb. Maintaining continuity, we evaluated the CFL equivalent of a 60-Watt incandescent bulb. This means that the CFL bulb outputs an amount of light equal to that of the 60-Watt CFL; however it typically only requires 14 Watts of electricity to produce this light<sup>4</sup>. The average 14-Watt CFL bulb (Ecosmart) has an overhead cost of about \$4.00 and a typical lifespan of 10,000 hours<sup>4</sup>. Assuming again that electricity costs 10.25 cents per kilowatt hour, we found the energy cost of one bulb to be \$14.35 throughout its lifetime. The total cost of purchasing and using a single 14-watt CFL bulb is \$18.35.

As with our analysis of the incandescent bulb, we evaluated the costs of using CFL bulbs over a fifteen year time period, during which the lights are on for a total of 49,500 hours. Since the 14-watt CFL bulb lasts for approximately 10,000 hours, five bulbs used one after the other would be necessary over fifteen years. Therefore, we multiplied the total cost of a single CFL bulb through its lifetime (\$18.35) by five to get the total cost of using only one bulb at a time for fifteen years, \$91.75. The average commercial building utilizes 39 CFL bulbs at one time<sup>5</sup>. Therefore, the average total cost of using these CFL bulbs in a typical commercial building is \$3,578.25 over a fifteen-year period.

Along with these monetary costs involved in utilizing CFL bulbs, this type of bulb presents several unquantifiable costs. First, compact fluorescent bulbs contain mercury, presenting major problems related to their disposal. Also, CFL bulbs are criticized for having a slightly lower color rendition than incandescent bulbs, as the light that emanates from a CFL bulb typically has a slight green-blue hue<sup>12</sup>.

There is no doubt that compact fluorescent light bulbs offer advantages over other types of bulb that greatly outweigh the costs of CFLs. The most obvious benefit of CFL bulbs is their energy efficiency. A CFL bulb requires 75% less energy input than an incandescent bulb requires to produce a comparable amount of light. An organization that uses CFL bulbs instead of incandescent would undoubtedly experience significant electric-bill savings. Even though the overhead cost of a 14-watt CFL bulb is higher than that of a 60-watt incandescent bulb, this small price discrepancy would be overcome in time through energy savings. Energy efficient products are becoming more and more attractive to

commercial consumers who value sustainability. In this respect, the efficiency of CFLs provides a strong benefit to choosing this product.

### 3.2.3 LED Light Bulbs

The next light bulb our team evaluated was a 10.5-watt LED bulb (Philips), which has an equivalent light output to that of a 60-watt incandescent bulb. This LED bulb has an overhead cost averaging \$10, and a typical lifespan of 20,000 hours<sup>14</sup>. With an electricity cost of 10.25 cents per kilowatt-hour, the cost of running one bulb for its entire lifetime is \$21.53. The total cost of purchasing and using this 10.5-watt LED bulb for its entire lifetime is \$31.53.

Once again we evaluated the cost of this LED bulb being used for a fifteen year period, 49,500 hours. Considering the bulb's 20,000-hour lifespan, two and a half bulbs will be used every fifteen years. We multiplied the total cost of purchasing and using one 10.5-watt LED bulb by 2.5 to get \$78.81, the average cost of buying and using one of these bulbs for fifteen years. Considering the fact that this LED product is a new and innovative alternative to the aforementioned CFL bulb, of which there is an average of 39 per commercial building at any given time, our team decided it was best to consider the cost of purchasing and using 39 of these 10.5-watt LED bulbs at a time over a fifteen year period, which would be \$3073.69.

### 3.2.4 Linear Tube Lighting – Fluorescent vs. LED

Linear tube lighting is used very often in commercial buildings, and accounts for a high percentage of the cost of lighting for businesses. In fact, the average commercial building contains 301 linear (fluorescent) tube light bulbs in use at any given time. Eighty percent of all bulbs used in commercial buildings are linear fluorescent bulbs. Currently, virtually all of these bulbs fall under the category of linear fluorescent lighting<sup>5</sup>. Our team chose to evaluate a 32-watt T8 linear fluorescent bulb (Philips), which typically costs about \$13 and has a lifespan of 20,000 hours<sup>15</sup>. In a commercial setting, the cost of electricity to run one of these bulbs for its entire lifetime is \$65.60. Therefore, the total cost of purchasing and using one 32-watt T8 linear fluorescent bulb is \$78.60.

Considering a situation where one of these bulbs is used for a fifteen year period (49,500 hours of use), two and a half bulbs would need to be purchased and used. The cost of purchasing and running two and half bulbs is \$196.50. Commercial buildings use an average of 301 linear fluorescent tube lights at a time<sup>5</sup>, so our team multiplied the cost of running one bulb at a time for fifteen years (\$196.50) by 301, to find the average cost for a commercial building of purchasing and using this type of linear fluorescent tube lighting over a fifteen year period, \$59,146.50.



Recent technological advancements in light-emitting diode tube lighting have encouraged the adoption of these new LED products as potential replacements for linear fluorescent bulbs like the one discussed above. For the purposes of comparison, our team chose to examine an 18-watt T8 LED tube light (Green Creative), which has an equivalent light output to that of the 32-watt compact fluorescent bulb mentioned above. This bulb costs about \$38.00 and has lifespan of 50,000 hours<sup>16</sup>. In a typical commercial building, with an electricity price of 10.25 cents per kilowatt-hour, it would cost \$92.25 to run one of these bulbs for its entire lifetime. The total cost of purchasing and using one 18-watt T8 LED tube light for its entire lifespan is \$130.25.

Considering this bulb’s 50,000-hour lifespan, a single bulb would last an entire fifteen year period. Therefore, the fifteen year cost of purchasing and using one of these bulbs is \$130.25. Our group calculated the cost of using this type of LED tube light bulb to replace linear fluorescent tube lights. Since there are 301 linear fluorescent light bulbs being used in the average commercial buildings, we calculated the cost of purchasing and using 301 of these 18-watt LED tube light bulbs at a time for a fifteen year period, \$39,205.25.

### 3.3 Cost-Benefit Analysis – Phi Gamma Delta Fraternity House

In conducting an extensive energy audit of the Phi Gamma Delta Fraternity House, our team was able to adequately assess the commercial building’s current lighting situation in terms of energy consumption by type of light bulb. The house (floor plan can be found in Appendix 7.3.2) contains 15 bedrooms, an industrial kitchen, a large dining room, a foyer area, a living room, two bathrooms, and a basement. Table 1 below summarizes the data we collected in our audit and includes a list of the different types of light bulb used at FIJI, the quantity of each type of bulb, and each light bulb’s product specifications.

*Table 1 Summary of Energy Audit*

Bulb Type	Power Output (W)	# of Bulbs	Avg hours of use/day	Bulb Lifespan(h)	Lumen Output	Energy use/yr (KWh)	Energy cost/yr
CFL - Ecosmart	14	49	17.39	10000	800	4353.72	\$631.29
Linear Fluorescent - Phillips T8	32	119	24.00	20000	2000	33358.08	\$4,836.92
Incandescent - GE	100	12	13.23	1000	1350	5795.08	\$840.29
LED	10	6	14.00	20000	600	306.60	\$44.46

Average hours of use per day was calculated for each type of light bulb by compiling the daily usage values for each individual light bulb of the given type. These daily usage values for all light bulbs in bedrooms were based on estimates given by each room’s tenants; our group’s first-hand observations allowed us to estimate daily light bulb usage in all common areas. Using our data, we calculated the annual energy usage (consumption) for each type of bulb using Equation (1), shown below. Finally,

assuming the electricity price is \$0.145 per Kilowatt-hour (KWh), the average price of electricity in Massachusetts<sup>10</sup>, we calculated the annual energy cost of each type of light bulb used at FIJI (See Equation (2)).

**Equation (1):**

$$AEC = P * n * ADU * 365 \text{ days/year}$$

**Equation (2):**

$$ECY = \$0.145/\text{KWh} * AEC$$

*AEC = Annual Energy Consumption (kWh)*

*P = Power Output (kW)*

*n = number of bulbs*

*ADU = Average Daily Usage (hrs)*

*ECY = Energy Cost per Year (\$)*

Our group was able to conduct supplemental interviews with each of the two house managers at FIJI in order to evaluate our findings for consistency. Both managers confirmed our data, including bulb types and energy use, to be quite typical for the building. Once we assessed and established the current lighting situation at Phi Gamma Delta, our next task was to calculate the potential costs and benefits involved in replacing all traditional light bulbs with equivalent LED bulbs. In order to do this, it was necessary for us to research different LED products and determine the bulbs that most nearly replicated the light quality and intensity of the bulbs currently being used in the house. Table 2 shows the specifications for the proper replacement LED bulb for each of the bulbs currently being used by FIJI. The costs and specifications of the bulbs were identified using online retailers including Amazon, Sears, and Home Depot (2014). Once again, Equations (1) and (2) were used to project the annual energy usage and energy cost for each LED replacement bulb type.

*Table 2 LED Lights replacing traditional light forms*

Original Bulb Type	Bulb Cost		LED Replacement Bulb	LED Bulb Cost	Bulb Lifespan (h)	Lumen Output	Energy use/yr (KWh)	Energy cost/yr
14w CFL - Ecosmart	\$2.70	==>	10.5w LED - Philips	\$10.00	20000	800	3265.29	\$473.47
32w Linear Fluorescent - Phillips T8	\$13.00	==>	18w Green Creative T8 Ultra LED	\$38.00	50000	2000	18763.92	\$2,720.77
100w incandescent - GE	\$2.50	==>	19w Philips A21	\$24.00	25000	1600	1101.064615	\$159.65

### 3.4 Survey Results

Table 6 displays the results from the survey distributed to the WPI community. The answers for each question that received the most responses are highlighted.

## Survey Results

**Total Respondents: 367**

This survey contains seven questions and will take approximately five minutes to complete. Please answer truthfully and to the best of your abilities. The survey results will be anonymous, so please do not include your name anywhere on this survey. Choose the best choice, **0** through **5**; **0**=Not at all, **5**=Very.

**1. How familiar are you with recent increases in the design and consumer adoption of energy efficient technology?**

Answer	Responses	Percentage
0	18	5%
1	43	12%
2	54	15%
3	113	31%
4	100	27%
5	39	11%

**2. How knowledgeable are you about traditional types of lighting technology used in everyday life (incandescent, fluorescent, etc.)?**

Answer	Responses	Percentage
0	8	2%
1	24	7%
2	49	13%
3	119	32%
4	109	30%
5	58	16%

**3. In general, how familiar are you with newer types of energy-efficient lighting (CFL, LED, etc.)?**

Answer	Responses	Percentage
0	10	3%
1	27	7%
2	57	16%
3	127	35%
4	95	26%
5	51	14%

**4. How familiar are you with the applications of LED lighting in today's world?**

Answer	Responses	Percentage
0	7	2%
1	27	7%
2	69	19%
3	96	26%

4	117	32%
5	51	14%

**5. How familiar are you with the energy and cost saving potential of using LED light bulbs in place of traditional bulbs?**

Answer	Responses	Percentage
0	7	2%
1	22	6%
2	41	11%
3	62	17%
4	119	32%
5	116	32%

**6. How likely are you to choose an LED light bulb over traditional incandescent or compact fluorescent bulbs?**

Answer	Responses	Percentage
0	13	4%
1	22	6%
2	45	12%
3	93	25%
4	107	29%
5	87	24%

**7. How important is each of the following factors to you personally when choosing which type of lighting to use in your residence (Choose the best choice, 0 through 5; 0=not important at all, 5=most important):**

#	Factors	0	1	2	3	4	5	Total Responses	Mean
1	Initial Cost	4	17	50	98	111	85	365	4.51
	Percentage	1%	5%	14%	27%	30%	23%		
2	Quality of light produced (Brightness, color, light distribution)	1	0	9	49	142	165	366	5.26
	Percentage	0%	0%	2%	13%	39%	45%		
3	Energy Usage (Potential savings on energy bill)	5	10	19	72	131	128	365	4.91
	Percentage	1%	3%	5%	20%	36%	35%		
4	Lifespan	0	8	18	57	131	152	366	5.1
	Percentage	0%	2%	5%	16%	36%	42%		
5	Physical appearance of bulb (size, shape)	69	87	77	68	42	20	363	2.96
	Percentage	19%	24%	21%	19%	12%	6%		
6	Features (Dimmability, etc.)	22	40	86	102	74	39	363	3.78
	Percentage	6%	11%	24%	28%	20%	11%		
7	In-Store Availability (Product placement, shelf space)	25	36	68	93	85	58	365	3.96
	Percentage	7%	10%	19%	25%	23%	16%		
8	Product advertisements	131	87	85	39	15	7	364	2.29
	Percentage	36%	24%	23%	11%	4%	2%		

Table 3 Survey Results

## 4.0 Discussion

### 4.1 Literature Review

#### 4.1.1 Brief History of Lighting

Life has revolved around light since the beginning of time. The power to control and emit light has been a struggle for humans for over 10,000 years ago since the first fire starting kits were created in the Neolithic Period.<sup>17</sup> Since then light sources have grown and expanded as all of society and technology has. Oil and gas lamp use spanned from 2600 B.C to the late nineteenth century. In 1800 it was confirmed that electricity was able to emit visible light by an arc between two electrical rods. It was not until a consistent source of energy generation, electromagnetic induction, that this visible arc of electricity was harnessed into arc lights. This arc lighting was adopted by lighthouses, roadways, stadiums and halls but were too bright for residential use.<sup>17</sup>

Thomas Edison was the first inventor to design and manufacture lighting systems for businesses and home use in 1881. The incandescent lighting system was a relatively new technology but under Edison's research by 1882 more than 30,000 incandescent lamps were being used in factories and homes. This sparked even more interest in the lighting industry leading to a swarm of new technologies and advances. Fluorescent light bulbs were the next major development in lighting. These light systems were mastered by one of Edison's former employees, Daniel Moore, and brought to market in 1904. Although more expensive to create, fluorescent lighting allows for 75-80 percent more efficiency creating more light and less heat.<sup>17</sup>

It was not until 1962 that an innovative new form of lighting was discovered. Light emitting diodes, or LED's, were first developed when a GE engineer when photons were released from a metal diode after being exposed to electricity. The visible light emitted from the diodes could originally only be produced as yellow and red light and it was not until the 1990's that new methods were developed that would allow LED's to deliver white light. White light production has allowed LED's to break into the consumer markets and challenge the traditional light sources.<sup>17</sup>

#### 4.1.2 Mechanisms of Incandescent Lighting

Incandescent bulbs were the most widely used light source for decades because of the developments made by Thomas Edison. The screw in bulb was adopted as an industry standard over other developing lighting bulb styles.<sup>18</sup> Compared to other light sources today incandescent bulbs are very simple and thus manufactured at low costs.

Incandescent bulbs emit white light as an electric current runs through a tungsten filament. As the electric current passes through the filament, the filament temperature begins to rise. Tungsten has an abnormally high melting point (3,422 degrees Celsius) allowing the filament to heat to the point where it glows and emits light. The electricity that heats each filament originates from the foot contact at the base of a bulb and attaches to the filament at each end.<sup>18</sup>

Every incandescent bulb is vacuum sealed in order to prevent combustion. With the tungsten filament reaching temperatures up to 3,000 degrees any presence of oxygen can produce negative effects. As these high temperatures are reached excited atoms will detach from the tungsten filament and begin to collect in the casing of the bulb. Over time this leads to a dimmer light and a dark coating around the bulb. In modern incandescent bulbs the case is filled with inert gas to prevent this from happening. As these small filament particles evaporate off of the tungsten they will be deflected back towards its original place. Filament particles rejoin as they come together with the filament extending the lifetime and brightness of the bulb.

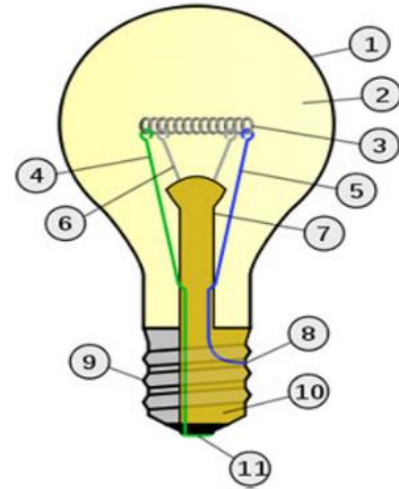

Diagram showing the major parts of a modern incandescent light bulb.

1. Glass bulb
2. Inert gas
3. Tungsten filament
4. Contact wire (goes to foot)
5. Contact wire (goes to base)
6. Support wires
7. Glass mount/support
8. Base contact wire
9. Screw threads
10. Insulation
11. Electrical foot contact

Figure 5 . Breakdown of Incandescent Bulb<sup>19</sup>

#### 4.1.3 Mechanisms of Fluorescent Lights

Fluorescent lighting does not use a metal filament to emit light like incandescent bulbs but rather a reaction between gaseous materials. These bulbs are made up of large discharge tubes whose interior walls are coated in phosphorous. Each tube is filled with argon and a small amount of mercury vapor. At each end of the tubes are electrodes to supply an electric current throughout the bulb and a seal to maintain a low pressure. As electricity runs into the electrodes, the tubes are preheated and a rapid conduction of electrons begins between the two ends.<sup>20</sup> The introduction of free electrons ionize the argon gas and both free electrons and ionized argon travel rapidly through the tubes. As these rapidly moving particles make their way around tube the mercury vapor experiences an electron jump eventually returning to its original form. When the electron falls back to its original level, energy is released in the form ultraviolet photons.<sup>20</sup>

Because ultraviolet photons are not visible to the human eye, in order to create white light the phosphorous coating is added. The photons emitted by the mercury excite the electrons of the phosphorous causing a second electron jump to occur. When the phosphorous atoms return to their normal state, energy is then emitted as a visible light photon. The ballast located at the base of the bulb controls the flow of alternating current through a tube. If the ballast is unable to properly control the alternating current and the level of current reaches an abnormally high level, the tubes will burst and shatter.<sup>20</sup>

#### 4.1.4 Mechanisms of LED Lights

Light Emitting diodes provide much differently than incandescent or fluorescent lighting. Rather than generating light through a filament, plasma or gas, LED's utilize a semiconductor to emit photons. These

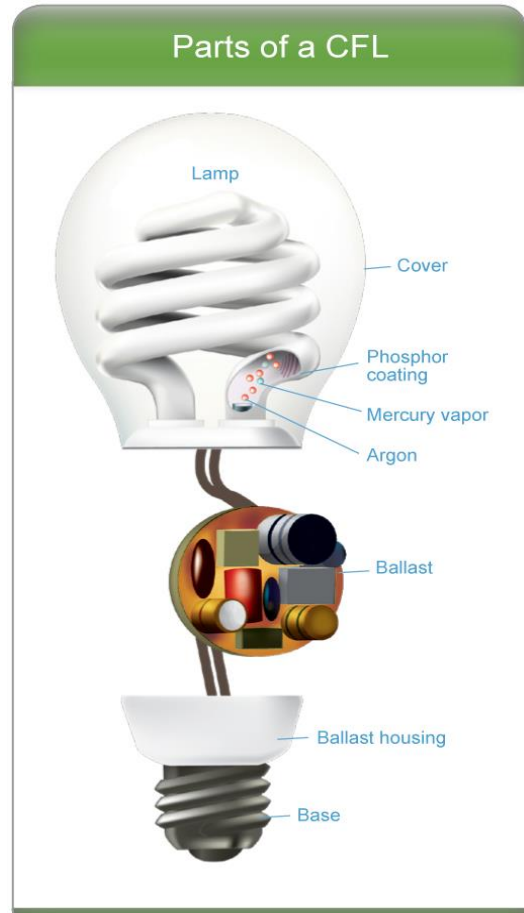

Figure 6 Breakdown of Fluorescent bulb<sup>21</sup>

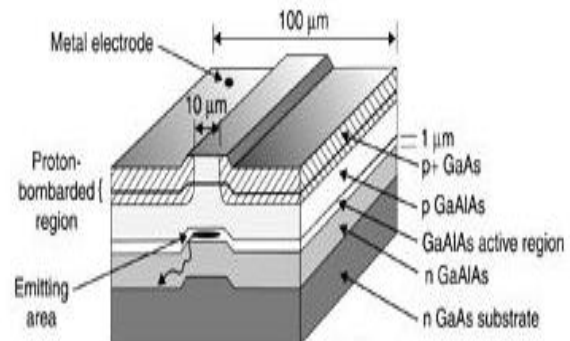

Figure 7 Composition of LED Semiconductor<sup>22</sup>

semiconductors consist of different element combinations of gallium, aluminum, arsenide, indium and phosphide. The precise differences in the composition of semiconductors leads to different wavelengths of light and therefore changing the color of the light emitted.<sup>23</sup> Figure 7 is an example of a common composition found in LED semiconductors that emit red light. In order to produce white light the red, green and blue LED chips are combined into a single series, allowing for all different spectrums of white light to be emitted all depending upon the ratios of each color. A second method used to emit white light utilizes LED's that emit UV light very similar to fluorescent lighting. These diodes are encased in a bulb coated in phosphorous. When the UV light photons created by the diode react with the phosphorous coating white light is emitted.<sup>24</sup>

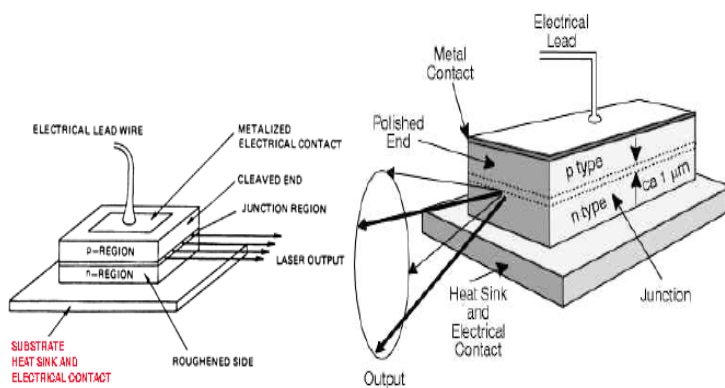

Figure 9 Sketch of Semiconductor laser light<sup>22</sup>

These semiconductor chips are doped to produce a diode with a positive and negative junction. This junction is located in the middle of the semiconductor where the positive and negative type layers meet. The p-type material is positively charged leaving holes for electrons to join on too. On

the other side of the semiconductor is the n-type material that contains extra electrons making in negatively charged. In its resting state, the materials in the diode are separated by the p-n junction when the N-type materials joining onto the p-type forming a depletion zone. When an electric current is added to the diode, current flows freely from the p-type region to the n-type. The current flowing through the diode drives electrons and p-type material through the junction point, forming an active region.

In the active region the holes of the holes of the p-type material combines with the surrounding free electrons, causing the p-type material to fall into a lower energy level. Transition to a lower level energy causes energy to be released in the form of a photon or light. Production of light through a solid state process such as this is called electroluminescence.<sup>25</sup> This process is illustrated in figure 8 which shows the reaction process in a simple LED laser light.

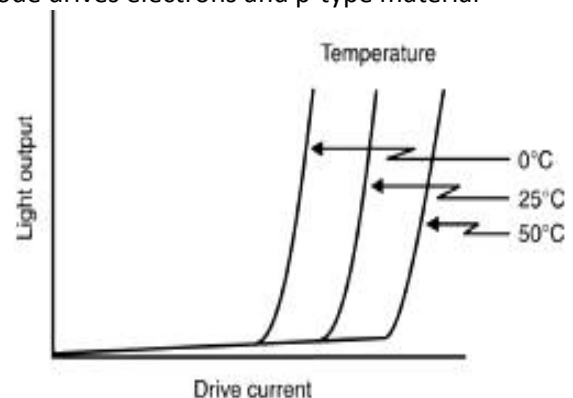

Figure 8 Sketch of output for typical laser diode as a function of drive current for three separate temps.<sup>22</sup>



This process is not one hundred percent efficient in creating light photons and therefore the energy that is not released as light photons turns into heat. As seen in Figure 5 when the temperature of a diode is increased the amount of current required to produce a given light output is increased. To prevent this from happening a heat-sink slug is commonly placed underneath the semiconductor chip. This device allows heat to quickly and efficiently travel away from the diode keeping the temperature stable.<sup>22</sup> LED bulbs do not require any gaseous materials and are covered with a clear plastic lens. Figure 10 breaks down the components of a basic LED light bulb.

#### 4.1.5 Current Trends in the lighting and LED market

Many of the trends that are affecting today's commercial lighting sector are being influenced by the national government. In December of 2011 a Presidential Memorandum was released regarding the implementation of energy savings projects and performance-based contracting for energy savings. In the memorandum the president stated "Upgrading the energy performance of buildings is one of the fastest and most

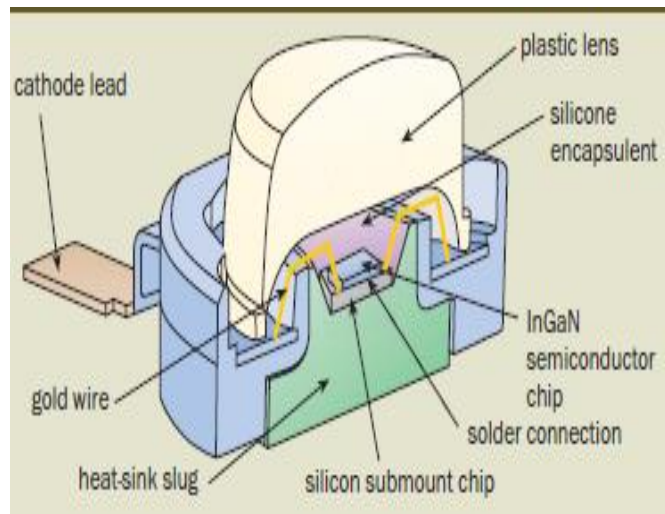

Figure 10. Breakdown of components in a LED light bulb

effective ways to reduce energy costs, cut pollution, and create jobs in the construction and energy sectors."<sup>26</sup> In February of 2012 President Obama announced the Better Building Initiative devoted to making the industrial and commercial sector 20% more energy efficient over the span of the next ten years. He also wanted to accelerate the private sector investment in energy efficiency.<sup>27</sup> This initiative would incorporate strategies of better access of information, workforce training and having the federal government lead by example. The Better Building Alliance was also formed to have organizations share their experiences and savings while also committing to energy efficiency. Currently the alliance has over 200 commercial sector members who represent over 9 billion commercial square feet of building.<sup>28</sup>

The government’s advocacy of energy efficiency also led to new regulations of common light sources sold in the US outlined in the Energy Independence and Security Act. As of January 1, 2012 new lighting standards were implemented that would continue to be phased in throughout 2014. New government regulations now require light sources to consume less energy dependent upon the amount of lumens the bulb produces. Traditional 100W, 60W and 40 W incandescent lights, known for their low prices, will not meet these new requirements. The goal of these new regulations is to reduce the amount of energy common light sources use by 25%-80%.<sup>29</sup> This will not totally phase out incandescent lights but will make way for more expensive and energy efficient incandescent. Figure 11 shows the current standards of incandescent lights and the new regulations along with the date.

**CLEAR, FROSTED AND SOFT WHITE GENERAL SERVICE INCANDESCENT LIGHT BULBS**

Current Wattage	Lumen Range	New Max Wattage	Minimum Lifetime	Effective Dates
100	1490-2600	72	1,000 hours	1/1/2012
75	1050-1489	53	1,000 hours	1/1/2013
60	750-1049	43	1,000 hours	1/1/2014
40	310-749	29	1,000 hours	1/1/2014

Figure 11 Newly Enforced Government Standards for Incandescent Lightin<sup>30</sup>

With the higher efficiency standards being implemented there is an opening in the market fluorescent and LED lighting. Figure 12 shows the advancements in technology of all common lighting sources. Fluorescent lighting has been around since 1938 and made many initial advancement in the technology but has plateaued in the past decades. Recent advancement in fluorescent lighting have been minimal, focusing mainly on reducing the hazardous materials that are used in production. At the moment fluorescent lighting is very much in the maturity stage of the product life cycle.

LED lights are very much in the early stages of the product life cycle and have been rapidly increasing in technology. In 2008 LED lights have similar energy consumption levels as CFL’s which is one quarter that of incandescent lights.

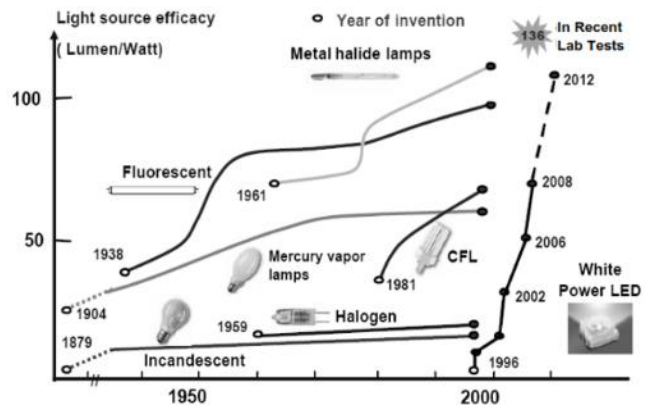

Figure 12 Advancements of different lighting technologies

## 4.2 Market Analysis

Our team's in-depth market analysis (displayed in Results section 3.1) encompassed the entire commercial market for lighting, of which LED products make up merely a tiny fraction. Commercial buildings account for nearly 20% of the United States' total energy consumption, and lighting accounts for 40% of the electricity consumed by these buildings. It is evident that the commercial lighting market is extremely large. Any market of this size presents a significant level of opportunity for companies with innovative products to enter into the market and gain a momentous market share.

LED products have achieved very limited market penetration in commercial lighting at this point in time. As of 2010, LED bulbs were virtually nonexistent in commercial buildings, with the exception of small LED exit sign bulbs. In 2010, linear fluorescent bulbs controlled an 80% share of the commercial lighting market, compact fluorescent bulbs accounted for 10%, and LED lighting represented a mere 1.8% market share. However, in 2012, a market research report by Pike Research predicted LEDs to capture more than 50 percent of the commercial lighting market by 2021. This means there is expected to be an immense amount of growth in LED lighting sales in the commercial market over the next seven years, and there is a significant opportunity for businesses to enter this rapidly growing market.

Developments in LED lighting technology have allowed companies to begin selling their LED products at more affordable prices. The technology is still relatively new, and will continue to develop for years to come. As LED lighting products are advanced, their cost will inevitably decrease, diminishing one of LED lighting's main barriers to entry, their high initial cost. As the price of these bulbs decreases and LED technology advances further, the energy savings these bulbs provide will become more and more apparent, increasing the chances of LED lighting advancing through the product life-cycle past the introduction phase and through the growth phase towards maturity.

## 4.3 Cost Benefit Analysis: LED vs. Incandescent, CFL, Linear Fluorescent

The results of our general cost benefit analysis, which examined incandescent, compact fluorescent, linear fluorescent, and LED bulbs, allowed us the ability to compare the financial costs and benefits of each bulb. The results section of our analysis allowed us to make two different comparisons. First, we compared the costs and benefits of three standard bulbs, the 60-watt incandescent bulb, the 14-watt compact fluorescent bulb, and the 10.5-watt LED bulb, which have equivalent light outputs to one another. Second, we compared two different types of tube lighting; a traditional 32-watt T8 linear fluorescent bulb and a newer 18-watt T8 linear LED bulb.

#### 4.3.1 Standard Bulb Comparison: Incandescent, CFL, LED

The first three bulbs our team selected for comparison all have equivalent light outputs (~800 lumens) and comparable light quality and floor area coverage. The most apparent difference between the three bulbs is the amount of power each requires to produce light. The incandescent bulb we examined requires 60 watts of power to run, while the compact fluorescent bulb requires 14 watts, and the LED bulb runs on 10.5 watts of power. Obviously, the incandescent bulb is much less energy-efficient than the other two bulbs. The CFL bulb is much more efficient than the incandescent, but still less efficient than the LED bulb. The lifespan of the incandescent is a mere 1,200 hours, compared to the CFL which lasts 10,000 hours, and the LED which lasts 20,000 hours. It would take eight incandescent bulbs to last the lifetime of one CFL bulb and nearly seventeen incandescent bulbs to last the lifetime of one LED bulb. The retail prices of the incandescent, CFL, and LED bulbs are, respectively, \$1, \$4, and \$10. Our team calculated the total cost of purchasing and using (electricity cost) the amount of each type of bulb required to last in a commercial setting for fifteen years (49,500 hours of use). 42 incandescent bulbs would need to be purchased and used in succession to last for fifteen years, costing a total of \$351.96. Five CFL bulbs would be necessary to last fifteen years, with a total cost of \$91.25. Two and a half LED bulbs would need to be purchased and used every fifteen years, carrying a total cost of \$78.81. From these figures alone it is obvious that, in the long term, using the incandescent light bulb is highly inefficient and costly compared to using the CFL and the LED bulbs. Over a long period of time (fifteen years), the LED bulb is the least expensive to use and most efficient of the three bulbs we compared.

Next, we considered the quantity of each type of bulb that commercial buildings actually use. At any given time, a commercial building uses an average of fourteen incandescent bulbs and 39 CFL bulbs. This is evident of the recent phasing-out of incandescent bulbs and an overwhelming shift toward the use of CFL bulbs. Considering the obvious inefficiency and declining use of the incandescent bulb in commercial buildings, our team was able to rule out this bulb as a viable option for commercial lighting. The bulb uses an overwhelming amount of energy and is far more expensive to use for a long period of time than either the CFL or the LED bulb.

After ruling out the 60-watt incandescent bulb as a viable option, our group further compared the costs associated with using the CFL and LED bulbs. The total cost of purchasing and running 39 CFL light bulbs (average for a commercial building) simultaneously for a fifteen year period (49,500 hours of use) would be \$3578.25. If the building were to use 39 LED bulbs in place of the CFLs, the fifteen year total cost would be \$3073.69. Therefore, we surmised that the average commercial building would save

about \$500 over a fifteen year period by using 10.5-watt LED bulbs in place of all 14-watt CFL bulbs. These savings alone are not especially substantial, and offer a relatively small incentive for the average business to use LED bulbs in place of CFL or incandescent bulbs. CFL bulbs contain mercury, creating disposal risks and costs. This is not the case for LED bulbs. Another disadvantage of CFL bulbs is their incompatibility with dimmer switches. Societal trends favoring environmentally friendly and energy-efficient practices by businesses provides a social incentive for businesses to use LED lighting to maximize energy-efficiency. LED light bulbs offer a clear cost advantage compared to traditional CFL bulbs and a significant social incentive for a business to become more sustainable.

#### 4.3.2 Tube Lighting Comparison – T8 Linear Fluorescent, T8 Linear LED

Our team compared two types of T8 linear tube light bulb, linear fluorescent and LED. The 32-watt T8 linear fluorescent bulb has a 20,000 hour lifespan and costs \$13. The 18-watt T8 linear LED bulb, which has an equivalent light output to that of the linear fluorescent, has a 50,000 hour lifespan and costs \$38. Two and a half linear fluorescent bulbs would be necessary to last the lifespan of the LED bulb. As explained in our results section, the average commercial building uses 301 linear fluorescent tube light bulbs at one time. Our team calculated the total cost of purchasing and running (electricity cost) 301 linear fluorescent bulbs at time for fifteen years, \$59,146.50. The calculated cost of purchasing and using the linear LED bulbs in place of these linear fluorescents would be \$39,205.25. Therefore, we concluded that the average commercial building would save about \$20,000 over a fifteen year period using T8 linear tube lighting in place of traditional T8 linear fluorescent tube lighting. This cost advantage is rather significant, offering businesses an economic incentive to switch to LED tube lighting. Coupled with the social incentives that exist for a business to become more energy-efficient and sustainable, our team believes LED tube lighting offers a great deal of benefit over traditional linear fluorescent lighting.

#### 4.4 Cost Benefit Analysis - Phi Gamma Delta Fraternity House

Replacing each of the three types of light bulbs currently used at FIJ with equivalent LED light bulbs would effectively decrease the energy required to light the building, leading to electric bill savings over time. From Table 3 below, one can see the significant potential for savings using LED light bulbs in place of traditional Compact-Fluorescent, Linear Fluorescent, and Incandescent lighting.

*Table 4 Cost of LED Lighting*

Original Bulb Type	Energy cost/yr	LED Replacement Bulb	LED Bulb Cost	Energy cost/yr	Energy bill savings/yr	Initial Cost of LEDs
14w CFL - Ecosmart	\$631.29	10.5w LED - Philips	\$10.00	\$473.47	\$157.82	\$490.00
32w Linear Fluorescent - Phillips T8	\$4,836.92	18w Green Creative T8 Ultra LED RF Tube	\$38.00	\$2,720.77	\$2,116.15	\$4,522.00
100wIncandescent - GE	\$840.29	19w Philips A21 LED	\$24.00	\$159.65	\$680.63	\$288.00
				<b>Total:</b>	<b>\$2,954.61</b>	<b>\$5,300.00</b>

If all traditional light bulbs in FIJI were replaced with the given LED equivalent bulbs, the organization would save approximately \$2,954.61 annually on its energy bill, assuming usage habits continue. The initial cost of all of the LED replacement bulbs, shown above, is \$5,300. In addition to this one-time initial cost, we considered the cost of replacing bulbs that burn out.

*Table 5 Replacement costs of LED light bulbs*

Original Bulb Type	Bulb Lifespan(h)	Total hrs of use/year	Replacement bulbs required/year	Bulb replacement cost/year
14w CFL - Ecosmart	10000	310980.00	31.10	\$83.96
32w Linear Fluorescent - Phillips T8	20000	755237.14	37.76	\$490.90
100w Incandescent - GE	1000	76158.37	76.16	\$190.40
			<b>Total:</b>	<b>\$765.26</b>
LED Replacement Bulb	LED Lifespan (h)	Total hrs of use/year	Replacement bulbs required/year	Bulb replacement cost/year
10.5w LED - Philips	20000	310980.00	15.55	\$155.49
18w Green Creative T8 Ultra LED RF	50000	755237.14	15.10	\$573.98
19w Philips A21 LED	25000	76158.37	3.05	\$73.11
			<b>Total:</b>	<b>\$802.58</b>

One will notice from the tables presented above that the LED replacement bulbs all have significantly longer life expectancies than their traditional counterparts. In order to calculate the total hours of use per year for each type of light bulb, our team multiplied the average daily usage (hours) by 365 days per year to find the average yearly usage for each individual bulb, and multiplied this by the quantity of the given type of bulb currently in use at FIJI. After finding the total hours of use per year for each bulb type, we divided each of these values by the bulb's respective lifespan in order to calculate the average number of replacement bulbs of each type FIJI will be required to purchase per year. The number of replacement bulbs was then multiplied by the cost of the given bulb to determine the average cost each year to replace bulbs of a given type. Looking at the resulting total bulb replacement costs, on average, it would cost \$802.58 to replace dead LED bulbs each year, compared to \$765.26 to replace the original light bulbs that burn out.

Table 6 Total annual cost of bulbs

Original Bulb Type	Energy cost/yr	Bulb replacement cost/year	Total cost/year
14w CFL - Ecosmart	\$631.29	\$83.96	\$715.25
32w Linear Fluorescent -	\$4,836.92	\$490.90	\$5,327.83
100w Incandescent - GE	\$840.29	\$190.40	\$1,030.68
	\$6,308.50	\$765.26	<b>\$7,073.76</b>
LED Replacement Bulb	Energy cost/yr	Bulb replacement cost/year	Total cost/year
10.5w LED - Philips	\$473.47	\$155.49	\$628.96
18w Green Creative T8 U	\$2,720.77	\$573.98	\$3,294.75
19w Philips A21 LED	\$159.65	\$73.11	\$232.77
	\$3,353.89	\$802.58	<b>\$4,156.47</b>

Table 5 compares the total annual cost of using each type of bulb, which includes the average annual energy cost and the average cost of replacing dead bulbs each year. The total yearly cost to use the bulbs currently in place at FIJI is \$7,073.76, while the total yearly cost to use the LED replacement bulbs would only be \$4,156.47. Taking into account the initial cost of the LED replacement bulbs and the total yearly cost of use for each set of bulbs, the Table 6 below shows the potential savings over time of switching to the LED bulbs.

Table 7 Potential Cost Savings of LED bulbs

	Initial Cost	Total Cost/Yr	One-Year Savings w/ LEDs	Break Even Point (Years)	5-Year Savings w/ LEDs
Original Bulbs	\$0.00	\$7,073.76	<b>-\$2,382.71</b>	<b>1.82</b>	<b>\$9,286.45</b>
LED Replacement Bulbs	\$5,300.00	\$4,156.47			

The break-even point describes the time required for an initial investment to pay for itself in terms of the savings it provides. Table 6 shows the break-even point, 1.82 years, for the investment in LED light bulbs for FIJI. Five years following a potential switch to LED light bulbs, our team calculated that FIJI would have saved a total of \$9,286.45.

Analyzing the results of our cost benefit analysis of the potential decision of the Phi Gamma Delta (FIJI) Fraternity House at WPI to replace all of its current lighting with alternative LED bulbs with equivalent outputs, our team has found significant benefits for this potential decision.

First, our team considered the initial cost of purchasing all the LED bulbs necessary to replace the existing bulbs, \$5,300. Next, our team considered the yearly energy cost of the lighting currently in place at FIJI, \$6,305.80, and the would-be yearly energy cost of using LED replacement bulbs, \$3,353.89. Replacing all existing light bulbs at FIJI with LEDs would offer the house about \$3,000 in savings every year on its electric bill. Our team then compared the average yearly cost to replace the current light

bulbs, \$765.26, with the potential average yearly cost to replace LED bulbs, \$802.58. These costs are fairly similar, as the high initial cost of the LED bulbs is counteracted by their much longer lifespan.

Our team calculated the total yearly cost of using the bulbs already in place, \$7,073.76, by factoring in the average yearly energy cost and the average yearly bulb replacement cost. The total yearly cost of using and replacing LED bulbs would be \$4,156.47, in addition to the one-time initial cost of purchasing all necessary replacement bulbs, \$5,300. The total potential cost savings of switching over to LED lighting amounts to about \$2,900. One year after installing the LED replacement bulbs, the net savings will from the switch would be approximately -\$2,300, meaning the initial cost of the new bulbs would not be fully recovered in the first year. Our team calculated the break-even point for this investment, 1.8 years, the amount of time it would take for the house to recover its initial investment in full. Therefore, FIJI would begin experiencing a positive return-on-investment (ROI) 1.8 years after replacing all currently existing light bulbs with LED bulbs. Two years after the initial investment, net savings would amount to \$500. Each year following this point, assuming energy usage remains constant, FIJI would experience an additional \$2,900 in net savings (positive ROI).

Since there are approximately 30 residents living in the house at any given time, the initial cost of this investment would be about \$175 per resident. Since house bills are paid annually, we factored in the potential energy savings for the first year to find the amount each individual's house bill would increase for the first year following the initial investment, \$75. Typically, each brother's house bill amounts to approximately \$9,000 per year. Therefore, the percent increase in each brother's house bill for year one following the initial investment would only be .8%. The cost of this investment to each brother living in the house during the first year is very minimal. The only residents who would not experience positive returns on their investment are those who will not live in the house during year two of using the LED bulbs. Their \$75 investment would be considered a loss. On the other hand, the vast majority of residents in living in the house during year one will live there for one or two more years, meaning that they would all experience net savings on their house bills due to the switchover to LED lighting. Additionally, the annual house bills of all individuals who begin living in the house after year two of the LED switchover would amount to \$100 less (~1% increase) than they would have if the original light bulbs were still in use.

The break-even point we calculated (1.8 years) would take place in the very near and foreseeable future, and the potential ROI after this point would be fairly substantial. The cost savings each brother would see over time, although not excessive, are significant. Aside from the initial



investment, there are virtually no additional costs (monetary or intangible) associated with switching to LED lighting. There would also be the added benefits of increased energy efficiency and environmental sustainability. Our team’s cost-benefit analysis regarding the potential decision for FIJI to replace all existing light bulbs with equivalent LED bulbs has provided us with strong quantitative data to support this decision.

#### 4.5 Survey Discussion Table

This table displays each question number of the survey in order, along with a brief description of the topic covered in that question. The results are shown for each question alongside corresponding discussion points that were drawn from the conclusion of the survey. The population used for the survey was the Worcester Polytechnic Institute graduate and undergraduate student body. Due to the engineering and technical background of its students, respondents may be considered more sophisticated on this subject compared to the general public.

*Table 8 Survey Discussion Table*

Question	Topic	Result	Discussion
Q1.	Knowledge of increases in design and consumer adoption of energy efficient technology.	0 (not at all): 5% 1: 12% 2: 15% 3: 31% 4: 27% 5 (very): 11%	Only 11% of people felt they were very knowledgeable about the increases in energy efficient technologies and consumer adoption of these product. And on the other end of the spectrum 5% felt they had very little knowledge on the subject. People appear to be unsure, in the middle, when asked the question. Without education about these technologies consumers are unaware about their benefits and therefore are less likely to be accepting of the products.
Q2.	Knowledge of traditional lighting sources.	0 (not at all): 2% 1: 7% 2: 13% 3: 32% 4: 30% 5 (very): 16%	Our respondents are familiar with the traditional lighting sources but only 16% felt they were very knowledgeable on the topic. Majority of individuals are moderately to not very educated on this topic. This can translate to consumers making uneducated purchasing decisions and keeping with traditional lighting.
Q3.	Familiarity of new forms of energy efficient lighting.	0 (not at all):3% 1: 7% 2: 16% 3: 35% 4: 26% 5 (very): 14%	51% of respondents are moderately familiar with the new forms of energy efficient lighting, responding in the middle of not at all familiar and very familiar. Without consumers being aware of these new energy efficient lights it is unlikely there will be mass adoption of these new technologies, such as LED’s.
Q4.	Familiarity of LED lighting applications.	0 (not at all):2% 1: 7% 2: 19%	The majority of people are familiar with the applications of LED lighting in today’s market although only 14% of the respondents felt as though

		3: 26% 4: 32% 5 (very): 14%	they are very familiar. If consumers are more familiar with the multiple applications of LED lights there is a greater probability of sales rising.
Q5.	Knowledge of cost savings potential through the use of LED lights.	0 (not at all):2% 1: 6% 2: 11% 3: 17% 4: 32% 5 (very): 32%	Although being less aware of the applications of LED lighting people do seem to be educated on the cost savings potential that LED's offer. 64% of respondents feel they are very, or close to very, knowledgeable about this benefit of LED lights.
Q6.	Likelihood of choosing LED lights over incandescent or CFL bulbs.	0 (not at all):4% 1: 6% 2: 12% 3: 25% 4: 29% 5 (very): 24%	Majority of people favored towards purchasing LED light bulbs over other traditional lighting sources. Only 22% of respondents felt they would be less likely to purchase an Incandescent or CFL bulb over an LED light.
Q7.	Importance of factors when making a purchasing decision.	Rankings: 1:Quality of light 2:Lifespan 3:Energy Usage 4:Initial Cost 5:Availability 6:Features 7:Physical Appearance 8:Advertisements	The top three factors in a consumers purchasing choice are the quality of light, lifespan and energy usage. This bodes well LED lighting options as they are leaders in these areas across the lighting industry. Although the fourth most important factor, initial cost, fell very close behind the top three. With LED's being much higher priced than CFL's and incandescent lights this may be a major deterrent for consumers purchasing light bulbs. Availability of the bulbs also received high scores which may also be a major deterrent when making a purchasing decision. There are not as many LED lights available to purchase as other lights. The physical appearance, advertisements and features of the bulb are of much lower concern to consumers.

## 5.0 Conclusions and Recommendations

### 5.1 Conclusions

**1. LED lighting is presently approaching the end of the introduction phase and entering into the growth phase of the product-life cycle.**

Although LED lighting currently possesses only a small share of the commercial lighting market, this technology is becoming increasingly popular. LED lighting sales are projected to grow at an extremely high rate over the next decade, and a prosperous growth phase is inevitable for LED lighting in the commercial lighting market.

***2. LED lighting products are still relatively new products, and they have strong potential for continued technological advancement and innovation moving forward.***

LED lighting technology has been improving rapidly in recent years. Significant advancements in the energy efficiency, light quality, and lifespan of LED bulbs are expected to continue to occur for many years to come. These three factors were all identified in our survey as the three main factors that influence consumers to purchase a light bulb. Along with these advancements, the production costs, and therefore the retail prices, of LED lighting will inevitably decrease over time, as they have since these products were first introduced. We found the initial cost of light bulbs to be the fourth most important factor in the consumer decision to purchase a light bulb.

***3. LED lighting offers a plethora of benefits compared to traditional (Incandescent, CFL) and is highly feasible for widespread use in the commercial sector.***

LED light bulbs offer substantial advantages over their incandescent and compact-fluorescent counterparts. Despite the fact that the initial cost of LED bulbs is significantly higher than that of traditional types of lighting, the LED bulbs offer substantial energy savings and much longer lifespans. These savings allow the initial cost of LED lighting to be recovered fairly quickly, offering consumers a positive return on their investment. According to our survey results a large majority of consumers are willing to purchase LEDs over other traditional lighting. Our team concluded that, from the results of our theoretical and practical cost-benefit analyses, LED lighting is absolutely a viable option to replace traditional incandescent and CFL lighting in the commercial sector.

***4. Individuals are less knowledgeable about newer LED lights than they are when it comes to traditional light sources such as incandescent and fluorescent lights.***

The general public will not be familiar with new and emerging technologies and products. The majority of their knowledge will reside in products they have experience using or seeing used globally.

***5. The overwhelming majority of individuals are aware of the energy and cost saving potential LED lights offer.***

Since the introduction of LED lights they have been advertised as being more electrically efficient than other light sources and their major selling point.

## 5.2 Recommendations

- 1. Our team recommends that any business in the LED lighting market should educate its customers on all of the advantages LED products possess over competing products, not solely their potential energy savings.***
- 2. Our team recommends that any business attempting to penetrate the LED lighting market ensures their product is not only innovative but offered at a competitive price.***
- 3. Our team recommends that commercial businesses strongly consider switching from traditional lighting to LED lights.***
- 4. Our team recommends that the Phi Gamma Fraternity house at WPI replace all existing light bulbs with equivalent LED replacement bulbs.***

## 6.0 References

1. *Energy consumption*. (2013). Retrieved Oct 3, 2013, from [http://www.need.org/needpdf/infobook\\_activities/IntInfo/Consl.pdf](http://www.need.org/needpdf/infobook_activities/IntInfo/Consl.pdf)
2. U.S. Department of Energy. (2013). *Solid-state lighting*. Retrieved Oct 3, 2013, from [http://www1.eere.energy.gov/buildings/ssl/comparing\\_lighting.html](http://www1.eere.energy.gov/buildings/ssl/comparing_lighting.html)
3. U.S. Department of Energy. (2013). *Energy efficiency of LEDs*. Retrieved Oct 3, 2013, from [http://apps1.eere.energy.gov/buildings/publications/pdfs/ssl/led\\_energy\\_efficiency.pdf](http://apps1.eere.energy.gov/buildings/publications/pdfs/ssl/led_energy_efficiency.pdf)
4. *LED light bulbs: Comparison charts*. (2012). Retrieved October 3, 2013, from [http://eartheasy.com/live\\_led\\_bulbs\\_comparison.html](http://eartheasy.com/live_led_bulbs_comparison.html)
5. Navigant Consulting. (2012). *2010 U.S. lighting market characterization: U.S. Department of Energy*.
6. WinterGreen Research. (2013). *LED lighting: Markets at \$4.8 billion in 2012 reach \$42 billion by 2019: WinterGreen Research*.
7. IMS Research. (2012). *Succeeding in the global retail LED lamp market*
8. *Pike research: LEDs to capture 52% of commercial lighting by 2021*. (2013). Retrieved December 2, 2013, from <http://lighting.com/pike-research-leds/>
9. White, M. C. (2013). *Light switch: Why you'll start using LED bulbs this year*. *Time*
10. U.S. Energy Information Administration. (2013). *Electric power monthly*. Retrieved February 3, 2013, from [http://www.eia.gov/electricity/monthly/epm\\_table\\_grapher.cfm?t=epmt\\_5\\_6\\_a](http://www.eia.gov/electricity/monthly/epm_table_grapher.cfm?t=epmt_5_6_a)
11. Atkins, W. (2008, October 5). *Toxic mercury, fluorescent or incandescent bulbs. what's better?* *IT Wire*
12. Johnson, S. (2013). *What are the benefits of incandescent light bulbs?* Retrieved December 3, 2013, from [http://www.ehow.com/list\\_6584513\\_benefits-incandescent-light-bulbs\\_.html](http://www.ehow.com/list_6584513_benefits-incandescent-light-bulbs_.html)
13. Truini, J. (2012, November 27). *What you need to know about the lightbulb law*. *Popular Mechanics*
14. Philips 433227 10.5-watt slim style A19 LED light bulb, soft white. (2014). Retrieved February 12, 2014, from <http://www.amazon.com/Philips-433227-10-5-watt-Style-Dimmable/dp/B00I134ORI>
15. Philips 221549 - F17T8/TL950 straight T8 fluorescent tube light bulb. (2014). Retrieved February 21, 2014, from [http://www.amazon.com/Philips-221549-F17T8-Straight-Fluorescent/dp/B002CZ35HG/ref=pd\\_rhf\\_se\\_p\\_d\\_9](http://www.amazon.com/Philips-221549-F17T8-Straight-Fluorescent/dp/B002CZ35HG/ref=pd_rhf_se_p_d_9)
16. *Green creative titanium LED*. (2014). Retrieved February 15, 2014, from <http://earthled.com/products/green-creative-titanium-led-4-foot-t8-ultra-led-retrofit-tube-dlc-listed-led-t8>
17. David DiLaura, "A Brief History of Lighting," *Optics & Photonics News* **19**(9), 22-28 (2008) <http://www.opticsinfobase.org/opn/abstract.cfm?URI=opn-19-9-22>
18. Chen, K., & Murray, W. (May 1980). *Energy, incandescent lighting, and 100 years*. *Industry Applications, IEEE Transactions, IA-16*(3), 413-419.

19. *Bulbs.com. (2013). Incandescent bulbs. Retrieved 11/2/2013, 2013, from <http://www.bulbs.com/learning/incandescent.aspx>*
20. *Goldwasser, Sam. (2002). Fluorescent lamps, ballasts, and fixtures (service clinic). Poptronics, 3.12(December), pg. 49.*
21. *Superior Lighting. (2013). CFL components. Retrieved 10/20, 2013, from [http://www.superiorlighting.com/Compact Fluorescent Lamp Components s/2466.htm](http://www.superiorlighting.com/Compact_Fluorescent_Lamp_Components_s/2466.htm)*
22. *Gavryushin, V., & Zukauskas, A. (2006). Light-emitting diodes (LED). Retrieved 10/13/2013, 2013, from [http://www.pfk.ff.vu.lt/lectures/funkc\\_dariniai/diod/led.htm](http://www.pfk.ff.vu.lt/lectures/funkc_dariniai/diod/led.htm)*
23. *Nakamura, S., & Krames, M. R. (2013). History of Gallium–Nitride-based light-emitting diodes for illumination. Proceedings of the IEEE, 101(10), 2211-2200.*
24. *Dupuis, R., & Krames, M. (May 1,2008). History, development, and applications of high-brightness visible light-emitting diodes Journal of Lightwave Technology, 26(9), 11/13/2013-1154-1171.*
25. *The University of Wisconsin-Madison. (2008). Exploring the nano world. Retrieved 10/12/2013, 2013, from <http://www.education.mrsec.wisc.edu/background/LED/index.html>*
26. *Obama, Barack. (2011). Presidential memorandum -- implementation of energy savings projects and performance-based contracting for energy savings Office of the Press Secretary.*
27. *US Department of Energy. (2013). Better buildings progress report 2012. energy.gov: US DOE.*
28. *US Department of Energy. (2014). Better building alliance 2013 annual report (Annual Report. energy.gov: US DOE*
29. *Office of Energy Efficiency and Renewable Energy. (2014). Energy independence and security act. Retrieved 1/6, 2014, from <http://energy.gov/eere/femp/energy-independence-and-security-act>.*
30. *American Lighting Association. (2013). New U.S. Energy Efficiency Requirements. Retrieved 10/15/2013, 2013, from <http://www.americanlightingassoc.com/Lighting-Fundamentals/Light-Sources-Light-Bulbs/New-Incandescent-Light-Bulb-Requirements.aspx>*

## 7.0 Appendix

### 7.1 Survey Appendices

#### 7.1.1 Distributed survey and number of responses

Figure 13 is a copy of the online survey that was presented to willing survey candidates through Qualtrics survey provider. Below the survey is a screenshot of the number of respondents as given on the Qualtrics website.

**WPI**

**Introduction**  
This survey is designed to help our team gauge consumer opinions regarding the purchase and use of different types of lighting.

**Instructions**  
This survey contains seven questions and will take approximately five minutes to complete. Please answer truthfully and to the best of your abilities. The survey results will be anonymous, so please do not include your name anywhere on this survey.  
Choose the best choice, 0 through 5; 0=Not at all, 5=Very.

How familiar are you with recent increases in the design and consumer adoption of energy efficient technology?  
0 1 2 3 4 5

How knowledgeable are you about traditional types of lighting technology used in everyday life (incandescent, fluorescent, etc.)?  
0 1 2 3 4 5

In general, how familiar are you with newer types of energy-efficient lighting (CFL, LED, etc.)?  
0 1 2 3 4 5

How familiar are you with the applications of LED lighting in today's world?  
0 1 2 3 4 5

How familiar are you with the energy and cost saving potential of using LED light bulbs in place of traditional bulbs?  
0 1 2 3 4 5

How likely are you to choose an LED light bulb over traditional incandescent or compact fluorescent bulbs?  
0 1 2 3 4 5

How important is each of the following factors to you personally when choosing which type of lighting to use in your residence (Choose the best choice, 0 through 5, 0=not important at all, 5=most important):

	Click to write Column 1					
	0	1	2	3	4	5
Initial Cost	<input type="radio"/>	<input type="radio"/>	<input type="radio"/>	<input type="radio"/>	<input type="radio"/>	<input type="radio"/>
Quality of light produced (Brightness, color, light distribution)	<input type="radio"/>	<input type="radio"/>	<input type="radio"/>	<input type="radio"/>	<input type="radio"/>	<input type="radio"/>
Energy Usage (Potential savings on energy bill)	<input type="radio"/>	<input type="radio"/>	<input type="radio"/>	<input type="radio"/>	<input type="radio"/>	<input type="radio"/>
Lifespan	<input type="radio"/>	<input type="radio"/>	<input type="radio"/>	<input type="radio"/>	<input type="radio"/>	<input type="radio"/>
Physical appearance of bulb (size, shape)	<input type="radio"/>	<input type="radio"/>	<input type="radio"/>	<input type="radio"/>	<input type="radio"/>	<input type="radio"/>
Features (Dimmability, etc.)	<input type="radio"/>	<input type="radio"/>	<input type="radio"/>	<input type="radio"/>	<input type="radio"/>	<input type="radio"/>
In-Store Availability (Product placement, shelf space)	<input type="radio"/>	<input type="radio"/>	<input type="radio"/>	<input type="radio"/>	<input type="radio"/>	<input type="radio"/>
Product advertisements	<input type="radio"/>	<input type="radio"/>	<input type="radio"/>	<input type="radio"/>	<input type="radio"/>	<input type="radio"/>

Active Name Responses  
 LED Lighting 367  
Modified on Feb 17, 2014

Figure 13 Survey taken by Respondents

#### 7.1.2 Survey Results

Figure 14 displays the results of the survey along with the calculated statistics to the right of each question. The answers that received the highest percentage of responses are highlighted.

Figure 14 Survey Results with Statistical Analysis

<b>Survey Results</b>		
<b>1. How familiar are you with recent increases in the design and consumer adoption of energy efficient technology?</b>		
Answer	Responses	Percentage
0	18	5%
1	43	12%
2	54	15%
3	113	31%
4	100	27%
5	39	11%
<b>2. How knowledgeable are you about traditional types of lighting technology used in everyday life (incandescent, fluorescent, etc.)?</b>		
Answer	Responses	Percentage
0	8	2%
1	24	7%
2	49	13%
3	119	32%
4	109	30%
5	58	16%
<b>3. In general, how familiar are you with newer types of energy-efficient lighting (CFL, LED, etc.)?</b>		
Answer	Responses	Percentage
0	10	3%
1	27	7%
2	57	16%
3	127	35%
4	95	26%
5	51	14%
<b>4. How familiar are you with the applications of LED lighting in today's world?</b>		
Answer	Responses	Percentage
0	7	2%
1	27	7%

Statistic	Value
Min Value	1
Max Value	6
Mean	3.96
Variance	1.76
Standard Deviation	1.33
Total Responses	367

Statistic	Value
Min Value	1
Max Value	6
Mean	4.28
Variance	1.44
Standard Deviation	1.2
Total Responses	367

Statistic	Value
Min Value	1
Max Value	6
Mean	4.15
Variance	1.49
Standard Deviation	1.22
Total Responses	367

Statistic	Value
Min Value	1
Max Value	6



2	69	19%
3	96	26%
4	117	32%
5	51	14%

**5. How familiar are you with the energy and cost saving potential of using LED light bulbs in place of traditional bulbs?**

Answer	Responses	Percentage
0	7	2%
1	22	6%
2	41	11%
3	62	17%
4	119	32%
5	116	32%

**6. How likely are you to choose an LED light bulb over traditional incandescent or compact fluorescent bulbs?**

Answer	Responses	Percentage
0	13	4%
1	22	6%
2	45	12%
3	93	25%
4	107	29%
5	87	24%

Mean	4.2
Variance	1.49
Standard Deviation	1.22
Total Responses	367

Statistic	Value
Min Value	1
Max Value	6
Mean	4.67
Variance	1.67
Standard Deviation	1.29
Total Responses	367

Statistic	Value
Min Value	1
Max Value	6
Mean	4.42
Variance	1.75
Standard Deviation	1.32
Total Responses	367

**7. How important is each of the following factors to you personally when choosing which type of lighting to use in your residence (Choose the best choice, 0 through 5; 0=not important at all, 5=most important):**

Factor	0	1	2	3	4	5	Total Responses	Mean
Initial Cost	4	17	50	98	111	85	365	4.51
Quality of light produced (Brightness, color, light distribution)	1	0	9	49	142	165	366	5.26
Energy Usage (Potential savings on energy bill)	5	10	19	72	131	128	365	4.91
Lifespan	0	8	18	57	131	152	366	5.1
Physical appearance of bulb (size, shape)	69	87	77	68	42	20	363	2.96
Features (Dimmability, etc.)	22	40	86	102	74	39	363	3.78
In-Store Availability (Product placement, shelf space)	25	36	68	93	85	58	365	3.96
Product advertisements	131	87	85	39	15	7	364	2.29

Statistic	Initial Cost	Quality of light produced	Energy Usage (Potential savings)	Lifespan	Physical appearance of bulb	Features (Dimmability, etc.)	In-Store Availability (Product placement, shelf space)	Product advertisements
Min Value	1	1	1	2	1	1	1	1
Max Value	6	6	6	6	6	6	6	6
Mean	4.51	5.26	4.91	5.1	2.96	3.78	3.96	2.29
Variance	1.4	0.66	1.22	0.96	2.15	1.81	2.07	1.62
Standard Deviation	1.19	0.81	1.1	0.98	1.47	1.35	1.44	1.27
Total Responses	365	366	365	366	363	363	365	364

7.1.3 Graphs of Survey Questions

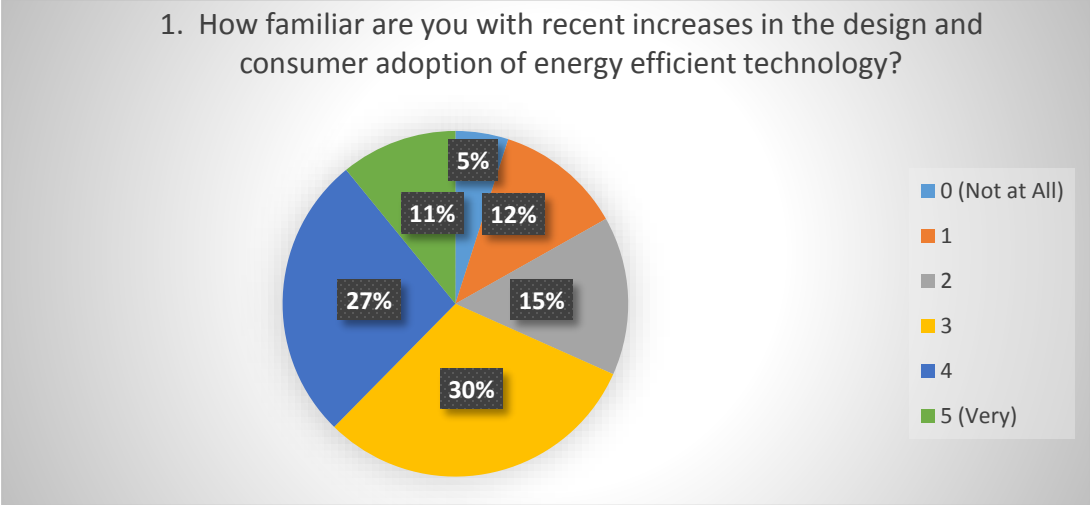

Figure 15 Pie Chart of answers from Survey Question 1

2. How knowledgeable are you about traditional types of lighting technology used in everyday life (incandescent, fluorescent, etc.)?

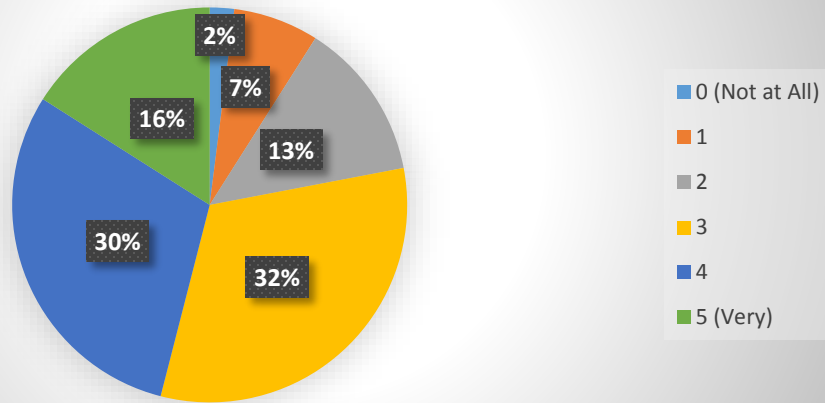

Figure 16 Pie Chart of answers from Survey Question 2

3. In general, how familiar are you with newer types of energy-efficient lighting (CFL, LED, etc.)?

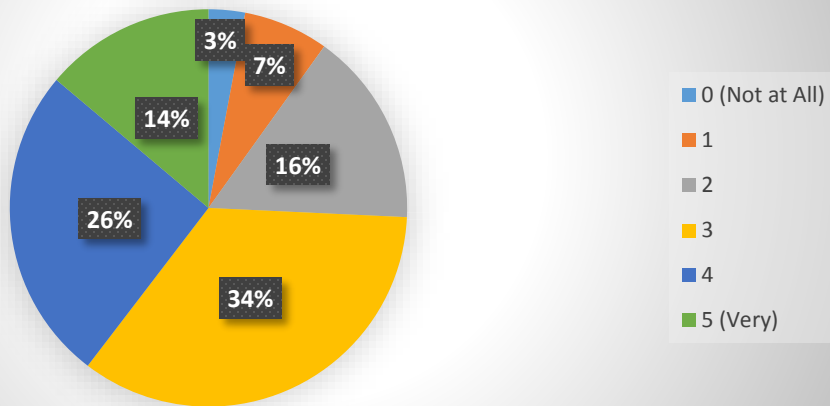

Figure 17 Pie Chart of answers from Survey Question 3

4. How familiar are you with the applications of LED lighting in today's world?

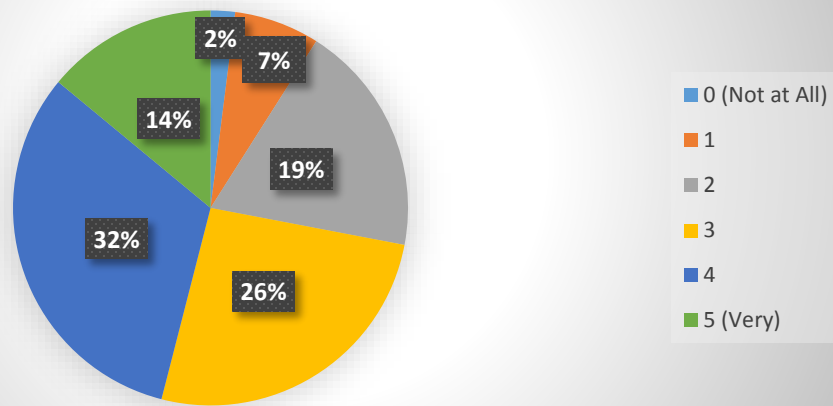

Figure 18 Pie Chart of answers from Survey Question 4

5. How familiar are you with the energy and cost saving potential of using LED light bulbs in place of traditional bulbs?

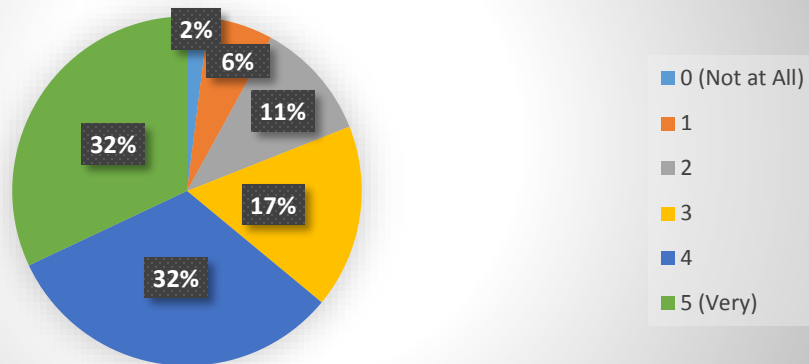

Figure 19 Pie Chart of answers from Survey Question 5

6. How likely are you to choose an LED light bulb over traditional incandescent or compact fluorescent bulbs?

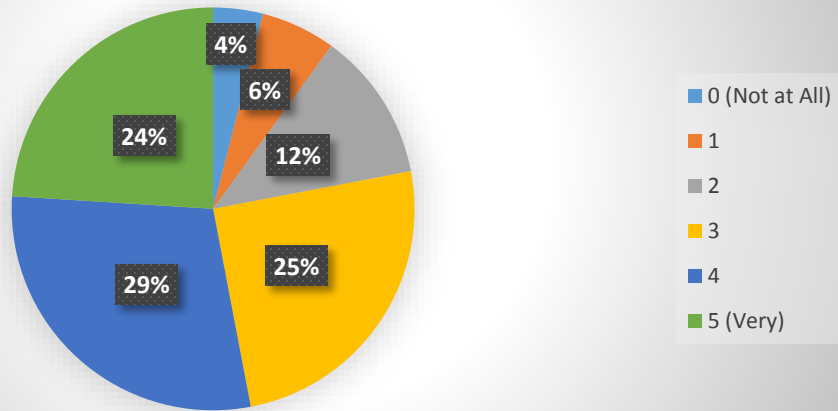

Figure 20 Pie Chart of answers from Survey Question 6

7. HOW IMPORTANT IS EACH OF THE FOLLOWING FACTORS TO YOU PERSONALLY WHEN CHOOSING WHICH TYPE OF LIGHTING TO USE IN YOUR RESIDENCE (CHOOSE THE BEST CHOICE, 0 THROUGH 5; 0=NOT IMPORTANT AT ALL, 5=MOST IMPORTANT):

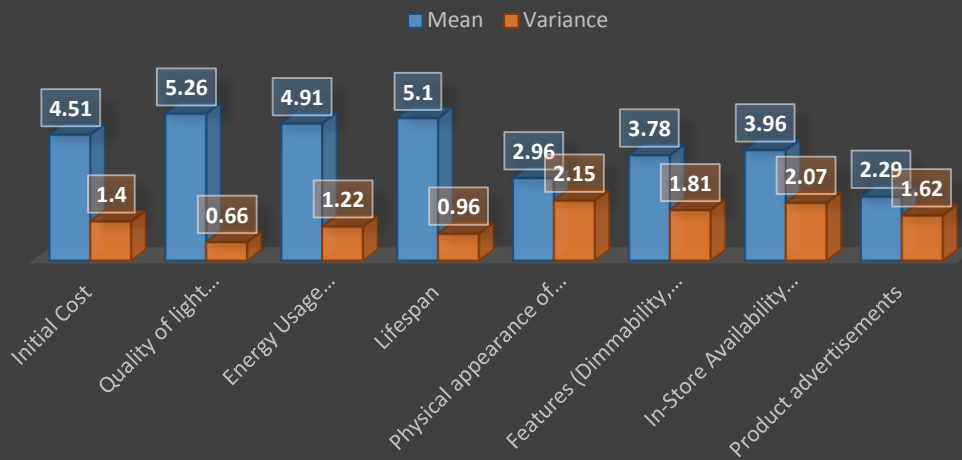

Figure 21 Average of Answers from Survey Question 7 and the variance of answers

## 7.2 Cost Benefit Analysis Appendices

### 7.2.1 Energy Audit

Table 9 Table of the energy audit raw data used to perform calculations

Room	Type of Bulb	Number of Bulbs	Wattage	Hours on during day	Energy Use/Day (KWh)	Energy Use/Yr (KWh)	Cost of Energy/KWh	Energy Cost/Yr
1	CFL	4	14	16	0.896	327.04	\$0.15	\$47.42
2	LED	3	10	12	0.36	131.4	\$0.15	\$19.05
3	CFL	2	14	16	0.448	163.52	\$0.15	\$23.71
4	CFL	3	14	16	0.672	245.28	\$0.15	\$35.57
5	CFL	3	14	12	0.504	183.96	\$0.15	\$26.67
6	LED	3	10	16	0.48	175.2	\$0.15	\$25.40
7	CFL	4	14	12	0.672	245.28	\$0.15	\$35.57
8	Incandescent	3	100	12	3.6	1314	\$0.15	\$190.53
9	Incandescent	3	100	12	3.6	1314	\$0.15	\$190.53
10	Incandescent	3	100	12	3.6	1314	\$0.15	\$190.53
11	CFL	10	14	16	2.24	817.6	\$0.15	\$118.55
12	CFL	2	14	16	0.448	163.52	\$0.15	\$23.71
13	CFL	4	14	16	0.896	327.04	\$0.15	\$47.42
14	CFL	2	14	16	0.448	163.52	\$0.15	\$23.71
15	CFL	2	14	16	0.448	163.52	\$0.15	\$23.71
16	Incandescent	3	100	16	4.8	1752	\$0.15	\$254.04
Dining Room	Linear Fl.	45	32	24	34.56	12614.4	\$0.15	\$1,829.09
Kitchen	Linear Fl.	16	32	24	12.288	4485.12	\$0.15	\$650.34
Pantry	Linear Fl.	1	32	24	0.768	280.32	\$0.15	\$40.65
Main Foyer	CFL	6	14	24	2.016	735.84	\$0.15	\$106.70
Living Room	CFL	3	14	24	1.008	367.92	\$0.15	\$53.35
Piano Room	CFL	1	14	8	0.112	40.88	\$0.15	\$5.93
DJ Room	CFL	3	14	24	1.008	367.92	\$0.15	\$53.35
Sch. Closet	Linear Fl.	1	32	24	0.768	280.32	\$0.15	\$40.65
Basement	Linear Fl.	20	32	12	7.68	2803.2	\$0.15	\$406.46
Back Stairs	Linear Fl.	4	32	24	3.072	1121.28	\$0.15	\$162.59
2nd Hall	Linear Fl.	12	32	24	9.216	3363.84	\$0.15	\$487.76
2nd Head	Linear Fl.	6	32	24	4.608	1681.92	\$0.15	\$243.88
3rd Hall	Linear Fl.	8	32	24	6.144	2242.56	\$0.15	\$325.17
3rd Head	Linear Fl.	6	32	24	4.608	1681.92	\$0.15	\$243.88
						<b>40868.32</b>		<b>\$5,925.91</b>

### 7.2.2 Floor Plan of Phi Gamma Delta

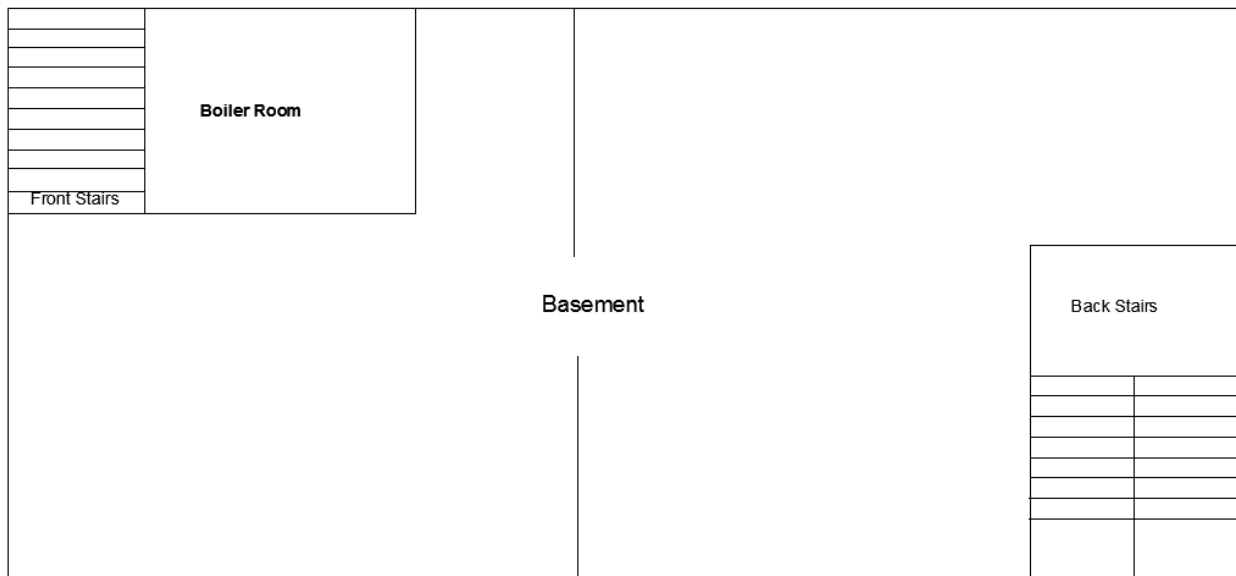

Figure 22 Basic Floor plan of Basement

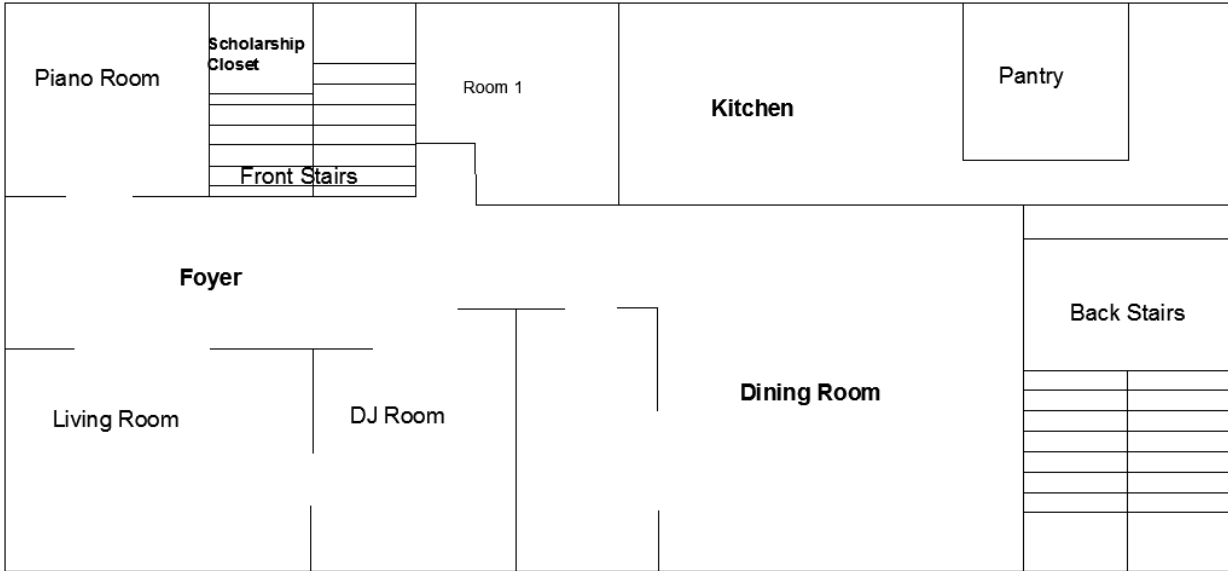

Figure 23 Basic Floor plan of the first floor

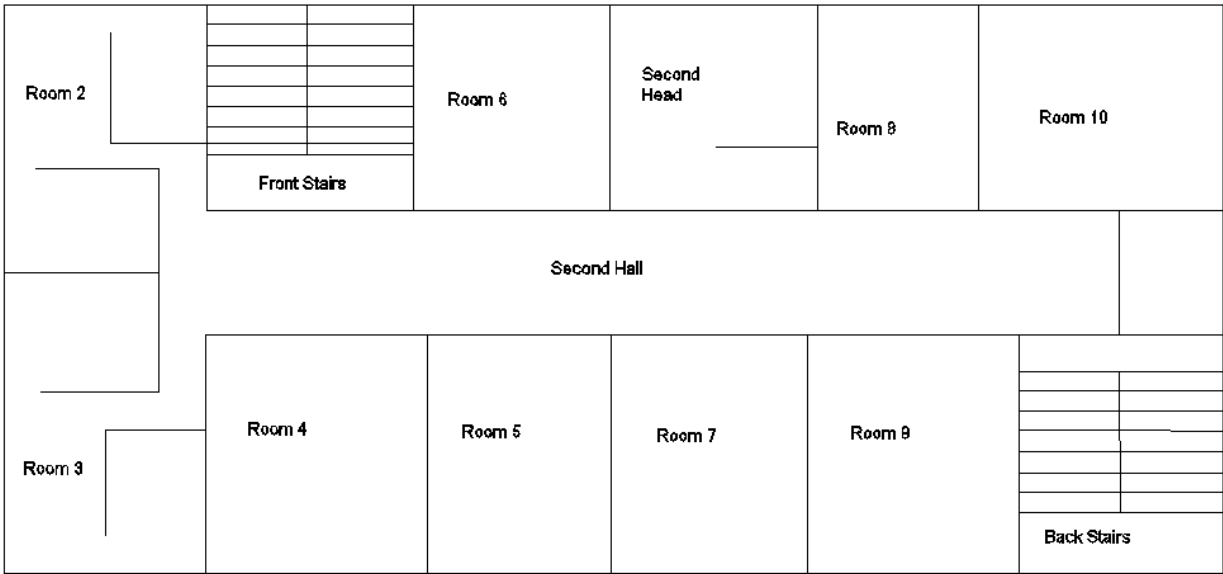

Figure 24 Basic Floor plan of the second floor

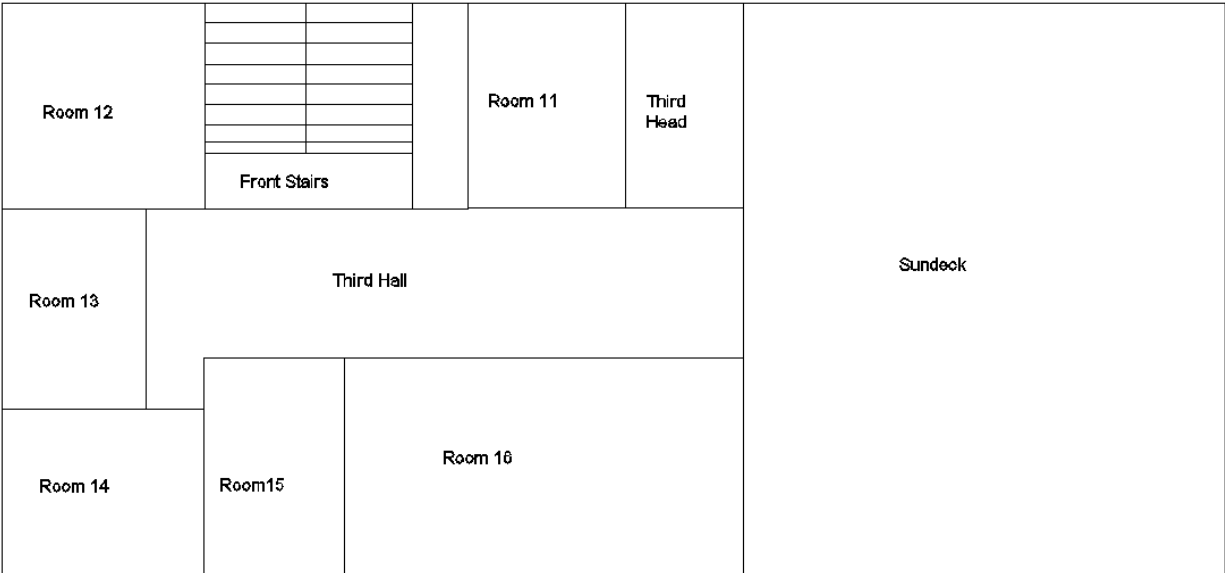

Figure 25 Basic Floor plan of the third floor

### 7.3 Project Contributions

Throughout the completion of this MQP our team has worked with each other to complete every aspect that was needed. When it came to the general writing requirements of the report, such as the problem statement and materials and methods, all members of the team collaborated with one another to complete the task, With that being said each group member took a major portion of the workload and took it upon themselves to ensure each part was completed fully.

Daniel Dwan took charge of the market analysis completing the necessary research and bringing together all the facts to form the analysis. He also completed the cost benefit analysis for each type of bulb and the fraternity of Phi Gamma Delta. Michael Horgan was in charge of conducting initial interviews with people and an in depth literature review on the subject. Michael also formatted, distributed and analyzed the survey sent to the WPI student body. He was also in charge of compiling and formatting the paper. Both groups members worked together to finalize each area of the project and draw conclusions and recommendations from the results.