

A Comparative Analysis of Biodiesel and Diesel Emissions

A Major Qualifying Project Report

Submitted to the Faculty

of the

WORCESTER POLYTECHNIC INSTITUTE

in partial fulfillment of the requirements for the

Degree of Bachelor of Science

by

Joshua Wayne Curto

Matthew David Giambrone

Alexander Scott MacGrogan

George Hutchinson Williamson IV

This report represents the work of WPI undergraduate students submitted to the faculty as evidence of completion of a degree requirement. WPI routinely publishes these reports on its website without editorial or peer review. For more information about the projects program at WPI, please see <http://www.wpi.edu/academics/ugradstudies/project-learning.html>

Abstract:

The goals of this project were to identify differences in the composition of combustion emissions between petroleum-based diesel and biodiesel and to determine if use of an emissions meter would be a suitable addition to a future laboratory experiment. The team achieved these goals through experimental testing of combustion emissions of the two fuels as well as mixtures using a flue gas analyzer and an existing biodiesel compatible combustion system. The team identified clear trends between biodiesel fuel proportions and exhaust concentrations of carbon monoxide, carbon dioxide, and nitrogen oxides, as well as validated the temperature dependence of emission compositions.

Acknowledgements:

We would like to extend special thanks to the following:

- Professor William Clark, our project advisor, for his support and advice over the course of the project, as well as for overseeing the construction of the modified exhaust ventilation system.
- Tom Partington for providing services in the Machine Shop to aid in the construction of the exhaust ventilation system.
- Worcester Polytechnic Institute for giving us the opportunity to conduct this research.

Table of Contents

Abstract:	2
Acknowledgements:	3
Table of Contents	4
Table of Tables	7
Table of Figures	8
Chapter 1: Introduction	10
Chapter 2: Background	12
Biodiesel and Its Chemistry	12
Advantages	17
Disadvantages	19
Biodiesel vs. Petroleum Diesel	19
Different Sources and Their Characteristics	20
Emissions	23
Nitrogen Oxides	24
Formation Mechanisms of NO _x	25
Effects of NO _x	27
Efficiency Computation	28
The EPA and Diesel Exhaust Regulations	30

Measurement Methods.....	32
Pitot Tube.....	32
Chapter 3: Methodology	34
Testo-340 Meter and Operation	34
Taking Measurements.....	36
Process of Producing Biodiesel at WPI	38
Production.....	38
Purification.....	40
Experimental Procedure.....	41
Burner Ignition Procedure:	41
Testo Measurement Procedure.....	43
Pitot Tube.....	44
Sulfur Dioxide Sensor.....	44
Chapter 4: Results and Discussions	45
Emissions Analysis with Diesel-Biodiesel Mixtures	45
Temperature Effects on Carbon Dioxide and Monoxide.....	47
Sulfur Dioxide.....	51
Completeness of Combustion and Mass Balance	52
Heater Efficiency	53

Pitot Tube.....	54
Chapter 5: Conclusions and Recommendations	55
Conclusions.....	55
Recommendations.....	57
Combined Lab with Heat Exchanger	57
Calorimeter Testing and Elemental Analysis	58
Fuel Line Protection.....	59
Pipe Insulation	59
Coolant Fluid Change	60
Fuels Derived From Other Feedstocks	60
Pitot Tube.....	60
Glossary:	62
Appendices:.....	63
References:.....	67

Table of Tables

Table 1: Summary of Twelve Biodiesel Sources.....	21
Table 2: Fuel Source Comparisons.....	23
Table 3: Pitot Tube Specifications.....	33
Table 4: Fuel Data: Flow Rate, Heat Exchange, Stack Temperature	63
Table 5: Fuel Data: Emissions and Coolant Flow	64
Table 6: Fuel Data: Coolant and Heating Value Data	65

Table of Figures

Figure 1: General Transesterification Process taken from (Meher, Vidya Sagar, & Naik, 2006)	12
Figure 2: Methane Combustion	13
Figure 3: CO ₂ Residential Oil Burner Characteristics (EPA, 1975).....	14
Figure 4: Methanol Separation Schematics (Van Gerpen, 2014).	16
Figure 5: Emission Changes with Percent Biodiesel	24
Figure 6: Kinetics of Reaction Equation ($d [NO] / dt$)	26
Figure 7: Testo-340 Schematic Mixing Chamber.....	35
Figure 8: Testo Slot Contents	35
Figure 9: Ventilation System	37
Figure 10: Biodiesel Production Schematic.....	38
Figure 11: WPI Biodiesel Production Setup.....	39
Figure 12: Two Phase Separation and Resin Column	40
Figure 13: Schematic of Diesel and Biodiesel Heater and Heat Exchange Setup.....	42
Figure 14: Air Density and Velocity Calculations.....	44
Figure 15: NO _x Concentration (ppm) Vs. Diesel-Biodiesel Composition.....	45
Figure 16: NO _x Concentration vs. Flue Temperature	46
Figure 17: Carbon Monoxide Concentration vs. Biodiesel Composition.....	47
Figure 18: %CO ₂ against Biodiesel Concentration.....	48
Figure 19: Carbon Dioxide vs. Temperature	49
Figure 22: Excess vs Stack Temperature	51

Figure 22: Burner Efficiency	53
Figure 23: Average Heating Efficiency for Pure Fuels and Mixtures	53

Chapter 1: Introduction

Society is continuously developing and evolving to enhance daily life. Energy has been, and always will be, required to achieve desired technological advances. As different methods of harnessing energy are discovered, they will possess the ability to transform society's surroundings. Petroleum based fuels have been used as one of the main sources of energy, however fossil fuel sources are projected to diminish as population increases in the next century. The combustion of these fossil fuels potentially releases hazardous chemicals and pollutants. In the past 30 years there has been a shift in awareness as to the negative impacts of fossil fuels on ecosystems and climates. As a result fuels derived from plants, geothermal energy, solar energy and more have been targeted as promising alternatives. An ideal fuel for the future should be both energetically competitive with current fuels but also have a better environmental contribution.

Interest in biodiesel has been a result of the growing need for a cleaner burning fuel that is also compatible with most current diesel engines. Unlike petroleum-based diesel fuel, biodiesel is produced from renewable organic sources. Although its stored energy content is comparable to petroleum diesel, there are multiple differences in their chemical, physical and emissions contents and properties.

Worcester Polytechnic Institute (WPI) has the capability to produce biodiesel fuel. This biodiesel as well as petroleum based diesel were compared using an Espar diesel combustion heater. The setup of this heater was designed in a previous MQP project focusing on the analysis on the energy contents and efficiencies of these different fuels.

The goals of this project were to modify the exhaust ventilation for use with a new emissions meter to compare the emissions as well as the combustion efficiencies of diesel and biodiesel fuels. These goals were achieved by:

- Developing a method of adding a testing apparatus into the existing combustion engine setup.
- Showing that a difference exists in exhaust emission contents of the two fuels.
- Identifying trends in exhaust emissions' contents for pure diesel, pure biodiesel and mixtures.
- Determining a suitable way to quantify combustion efficiency and calculating these efficiencies for pure diesel, pure biodiesel and mixtures of the two.

Chapter 2: Background

Biodiesel and Its Chemistry

Biodiesel is an alternative to petroleum-based diesel created from renewable resources such as used oils, animal fats, and oils derived from plants. The active compounds in biodiesels are known as fatty acid methyl esters (FAME), which are converted from triglycerides in a reaction known as transesterification. This process uses methanol and a potassium hydroxide catalyst to convert triglycerides and methanol into glycerol and methyl esters; the active compounds of biodiesel. Potassium hydroxide (KOH) is mixed with the methanol acting as the catalyst. Figure 1 below shows the general reaction equation for the formation of FAME using methanol. This reaction mechanism allows for an easy phase separation of the glycerol and methyl esters.

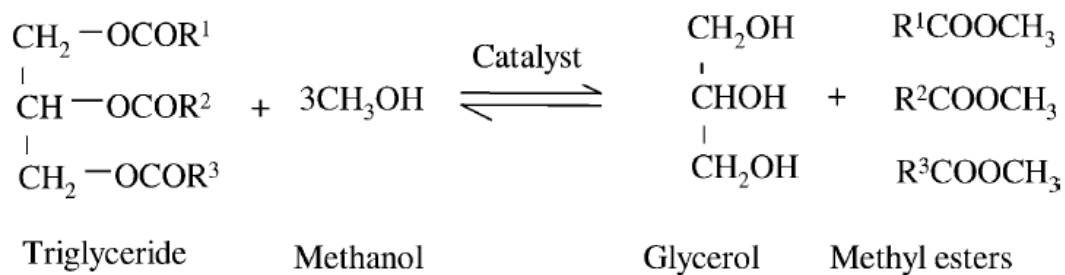

Figure 1: General Transesterification Process taken from (Meher, Vidya Sagar, & Naik, 2006)

Combustion Chemistry

For the purposes of this project, combustion is defined as an exothermic reaction between oxygen and a hydrocarbon to produce carbon dioxide, carbon monoxide, and water. Complete combustion is the complete reaction of oxygen and a hydrocarbon to form only carbon dioxide and water. Incomplete combustion occurs when there is too little oxygen available for the fuel to react with and therefore carbon monoxide is formed in much higher quantity than carbon

dioxide, along with water vapor. Incomplete combustion can also result from poor mixing of the fuel with air. The simplest form of combustion is the reaction of methane and oxygen. The energy released from this reaction is in the form of heat and light.

Complete Combustion

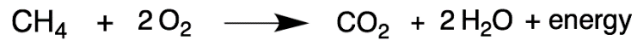

Incomplete Combustion

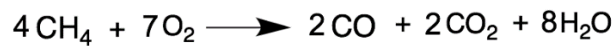

Figure 2: Methane Combustion

In order to achieve complete combustion, there should be two oxygen atoms for every carbon atom, and one oxygen atom for every two hydrogen. As the carbon chains become longer, more oxygen is needed to completely combust the fuel into carbon dioxide and water. For example, diesel fuel has on average the chemical composition $\text{C}_{12}\text{H}_{23}$. This means that 71 O_2 molecules are needed for every 4 diesel molecules to have complete combustion. It is difficult to achieve complete combustion in a typical engine due to insufficient air flow. This results in the release of carbon monoxide as an undesired by-product, as well as lower heat output. Due to impurities in the fuel sulfur oxides, nitrogen oxides, and trace amounts of cyclic organic compounds are also formed during combustion.

When discussing the combustion of biodiesel two types of molecules are typically considered, the $\text{C}_{19}\text{H}_{36}\text{O}_2$ and $\text{C}_{20}\text{H}_{38}\text{O}_2$ molecules. These molecules model the two main components of the mixture, however there are other compounds present that contain nitrogen and sulfur. For every kilogram of C_{19} fuel burned ideally 2.52kg of carbon dioxide are released. Compared with 3.17kg and 3.09kg for diesel and gasoline respectively, this is much lower. The

high presence of nitrogen compounds within biofuels leads to the higher production of nitrogen oxides in exhaust gases (Biofuel.org, 2010).

Combustion of hydrocarbons can be classified into three levels based on the amount of oxygen in the combustion chamber. If excess oxygen is pumped into the combustion chamber it causes unburned fuel to be ejected, along with high carbon monoxide emissions and relatively low carbon dioxide emissions. When insufficient oxygen is pumped into the chamber it causes the production of soot and high carbon dioxide and monoxide emissions. As the amount of air pumped into the chamber is increased a characteristic curve is produced. This is based upon the Bacharach Smoke Number and is illustrated in Figure 3.

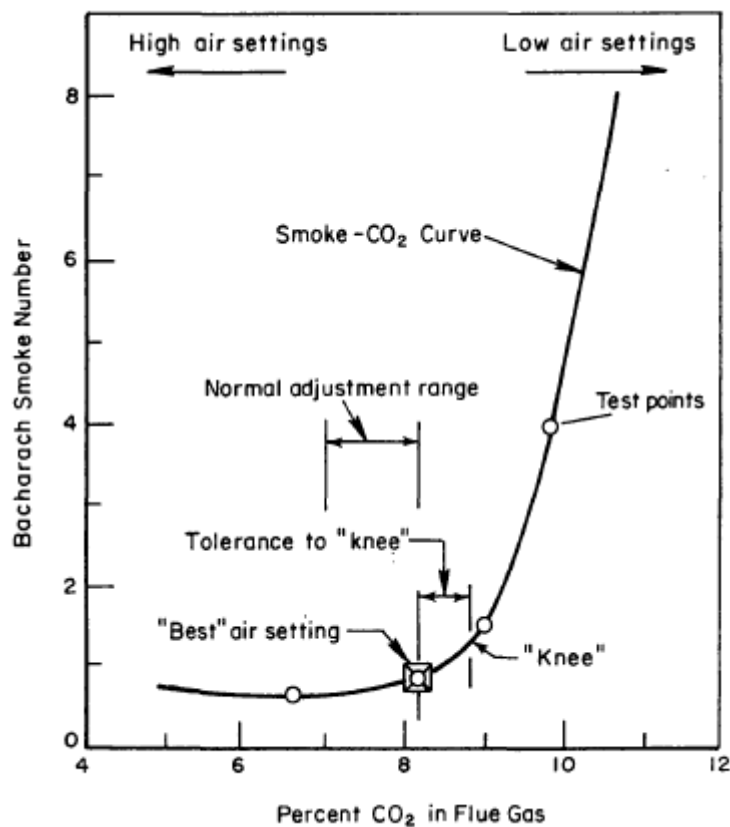

Figure 3: CO₂ Residential Oil Burner Characteristics (EPA, 1975)

The point right before the sudden increase 9% in the smoke number is the ideal amount of oxygen needed for combustion. This is denoted with the wording relative to the “knee”.

Reaction

The main components used in the manufacturing of biodiesel are fats and oils derived from plants and animal fats, the chemical compositions of which differ slightly. Animal fats and oils contain triglycerides, which are esters that contain three fatty acids and a glycerol molecule. Through transesterification, these esters, in the presence of methanol or ethanol, react to form mono-alkyl esters, also known as biodiesel. However, this reaction is rather slow, so a base catalyst of either NaOH, KOH, NaOCH₃, or KOCH₃ is added. This normally yields up to 98% conversion in a relatively short period of time. Glycerol is a byproduct of this reaction and since biodiesel and glycerol form two distinct phases, they can be easily separated. Since the biodiesel phase is contaminated with excess catalyst, alcohol and some glycerol, it has to be further purified before it can be used. This can be done through the use of distillation, membrane separation, and ion exchange resins (Kiss & Ignat, 2012; Morales, Lopez, & Rios, 2013; Saleh et al., 2010).

Biodiesel Production & Purification

In the United States there are over 145 large biodiesel production plants. These plants use a mixture of animal fats, soy oils or multiple different feedstocks as the reactant. The process most commonly used is seen in Figure 4.

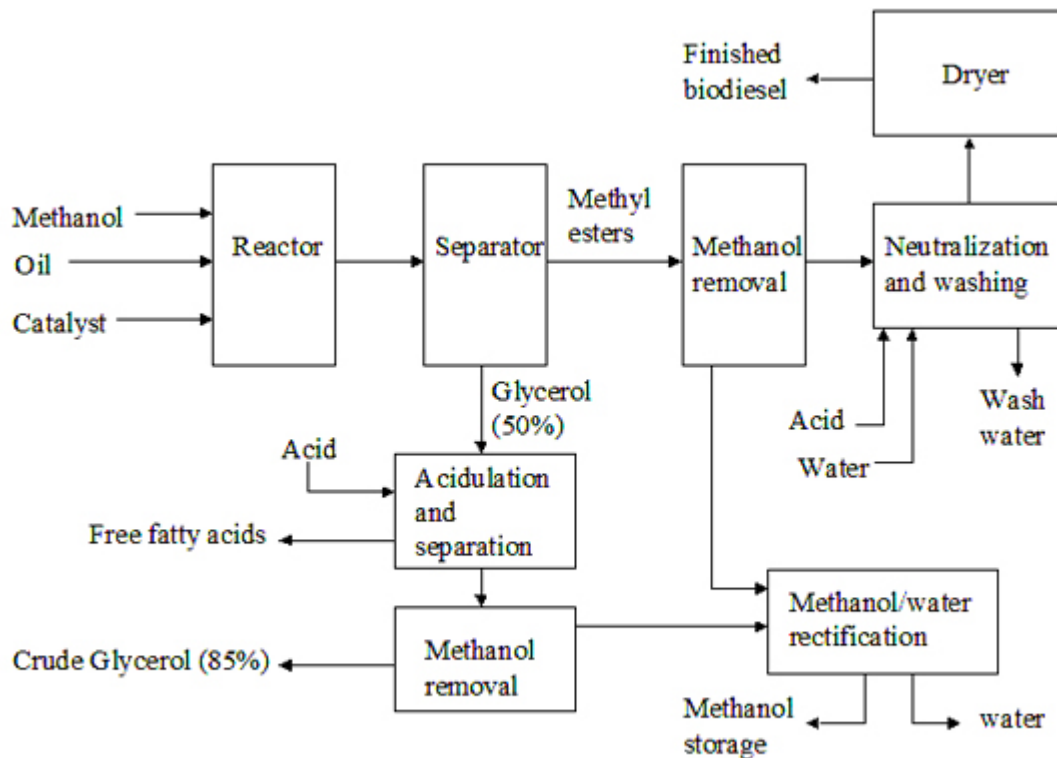

Figure 4: Methanol Separation Schematics (Van Gerpen, 2014).

The above reaction is typically done in two steps, where 80% of the alcohol and catalyst is added in the first reactor, and after having the glycerol removed, the product enters a second reactor where the remaining 20% is added. This reaction has very high yields, and can potentially decrease the amount of alcohol required when compared to single step reactions (Van Gerpen, 2014).

As mentioned above, the glycerol and the biodiesel form 2 distinct phases, but excess methanol in the stream slows the separation. Settling tanks or centrifuges are often used to speed

up this process. Since the glycerol rich phase also contains the base catalyst and the excess methanol, it is deemed hazardous waste, so it must be refined. The first step to refining the glycerol is the addition of an acid, which splits the free fatty acids from the salts. The free fatty acids are insoluble in glycerol, and will float to the top where they can be removed and recycled back into the reactant stream. The remaining salts stay in the glycerol, and depending on chemical composition may precipitate out. One option that helps to remove the salts is acidulation, or the addition of phosphoric acid, which neutralizes the solution. This causes the precipitate potassium phosphate, which is commonly used for fertilizers. After those two steps, the remaining glycerol contains mainly methanol. A vacuum flash process, or some type of evaporator is used to remove the excess methanol. The final glycerol product has a purity of around 85%, and can be sold to glycerol refineries for further processing.

After the glycerol phase is removed, the biodiesel phase enters a methanol stripper, typically a vacuum flash process or a falling film evaporator. The methanol that is collected from the biodiesel and the glycerol phases tends to collect water that entered the process. The water is removed through distillation before the methanol can be sent back into the process.

After removal of methanol, the biodiesel phase is neutralized through the addition of acid, which removes excess catalyst and also breaks up any remaining glycerol that may have formed. The glycerol reacts with the acid to form water-soluble salts and free fatty acids. The water-soluble salts are removed through dry washing, and the free fatty acids are left in the biodiesel (Van Gerpen, 2014).

Advantages

The transesterification process used to produce biodiesel generates a significant amount of glycerol. Glycerol has traditionally been made from petroleum based productions and

generally requires a dedicated production plant. It is possible to recover glycerol as a by-product of transesterification and use it further. Glycerol is used in many industries such as the production of soap and other household products. Glycerol is also used extensively in the cosmetics industry since it prevents rough crystalline structures from harming the user. The glycerol generated from the production of biodiesel has been shown to be an economic benefit. This cheap by-product of glycerol in combination with an anaerobic fermentation process will potentially allow an economically feasible fuel source when compared with existing methods (Yazdani & Gonzalez, 2007).

Different feedstocks affect the stored energy content in the final fuel. For example, a noteworthy property of soybean-derived biodiesel is that it yields 93% more energy than the amount invested in the production of it (Hill, Nelson, Tilman, Polasky, & Tiffany, 2006). The heating value of soybean oil is 39.7 MJ/kg whereas Canola Oil has 41.3 MJ/kg. There are various feeds sources that have potential for producing biodiesel in the future.

Emissions quality is one of the principal benefits of biodiesel. Compared with petroleum derived diesel, biodiesel produces less sulfur and carbon monoxide in the emissions. Not only would the emissions be cleaner than petroleum-based diesel but as a result less expensive vehicle catalysts can be used to further reduce toxic emissions. Biodiesel is able to achieve approximately 41% better emissions when compared with traditional fuels emission of greenhouse gases (Hill et al., 2006). In addition, biodiesel contains nearly 11% oxygen by weight, which aids the combustion process. Additionally biodiesel can extend the life of diesel engines due to its increased lubrication abilities (Demirbas, 2008).

Disadvantages

Although there are many benefits to utilizing biodiesel as a fuel source, there are some drawbacks. Due to the chemical properties of the biodiesel mixture, cold temperatures tend to cause coagulation in the fluid, which inhibits fuel injection in engines (Knothe, 2010). Biodiesel has a cloud point at which the fuel will start solidifying into a wax like material. If the fuel reaches a few degrees below this temperature, the fuel will become completely wax-like and will be unusable in the engine (Dogpatch, 2015, Using Biodiesel). Since some semi-trailers move large loads in cold climates coagulation poses a major threat to their operation. This temperature restraint has proven to be a hurdling challenge in the implementation of biodiesel in place of petroleum diesel.

Another pressing issue is the argument of fuel versus food. The main reactant in the production of biodiesel is a fat or oil. These oils are created from crops, which could otherwise be utilized as a source of food. The limited amount of fertile farmland means a finite amount of land for agriculture. The transformation of common foods into fuel has a negative impact on the supply of food available.

The biodiesel production process utilizes methanol as a reactant. It is argued that because of the most common sources of methanol, that biodiesel is not 100% “bio” (Knothe, 2010). Methanol can be easily obtained from the non-renewable source, natural gas. However, methanol can also be produced through a series of renewable reagents, but it is not commonly done.

Biodiesel vs. Petroleum Diesel

Biodiesels are all similar in terms of density and lower heating value (LHV), a measure of the energy content of fuel not accounting for the latent heat of vaporization of water. They are also similar in flash point and octane number with the exception of peanut oil. These differ from

standard diesel with all of the oils having a lower LHV and higher flash points. It is desired for a fuel to have a large amount of stored energy, therefore a fuel with the highest LHV is the optimal source for energy.

Fuel consumption is proportional to the volumetric energy density of the fuel based on the LHV. LHV takes into account the change in temperature during combustion and the heat of vaporization of water. Although the energy content of different types of biodiesels are quite similar, they all emit approximately 10% less heat than petroleum-based diesel (Alternative Fuels Data Center, 2015).

Different Sources and Their Characteristics

Different sources of making biodiesel from oils are used around the world due to their availability and range from olive oil to animal fat. The United States of America's main source of biodiesel is from soybean oil (Martinez, Sanchez, Encinar, & Gonzalez, 2014). Various oils have different amounts of fatty acids and this results in a slightly differing product.

A major study compared twelve different feedstocks for production of biodiesel, primarily composed of fatty acid methyl esters (FAME), through transesterification. They tabulated and made comparisons based on many properties including cetane number, viscosity, density, heating value, flash point, average carbon chain length, average degree of unsaturation, and oxidative stability (Hoekman, Broch, Robbins, Cenicerros, & Natarajan, 2012).

Property	Camelina		Canola		Coconut		Corn		Jatropha		Palm		Rapeseed		Safflower		Soy		Sunflower		Tallow		Yellow Grease	
	mean	dev	mean	dev	mean	dev	mean	dev	mean	dev	mean	dev	mean	dev	mean	dev	mean	dev	mean	dev	mean	dev	mean	dev
Sulfur Content, ppm	2	2	2	0	3	1	4	1	5	6	2	2	4	3	ND		2	2	2	3	7	8	5	5
Kinematic Viscosity @ 40 °C, mm ² /s	3.80	0.55	4.38	0.27	2.75	0.24	4.19	0.33	4.75	0.58	4.61	0.56	4.50	0.35	4.14	0.13	4.26	0.39	4.42	0.26	4.69	0.44	4.80	0.48
Cloud Point, °C	3	1	-2	1	-3	3	-3		5	3	14	2	-3	2	-4	2	0	2	2	1	13	2	8	5
Pour Point, °C	-7	3	-6	3	-9	5	-2	2	0	5	13	2	-10	3	-7	1	-4	3	-2	2	10	3	3	7
CFPP, °C	-3	2	-9	4	-5	1	-8	6	ND		9	5	-12	6	-6		-4	2	-2	1	13	2	1	5
Flash Point, °C	136		153	29	113	6	171	16	152	20	163	17	169	16	174	7	159	18	175	9	124	35	161	22
Cetane No.	50.4	1.6	53.7	1.5	59.3	9.7	55.7	2.9	55.7	3.0	61.9	3.6	53.7	2.9	51.1	1.8	51.3	4.6	51.1	3.2	58.9	2.1	56.9	4.2
Cetane Index*	ND		61.5		ND		60.9		ND		50.5	4.4	54.7	5.0	ND		52.3	5.7	55.0	8.4	59.1		48.5	
Iodine Value	152.8	2.5	108.8	1.3	18.5	16.3	101.0		109.5		54.0	6.1	116.1	6.7	141.0		125.5	5.4	128.7	4.6	65.9	15.6	88.9	16.2
Specific Gravity	0.882	0.007	0.883	0.003	0.874	0.001	0.883	0.005	0.876	0.009	0.873	0.008	0.879	0.010	0.879	0.012	0.882	0.007	0.878	0.011	0.878	0.006	0.879	0.010
Lower Heating Value, MJ/Kg	ND		38.9	1.6	35.2		39.9		37.7		37.3	2.3	37.6	1.6	ND		37.0	1.9	35.3	2.1	37.2	0.2	37.6	1.6
Higher Heating Value, MJ/Kg	45.2		41.3	3.1	38.1		43.1	2.7	40.7	1.5	40.6	1.5	41.1	2.3	42.2	2.7	39.7	0.8	40.6	2.4	39.7	0.2	39.4	1.1
Avg. Chain Length	19.10		18.20		13.40		17.80		18.30		17.20		17.90		17.80		17.90		18.10		17.30		18.50	
Avg. Unsaturation	1.81		1.34		0.12		1.46		1.15		0.62		1.31		1.63		1.50		1.59		0.59		1.06	
No. of References	7		15		7		6		23		44		39		4		59		20		12		37	

ND = No Data found in literature

* = No accepted method for determining cetane index of biodiesel

Table 1: Summary of Twelve Biodiesel Sources

The American Society for Testing and Materials (ASTM) has laid out specifications on properties for suitable biodiesels. Cetane number is a rating of the ignition time for diesels, with higher cetane numbers resulting in greater ease of combustion and is commonly used as one measure of fuel quality. The ASTM specification D6751 specifies a minimum cetane number of 47 for biodiesels. Biodiesels prepared from the most-used feedstocks all exceed this value, though higher cetane numbers are desirable.

Though no standards exist for the heating value of biodiesels, the higher heating value (HHV) is another important property used in determining the quality of biodiesels. HHV is the energy contained in the fuel that is readily converted to thermal energy taking into account the

latent heat of vaporization of water. Biodiesel contains on average 11% oxygen by mass and also contains less carbon and hydrogen by mass than petroleum-based diesel. Thus biodiesel has about a 10% lower HHV by mass than petroleum-based diesel; though it only has 5-6% lower HHV by volume, considering that biodiesel density is typically higher than petroleum diesel (Hoekman et al., 2012).

Cold-flow properties, or properties affecting fuel performance at low temperatures, include both the variability of density and viscosity of the fuel and is heavily dependent on the cloud point of the fuel. Viscosity, a liquid's resistance to flow, is an important property that affects the performance of a fuel. Fuels with high viscosities have worse performance due to increased difficulty in atomization and vaporization, resulting in poor combustion and higher emissions. Viscosity is very temperature-dependent, meaning most problems that arise due to viscosity of a fuel occur most noticeably under low ambient temperature and cold-start engine conditions (Hoekman et al., 2011).

Cloud point is generally used as an indicator cold-flow property. This is the temperature at which waxes in the fuel begin to solidify and cloud the FAME mixture, which has adverse effects on engine performance due to clogging of filters and fuel injectors (Hoekman et al., 2011). The average degree of unsaturation, or the average number of double bond equivalents (number of double bonds + aromatic rings) in a fuel, has been shown to negatively correlate with cloud point, meaning that higher degrees of unsaturation have better cold temperature performance. The following are sources of feedstocks and associated properties from (Demirbas, 2008).

Fuel Source	Fuel Property Descriptions
Peanut Oil	The density of biodiesel produced from peanut oil is higher than all other oils studied and the lowest octane number.
Soybean Oil	Soybean oil has a slightly lower density than peanut oil but is 10 points better in terms of octane rating, but peanut oil was the anomaly so this is not a reason to stand out from the rest.
Palm Oil	Palm oil's octane number was worse than soybean's and the density was lower. This leaves the more expensive palm oil out of the question. The only redeeming factor was its higher cloud point than the others.
Sunflower Oil	Sunflower oil possesses no characteristic that sets itself apart from the other four oils and its price tends to be a bit higher than the others, leaving it to be undesirable.
Canola Oil	Canola oil is a cheap alternative that has a higher cetane number than that of soybean oil. The density is nearly the same as well, both these indicators show that it is a promising source.

Table 2: Fuel Source Comparisons

Emissions

Biodiesel has been shown to have an advantage over petroleum-based diesel in terms of emissions composition. Combustion of biodiesel emits minimal to no SO₂ emissions, less polyaromatic hydrocarbons, soot, and carbon monoxide. Combustion efficiency is defined as the ratio of the energy released in combustion to the higher heating value of the fuel. This efficiency can be optimized through adjustments of the air inlet to the burner which can also effect final emission composition (Durrenberger, 1983).

Combustion efficiency is also a function of the exhaust temperature and the exhaust concentration of CO₂. High concentrations of CO₂ indicate that combustion is going towards completion and most of the fuel is being consumed. The stack temperature is directly related to the amount of built-up soot and scale on the heat transfer surfaces. With greater buildup of soot, the conductive heat transfer coefficient of the surfaces drop and more useful heat is lost in the

stack (Durrenberger, 1983). For these reasons, it is important to tune burners to maximize CO₂ concentrations in the stack while minimizing the amount of smoke produced.

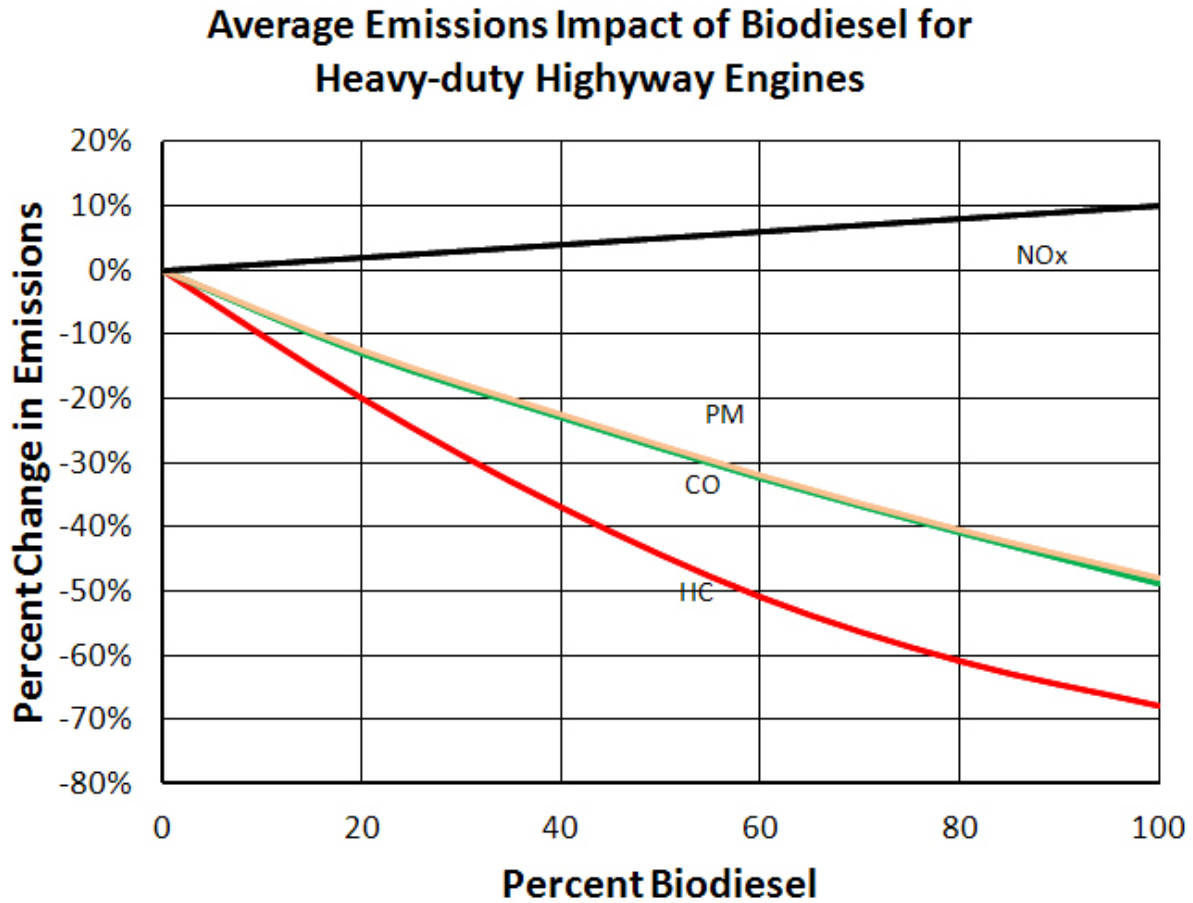

Figure 5: Emission Changes with Percent Biodiesel

Figure 5 displays the expected trends when combusting mixtures of diesel and biodiesel.

Nitrogen Oxides

Nitrogen Oxides (NO_x) are a group of highly reactive gases, which encompass compounds ranging from nitrous to nitric acid. These compounds are primarily released in truck, car, power plant and off road equipment exhaust (O. US EPA, OAQPS, 2014). NO_x gases form when nitrogen and oxygen from the air react at the extremely high temperatures and pressures inside a combustion cylinder, which can reach up to 4000°F and 300PSI (Johnson, 2015). In the

direct injection diesel engine fuel is sprayed into the cylinder and forms tiny droplets. Oxygen interacts at the boundary surface between the air and the fuel droplets where the localized temperature in the fuel droplet exceeds that required to form NO_x gases. Typically a high amount of oxygen and high temperature will result in high levels of NO_x formation. These conditions are typically found in diesel engines because they run at a lean air-fuel mixture and at high compression ratios. Diesel fuel produces less NO_x than gasoline during combustion, however with the implementation of catalytic converters in gasoline powered vehicles, diesel engines release more NO_x gases to the environment ("Vehicle Emissions | Air Pollution | City Diesel | LPG | CNG," 2015).

Formation Mechanisms of NO_x

The three main sources of NO_x gases from combustion processes are thermal, fuel, and prompt. Thermal NO_x refers to NO_x formed through high temperature oxidation of atmospheric nitrogen. Fuel NO_x refers to the conversion of fuel bound nitrogen to NO_x. Although the fuel NO_x mechanism is not fully understood, it is very important and contributes to nearly 50% of all NO_x production when combusting oil, and up to 80% when burning coal. Prompt NO_x is formed through the reaction of atmospheric nitrogen with radicals such as C, CH, and CH₂ fragments derived from the fuel.

There are three reactions, derived from the extended Zeldovich mechanism, that represent the thermal mechanism for the formation of NO during combustion:

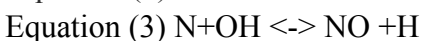
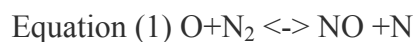

The temperatures these reactions typically occur at or above 2900°F. The forward and reverse reaction rate constants of the above reactions are exponentially dependent on

temperature, and also residence time of nitrogen at that temperature. The kinetics of the reaction is shown below.

$$\frac{d[\text{NO}]}{dt} = \frac{6 \times 10^{16}}{T^{1/2}} \exp\left(\frac{-69,090}{T}\right) [\text{O}_{2,eq}]^{1/2} [\text{N}_{2,eq}] \text{ (moles/cm}^3 \text{ - sec)}$$

Figure 6: Kinetics of Reaction Equation (d [NO] / dt)

The large activation energy and inverse temperature relationship in the exponential term are what impose a strong temperature dependence on the formation rate of NO. In relation to biodiesel however, some studies have found differences in NO_x emissions when compared to petro-diesel that result from a shift in dependencies on thermal and prompt mechanisms to the fuel NO_x. The changes in NO_x emissions between biodiesel and petroleum diesel are mainly determined by pre-combustion chemistry of hydrocarbon free radicals. The thermal mechanism above is largely unaffected by fuel chemistry, however the prompt mechanism is sensitive to radical concentrations. It has been suggested that increased acetylene production may contribute to the increase in prompt NO formation and cause the increased NO formation that is observed when combusting highly unsaturated biodiesel fuel, such as that created from soybean oil.

When comparing petroleum diesel and biodiesel it is important to discuss the adiabatic fuel temperature. Adiabatic fuel temperature is based on the amount of fuel bound oxygen, level of aromatic compounds, and the number of double bonded species. Decreased radiative heat transfer within biodiesel fuels, caused by the decreased concentration of fuel bound aromatic species and increased concentrations of fuel bound oxygen, tends to increase post flame gas temperatures, which can increase NO emissions. This is countered by the fact that aromatic species tend to have higher adiabatic flame temperatures and therefore the higher concentrations of those compounds in petroleum diesel may raise flame temperatures.

The literature reveals inconsistent trends in the effect of NO_x emissions with the use of biodiesels, although many report an increase in NO_x. This inconsistency is based on the variability of the experiment, fuel type, and test apparatuses. A little over half the literature showed a linear increase in NO_x emissions as biodiesel concentration increases ("Oxides of nitrogen emissions from biodiesel-fuelled diesel engines," 2010).

Effects of NO_x

When in the atmosphere NO₂ is split by UV radiation from the sun to form NO and O, which combines with oxygen present in the air to form ground level Ozone, a toxic pollutant and powerful greenhouse gas. The NO₂ is oxidized to nitric acid by a reaction with ammonia, which in turn combines with water vapor to form acid rain. The concentration of NO, NO₂ and NO₃ individually are difficult to determine due to a quasi-equilibrium that is reached between the molecules interchanging oxygen atoms ("Nitrogen Oxides (NO_x)," 2015)

Increased amounts of nitrogen in water bodies, especially coastal estuaries, can upset the natural chemical equilibrium that keeps ecology of the system alive. This increased nitrogen can accelerate a process called eutrophication, which eventually leads to decreased oxygen levels and decreased fish populations. NO_x also reacts readily with common organic molecules present in the air to form a number of toxic compounds including nitrate radicals, nitroarenes, and nitrosamines (Agency, 1998).

NO_x gases contribute to a wide variety of health problems including: respiratory irritation, headaches, pulmonary emphysema (chronically reduced lung functions), impairment of lung defenses, edema of lungs, eye irritations, loss of appetite, and corrosion of teeth. The most vulnerable groups are young children and asthmatics as well as individuals with chronic bronchitis, emphysema or other chronic respiratory diseases.

In 2012, NO_x gases accounted for 6% of all U.S. greenhouse gas emissions. NO_x gases last approximately 120 years in the atmosphere before being removed by a sink or converted in chemical reactions. NO_x gases have a greenhouse effect that is nearly 300 times more than that of carbon dioxide (C. C. D. US EPA, 2014).

Efficiency Computation

Fuel combustion occurs at maximum efficiency when a fuel reacts completely with a stoichiometric equivalent amount of oxygen. When this happens the compositions of oxygen and carbon monoxide in the flue gas should be minimized, and the composition of carbon dioxide should be maximized. At this point, the maximum amount of chemical potential energy contained in the fuel is converted to thermal energy. Realistically, the perfect stoichiometric ratio does not result in maximally efficient combustion. It is extremely unlikely with continuous fuel injection that all the fuel will come into contact with oxygen unless excess air is supplied. Nearly complete combustion of the fuel is achieved with excess air ("Combustion Analysis Basics," 2004). The following equation gives a good approximation of the excess air:

$$\% \text{ Excess Air} = \frac{\%O_2 - \frac{\%CO}{2}}{21 - \left(\%O_2 - \frac{\%CO}{2}\right)}$$

This accounts for the air used in incomplete combustion. However, too much excess air does reduce the efficiency of combustion because it cools the combustion chamber and results in fuel exiting unburnt. Air is composed mainly of nitrogen gas that does not contribute to the combustion reaction and absorbs a significant amount of heat.

A good measure of the efficiency of combustion is the net combustion efficiency, which is the ratio of the useful heat to the total fuel heating value. This is the common measure of efficiency since it accounts for the energy contained in the water vapor formed in the combustion

process. This can be calculated either from measuring the heat losses in the stack or the amount of heat transferred to the heating fluid. The equations are:

$$\% \text{ Net Combustion Efficiency} = \left(1 - \frac{\text{Flue Heat Losses}}{\text{fuel heating value}} \right) * 100$$

Alternatively, the gross combustion efficiency excludes the heat contained in water vapor formed during the combustion process:

$$\% \text{ Gross Combustion Efficiency} = \left(1 - \frac{\text{Dry Flue heat losses}}{\text{fuel heating value}} \right) * 100$$

The dry flue heat losses can be calculated using the equation:

$$\text{Losses} = m * c_p (T_{\text{Flue}} - T_{\text{Air}})$$

The specific heat of the exhaust, c_p , is the average specific heat value of the gas mix. The specific heat of the exhaust is known to not vary greatly with the type of fuel used. The mass of the exhaust, m , can be found using a mass balance on the reactor. A formula that can be used to calculate the mass of the exhaust is as follows:

$$m = \frac{(44C_{O_2} + 32O_2 + 28N_2 + 28CO)}{12 * (CO_2 + CO)} * \left(C_b + \frac{12 * S}{32} \right)$$

Where CO_2 , O_2 , CO , and N_2 are the concentrations of those gases in the exhaust expressed as percentages, S is the sulfur content of the fuel, C_b is the average carbon content of the fuel in number of carbon atoms per hydrocarbon molecule.

Another method of calculating the efficiency of combustion is to measure the useful heat and the heat lost in the stack. With temperature probes at the entrances and at the exits of the heater as well as the calculations of heat losses in the flue gas, the ratio of useful heat to total heat available can be found.

$$\text{Useful heat} = \dot{m} * C_{p,coolant} * (T_{out} - T_{in})$$

The EPA and Diesel Exhaust Regulations

With increasing awareness of the negative impact diesel emissions have on Earth's environments and climate, regulations passed by the U.S. and other governments have steadily grown in number and strictness over the last 50 years. Due to growing concerns over the quality of air during the 1950s and through the 1960s, the Clean Air Act (CAA) of 1970 was passed. This established the first nation-wide regulations on emissions from industrial sources and automobiles. An enforcing body called the Environmental Protection Agency was established soon afterward to ensure that these regulations were followed. In 1996, the federal government set up a tiered regulation system to gradually roll in limits on toxins and greenhouse gases from diesel emissions, culminating in reductions of NO_x and hydrocarbons by at least 90% through improvements in engine design and reducing the concentration of toxins in the diesel itself, over the course of several years ("Emissions Standards- Nonroad Diesel Engines," 2013).

Emissions from boats, planes, cars and trucks contribute to over 28% of greenhouse gases in the United States. Carbon dioxide and carbon monoxide are two of the main pollutants in transport emissions, which account for 82% of overall emissions in the US. Over 90% of fuels used for transportation are petroleum based, including both gasoline and diesel. Emission standards for modes of transportation did not exist until 1970 when the U.S. congress passed The Clean Air Act. Five years later the act was finally put into place restricting pollutants such as carbon monoxide, volatile organic compounds (VOC), and various nitrogen oxides (NO_x). Through the 1980's and 90's certain amendments were made to the act further restricting NO_x emissions, and also allowed the EPA to assess air quality needs, cost effectiveness, and feasibility of tighter emission standards for the future (C. C. D. US EPA, 2014).

Although the United States has set forth laws and regulations governing emissions and their limitations, the global community has less strict standards. Global greenhouse gas emissions are caused by 5 main industries: energy, transportation, industrial, agriculture, and forestry. The transport sector CO₂ emissions represent 23% (globally) and 30% of overall CO₂ emissions from fossil fuel combustion. Global CO₂ emissions from transport have grown by over 45% from 1990 to 2007, and are expected to grow another 40% from 2007 to 2030 (Forum, 2010). However in December of 2009, the Copenhagen Accord was created which set emission reduction goals for countries. According to the document the United States was expected to decrease its total emissions by 17% (of 2005 standards) by 2020.

In 2005 the Energy Policy Act and the Diesel Emissions Reduction Act authorized the use of \$100 million annually to help truck fleet owners reduce diesel emissions. This could be done through the use of retrofit devices with verified EPA technologies, repairing and repowering engines, replacing older vehicles and equipment, and the use of cleaner fuels. Some technologies that are being used to reduce diesel fuel emissions in heavy vehicles are diesel oxidation catalysts, particulate filters, selective catalytic reduction, lean NO_x catalysts, and close crankcase ventilation. Many of these technologies chemically alter the exhaust fumes to turn them into safer products to be released in the environment. One other way of reducing the emission is to lower the temperature needed for combustion. This lowers the amount of particulates and reduces NO_x. One other alternative to reduce diesel emissions is to use Ultra-low Sulfur Diesel (ULSD). ULSD became required in 2007 for highway use, 2010 for non-road use, and 2012 for locomotive and marine use.

Measurement Methods

It has become increasingly important to be able to accurately measure the composition of diesel exhaust to ensure that engines comply with these strict regulations. One major method of measurement uses the optical absorption spectrums unique to each component of diesel exhaust to quantify their concentrations. This eliminates the possibility a particular sensor being cross-sensitive to other gases given that the sensor is calibrated and spectral resolution is tuned. Since carbon dioxide is the result of complete combustion of diesel, monitoring of carbon dioxide levels could be necessary since many pollutants such as carbon monoxide and NO_x are produced from incomplete combustion and oxidization of nitrogen compounds in the fuel. Carbon dioxide and carbon monoxide both absorb only in the infrared spectrum, as opposed to nitrogen dioxide and nitric oxide, which absorb in the ultraviolet spectrum. The advantage of carbon dioxide absorbing only in the infrared spectrum is that mid-infrared detection systems having relatively low costs can be installed on a vehicle tail pipe. Using an optical fiber filter for the absorption range of carbon dioxide with a minimum detection limit of 350 ppm, carbon dioxide can be reliably detected since carbon dioxide emissions from diesel engines are generally greater than 1% (Mulrooney, Clifford, Fitzpatrick, & Lewis, 2007).

Pitot Tube

Pitot tubes are used to determine air velocity within a cylinder. Calculations are based on the temperature, measured by another instrument, and pressure, measured by the Pitot tube. The calculation uses the assumption that the pressure of the air stream is made up of two quantities, the pressure of the air on the walls and the pressure of the moving air over and through the Pitot tube. The Pitot tube measures the pressure of the system and coordinates with a manometer to differentiate the two pressures, resulting in a velocity pressure.

Changes in temperature cause fluctuations in air density, which in turn will cause incorrect velocities to be produced. To fix for air density a correction shall be applied provided by Dwyer Instruments' specification pamphlet for this unit.

- Temperature measured in Absolute ($^{\circ}\text{F}+460$)
- Barometric Pressure measured in mmHg
- Velocity Pressure measured in inches H_2O
- Air Density measured in lbs/cubic foot

Table 3: Pitot Tube Specifications

Chapter 3: Methodology

It was desired to identify the differences in combustion emissions of biodiesel and petroleum diesel. This was completed using the existing combustion unit in the Unit Operations Lab. To achieve this, a Testo-340 flue gas analyzer was obtained. It was necessary to modify the ventilation system in order to safely evacuate the exhaust, and to add a port for obtaining measurements with the flue gas analyzer. The analyzer has the ability to measure the temperature of the flue gas, pressure drop, as well as concentrations of oxygen, carbon monoxide, sulfur dioxide, and several nitrogen oxides.

Testo-340 Meter and Operation

The Testo-340 meter is a hand-held device with a detachable probe to be inserted into an exhaust line. The meter contains four slots for interchangeable sensors to measure a number of combustion products. When sampling, the gas in the intake line of the probe first passes through a humidity trap to condense and remove water that could damage the sensors. The sensors have ranges of concentrations and exceeding these ranges may damage the sensors. The system has a sensor-protection mechanism that will automatically dilute the entering gas two-fold with ambient air. This occurs before any measurement is taken, and before shutdown of the device.

To obtain accurate readings of sample concentrations, it is recommended to calibrate the meter. Before calibrating, the instrument must first be switched on for at least 20 minutes to warm up. Low concentrations of exhaust components are inappropriate for calibration since this can lead to deviations in accuracy, so sensor protection is momentarily turned off. The Testo-340 automatically zeroes and calibrates itself when a gas is chosen. The team did not have access to pure calibration gases, so it was assumed that the meter was calibrated throughout all trials.

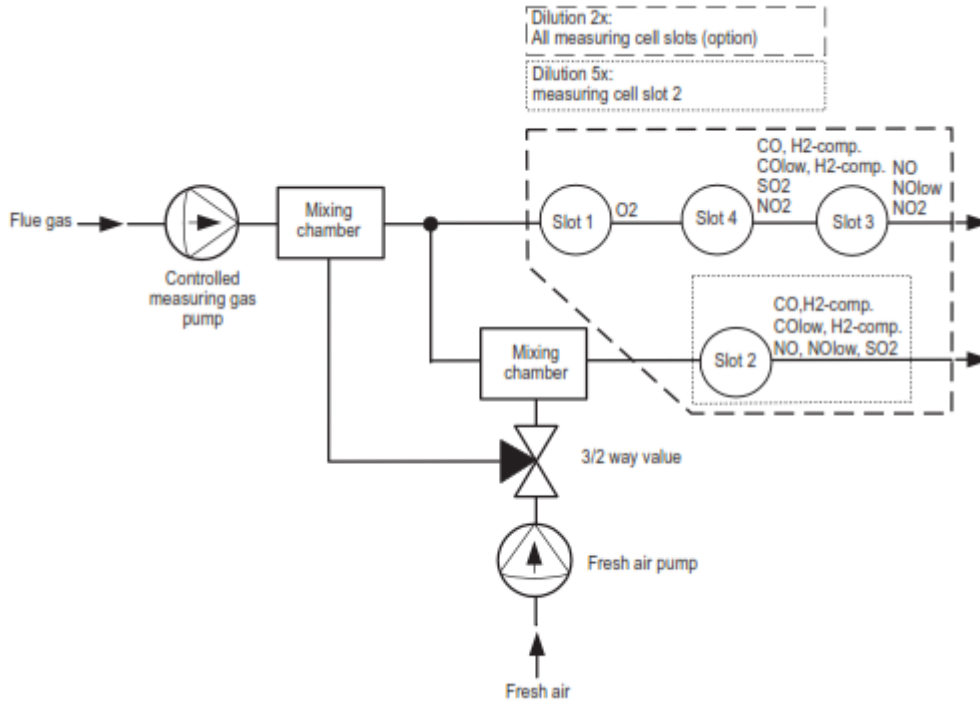

Figure 7: Testo-340 Schematic Mixing Chamber

Figure 7 is a schematic of the mixing chambers and the positions of sensors within the Testo-340 unit. It is notable to show that the flue gas is mixed with fresh air via two different mixing chambers. Since the meter itself pulls in ambient air, it is crucial that the exhaust system does not also add air into the site of measurement. The existence of extra air will cause severe deviations in the relative quantities of the emissions, especially that of oxygen.

Slot 1	Slot 2	Slot 3	Slot 4
O2	CO, H2-comp.	NO	CO, H2-comp.
	COlow, H2-comp.	NOlow	COlow, H2-comp.
	NO	NO2	SO2
	NOlow		NO2
	SO2		

Figure 8: Testo Slot Contents

Figure 8 describes the capabilities of each of the sensor slots. For the purpose of this study, it was desired to measure NO_x and CO gases in both diesel and biodiesel.

Taking Measurements

Before any measurements were taken, the tip of the probe was aligned so that the intake hole was centered in the flue. The sampling pipe was wide enough for this to occur without significantly blocking the flow. The measurements were taken in the center of the pipe.

Modification of Exhaust Ventilation System

To be able to sample exhaust for the purpose of measuring emissions concentrations, it was necessary to modify the ventilation system. It was determined that a 6-inch diameter metal duct was large enough to insert the flue gas analyzer probe while being suitable for directing the flow of exhaust into the overhead ventilation shafts. With the aid of the Unit Operations lab manager and machinist Tom Partington, these were mounted onto fixed steel brackets, and a 6-inch pipe tee closed on one end was added to catch condensing water vapor. A funnel-shaped pipe fitting was coupled with this tee, and fed into a 1 ½ inch diameter aluminum hose leading from the heater. A small hole was drilled into the side of the 6-inch duct for taking measurements. This hole was plugged with a bolt when not in use.



Figure 9: Ventilation System

Figure 9 shows the view of the exhaust system modified for this project. With aid from the machinist on campus, this setup was created to allow for proper air flow. Directly below the top mounting bar is a bolt used to securely close the vent. This is removed in order to do measurements using the Testo meter.

The ventilation system also had to be adjusted to decrease the vacuum pressure exerted on the combustion chamber. This was accomplished through the use of slide gate. The Tee vent connector was installed to catch water that may have condensed, not allowing to flow back into the combustion chamber.

Process of Producing Biodiesel at WPI Production

The WPI Unit Operations Laboratory is capable of creating biodiesel and purifying it through an ion-exchange resin. Currently senior level chemical engineering students produce the biodiesel in an experiment for the Unit Operations class. This is done using two computer controlled reactors. Methanol is used as the alcohol, and potassium hydroxide as the catalyst. Methanol and potassium hydroxide are mixed together in the first reactor vessel, while canola oil is heated in the second vessel. Once it reaches a predefined temperature, the methanol-catalyst mixture is pumped into the second vessel where the reaction occurs. This is kept at a constant temperature between 55°C-60°C through automated hot water baths. Upon completion the reaction is allowed to cool over a few days, during which two phases are formed. The heavier glycerol- rich phase is drained out of the bottom of the vessel first, then the biodiesel rich phase is recovered. This process typically takes around 2 hours and produces around 400mL of unpurified biodiesel (Belliard, Carcone, Swalec, & Zehnder, 2014).

The biodiesel used in this study was produced by students of the Unit Operations of Chemical Engineering course in WPI's Unit Operations Laboratory in Goddard Hall.

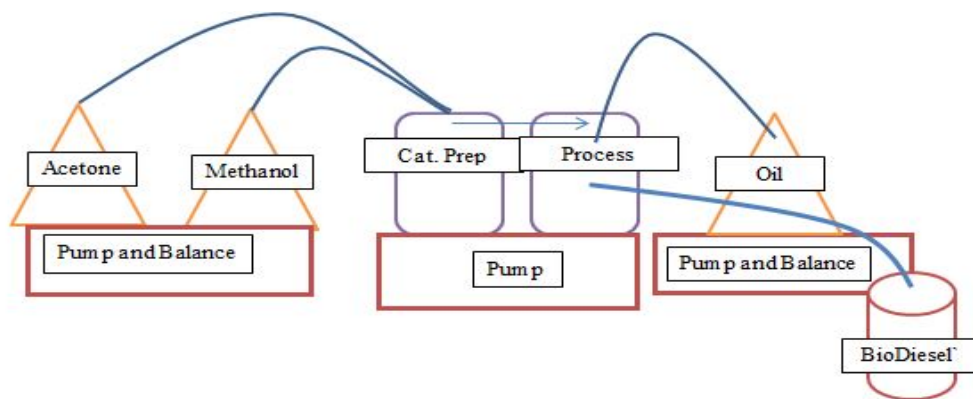

Figure 10: Biodiesel Production Schematic

Figures 10 and 11 display the setup used to produce biodiesel in the WPI Unit Operations Lab. The process diagram shown above includes the two reactors and the supply streams to the two reactions with one final biodiesel receiver. The software on a computer controls the system's two reactors are the Catalyst Preparation reactor and the Process reactor. The contents of the catalyst preparation reactor are pumped into the process reactor. Samples can be withdrawn from the process reactor and then analyzed for glycerol content. Acetone is used in between runs to clean the reactors.

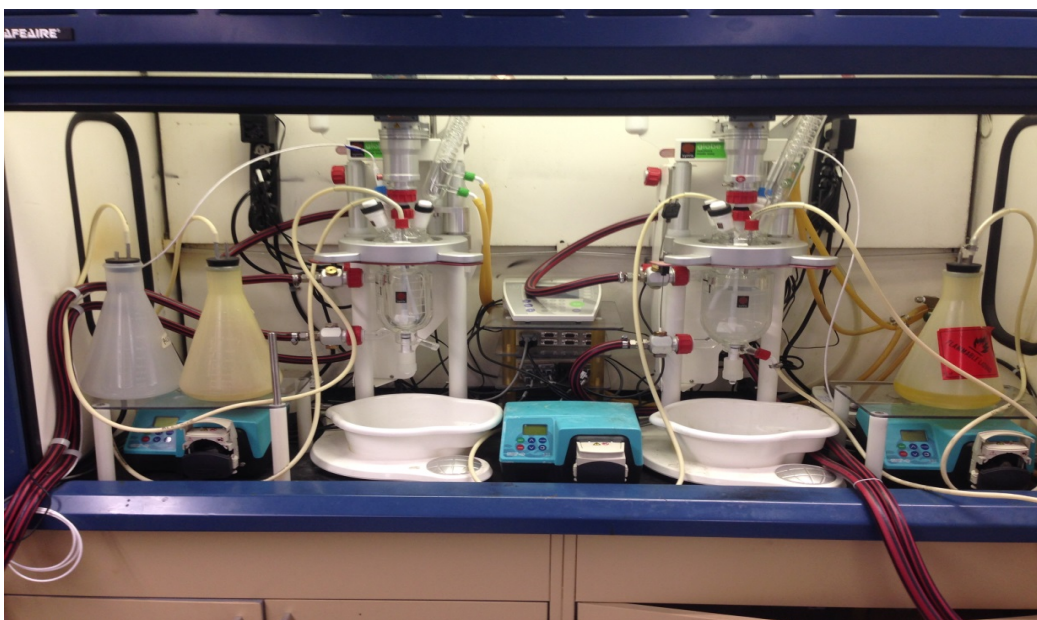

Figure 11: WPI Biodiesel Production Setup

The process produces a mixture of methanol, glycerol and biodiesel, which then must be purified to remove the methanol and glycerol. The process produces approximately 300-400mL of usable biodiesel every run (approx. 40 minutes). The batches made in the lab class were all prepared with canola oil but the system can produce biodiesel with other types of oils.

Purification

The excess methanol in the biodiesel phase is evaporated by subjecting the biodiesel to low pressures and temperatures around 65°C. The biodiesel rich phase is then purified through an ion-exchange resin. The resin is used to wash the biodiesel by extracting the residual glycerol, methanol, and catalyst. The system is set up so that water is not introduced to the biodiesel, otherwise known as dry-washing. The resin currently used in this process is Dudalite DW-R10 Ion Exchange Resin, which is was thought to have better adsorption rate than other resins. Although thorough testing has not been done to prove it, we expect the purified biodiesel to meet the ASTM standards for biodiesel (Belliard et al., 2014).

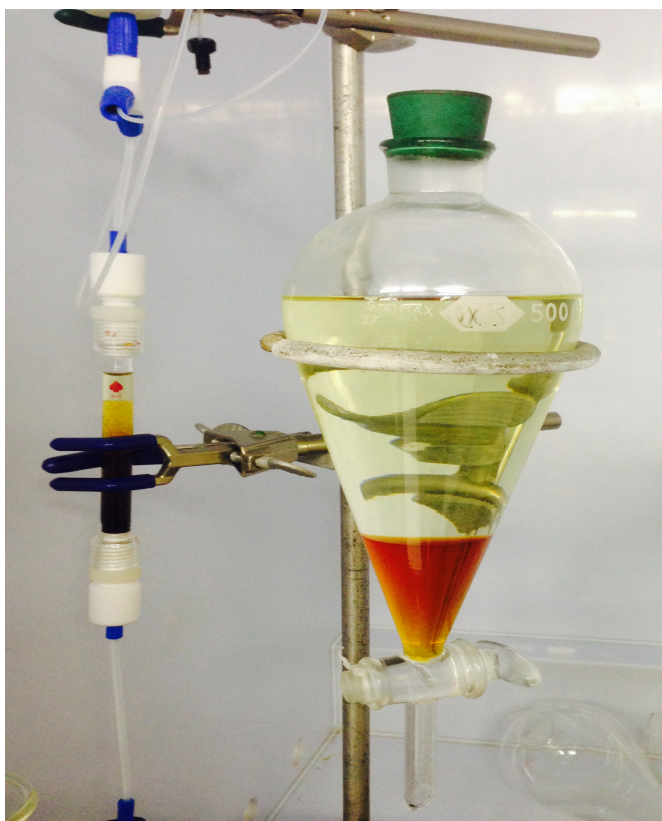

Figure 12: Two Phase Separation and Resin Column

Figure 12 is displaying the two phase separation of glycerol and refined biodiesel. The dark orange-brown phase, a mixture of mainly glycerol with trace amounts of biodiesel, is removed leaving the nearly pure biodiesel above. The ion exchange resin is shown on the left.

Experimental Procedure

The group's goal was to quantify the differences in exhaust compositions between biodiesel and petroleum-based diesel. Correlations were drawn between varying mixtures of petroleum-based diesel and biodiesel, and the measured concentrations of exhaust components from the fuel. The concentrations of many emissions components such as carbon dioxide, carbon monoxide, nitrogen oxides differ by the composition of the fuel type used. For completeness, the entire range of components that the Testo-340 meter can measure were tested for a range of mixtures.

Mixtures of biodiesel and petroleum diesel were made at 25%, 50% and 75% biodiesel along with the pure fuels. Biodiesel supplied by the Unit Operations lab was chosen to ensure the feed stock and method of preparation of the biodiesel were controlled. For a selected mixture, the fuel line was primed with fuel and the burner was allowed to go to steady state. This occurred when the exhaust temperature plateaued and became constant.

Burner Ignition Procedure:

- Ensure that the coolant system is filled.
- Lock the heater controller into its mount and connect it to the system.
- Plug the power supply into the outlet, and turn on the thermocouple power supply.
- Initiate the data logging program, QuickDAQ 2013. Ensure that all thermocouples are transmitting data properly.
- Load the fuel containers with desired fuel mixture.

- Place the fuel container on the scale ensuring there is enough fuel to supply.
- Open the yellow ball valve to supply tap water to the system.
- Open the blue handled valve to allow water to flow through the system. Adjust the water flow rate using the rotameter to the desired level.
- Press the red power button on the controller twice to turn the heater on, or until “120” is displayed. Begin logging temperature data in the data logging program. The coolant should begin flowing through the system at this point.
- If fuel is not pumping after 1min restart the system.
- Allow the thermocouple readings to plateau before taking exhaust measurements, which should take roughly ten minutes.

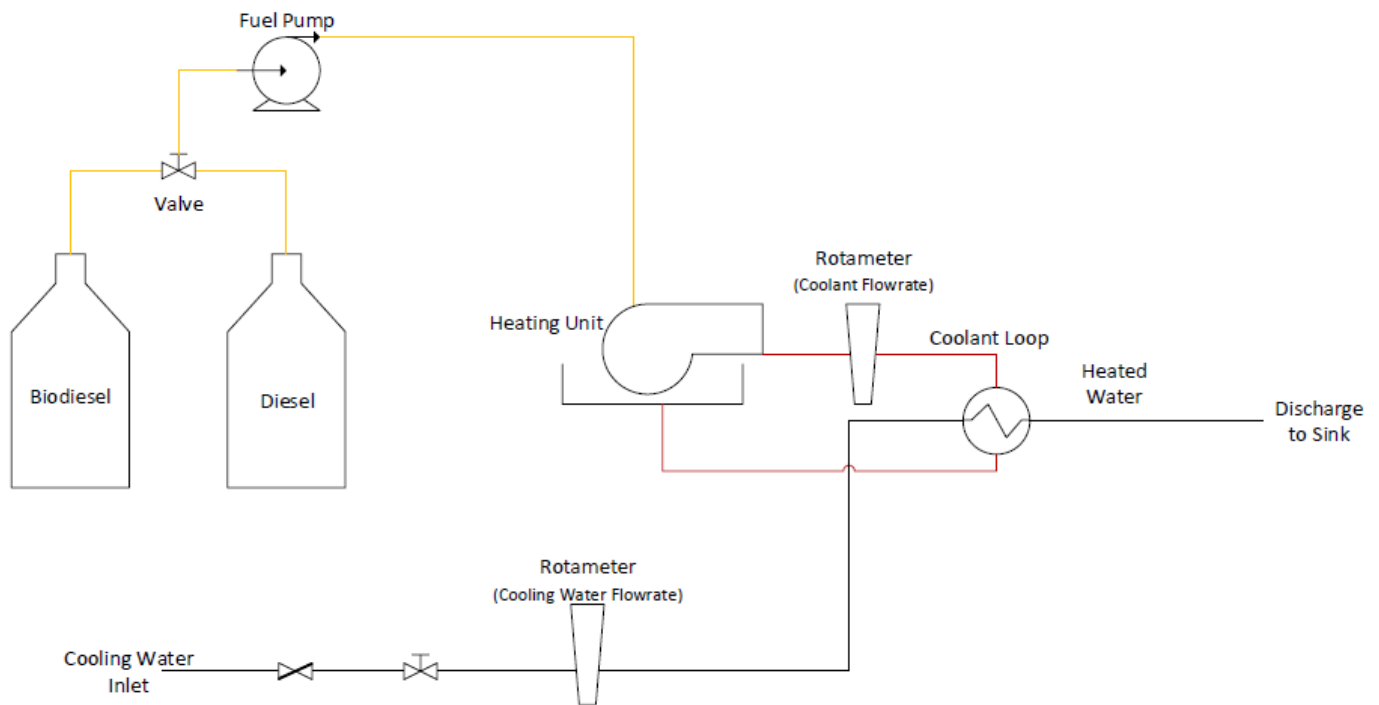

Figure 13: Schematic of Diesel and Biodiesel Heater and Heat Exchange Setup.

Testo Measurement Procedure

- Attach the probe to the Testo-340 by lining up the pins and locking into place
- Turn on power to the Testo-340 and remove the plastic tip on the probe
- Click “Oil Flow Rate” to enter the mass flow of the fuel in kg/hr
- Click “Ok Copy Readings” to set value
- Click “Flue Gas Test”
- As probe is zeroing, select “Diesel” as fuel type
- Adjust the probe length by moving the stopper to where the probe is centered in the exhaust line, roughly 3in into pipe
- Remove the screw from the exhaust line using heat resistant gloves and insert probe
- Click “Start” to begin measurement
- Hold in exhaust line until “Tstack” reaches a constant value, scroll up using the arrows to view this value if necessary.
- When done click “stop”
- Remove the probe from the exhaust line being careful not to touch the metal due to heat, and replace the screw into the exhaust hole using safety gear.
- Move through the results using the up and down arrows located on the front of the Testo-340.
- When finished, click the power button once and allow the probe to flush itself before replacing the plastic tip and storing the equipment.

Pitot Tube

There are two steps in the calculation to correct for change in temperature shown below (Instruments, 2005).

$$\begin{aligned} \text{Air Density} &= 1.325 * \frac{\text{Barometric Pressure}}{\text{Temperature}} \text{ \& Air Velocity} \\ &= 1096.2 \sqrt{\frac{\text{Velocity Pressure}}{\text{Air Density}}} \end{aligned}$$

Figure 14: Air Density and Velocity Calculations

The Pitot tube in our possession is a Series 160 Stainless Steel unit from Dwyer Instruments. This tube meets ASME, ANSI/AMCA, and ANSI/ASHRAE standards for fluid meters between 1 foot and 5 feet long (Instruments, 2005).

Sulfur Dioxide Sensor

To check if our SO₂ sensor was properly functioning, we placed a bundle of matches into a metal container and allowed them to burn. Once a fire had begun, we covered the container with a lid, and inserted the probe from the spout on the container. In order to insure the safety of the probe and its sensors, and to avoid overloading them we stopped the sensor after a few seconds. We were able to read sulfur dioxide in the smoke, indicating that our sensor was properly functioning.

Chapter 4: Results and Discussions

Emissions Analysis with Diesel-Biodiesel Mixtures

To determine the effects of fuel composition on toxic emission concentrations, the team ran a series of trials using the ESPAR heater and varying mixtures of diesel and biodiesel. Pure ultra-low sulfur diesel and canola oil-based biodiesel were used, as well as mixtures of the two containing 25%, 50%, and 75% biodiesel. We compared our data to Figure 5 which was done using a heavy-duty highway engine, while our data was collected using a cabin heater. The two apparatuses operate at very different temperatures and pressures, which may alter results. Also, while heavy-duty engines typically have fixed amounts of fuel that is burned per cycle, the cabin heater adjusts the amount of fuel burned to maximize efficiency. The data points are an average of three or four trials completed for each fuel mixture, giving concentrations of combustion byproducts in the flue gas.

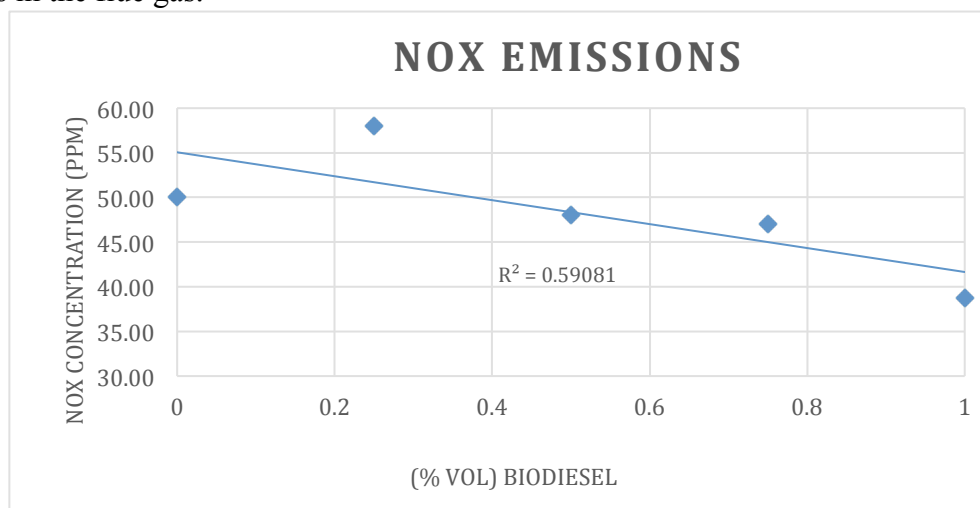

Figure 15: NO_x Concentration (ppm) Vs. Diesel-Biodiesel Composition

Nitrogen Oxide (NO_x) compounds' concentrations varied enough that a linear relationship could be verified. However, as the biodiesel percentage increases, the NO_x concentrations decreased. There was a large day-to-day variation of ground-water temperature,

which may have affected the fuel flow and burn rate. A constant cooling water flow rate was maintained throughout the trials, so this variation in temperature was not accounted for.

Although nearly half the literature shows an increase in NO_x as biodiesel increases, our results did not. These results can be explained through the heat content of the fuel. Biodiesel typically has a lower heating value than diesel fuel, and there was an overall decrease in stack temperature as biodiesel concentrations increased. Additionally, since NO_x formation has previously been found to increase as combustion temperature increases, the highly variable stack temperature likely had a significant effect on the NO_x concentrations. The following plot using data from all trials demonstrates this relationship:

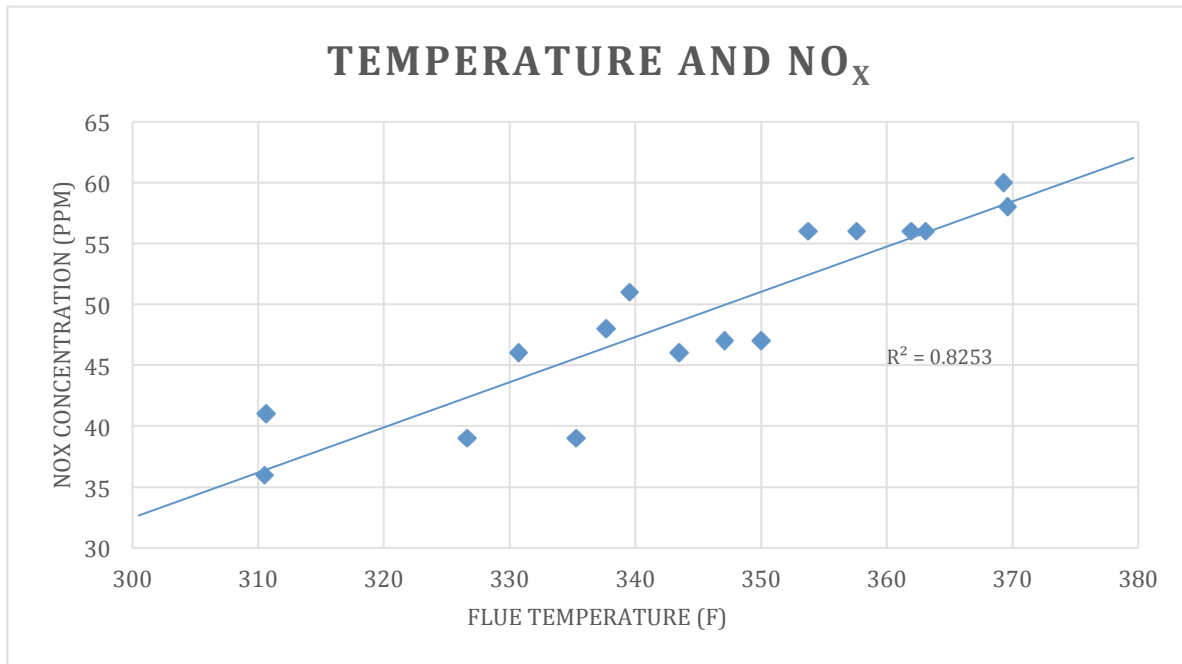

Figure 16: NO_x Concentration vs. Flue Temperature

The high variation in stack temperature may be due to the time at which measurements were taken, as well as positioning of the meter probe and duration of measurement. Each measurement was recorded once the temperature reading on the probe leveled off and seemed to

stay constant. It is clear from this data that NO_x formation tends to increase with temperature. This is also noted in the thermal formation kinetic for NO_x in combustion reactions.

Carbon monoxide was also measured for each diesel-biodiesel mixture. As with the NO_x measurements, the CO measurements were averaged for each diesel-biodiesel mixture type.

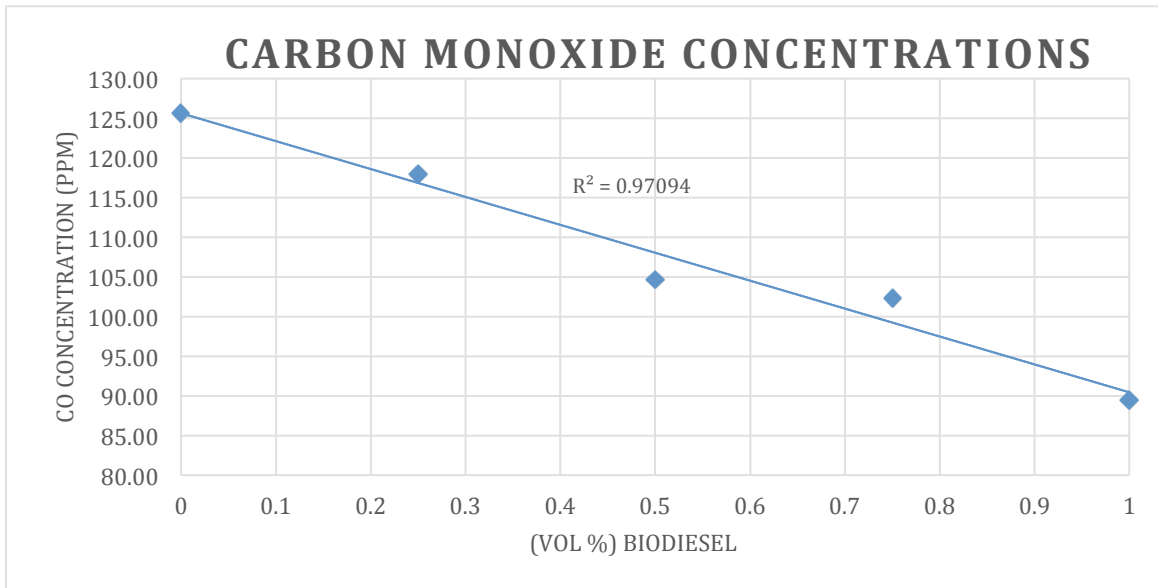

Figure 17: Carbon Monoxide Concentration vs. Biodiesel Composition

From the five points plotted, an R^2 value of 0.97 indicates a strong negative linear correlation between CO concentration in the exhaust and biodiesel composition. The decrease in CO emissions confirms literature results. This decrease in CO emissions is found in nearly all biodiesels, and is one of the main reasons for the interest in its use. Since CO has a stronger greenhouse effect than CO_2 , this is an extremely important factor to study.

Temperature Effects on Carbon Dioxide and Monoxide

The concentration of CO_2 in the exhaust and the amount of biodiesel in the fuel mixture were shown to have a possible correlation. As seen in Figure 18, CO_2 decreased as biodiesel

concentration increased, this could be caused by excess air which could dilute the exhaust measurements.

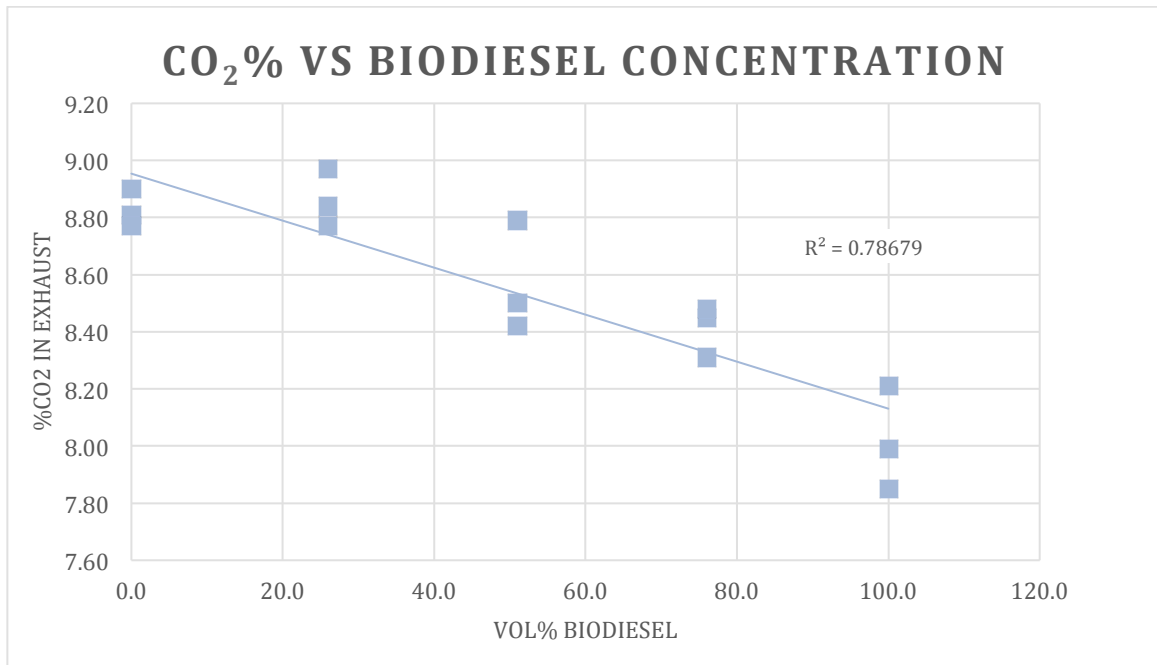

Figure 18: %CO₂ against Biodiesel Concentration

It was also shown that with an increase of temperature, carbon dioxide increased. This shows that with higher temperature, a cleaner burn is achieved, and therefore more carbon dioxide can form as a byproduct. This will need more testing with a controlled fuel composition to ensure that the amount of carbon dioxide in the exhaust is not dependent on the fuel composition but on temperature.

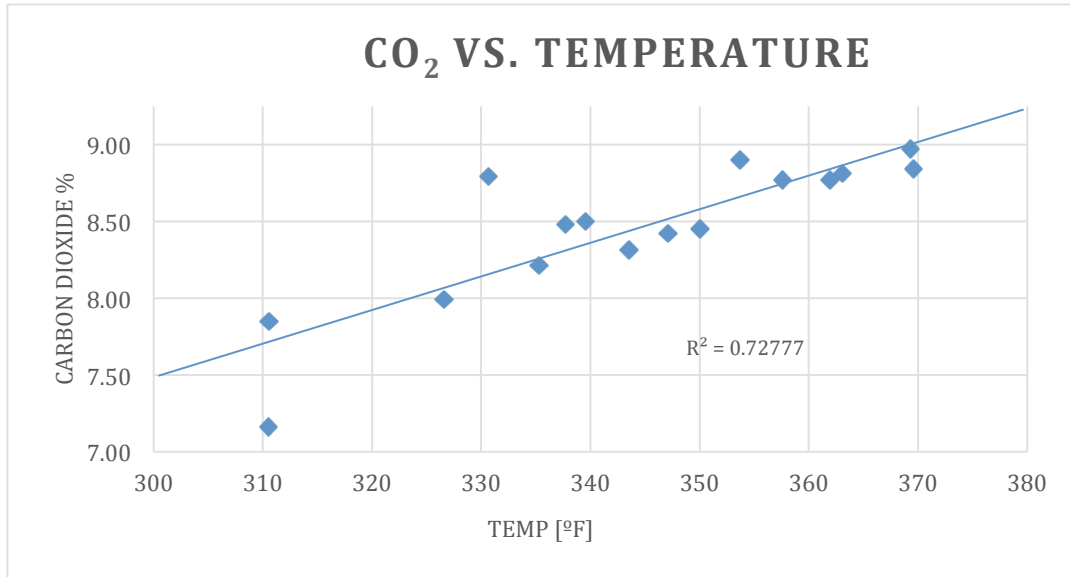

Figure 19: Carbon Dioxide vs. Temperature

Figure 19 is a plot of carbon dioxide concentration in the exhaust versus temperature. There appears to be a strong trend between the two, as indicated by the R^2 of 0.73. This could be a result of higher temperatures causing more fuel to burn due to greater ease of overcoming activation energy of combustion, releasing more carbon dioxide.

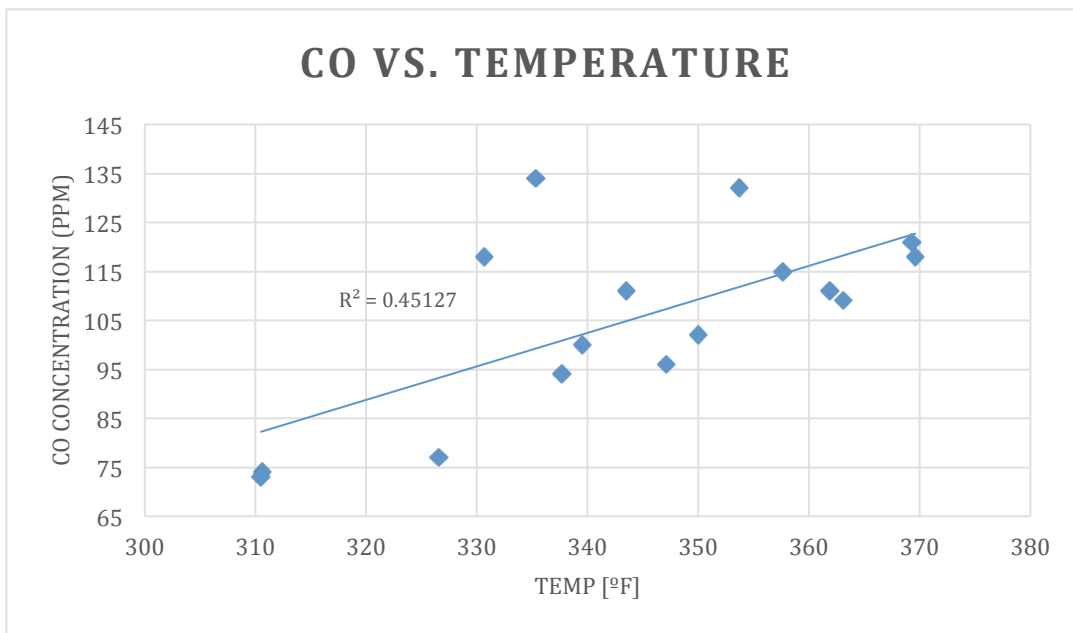

Figure 20: Carbon Monoxide vs. Temperature

Figure 20 is a plot of carbon monoxide concentration vs. temperature. The points appear to be scattered, and with an R^2 value of 0.45, there does not appear to be a significant relationship between the two. The carbon monoxide formed in the combustion of fuel was minuscule since complete combustion dominated incomplete combustion. Thus, the carbon monoxide compositions were much more susceptible to dilution from differing amounts of excess air.

The Testo-340 meter was able to calculate the amount of excess air in the stack based on the measured concentration of oxygen. Excess air is the air entering the combustion chamber that is additional to the stoichiometric amount of air required for complete combustion of the fuel. It was found that the amount of excess air present in the stack increased with increasing biodiesel composition. The excess air variation likely had an effect on the compositions of CO, CO₂, and NO_x.

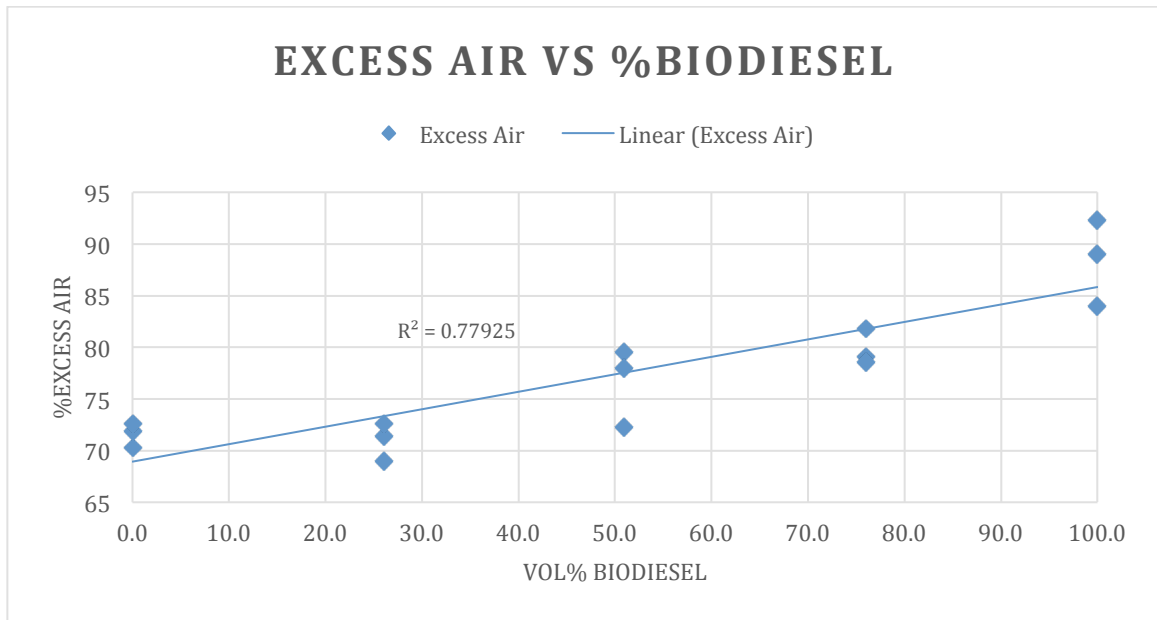

Figure 21: Excess Air vs Biodiesel Concentration

Since biodiesel is known to have a lower heating value than petroleum-based diesel and the heater pumps a constant volume of fuel into the combustion chamber, the combustion temperature decreased with increasing concentration of biodiesel. It is believed that the Espar heater controlled the temperature by changing the amount of excess air and as a consequence diluted the combustion products in the exhaust. This could account for the negative trends with percent biodiesel seen for all of the exhaust components.

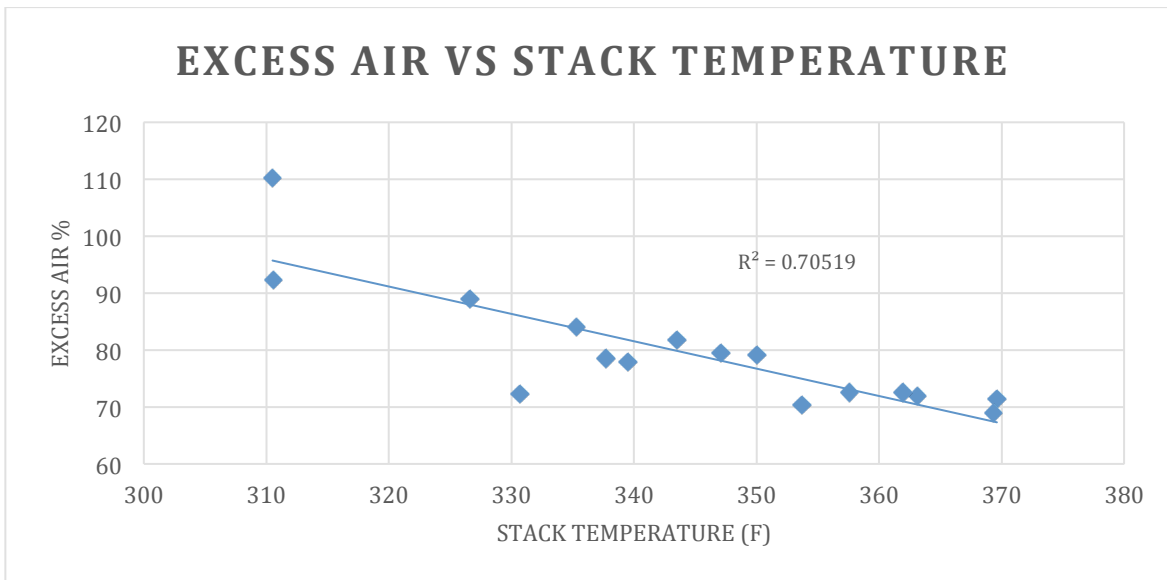

Figure 20: Excess vs Stack Temperature

Figure 22 shows that as combustion temperature decreased, the heaters computer compensated by increasing excess air pumped into the combustion chamber.

Sulfur Dioxide

The levels of sulfur dioxide in the emissions proved too low for the sensitivity of the Testo 340. The Testo exhaust meter was successfully able to record the sulfur given off when matches were lit giving a result on the parts per-million scale. This proved that the meter was able to read sulfur levels and that the diesel and biodiesel both lacked enough sulfur to be measured. This is due to the diesel being ultra-low sulfur diesel, which is required by the US

government's Environmental Protection Agency ("Emissions Standards- Nonroad Diesel Engines," 2013).

Completeness of Combustion and Mass Balance

The “completeness” of fuel combustion was determined using a ratio of carbon monoxide to carbon dioxide and a carbon balance. In a 100% efficient burner all of the fuel would be turned into carbon dioxide; therefore we can determine the efficiency of the burner by relating the percentages of the two gases in the exhaust to the total carbon present. As the carbon monoxide composition increases, it can be seen that the limit of the equation reaches 1, or 100% efficiency. This equation assumes that all fuel is consumed in the combustion reaction and formed either carbon dioxide or monoxide.

$$Completeness = \frac{\frac{\%CO_2}{100}}{\left(\frac{ppmCO}{1000000}\right) + \left(\frac{\%CO_2}{100}\right)}$$

The completeness of combustion was determined using this equation and the average exhaust compositions for each fuel mixture. The carbon monoxide compositions were extremely low compared to those of carbon dioxide, so it was expected that the majority of the fuel completely combusted. There was very little difference between the fuels, but the trend showed that as the percentage of biodiesel increased in the fuel mixture, the efficiency increased as well.

However, as shown in Figure 20, the relatively small differences in calculated completeness of combustion, and possible uncertainty in measurements, it can be concluded that all fuel types had approximately equal completeness of combustion ratings.

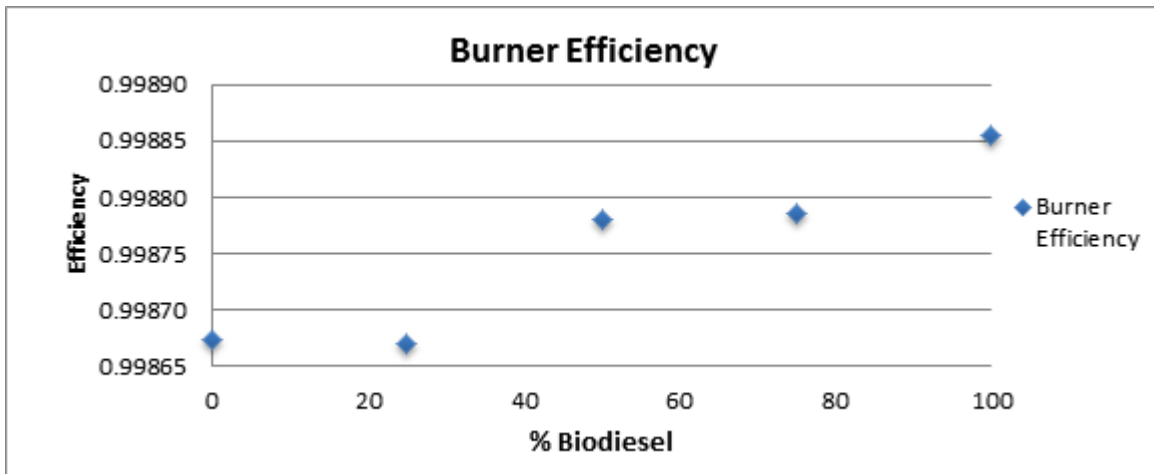

Figure 21: Burner Efficiency

Heater Efficiency

Heater efficiency for each trial was determined by calculating the heat duty of the coolant entering and exiting the heater, and dividing by the higher heating value of the fuel used. The higher heating value of mixtures were assumed to be a weighted average of the higher heating values of pure diesel and pure biodiesel. The higher heating value of the biodiesel was taken to be the average heating value for canola-based biodiesels (Hoekman et al., 2012).

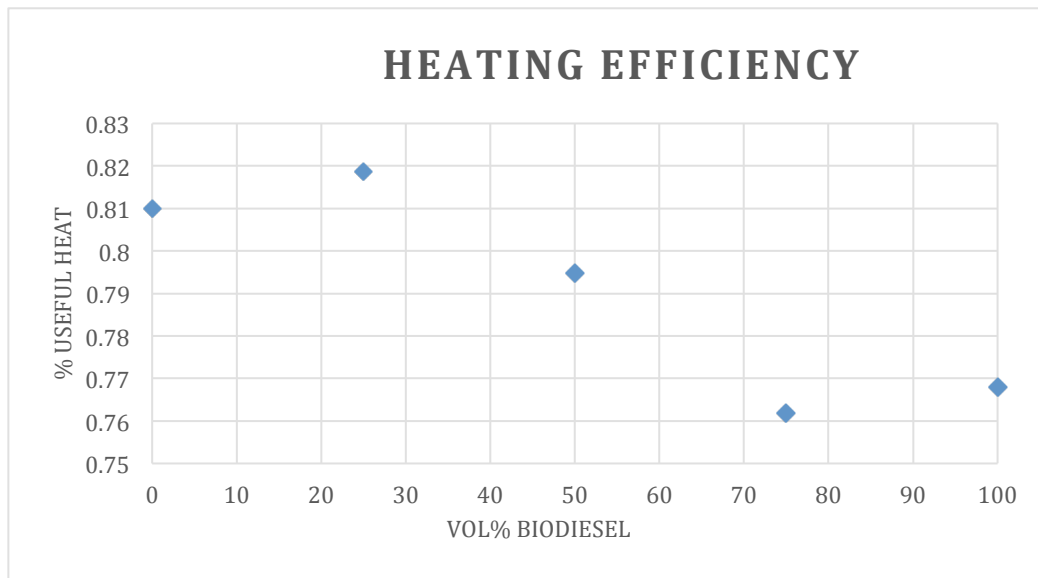

Figure 22: Average Heating Efficiency for Pure Fuels and Mixtures

There appears to be a negative trend in heating efficiency with increasing biodiesel composition. The efficiency values used to compute the average were highly scattered, so this could merely be a coincidence. Further testing would need to be done to establish the significance and establish possible meaning in the trends shown. It is also possible that some intermediate mixture between pure substances, could contain an optimal amount of heating efficiency based on the way diesel and biodiesel interact in mixture.

Pitot Tube

The tests with the Dwyer Pitot tube, described in the background section: *Pitot Tube*, gave no readings when connected to the Testo 340's location for a fluid velocity pressure. The flow within the exhaust was too low to be read by the Pitot tube, which was designed for higher velocity pressures. This was proved by the use of the gas flow apparatus within WPI's Goddard Hall, where the group used air flow from this apparatus to gather a positive reading from the Pitot tube.

Chapter 5: Conclusions and Recommendations

Conclusions

The emission trends determined in this experiment showed a difference between varying mixtures of diesel and biodiesel. Differences were also found in the amount of useful heat obtained from the fuels, which could be indicative of the differences in the fuels' energy contents. The data in this project was collected over several months and changes in ambient temperatures may have had an effect on the data gathered. The coolant water temperature also varied between 5 and 12 degrees Celsius. Fuel consumption varies due to the pre-programmed nature of the heater as a result of change in coolant water temperature. This resulted in some inconsistencies because the preprogrammed behavior may have caused fluctuations in emissions data. For example, NO_x gases are highly temperature dependent and the burner may have caused significant variation in temperatures. A hotter coolant fluid would suggest that less heat is able to be removed because coolant water flow-rate was kept constant. Assuming the heater is programmed to stay within a safe temperature range, the heater would need to burn less fuel to release less heat. This uncertainty may cause some difficulty when attempting to identify an unknown solution for a Unit Operations Lab experiment. The team was able to determine the emissions in the stack relatively easily, making it a great addition to the lab experiment proposed by Belliard et al. A combination of the heat exchanger analysis and determining emission trends may be a significant workload for a Unit Operations experiment.

The team was able to ascertain emissions trends of exhaust gases with different fuel types utilizing the Testo-340. It was found that as biodiesel concentrations increased in the fuel mixtures, carbon monoxide levels decreased. The carbon monoxide concentration held a

negative linear relationship with increasing percentage of biodiesel. These results held true with varying fuel mixtures and agreed with results in the literature.

A negative linear trend was also found between nitrogen oxide emissions and increasing percentage of biodiesel. Nitrogen oxide formation is highly dependent on temperature and the fuel type used in these experiments varied the temperature of combustion. This may have been due to the heat content of the fuel decreasing from pure diesel to pure biodiesel but also from the uncertainties described in the heater's programming. The temperature dependence of nitrogen oxide emissions suggested in previous literature was confirmed with a positive linear trend between exhaust temperature and nitrogen oxide concentration ("Nitrogen Oxides (NO_x)," 2015).

A significant positive correlation was found between carbon dioxide composition and stack temperature. This could be indicative of greater stack temperatures resulting in more even combustion of fuel and greater amounts reacting to form carbon dioxide. A less significant positive trend was found between carbon monoxide exhaust composition and stack temperature. The carbon monoxide composition data may have been affected by varying dilution with excess air. With further testing and controlling for excess air, a stronger correlation could be established.

The team also desired to test sulfur oxide emissions and to measure exhaust gas velocity. However the concentration of sulfur oxides in the exhaust proved to be too low for the Testo-340 to measure, and the exhaust velocity was also too low for the use of the Pitot tube. The Pitot tube specifies that measurements should be done using a diameter 30 times than that of the Pitot tube which proved impossible with the size of the duct. Pitot tubes are discussed further detail in the recommendations.

The heating efficiency of the fuels in the burner was also determined. The heating efficiency fell as the percentage of biodiesel increased in the mixture. This trend was relatively linear. This may have been due to the computer within the heater adjusting for different fuel types and heat content. As the biodiesel burned, less heat was released due to its lower heat content. The computer adjusted for this and increased fuel consumption, which inadvertently lowered the efficiency of the burner itself. Due to experimental error, the upper and lower limits of the equipment, and the relatively small differences in the group's results on completeness of combustion this trend was determined to be insignificant.

The heating efficiency of the fuel mixture in the burner was also determined. The heating efficiency fell as the percentage of biodiesel increased in the mixture. This trend was relatively linear. This may have been due to the computer within the heater adjusting for different fuel types and heat content. As the biodiesel burned, less heat was released due to its lower heat content. The computer may have accounted for this by increasing air consumption which would lower the temperature in the stack and furthermore would decrease the concentrations of the exhaust products. Due to experimental error, the upper and lower limits of the equipment, and the relatively small differences in the group's results on completeness of combustion this trend was determined to be insignificant.

Recommendations

Combined Lab with Heat Exchanger

One of the goals for this project was to determine if a senior level Unit Operations lab experiment could be developed utilizing the devices acquired for this project. The team found that it could be used as part of the experiment proposed by Belliard et al. for the heat exchanger attached to the heater setup. In order for this to be a Unit Operations experiment, it must meet

several criteria: it must be able to be completed within two four-hour time frames, it must include theory that students have acquired from previous classes, and require students to apply this theory to the problem. The goals of the previous experiment proposed by Belliard et al. included determining the dependence of the overall heat transfer coefficient on the cooling water flow rate and the dependence of the heat duty on the fuel composition. To supplement these goals, the students would be required to take emission samples from the exhaust of different fuel mixtures of biodiesel and diesel to determine the overall efficiency of the combustion reaction occurring. They would also be able to use correlations between the temperature of the stack and the heat content of the fuels. The previous team reported that the experiment they designed may only require two hours, so this supplement would fit within the other two hours of allotted lab time.

The students would record emission percentages of carbon dioxide, carbon monoxide, oxygen, as well as the temperature of the exhaust line. The experiment would pull from the student's knowledge of combustion chemistry and unit conversion in order to complete this lab. This would provide students with experience dealing with new types of measurement equipment, as well as emissions and flue gas testing. This would also provide students with exposure to alternative fuels and show them first-hand differences in emissions.

Calorimeter Testing and Elemental Analysis

The Fire Protection Lab has multiple calorimeters that would allow students to test the amount of stored energy in different types of fuels. This would also allow for increased accuracy of calculations when determining the efficiency of the overall system; including the heat exchanger. In addition, this would offer insight as to the energy content of the fuel compared with estimates from literature values.

In order to carry out a more precise carbon balance on the system, Elemental Analysis equipment could be advantageous. The equipment completely burns a predetermined amount of fuel by pumping pure oxygen into the combustion chamber. It then forces exhaust gases over different materials that selectively adsorb gaseous carbon dioxide and water as exhaust flows over them and allow other components to pass. The change in weight in the adsorbent material can be directly related to the amount of CO₂ and H₂O in the exhaust. The amounts of CO₂ and H₂O can be used to obtain an average molecular formula for the unknown fuel.

Fuel Line Protection

To further protect the project and fuel lines, it is highly recommended that a secondary specialized polymer fuel line is purchased. The blue fuel line is polymer that does not decay with biodiesel usage. Currently there are two flasks for fuel consumption. One of the lines is biodiesel-specific with a more expensive fuel line designed to handle the harsher properties of biodiesel. The other line is for diesel fuel, but cannot properly handle the biodiesel. It would be highly useful to have a second biodiesel capable line so that a continuous run is possible. Currently it is required to shut off the burning prompting its relatively long shutdown procedure, and then remove the fuel to switch mixtures. For example with two lines available, a 50% mixture and a 75% mixture could be stored or run by switching the valve without the need for shutdown procedure.

Pipe Insulation

The exhaust pipe that is currently part of the heater is more a conductive area and does not retain heat in the exhaust well because it is uninsulated metal. Our recommendation is that as

much of the exhaust line as possible be insulated to increase accuracy stack temperature readings, and in turn allow more precise calculation.

Coolant Fluid Change

Changing the coolant fluid may allow for a proper sealing eliminating the air bubbles seen during heater operation. This would eliminate the need to account for the heat capacity of air in the coolant, allowing for more accurate heat exchange data and calculations.

Fuels Derived From Other Feedstocks

This project solely utilized biodiesel produced from canola oil, made by WPI students. It could be of interest to test different oil feedstocks to determine other efficiencies, emission trends, and study which source shows the most consistent results. Newport Biodiesel provided the previous group with biodiesel produced from waste oil; it would be interesting to note the emissions of this versus the canola based produced in the WPI laboratory.

Pitot Tube

It may be desired in the future to measure the velocity of the exhaust to carry out the mass balance on the fuel-exhaust system. A Pitot tube would be an appropriate tool for this purpose, and one has been acquired. The Pitot tube is able to measure the difference between the total pressure and the static pressure, which is velocity pressure. This can be used to compute the velocity of a fluid using Bernoulli's equation (NASA, 2014).

$$p_s + \rho * \frac{V^2}{2} = p_t$$

$$V = \sqrt{\frac{2 * (p_t - p_s)}{\rho}}$$

The Pitot tube's specifications were provided by the manufacturer Dwyer Instruments, these specifications require extreme care to ensure its advertised accuracy of plus or minus 2%. These specifications and precautions instructed the placement depending on the Testo-340, duct type, and diameter of the tube over 10 diameter lengths of ventilation pipe. The specifications are as follows (Instruments, 2005):

- The duct diameter must be 30 times larger than that of the diameter of the pitot tube
- A traverse sketch must be made according to Dwyer's sketch nature
- The duct must be smooth and straight 8.5 diameters upstream and 1.5 diameters downstream from the Pitot tube
- An egg crate type straightener must be placed upstream from the pitot tube

It is recommended that further studies are conducted using this device to find the velocity of exhaust flow.

Glossary:

ASME – American Society of Mechanical Engineers

Biodiesel – Fuel with similar properties as diesel, but derived from organics such as vegetable oil, soybeans, or sunflower oil.

FAME – Fatty Acid Methyl Ester

NO_x – Nitrogen Oxides such as NO, NO₂, NO₃, N₂O₅ among others.

Petroleum Diesel – Diesel fuel derived from petroleum crude materials.

SO_x – Sulfuric Oxides such as SO₂, SO₃ among others.

ULSD – Ultra Low Sulfur Diesel

Appendices:

Date	Fuel Type	Time (s)	g/s	Temperature Data C					<u>Tstack (F)</u>
				Heater Out	HEX Hot In	HEX Hot Out	HEX Cold In	HEX Cold Out	
2/3	B100	157	0.229	33.4	30.2	21.2	7.5	16.9	310.6
2/4	B100	60	0.233	31.08	31	22.04	8.24	17.82	326.6
2/7	B100	140	0.229	37.09	36.95	28.19	15.11	24.62	310.5
2/7	Diesel	94	0.213	36	35.88	26.43	12.11	22.35	353.7
2/18	B100	118	0.229	30	29.9	20.6	6.5	16.2	335.3
2/18	B50	148	0.223	30.6	30.4	20.8	6.22	16.2	330.7
2/20	B50	58	0.224	29.94	29.86	20.29	5.85	15.76	347.1
2/20	B50	135	0.222	29.8	29.7	20.1	5.35	15.3	339.5
2/20	B75	120	0.233	29.4	29.4	20	5.4	15.2	350
2/22	B75	144	0.229	36.3	36.1	27.3	13.8	23.4	343.5
2/22	B75	133	0.226	34.35	34.29	25.23	11.26	21.08	337.7
2/25	B25	90	0.217	31.02	30.8	21	6.2	16.43	369.6
2/25	B25	90	0.211	31.4	31.6	21.5	5.9	18.45	369.3
2/25	B25	90	0.222	30.7	30.55	21.98	6	17.45	357.6
2/27	Diesel	139	0.216	31.55	31.44	21.71	6.78	16.98	363.1
2/27	Diesel	129	0.217	30.9	30.8	21.1	6.05	16.2	361.9

Table 4: Fuel Data: Flow Rate, Heat Exchange, Stack Temperature

Date	Fuel Type	O2%	CO (ppm)	NO (ppm)	<u>Nox</u> (ppm)	<u>Tamb</u> (F)	CO2 (%)	Cooling Water Flow Rate (% of 4.8 gal/min)	Coolant Flow Rate (% of 0.062 gpm)
2/3	B100	10.43	74	39	41	71.9	7.85	54	55
2/4	B100	10.24	77	37	39	70.9	7.99	54	55
2/7	B100	11.36	73	34	36	69.7	7.16	54	57
2/7	Diesel	9.01	132	53	56	71.3	8.90	54	56
2/18	B100	9.94	134	37	39	73	8.21	54	55
2/18	B50	9.16	118	44	46	73.7	8.79	54	55
2/20	B50	9.65	96	45	47	71.8	8.42	54	55
2/20	B50	9.55	100	49	51	75.7	8.50	54	55
2/20	B75	9.62	102	45	47	74.6	8.45	54	55
2/22	B75	9.8	111	44	46	72.2	8.31	54	57
2/22	B75	9.58	94	46	48	73.4	8.48	54	56
2/25	B25	9.09	118	55	58	75.2	8.84	54	58
2/25	B25	8.92	121	57	60	76.8	9	54	57
2/25	B25	9.18	115	53	56	76.3	8.8	54	57
2/27	Diesel	9.13	109	53	56	73	8.8	54	57
2/27	Diesel	9.18	111	53	56	73.7	8.8	54	57

Table 5: Fuel Data: Emissions and Coolant Flow

Date	Fuel Type	Coolant V (L/s)	Coolant Cp kJ/kg K	Qc (kW)	HHV (kJ/kg)	LHV (kJ/kg)	Qc/HHV
2/3	B100	0.0021483	3.44	9.66	41300	38900	1.02
2/4	B100	0.0021483	3.44	7.16	41300	38900	0.74
2/7	B100	0.00222642	3.44	7.30	41300	38900	0.77
2/7	Diesel	0.00218736	3.44	7.71	45560	42612	0.80
2/18	B100	0.0021483	3.44	7.44	41300	38900	0.79
2/18	B50	0.0021483	3.44	7.76	43387	40718.9	0.80
2/20	B50	0.0021483	3.44	7.64	43387	40718.9	0.79
2/20	B50	0.0021483	3.44	7.68	43387	40718.9	0.80
2/20	B75	0.0021483	3.44	7.44	42322	39790.9	0.75
2/22	B75	0.00222642	3.44	7.38	42322	39790.9	0.76
2/22	B75	0.00218736	3.44	7.35	42322	39790.9	0.77
2/25	B25	0.00226548	3.44	8.37	44495	41684	0.87
2/25	B25	0.00222642	3.44	8.12	44495	41684	0.86
2/25	B25	0.00222642	3.44	7.15	44495	41684	0.72
2/27	Diesel	0.00222642	3.44	8.07	45560	45560	0.82
2/27	Diesel	0.00222642	3.44	8.04	45560	45560	0.81

Table 6: Fuel Data: Coolant and Heating Value Data

References:

- Agency, E. P. (1998). NOx: How Nitrogen Oxides affect the way we live and breathe. Retrieved from: http://www.nchh.org/Portals/0/Contents/EPA_Nitrogen_Oxides.pdf
- Belliard, B., Carcone, E., Swalec, J., & Zehnder, J. (2014). Biodiesel Combustion and Heat Exchanger Unit Operations Lab (Major Qualifying Project). In P. W. Clark (Ed.). Biofuel.org. (2010). Biofuel Chemistry: How they Burn? Retrieved January 25th, 2015 . Combustion Analysis Basics. (2004): TSI Incorporated.
- Demirbas, A. (2008). *Biodiesel: a realistic fuel alternative for diesel engines*. London: Springer.
- Durrenberger, J. (1983). FURNACE EFFICIENCY TESTING.
- Emissions Standards- Nonroad Diesel Engines. (2013). Retrieved September 5, 2014, from <http://www.dieselnet.com/standards/us/nonroad.php#tier3>
- EPA. (1975). Guidelines For Residential Oil-Burner Adjustments (pp. 26). EPA, Office of Research and Development: EPA.
- Forum, I. T. (2010). Reducing Transport Greenhouse Gas Emissions: Trends and Data. Retrieved from: <http://www.internationaltransportforum.org/Pub/pdf/10GHGTrends.pdf>
- Hill, J., Nelson, E., Tilman, D., Polasky, S., & Tiffany, D. (2006). Environmental, Economic, and Energetic Costs and Benefits of Biodiesel and Ethanol Biofuels. *Proceedings of the National Academy of Sciences of the United States of America*, 103(30), 11206-11210. doi: 10.1073/pnas.0604600103
- Hoekman, S. K., Broch, A., Robbins, C., Cenicerros, E., & Natarajan, M. (2012). Review of biodiesel composition, properties, and specifications. *Renewable and Sustainable Energy Reviews*, 16(1), 143-169. doi: 10.1016/j.rser.2011.07.143
- Instruments, D. (2005). Series 160 Stainless Steel Pitot Tubes *Instruments* (8 ed., Vol. 440226-00).
- Johnson, C. (2015). Automotive Engine - Physics and Mechanics. from <http://mb-soft.com/public2/engine.html>
- Knothe, G. (2010). Biodiesel and renewable diesel: A comparison. *Progress in Energy and Combustion Science*, 36(3), 364-373. doi: <http://dx.doi.org/10.1016/j.pecs.2009.11.004>
- Martinez, G., Sanchez, N., Encinar, J. M., & Gonzalez, J. F. (2014). Fuel properties of biodiesel from vegetable oils and oil mixtures. Influence of methyl esters distribution. *BIOMASS & BIOENERGY*, 63, 22-32. doi: 10.1016/j.biombioe.2014.01.034
- Meher, L. C., Vidya Sagar, D., & Naik, S. N. (2006). Technical aspects of biodiesel production by transesterification—a review. *Renewable and Sustainable Energy Reviews*, 10(3), 248-268. doi: <http://dx.doi.org/10.1016/j.rser.2004.09.002>
- Mulrooney, J., Clifford, J., Fitzpatrick, C., & Lewis, E. (2007). Detection of carbon dioxide emissions from a diesel engine using a mid-infrared optical fibre based sensor. *Sensors & Actuators: A. Physical*, 136(1), 104-110. doi: 10.1016/j.sna.2006.11.016
- NASA. (2014). Pitot-Static Tube. from <http://www.grc.nasa.gov/WWW/k-12/airplane/pitot.html>
- Nitrogen Oxides (NOx). (2015). from http://www.apis.ac.uk/overview/pollutants/overview_NOx.htm
- Oxides of nitrogen emissions from biodiesel-fuelled diesel engines. (2010). 36(6), 677–695. doi: 10.1016/j.pecs.2010.02.004
- US EPA, C. C. D. (2014). Greenhouse Gas Emissions: Greenhouse Gases Overview.

US EPA, O., OAQPS. (2014). Nitrogen Dioxide.

Van Gerpen, J. (2014). Commercial and Large Scale Biodiesel Production Systems - eXtension. 1.

Vehicle Emissions | Air Pollution | City Diesel | LPG | CNG. (2015). from <http://www.air-quality.org.uk/26.php>

Yazdani, S. S., & Gonzalez, R. (2007). Anaerobic fermentation of glycerol: a path to economic viability for the biofuels industry. *Current Opinion in Biotechnology*, 18(3), 213-219. doi: <http://dx.doi.org/10.1016/j.copbio.2007.05.002>



testo 340
Flue gas analyser

Instruction manual

en









General notes

Please read this documentation through carefully and familiarise yourself with the operation of the product before putting it to use. Keep this document to hand so that you can refer to it when necessary.

This document describes the country-specific version **GB** of the testo 340 measuring instrument.

Identification

Symbol	Meaning	Comments
 Warning!	Warning advice: Warning! Serious physical injury could be caused if the specified precautionary measures are not taken.	Read the warning advice carefully and take the specified precautionary measures!
 Caution!	Warning advice: Caution! Slight physical injury or damage to equipment could occur if the specified precautionary measures are not taken.	Read the warning advice carefully and take the specified precautionary measures!
	Important note.	Please take particular notice.
Text	Text appears on the instrument's display	-
	Key	Press the key.
	Function key with the function "OK".	Press function key.
 → xyz	Short form for operating steps.	See <i>Short form</i> , p. 3.







Short form

This document uses a short form for describing steps (e.g. calling up a function).

Example: Calling up the **Flue gas** function

Short form:  → **Measurements** →  → **Flue gas** → 
(1) (2) (3) (4) (5)

Steps required:

- 1 Open the Main menu: .
- 2 Select **Measurements** menu: , .
- 3 Confirm selection: .
- 4 Select **Flue gas** menu: , .
- 5 Confirm selection: .



Content

! See also *Functional overview*, p. 60.

General notes	2
Content	4
A. Safety advice	7
B. Intended purpose	9
C. Product description	10
C.1 Measuring instrument	10
C.1.1 Overview	10
C.1.2 Keypad	11
C.1.3 Display	11
C.1.4 Instrument connections	12
C.1.5 Interfaces	13
C.1.6 Components	13
C.1.7 Carrying strap	14
C.2 Modular flue gas probe	14
D. Commissioning	14
E. Operation	15
E.1 Mains unit/rechargeable battery	15
E.1.1 Changing the battery	15
E.1.2 Charging batteries	16
E.1.3 Operation with the mains unit	16
E.2 Probes/sensors	17
E.2.1 Connecting probes/sensors	17
E.2.2 Replacing the probe module	18
E.3 Regular care	18
E.3.1 Condensate trap	18
E.3.2 Checking/replacing the particle filter	19

E.4	Basic operating steps	19
E.4.1	Switching the measuring instrument on	19
E.4.2	Calling up the function	20
E.4.3	Entering values	20
E.4.4	Printing data	21
E.4.5	Saving data	21
E.4.6	Confirming an error message	21
E.4.7	Switching the measuring instrument off	21
E.5	Memory	22
E.5.1	Folders	22
E.5.2	Location	23
E.5.3	Protocols	24
E.5.4	Extras Memory	25
E.6	Instrument diagnosis	26
F.	Configuration	26
F.1	Instrument settings	27
F.1.1	Display edit	27
F.1.2	Printer	28
F.1.3	Start keys edit	29
F.1.4	AutoOff	29
F.1.5	Communication	30
F.1.6	Date/Time	30
F.1.7	Language	30
F.2	Sensor settings	31
F.3	Fuels	35
G.	Measuring	36
G.1	Preparing measurements	36
G.1.1	Zeroing phases	36
G.1.2	Using the modular flue gas probe	37
G.1.3	Configuring the reading display	37
G.1.4	Set location/fuel	37
G.2.1	Flue gas, Flue gas + m/s, Flue gas + Dp2	38
G.2.2	Program	39
G.2.3	Draught	40
G.2.4	Smoke#/HCT	40
G.2.5	Gas flow rate	41
G.2.6	Oil flow rate	42
G.2.7	m/s	42
G.2.8	Dp2	43
G.2.9	Burner control	43



6 Content

H.	Transferring data	45
H.1	Protocol printer	45
I.	Care and maintenance	46
I.1	Cleaning the measuring instrument	46
I.2	Replacing sensors	46
I.3	Filter for CO, H ₂ -comp., NO exchanging sensors	47
I.4	Recalibrating sensors	47
I.5	Cleaning the modular flue gas probe	48
I.6	Replacing probe preliminary filter	48
I.7	Replacing thermocouple	48
J.	Questions and answers	49
K.	Technical data	50
K.1	Standards and tests	50
K.2	Measuring ranges and accuracies	50
K.3	Other instrument data	52
K.4	EC declaration of conformity	53
K.5	Principles of calculation	53
K.5.1	Fuel parameters	54
K.5.2	Calculation formulae	54
K.6	Recommended rinsing times	57
L.	Accessories/spare parts	58
	Functional overview	60

A. Safety advice

Avoid electrical hazards:

- ▶ Never use the measuring instrument and probes to measure on or near live parts!

Protect the measuring instrument:

- ▶ Never store the measuring instrument/sensors together with solvents (e.g. acetone). Do not use any desiccants.

Product with **Bluetooth®** (Option)

Changes or modifications, which are not expressly approved by the responsible official body, can lead to a withdrawal of operating permission.

Interference with data transfer can be caused by instruments which transmit on the same ISM band, e.g. microwave ovens, ZigBee

The use of radio connections is not allowed in e.g. aeroplanes and hospitals. For this reason, the following point must be checked before entering:

- ▶ Deactivate Bluetooth function

 → **Inst' settings** → → **Communication** → → Select **IrDA**

Product safety/ **preserving warranty claims:**

- ▶ Operate the measuring instrument only within the parameters specified in the Technical data.
- ▶ Handle the measuring instrument properly and according to its intended purpose.
- ▶ Never apply force!
- ▶ Temperatures given on probes/sensors relate only to the measuring range of the sensors. Do not expose handles and feed lines to any temperatures in excess of 70 °C unless they are expressly permitted for higher temperatures.
- ▶ Open the measuring instrument only when this is expressly described in the instruction manual for maintenance purposes.
- ▶ Carry out only the maintenance and repair work that is described in the instruction manual. Follow the prescribed steps exactly. For safety reasons, use only original spare parts from Testo.



8 A. Safety advice

Any additional work must only be carried out by authorised personnel. Testo will otherwise refuse to accept responsibility for the proper functioning of the measuring instrument after repair and for the validity of certifications.



Ensure correct disposal:

- ▶ Dispose of defective rechargeable batteries and spent batteries at the collection points provided for that purpose.
- ▶ Send the measuring instrument directly to us at the end of its useful life. We will ensure that it is disposed of in an environmentally friendly manner.

B. Intended purpose

This chapter describes the areas of application for which the measuring instrument is intended.

The testo 340 is a handheld measuring instrument used in professional flue gas analysis for:

- Engineers servicing/monitoring industrial combustion plants (process systems, power stations)
- Emissions inspectors
- Engine manufacturers and operators
- Service engineers/mechanics of burner/boiler manufacturers in the industrial sector

Typical measuring tasks and particular characteristics of the testo 340 include:

- Measurement on industrial engines (CO/NO dilution)
- Measurement on gas turbines (high precision CO and NO plus optional dilution)
- Emissions measurement (integrated flow speed and differential pressure measurement)

testo 340 should not be used:

- for continuous measurements > 2 h
- as a safety (alarm) instrument

! The testo 340 with the Bluetooth option may only be operated in countries in which it is type approved (see Technical Data).

C. Product description

This chapter provides an overview of the individual components of the product.

C.1 Measuring instrument

C.1.1 Overview



① Infrared interface



Do not point infrared beam at people's eyes!

② Interfaces: USB, PS2

③ On/Off switch

④ Condensate trap (on rear)

⑤ Attachment for carrying strap (on rear)

⑥ Magnetic holders (on rear)



Caution!

Strong magnets

Damage to other instruments!

► Keep well away from products which could be damaged through the effects of magnetism (e.g. monitors, computers, heart pacemakers, credit cards).









⑦ Display

⑧ Service cover (on rear)

⑨ Keypad

⑩ Instrument connections: flue gas probe, sensor, pressure probe, mains unit, gas outlet

C.1.2 Keypad

Key	Functions
	Switch measuring instrument on/off
	Function key (orange, 3x), relevant function is shown on the display
	Scroll up, increase value
	Scroll down, reduce value
	Back, cancel function
	Open Main menu : press briefly (changed settings are stored, measurement values are carried over into the menu Flue gas); open Measurements menu: press and hold down for 2s (changed settings are stored, measurement values are carried over into the menu Flue gas)
	Open Inst' diagnosis menu
	Change display light: display light stays on permanently or display light is switched on for 10s every time the key is pressed.

C.1.3 Display

Depending on the menu that is active, the display shows a variety of elements.

Header (active in all views)









①

②

③

- ① Warning symbol (only if there is a device error; device errors are displayed in the **Inst' diagnosis** menu).
- ② Active folder and location.
- ③ Power supply symbol:

Symbol	Characteristic	Symbol	Characteristic
	Mains operation		Rech. battery operation, capacity: 26-50%
	Rech. battery operation, capacity: 76-100%		Rech. battery operation, capacity: 6-25%
	Rech. battery operation, capacity: 51-75%		Rech. battery operation, capacity: 0-5%

Function select view



Measurements
Light oil

①

Flue gas
Flue gas + m/s
Flue gas + Δp2
Program
Draught
Smoke # / HCT
Oil flow rate

②

③

Fuel

OK

④

- ① Active menu, activated fuel
- ② Function selection field:
The selected function has a grey background.
Unavailable functions are written in grey type
- ③ Scroll bar
- ④ Function keys for entering commands

Settings view

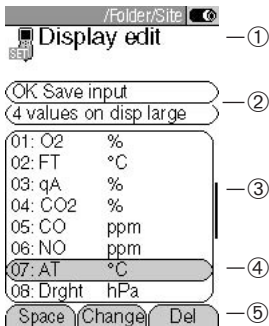

- ① Active menu
- ② Function fields for entering commands
- ③ Scroll bar
- ④ Selection field for adjustable values:
The selected value is shown with a grey background. Unavailable values are written in grey type.
- ⑤ Function keys for entering commands

Measuring view

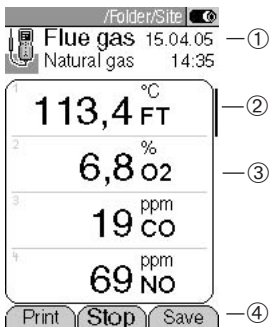

- ① Active menu, depending on the selected function:
Additional information (e.g. activated fuel, date and time)
- ② Scroll bar
- ③ Display field for readings, parameters
- ④ Function keys for entering commands

C.1.4 Instrument connections

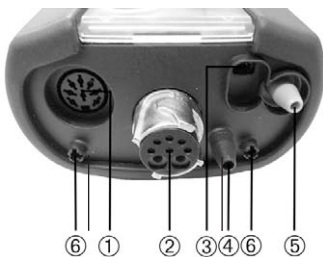

- ① Sensor socket
- ② Flue gas socket
- ③ Mains unit socket
- ④ Pressure socket p+
- ⑤ Pressure socket p-
- ⑥ Gas outlet

C.1.5 Interfaces



- ① USB interface:
connection to PC
- ② PS2 interface:
Adapter for automatic furnaces
- ③ Ir/IrDA interface
- ④ Bluetooth interface

C.1.6 Components

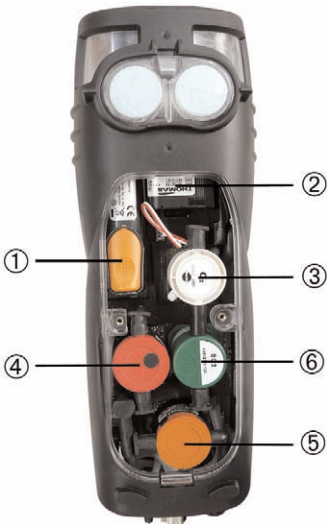

- ① Rechargeable battery
- ② Measuring gas pump
- ③ Sensor slot 1: O₂
- ④ Sensor slot 2: CO, CO_{low}, NO, NO_{low}, SO₂
- ⑤ Sensor slot 3: NO, NO_{low}, NO₂
- ⑥ Sensor slot 4: CO, CO_{low}, SO₂, NO₂

C.1.7 Carrying strap

To secure the carrying strap:



- 1 Place the measuring instrument on its front.
- 2 Attach carrying strap in the fixture (①).

C.2 Modular flue gas probe

Place the
Abgassonde

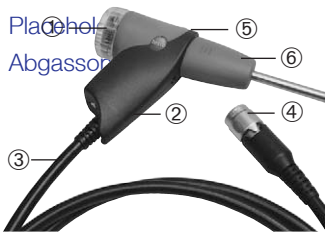

- ① Removable filter chamber with window and particle filter
- ② Probe handle
- ③ Connecting lead
- ④ Connecting plug for measuring instrument
- ⑤ Probe module release
- ⑥ Probe module

D. Commissioning

This chapter describes the steps required to commission the product.

- ▶ Remove the protective film from the display.

The measuring instrument is supplied with a rechargeable battery already fitted.

- ▶ Charge the rechargeable battery up fully before using the measuring instrument (see *Charging batteries*, p. 16).

E. Operation

This chapter describes the steps that have to be executed frequently when using the product.

! Please read this chapter carefully. The following chapters of this document will assume you are already familiar with the content of this chapter.

E.1 Mains unit/rechargeable battery

If the mains unit is connected, the measuring instrument is automatically powered from the mains unit. It is not possible to charge the rechargeable battery in the measuring instrument during operation.

E.1.1 Changing the battery

! The measuring instrument must not be connected to a mains socket via the mains unit. The measuring instrument must be switched off. Change the rechargeable battery within 60 minutes, otherwise instrument settings (e.g. date/time) will be lost.

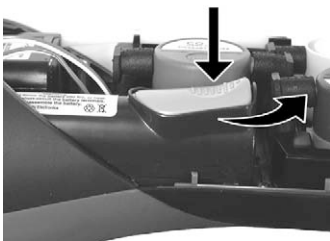

- 1 Place the measuring instrument on its front.
- 2 Loosen screws with a Phillips screwdriver, release clip in the direction of the arrow and remove service cover.
- 3 Open the rechargeable battery compartment: Press the orange key and push in the direction of the arrow.
- 4 Remove the rechargeable battery and insert a new one. Use only Testo 0515 0100 rechargeable batteries!
- 5 Close the rechargeable battery compartment: Press the orange key and push against the direction of the arrow until the rechargeable battery engages.
- 6 Replace and close service cover (clip must click in), fix with screws.

E.1.2 Charging batteries

The rechargeable battery can only be charged at an ambient temperature of $\pm 0...+35^{\circ}\text{C}$. If the rechargeable battery has discharged completely, the charging time at room temperature is approx. 5-6 hrs.

Charging in the measuring instrument

! The measuring instrument must be switched off.

- 1 Connect the plug of the mains unit to the mains unit socket on the measuring instrument.
- 2 Connect the mains plug of the mains unit to a mains socket.
 - The charging process will start. The charge status will be shown on the display. The charging process will stop automatically when the rechargeable battery is fully charged.

Charging in the charger (0554 1103)

- ▶ Refer to the documentation that comes with the charger.

Battery care

- ▶ If possible, always discharge the rechargeable battery and recharge it fully.
- ▶ Do not store the battery for long periods when discharged. (The best storage conditions are at 50-80 % charge level and 10-20 °C ambient temperature; charge fully before further use).

E.1.3 Operation with the mains unit

- 1 Connect the plug of the mains unit to the mains unit socket on the measuring instrument.
- 2 Connect the mains plug of the mains unit to a mains socket.
 - The measuring instrument is powered via the mains unit.
 - If the measuring instrument is switched off and a rechargeable battery is inserted, the charging process will start automatically. Switching the measuring instrument on has the effect of stopping rechargeable battery charging and the measuring instrument is then powered via the mains unit.

E.2 Probes/sensors

E.2.1 Connecting probes/sensors

! Sensor socket:

Sensor detection is carried out at the sensor socket during the activation process: Always connect the sensors you need to the measuring instrument before switching it on or switch the device on and then off again after a change of sensor so that the correct sensor data are read into the measuring instrument.

Flue gas socket:

Probe/sensor detection at the flue gas socket is carried out continuously. It is possible to change the probe/sensor even while the measuring instrument is switched on.

Connecting flue gas probes



- ▶ Plug the connector onto the flue gas socket and lock by turning it clockwise gently (bayonet lock).

- ! There must be no more than two extension leads (0554 1202) between the measuring instrument and the flue gas probe.

Connecting other sensors



- ▶ Insert the connector of the sensor into the sensor socket.

Connecting the pressure tube



- ▶ Connect the pressure tube/tubes to the connecting nipple/nipples of the pressure socket(s).

E.2.2 Replacing the probe module

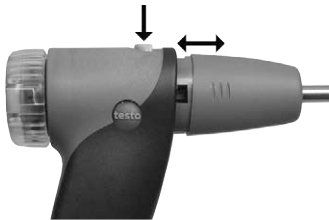

- 1 Press the key on the top of the probe handle and remove the probe module.
- 2 Fit a new probe module and engage it in place.

E.3 Regular care

E.3.1 Condensate trap

The fill level of the condensate trap can be read from the markings on the trap. A warning message is displayed if the level in the condensate trap reaches 90% (⚠, red flashing light).

Emptying the condensate trap

! The condensate consists of a weak mix of acids. Avoid contact with the skin. Make sure that the condensate does not run over the housing.



Caution!

Condensate entering the gas path.

Damage to the sensors and flue gas pump!

- ▶ Do not empty the condensate trap while the flue gas pump is in operation.



- 1 Hold the measuring instrument so that the condensate outlet points up.
- 2 Open the condensate outlet of the condensate trap: Push out approx. 7 mm to the stop).
- 3 Let the condensate run out into a sink .
- 4 Mop up any remaining drops on the condensate outlet using a cloth.
- 5 Close the condensate outlet.

! The condensate outlet must be completely closed (marking), otherwise measuring errors could occur if external air gets in.

E.3.2 Checking/replacing the particle filter

Checking the particle filter:



- ▶ Check the particle filter of the modular flue gas probe for contamination at regular intervals: Check visually by looking through the window of the filter chamber. Replace the filter if there are signs of contamination

Replacing the particle filter:

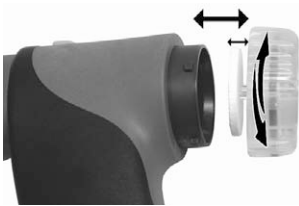

! The filter chamber may contain condensate

- 1 Open the filter chamber by turning it gently anticlockwise.
- 2 Remove the filter plate and replace it with a new one (0554 3385).
- 3 Fit the filter chamber again and close it by turning it gently clockwise.

E.4 Basic operating steps

E.4.1 Switching the measuring instrument on

▶

- The start screen is displayed (for about 5 s).
- Display light is switched on for 10 s.

Option:

- ▶ To go directly to a measurement while the start screen is being displayed, press the function key for the desired measurement. See also *Start keys edit*, p. 29.

- The **Measurements** menu is opened.

-or-



- If the power supply was interrupted for a longer period: the **Date/Time** menu is opened.

-or-

- There is a device error: The **Error diagnosis** is displayed.

E.4.2 Calling up the function

! Functions which cannot be selected because the required sensor/probe is not connected are shown in grey type.







- 1 Select function: , .
 - The selected function is shown with a grey background.
- 2 Confirm selection: .
 - The selected function is opened.

E.4.3 Entering values

Some functions require values (numbers, units, characters) to be entered. Depending on the function that is selected, the values are entered via either a list field or an input editor.





List field



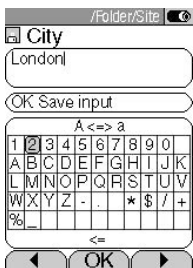



- 1 Select the value to be changed (number, unit): , .
- 2 Adjust the value: , .
- 3 Repeat steps 1 and 2 as required.
- 4 Confirm the input: .
- 5 Save the input: **OK Save input** → .

Input editor



- 1 Select value (character): , , , .
- 2 Accept the value: .

Options:

- ▶ Switch between uppercase/lowercase letters: **A <=> a** (not always available).
- ▶ Delete character: **<=**.
- ▶ To position the cursor in the text: Select the text input field: ,  and position the cursor: , .
 - ▶ To delete character in front of the cursor: .

- 3 Repeat steps 1 and 2 as required.
- 4 Save the input: **OK Save input** → **OK**.

E.4.4 Printing data

Data are printed out via the function key **Print**. The function is only available if a printout is possible.

If data are to be transferred to a protocol printer via the infrared or Bluetooth interface, the printer that is to be used must be activated, see *Printer*, p. 28.

E.4.5 Saving data

Data are saved either via the function key **Save** or the function field **OK Save input**. The functions are only available if saving is possible.

See also *Memory*, p. 22.

E.4.6 Confirming an error message

If an error occurs, an error message is shown in the display.

- ▶ To confirm an error message: **OK**.

Errors which have occurred and have not yet been rectified are shown by a warning symbol in the header (⚠).

Messages for errors which have not yet been rectified can be viewed in the **Error diagnosis** menu, see *Instrument diagnosis*, p. 26.

E.4.7 Switching the measuring instrument off

! Unsaved readings are lost when the measuring instrument is switched off.

- ▶ .
- Possibly: The pump starts and the sensors are rinsed until the shutoff thresholds ($O_2 > 20\%$, other parameters $< 50\text{ppm}$) are reached. Rinsing lasts no more than 2 minutes.
- The measuring instrument switches off.

E.5 Memory

All readings are allocated to the location that is activated at the time and can be saved in the Flue gas menus. Unsaved readings are lost when the measuring instrument is switched off.

Folders and locations can be created (max. 100 folders, max. 10 locations per folder), edited and activated and measurement protocols can be printed.

The special function **Extras memory** can be used to display the remaining free memory space. All protocols can be printed or deleted. The entire memory (folders and locations incl. protocols) can also be cleared.

Calling up the function:

 → **Memory** → .

E.5.1 Folders

Creating a new folder:

Folders are given a unique identification via the folder number. A folder number can only be allocated once. The folder number cannot be changed afterwards.

- 1 **New Folder** → .
- 2 Select **Folder Number** → .
- 3 Enter values → **OK Save input** → .
- 4 Repeat steps 2 and 3 for the other criteria as required.
- 5 .

Ordering the folders list:

- 1 **Folders list**.
- 2 Select the order criterion: , , .

Restoring the folders list:

- ▶ Order the list in the sequence in which the folders were created:
Restore list → .

Editing folders:

- ▶ Select the folder.

Options:

- ▶ Delete the folder: .
- ▶ Edit the folder: .

E.5.2 Location

Creating a new location:

A location is always created in a folder.

- 1 Select the folder → → **New location** → .
- 2 Select the **Location name** → .
- 3 Enter values → **OK Save input** → .
- 4 Repeat steps 2 and 3 for the other criteria accordingly.
- 5 **OK Go to measurement** or **OK To location** → .

Ordering the locations list:

- 1 Select the folder → .
- 2 **Locations list** → .

Activating a location:

- ▶ Select the folder → → Select location → .
- The location is activated and the **Measurements** menu is opened.

Restoring the locations list:

- ▶ To arrange the list in the order in which the folders were created:
Select the folder → → **Restore list** → .

Delete a location:

- 1 Select the folder → .
- 2 Select the location → .
- 3 Select **Delete site with data** → .

Performing location settings:

For flow speed, air flow and mass flow to be measured correctly, the shape and surface area of the cross-section must be set.

The parameters **Pitot factor** and **Offset factor** influence the measurement of flow speed, air flow and mass flow. The pitot factor depends on the type of pitot tube that is used.

The offset factor should be set at 1.00 for all standard applications.

The parameters **Temp./amb.** (ambient air temperature), **Hum/amb.** (ambient air humidity) and **Dew p./amb.** (ambient air dew point) influence calculation of the q_A (Flue gas loss) and DP (Flue gas dew point temperature). The parameters should be set to the factory settings for all standard applications (Temp./amb.: 20.0 °C, Hum/amb.: 80.0 %, Dew p./amb.: 16.4 °C). To achieve greater accuracy, the values can be adjusted to the actual ambient conditions.

If the ambient air temperature sensor is plugged in, the value for Temp./amb. is accepted automatically. The parameter **Dew p./amb.** can be calculated from the values of **Temp./amb.** and **Hum/amb.** via the function key .

1 Select the folder → .

2 Select the location → .

Options:

▶ To set the shape of the cross-section:

Cross section → → Select the cross-section → .

▶ To set the surface area of the cross-section:

Cross section → → Select the cross-section → → Set the values → .

▶ To set parameters:

Select the parameter → → Set the values → .

3 **OK To location** → .

E.5.3 Protocols

Printing/deleting all protocols:

▶ Select the folder → → Select a location → .

- The saved protocols are displayed. Protocols of measurement programs are marked with a vertical line and the number of individual measurements (e.g. **I245**), for more than 999 measurements dots are used (**I...**). If automatic furnace data are stored with a measurement protocol the following symbol is displayed next to the protocol name: . The data are printed with the protocol printout.

Options:

▶ To print all data: Print all → .

▶ To delete all data: Delete all → .

Displaying/printing/deleting an individual protocol:

- 1 Select the folder → → Select a location → .
 - The saved protocols are displayed. Protocols of measurement programs are marked with a vertical line and the number of individual measurements (e.g. **I245**), for more than 999 measurements dots are used (**I...**). If automatic furnace data are stored with a measurement protocol the following symbol is displayed next to the protocol name: . The data are printed with the protocol printout.
- 2 Select the protocol → .
- Options:**
- ▶ To print the data: .
 - ▶ To delete the data: .

E.5.4 Extras Memory

Calling up the function:

- ▶  → **Memory** → .
 - The remaining free memory space is displayed.
- Options:**
- ▶ **Print all data** → .
 - ▶ **Delete all data** → .
 - ▶ **Delete memory** → .

E.6 Instrument diagnosis

Important operating values and instrument data are displayed. A gas path check can be carried out. The status of the sensors and any device errors not yet rectified can be displayed.

Calling up the function:

▶  → Inst' diagnosis.

-or-

▶ .

Performing a gas path check:

1 **Gas path check** → .

2 Place the black sealing cap on the tip of the flue gas probe.

- The pump flow is displayed. If the flow rate ≤ 0.02 l/min, the gas paths are not leaking.

3 End the check: .

Viewing device errors:

▶ **Error diagnosis** → .

- Unrectified errors are displayed.

▶ View next/previous error: , .

Viewing the sensor diagnosis:

1 **Sensor check** → .

- Possibly: Gas zeroing (30 s).

2 Select the sensor: , .

- The status of the sensor is displayed.

F. Configuration

This chapter describes the possible steps for adapting the product to the particular measurement task or the requirements of the user.

! Familiarity with the contents of the chapter *Operation* (see p. 15) is assumed.

F.1 Instrument settings

F.1.1 Display edit

The parameters/units and the display representation (number of readings displayed per display page) can be set.

Available parameters and units (may vary from one instrument to another):

Display	Parameter	Units
FT	Flue gas temperature	°C, °F
AT	Ambient temperature	°C, °F
CO2	Carbon dioxide	%
O2	Oxygen	%
CO	Carbon monoxide	ppm, %, g/GJ mg/m ³ , mg/kW
uCO	Carbon monoxide undiluted	ppm
NO	Nitrogen monoxide	ppm, %, g/GJ, mg/m ³ , mg/kW
NOx	Nitrogen oxide	ppm, %, g/GJ, mg/m ³ , mg/kW
AT	Ambient temperature	°C, °F
Drght	Flue draught	mbar, hPa, mmWS, inW, Pa, psi, inHG
S02	Sulfur dioxide	ppm, %, g/GJ mg/m ³ , mg/kW
NO2	Nitrogen dioxide	ppm, %, g/GJ mg/m ³ , mg/kW
Itemp	Instrument temperature	°C, °F
DP	Flue gas dew point temperature	°C, °F
Effn	Effency referred to net calorific value	%
Effg	Effency referred to gross calorific value	%
ratio	Poison index	-
ExAir	Air ratio	%

Display	Parameter	Units
ΔP2	Differential pressure (200hPa)	mbar, hPa, Pa mmWS, inW psi, inHG
Gasfl	Gas flow rate	m ³ /h, l/min
GasP	Gas burner output	kW
OilFI	Oil flow rate	kg/h
Oil p	Oil pressure	bar
OilP	Oil burner output	kW
Pabs	Absolute pressure	hPa, mbar, Pa, mmWS, inW psi, inHG
Pump	Pump output	l/min
ΔP1	Differential pressure (40hPa)	mbar, hPa, Pa mmWS, inW psi, inHG
Speed	Flow speed	m/s, fpm
Flow	Airflow	m ³ /s, m ³ /m, m ³ /h, m ³ /d, m ³ /y, f ³ /s, f ³ /m, f ³ /h, f ³ /d, f ³ /y, l/min
MCO, MNOx, MSO2	Mass flow	kg/h, kg/d, t/d, t/y, lb/h
H2	Hydrogen	ppm

Calling up the function:

- ▶  → **Inst' settings** → → **Display edit** → .

Setting the display representation:

- ▶ Select **4 values on disp large** or **8 values on disp small** → .

Changing parameters and units:

- 1 Select the display position.

Options:

- ▶ To insert a space: .
- ▶ To delete a parameter: .

- 2 → Select parameter → → Select unit → .

Saving settings:

- ▶ **OK Save input** → .

F.1.2 Printer

The headers (lines 1-3) and the footer for the printout can be set. The printer that is used can be activated.

Calling up the function:

- ▶  → **Inst' settings** → → **Printer** → .

Setting the print text:

- 1 **Print text** → .
- 2 Select **Line 1**, **Line 2**, **Line 3** or **Footnote** → .
- 3 Enter the values → **OK Save input** → .
- 4 Repeat steps 2 and 3 for the other lines in the same way.
- 5 **OK Save input** → .

Printer selection:

! The printer 0554 0543 can only be selected after activating bluetooth, see *Communication*, p. 30.

- ▶ **Select Printer** → → Select Printer → .

F.1.3 Start keys edit

The assignment of the function keys depends on the function that is selected. Only the function keys in the start screen (shown when the measuring instrument is switched on) can be assigned any function from the **Measurements** menu.

The function keys are only active if the required sensors are connected.

Calling up the function:

▶  → **Inst' settings** → **OK** → **Start keys edit** → **OK**.

Assigning functions to the start keys:

- 1 Select function → Press the function key that is to be assigned the selected function.
- 2 Repeat step 1 for the other function keys as required.

Saving settings:

▶ **OK Save input** → **OK**.

F.1.4 AutoOff

With the AutoOff function active, the instrument switches itself off automatically if no key is pressed after the set period of time.

Calling up the function:

▶  → **Inst' settings** → **OK** → **AutoOff** → **OK**.

Switching AutoOff on and off:

▶ Select **Auto Off** → **Change** → select **On** or **Off** → **OK**.

Setting the AutoOff time:

▶ Select **Time** → **Change** → Set the value → **OK**.

F.1.5 Communication

Select interface IR/IrDA/ interface Bluetooth.

Calling up the function:

- ▶  → **Inst' settings** → → **Communication** →

Set interface IR/IrDA / interfaceBluetooth:

- ▶ Select **IrDA** oder **Bluetooth** →

F.1.6 Date/Time

The date and the time can be set.

Calling up the function:

- ▶  → **Inst' settings** → → **Date/Time** →

Setting the date/time:

- ▶ Select **Time** or **Date** → → Set the values → .

Saving settings:

- ▶ **OK Save input** → .

F.1.7 Language

The menu language can be set.

Calling up the function:

- ▶  → **Geräteeinst.** → → **Sprache** → .

-or-

- ▶  → **Inst' settings** → → **Language** → .

Setting the language:

- ▶ Select **Deutsch** or **Englisch** → .

-or-

- ▶ Select **German** or **English** → .

F.2 Sensor settings

It is possible to set an NO₂ addition and thresholds for activating sensor protection (dilution/disconnect). The actual calibration data and the status of the sensors can be displayed. Recalibration can be carried out.

Calling up the function:

► → **Sensor settings** → **OK**.

Setting the NO₂ addition (as long as no NO₂ sensor is plugged in):

1 NO₂ addition.

Option:

► Reset NO₂ addition to default value: **Deflt**.

2 **Change** → Set the value → **OK**.

Schematic presentation of gas path testo 340:

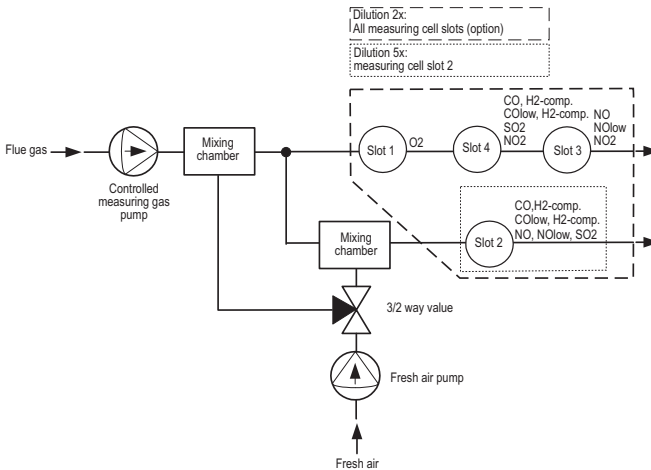

Slot 1	Slot 2	Slot 3	Slot 4
O ₂	CO, H ₂ -comp.	NO	CO, H ₂ -comp.
	CO _{low} , H ₂ -comp.	NO _{low}	CO _{low} , H ₂ -comp.
	NO	NO ₂	SO ₂
	NO _{low}		NO ₂
	SO ₂		

Setting sensor protection:

To extend the measuring range and protect the sensors against overloads, you can set thresholds which, when exceeded, activate sensor protection. Thresholds for a variety of parameters can be set, depending on the sensors that are connected.

For instruments without "Dilution of all sensors" option: If a threshold of the sensor in slot 2 is exceeded, the gas to sensor 2 is diluted by a factor of five.

There is switch-off if a sensor threshold value is exceeded in slot 3 or slot 4.

For devices with the "Dilute all sensors" option: If a sensor threshold value is exceeded in slot 2, the gas to sensor 2 is diluted by factor five. If a sensor threshold value is exceeded in slot 3 or slot 4, gas to all sensors is diluted by factor two.

With dilution active, the reading resolution and accuracies will change, see Technical data. Diluted values are represented inversely.

If the threshold is still exceeded despite dilution, the instrument is switched off. To deactivate sensor protection, set the thresholds to 0 ppm.

1 Sensor protection → .

2 Select the parameter.

Option:

▶ Reset selected parameter to default value: .

3 Change → Set the values → .

4 Repeat steps **2** and **3** for the other parameters accordingly.

▶ Saving settings: **OK Save input** → .

Measurement CO (H₂-compensated) sensor:

! In order to protect the sensor and for a longer sensor life, we recommend that in measurements with unexpectedly high CO concentrations (more than 1,000ppm), the CO sensor is installed in slot 2, and that the threshold of the CO sensor protection is set to 1,000ppm. From a CO concentration of 1,000ppm, dilution with a factor of 5 is automatically activated.

This setting can also be made if H₂ concentrations of more than 1,000ppm are to be expected.

Display ppm/hour counter (active only when sensors with exchangeable filters are used):

For those sensors which have an exchangeable chemical filter for neutralizing cross-gases, a ppm/hour counter is available.

this applies to:

CO, H2 comp. sensor (filter life approx. 170000 ppmh)

NO sensor (filter life approx. 120000 ppmh)

1 **ppm/hour counter** → .

2 Select sensors.

Options:

- ▶ Switch between the individual sensors: , .
- ▶ Display of max. filter life and current hour counter value
- ▶ When maximum filter life is reached, information is displayed: **Filter material spent. Please exchange filter.**
- ▶ Reset hour counter of a sensor: .

Displaying actual calibration data/sensor status:

▶ **Calibrationdata** → .

Options:

- ▶ To change between the actual calibration data of the individual sensors: , .
- ▶ To print out the actual calibration data of all sensors: .
- ▶ To display the status of the sensor as a graphic: .
 - The status of the sensor is checked on every recalibration. Any deviation from the condition on delivery is indicated as a percentage.
 - 70%-threshold: "Gas cell reading unstable, replace item recommended."
 - 50%-threshold: "Replacement sensor."
 - The last 25 recalibrations are shown.
- ▶ To return to the display of the actual calibration data: .

Recalibration:

CO, H2-comp, SO2, NO2, NO sensors and the O2 reference value can be recalibrated. Measurement gas dilution in slot 2 can be recalibrated.

If obviously unrealistic readings are displayed, the sensors should be checked and recalibrated as required.



Dangerous gases

Danger of poisoning!

- ▶ Observe safety regulations/accident prevention regulations when handling test gases.
- ▶ Use test gases in well ventilated rooms only.

! Recalibration with low gas concentrations can lead to deviations in accuracy in the upper measuring ranges.

Sensor protection is deactivated during recalibration. For this reason, test gas concentration should be lower than the maximum value of the sensors.

Recalibrating the sensor at slot 2 has an effect on the dilution: Always carry out a recalibration of measurement parameters before a recalibration of dilution.

The following conditions must be met when recalibrating:

- Use absorption-free tube material
- Switch the measuring instrument on at least 20 min before recalibration (warming-up)
- Use clean air for gas zeroing
- Charge the test gas via calibration adapter (0554 1205, recommended) or the tip of the probe
- Maximum overpressure of the test gas: 30 hPa (recommended: unpressurised via bypass)
- Charge the test gas for at least 3 min

Recommended test gas concentrations and compositions are given in Testo's field guide to test gases.

1 Recalibration → .

- Possibly: Gas zeroing (30 s).

2 Select the parameter → → Enter the test gas concentration (nominal value).

3 Charge the analyzer with test gas.

4 Start calibration: .

If the parameter of the sensor inserted in slot 2 has been selected:

- You will receive a query as to whether dilution should be initialised.

▶ Start recalibration of parameter: → .

▶ Start recalibration of dilution: → .

5 Accept the nominal value as soon as the actual value is stable: .

F.3 Fuels

The fuel can be selected. The fuel-specific coefficients can be set. Ten fuels can be set for each customer.

Calling up the function:

▶  → Fuels → .

Activating fuel:

▶ Select the fuel → .

Setting coefficients:

1 .

Option:

▶ To reset all coefficients to default values: **Default values** → .

▶ To change the name of the fuel (only possible with customer-specific fuel): **Name** → → Set the values → .

2 Select the coefficient

Option:

▶ To reset the chosen coefficients to default values: .

3 → Set the values → .

4 **OK Save input** → .

! The calculation of the fuel factors is carried out via the testo easyEmission software.

G. Measuring

This chapter describes the measuring tasks that can be carried out with the product.

! Familiarity with the contents of the chapter *Operation* (see p. 15) is assumed.

G.1 Preparing measurements

G.1.1 Zeroing phases

Measuring the ambient air temperature (AT)

If no ambient air temperature sensor is connected, the temperature measured by the thermocouple of the flue gas probe during the zeroing phase is used as the ambient air temperature. All dependent parameters are calculated by this value. This method of measuring ambient air temperature is sufficient for systems dependent on ambient air. However, the flue gas probe must be near the intake duct of the burner during the zeroing phase!

If an ambient air temperature sensor is connected, the ambient air temperature is measured continuously via this sensor.

Gas zeroing

The first time a gas measuring function is called up after the instrument has been switched on, the sensors are zeroed.

! The flue gas probe may already be in the flue gas duct during zeroing if a separate AT sensor is connected.

Draught/pressure zeroing

The pressure sensors are zeroed when a pressure measuring function is called up.

! The pressure sockets of the instrument must be free (i.e. unpressurized, not closed) during zeroing.

G.1.2 Using the modular flue gas probe

Checking the thermocouple



The thermocouple of the flue gas probe must not lie against the probe cage.

- ▶ Check before use. Bend the thermocouple back if necessary.

Aligning the flue gas probe



The flue gas must be able to flow freely past the thermocouple.

- ▶ Align the probe by turning it as required.

The tip of the probe must be in the centre of the flue gas flow.

- ▶ Align the flue gas probe in the flue gas duct so that the tip is in the centre of the flow (area of the highest flue gas temperature).

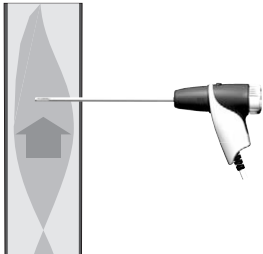

G.1.3 Configuring the reading display

Only those parameters and units which are activated in the reading display appear in the reading display, the saved measurement protocols and the protocol printouts.

- ▶ Before beginning measurements, configure the reading display so that the required parameters and units are activated, see *Display edit*, p. 27.

G.1.4 Set location/fuel

Before carrying out measurements, the measurement location and the fuel must be correctly selected see *Memory*, p. 22 and *Fuels*, p. 35.

G.2 Measurements

G.2.1 Flue gas, Flue gas + m/s, Flue gas + $\Delta p2$

The flue gas menus are the central measurement menus in which - in addition to the readings measured with this function - the readings of all measurements carried out are displayed (if this is selected in the **Display edit** menu). All readings can also be saved in or printed out from these menus.

The flue gas menus are always available, regardless of which sensors are connected.

Measuring functions of the three flue gas menus:

- The **Flue gas** function enables flue gas to be measured.
- The **Flue gas + m/s** function enables flue gas to be measured in addition to flow speed (+ air/mass flow calculation) by means of a Pitot tube (the connection cable for the straight Pitot tube thermocouple should not be connected to the instrument probe socket).
- The **Flue gas + $\Delta p2$** function enables flue gas to be measured in addition to differential pressure measurement.

! After measurements with high concentrations and longer measurements, the instrument should be rinsed with fresh air in order to enable the sensors to regenerate, see Chapter Recommended rinsing times, p. 57.

! For flow speed measurement. Before beginning measurement, configure the location settings (Pitot tube factor and correction factor), see chapter *Location*, p. 23.

Do not measure for longer than 5 min, as the drift of the pressure sensor means that the readings could be outside the tolerance limits.

Calling up the function:

▶  → **Measurements** → → **Flue gas** → .

-or-

▶  → **Measurements** → → **Flue gas + m/s** → .

-or-

▶  → **Measurements** → → **Flue gas + $\Delta p2$** → .

- Possibly: gas zeroing (32 s).

For the functions **Flue gas + m/s** and **Flue gas + $\Delta p2$** :

- ▶ Depressurise the pressure sensor and carry out pressure zeroing with .

If no fuel has yet been selected:

- ▶ Select the fuel → .

Measuring:

1 Start measuring: **Start**.

- The readings are displayed.

Option:

▶ Interrupt measurement and rinse sensors: **Air**,
Continue measurement: **Gas**.

2 Stop measuring: **Stop**.

Options:

▶ To print readings: **Print**.
▶ To save readings: **Save**.

- The readings from the flue gas measurement, as well as any readings taken over into the menu **Flue Gas** from other measurement functions are stored and/or printed in a measurement protocol (automatic furnace data are not printed).

G.2.2 Program

Five flue gas measuring programs can be set, saved and run.

Calling up the function:

▶  → **Measurements** → **OK** → **Program** → **OK**.

Changing a measuring program:

1 Select the program → **Change**.

2 **Meas rate** → **Change** → Enter the values → **OK**.

3 Repeat step 2 for the other criteria accordingly.

4 **OK Save input** → **OK**.

Running a measuring program:

1 Select the program → **Start**.

2 Select **Start without zeroing** (only available if gas zeroing has already been carried out) or **Start with zeroing** and start the program with **OK**.

- If selected: Gas zeroing (32 s).

- Stabilisation phase (60 s).

- The program will run and then stop after the programmed time.

Option:

▶ To print readings: **Print**.

▶ To cancel the program: **Stop**, start again: **Start**.

G.2.3 Draught

The **Draught** function is only available when a flue gas probe is connected.

! Do not measure for longer than 5 min, as the drift of the pressure sensor means that the readings could be outside the tolerance limits.

Calling up the function:

▶  → **Measurements** → **OK** → **Draught** → **OK**.

Measuring:

- 1 Start measuring: **Start**.
 - Draught zeroing (5 s).
- 2 Position the flue gas probe in the centre of the flow (area of the highest flue gas temperature). The display showing the maximum measured flue gas temperature (FT) helps when positioning the probe.
 - The reading is displayed.
- 3 Stop measuring **Stop**.
 - The reading is recorded.

Option:

- ▶ To print the reading: **Print**.
- 4 To copy the reading to the **Flue gas** menu: **OK**.
 - The **Measurements** menu is opened.

G.2.4 Smoke#/HCT

Calling up the function:

▶  → **Measurements** → **OK** → **Smoke#/HCT** → **OK**.

Recording smoke tester no./smoke numbers/oil derivative with the smoke pump and manual input:

The function is only available if the chosen fuel is an oil.

- 1 **Sm. tester no.** → **Change** → Enter the tester number → **OK**.
- 2 **Smoke # 1** → **Change** → Enter the value → **OK**.
- 3 Repeat step 2 for the other smoke # and the oil derivative accordingly.

Recording smoke tester no./smoke numbers/oil derivative with the smoke tester testo 308 and wireless transfer:

- **t308** must be in Data Mode (**Data**).
- 1 Press function key **t308** .
- The values recorded by the smoke tester are transferred.
- 2 Once all values have been transferred, select function key **OK** .

Entering the heat carrier temperature:

- ▶ **Heat carrier** → **Change** → Enter the value → **OK** .

Copying values to the Flue gas menu:

! The values are not shown on the instrument's display. In the menu **Flue Gas**, they can be stored and/or printed in a measurement protocol together with the readings from a flue gas measurement, or transferred to a PC

- ▶ **OK Copy readings** → **OK** .
- The **Measurements** menu is opened.

G.2.5 Gas flow rate

The **Gas flow rate** function is only available if the activated fuel is a gas.

Calling up the function:

- ▶ **Measurements** → **OK** → **Gas flow rate** → **OK** .

Measuring:

- 1 Enter the measurement period: **Sample time** → **Change** → Enter the value (**18, 36, or 180** seconds) → **OK** .
- 2 Start measuring: **Start** . Note the counter status of the gas counter.
 - The remaining measurement period is displayed.
 - When the measurement period has lapsed, a long beep is emitted. The last 5 s are indicated by a short beep.
- 3 Enter the flow rate: **Gasflow** → Enter the value → **OK** .
 - The calculated gas burner output is displayed.
- 4 Copy the values to the **Flue gas** menu: **OK Copy readings** → **OK** .
 - The **Measurements** menu is opened.

G.2.6 Oil flow rate

The **Oil flow rate** function is only available if the activated fuel is an oil.

Calling up the function:

▶  → **Measurements** → **OK** → **Oil flow rate** → **OK**.

Measuring:

- 1 Enter the flow rate: **Flowrate** → **Change** → Enter the value → **OK**.
- 2 Enter the oil pressure: **Oil pressure** → **Change** → Enter the value → **OK**.
 - The calculated oil burner output is displayed.
- 3 Copy the values to the **Flue gas** menu: **OK Copy readings** → **OK**.
 - The **Measurements** menu is opened.

G.2.7 m/s

! A Pitot tube must be connected, the connection cable for the Pitot tube thermo-couple must be connected to the instrument probe socket.

To measure flow speed, air flow and mass flow the parameters of cross-section shape, cross-section surface area, Pitot factor and offset factor must be set, see *Location*, p. 23.

! Do not measure for longer than 5 min, as the drift of the pressure sensor means that the readings could be outside the tolerance limits.

Calling up the function:

▶  → **Measurements** → **OK** → **m/s** → **OK**.

Measuring:

- 1 Start measuring: **Start**.
 - Pressure zeroing (5 s).
- 2 Position the Pitot tube in the duct. The display showing the measured flow speed (Speed) helps when positioning the probe.
 - The reading is displayed.
- 3 Stop measuring: **Stop**.
 - The reading is recorded.

Option:

- ▶ To print the reading: **Print**.
- 4 Accept the reading: **OK**.
 - The **Measurements** menu is opened.

G.2.8 Δp_2

! Do not measure for longer than 5 min, as the drift of the pressure sensor means that the readings could be outside the tolerance limits.

When measuring the gas flow pressure of gas heaters:



Dangerous mixture of gases

Danger of explosion!

- ▶ Make sure there are no leaks between the sampling point and the measuring instrument.
- ▶ Do not smoke or use naked flames during measurement.

Calling up a function:

▶  → **Measurements** → **OK** → Δp_2 → **OK**.

Measuring:

- 1 Start measuring: **Start**.
 - Pressure zeroing (5 s).
- 2 Position the Pitot tube in the duct.
- 3 Stop measuring **Stop**.
 - The reading is recorded.

Option:

- ▶ To print the reading: **Print**.

- 4 Accept the reading: **OK**.
 - The **Measurements** menu is opened.

G.2.9 Burner control

With the help of the readout adapter for automatic furnaces (0554 1206), status data and malfunction reports can be read out from compatible automatic furnaces, see also documentation for readout adapter. The range of data which can be read out is dependent on the automatic furnace type.

Calling up the function:

- 1 Connect readout adapter to the instrument (PS2 interface) and the automatic furnace (use adapter ring if necessary).
- 2  → **Measurements** → **OK** → **Burner Control**.

Option:

- ▶ Display type and version of the adapter: **Adapt.**









44 G. Measuring

3 .

- The data are read from the automatic furnace. An update of the data takes place every 30s at the latest, this is dependent on the automatic furnace.

Reading out current status data:

The current data are displayed when a connection to the automatic furnace exists. The following data are displayed with the help of symbols:

Component	Status ON	Status OFF	Component	Status ON	Status OFF
Air controller			Flame		Symbol not displayed
Motor			Ignition		
Valve1			Oil prewarmer		
Valve 2					

Printing data:

▶ .

Display identification data:

▶ **Info** → .

Display failure statistic:

▶ **Failure statistic** → .

Reading out failure store:

Automatic furnaces are equipped with circular buffer memories, i.e. failure reports are overwritten when the failure store is full.. The last failure occurring is at position 1 in the failure list.

▶ .

Option:

▶ Scroll through failure list: , .

Taking readings over into the menu Flue Gas:

! The readings are not presented in the display, in the menu **Flue Gas** they can be stored with the readings from a flue gas measurement, stored in a measurement protocol or transferred to a PC.

For taking data over into the menu **Flue Gas** the function fields **Info** and **Failure statistic** must not be active (grey background).

▶ .

- The Menu **Measurements** is opened.

H. Transferring data

H.1 Protocol printer

If data are to be transferred to a Testo protocol printer via the infrared or Bluetooth interface, the printer that is to be used must be activated, see *Printer*, p. 28.

Data are printed out via the function key . The function is only available if a printout is possible.

I. Care and maintenance

This chapter describes the steps and action required in order to keep the product functioning properly.

See also *Regular care*, p. 18.

I.1 Cleaning the measuring instrument

- ▶ If the housing of the instrument is dirty, clean it with a damp cloth. Do not use any aggressive cleaning agents or solvents. Weak household cleaning agents and soap suds may be used.

I.2 Replacing sensors

A slot bridge (0192 1552) must be inserted in slots which do not have a sensor. Used sensors must be disposed of as special waste!

The measuring instrument must be switched off and the mains unit disconnected from the mains supply.

- 1 Place the measuring instrument on its front.
- 2 Loosen screws with a screwdriver, release clip in the direction of the arrow, and remove service cover.
- 3 Pull tube connections from the faulty sensor/bridge.
- 4 Remove the faulty sensor/bridge from the slot.

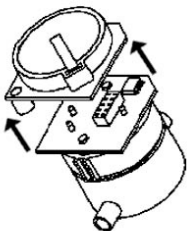

- ! Do not remove auxiliary circuit boards of the new sensors until immediately before installation. Do not leave the sensors without a auxiliary circuit boards for longer than 15 min.
- ▶ NO/NO_{low} sensors:
Remove the auxiliary circuit board.
- 5 Insert a new sensor/bridge in the slot.
- 6 Attach tube connections to the sensor/bridge.
- 7 Replace and close service cover (clip must click in), fix with screws.

- !** After replacing an O₂ sensor, wait 60 min before using the instrument again.
! If retrofitting a sensor you must activate the relevant measuring parameter and unit, see *Display edit*, p. 27.

I.3 Filter for CO, H₂-comp., NO exchanging sensors

The measuring instrument must be switched off and the mains unit disconnected from the mains supply.

- 1 Place measuring instrument on its face.
- 2 Loosen screws with a screwdriver, release clip in the direction of the arrow, and remove service cover.
- 3 Remove hose connections from sensor.
- 4 Remove sensor from slot.

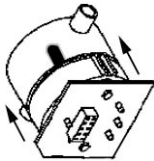

- 5 Remove spent filter from sensor.
- 6 Place new filter on sensor.
- !** Avoid touching the electronics of the sensor.
- Observe the markings on the filter and the sensor
- 7 Insert sensor into slot.
- 8 Replace hose connections on to sensor.
- 9 Replace and close service cover (clip must click in), fix with screws.
- 10 Reset ppm hour counter (see *Display ppm/hour counter*, p. 33).

I.4 Recalibrating sensors

See *Sensor settings*, p. 31.

I.5 Cleaning the modular flue gas probe

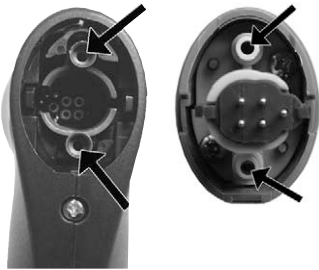

! Detach the flue gas probe from the measuring instrument before cleaning.

1 Release the probe catch by pressing the key on the probe handle and remove the probe module.

▶ Probe shafts with preliminary filter:
Unscrew the preliminary filter.

2 Blow compressed air through the flue ducts of the probe module and probe handle (see illustration). Do not use a brush!

▶ Probe shafts with preliminary filter:

Blow compressed air through the preliminary filter. For thorough cleaning, use an ultrasonic bath or a cleaner for dentures. Screw the preliminary filter back on to the probe shaft after cleaning.

3 Fit a new probe module on the handle and engage it in place.

I.6 Replacing probe preliminary filter

The preliminary filter in probe modules fitted with a preliminary filter can be replaced.

▶ Unscrew the preliminary filter from the probe shaft and screw on a new filter.

I.7 Replacing thermocouple

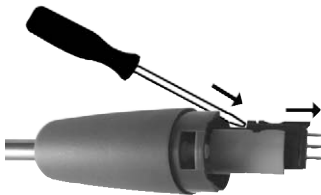

1 Release the probe catch by pressing the key on the probe handle and remove the probe module.

2 Detach the plug-in head of the thermocouple from its mounting using a screwdriver and pull the thermocouple from the probe shaft.

3 Lead a new thermocouple into the probe shaft until the plug-in head engages.

4 Fit probe module on the handle and engage it in place.

J. Questions and answers

This chapter gives answers to frequently asked questions.

Question	Possible causes	Remedy
Measuring instrument keeps switching itself off or instrument will not switch on.	AutoOff function is switched on. Battery spent.	<ul style="list-style-type: none"> ▶ Switch AutoOff function off (see <i>AutoOff</i>, p. 29). ▶ Charge rech. battery or connect mains unit (see <i>Operation</i>, p. 15).
Measuring instrument will not switch on.	Battery spent.	<ul style="list-style-type: none"> ▶ Charge rech. battery or connect mains unit (see <i>Operation</i>, p. 15).
Display of the battery capacity appears faulty	Battery was often not fully discharged/charged.	<ul style="list-style-type: none"> ▶ Discharge rechargeable battery fully (until instrument switches off by itself) and then charge fully.
Failure report: Pump flow rate to high	Gas output closed.	<ul style="list-style-type: none"> ▶ Ensure that gas output is free
Message: Gas cell shutdown-threshold has been exceeded	The shutdown threshold of a sensor has been exceeded	<ul style="list-style-type: none"> ▶ Remove probe from flue.
Failure report: Printing not possible	<ul style="list-style-type: none"> · With printer 0554 0543: The wrong interface is activated. · The wrong printer is activated. · Printer is switched off. · Printer is out of wireless range. 	<ul style="list-style-type: none"> ▶ Activate correct interface (see <i>Communication</i>, p. 30). ▶ Activate correct printer (see <i>Printer</i>, p. 28). ▶ Switch printer on. ▶ Place printer within wireless range.

If we could not answer your question, please contact your dealer or Testo Customer Service. For contact data, see back of this document or web page www.testo.com/service-contact

K. Technical data

K.1 Standards and tests

- As declared in the certificate of conformity, this product complies with Directive 2004/108/EEC.
- This product is TÜV approved to EN50379 part 2, exception: SO₂ and NO₂ parameters are not tested, recalibration is not blocked.

K.2 Measuring ranges and accuracies

Parameter	Measuring range	Accuracy	Resolution	t90 ¹
O ₂	0...25Vol.%	±0.2Vol.%	0.01Vol.%	< 20s
CO, H ₂ -comp.	0...10000ppm	±10ppm or ±10% of reading ¹ at 0...200ppm ±20ppm or ±5% of reading ¹ at 201...2000ppm ±10% of reading at 2001...10000ppm	1ppm	< 40s
COlow, H ₂ -comp.	0...500ppm	±2ppm at 0.0...39.9ppm ±5% of reading at 40.0...500ppm	0.1ppm	< 40s
NO ₂	0...500ppm	±10ppm at 0...199ppm ±5% of reading in rest of range	0.1ppm	< 40s
SO ₂	0...5000ppm	±10ppm at 0...99ppm ±10% of reading in rest of range	1ppm	< 40s
NOlow	0...300ppm	±2ppm at 0.0...39.9ppm ±5% of reading at 40.0...300.0ppm	0.1ppm	< 30s
NO	0...3000ppm	±5ppm at 0...99ppm ±5% of reading at 100...1999ppm ±10% of reading at 2000...3000ppm	1ppm	< 30s
Draught, Δp1	-40...40hPa	+ 1.5% v. Mw. at -40.00...-3.00hPa + 0.03hPa at -2.99...2.99hPa + 1.5% v. Mw. at 3.00...40.00hPa	0.01hPa	-
Δp2	-200...200hPa	±1.5% of reading at -200.0...-50.0hPa ±0.5hPa at -49.9...49.9hPa ±1.5% of reading at 50.0...200.0hPa	0.1hPa	-

¹ Response time 90%, recommended minimum measurement duration to guarantee correct readings: 3min

Parameter	Measuring range	Accuracy	Resolution	t90 ¹
Pabs	600...1150hPa	±10hPa	1hPa	-
Temperature (NiCrNi)	-40...1200°C	±0.5°C at 0.0...99°C ±0.5% of reading in rest of range	0.1°C at -40.0...999.9°C 0.1°C at 1000°C...1200°C	depends on probe
Efficiency	0...120%	-	0.1%	-
Flue gas loss	0...99,9%	-	0,1%	-
Flue gas dewpoint	0...99,9°C	-	0.1%	-
CO2 determination (Calculated from O2)	0...CO2 max.	±0.2 Vol%	0.1 Vol%	<40s

¹ Response time 90%, recommended minimum measurement duration to guarantee correct readings: 3min

For activated single dilution slot 2 (factor 5)

Parameter	Measuring range	Accuracy	Resolution
CO, H2-comp.	700...50000ppm	+10% of reading (additional error)	1ppm
COlow, H2-comp.	300...2500ppm	+10% of reading (additional error)	0.1ppm
SO2	500...25000ppm	+10% of reading (additional error)	1ppm
NO	500...15000ppm	+10% of reading (additional error)	1ppm
NOlow	150...1500ppm	+10% of reading (additional error)	0.1ppm

With activated dilution of all sensors (optional) (factor 2)

Parameter	Measuring range	Accuracy	Resolution	t90 ¹
O2	0...25Vol.%	±1Vol.% of reading additional error (0...4,99Vol.%) ±0,5Vol.% of reading additional error(5...25Vol.%)	0.01Vol. %	< 20s
CO, H2-comp.	700...20000ppm	+10% of reading (additional error)	1ppm	
COlow, H2-comp.	300...1000ppm	+10% of reading (additional error)	0.1ppm	
NO2	200...1000ppm	+10% of reading (additional error)	0.1ppm	
SO2	500...10000ppm	+10% of reading (additional error)	1ppm	
NOlow	150...600ppm	+10% of reading (additional error)	0.1ppm	
NO	500...6000ppm	+10% of reading (additional error)	1ppm	

¹ Response time 90%, recommended minimum measurement duration to guarantee correct readings: 3min

Filter lifetime

Parameter	Lifetime
CO, H2-comp.	170000 ppmh
NO	120000 ppmh

K.3 Other instrument data

Characteristic	Values
Operating temperature	-5...50 °C
Storage/transport temperature	-20...50 °C
Power supply	Battery block: 3.7V/2.4 Ah Mains unit: 6.3 V/2 A
Dimensions (L x W x H)	283 x 103 x 65mm
Weight	960g
Memory	max. 100 folders, max. 10 locations per folder
Display	Monochrome, 4 grey levels, 160 x 240 pixels
Battery storage temperature:	±0...35 °C
Battery life	>6 h (pump on, display light off, 20 °C ambient temperature)
Battery charge time	approx. 5-6h
Pump perform.against x hPa	Max. positive pressure at probe tip: + 50 mbar Max. negative pressure at probe tip: -200 mbar
Initialization and zeroing time	30 sec.
Protection class	IP 40
Guarantee	Measuring instrument: 24 months Sensors: 12 months, O2 sensor: 18 months Flue gas probe: 24 months Thermocouple: 12 months Battery: 12 months Warranty conditions: see www.testo.com/warranty
Option Bluetooth®	Typ-designation: BlueNiceCom IV Bluetooth Qualified Product Notice: BNC4_HW2x_SW2xx Bluetooth listing identifier: B013784 Bluetooth listing company: 10274
 Bluetooth	
Option Bluetooth®	Range <10m
Option Bluetooth®	EU countries
Certification	Belgium (BE), Bulgaria (BG), Denmark (DK), Germany (DE), Estonia (EE), Finland (FI), France (FR), Greece (GR), Ireland (IE), Italy (IT), Latvia (LV), Lithuania (LT), Luxembourg (LU), Malta (MT), Netherlands (NL), Austria (AT), Poland (PL), Portugal (PT), Romania (RO), Sweden (SE), Slovakia (SK), Slovenia (SI), Spain (ES), Czech Republic (CZ), Hungary (HU), United Kingdom (GB) and Republic of Cyprus (CY). EFTA Countries Iceland, Liechtenstein, Norway and Switzerland Other countries Canada, USA, Japan, Ukraine, Australia, Columbia, Turkey, El Salvador

K.4 EC declaration of conformity



EG-Konformitätserklärung

EC declaration of conformity

Für die nachfolgend bezeichneten Produkte:

We confirm that the following products:

Testo 340 (*bluetooth*)

Best. Nr.: / Order No.: 0632 3340

wird bestätigt, daß sie den wesentlichen Schutzanforderungen entsprechen, die in der Richtlinie des Rates zur Angleichung der Rechtsvorschriften der Mitgliedstaaten über die **elektromagnetische Verträglichkeit** (2004/108/EG) festgelegt sind.

corresponds with the main protection requirements which are fixed in the EEC "Council Directive 2004/108/EC on the approximation of the laws of the member states relating to electromagnetic compatibility".
The declaration applies to all samples of the above mentioned product.

Zur Beurteilung der Erzeugnisse hinsichtlich elektromagnetischer Verträglichkeit im Kleingewerbebereich wurden folgende Normen herangezogen:

For assessment of the product following standards have been called upon:

Störaussendung / Pertubing radiation:
Störfestigkeit: / Pertubing resistance:

DIN EN 50270:2000-01 Typ 1
DIN EN 50270:2000-01 Typ 2

R&TTE Richtlinie:

EN 300 328 V1.7.1 (2006-10)
EN 301 489-1 V1.6.1 (2005-09)
EN 301 489-17 V1.2.1 (2002-08)
EN 60950-1 (2006-11)

Sicherheits-Richtlinie:

This declaration is given in responsibility for:

Diese Erklärung wird für:

Testo AG
Postfach / P.O. Box 1140
79849 Lenzkirch / Germany
www.testo.com

abgegeben durch / by:

Herr Walleser Mr. Walleser
(Name) (name)

Vorstand Managing Director
(Stellung im Betrieb des Herstellers) (Position in the company of the manufacturer)

Lenzkirch, 04.12.2009
(Ort, Datum / place, date)

(Rechtsgültige Unterschrift / Legally valid signature)



Der Hersteller betreibt ein zertifiziertes Qualitätssicherungssystem nach DIN ISO 9001

The manufacturer operates a certified quality assurance system according to DIN ISO 9001

K.5 Principles of calculation

K.5.1 Fuel parameters

Fuel	CO ₂ max	O ₂ ref	K _{gr}	K _{net}	K ₁	H	MH ₂ O	Q _{gr}	Q _{net}
Natural Gas	11,90	3,00%	0,35%	0,39	40,00	24,4	0	53,42	48,16
Light Oil	15,50	3,00%	0,48%	0,51	53,00	13	0	45,6	42,8
Heavy Oil	15,80	3,00%	0,51%	0,51	54,00	11,5	0,2	42,9	40,5
Coal	18,40	7,00%	0,62%	0,65	63,00	4	13	26,75	25,5
Anthracit	19,10	7,00%	0,67%	0,69	65,00	3	12	29,65	28,95
Coke	20,60	7,00%	0,75%	0,76	70,00	0,4	10	27,9	27,45
Propane	13,80	3,00%	0,42%	0,45	48,00	18,2	0	50	46,3
Butan	4,10	3,00%	0,43%	0,46	48,00	17,2	0	49,3	45,8
Test gas	0,00	0,00%	0,00%	0,00	0,00	0	0	0	0
Diesel	15,60	3,00%	0,49%	0,53	53,00	12,9	0	44,62	41,8
Petrol	15,10	3,00%	0,46%	0,49	51,00	14,2	0	45,1	42,02

K.5.2 Calculation formulae

Carbon dioxide:
$$CO_2 = \frac{CO_{2max} \times (O_{2ref} - O_2)}{O_{2ref}}$$

CO_{2max}: Fuel-specific carbon dioxide value
 O_{2ref}: O₂ reference value
 O₂: Measured oxygen content as %

Efficiency referred to Gross Efficiency:

$$Effg = 100 - \left(\left(\frac{K_{gr} \times (FT - AT)}{CO_2} \right) + \left(\frac{(MH_2O + 9 \times H) \times (2488 + 2.1 \times FT - 4.2 \times AT)}{Q_{gr} \times 1000} \right) + \left(\frac{K_1 \times CO}{CO_2 + CO} \right) \right)$$

Efficiency referred to Nett Efficiency:

$$Effn = 100 - \left(\left(\frac{K_{net} \times (FT - AT)}{CO_2} \right) + \left(\frac{(MH_2O + 9 \times H) \times (210 + 2.1 \times FT - 4.2 \times AT)}{Q_{net} \times 1000} \right) + \left(\frac{K_1 \times Q_{gr} \times CO}{Q_{net} \times (CO_2 + CO)} \right) \right)$$

K_{gr}/K_{net}/Q_{gr}/Q_{net}/K₁/MH₂O/H:
 Fuel-specific factors
 FT: Flue gas temperature
 AT: Ambient temperature
 CO: Measured carbon monoxide value in %
 CO₂: Calculated carbon dioxide value in %

Poison index:	$\text{ratio} = \frac{\text{CO}}{\text{CO}_2 \times 10000}$	CO:	Measured carbon monoxide value in %
		CO ₂ :	Calculated carbon dioxide value
Excess Air (ExAir):	$= \left(\frac{21\%}{21\% - \text{O}_2} - 1 \right) \times 100$	21%:	Oxygen level of air
		O ₂ :	Measured oxygen level in %
Nitrogen oxides:	No NO ₂ sensor connected: $\text{NO}_x = \text{NO} + (\text{NO}_{2\text{Add}}, \times \text{NO})$ NO ₂ sensor connected: $\text{NO}_x = \text{NO} + \text{NO}_2$	NO:	Measured nitrogen monoxide value
		NO _{2Add} :	Nitrogen dioxide addition factor
Carbon monoxide undiluted:	$u\text{CO} = \text{CO} \times \lambda$	CO:	measured carbon monoxide content
		λ:	Calculated air ratio
Flue gas dew point:	$\text{DP} = \frac{\ln \left(\frac{F_{\text{H}_2\text{O}} \times P_{\text{Abs}}}{610.78} \right) \times 234.175}{\ln \left(\frac{F_{\text{H}_2\text{O}} \times P_{\text{Abs}}}{610.78} \right) - 17.08085}$	F _{H₂O} :	Flue gas-specific water vapour content as vol.%
		P _{Abs} :	Absolute pressure in mbar/hPa
Flow speed:	$v = \sqrt{\frac{575 \times \Delta P \times (FT + 273.15)}{P_{\text{abs}}}} \times \alpha$	P _{abs} :	Absolute pressure
		ΔP:	Differential pressure
		FT:	Flue gas temperature
		α:	Pitot tube factor
Air flow:	$V = v \times a$	v:	Flow speed
		a:	Cross-section area

56 K. Technical data

Mass flow:

Mass flow CO: $MCO = CO \text{ [kg/h] [ppm]} \times F_{Gas} \times 1.25 \text{ [kg/m}^3\text{]} \times Z$

Mass flow NO_x: $MNO_x = NO_x \text{ [kg/h] [ppm]} \times F_{Gas} \times 2.05 \text{ [kg/m}^3\text{]} \times Z$

Mass flow SO₂: $MSO_2 = SO_2 \text{ [kg/h] [ppm]} \times F_{Gas} \times 2.86 \text{ [kg/m}^3\text{]} \times Z$

F_{gas}: Fuel-specific humidity value
T: Dew point
Z: Calculation term (see below)

Calculation term Z: $Z = \frac{273.15 \times P_{abs} \text{ [mbar]}}{273.15 + T \text{ [}^\circ\text{C]} \times 1013} \times V \text{ [m}^3\text{/s]} \times 10^{-6} \text{ [1/ppm]} \times 3600$

Conversion from ppm to mg/m³:

Carbon monoxide: $CO \text{ [mg/m}^3\text{]} = \frac{O_{2ref} - O_{2Bez}}{O_{2ref} - O_2} \times CO \text{ [ppm]} \times 1.25$

Nitrogen oxide: $NO_x \text{ [mg/m}^3\text{]} = \frac{O_{2ref} - O_{2Bez}}{O_{2ref} - O_2} \times NO_x \text{ [ppm]} \times 2.05$

Sulfur dioxide: $SO_2 \text{ [mg/m}^3\text{]} = \frac{O_{2ref} - O_{2Bez}}{O_{2ref} - O_2} \times SO_2 \text{ [ppm]} \times 2.86$

O_{2ref}: O₂ Reference value
O₂: Measured oxygen content as %
O_{2Bez}: Fuel-specific oxygen reference index as %

K.6 Recommended rinsing times

Recommended rinsing times in measurements with high concentrations and longer measurements:

- Rinse instrument: Expose probe to fresh air and start flue gas analysis

Parameter	Concentration [ppm]	Measurement duration [min]	Recommended rinsing time [min]
CO	50	60	5
	100	30	5
	200	20	10
	500	10	10
	1000	10	15
	2000	10	20
	4000	5	30
	8000	5	60
COlow	10	60	5
	20	30	5
	50	20	10
	100	10	10
	200	10	15
	500	10	20
NO	50	60	5
	100	45	5
	200	30	5
	500	20	10
	1000	10	10
	2000	10	20
	3000	5	30
NOlow	10	60	5
	20	45	5
	50	30	5
	100	20	10
	200	10	10
	300	10	20
NO2	10	60	5
	20	45	5
	50	30	5
	100	20	10
	200	10	10
	500	10	20
SO2	50	60	5
	100	30	5
	200	20	10
	500	15	10
	1000	10	10
	2000	10	20
	5000	5	40



L. Accessories/spare parts







Designation	Article no.
Modular flue gas probes	
Modular flue gas probe 335mm, 500°C, thermocouple 0.8mm	0600 9766
Modular flue gas probe 700mm, 500°C, thermocouple 0.8mm	0600 9767
Modular flue gas probe 335mm, 1000°C, thermocouple 0.8mm	0600 8764
Modular flue gas probe 700mm, 1000°C, thermocouple 0.8mm	0600 8765
Modular flue gas probe with preliminary filter 335mm, 1000°C, thermocouple 0.8mm	0600 8766
Modular flue gas probe with preliminary filter 700mm, 1000°C, thermocouple 0.8mm	0600 8767
Probe modules/accessories for modular flue gas probes	
Module probe shaft 700mm, 500°C, thermocouple 0.8mm	0554 9767
Module probe shaft 335mm, 1000°C, thermocouple 0.8mm	0554 8764
Module probe shaft 700mm, 1000°C, thermocouple 0.8mm	0554 8765
Module probe shaft with preliminary filter 335mm, 1000°C, thermocouple 0.8mm	0554 8766
Module probe shaft with preliminary filter 700mm, 1000°C, thermocouple 0.8mm	0554 8767
Extension lead for modular flue gas probe, 2.80m	0554 1202
Particle filter, 10 pcs	0554 3385
Replacement preliminary filter for modular flue gas probe with preliminary filter (2 pcs.)	0554 3372
Industry engine probe	
Engine probe without pre-filter	0600 7560
Engine probe with pre-filter	0600 7561
Thermocouple with 2.4 m hose, Tmax. 1000 °C	0600 8894
Spare probe shaft for engine probe with pre-filter	0554 7455
Other probes/sensors	
Pitot tube, 350mm	0635 2041
Pitot tube, 700mm	0635 2042
Ambient air temperature (AT) sensor, 60 mm	0600 9797
Retrofit sensors	
NOlow retrofitting kit	0554 2152
NO retrofitting kit	0554 2150
COlow-, H2-comp.- retrofitting kit	0554 2102
CO-, H2-comp.-retrofitting kit	0554 2100
NO2 retrofitting kit	0554 2200
SO2 retrofitting kit	0554 2250
Replacement sensors	
O ₂ sensor	0393 0001
CO-, H2-comp. sensor	0393 0100
NOlow sensor	0393 0152
NO sensor	0393 0150
NO2 sensor	0393 0200
SO2 sensor	0393 0250
COlow-, H2-comp. sensor	0393 0102

Designation	Article no.
Spare filters	
CO-, H2-comp. sensor	0554 4100
NO sensor	0554 4150
Other retrofitting kits	
Bluetooth	only retrofittable by Testo service
Dilution of all sensors	only retrofittable by Testo service
Other accessories	
Infrared printer	0554 0549
Bluetooth printer incl. rechargeable battery and charging adapter	0554 0553
Mains unit	0554 1096
Charger with replacement battery	0554 1087
Replacement battery	0515 0100
Replacement thermal paper for printer (6 rolls)	0554.0568
Instrument/PC connecting cable	0449 0047
testo EasyEmission PC configuration software	0554 3334
Transport case	0516 3400

Functional overview

The table gives an overview of the most important functions configured on the individual instruments. Detailed information about the individual functions can be found on the pages indicated.

Task	Call/function	see page
	 → Measurements → <input type="button" value="OK"/> →	
Flue gas measurement	Flue gas → <input type="button" value="OK"/>	38
Flue gas measurement with parallel flow measurement (+ air/mass flow calculation)	Flue gas + m/s → <input type="button" value="OK"/>	38
Flue gas measurement with parallel differential pressure measurement	Flue gas + Δp_2 → <input type="button" value="OK"/>	38
Change/save/run measuring program	Program → <input type="button" value="OK"/>	39
Draught measurement	Draught → <input type="button" value="OK"/>	40
Enter smoke #/heat carrier temperature	Smoke # / HCT → <input type="button" value="OK"/>	40
Determine gas flow rate	Gas flow rate → <input type="button" value="OK"/>	41
Determine oil flow rate	Oil flow rate → <input type="button" value="OK"/>	42
Flow speed and pressure measurement	m/s → <input type="button" value="OK"/>	42
Pressure measurement	Δp_2 → <input type="button" value="OK"/>	43
Read automatic furnace	Burner control → <input type="button" value="OK"/>	43
	 → Memory → <input type="button" value="OK"/> →	
Create new folder	New folder → <input type="button" value="OK"/>	22
Sort folder list by Folder, Name or Addr'	Folders list → <input type="button" value="Folder"/> or <input type="button" value="Name"/> or <input type="button" value="Addr'"/>	22
Sort locations list by order of creation	Restore list → <input type="button" value="OK"/>	22
Create new location	Folder → <input type="button" value="OK"/> → New location → <input type="button" value="OK"/>	22
Sort locations list by location name	Folder → <input type="button" value="OK"/> → Locations list → <input type="button" value="Locat"/>	22
Sort locations list by order of creation	Folder → <input type="button" value="OK"/> → Restore list → <input type="button" value="OK"/>	22
Activate location	Folder → <input type="button" value="OK"/> → Select location → <input type="button" value="OK"/>	22
Perform location settings	Folder → <input type="button" value="OK"/> → Select location → <input type="button" value="Change"/>	22
Display measurement data of one location	Folder → <input type="button" value="OK"/> → Select location → <input type="button" value="Data"/>	22
Print all measurement data of a location	Folder → <input type="button" value="OK"/> → Select location → <input type="button" value="Data"/> → <input type="button" value="Print all"/> → <input type="button" value="OK"/>	22
Delete all measurement data of a location	Folder → <input type="button" value="OK"/> → Select location → <input type="button" value="Data"/> → <input type="button" value="Delete all"/> → <input type="button" value="OK"/>	22
Display readings of a selected measurement protocol	Folder → <input type="button" value="OK"/> → Select location → <input type="button" value="Data"/> → Select protocol → <input type="button" value="Value"/>	22
Print a single measurement protocol	Folder → <input type="button" value="OK"/> → Select location → <input type="button" value="Data"/> → Select protocol → <input type="button" value="Print"/>	22

Task	Call/function	see page
	 → Memory → Extra →	
Print all protocols in the memory	Print all data → OK	22
Delete all protocols in the memory	Delete all data → OK	22
Clear whole memory (protocols and locations)	Delete memory → OK	22
	 → Inst' settings → OK →	
Set reading display	→ Display edit → OK	27
Select printer, set print text	→ Printer → OK	27
Set function key assignment, start screen	→ Start keys edit → OK	27
Set date/time	→ Date/Time → OK	27
Set language	→ Language → OK	27
Set automatic instrument disconnect	→ AutoOff → OK	27
	 → Sensor settings → OK →	
Display calibration data	Calibration data → OK	31
Set NO2 addition	NO2 addition → Change	31
Set O2 reference	O2 reference → Change	31
Set sensor protection	Sensor protection → OK	31
Display ppm/hour counter	ppm/hour counter → OK	31
Perform recalibration	Recalibration → OK	31
	 → Fuels → OK →	
Activate fuel	Select fuel → OK	35
Change fuel coefficients	Select fuel → Coeff.	35
	 -or-  → Inst' diagnosis → OK →	
Perform gas path check	Gas path check → OK	26
View instrument errors	Error diagnosis → OK	26
View sensor diagnosis	Sensor diagnosis → OK	26