

The Neot Semadar Narrative

A compilation of personal journeys written to illustrate the individual experiences at the Israeli desert community of Neot Semadar and the transformative adventure of participating in a new way of life as it relates to the overall experience of international travel and project work.

An Interactive Qualifying Project submitted to the
Faculty of WORCESTER POLYTECHNIC
INSTITUTE in partial fulfillment of the requirements
for the Degree of Bachelor of Science

Austin Shalit, Daniel Shrives, Benjamin Stevens, Carly Whittle

Advisor: Isa Bar-On

Sponsor: Yoram Tencer, Neot Semadar



WPI



Introduction

Neot Semadar— an apparent desert oasis for body and mind located in the southern region of the Negev Desert in Israel. Surrounded by hand-planted trees and man-made lakes there lives a unique and diverse community of permanent inhabitants, passersby-ers, and volunteers from around the world. On the surface, their lifestyle cultivates a culture of active listening, engaged participation, self-reflection and, above all else, an atmosphere where attention to relationships with one another is of the utmost importance. But what is under the surface, under the “sales pitch” of coming to participate in their way of life? The experience of Neot Semadar is said to spark a transformation of the mind, improving one’s ability to perceive and interact with the surrounding world and with themselves. With a reluctance to define itself, Neot Semadar exists on the basis of inviting the curious to experience their culture first-hand, creating a community centered around the search for understanding humanity in its most simple form.

As four college students, we have been groomed to have the minds and the experiences of engineers where the work load is copious, the environment is intense, and the expectations we are upheld to is of the highest caliber. Life had one direction, and that was fast-forward. As you will see, once our feet hit the sand in Neot Semadar, we were completely unaware of the adventurous unknown we had stepped into. The limitations of knowledge and literature on this settlement placed us far beyond the realm of preparation. So, we researched, made assumptions, and gathered information that we felt best described a place that strives for indefinability and perplexity.

Follow us in this narrative as we illustrate those assumptions and expectations of Neot Semadar colliding with reality, reaching points of revelation, contemplation, confusion, even contradiction. This account contains new discoveries, different perspectives, and insight into the experiences of life and the mindset found on this desert kibbutz. As each of our stories unfold, our personal experiences highlight themes most prevalent to us and the most important and memorable moments that shaped our lives over the past several weeks. Some of the topics covered include our work within the community, interactions with the individuals themselves, and the overall transformation of ourselves throughout the journey, from beginning to end.

The intention of this document is to record our experiences at Neot Semadar, however similar or different they may be, into a narrative that remains timeless as the experiences fade away with time. It is not intended to represent or define Neot Semadar by attempting to analyze and characterize their community and their culture, but rather it serves as a collaborative reflection of our endeavors and experiences. We aim to display the effects of this place on our lives, and how living at Neot Semadar for seven weeks has changed us or has not changed us.

As you read along, you will encounter the disintegration of our expectations, our preconceived notions about humanity, and our self-identity, leaving in its place a deeper understanding of who we are, how we relate to others, and how we relate to ourselves. We hope you enjoy reading about our experiences at Neot Semadar—we surely will remember these moments for the rest of our lives.

*Sincerely,
Austin, Daniel, Ben, and Carly*



Acknowledgements

We would like to thank Neot Semadar for welcoming us into their community so willingly, as well as allowing us to participate in their culture and giving us the opportunity to work on our project simultaneously. We know that we were not the typical volunteers that come to serve, but they still welcomed us with open arms and helped us in ways that are difficult to put into words. To all the volunteers who encouraged us, befriended us, and led us on this seven-week journey, we are eternally grateful.

We would also like to thank Yoram Tencer, our sponsor, for guiding us and providing the proper tools to complete the technical aspect of our project. It was an honor and a privilege to work along side you on the temperature and current sensors. Thank you to Israela, Mor, and Neta for being our connection to the kibbutz and the culture of the community. Both great friends and great mentors, we are very grateful for the time that we were able to spend with you all.

Finally, we would like to say thank you to Isa Bar-On, our advisor, for being a solid source of positive feedback, support, and chocolate bars. Without you, this project and the Israel project site would not be what it is today.

Table of Contents

<i>Introduction.....</i>	<i>1</i>
<i>Acknowledgements.....</i>	<i>2</i>
<i>The IQP Experience.....</i>	<i>4</i>
<i>PART ONE: From Familiar Land to the Holy Land.....</i>	<i>5</i>
<i>Chapter 1: Anticipation for a Season of Growth.....</i>	<i>6</i>
<i>Chapter 2: Alone in Jerusalem.....</i>	<i>7</i>
<i>Chapter 3: From Back Woods to the Desert.....</i>	<i>8</i>
<i>Chapter 4: Going Up!.....</i>	<i>9</i>
<i>PART TWO: Journey to Emotional and Spiritual Growth.....</i>	<i>10</i>
<i>Chapter 5: Off to an Anxious Start.....</i>	<i>11</i>
<i>Chapter 6: Where do I Belong?.....</i>	<i>14</i>
<i>Chapter 7: Growth Begins with Surrender.....</i>	<i>16</i>
<i>Chapter 8: Once Empty, Slowly Being Filled Again.....</i>	<i>18</i>
<i>Chapter 9: Seeing through the Lense of Gratitude.....</i>	<i>20</i>
<i>PART THREE: An Unexpected Israeli Adventure.....</i>	<i>22</i>
<i>Chapter 10: First Impressions.....</i>	<i>23</i>
<i>Chapter 11: Growing Relationships.....</i>	<i>25</i>
<i>Chapter 12: Loose Ends.....</i>	<i>28</i>
<i>PART FOUR: A Metal Shoelace—Learning to Thrive.....</i>	<i>29</i>
<i>Chapter 13: Upon Arrival.....</i>	<i>30</i>
<i>Chapter 14: Filling in the Past.....</i>	<i>32</i>
<i>Chapter 15: Trust!! Autopilot.....</i>	<i>34</i>
<i>PART FIVE: Short Tales of a Red Head and a Desert.....</i>	<i>36</i>
<i>Chapter 16: A Pumpkin Tale.....</i>	<i>37</i>
<i>Chapter 17: Me'laf 'fone and Music.....</i>	<i>38</i>
<i>PART SIX: Epilogue.....</i>	<i>39</i>
<i>Our IQP Experience at Neot Semadar.....</i>	<i>40</i>
<i>Appendix - Temperature and Current Sensor User Manual.....</i>	<i>42</i>



The IQP Experience

As students at WPI, we are honored with the privilege to further our education in more than just the classroom and in more than just academics. In the third year, each student embarks on an Interactive Qualifying Project, or an IQP, to get experience on how to problem solve, work in a team setting, and overcome difficult challenges they may face in the real world. They can choose to perform this project abroad or on campus, but regardless of the location, the general goals and guidelines for the learning outcomes of the project are the same.

According to the faculty-approved learning outcomes, IQP students will:

- Demonstrate an understanding of the project's technical, social and humanistic context.
- Define clear, achievable goals and objectives for the project.
- Critically identify, utilize, and properly cite information sources, and integrate information from multiple sources to identify appropriate approaches to addressing the project goals.
- Select and implement a sound approach to solving an interdisciplinary problem.
- Analyze and synthesize results from social, ethical, humanistic, technical or other perspectives, as appropriate.
- Maintain effective working relationships within the project team and with the project advisor(s), recognizing and resolving problems that may arise.
- Demonstrate the ability to write clearly, critically and persuasively.
- Demonstrate strong oral communication skills, using appropriate, effective visual aids.
- Demonstrate an awareness of the ethical dimensions of their project work.

It is typical for a student to not choose the exact location, project, or teammates for their IQP experience. Having to live with new people, work in a different setting and / or culture than one may be used to and deciphering the project at hand with potentially limited resources are common challenges students encounter and are encouraged to overcome during their seven-week project. It exposes them to different cultures, different learning and working habits, and how to accomplish a task that is outside of their expertise and comfort zone. The IQP experience prepares these WPI students for real-life interactions with potential clients and sponsors, as well as how to ask the right questions that allow for clear communication between engineer and client.

Within this narrative, there are references to this idea of the "IQP Experience" and how components of this concept shaped the outlook and understanding of the project in the eyes of the four students as their experience transformed over the course of the term. Some of these stories highlight the expected when it comes to a project abroad; however, there are other components to this IQP that are unique to this project and its location. They will journey to define what the IQP experience means to each one and how that may be unique for everyone, and how, in some ways, their journeys were the same.



PART ONE: From Familiar Land to the Holy Land

New Years Eve to Neot Semadar Eve





Chapter 1: Anticipation for a Season of Growth

As the crowd of unacquainted faces begins to countdown an ending to what was familiar in anticipation of the New Year, she could not help but feel alone. Things were good in 2018, or at least the moments she tried to remember whilst suppressing the unease that had begun brewing inside of her for several months. Despite these feelings, she joined in with the countdown, knowing her exuberant cheering would be enough to mask her confusion and anxieties that awaited her in five... four... three... two... one...

Carly found herself launched into the New Year most of her loved ones scattered across the eastern seaboard— which is poetic, she thought, that in the year she was most frightened to begin she found herself facing it alone. She was surrounded by friends and new acquaintances, with the only true familiar face being Jonathan. For the first two years of their relationship, they had never spent more than two weeks apart. As the adventure of beginning a third year with him was exciting, she knew that it would be hard being apart for so long. Carly was preparing in three days to journey to Israel, leaving Jonathan and her family behind for over two months. Her normal charismatic nature and outgoing personality quickly ran into hibernation at the thought of the true loneliness that may await her in an unfamiliar land.

Over the next three days, she busied herself with packing preparations, late night movies and dinner dates with her mother, and one last hurrah in Connecticut at her older brother, David's, apartment as she watched over internet livestream as Samuel, the youngest, played in his collegiate basketball game. As each day passed, she was forced into the longest series of goodbye's ever experienced. She spread her time amongst her friends and family, having to experience their last hugs and good wishes before leaving for what she saw as a punishment of circumstance, but others saw as the opportunity of a lifetime. She felt the continual flow of gentle tears for those last three days, to the point that on January 3rd when her parents pulled into the airport and unpacked her bags, she was practically numb.

Her mother, Lori, had been the foundation of stability for Carly her whole life. When it seemed as if the world was crashing in, her mother would always remind her of her Heavenly Father who watched over her and loved her like no one else could. She had an effortless way about being the strength of those around her that needed her most, even in the final moments before Carly had left the grip of her mother's grasp. Her father, Donnie, was a pilot by profession and was able to accompany her past security and wait with her in the airport, easing some of her hidden anxiety. His cool, centered, and fun personality made it easy for her to forget that she was about to leave his side for the next fifty-seven days. But the moment she stepped foot on her connecting flight to New York, she pushed down what was left of her uneasiness and tried to fill herself with excitement and anticipation for the new chapter ahead.

Once in New York, she was on her own—literally and metaphorically—as she attempted to navigate her way to the international terminal and through security for the second time that day. After experiencing an intense screening from the El Al Israeli Airlines Security and losing her favorite water bottle in the process, she was on her ten-and-a-half-hour flight to Israel. She had no time to process, but knew that she must not overthink, or else she may never leave the airplane once it lands in Tel Aviv.

She spends three days on the central coast of Israel before realizing that this was it—she was in Israel; the highly anticipated moment was finally here. The countdown of the next two months was about to begin as her feet stepped off the bus and onto the sandy roads of Neot Semadar.



Chapter 2: Alone in Jerusalem

New Year's Day, Jerusalem Israel, Daniel Shrives awoke early to a bustling hostel room in a busy city. Moving outside, he sits on the rooftop balcony overlooking Jaffa street deconstructing the events of the past couple of weeks. The Taglit Birthright trip had been a welcome surprise; forty strangers became unlikely friends while fully immersed in Israeli history and culture. The trip commenced in the small town of Zevat in the Upper Galilee, followed by a night at Kibbutz Farod, celebrating the first Shabbat of the trip. The following day was spent on the Golan Heights before traveling to Tel Aviv. Continuing south, the group hiked Masada and swam in the dead sea before riding camels and spending the night in a Bedouin Tent. The trip culminated at the capital, Jerusalem. Exhausted and weary from resolute travel, each member was imbued with an overwhelming sensation of repatriation. Over an emotional Shabbat Service, the participants exchanged parting words with the majority leaving for home early the next morning. Though for many it was the culmination of their journey, for Daniel it marked the beginning of a much longer one.

After an overbooked, fast paced and seamlessly executed trip, five days alone in Jerusalem was a new challenge. The newfound freedom exalted exploration, ensuing days filled with landmarks, museums and mindless escapades. The Old City and Israel Museum were highlights, preceded by the Yehuda Market and Jaffa Street. Without the strain of a leash constantly pulling forward, the pace slowed, and individual experiences were more profound. At the Israel Museum the installation "Space that Sees" by James Turrell was an unintended surprise. The room, buried in a hill, is only found through thorough exploration. Upon finding the concealed opening, a short dark hallway leads to a bleach white room with pink stone benches flanking all four walls. Seated, the eyes are immediately drawn upwards finding a square opening, framing the sky. Watching the clouds shift across the immersive frame conjured an unanticipated meditative state. The encounter provided an overarching metaphor for the five days alone in Jerusalem.

Soon after life became monotonous, the day arrived to take the bus to Tel Aviv, marking the next chapter in his journey. The trip west, from old to new, was chaotic but successful, terminating at the posh Lighthouse Hotel, a dipole of prior Israeli accommodations. The preceding days were spent touring the north of Israel, besides different characters, a logical continuation of the past couple of weeks. After a long bus ride through the arid Negev desert, sleepy eyes awoke to the Desert Oasis of Neot Semadar.



Chapter 3: From Back Woods to the Desert

Ben pulled off a winding dirt road and into a small parking lot by the lake in Pawtucaway, New Hampshire. He was taking his beat-up old Subaru, with the check engine light a permanent fixture of the dash to New Hampshire for one last day of rock climbing before he had to leave for Israel. The lake was frozen over, and the cold silent air of winter wilderness flooded his car as he opened the door and started to assemble his gear. It was only his second time there, and he was left with nothing more than a rough map, and some vague recollection of where to go. After about an hour of stumbling through the woods, he ran into another climber who accurately assessed just how lost he was and pointed him in the right direction. After finally maneuvering his way to the boulder field about an hour later he started to climb. He was the only one out there for miles. *It's funny how isolation in the woods can be both incredibly terrifying and incredibly peaceful*, he thought. Being alone for the experience serves to intensify it.

He wasn't always like this. A few months earlier, the idea of being alone in the woods was unthinkable. He was set to go on a headlamp bouldering trip with some friends, but they all flaked at the last minute. A friend somehow talked him into going alone. He was terrified, but against his better judgement, he still went. After that trip, his perspective changed—he learned to trust himself more, live in the moment, and enjoy solitude.

As the sun set, he packed his gear and headed for his car, following the rough semblance of a trail obscured by leaves and other debris. After a rather circuitous journey, he wound up bushwhacking his way to the Stand and Deliver boulder, a 20ft tall glacial erratic with a sweeping overhang, one of his landmarks. By then, it was completely dark out. He continued back, and after a few additional wrong turns, and another hour and a half, he could finally see the reflections of his headlights through the trees. He ran into a friendly stranger near the parking lot and shared a laugh about his misfortune. “Your mom’s going to be pissed”. He smiled as he stumbled to his car exhausted and more than ready for dinner.

His drive home gave him time to think: There is something satisfying about these adventures, though difficult to articulate. Maybe its building self-sufficiency and seeing what you are capable of when left to your own devices. Maybe it’s the all-consuming feeling of being alone in the woods at night. There’s no room to worry about anything else other than the current moment. You get sucked into the present and everything just starts to flow. Flow state is a term that gets used a lot in climbing. It’s when your body takes over and you escape conscious thought for a minute. All your thoughts except for the present moment dissolve. He was excited for IQP in Israel, and a little nervous too. While he liked the idea of Neot Semadar, he was also completely unsure of what to expect. The nervousness was good, though. It is beneficial to run straight at things that make you nervous or uncomfortable. You learn a lot that way. Despite that, he had spent the previous seven weeks convincing himself he was not nervous, but as his flight took off, the feeling was inescapable.



Chapter 4: Going Up!

In the commotion of Boston Logan International Airport, Austin Shalit, wearing sweats and a t-shirt, was passing through the lines for security. Jet fuel filled the stuffy air inside of the terminal. Austin drifts in thought as he passes through the screening and prepared to board the plane. It was the end of B-term, 2018. Austin had been packing since the early morning because his time in New England dwindled. But now it was time to depart for the new adventure that awaits. This flight, JetBlue 987 direct from Boston to Los Angeles, has become common practice for Austin. It is the last flight of the day to the west coast from Boston. He wants to be back home as soon as possible to stretch the time able to spend with family.

Like at school, there is always something to do at home. Updating computers, fixing cracked screens, preparing meals, chauffeuring people around, or being a passenger in a car so people do not need to travel alone. At first, break was like every other term break for Austin. Making rounds to the doctor, hairdresser, and dentist. Distributing holiday gifts and getting checked up and cleaned up after seven weeks away. There are also the dinner parties with friends and their families because all the children have missed Chanukah the week before arriving home.

There is a celebration for Austin's birthday because he will not be home to celebrate in two weeks. Friends and family come together and rejoice over lunch. This is the last time they will be together for at least a year, each person going their own way.

Finally, after much preparation, the day has arrived for Austin to leave home and go up to Israel to study in the desert. Some last-minute packing of supplies and clothing ensues. A final goodbye is had with the family. There are hugs, smiles, and tears. The next time they will see each other together is unknown to them all. Time is now short because of the unknown holiday traffic that awaited Austin on the way to the airport. The car is loaded with suitcases, backpack, and people. At three in the afternoon Austin and his parents leave for the airport.

The ride to the airport is quieter than usual. Austin's dad reminds him to stay safe, to stay in touch, and to enjoy the experience. Final hugs are exchanged at the curb and Austin disappears into the bustle of travelers in the terminal.

Austin awoke to sunrise in Tel Aviv. Excitement fills the air; Austin has returned to Israel after three years away. He goes for a walk along to the beach front. The city is calm, still waking up and getting started with its day, like Austin. He gets a bagel and lox from an Aroma with a beach front view to relax and prepare for the day.

Isa, the group's advisor, calls just as Austin is finishing breakfast. She asks if he can run to the market to purchase fruits and pastries for the group to snack on while walking around the city tomorrow. Austin instinctively agrees and starts to make his way over to the market. The market is massive and filled with people. Everyone is always in contact with another person. There are hundreds of shops and thousands of people there buying fresh fruits and vegetables, clothing, jewelry, and chachkies. Austin buys what his arms can carry and returns to the hotel. He would make this trip three more times to get enough food for the group.

For the next few days, the group spends time exploring central Israel. Austin eats a lot of shawarma knowing that he will not be able to again for the next several weeks. The group starts to make their way south. Just past Be'er Sheva, the green hills transform into sandy mountains. This is a special time for Austin, it is the first time he has been this far south in Israel. They continue to move into the desert. Mitzpe Ramon is a town built on the northern ridge of the Ramon crater. It is vast, flat, and empty. This is the last look of a regular town that Austin will see for a few weeks.

On arrival at Neot Semadar, it was too dark to see. The light of the cities had faded away and all that was left was a few lampposts and the lights from the bus. The only noise was the soft sound of the group's feet walking along the dirt road.



PART TWO: Journey to Emotional and Spiritual Growth

Carly's Story

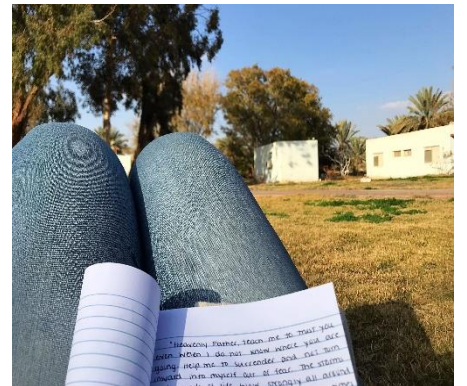



Chapter 5: Off to an Anxious Start

As her feet hit the sand, a moment of relief flooded her body from the soles of her feet to the top of her head. Carly stepped over the first hurdle of challenges that lay ahead—making it to Neot Semadar without having some form of mental collapse. It was a win in her book. She looked to her left and to her right, and around her she saw her teammates, Daniel, Austin and Ben, who had been with her preparing for this journey for seven weeks prior. As relieved as she was to finally be at her destination, she knew that this feeling was to be short-lived.

The first sound they heard as they gathered their things off the bus was the sound of the vehicle driving away, and then nothing at all. It was 3:00pm in the afternoon and there were no people outside, no children playing on the jungle-gym play area they passed, no conversations to be heard in the homes of their new neighbors. “Everyone right now is at lunch,” said Israela, our connection between the school and the kibbutz. “You are welcome to join us for food, or you can get settled in and meet us for dinner at 7:00pm.” Carly was starving after a three-and-a-half-hour bus ride, but her group mates were excited about seeing their new home for the first time. So, they decided to go for a walk around the area.

The sounds of their steps felt like it could be heard for miles. In the Negev desert, the rolling mountains and crevices are not filled with airbrushed sand, but rather water-deprived shards of sedimented rocks, creating a mosaic of burnt orange, dark brown, and black. With each step, the sounds were akin to breaking glass as the already empty and open desert echoed to each step. Overwhelmed at first by the crushing presence of silence, Carly was not sure if this was a normal form of silence, since she was not that familiar with it. Her whole life was centered around the idea of constant movement, introducing new challenges and activities, that to her, this type of silence was more foreign than the land in which she walked.

She does not feel homesick, for at this point the overwhelming sense of living in a new place and experiencing a new culture excited her. However, her fears of true loneliness were staring her in the face as she found her way home from the first dinner. The silence felt heavier at night, as the only sounds to be heard were the rustling leaves that were brushed every so slightly by the evening breeze. She felt as though she had been blown by this slow and steady breeze the past several weeks leading up to her arrival in Israel—she was going through the motions of life and just hoping that somehow someone or something would get her to Israel without her having to think about it too much. Neot Semadar seemed to emulate frozen time, as each minute felt longer here than it did back in The States. The short five-minute walk from the dining hall to the apartment felt like an eternity. She was just being whisked along into this new chapter of her life with no control over what she was to experience, how it would affect her, and if she would be able to survive living in the same small apartment with three men that she had just met seven weeks prior. But as lonely as she felt, Carly found company in Orion, the strong, brightly-lit constellation that seemed to have followed her from back home. Chilled by the night sky, he stands where he’s always stood, and in a strange way it brings her comfort in the form of a reminder that there is someone who knows her heart and knows that a starry sky is her most treasured gift from the nature that surrounds her. It would remind her that God is still there, even if none of her family and loved ones were.



Within the first few days, she began the acclimation process by waking up at 5:30am to participate in morning tea and mindful silence. The cool morning was warmed by the scalding hot tea that she held in her hands as her head hung heavier with each drawing breath. She opted to keep her eyes closed to both experience the silence in a deeper level and to give her eyes some more rest. The lack of distractions allowed for Carly to begin her day as if she were starting afresh—she was

able to sit in thoughtful prayer that allowed for a reset of mind. Her world seemed to stand still, making the short moments last what seemed to be a lifetime. A soft good morning broke the silence, and just like that the world went back into its constant motion.

The anxiety and uncertainty she brought with her disguises itself as nervous excitement as she begins her first job as part of the community. Working all morning in the gardens weeding the garlic patch was exactly what she needed. It provided some level of strenuous activity that was neither difficult nor required extra brain power, so she was happy to perform ordinary tasks until breakfast. Before leaving the garden for breakfast, she was invited by Amir, the head of the garden crew, to join the workers in a circle while they performed an exercise of releasing the tensions of the morning using body movement and deep breathing. This was her first exposure to the uniqueness of Neot Semadar, and she found this to be a refreshing experience. Allowing her body to move in a way that was obscure to normal with a group of strangers felt oddly freeing.

After breakfast, her anxiety bubbled up once again. Before coming to Neot Semadar, most of the preparation was focused on how to capture her experiences here with little to no preparation for the technical aspect of her project—measuring houses at Neot Semadar with handcrafted temperature and current sensors. Despite that fact, it seemed that as soon as they arrived, the sensor project was in full-swing. Daniel had been working on the technical preparation by creating a temperature sensor prototype before they all left for Israel, and since he was the only one with knowledge on this aspect of the project, he took the lead in communicating with Yoram, our sponsor, to begin with the construction of these devices. With no clear group direction or understanding as to what was happening with the project, what was expected of each one, and little time to catch everyone up to speed, the group project trudged forward as an individual project as it felt like the others were left behind. Several were left hurt, frustrated, and tired, including Carly.

Within the span of three days, she had experienced great excitement, fear, loneliness, and peace. She could not begin to determine which of these feelings were legitimate, or if they all were fabricated through her new environment. Her life began to exist in a series of ebbs and flows—within one 24-hour period, she could experience confidence, anxiety, peace, anger, frustration. The constant waves of emotion left her feeling exhausted, as it seemed that the atmosphere at Neot Semadar creates extreme and fluent emotions. The combinations of being in a new place, surrounded by a new culture and language, as well as the severe unknowns that faced her every moment each day left her uneasy. Determined to not let the inner turmoil she felt to affect her once-in-a-lifetime experience at Neot Semadar, she placed mind over matter every day, trying to ignore the disquiet she felt.



On the first Shabbat at Neot Semadar, she slept in for the first time in what felt like weeks. Carly arose from her slumber at the blissful time of 9:45am, which felt amazing considering the last several days she had been up before the sun rose. After taking her time eating breakfast, she retired to a small patch of grass to absorb the sunshine. She felt the radiance of the sun light a spark in her heart that made her think, *I can do this*. Closing her eyes, absorbing in every ray of radiant hope.

The moment, though marvelous, was a fleeting one, for before long she felt warmth disappear behind the shadow of her group mates as she stood over her asking what she was doing sprawled out in the grass with her eyes closed. It was time to go on their hike with Yoram passed the army lines of the neighboring IDF camp. One thing that Carly found humorous about this place that was so focused on silence and self-reflection was the constant sound of machine guns and tank shells exploding in the distance. Was it a contradiction of this place, or was it a harrowing insight to what went on in the hearts and minds of those around her?

Since it was Shabbat, the soldiers returned home for the weekend and the live fire seized. This allowed for all the group, including a new friend that they had made named Elad, to scale the larger mountains that surrounded Neot Semadar as they were led by their project sponsor, Yoram. On the journey, he had encouraged the group that as they walked to not look down at their feet, but rather to look at the views around them. “Trust that your feet know what they are doing, and continue

to walk forward and enjoy the journey,” he said, “because sometimes we are so focused on the wrong things and we miss the profound adventure of the morphing landscape.” This was the first thing that she heard at Neot Semadar that really inspired her. What Yoram was saying reminded her of the verse she grew up hearing from Proverbs 16 where it says, “In their hearts humans plan their course, but the Lord establishes their steps.” So often, she felt as if she were looking down at her feet, trying to control the movements of life and circumstances she found herself in, refusing to relinquish control. Carly would find herself at the end of a seven-week term at school wondering where the time had gone and looking around to realize that there were so many moments missed out on because she did not trust fully that her God was guiding her steps. In the very desert that the Lord’s people wandered for dozens of years and guided their steps with a cloud by day and a pillar of fire by night, she was being taught the same lesson. *Trust that God has your back, that he has plans to give you hope and a future. Then you will be able to look up in this journey of life instead of looking down. You may begin to realize that sometimes it is the journey that is more profound than the destination.*

Maybe there was something she could learn from this place while she was here. Maybe God can speak to her through the people around her. Maybe there was something developing inside of her that was far greater than she could ever imagine, and it began the moment she arrived at Neot Semadar.

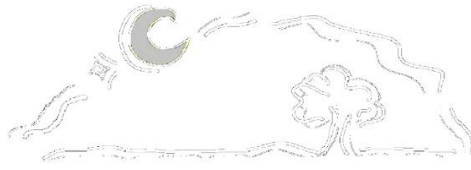

Chapter 6: Where do I Belong?

As life was beginning to truly take off at Neot Semadar, she was determined to try and understand the ways of the community she was now immersed in. Eager to take part, she volunteered several mornings in a row to work in the vegetable garden. There was something about the mundane work of weeding as the sun rose in the horizon that highlighted within the quiet and stillness of the morning that she could find rest. Raised to work with the utmost effort, Carly did everything with swiftness and speed, making sure to put in all the effort she could to complete the task at hand. What she observed, however, was that this was not the way the community of Neot Semadar operated. The other more experienced volunteers around her moved slowly, taking their time to accomplish tasks. They seemed to move with intentionality and deliberation, but without rush. Things were to get done in their own time, and it was not imperative that tasks were to be completed before breakfast. The concept of moving at a slow pace and making room in every action to reflect upon what it is that she was doing and why she would do it made sense to her in a contemplative and life-analytical sense, but not in a vegetable-picking sense.

Looking to enjoy more diversity in her morning schedule, she began to volunteer in the kitchen and dining room to help with breakfast preparations. There was something satisfying in washing and cutting the vegetables that she harvested the day before that were soon to be consumed by the greater community. Carly found herself placed in the dining room more often than the kitchen, which she did not mind. She chooses to make the buckets of soap used to scrub the floors of the dining room, collecting herbs for the tea corner, and organizing the porridge table. Her mornings became filled with more tasks to be accomplished, making the time fly by faster until she could sink her teeth into her new favorite breakfast—homemade tahini and vegetables spread across freshly baked bread and topped with cracked pepper.

The sense of slowness and intentionality seemed not to exist in this part of the morning as it did in the vegetable garden. There was a need to accomplish all tasks before the breakfast gong rang out ten minutes before the meal was to be served. Working at a heightened speed in this facet made sense to Carly, because all the food needed to be prepared and placed on each of the twenty-one tables before 8:30am, therefore, a sense of urgency helps to get the job done efficiently and effectively. What did not make sense to her was how the people here decide when it is appropriate to work fast and deliberately or slow and steadily with no rush. This was her first encounter with the contradictions that lay beneath most practices within the community.

She discovered that the more often she volunteered for the same tasks and understood the responsibilities required to complete them, the more there were different expectations as to how the leader of the group would want the task done. Since the rotation of leader happened daily, even if she volunteered to do the same task every day, she was corrected in her ways and led to believe that she did not know the right way to complete the chore. There seemed to be an abundance of criticism, both constructive and critical, but no positive feedback to reassure that she was accomplishing a job well done. She never thought of herself as an attention-seeker or one that finds her identity in the approval of others, but not experiencing praise for the hard work she was doing made it difficult to continue to do the tasks with a positive attitude day in and day out.

The one thing she found motivation in was interacting with the other volunteers while working. As much as her schedule was fluent and changed depending upon the demands of the project and how much time she had, most people who worked in the kitchen-dining room-vegetable garden group worked there every morning. This made it easy for people to get to know one another on more of name basis, considering every morning the group started with a name circle to make sure that they all knew each other.

Part of traveling abroad meant getting a taste of an unfamiliar culture while being surrounded by unfamiliar faces. It was an opportunity for her to get to know what life was like outside of the small borders of the United States, and she expected

there to be some grace period of acclimation and feeling the waters. What she did not expect was the complete and constant immersion in an unknown Neot Semadar culture, on top of the new Israeli culture. This was an interesting challenge for Carly, since it felt as if she had no break to be able to process and comprehend what she was experiencing, and rather she was swept up into the current of this unacquainted philosophy of life.

What she really longed for was being around people of similar mind, motivation, and heart that she could live daily life with. She knew that the people here were not the same as her, as many of them came from all over the world with different motivations for coming to Neot Semadar. This made it difficult to truly connect with the other volunteers, especially those who had been part of the community for several months and were very committed to the abstract ideas beneath the surface. So, she found herself creating very few deep connections with others and more acquainted faces that she could say hello to as passerby-ers on her way to the dining hall thrice a day.



The complete unknown of the progression of the project was beginning to overwhelm her already restless soul. Experiencing fatigue during the day and migraines by night, it seemed as though there was no escaping this anguish. The sensor assembling shop was set up in the team's living room, making it impossible to separate and sanctify the home as a place of rest. The awe and amazement of living her new life at Neot Semadar was no longer enough to cover the gaping hole that was forming in her soul.

The emphasis of self-reflection and familiarity with silence were aspects of life that she could get behind, but the underlying reasoning the community of Neot Semadar projects was something that grew more uncomfortable as the days went on. There is also this unspoken desire of discovering the harmony that lies deep within humankind that is apparently impeded by the mind, focusing on impression to expression without the filter of thought. They encourage all to participate in experiencing this free way of thinking, but to Carly it seemed more like a boundary or a hinderance to the discovery of the true peace and happiness they were in search of.

The longer she stays at Neot Semadar, the longer she feels as though she is physically and mentally trapped. Her environment has an interesting dichotomy of placing immense pressure on her while also giving an invitation for slow down her life and live with intentionality and no rush. It is hard for her mind to process how she is both at peace and stressed at the same time.

It was difficult to find a true sense of belonging within this community. Since the four of them had come as students to work on an engineering project, they did not come to Neot Semadar on the same pretenses as the rest of the community. This did not prevent members of the community from encouraging them to engage in their mindfulness meetings, intense sessions of introspection, or special Shabbat events of disconnecting the mind from the activity of the body. At the same time, Carly and her other groupmates still participated in morning chores but would continue with their engineering project in the afternoons. For most volunteers, their chores lasted through the afternoon. Carly found herself laying between identities of resembling a volunteer yet excluding herself from most of the afternoon work, resembling a guest yet waking up every morning to clean the floors of the dining room, resembling a young adult seeking transformation yet not wanting to let the ideas and deep-rooted intentions of the community influence her in the wrong ways. The idea of living in a place in which she felt as an outsider in an apparently welcoming community attributed to a level of unease that she had never experienced before. If she was here strictly for business, it would be normal to not feel like she was truly part of the community. But at Neot Semadar, their intention is to create an atmosphere of one—having all people part of one community and under one cause. Yet, she still felt so alone.

She made a commitment to herself that she would not let her emotions and inner self affect how she experienced and interacted with Neot Semadar, but it was becoming harder and harder to separate the two. Was Neot Semadar causing her anguish? Were the circumstances she was in with her teammates as bad as it seemed? Was she ever going home, or was she stuck at Neot Semadar forever?



Chapter 7: Growth Begins with Surrender

While Neot Semadar exists to provide a transformative experience for those who come to volunteer and participate in their way of life, Carly was experiencing her own more intentional, personal, and intense transformation. The idea of trust, patience, brokenness, and rest were reoccurring themes placed on her heart. Her close friend from back home gifted her with several books to read while abroad in Israel about the significance of emotional health to spiritual health. Before leaving, she could already feel that these next seven weeks were going to change her, and she was grateful for the opportunity to use these books to give her vocabulary in articulating her season of growth. But what she was beginning to realize in the intense, pressure-cooker-like environment she was consumed in, spiritual and emotional growth does not come without trials and pain.

Imagine a gardener as he sees his magnificent fields. He feels admiration for the work of nature as it produces fruit in the soil it is planted in, watching as the colors from flowers and fruit dance amongst the green leaves and branches. In order to allow the tree to continue to be fruitful and promote growth, the gardener must prune its branches. There are many reasons why the gardener may wish to prune, including; improving the overall health of the plant, encouraging the plant to put energy into new growth; controlling or directing the growth of the plant in order to shape the plant to the desire of the gardener; to remove the dead pieces of the plant to decrease the chances of the entire plant dying of disease, and; increasing the number and quality of the fruit the plant produces. The gardener knows what is best for the plant to grow, therefore, he cuts away.

In her faith, Carly has heard of the story told in the Bible in John 15 comparing God to be the gardener as she is the branches that, as a believer, abides in the vine of Jesus Christ. “He cuts off every branch in me that bears no fruit, while every branch that does bear fruit, He prunes so that it would be even more fruitful” (John 15:2). She has heard this verse her whole life growing up in church, and even used it as a word of comfort to those around her that were experiencing times of painful growth, but never had this verse felt so real and relevant to what she was experiencing. Pruning is not done gently but rather is done with the sharpest tools to ensure intentionality and precision. It implies that this includes a painful process of being cut of all the dead pieces in her life, whilst pruning the parts of her life that were good and producing fruit. She was lost within this feeling of complete emptiness and brokenness, as the things of her life that were both bad and good were seemingly cut off from her.

When she thought of this verse, she always imagined the action of pruning leading immediately to growth and more plentiful fruit. As her journey continues into this season of transformation, she sees that the pruning is leaving her in a state of emptiness. She is spiritually and mentally exhausted and lacking all strength—she is on her knees with her hands tied behind her back as true brokenness takes form within her.



She has reached her limits of mental and physical exhaustion. It was an amazing experience for her to have a mid-week trip to Masada, Ein Gedi, and the Dead Sea, but it drew every ounce of life she had left inside of her. Carly had been running on fumes a fire, barely having enough energy to last her through her days at Neot Semadar, but when she returned it felt like it was the last gust of wind to blow the flame right out.

She misses her loved ones fiercely. Being at Neot Semadar, though at times felt as if it was torture, allowed her brain to be occupied with other matters so that she did not have time to miss her family back at home. She was at the stage of her

spiritual transformation of journeying inward to look at her heart and the process took everything out of her. Like how the food at Neot Semadar was just enough to give her the energy, she felt as though God was giving her *just* enough life to make it to the end of every day, leaving her drained and fatigued.

Carly can feel in her heart a call to trust that this path she is on will lead her to understanding herself and her relationship with God and how the two are intrinsically intertwined. Though she does not know where the path leads, her brokenness calls her to a point of surrender. She is surrounded by nothingness and fear and unease, that in order to move forward in growth, she must trust that as she walks, God is guiding her steps.

Growth is a long series of developments that require complete trust and obedience to be pliable and willing to be continually pruned. It is an exhausting choice to everyday request to be filled of strength, patience, and obedience when there is absolutely nothing left inside of her but knowing that the journey is sometimes more profound than the destination, she continues to press on through the restlessness.



The sunshine has been her mode of recharging and refueling, since that is usually when she is able to read her books outside and capture moments of rest within the passing day breeze. Carly can escape to these sanctuaries of momentary rest through going to the man-made lake and sitting on the dock to journal and read. Watching the birds fly overhead all afternoon as her pen dances over the page, she can feel her heart become full. One thing that her time at Neot Semadar has begun to teach her is the power of silence and solitude and the effect that it has on her self-care and ability to converse with God on a more intimate level. It is a lesson she cannot imagine learning anywhere else—Neot Semadar creates an atmosphere of journeying with self through stillness and intentionality. The benefits of being alone to meditate and pray and delighting in the simplicity of life are concepts that Carly is grateful to be learning.

As the birds nestle into the warmth of the sunlit brush of the banks as the sun sets, she thinks about how these animals are taken care of by the nature that surrounds them and the One who created them. It reminds her of Matthew 6, where it says, “Look at the birds of the air; they do not sow or reap or store away in barns, and yet your heavenly Father feeds them. Are you not much more valuable than they?” She sees how the brush seems to hold the birds in comfort and protection, and yet God promises that he loves her and values her more. The emptiness that consumes her that is used to strip away all things that are old and no longer beneficial for her is beginning to be filled again, slowly but surely.

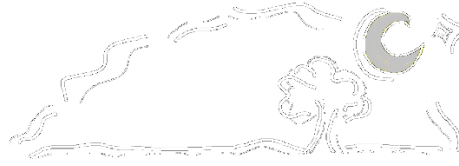

Chapter 8: Once Empty, Slowly Being Filled Again

How can I give when I feel as though I have nothing left? How can I show patience and kindness, gentleness and mercy, when I barely have enough in me to get myself out of bed every morning at 5:30am? How am I supposed to pretend that there is not a tumultuous storm raging in my thoughts and that everything is “well with my soul?”

These were the thoughts that ran through Carly’s head in the cold, early morning in late January. She could not shake this feeling of emptiness, and yet being filled with these unnamed emotions that were eating her alive. Neot Semadar emphasized the idea that intense emotions that are felt are just that—they are nothing but a feeling. They train people to see emotions as raw impressions of their surroundings, recognize and acknowledge them, and move on from them without tending to them or identifying them with any legitimacy. To some extent, it is important to see certain emotions as improper reactions to certain events and to take them at face value to not let the emotion take over. But it is another to say that there are “good and bad emotions” and the way to rid of the bad is to convince yourself that it is an overreaction or that the feeling itself is illegitimate.

It made it extremely hard for Carly to process her inner thoughts and feelings when she was surrounded by a community that convinces itself daily that life without the constant engagement of the mind and one without over-analyzing life is the best way to live. This filled the empty void in her heart with such intense loneliness that she could feel herself transforming into a version of herself that she did not recognize. When her advisor asked what it was that was causing her so much strife and anxiety living at Neot Semadar, it was impossible for her to place her finger on just one thing—it was an accumulation of little inconveniences combined with the intense loneliness and inability to properly express herself in a way that was healthy for her that left her in a state of emotional disarray. She used to be outgoing, fun-loving, adventurous, patient, and accepting of new experiences. Now, she wanted to spend all her time in her room with the door closed and head under the sheets.

As she was walking from the laundry room with her freshly clean clothes, her mind went blank. For the first time, she felt as if she was watching herself from an outer-body experience, and that as she watched this poor, emotionally wounded human meander through the tall grass, she could not help but wonder if this was her new life now. Was she to live in a constant state of unease and discontent? Would it be easier for her to just convince herself that none of this was real, that her emotions held no weight, and to delete the mind from the experience of life, just as the community of Neot Semadar wanted her to?



It takes remarkable courage and complete brokenness for one to be able to see their circumstances, feel the turmoil in their hearts, and make a conscious decision to cling to God’s promises as a form of hope and supernatural strength. She had been in that state of brokenness for some time now, though her brain tries daily to convince her heart otherwise. As much as she was trying to guard herself from the anecdotes of Neot Semadar, her mind was fighting against her in the spiritual warfare she was in. Did she have the ability to overcome this experience, or was she trapped in the cycle of her own unfiltered thoughts and emotions forever?

There were aspects of Neot Semadar that still provided her with glimpses of sanity, like the beautiful landscape that seemed to expand further and further the more she explored. Carly would take runs around the grounds to try and clear her head, and it was in those moments when she was alone in the beauty of nature that she was reminded of the gift of solitude this place gave her. It was in that solitude that she was able to connect with her faith in a way that was more real to her than she

had ever experienced, and the silence that allowed for her to hear God's voice so clearly. She was thankful that even in her circumstances of madness, she could still run to the secret places of the gardens and find some form of rest. Though she was constantly filled with confusion and contradiction over the ideas and practices of this place, it allowed her to work through her faith in a secluded setting where time seemed to stand still most of the time, allowing her to ask the questions she did not know she had.



The growth she had already experienced from the pruning process and the slow, gentle, yet strong refilling of her spirit was already enough to call this IQP a success, but she still found herself struggling with the concept of having to stay at Neot Semadar. With three weeks left in Israel, Carly grew frustrated that she was to be held mentally, and to an extent physically, captive in a place that she truly did not want to stay. She had to constantly remind herself that her timing was not perfect, and that if she still had three weeks left at Neot Semadar, then there was still more to learn and more to grow in. But as easy as it was to tell herself this, believing it to be true was a completely different story.

Feeling as though she was spiraling, she planned a trip to Eilat for the weekend with her group mates, her roommate, Sarah who had been working at Neot Semadar on her MQP along with Carly's group, and the other IQP students from Ketura. They arrived at their hostel to see that they were right on the coast of the Red Sea with full access to the water. It was an instantaneous reaction that when Carly's eyes met the sea, she felt as if she were home. She had loved the water ever since she was a child, as growing up on the beach town of Cape Cod cultivated in her a deep love for the sea.

The night was full of exciting adventures of walking through downtown Eilat and experiencing humanity as the vibrant, exciting, and versatile thing that it was. Eating mac and cheese, nachos, hummus, and pizza, she loved the feeling of food that was not vegetables or bread hitting her stomach. It felt good at the time, but after a full meal and a few rounds of bowling, she found that her stomach was not so happy with her after all.

The next day after napping in the warm sun for a while, she found herself excited and anticipating the next item on the agenda—snorkeling with the tropical fishes of the Red Sea. She and Sarah had been talking about doing this since they started making plans to go to Eilat. It was the thrill of exploring the intangibles in a foreign land that really excited her, because not only was she able to see many tropical and colorful fish, but her friendship with Sarah grew stronger than in the past month-and-a-half that they had been roommates at Neot Semadar. It was part of the IQP experience—being able to participate in new activities, new challenges, and new adventures with a group of people and a culture that she had never interacted with before. In that moment, she was so grateful for the opportunity to be in such a beautiful country, experiencing many different levels of Israeli culture, all the while with people she had only met seven weeks prior to leaving for Israel.

The trip to Eilat was exactly what Carly needed in order to have a clear head as she started the mental preparation for the last two weeks of her project abroad. She was back to waking up at 5:30am to do work for the community, which was fine with her. Now that she had a new and rejuvenated spirit, she was ready for anything that Neot Semadar had to throw at her.



Chapter 9: Seeing through the Lense of Gratitude

In the week before final reports and presentations were due, Sarah, Ben, and Carly decided to venture to Timna National Park for the second time in two weeks to celebrate Sarah's twenty-second birthday. After several missed busses and a two mile walk from the main road to the park's entrance, they were ready to begin their ultimate birthday adventure. Renting electric-assist bikes, the three of them raced down the roads as the colors of oxidized-copper blue, burnt orange, bright pink, and deep purple roll over the mountains on the Israeli skyline. There was something about feeling the wind in her hair and her scarf flying behind her that made it easy to let down the walls that had been built up so firmly since her time at Neot Semadar. She had not felt this free in months.

After stopping for brief intermissions of rock and landscape gazing, the three friends made their way to the Timna Oasis—a man-made lake with a restaurant and camp area. They all entertained the idea of spending their last Shabbat sleeping in a small two-person camper under the stars in the middle of the desert. The day-dreaming was cut short by their lunch showing up on big black platters. All sharing a bucket of fries with a refreshing drink, they looked into the horizon at the Jordanian Mountains. Like the presence of God in Carly's life, these mountains had been on every horizon since she landed in Neot Semadar. Even when she travelled, even when the weather was too foggy to see them, they were always there. Similar to her constellation friend, Orion, these mountains were a factor of consistency that she had longed for the past several months but never truly noticed their presence. In this moment, however, she was cherishing every moment of staring straight into the majestic and magnificent mountains.



On the bus back from Timna, it felt as though the veil was being removed from her eyes. Watching the mountainous desert run alongside her, she realized that this was the land in which she had learned about and heard about her whole life. Israel used to be this illustrious far off place where miracles were performed, hearts were transformed, and the basis of her faith was born. Not only was she only at Neot Semadar for a short amount of time, it was very likely that it would be the only time. So little time was spent truly being in awe of the place in which she had been living for the past two months.

Determined to have a more positive outlook on her last few days at Neot Semadar, she worked hard in the dining room cleaning floors, organizing the tea and porridge tables, and getting the rags ready to clean the tables post-meal. She worked with intention and determination, just as they wanted her to. She worked silently and took the seemingly constructive criticism of her peers as she performed the same tasks day in and day out. She participated in mindfulness meetings to appease the hearts of her Neot Semadar guides, Neta and Mor. Yet, all of this felt like it was in vain and in the wrong motivation.

As much as she is committed to the philosophy of “mind over matter” at this stage of the project, it still did not wipe away the thoughts about feeling trapped within the gates of Neot Semadar. She found herself becoming bitter about her Neot Semadar home, and with the days before she left inching closer with each moment, she was searching all over for the remote to her life to press fast-forward. She did not want to think or live this way, and it may have come from the culmination of an intense immersion experience with this community and also the stress of completing her project before the deadline, but she knew that this was not her normal way of thinking. She was so determined just days ago to end her days on a strong note and leave Neot Semadar creating happy memories instead of sad ones.

Frustrated with her current state of living, Carly ran back to the one thing she knew always gave her joy—music. One night as Sarah and Carly were getting ready to fall asleep, they heard a faint knock at the door of their apartment. Gal walked in, a volunteer that they had become acquainted to, and in his hand was a beat-up old guitar he had been carrying with him for years as he traveled around the world. They had all talked about having a night of guitar playing and singing, but it did not

come to fruition until that night. They started by trying to sing songs from the book he brought, but neither Sarah nor Carly knew the tune to any of the songs. Instead, Gal chose his favorite song and the three of them sang it repeatedly until the mumbled words turned into beautiful vocals. It was a wonderful feeling for Carly to be able to sing again and let her mind not think about the current circumstance, but rather float in this moment of new-found harmonies and melodies. After a short while, Gal left the apartment with intentions to participate in one of the mindfulness events that Neot Semadar puts on every other week, to which Carly and Sarah opted out of. Instead, they spent the night playing old and new songs, Carly teaching Sarah the basic chords to play on the guitar, and the two of them staying up until almost midnight.

It was the moments like these that she wanted to remember her IQP experience as—moments that were filled with laughter, exploration of new ideas, and good times with new friends. She wanted to remember how she faced the adversity with everything she had, how she quelled arguments and gathered cooperation from her teammates, how she interacted with this new culture and how it had affected her. She wanted to remember her time in Israel as a whole, including the parts that she spent away from the project. She felt that she had more opportunities to experience the culture when she was exploring the ruins of Masada, walking through the old city of Jaffa and Caesarea, and swimming in the Red Sea while watching the Jordanian Mountains loom overhead. Her project was more than just the sensors that she was working on, or the reports she wrote, but it was the overcoming of challenges coming from within an unknown land and finding ways to understand a culture that differed from her own.



Carly realized that this whole experience would be difficult to explain to her friends and family back home—so much had happened over seven weeks that transformed her spiritually, challenged her mentally, and changed how she viewed herself and the world around her. It would take time to truly process what life at Neot Semadar meant to her, and time to understand what is still true in her life and what was fabricated by the environment she was in. All Carly knew for sure was that she had done what she set out to do—she conquered the unknown by trusting in God for the strength and courage every day to do the hard things. And she was all the better for it.

As she drifted off to sleep that night, all she could think about was the new songs she learned, the new friendships she had made, and the new place that had become home for the last two months. There was so much she encountered within the gates of Neot Semadar. One thing she came to realize is that every day is a gift and every moment is a treasure, but only if you seek to find them as those things. She made a promise to herself that she would encounter life this way for the rest of her days, always seeking to find the joy and the blessings in the little moments and creating space in her heart to make space for new experiences, new cultures, and new adventures.



PART THREE: An Unexpected Israeli Adventure

Daniel's Story





Chapter 10: First Impressions

Arriving late in the afternoon, the group pulled their heavy bags down the intricate and colorful cobbled pathways arriving at a pleasant family neighborhood and apartment 360. Entering the house, a living room and small kitchenette was proceeded by three bedrooms and two bathrooms. Satisfied with the housing and bags deposited, the group left to explore the kibbutz they would call home for the next seven weeks. Time spent at several kibbutzim throughout the Taglit trip allowed for instant comparisons. Neot Semadar immediately emitted an overwhelming sensation of intentionality. This persistent consciousness permeated through all parts of the kibbutz, initially illuminating itself most clearly through architecture and landscaping.

Soon after arriving they met their sponsor, Yoram Tencer. Under his arm was a piece of wood channeled for the temperature sensors they were tasked to build. Though plans had been discussed over Skype, it was a motivating head start. After settling into their new abode, dinner time soon approached. The group departed slightly anxious for what was to come, as they knew Neot Semadar's practices were unconventional, namely, the tradition of silence. Upon entering the dining room, each person sits at the next available seat, in front of them, an array of colorful food. When a platter of food is finished, a raised hand will signal an immediate refill. Sitting down they began to eat, the meal was tasty, and the silence comforting. Rather than being burdened with introductions and small talk, the group was given the opportunity to enjoy the meal. Dinner illustrated this principle most clearly because minimal conversation is permitted. It was common to have small table chatter without the encumbrance of introductions or explanations of the project. Instead, it was a chance to have light amusing conversation. Immediately came the realization that all the analysis and contemplation completed prior to arrival at Neot Semadar was to be taken with a grain of salt. Though there are many deeper meanings to silent eating, at the surface, it provided a more comforting and inviting experience. By labeling the kibbutz as a "mindfulness community" the students had approached with presuppositions that had to be recalculated.



Before they realized, their lives settled into the rhythm of Neot Semadar, beginning the day with Shaharit, an unusual but wholesome morning ritual. Leaving the house under cover of darkness, the walk to the dining hall serves as time to reflect and awaken before entering through the open door around 5:30am. Members gather in a semi-circle facing the center of the dining hall in complete silence. After preparing Turkish coffee or tea, you are invited to sit without instruction or expectation. Occasionally, deafening silence surfaces and saturates the room until a small movement breaks it. The unique situation invites intentionality in motion, a small sip of coffee or shift in your seat is heard throughout the room. Soon, movements are coordinated with another member entering, though footsteps do not mask a gulp. The ritual concludes when an unassigned member utters "boker tov" (good morning). Slowly members stand and prepare for their morning work, gradually moving towards the schedule posted on the wall.

Ten minutes before breakfast, the gong sounds, signaling the approaching meal. For the first time in years, Daniel had spent a week separated from his phone. Immediately, he is overcome with a sensation of sovereignty that had been absent. In conjunction with the independence from time, days became continuous. Without interruption, mental flow is easily attainable, and thoughts quickly became palpable. Trusting the gong, time is irrelevant; actions and thoughts became paramount. Morning work provided an unprecedented opportunity to let thoughts manifest themselves, occasionally becoming overwhelming. Lacking the distraction of a phone, silence superseded conversation; growing a connection between individuals greater than words. When one is using a smartphone, it is difficult to determine what reality a person

truly exists in. With an infinite stream of information accessible, the mind is fully saturated and exists in an unknown state. Without substantial meaning, joy is short lived and is soon replaced with a void. Each morning, strenuous work was at times unpleasant, but when the gong reverberates throughout the kibbutz true sanctity is found through undeniable achievement.



One aspect of the kibbutz that came as a surprise was Klal, the unspoken guidelines or rules that provide the foundation of the community. In contrast to most societies that follow strict regulations, Neot Semadar rarely defines them. A sharp glance by a senior member alerts you of a minor infraction, and a stern warning heralds a substantial mistake. This mindset transfers to work groups; in most cases, instructions are minimal; the individual is left to fill in the blanks. One morning, Daniel and Ben were assigned to clean the Magen David neighborhood. The group leader asked for each worker to take a hoe and remove weeds. Upon asking for further clarification, the question was met with more open-ended tasks. After some time, this attitude towards work became comforting, as with autonomy came the opportunity to take liberties. Occasionally, however, this approach to work became frustrating. The dining room is cleaned every morning in the following manner: firstly, the floor is flooded with water from a hose and soapy buckets, then brooms are used to loosen up dirt and debris. Finally, squeegees are used to move the water to the front of the dining room where drains are located. Logically, the water should be moved from back to front following a horizontal line, thus preventing water flowing to an area that has already been dried. By instinct each person cleaning acts autonomously rather than part of a group, causing a suboptimal outcome. In accordance, the efficiency of the work takes secondary importance over the attitude put forward.



Wandering through the kibbutz scrap yard late at night, exploring cars and old machinery, Daniel and Ben stumbled upon broken and discarded bicycles. Looking for a weekend project, Daniel spotted a long- forgotten BMX bike that caught his eye. Familiar with bicycle maintenance and knowing the trials and tribulations involved with brakes and gears, a BMX bike was perfect because it required neither. However, some problems immediately surfaced. The rear axle was bent and the headset, bottom bracket, and drive side pedal were troublesomely loose. Though Daniel was well accustomed with working on bicycles, living on a kibbutz presented a unique challenge. Unlike in his home workshop, there were no parts other than those found on broken bicycles and there were no other BMX bicycles on the kibbutz. Improvisation was necessary. After several days, the bicycle was rideable and brought a new perspective to the kibbutz. Nights were spent speeding down the cobbled paths snaking throughout the community, exploring new corners of the large kibbutz. Turns were taken without a destination in mind, rather they were a result of an open conscious. To slow down, Daniel placed his rear shoe above the tire, resting his shin on the seat, pressing down until the desired speed was reached. Soon the bicycle raised intrigue from other kibbutz members opening another window into the community.



Throughout early work on the temperature sensors, it became immediately apparent that the lack of available resources would provide a new challenge to the project. The evident lack of tools and resources made simple work on the project more challenging. Unlike in Worcester where almost any electronics component is a short drive, or an Amazon order away, in the Negev Desert of Israel, it is much more difficult to source materials. Initially the team needed 10k and 5k pull-up resistors for the temperature and humidity sensors. Usually this task would be trivial, but in reality, it was far from. Yoram placed an order over phone from a small shop in Jerusalem who sent a variety pack. In total, it cost ten times as much as it would have in Worcester and took twice as long to arrive. The challenge of finding parts and tools brought a level of problem solving that Daniel was not used to. Rather than spending time on high level tasks, time was spent looking to repurpose the available materials.

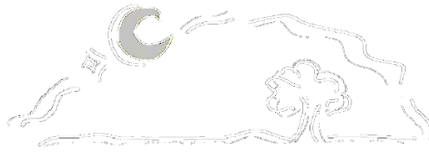

Chapter 11: Growing Relationships

Boarding the regional Egged bus headed North, the Neot Semadarnik's left for a two-day trip to Ein Gedi. As the bus pulled away, they were reunited with their peers living at kibbutz Ketura. The two-hour bus ride snaked through the Negev desert until the blue water of the Dead Sea broke the continuity of the arid desert. Once arriving at the hostel, dinner commenced, and it was the first community dinner not in silence. The relaxed table conversation was deafening in comparison to what they had been acclimatized to. For Daniel, the trip had immediately reframed the experiences at Neot Semadar thus far. This simple frustration with practices of the outside world exemplified one of the many reasons people choose to stay at Neot Semadar. Beyond the abstract rationalizations given, there are simple concrete traditions that make life more comfortable and meaningful. Though many members state that it takes years to experience true transcendence, those who stay for a short period of time can appreciate the concrete effect of these abstract thoughts daily.

The hike up Masada brought back strong memories of the Birthright trip, this time the ascent took twenty-five minutes; arriving just in time to watch the sun rise above the horizon, the exhaustion intertwined with awe, resulted in euphoria. Walking on top of the mountain, new experiences filled in the gaps of the old, solidifying the panoramic views and archeological digs. The question in his head, still to be answered was the nobility and ethics of the actions taken by those during the well-known Siege. Was self-inflicted death honorable in the face of inexorable slavery.



Now that the team had spent a substantial amount of time at Neot Semadar, Daniel started to feel more a part of the community. Though the group segregated themselves during the day due to work responsibilities, full working days and time spent with other volunteers outside of work hours helped assimilate. While walking around the kibbutz, every face was recognizable and most exchanged a friendly head nod. Though there are many members of the kibbutz still to meet, the group had been around long enough to be recognizable as the "American School Group". This integration has allowed for many insights that would not otherwise be apparent. Listening to the stories of members both short and long term as well as the stories of hikers passing through has illuminated new aspects of kibbutz life at Neot Semadar. It became apparent that compared to other volunteers who spent a similar amount of time on the kibbutz, the WPI group had not associated with other members as strongly. This is in part due to three reasons. Firstly, the group does not work with other volunteers during the day, thus missing out on an opportunity to socialize. Secondly, because they knew each other before coming, and are working on the same project, there is less opportunity and incentive to reach out and spend time with others. Lastly, not knowing fluent Hebrew makes conversing more difficult for Israelis and removes some depth to interactions. Though it has been difficult to make friends, each member of the group has found other kibbutz members who they enjoy spending time with and helps them grow roots more firmly into the community.

Facilitated by the style of conversation Neot Semadar encourages, discussions with fellow volunteers and members carried more weight than many of those experienced in the United States. Through these conversations, the topic of life trajectory was common, and the juxtaposition between many volunteer's trajectories and the groups became clear. Many volunteers come to Neot Semadar in a stage of life where direction is unclear; fulfilling a sense of emptiness by this unique environment. This is very different from WPI, where peers search for the best internships, look for the most fulfilling career path, in many cases with the goal to provide a financially comfortable life. Many volunteers at Neot Semadar are in their late twenty's to early thirties and are still looking for what will provide sufficient meaning to sustain them throughout their lives.



On the second day of full work, Daniel was assigned to the maintenance crew, his job was to demolish a closet in a young family's home to make more space. He was joined by another kibbutz member who would lead the project. Before he knew it, he was strategically pulling down drywall and studs, making sure not to make more work than necessary. The work was therapeutic, it required attentiveness and care but was satisfyingly destructive. By breakfast, most of the closet had been removed, with some studs remaining. They clambered over the rubble and hitched a ride in a club car to the dining hall. After breakfast, work resumed, it was now time to finish the demolition and start cleaning the mess they had made. After carrying large pieces of drywall and 2x4's out of the house and giving a thorough cleaning, it was time to start spackling. Holes made by removing screws and nails were carefully filled and sanded to provide a smooth finish. Through the work, two pillars of Neot Semadar became apparent. The young family, expecting another child soon was aided by the power of such a tight knit community. When they needed more space to house another child, the people and structure which surrounded them ensured it would be completed in a timely manner. The house being renovated was among those at the end of their life, with the plan of demolishing them once new houses are built. In many other communities, time is allocated to building and expanding. Rather than allotting our time to building something new, it was more important to repair the old. This trend holds true to many parts of the kibbutz, with many small fixes being completed every day. By the end of the work day, they had accomplished much more than was expected. By dinner, Daniel was exhausted but satisfied, feeling fulfilled through a successful days' work.

Daniel's work on bicycles continued, maintaining and upgrading the BMX bike as well as helping Ben with his project bike. Located next to the technical center is a bicycle work area with a sparse assortment of tools, a tire pump and parts bikes. One afternoon Amir, the head of the vegetable garden approached Daniel, asking if he knew how to work on bikes. Amir complained he was having trouble pedaling and the bike made a clunking noise. After some inspection, Daniel realized that the rear axle was very loose and needed adjustment. Within minutes the wheel was off the bike and on the workbench. With the limited tools, Daniel tightened the non-drive sided cone until it was perfect, then clamped it down with the lock nut. With the wheel off, Amir ran home and got a new tire which he wanted installed. Daniel showed Amir how to correctly fit a new tire, and let him try it himself to solidify the knowledge. Re-assembling the bike was quick and Amir left pleased. The interaction helped build a meaningful relationship; Daniel was left satisfied. Amir had taught him many new skills in the vegetable garden, and now Daniel had now returned the favor.



Late Friday afternoon, Gal, a friend who Daniel had met over a shared interest in riding bicycles knocked on the door. He asked if Daniel wanted to ride to Samar, another kibbutz in the Arava region, located 30km to the south. Daniel inquired when they would leave, and Gal responded, now, it was imperative for them to depart as the sun was setting in two hours. Without hesitation, Daniel knew he wanted go, it would be a substantial physical challenge, but possible. After being an avid cyclist as an adolescent, he knew he was capable of the journey, and knew what to expect, but it would still be challenging. Not knowing that nights sleeping arrangements, he packed a bag full of warm clothes and mounted Yoram's mountain bike. Riding away from Neot Semadar into the desolate desert felt freeing, shifting the bike into its highest gear, Daniel aligned his front tire parallel to Gals, with two inches between them. Years of cycling had taught him the significant advantages of drafting. Soon, they would descend 1300 feet over the course of five miles, the most exhilarating part of the ride. Daniel tucked his head down, with his elbows and knees touching the top tube. Soon he picked up significant speed, full concentration was paramount, as anything less would not be safe. Daniel felt at home, finally he was comfortable, fully in his element. Heavy braking into each corner compressed the suspension fork, his arms getting tired holding his body back as it was thrown side to side, apexing each corner. Finally came the tough part, 20km of flat desert terrain, the bike stayed in top gear and Daniel's legs found their cadence, pumping away at full speed. After an hour and a half, the duo arrived at

Kibbutz Samar and rode towards the house of two volunteers who had moved from Neot Semadar. Riding into the kibbutz, Daniel asked Gal what made this kibbutz special, he responded, they are Anarchist.



Chapter 12: Loose Ends

Sunday morning began like any other, this morning's work was with Ben, continuing to work on building a fence around a small green pasture. After marking an X in the dirt where each post would be placed, they were driven into the ground with a manual pile driver. After all posts were placed, Daniel and Ben drove with a kibbutznik to find a pipe needed to build the gate. Finding the pipe, they quickly realized the twenty foot by 6in diameter, thick wall pipe would not fit in the small Toyota pickup truck. To move the pipe to the metal workshop they found an old John Deere tractor with a trailer and the member asked, do either of you know how to drive a tractor, Daniel responded, yes. He had some experience driving tractors, but he knew his confidence driving manual would serve him well. With great excitement, Daniel boarded the tractor, he pushed the clutch to the floor and turned the key, the tractor sputtered to life. He selected high range on the left and second gear on the right then slowly let out the clutch waiting for it to grab, at the top of its stroke the tractor slowly moved forwards. Ben jumped in the fifteen-foot-long trailer and they departed. Pulling onto the main road, Daniel shifted into third, then fourth, and they were on their way. Daniel was effervescent, driving manual tractors, especially with trailers was one of his favorite activities, immediately his week was off to the best possible start.

This experience corroborated a point Yoram had made earlier, Neot Semadar is not a community, but an extended family. The trust and confidence required to allow Daniel to drive around the kibbutz closely resembled that which he had only experienced with family. Throughout his childhood, his grandfather, a former kibbutznik, let Daniel drive tractors and cars from the moment he could reach the pedals on each respectively. The trust his grandfather had endowed brought the confidence to challenge himself throughout many of life's hurdles. The close connection resonates throughout the entire kibbutz and fulfills a primal desire for a family who can both provide, nurture and protect. This theme is crucial to the makeup of Neot Semadar, but also dictates its future. For individuals to invest their lives into a structure, trust is paramount, the intimate relationship between each member is crucial to the success of the whole.

Over the last few days, morning work in the kitchen brought a new perspective. Rather than following instructions, Daniel was able to complete all tasks from memory, each executed with experience. The inhibition caused by the fear of doing something wrong had vanished, and he was able to relax through the repetitive work. The last morning working at Neot Semadar was spent washing rags and cleaning dishes. Though before he arrived these were his least favorite tasks, and avoided them at all cost, he felt the opposite now. By carrying out these responsibilities involuntarily, he had come to appreciate them in a newfound way. The gong signaling breakfast reverberated through the kitchen before he knew it, the last of his morning work had coasted by. He would miss this time in the morning, a chance to reflect and process before the day began. Returning to school, Daniel hopes to continue this practice of completing unpleasant or repetitive tasks early in the morning as it facilitated productivity throughout the rest of day.

With the end in sight, Daniel feels there are many loose ends that he will have to leave. He felt, with more time he could improve not only the school project, but also the bicycles he has worked on and the relationships he has grown. Along with the physical loose ends, Daniel also feels there is much more to learn from Neot Semadar, and much more to learn about himself. With classes resuming upon his return, he must absorb what he can in the time he has remaining. During this time, he also begins to realize that what he is experiencing now may never happen again. This isolated community is very private, and only accepts volunteers for long periods of time. After being a part of the community for almost two months, the connection he has with the kibbutz as a whole has grown stronger. Walking down the cobbled paths and eating in the dining hall now holds more value in these last fleeting weeks, each step is one to remember. The true beauty of the landscape and architecture begins to impact him in a way it has yet to before.



PART FOUR: A Metal Shoelace—Learning to Thrive

Ben's Story





Chapter 13: Upon Arrival

The bus from Tel Aviv dropped the five of them off in the middle of the desert. As it turned around and drove off, first the distinct sound of tires biting into gravel, then silence. They were left standing in what would be their home for the next seven weeks. They dropped their stuff off in house number 360, a small prefab house, sparsely furnished with blank white walls. Eager to get to know the area, there was exploring to do. The group set out looking for the lake which they found after wandering through the art center, but it was fenced off, so they decided not to explore further. The art center was a pastille pink Taj Mohall inspired monolith, featuring a cooling tower visible from anywhere on the settlement. After that, the group ate a far from filling diner of soup and salad, before returning home. The light vegetarian meals of Neot Semadar provided a sharp contrast to the heavily fat and protein dominant copiously sized meals of back home. An average dinner for Ben was twice to three times the size of what he got in Neot Semadar. As soon as he walked through the door, Ben planted himself right next to the coil heater. He found it impossible to stay warm, probably due to the combination of hunger and exhaustion. Dreading the 5:30 am wakeup call he went to sleep.

Their first full day, Yoram took the team on a tour at sunset. Yoram was a founding member of the community, and would serve as a guide, introducing them to their new home. As Ben jumped the fence to the lake following Yoram, he was conflicted. He was exploring an amazing place, but all he felt was cold and tired. He resented the fact that he couldn't enjoy the experience, especially since he was in his element. He was hiking, and normally loved exploring new domains especially outside, but today it felt off. It might have something to do with the fact he was sleep deprived and still adjusting to a new diet, but that alone should have been easily manageable. When he got home, he was very tempted to post all about his experience on Instagram to have others validate it for him but restrained the urge.

The next day, feeling paralyzed by uncertainty of what he was and wasn't allowed to do, and fed up with the lack of autonomy that facilitated, Ben decided to take a walk alone at sunset. He climbed to the top of a nearby hill and watched as the sun set the cliffs of Jordan aglow like a Renaissance Painting. It was breathtaking, and Ben was at a loss for words, but that was okay because there was no one around to talk to. This newfound freedom gave him energy. He now had a whole desert to explore. As the daylight faded, and the desert adopted its freezing cold nightly persona, Ben took a minute to note that most of what seemed to be wrong was really just a minor inconvenience and letting go of that discomfort was key. Also, taking the initiative to do things like this for himself would be important. When faced with uncertainty, it is important to not feel paralyzed by a lack of instruction, and to take initiative rather than donning a self-imposed short leash. Before dawn the next day, Ben standing around a barrel fire made by a volunteer who seemed well versed in the skill, along with a few other volunteers. One of them was dropped at Neot Semadar after accidentally wandered into the IDF training area while hiking the Israeli National Trail. Another, Elad, had spent years traveling from community to community all over the world. All of the volunteers were incredibly interesting people with amazing stories to tell. Ben was back in the fields before dawn the day after, standing around a barrel fire made by a volunteer who seemed well versed in the skill, along with a few other volunteers. One of them was dropped at Neot Semadar after accidentally wandered into the IDF training area while hiking the Israeli National Trail. Another, Elad, had spent years traveling from community to community all over the world. All the volunteers were incredibly interesting people with amazing stories to tell.



As Ben was clearing and spreading mulch in front of houses one morning, he ran into the first person he met who didn't enjoy the community. She said you either hate it and grow to love it, or love it and grow to hate it which Ben found a little unnerving given so far, he had a positive view of the community. She felt there was no way to make changes or improve

things, and a little too much just putting your head down and doing what you're old. It is an interesting moral dilemma. There is an importance to both questioning what you are handed, but also learning to thrive with whatever hand you've been dealt. Ben had always defined confidence as belief in one's ability to deal with whatever life throws at you. Finding the line between what one should do within the given rules before trying to change or break them proved difficult. Normally Ben would want to work within what he was handed, but the volunteer he met took issue with the given constraints leading Ben to wonder if he was missing something. The near spiritual importance placed on work also challenged Ben's perspective. He was used to a clear distinction between work and activities done for fulfillment and entertainment. For example, rock climbing served as a form of moving meditation to escape the stress of life. At Neot Semadar, work, introspection, getting out of one's head, and life all seemed to converge.

It was Saturday morning, and the tank battalion was taking a day off, which meant that the team's domain had expanded greatly. They walked with Yoram to a farther hill, the highest point around for miles. It was a great hike, and it was fun to be out with friends, but it didn't feel entirely right either. It was only a few miles, and not physically demanding enough for Ben to be satisfied, and the cliffs that had been stunning a few days ago were now completely obscured by the haze and sand of midday. He had left him with the desire to repeat the walk at sunset. As he hiked down, he found some fossilized shells left over from when the area was also part of the Mediterranean. Dinner that night was back to the normal silent eating. Ben missed hearing people share stories at dinner, but that was only allowed once a week on Shabbat and could wait until later that night.

Later that week, Ben went on a walk with Austin to go check out the nearby tanks. They walked towards the noise for fifteen minutes, and popped up over a hill, which unbeknownst to them was being used as a berm. They saw 8 tanks pointing directly at them, "op! There are the tanks" Austin said as they booked it back towards the safety of the olive grove. On the walk back, Carly called to ask about their whereabouts. Austin made sure to answer with video share. "We're on our way back" they said, panning the camera over the desert, before returning it to their grinning faces, proud of the hijinks they had gotten into. Ben loved getting into trouble with friends like that.



As the weather turned warmer, Ben found his mornings to be less stressful. It was the first morning all trip that his hands didn't go numb while working. He wondered how much of enjoying experiences has to do with the ability to relax, or selectively focus on the positive rather than get bogged down by the negative. He was unsure of whether he was more relaxed because the morning was easier, or the morning was easier because he was more relaxed, but either way he smiled as he scrubbed the floor of the dining hall with a broom. That Night, at sunset Ben climbed the hill Yoram had shown him weeks earlier. This time it felt different. He saw no one else and did it because he was compelled to by an internal force rather than an external one. It was beautiful to get a panoramic view, and he could see both the sun, and the light painted on the cliffs to the east.

That weekend, Ben embarked on a two-day trip to Ein Gedi, Masada, and the Dead Sea with the rest of his classmates. It was a jam packed two-and-a-half-day trip, and the first time he had left Neot Semadar so far. He knew he was only gone for a couple weeks, but it felt like years. Dinner with the people living at Ketura reminded him of what he was used to before Neot Semadar. He sat on a bench outside his room to try to escape the mishigas, and the past few weeks came into focus. At the meeting with Yoram the idea of intention was brought up. If you want it to work and trust that it will, your mind will do everything needed to accomplish it. That cuts out a lot of the noise and self-doubt that can plague one's mind. Another common theme has been appreciating the moment. He remembered sitting in the carpentry shop in front of a fire made in an old hot water heater sipping coffee with a veteran member. Neither of them talked for minutes. It wasn't awkward silence, but rather a peaceful moment filled only by the smell of wood smoke, and the soft crackle of a campfire. This idealization of living in the moment when taken into consideration along with the fact that everyone has difficulties describing what it is like reminded Ben of flow state. Flow is when your mind operates outside of conscious thought, and your body takes over, and everything just works. Subtleties like this are often very difficult to articulate, because most of the experience exists outside of language. The lack of definition also helps because flow is elusive through conscious thought. If your mind

was like a turbulent river, damming it would only work so long before it all came crashing down. You need to slowly drain the water away.

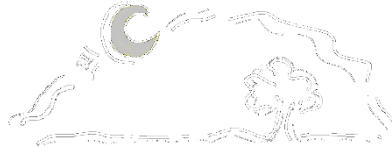

Chapter 14: Filling in the Past

As Ben wound through the brick paths of Neot Semadar on the luggage holder of an old mountain bike, Daniel manning the helm, he felt a strong pang of nostalgia, not for any childhood memory, but rather from the lack thereof. In fact, he distinctly remembered missing that experience. In fifth grade, one of his classmates had gotten a new bicycle with standing pegs on the rear wheels and was giving out rides around the parking lot, Ben wished he had been one of the people to be part of that but remembered backing out from fear of falling off. Growing up with situational anxiety has always been an issue. Normal things like getting a driver's license at sixteen or riding a bike to a friend's house had all sailed and lived only in imagination as what they could have been if they were to have happened. Neot Semadar provided a good place to fill those gaps, continuing a journey that only began a few months prior. Then, he was miles from cell service, on the side of a boulder existing entirely in the bubble of light provided by his headlamp. It was a new experience for him. He wasn't used to the solitude, or the need to trust his own judgement. Until then, he relied heavily on others to guide his decisions, but there were none there to do that for him now. This trip affirmed for him that he could do things and trust his own judgement. As he continued to the scrapyard, he saw abandoned buildings towards the back. After a couple hours of exploring those and climbing and jumping around on top of scrap piles, he discovered an old mountain bike frame and decided to fix it up. It's the little things like these that made his time at Neot Semadar special to Ben.



Earlier that week, Austin was headed to a special Tu B'shvat meeting at the lake. It was scheduled by the community and open to all, but no specific information was provided. Ben, having nothing else to do, decided to tag along completely unsure of what to expect. It was warm in the sun, pretty nice weather for mid-January, especially given that everything was covered in snow back home. After a short picnic snack of dates and tea, he was thrown into a fascinating event. The language barrier was a plus, because it didn't give him time to process and back out of whatever was about to happen. A circle formed, and after some exposition in Hebrew one person ran into the circle, shouted and pointed to someone, ran back to their spot, then that person did the same. This continued as a cycle for a bit before it transitioned to pointing to two people which quickly became pandemonium as half of the circle was running pointing and shouting at once. On the walk back, Ben couldn't help but smile. Activities like that where one can let fear of judgement go and just do things were difficult, but also freeing. The next day, he had a similar experience. After volunteering to clean up from a picnic breakfast, he joined an activity where he was told to do whatever motion our body asks for, which is clever because it interrupts any learned, "don't do that, that's stupid" reaction, and allows your true self to show through, something difficult for him.



Just after sunrise Ben was sprinting after a 30-foot-long flatbed trailer full of mulch arms wildly swinging with a pickaxe in one hand and a jacket in the other. He was working as a part of the garden team and was covering freshly planted trees with mulch. The tractor stopped and he jumped on, taking a seat towards the front. He smiled as he felt the cool breeze of the lake. He suddenly felt a little sheepish for being this giddy about riding a tractor. It was awfully childish wasn't it? Whatever,

he thought, it was still fun. Part of what he enjoyed about the other volunteers was the lack of judgement for things like this. Not only did they not scoff at his jumping on the tractor, they joined in. As the tractor pulled in behind the dining hall, he jumped off hungry and ready for a bowl of oatmeal piled high with dates coconut and apricot jam. Where else could he have a morning like this? That night, Daniel finished fixing the BMX bike he was working on and to celebrate, they decided to go out for a joyride. They played a game of follow me, chasing each other all over the kibbutz, weaving between houses, taking laps through the art center garden, over bridges, slaloming through trellises, and riding over the compacted dirt hills that lay just outside the main residential section. When they swapped, Ben had fun letting his mind drift, exploring new areas with no real destination planned. The ambiguous shapes of trees and houses flew by before disintegrating into his peripheral vision as he coasted down the hill from the school to the dining hall before making the sharp turn towards home, intentionally skidding out the back of the bike. It was a good night, he didn't overthink anything, and he just enjoyed the moment.



As Ben watched the mountains of Jordan from the window of a bus to Eilat, he was ecstatic. He had just turned 21, his roommates put on an awesome mini celebration the night before, and he was going to spend a weekend at the Red Sea. After arrival, he embraced all of the freedom he could for the first time in weeks, grabbing a steak and cocktail by the beach. Later that night he went bowling with some of his friends who were staying at Ketura. He hadn't seen them in weeks, and it was nice to catch up. It was probably the lowest scoring game he ever bowled, but it wasn't about that. It was fun to be spending time with his friends. Still used to agricultural hours, he was exhausted by 9:30 and headed back to the hostel.

The next morning, Ben awoke at 7am, well before his alarm, and everyone else. The sun had just risen, and the last chills of night were swept away and replaced by warm tropical air. He sat on the beach and watched the end of sunrise as he waited for the nearby Aroma coffee to open. It was peaceful. He was the only one there for the moment, a bizarre feeling given that and the beach would be packed with tourists later that morning. He got up, got coffee, and went for a walk along the beach. After returning, he met up with everyone and signed up for an "I know nothing" scuba diving experience. The first five minutes were amazing, but divers panic set in soon after. Deep breath? Not enough air. As the ocean turned darker and closed in around him, he tried to get his breathing back under control but couldn't. He surfaced, taking a full breath as he spit the regulator out and felt a knife twist in his chest. How could he have failed so catastrophically? He hadn't had to face something like this in a long time. He was a climber, adventure sports were his thing, or maybe not. The rest of that day was a blur, his mind was in another place. As he sat on the beach that night and watched the waves roll in, he was angered by the hand he had been dealt, just as everything felt like it was falling into place, he got a sharp reminder that it hadn't. Life has a funny way of keeping your ego in check.

He took the bus back the next day, and when he returned, he went on a walk out into the desert to try to clear his head, but everything felt stale. He missed the feeling of watching the sunset the first time he went out alone. The light on the cliffs were still reminiscent of a renaissance painting. But now with that novelty gone, it no longer felt special. With nowhere new to explore, and no new experiences left, he felt like a goldfish that is stuck in the same bowl all its life. He watched the horizon turn a dark red as the IDF tanks kicked up dust below and began to wonder if he could relax and enjoy the moment. He was living in a community focused on relaxing your mind to better your experience and be comfortable anywhere, but his recent experience had raised huge doubts of whether this would ever be possible. As he started to walk home, he jumped off a boulder and onto the steep side of the mesa which dislodged from under him. Small rocks and dust kicked up around him as his bald sneakers struggled for traction, but he didn't need to think to keep his balance, he just did it. As he skated down the side, he let out a laugh for the first time in days. Maybe it was possible.

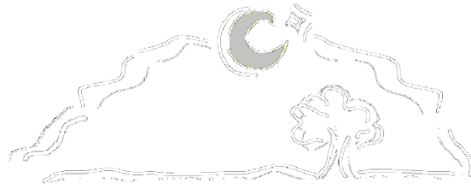

Chapter 15: Trust!! Autopilot

Movie Night. Ben had moved on but not fully recovered from this past weekend's events. He took a night to refocus, deciding to watch *Free Solo*, a movie about rock climber Alex Honnold's rope-less ascent of El Capitan, a life threatening and incredibly physically difficult achievement. It's about "an Olympic-gold-medal-level athletic achievement that if you don't get that gold medal, you're going to die." For the most difficult section he outlined his plan, "Trust, double underline exclamation point exclamation point period. Autopilot". This line stuck out to Ben. Autopilot negates the typical anxiety death spiral where one becomes anxious for the sole reason one is anxious. Synonymous to flow state, it is about letting everything happen naturally and trusting yourself. After seeing the movie Ben knew what he needed to do. He was going back to Eilat tomorrow. He finished his morning work, packed a bag, and boarded a bus south.

When Ben arrived, the waves were choppy and clouds periodically blocked out the sun, not like the still calmness of last time. He met his guide who was posted on a wall in a bath robe smoking a cigarette and geared up. Ben wished he could display that same easy confidence. As he walked into the water, dread began to materialize. Last time he failed miserably, not only was there chance of failure this time, there was chance of validating his previous failure. As he put his fins on, and fully submerged in the crystal-clear water of the Red Sea he had a moment of nervousness but then autopilot. Breathing was easy, and the new underwater world came to life. It was calm below the surface, and there was no evidence of the waves above. He watched as colorful tropical fish swam by, a stonefish lay quietly on the bottom, and a bottom feeder picked at the sand. Ben was elated by the fact that not only was he able to be underwater, he was able to be calm and enjoy it. He surfaced half an hour later and was hit by a big wave, instinctively he took a breath, because breathing underwater was something he could do now. Forgetting he took his regulator out he spit out a big gulp of water. He laughed realizing his mistake. As he walked to shore, he began shivering, he was having so much fun he didn't realize how cold he was. That night as he enjoyed watching the waves crash on the shore, he celebrated his success with a lamb kebab. He was also met with an interesting question. Mentally programmed to overthink everything, it was unnatural to just sit back and trust himself, yet it seemed to work well. That was a question for a later date. Right now, he just wanted to enjoy his food.



The next morning, he was up well before his alarm again, ready to work in the fields, but as the light and sound of waves permeated the open window of the hostel, he had a bus to catch. Ben was meeting some friends in Timna Park later that morning. He packed his bag and hailed a cab for the central bus station. With an hour before his bus left, he went out in search of coffee. It was only his second time in Eilat, but the small city had already become familiar. He walked two blocks up the street to get coffee from Mifgash Ha'Sheik. As he entered, the smell of fresh baked pastries filled the air. The crowds had not yet woken up, and the bakers were finishing pulling the day's wares from the oven. Two espresso shots later, he was ready for the day ahead. Ben enjoyed solo travel for the challenge of figuring things out for himself. He still loved company on trips, and wouldn't give up traveling with others, but it felt good to prove he could function independently. As he boarded the bus, he had a soundtrack planned. He stared out the window at the same mountains as a week earlier, and the lyric he was waiting for came up: "so understand, don't waste your time searching for those wasted years, and realize your living in the golden years". You can either worry about the past and feel like you have missed out, or you can make the best of your current moment. That's what this weekend was about. The bus stopped at Timna Elifaz and Ben got off ready to rejoin his friends. He was brimming with excitement as they arrived, energized by the previous day. He hugged Austin and bantered with Evan about coffee.

He felt like himself again, and his step resumed its characteristic bound as he explored the historic copper mine. This time, exploring a new area brought all the excitement and wonder it usually did for him. Along the way the group decided to take a photo in a rock archway. The narrow space wasn't enough for everyone, so Ben climbed up the side to make room. It felt good to touch real rock again, he had to stop himself from climbing higher after he found himself on a ledge ten feet off the ground. "Autopilot" he mused.



When he returned to Neot Semadar he felt the blissful combination of exhaustion intermixed with the pride of accomplishment for the first time in ages. He felt capable after taking ownership over a task and seeing it through to a successful end. He didn't need anyone to reaffirm it for him, no Instagram post needed. Ben was used to the emotional exhaustion from Neot Semadar, but physical exhaustion and the sense of accomplishment had become forgotten pleasures. He was grateful to have the experiences like the Tu B'shvat event where he could let fear of judgement go, and concepts like intention had served as a new and useful ways to think about things. His experiences had helped him improve at getting out of his own head, but by the end of this weekend, he was ready to take what he learned home. Rock Climbing had always given him a sense of fulfillment unlike anything else, and he was grateful for the small reminder of that, but he needed more. Learning what he did at Neot Semadar made him excited for his next adventure whatever it may be.



PART FIVE: Short Tales of a Red Head and a Desert

Austin's Story





Chapter 16: A Pumpkin Tale

My eyes open to the sound of the morning alarm as I start to remember where I am, who I am. I find the snooze button on my phone. Some mornings my mind is not back drivable – a quality of a system that allows extrinsic motivation to act upon it. My eyes close.

The alarm is ringing again. I open my eyes and sit up in bed. Today the alarm has won. I pull the orange duvet cover off my body and get dressed. As I slip into my crimson WPI t-shirt and jeans, I start to walk to the early morning meeting. The lowly lit and flickering lights guide me to the dining hall in the coolness of the morning. I find my seat slowly as I watch the others in their seats with tea or coffee in hand, meditating in silence. After an eternity of sitting in quiet, I find myself falling asleep again in my chair. There is a struggle fighting the outward pull to be present and functioning this early in the morning. As the day began and the world moved in motion once again, I awake once to the sunrise dancing on my face and I head to the kitchen to start working.

I am handed half of a large pumpkin that needs to be chopped into cubes. Using a large knife that probably does not belong in a kitchen, I get to work at this seemingly monotonous task. The knife is about sixteen inches long with a curved tip, making it difficult to do such a simple task. I push the knife into the top of the pumpkin all the way through. Then like a lever, I push the knife down. The knife is dull, and I can hear the pumpkin ripping into pieces as I cut.

One half of a pumpkin, twenty slices, and approximately two hundred cubes later, the pumpkin is gone and in its place is a bowl of chopped remains. I bring my tools to the sink to wash. The cutting board, like a scared battlefield, is washed and there is no trace of what just happened on its surface. Same with the knives and my hands.

And just as if no time had passed, it was breakfast time. It was the same delicious meal as usual—a tray of vegetables, freshly baked bread, jams, oatmeal, and organic goat cheese. Having a break from chopping pumpkins is relaxing. After I am finished eating my oatmeal mixed with the perfect ratio of cinnamon and sugar, the morning meeting occurs and then I return to the kitchen.

Once I step into the room in which I spent my whole morning, I find yet another pumpkin sitting in place of the bowl I had left there before. As expected, I am asked to chop this pumpkin into cubes as well. I get the same large dull knife with the curved tip, the short and serrated knife, a clean cutting board, and get to work. Five pumpkins, four hundred slices, and thousands of pieces later, the pumpkins are gone, leaving in their place only small pieces of what once was. I am bored and tired of pumpkins by the end of the day.

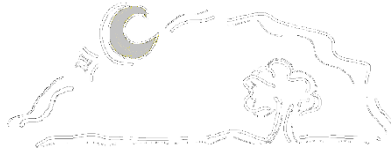

Chapter 17: Me'laf 'fone and Music

I wake up in this morning with a new-found energy. Jumping out of bed, I rapidly put on my cotton waffle shirt, blue jeans, and waterproof work boots. I brush my teeth at a rapid pace and walk out the door to head into the dining hall—a normal routine at this stage of my journey at Neot Semadar. After waiting outside for a minute for the morning quiet time to end, I enter and sit in the circle of chairs, waiting for the people working in the kitchen.

The day begins and we go through the usual motions of the morning. First a name circle: “Mor, Amir, Carly, Austin, Neta, Iris...”. There is a moment of silence for everyone to process each other’s names and then an explanation of how the kitchen/dining room/vegetable garden group functions and is organized. “We are a group that is made up of three groups. One group will be in the kitchen preparing food. Another will be in the dining room cleaning the floor and setting the tables. And the last group will be in the vegetable garden collecting fresh veggies for the morning breakfast.” I offer to work in the kitchen because it is my favorite place to work of the three. I drink a glass of water and then proceed to the kitchen— my home away from home.

Once standing around the island countertop, I receive my first task for the morning. I need to use the food processor, with the “chipsor” and “knife one” inserts, to chop onions. I start out by setting up my station, then checking the processor for damage and inserting the attachments to make sure they are secure. Then I am off to the fridge to see how many onions we had that needed chopping. I find two white, twenty-five-liter buckets filled with peeled onions.

My mind starts to wander as I start to get into a rhythm while working and I begin singing my “musical playlist” to myself. My whole life I have always found music to fill me with joy. It is one of the few things that I have been able to bring with me from home to Neot Semadar; a comfort that I have come to use often as the days seem to run together. After I have sung through a few songs, I am really beginning to be in a rhythm with my morning work. Eventually, I invite others in the kitchen to join in my fun, bringing my inner tunes outward as I sing at full volume. It is very rare to have entertainment at Neot Semadar outside of the song before Shabbat. I am not sure why there is this standard of being completely silent and not connecting through things other than work. Despite this, I get a couple of the women I am working with that morning to sing along different songs we all know as we continue to work. This is the happiest I have felt while working here, and at the same time I was bringing joy to everyone else’s day.



PART SIX: Epilogue

What have we learned, what challenges did we face, how we are changed?

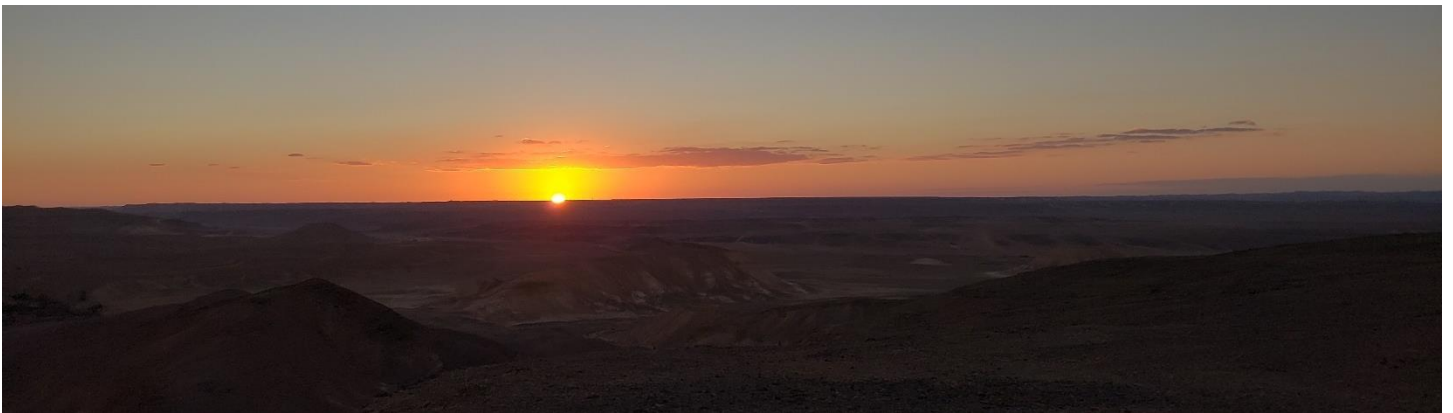

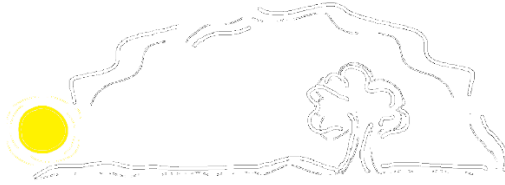

Our IQP Experience at Neot Semadar

Neot Semadar, an experiment into understanding human relationships, was established in the arid Negev desert with the goal of creating a better form of community. The beautiful desert oasis was grown from the sand, requiring not only enormous efforts, but intelligent design and the willingness to learn. Each one of the thousands of trees inhabiting the kibbutz were planted by hand and watered daily. Those who find their way to this desert oasis seek refuge from the harsh world and seek solace in the traditions and culture that emanate from all subsets of the kibbutz. The experiment being conducted is multifaceted, not only is it important to those who practice, but it is a testing ground for theories that could have wide ranging applications. In a country marred by strife, a community exploring and experimenting with human relationships provides hope in an overwhelmingly pessimistic world.

This unique environment focused on self-reflection forced us to challenge our beliefs and explore relationships and emotions in ways we had not before. Each individual was confronted with obstacles that were difficult to overcome but built character and resilience through challenging our pre-existing views. Working within the tight confines of our apartment and within a tight community, it tested each member's ability to work as a group, initially pushing us apart, but eventually bringing us together closer than when we began. In times of great stress, there were no comforts from home to lean on within a community that prides itself on resisting conventional modern influences. Each challenge had to be attacked face on, which for some was uncomfortable. The goal of WPI's IQP program is to put students out of their comfort zone, to challenge them in ways they have not been before, and through that process, grow them into engineers and better people. In that sense, Neot Semadar succeeded in a spectacular way. Not only was it an exercise in human relationships, but it was an exercise in the relationship with one's self. We are coming out of this experience more comfortable with who we are, and more prepared to take on life's challenges that will surly arise.

As we reflect upon our experience at Neot Semadar, it is important to look at how much of this journey was fabricated by the environment in which we lived and what is to be expected within a normal IQP experience.



Our school, WPI, prides itself in exposing its students to difficult academic and social challenges that ultimately allow for the students to thrive. With seven-week terms, the ability to overload and ample extracurriculars gives no limit to the level of achievement that can be reached, and it is up to the student to see how hard they want to push themselves. IQP abroad is found to be no exception—it requires students to complete a project in an unfamiliar culture with far fewer resources and technologies available. The Israel center provides an interesting parallel to WPI in that Israelis are famous for their ability to improvise and make extemporaneous decisions—a useful skill at WPI.

Neot Semadar is a small community located in an isolated parcel of land in the Negev where we had far less access to resources, which required a unique approach to problem solving. The community embodied a very distinct culture, and access to the outside world was reduced from what many of us were used to. This placed a lot of stress on the whole group in addition to the normal stresses of a high-immersion project. A lot of the challenges stemmed from trying to determine how to become a member of the community whilst juggling our project work, seemingly two incongruous tasks. Learning to trust that we would eventually figure things out in the end proved to be helpful in an experience like this.

This specific experience at Neot Semadar improved our skills at working while lacking the resources of home, both tangible, some of the more intangible. Overall, this IQP has improved our ability to function in a stressful and unfamiliar environment, whilst also “creating an awareness of the ethical dimensions of our project work” and “maintaining effective

working relationships within the project team and with the project advisors, recognizing and resolving problems that may arise.”



There is a component to IQP that is not mentioned in the learning outcomes is this entirely other aspect of interacting with the foreign world and how that influenced our lives as well as our education and success with the project. We found that in engaging with the community at Neot Semadar that it was difficult to come to a consensus on what was considered a priority, how to interface with technology, and how to interact as equal parts within a culture that promoted gender stereotypes. What we came to Israel with were the pretenses by which we were raised, and as an international student and engineer there are many challenges trying to communicate over language and generational barriers. Through this seven-week adventure of navigating the ever-changing project and the cultural clashing of fast-paced, high-tech engineering world to the slow, intentional, no electronics world of Neot Semadar, we gained experience and learned the intangibles of what it takes to truly pull yourself out of your cultural comfort zone and collaborate with the outside world.

The global component to engineering is growing rapidly as the world continues to integrate the uses of technology and global communication. The likelihood of us as engineers collaborating with buyers, sponsors, and other engineers from around the world is quite high, therefore, it is very important and integral to the future of engineering to have a broad sense of international culture. William Wolf, former vice president of Ford Motor Company, stated that in the future, “understanding other cultures, speaking other languages, and communicating with people from marketing and finance will be just as fundamental to the practice of engineering as physics and calculus.”¹

The access that IQPs give students in interfacing with the international world is an unexplainable advantage that allows for WPI students to have exposure to this type of experience. We were able to experience this first hand with the community of Neot Semadar and developed a connection with our sponsor through attempting to reach mutual understandings of each other’s background and cultural upbringings. Though it took several weeks to begin the true acclimation process, much was gained from living in an Israeli community for seven weeks, including a wider perspective on humanity.

ASSEMBLY OF SENSORS

The following section is used to show how to adequately assemble and electrically wire each component for the temperature and current reading sensors. Schematics are included, and code needed to program each microcontroller is listed in each section as to where it can be found in the Appendix.

Temperature Sensors

The implemented temperature-monitoring instrument follows two key requirements: firstly, the device must be able to measure temperature at multiple nodes, at least 3m apart, and secondly, be constructed in a modular fashion such that the apparatus can be modified before and after our departure. In creating a device that fulfills these requirements, the Arduino platform is used as it provides the largest library support allowing easy expansion, in addition to ease of use for kibbutz members upgrading the device in the future. The following are the components chosen for the main measuring system of the temperature sensor:

- Adafruit Pro Trinket 3V microcontroller
- 8GB microSD Card
- Sparkfun Level Shifting microSD Breakout
- DS3231 Real Time Clock (RTC)
- 18650 Lithium Battery

The Adafruit Pro Trinket 3V microcontroller provides a respectable balance of price, size, power consumption and reliability (Amtel, 2012). The data is stored on an 8GB micro SD card which interfaces with the Sparkfun Level Shifting microSD breakout (Wilkins, 2016). Using the SD card allows for an easy transfer of data from sensor to computer where the data can be processed and stored long-term. Time stamps are crucial for the experiment, so a DS3231 RTC communicating over an I²C interface supplies accurate time and date to the microcontroller (DS3231 Data Sheet, 2015). To power the assembly, an 18650 Lithium battery is used as it provides the appropriate voltage and 2500maH is enough to power the device for months on end. Follow the schematic found in Figure 1 on how to assemble this part of the measuring device. The code to program these sensors can be found in Appendix A. 14-gauge stranded wire is used to connect each individual component and assemble the device.

MAX31820 digital local temperature sensors with $\pm 0.5^{\circ}\text{C}$ accuracy from $+10^{\circ}\text{C}$ to $+45^{\circ}\text{C}$ with each reading having 12-bit precision are used to collect the temperature data (MAX31820 Data Sheet, 2013). Each sensor utilizes a one wire

data/power transfer protocol also called microLAN. Though more expensive than thermistors, these sensors provide precise readings independent of their distance from the ADC. In addition to temperature readings, the temperature sensor device will have the capability to measure humidity using the DHT11 Basic Temperature and Humidity Sensor. It uses a capacitive

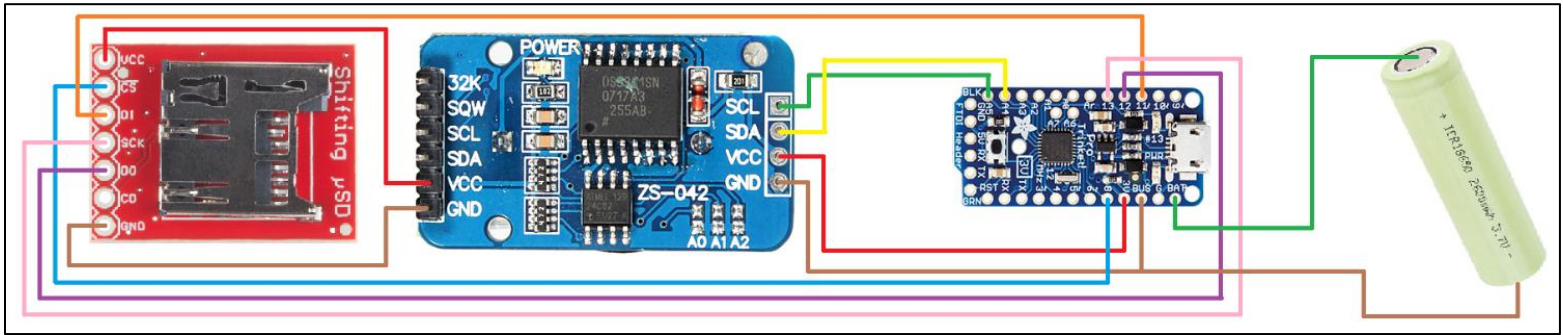

Figure 1: This schematic consists of (from right to left) the 18650 Lithium Battery, Adafruit Pro Trinket 3V Microcontroller, DS3231 Real Time Clock, and the Sparkfun Level Shifting microSD Breakout. These components are shown to be connected by wires and solder

The temperature sensors communicate to the microcontroller over a one-wire protocol. When connecting the sensors to the main measuring system, two pins are used for ground and a data line. The data line is connected to a digital GPIO pin and pulled up using 5K resistor. In the assembly, the main measuring system and the temperature readers will be attached to a carved out 2-by-2 piece of plywood that is cut at varying lengths depending upon the height of the ceiling in the home being measured. The brain will be placed in the middle of the apparatus with the sensors running from the top to the bottom. Each sensor unit is comprised of seven individual temperature sensors with locations and numbers denoted in Figure 2. There are two sensors located 20 cm above the floor and below the ceiling, followed by a sensor located at 180 cm which is average head height. Then there are two sensors located 20cm from the bottom and top that are used to measure floor and ceiling temperature. Lastly, there is a sensor located at 180 cm used to measure wet bulb humidity and another that is a meter away from the apparatus used to measure wall temperature.

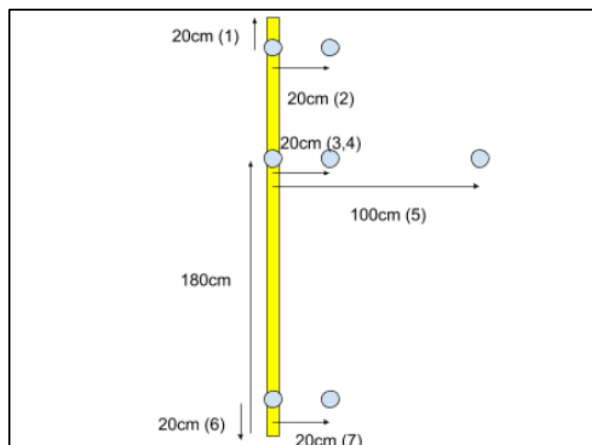

Figure 2: Relative locations of the temperature sensors along the overall structure of the measuring apparatus. The sensors are denoted as blue circles.

Current Sensors

The main measuring system of this sensor is identical to the temperature sensor, comprising of an Adafruit Pro Trinket 3V microcontroller, an 8GB micro SD card which interfaces with the Sparkfun Level Shifting microSD breakout, and the DS3231 RTC. Use the code found in Appendix B in order to program the sensor for accruing current data. To assemble the brain, follow the schematic shown in Figure 1. The current reader consists of one main measuring system and six current readers. The following are the components chosen for each current reader:

- YHDCSCT013 Non-Contact Current Sensor
- (2) 144K Ω Resistor
- 84 Ω Resistor

The YHDCSCT013 Non-Contact Current Sensor is used to receive the current readings from each individual power wire within the central current units. These sensors are non-invasive, current transformers that measure the intensity of a current that crosses a conductor without needing to cut or modify the conductor itself (Non-Invasive Sensor, 2018). Each current reader must be connected to a voltage divider using 144K Ω resistors in series connected to power and ground, as well as an 84 Ω resistor that connects from the reader to the analog input on the microcontroller. Once the brain is assembled, Figure 3 illustrates how to add on each of the current readers with the voltage divider. The figure shows an example using only three current readers, but there is one variation where there are six current readers in total, connecting to the microcontroller at the same power and ground, as well as analog inputs A0-A3 and A6-A7.

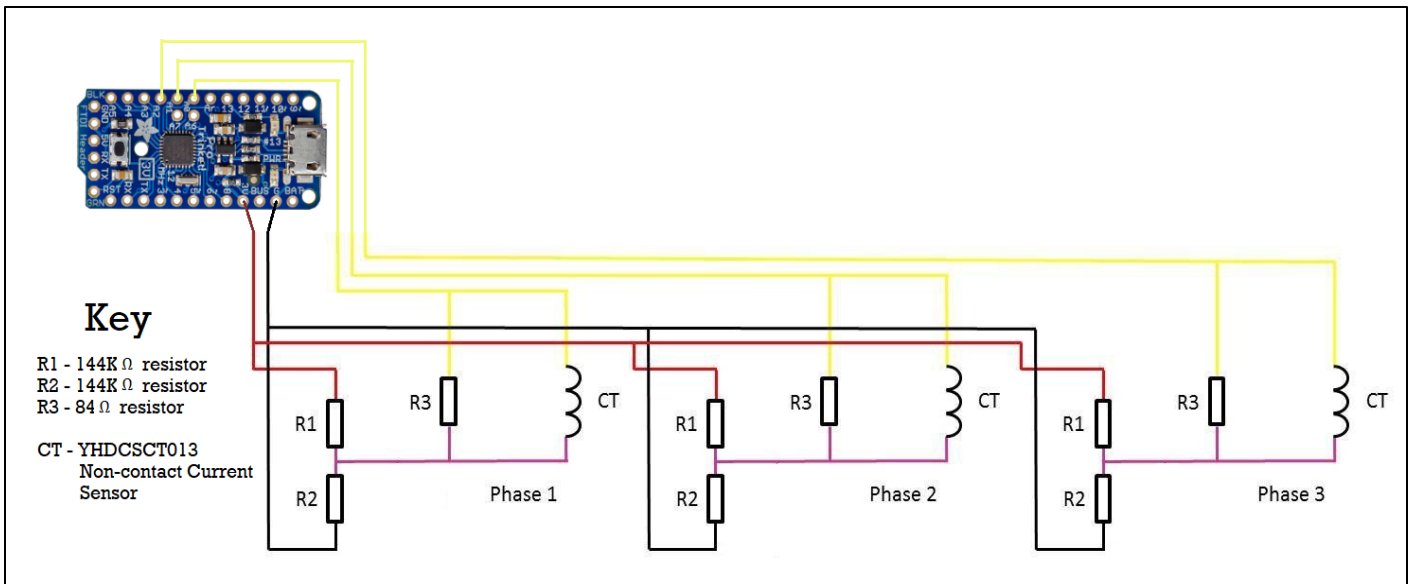

Figure 3: This schematic shows the connections between the microcontroller and the YHDCSCT013 Current Readers. Refer to the key for specifics about the schematic. This schematic is to be used in addition to the schematic found in Figure 1.

Once all the connections are completed within the system, the main measuring system of the sensor will be placed within a control box for external protection from the environmental elements. Access to this brain will be important for data extraction, so the top part of the control box will be removable and secured in place by screws. On either end of the box, there are slots to allow for the current readers to extrude and attached to the wires within the central current unit. These sensors and control boxes are intended to be permanent, so the electrical components will be glued inside of the box, which will be securely placed within the central current unit.

Figure 3: This schematic shows the connections between the microcontroller and the YHDCSCT013 Current Readers. Refer to the key for specifics about the schematic. This schematic is to be used in addition to the schematic found in Figure 1.

come half-charged out of the package at a charge of about 3.5 volts. It is preferable for the batteries to be charged above 4 volts to ensure optimal operation of the current and temperature sensors. In order to charge the battery, remove it from the apparatus by pushing gently on the bottom side of the battery holster. Connect it to the charging device, aligning the positive and negative ends of the battery into the proper location on the charger. The charger has an LED light that glows red when charging and lights up green when the charge is complete. To check the exact charge of the battery, use a voltmeter by placing the two connective ends of the voltmeter to the positive and negative ends of the battery respectively. The instrument should read a voltage around or above 4 volts before reinstalling into the sensor apparatus.

Reference for Resistor Color Codes

Resistors are available in a range of different resistance values from fractions of an Ohm (Ω) to millions of Ohms, so it is important to be able to determine how much resistance is contained within a resistor. Small resistors use colored-painted bands to indicate both their resistive value and their tolerance with the physical size of the resistor indicating its wattage rating. These colored painted bands produce a system of identification generally known as a Resistors Color Code denoted in Figure 4. The proper way to read the resistor color code markings is by reading one band at a time starting from left to right, with the larger width band, representing the tolerance of the resistor, on the right side.

The code follows an equation of Number, Number, Multiplier and Tolerance. For example, in Figure 4, the 4-band-code resistor used has a color code of green, blue, yellow, and gold. The way to determine its resistance is correlating the green color to be equal to 5, blue is equal to 6, yellow is equal to 10K Ω , and gold is equal to $\pm 5\%$ tolerance. To put that equation together, the resistance is equal to $56 * 10K \Omega$, or $560K \Omega$ with a tolerance of $\pm 5\%$.

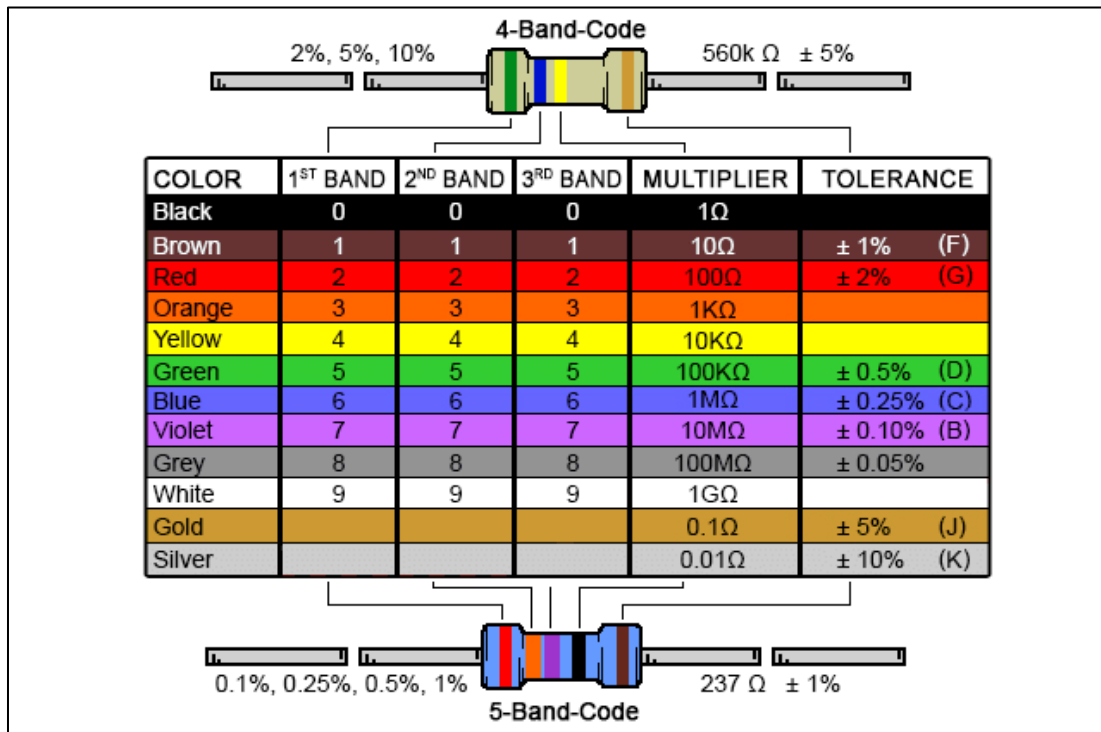

Figure 4: This shows the code in which to determine the resistance capabilities of a resistor. Read the resistor colors from left to right and use the code to determine its value.

The 5-band-code resistor reads colors of red, orange, purple, black and brown. Five band resistors follow the code of Number, Number, Number, Multiplier and Tolerance. So, in the example of the blue resistor from Figure 4, the resistance would be $237 * 1 \Omega$, or 237Ω with a tolerance of $\pm 1\%$.

INSTALLATION OF SENSORS

To install the **temperature sensor** in a home, the room must be measured from floor to ceiling and recorded. Take this measurement and acquire a 2-by-2 piece of plywood equal in length to the height of the room being measured. Place the main measuring system in the middle of the wood and run the temperature readers through the rest of the apparatus, leaving the floor, wall and ceiling temperature sensor to be outside of the wooden piece.

Once the sensor is in the home, place it in the location of choice near the wall selected for analysis. To ensure safety of the residents of the home, chose a location in the room that is least likely to experience high foot traffic. Slide the bottom side of the sensor along the floor and have a second person aid in the installment to ensure that the structure is sitting upright parallel to the wall. Once the desired position is acquired, take small pieces of wood and wedge them underneath the apparatus to create tension between the sensor and the floor / ceiling. Continue to place pieces of wood until the sensor can stand freely and safely on its own.

When the apparatus is secured, obtain three 3 cm-by-3 cm pieces of insulation and tape. These will be used to cover the floor, wall, and ceiling temperature readers to isolate the readings from the ambient air temperature in the house. Take the temperature reader and place it in the desired location and cover with the insulation pad. Tape the pad on all four sides to ensure a tight seal around the edges of the insulation. Repeat this for all three temperature readers for floor, ceiling, and wall. Once all readers are in place and the sensor is secured, insert the battery into the battery holster. Two sets of lights should come one, one from the microcontroller and the other from the RTC. If both lights are on, the apparatus can operate with no electrical problems. Be sure to place an SD card in the microSD holster before beginning the experiment to be able to collect the data.

To install the **current sensor**, first determine which central current unit the observed house uses, and which power lines correspond to that house. Before installing the device, make sure that the SD card is inserted in the microSD holder and the battery is in the battery holster. The brain for the temperature and current sensors is the same, therefore, the same system to determine if the device is operating correctly from an electrical stand point is the same—if there are two lights on, one for the microcontroller and the other for the RTC, then the device is operational. Once you select the correct power lines, connect the current sensors by opening the blue component of the current reader and clasping it around the line. Allow for the current sensor box to remain in the central current unit. Collect data by removing the SD card and following the procedure found in the next section.

DATA COLLECTION AND ANALYSIS

With the use of the graphical software, the data collected from the microSD card can be organized and sorted into a graphical representation for analytical purposes. The following sections contain step-by-step guides as how to extract data, plot the data on interactive graphs, and utilizing the heat map overlay with the psychrometric chart.

How to Extract the Data

1. Remove the SD card from the microSD card holder in the sensor apparatus
2. Obtain a USB-to-SD card reader and place the SD card into the reader
3. Plug the reader into computer of choice
4. Open the Graphical Software provided by the WPI IQP project group
5. Press the “open” or “create database” button to select where to store the data
6. Select “import”
7. Select file on the SD card that you wish to save to the database
8. Enter location of where the SD card came from and which sensor it corresponds to
9. Delete file from SD card
10. Replace into the apparatus to start recording again

** Please be aware that to access the data within the database, an expert in computer programming should be the only individual to have permission to handle the code for the database. This is to ensure that the database stays functioning and works properly, as well as eliminates the risk of tampering with the advanced code and breaking the system. **

How to Plot Data on Interactive Graph

1. Open the database and select generate graph
2. Give the graph a title in the title box
3. Click “add custom”
4. Give the trace a name
5. Choose the trace location and measurement, if you want to filter the data, and what type of data
6. Press OK
7. Select the date range for the set of data, press generate

How to Create Heat Map on Psychrometric Chart

1. Open the database and select psychrometric heat map
2. Choose the location, the temperature, and the humidity data

3. Select the date range, press generate

RESULTS

The outcome of the assembly of these sensors will allow for a full thermal analysis to be completed in any house at any time of the year. To adjust the temperature sensors for each home, the height of the room should be measured from floor to ceiling, leaving a small gap in order to perform the securing procedure as outlined in the installment section of this manual.

By placing both the current data and the temperature data on the same graph, it is possible to compare the thermal conservation and behaviors of the house in correlation to energy consumption that is directly related to heating. The second concept of this analysis comes from the idea of thermal comfort as perceived by the inhabitants, and how to quantitatively display that with the data collected. The figures shown in this section are examples of the types of graphs that can be generated as part of the graphical software provided.

In Figure 5 below, the general graphs of how the data from the temperature sensor can be displayed, verses in Figure 6 where the current data is displayed. The images found in Figures 5 and 6 are screen shots taken from the interactive graph generated by the Graphical Software. For reference, the graphs in Figures 5 and 6 models a high thermal mass home recorded over five days. To compare the temperature data and the current data on the same graph, follow the steps

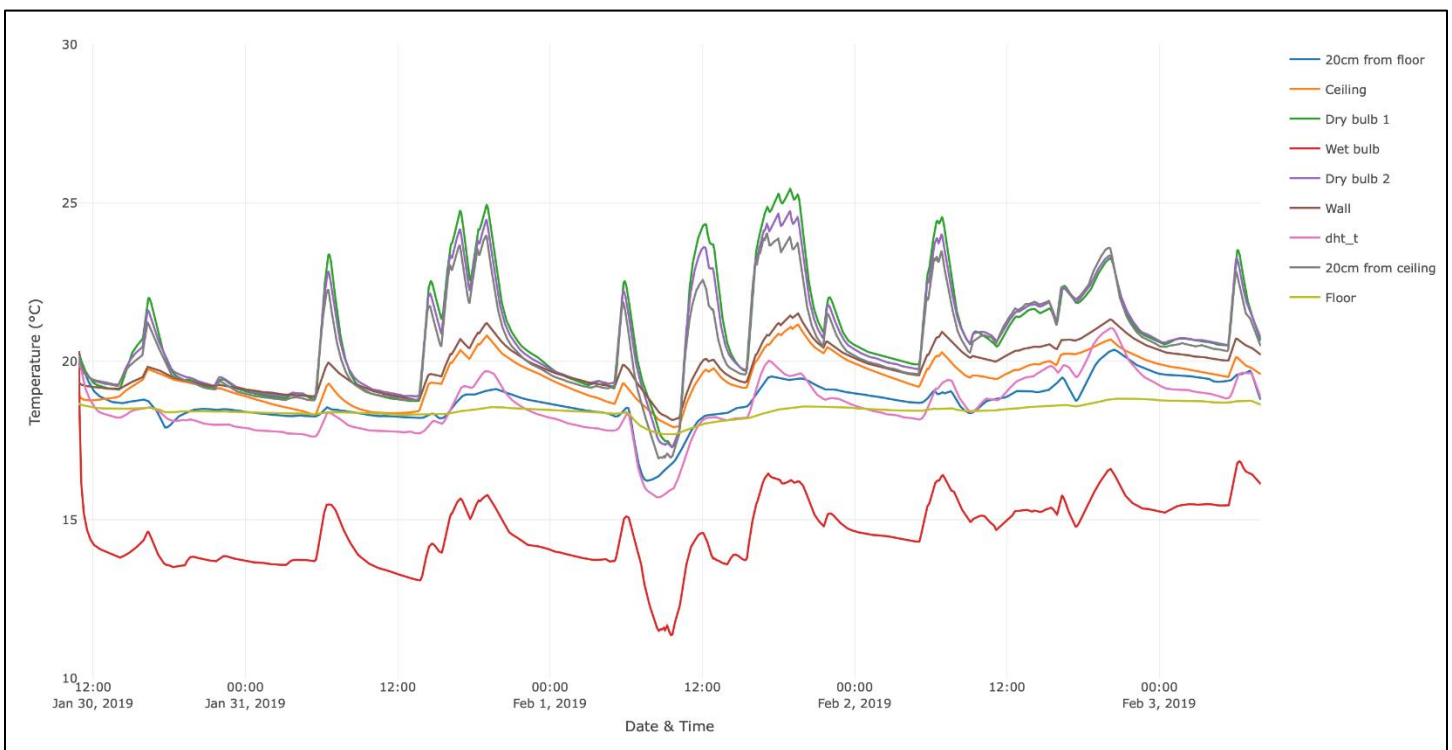

Figure 5: Example Graph for Temperature Sensor Data - for High Thermal Mass House take over a period of 5 days

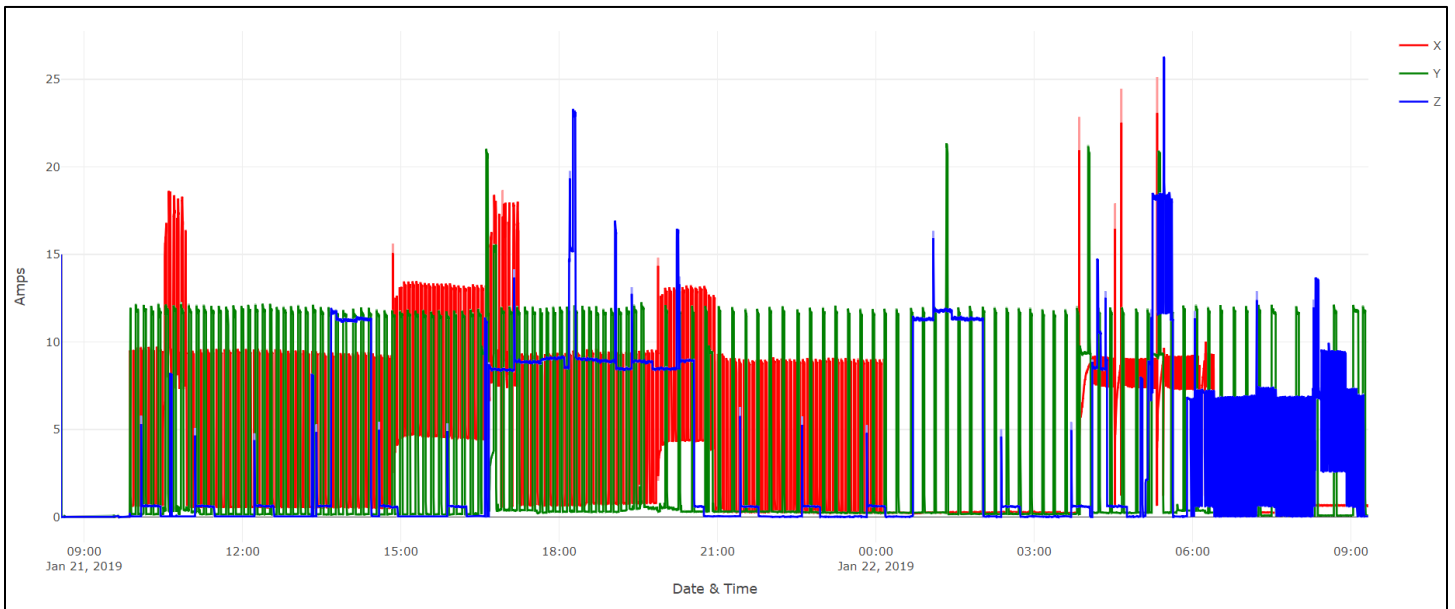

Figure 6: Example Graph for Current Sensor Data - for High Thermal Mass House take over a period of 5 days

In addition to looking at the data in a linear graphical format, there is also the ability to compare the temperature data to the humidity and create a heat map overlay with a psychrometric chart format. The purpose of this is to compare how the temperature and humidity within the home related to an occupant's perceived thermal comfort. The graph in Figure 7 was created by mathematically combining a bioclimatic chart and a psychrometric chart to determine which levels of temperature and humidity can be considered comfortable (Givoni, 2003).

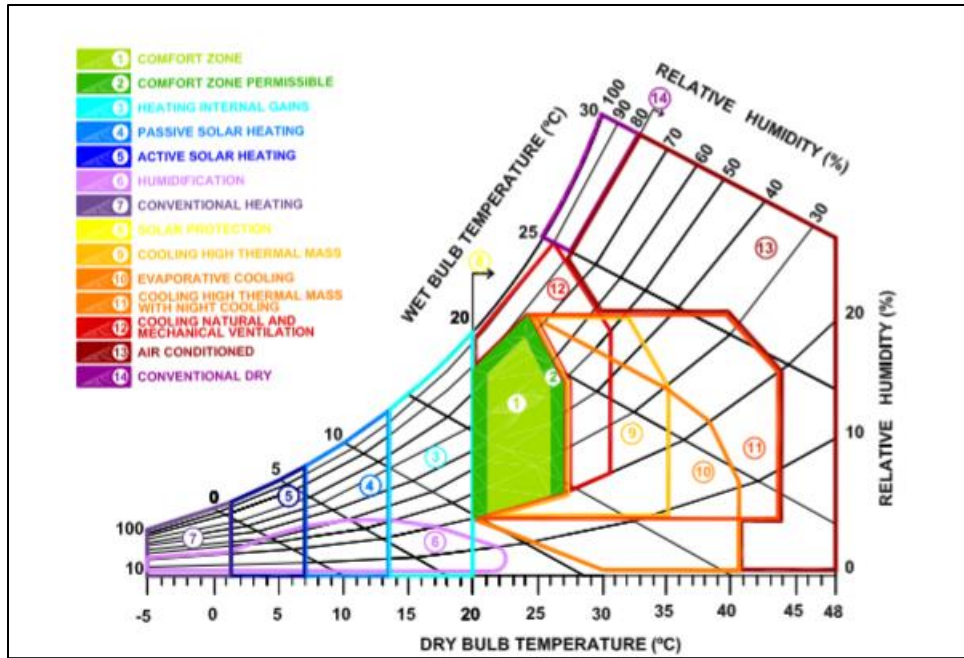

Figure 7: Psychrometric Chart created by Givoni to compare thermal comfort to relative humidity and temperature of an internal environment

By comparing the data created in the generated psychrometric chart found in Figure 8 to the zones outlined in Figure 7, there can be conclusions drawn as to how the measurements for each home under analysis compares to the relative comfort of the individuals living there. In the figure below, the blue dots refer to the high thermal mass housing, whereas the red dots refer to the light weight housing. The data recorded for this example heat map overlay was taken over a period of 5 days in the beginning of February in 2019.

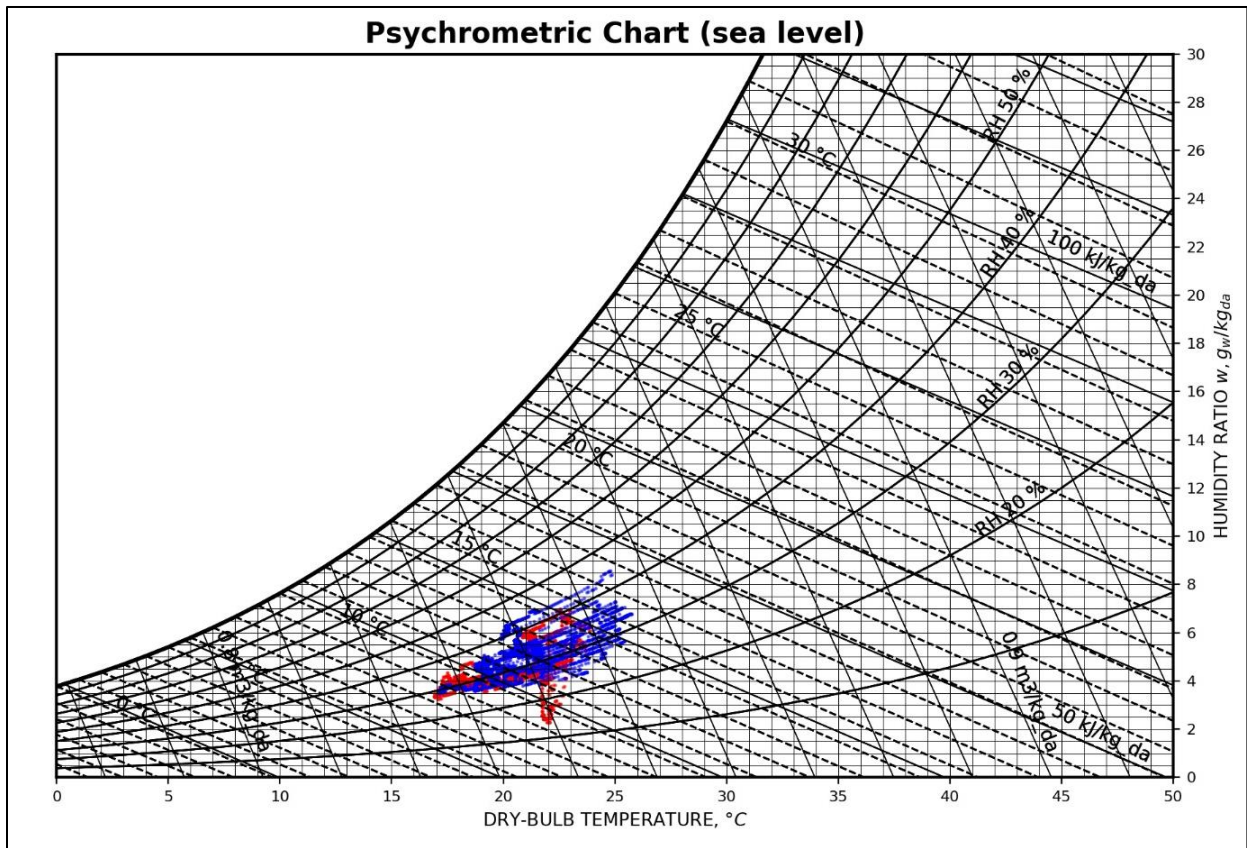

Figure 8: Example graph of heat map overlay with a psychrometric chart. To compare relative thermal comfort, reference the conclusions from this graph to the zones found in Figure 7

With the variety of different types of graphs shown above, several conclusions can be made between the relative energy usage and achieved internal home temperature verses outside temperatures, comparing one type of home to another, and determining if there is a correlation between high energy usage and temperatures that individuals may prefer for thermal comfort.

BIBLIOGRAPHY

- Atmel 8-bit Microcontroller with 4/8/16/32KBytes InSystem Programmable Flash[ATmega48A; ATmega48PA; ATmega88A; ATmega88PA; ATmega168A; ATmega168PA; ATmega328; ATmega328P]. (2012).
- DHT11 Basic Temperature-Humidity Sensor Extras. (2019). Retrieved February 3, 2019, from DHT11 basic temperature-humidity sensor extras
- DS3231 Data Sheet [Extremely Accurate I2C-Integrated RTC/TCXO/Crystal]. (2015).
- Givoni, B. (2003, February 12). Comfort, climate analysis and building design guidelines. Retrieved January 15, 2019, from <https://www.sciencedirect.com/science/article/pii/037877889290047K?via=ihub>
- Manzano-Agugliaro, F., Montoya, F. G., Sabio-Ortega, A., & García-Cruz, A. (2015).
- MAX31820 Data Sheet [1-Wire Ambient Temperature Sensor]. (2013).
- Non-Invasive Sensor: YHDC SCT013-000 CT used with Arduino. (SCT-013). (2018, June 28). Retrieved February 3, 2019, from <https://poweruc.com/blogs/news/non-invasive-sensor-yhdc-sct013-000-ct-used-with-arduino-sct-013>
- Review of bioclimatic architecture strategies for achieving thermal comfort. *Renewable and Sustainable Energy Reviews*, 49, 736-755. doi:10.1515/quageo-2017-0041
- Thermal comfort in buildings. (2018, September 21). Retrieved January 15, 2019, from https://www.designingbuildings.co.uk/wiki/Thermal_comfort_in_buildings
- Wilkins, B. (2016, February 25). SparkFun Shifting μ SD.

Appendix

A: Code to be Used to Program the Temperature Sensors

B: Code to be Used to Program the Current Sensors

Appendix A: Code to be Used to Program the Temperature Sensors

THE FOLLOWING CODE IS SPLIT INTO TWO COLUMNS FROM LEFT TO RIGHT.

MAIN CODE

```
/* -----  
----- */  
/* Copyright (c) 2019 Austin Shalit. All Rights  
Reserved.          */  
/* -----  
----- */  
  
// Arduino  
#include <Arduino.h>  
  
#include <SPI.h>  
#include <SD.h>  
  
#include <DallasTemperature.h>  
#include <DHT.h>  
#include <LowPower.h>  
  
// stdlib  
#include <stdint.h>  
  
#ifdef RTC_ENABLED  
#include "Rtc.h"  
#endif  
  
static constexpr uint8_t kOneWire_pin = 3;  
#ifdef DHT_ENABLED  
static constexpr uint8_t kDht_pin = 4;  
#endif  
static constexpr uint8_t kSdCs_pin = 8;  
static constexpr char kFilename[] = "data_5.csv";  
static constexpr char kHeader[] =  
    "timestamp,"  
    "Dry bulb,"  
    "Wet bulb,"  
    "Wall,"  
    "20cm from ceiling,"  
    "20cm from ceiling,"  
    "Ceiling,"  
    "Floor,"  
    "Dry bulb 2";  
  
// Hardware  
#ifdef RTC_ENABLED  
wpi::Rtc rtc;  
#endif  
  
OneWire oneWire(kOneWire_pin);  
DallasTemperature sensors(&oneWire);  
#ifdef DHT_ENABLED  
DHT dht(kDht_pin, DHT11);  
#endif  
DeviceAddress sensorAddresses[10] = {0};  
  
void setup() {  
    Serial.begin(115200);  
    Serial.println("\n\n--Init--");  
  
#ifdef RTC_ENABLED  
    rtc.Init();  
#endif  
  
#ifdef SD_CARD_ENABLED  
    while (!SD.begin(kSdCs_pin)) {  
        Serial.println("sd-fail");  
    }  
    File dataFile = SD.open(kFilename, FILE_WRITE);  
    dataFile.seek(0);  
    dataFile.println(kHeader);  
    dataFile.close();  
#endif  
    Serial.println(kHeader);  
  
    // OneWire  
    sensors.begin();  
    sensors.setResolution(12);  
  
    for (uint8_t i = 0; i < sensors.getDeviceCount(); i++) {  
        if (!sensors.getAddress(sensorAddresses[i], i)) {  
            Serial.print("Unable to find address for Device ");  
            Serial.println(i);  
        }  
    }  
  
#ifdef DHT_ENABLED  
    dht.begin();  
#endif  
}  
  
void loop() {  
    sensors.requestTemperatures();
```

```

#ifdef RTC_ENABLED
    char dateStr[20];
    rtc.GetDateTimeString(dateStr, 20);
#endif

#ifdef SD_CARD_ENABLED
    File dataFile = SD.open(kFilename, FILE_WRITE);
    if (!dataFile) {
        Serial.println("sd-e-of");
        return;
    }
#endif

    Serial.print(dateStr);
#ifdef SD_CARD_ENABLED &&
defined(RTC_ENABLED)
    dataFile.print(dateStr);
#endif

    for (auto address : sensorAddresses) {
        if (address[0] == 0) {
            continue;
        }
        float temperature = sensors.getTempC(address);
        Serial.print(',');
#ifdef SD_CARD_ENABLED
        dataFile.print(',');
#endif
        if (temperature == DEVICE_DISCONNECTED_C) {
            Serial.print("None");
#ifdef SD_CARD_ENABLED
            dataFile.print("None");
#endif
        } else {
            Serial.print(temperature, 4);
#ifdef SD_CARD_ENABLED
            dataFile.print(temperature, 4);
#endif
        }
    }

}

}

#ifdef DHT_ENABLED
    float humidity = dht.readHumidity(false);
    Serial.print(',');
    Serial.print(humidity, 0);
#ifdef SD_CARD_ENABLED
    dataFile.print(',');
    dataFile.print(humidity, 0);
#endif

    float dhtTemperature = dht.readTemperature(false,
false);
    Serial.print(',');
    Serial.print(dhtTemperature, 1);
#ifdef SD_CARD_ENABLED
    dataFile.print(',');
    dataFile.print(dhtTemperature, 1);
#endif

    Serial.println();

#ifdef SD_CARD_ENABLED
    dataFile.println();
    dataFile.close();
#endif

#ifdef TEST_MODE
    for (uint8_t i = 0; i < 7; i++) {
        oneWire.depower();
        LowPower.powerDown(SLEEP_8S, ADC_OFF,
BOD_OFF);
    }
    sensors.begin();
#endif
}

```

THE FOLLOWING CODE IS SPLIT INTO TWO COLUMNS FROM LEFT TO RIGHT.

RTC CODE

```
/* -----  
----- */  
/* Copyright (c) 2019 WPI. All Rights Reserved.  
*/  
/* -----  
----- */  
  
#include "Rtc.h"  
  
#include <stdio.h>  
  
#include <avr/pgmspace.h>  
  
using namespace wpi;  
  
Rtc::Rtc() : m_rtc(Wire) {}  
  
bool Rtc::Init() {  
    m_rtc.Begin();  
  
    RtcDateTime compiled = RtcDateTime(__DATE__,  
    __TIME__);  
  
    if (!m_rtc.IsDateTimeValid()) {  
        // Common Causes:  
        // 1) first time you ran and the device wasn't running  
        yet  
        // 2) the battery on the device is low or even missing  
        // Serial.println("RTC lost confidence in the  
        DateTime!");  
  
        // following line sets the RTC to the date & time this  
        sketch was compiled  
        // it will also reset the valid flag internally unless the  
        Rtc device is  
        // having an issue  
        m_rtc.SetDateTime(compiled);  
    }  
  
    if (!m_rtc.GetIsRunning()) {  
        // Serial.println("RTC was not actively running,  
        starting now");  
        m_rtc.SetIsRunning(true);  
    }  
  
    RtcDateTime now = m_rtc.GetDateTime();  
    if (now < compiled) {  
        // Serial.println("RTC is older than compile time!  
        (Updating DateTime)");  
        m_rtc.SetDateTime(compiled);  
    } else if (now > compiled) {  
        // Serial.println("RTC is newer than compile time.  
        (this is expected)");  
    } else if (now == compiled) {  
        // Serial.println(  
        // "RTC is the same as compile time! (not expected  
        but all is fine)");  
    }  
  
    // never assume the Rtc was last configured by you, so  
    // just clear them to your needed state  
    m_rtc.Enable32kHzPin(false);  
  
    m_rtc.SetSquareWavePin(DS3231SquareWavePin_Mod  
    eNone);  
  
    return true;  
}  
  
void Rtc::Loop() {}  
  
void Rtc::GetDateTimeString(char* str, const size_t  
size) {  
    RtcDateTime dt = m_rtc.GetDateTime();  
    snprintf_P(str, size, PSTR("%02u/%02u/%04u  
%02u:%02u:%02u"), dt.Month(),  
        dt.Day(), dt.Year(), dt.Hour(), dt.Minute(),  
        dt.Second());  
}  
  
#define countof(a) (sizeof(a) / sizeof(a[0]))  
  
void Rtc::PrintDateTime() {  
    char datestring[20];  
    GetDateTimeString(datestring, countof(datestring));  
    Serial.print(datestring);  
}  
  
float Rtc::GetTemperature() { return  
m_rtc.GetTemperature().AsFloatDegC(); }
```

Appendix B: Code to be Used to Program the Current Sensors

THE FOLLOWING CODE IS SPLIT INTO TWO COLUMNS FROM LEFT TO RIGHT.

MAIN CODE

```
/* -----  
----- */  
/* Copyright (c) 2019 Austin Shalit. All Rights  
Reserved.          */  
/* -----  
----- */  
  
// Arduino  
#include <Arduino.h>  
  
#include <SPI.h>  
#include <SD.h>  
  
#include <LowPower.h>  
  
// stdlib  
#include <stdint.h>  
  
#ifndef RTC_ENABLED  
#include "Rtc.h"  
#endif  
  
#define ADC_BITS 10  
#define ADC_COUNTS (1 << ADC_BITS)  
  
static constexpr char kFilename[] = "log3.csv"; // The  
name of the log file  
static constexpr char sep = ',';  
static constexpr char kHeader[] =  
    "timestamp,"  
    "X1,"  
    "Y1,"  
    "Z1";  
static constexpr uint8_t kSdCs_pin = 8; // SD Card pin  
  
static constexpr int kNumberOfSamples = 1480;  
static constexpr double kICalibration = 2000.0 / 82.0; //  
2000 turn inductor / 82 ohm burden resistor  
static constexpr double kIRatio = kICalibration * (3.3 /  
ADC_COUNTS);  
  
struct CurrentSensor {  
    uint8_t pin;  
    double offsetI;  
};  
  
CurrentSensor x1 = { .pin=0,  
.offsetI=ADC_COUNTS>>1 };  
CurrentSensor y1 = { .pin=1,  
.offsetI=ADC_COUNTS>>1 };  
CurrentSensor z1 = { .pin=2,  
.offsetI=ADC_COUNTS>>1 };  
  
// Hardware  
#ifndef RTC_ENABLED  
wpi::Rtc rtc;  
#endif  
  
double calcIrms(CurrentSensor sensor) {  
    double sumI;  
    for (unsigned int n = 0; n < kNumberOfSamples; n++)  
    {  
        int sampleI = analogRead(sensor.pin);  
  
        // Digital low pass filter extracts the 1.65 V dc offset,  
        // then subtract this - signal is now centered on 0  
        // counts.  
        sensor.offsetI = (sensor.offsetI + (sampleI -  
sensor.offsetI) / ADC_COUNTS);  
        double filteredI = sampleI - sensor.offsetI;  
  
        // Root-mean-square method current  
        // 1) square current values  
        double sqI = filteredI * filteredI;  
        // 2) sum  
        sumI += sqI;  
    }  
  
    return kIRatio * sqrt(sumI / kNumberOfSamples);  
}  
  
void setup() {  
    Serial.begin(115200);  
    Serial.println("\n\n--Init--");  
  
#ifndef RTC_ENABLED  
    rtc.Init();  
#endif
```

```

#ifdef SD_CARD_ENABLED
while (!SD.begin(kSdCs_pin)) {
  Serial.println("sd-fail");
}
File dataFile = SD.open(kFilename, FILE_WRITE);
if (!dataFile) {
  Serial.println("sd-e-of");
}

dataFile.seek(0);
dataFile.println(kHeader);
dataFile.close();
#endif
Serial.println(kHeader);
}

void loop() {
double iRmsX1 = calcIrms(x1);
double iRmsY1 = calcIrms(y1);
double iRmsZ1 = calcIrms(z1);

```

```

#ifdef RTC_ENABLED
char dateStr[20];
rtc.GetDateTimeString(dateStr, 20);
#endif

```

```

#ifdef SD_CARD_ENABLED
File dataFile = SD.open(kFilename, FILE_WRITE);
if (!dataFile) {
  Serial.print("sd-e-of: ");
  Serial.println(dataFile);
  return;
}
#endif

```

```

#ifdef RTC_ENABLED
Serial.print(dateStr);
Serial.print(sep);
#endif
#ifdef SD_CARD_ENABLED
dataFile.print(dateStr);
dataFile.print(sep);
#endif
#endif

```

```

Serial.print(iRmsX1, 4);
Serial.print(sep);
Serial.print(iRmsY1, 4);
Serial.print(sep);
Serial.print(iRmsZ1, 4);
Serial.println();

```

```

#ifdef SD_CARD_ENABLED
dataFile.print(iRmsX1, 4);
dataFile.print(sep);
dataFile.print(iRmsY1, 4);
dataFile.print(sep);
dataFile.print(iRmsZ1, 4);

dataFile.println();
dataFile.close();
#endif

#ifndef TEST_MODE
for (uint8_t i = 0; i < 3; i++) {
  LowPower.powerDown(SLEEP_8S, ADC_OFF,
BOD_OFF);
}
#endif
}

```

THE FOLLOWING CODE IS SPLIT INTO TWO COLUMNS FROM LEFT TO RIGHT.

RTC CODE

```
/* -----  
----- */  
/* Copyright (c) 2019 WPI. All Rights Reserved.  
*/  
/* -----  
----- */  
  
#include "Rtc.h"  
  
#include <stdio.h>  
  
#include <avr/pgmspace.h>  
  
using namespace wpi;  
  
Rtc::Rtc() : m_rtc(Wire) {}  
  
bool Rtc::Init() {  
    m_rtc.Begin();  
  
    RtcDateTime compiled = RtcDateTime(__DATE__,  
    __TIME__);  
  
    if (!m_rtc.IsDateTimeValid()) {  
        // Common Causes:  
        // 1) first time you ran and the device wasn't running  
yet  
        // 2) the battery on the device is low or even missing  
        // Serial.println("RTC lost confidence in the  
DateTime!");  
  
        // following line sets the RTC to the date & time this  
sketch was compiled  
        // it will also reset the valid flag internally unless the  
Rtc device is  
        // having an issue  
        m_rtc.SetDateTime(compiled);  
    }  
  
    if (!m_rtc.GetIsRunning()) {  
        // Serial.println("RTC was not actively running,  
starting now");  
        m_rtc.SetIsRunning(true);  
    }  
  
    RtcDateTime now = m_rtc.GetDateTime();  
    if (now < compiled) {  
        // Serial.println("RTC is older than compile time!  
(Updating DateTime)");  
        m_rtc.SetDateTime(compiled);  
    } else if (now > compiled) {  
        // Serial.println("RTC is newer than compile time.  
(this is expected)");  
    } else if (now == compiled) {  
        // Serial.println(  
        // "RTC is the same as compile time! (not expected  
but all is fine)");  
    }  
  
    // never assume the Rtc was last configured by you, so  
    // just clear them to your needed state  
    m_rtc.Enable32kHzPin(false);  
  
    m_rtc.SetSquareWavePin(DS3231SquareWavePin_Mod  
eNone);  
  
    return true;  
}  
  
void Rtc::Loop() {}  
  
void Rtc::GetDateTimeString(char* str, const size_t  
size) {  
    RtcDateTime dt = m_rtc.GetDateTime();  
    snprintf_P(str, size, PSTR("%02u/%02u/%04u  
%02u:%02u:%02u"), dt.Month(),  
        dt.Day(), dt.Year(), dt.Hour(), dt.Minute(),  
dt.Second());  
}  
  
#define countof(a) (sizeof(a) / sizeof(a[0]))  
  
void Rtc::PrintDateTime() {  
    char datestring[20];  
    GetDateTimeString(datestring, countof(datestring));  
    Serial.print(datestring);  
}  
  
float Rtc::GetTemperature() { return  
m_rtc.GetTemperature().AsFloatDegC(
```

