

Designing an Aquaponic Greenhouse for an Urban Food Security Initiative – Extended Report

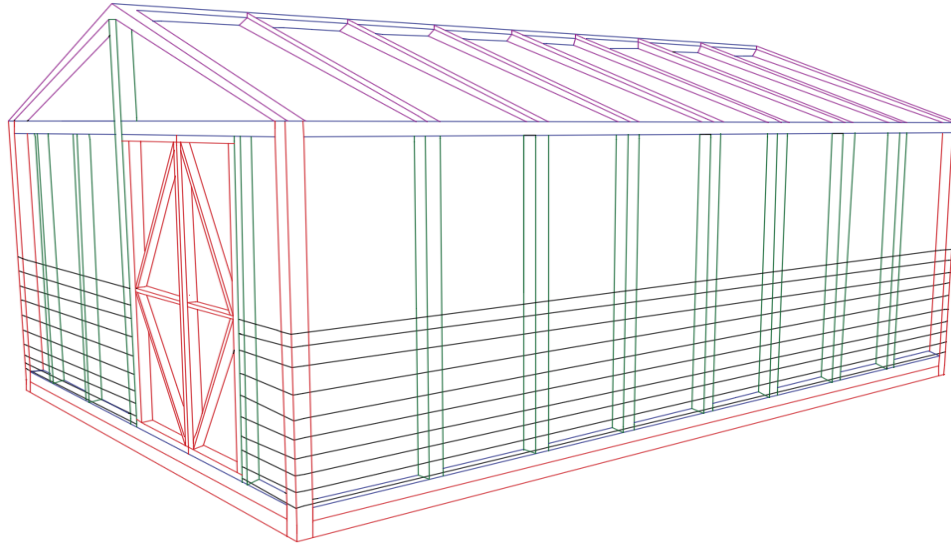

By
Rashid Chatani
Gabriel Demeneghi
Redon Hoxha
Khazhismel Kumykov
Blaine Rieger

Designing an Aquaponic Greenhouse for an Urban Food Security Initiative – Extended Report

An Interactive Qualifying Project
submitted to the Faculty of
WORCESTER POLYTECHNIC INSTITUTE
in partial fulfilment of the requirements for the
degree of Bachelor of Science

By
Rashid Chatani
Gabriel Demeneghi
Redon Hoxha
Khazhismel Kumykov
Blaine Rieger

Date:
30 April 2015

Report Submitted to:

Matt Feinstein
Worcester Roots Project

Professors Stephen McCauley and Lorraine Higgins
Worcester Polytechnic Institute

This report represents work of WPI undergraduate students submitted to the faculty as evidence of a degree requirement. WPI routinely publishes these reports on its web site without editorial or peer review. For more information about the projects program at WPI, see <http://www.wpi.edu/Academics/Projects>.

Abstract

This project supported the Worcester Roots Project's effort to build an aquaponic greenhouse at Stone Soup Community Center by designing a greenhouse and prototyping a modular aquaponic growing system. The team collaborated with Worcester Roots and Technocopia to develop a vision for the greenhouse project, evaluate options and determine appropriate designs for the system. We proposed a design for a wooden greenhouse with several growing systems using cheap, readily available materials, and successfully built a prototype growing system that to be by a future cooperative incubated by Worcester Roots. This project will enable growing local, fresh food in the City of Worcester and provide a starting point for developing a cooperative food business.

Acknowledgements

We would like to thank Professor Stephen McCauley and Professor Lorraine Higgins for their constant support and guidance throughout this project.

We would like to thank Professor Alamo for his assistance with the greenhouse design.

We would like to thank everyone at the Worcester Roots Project for their help, encouragement, and cooperation throughout this project.

We would also like to thank Technocopia and their volunteer members for assisting us with use of their workshop during construction.

We would like to thank Amanda Barker and Jonathan Bates for showing us around their greenhouses.

Authorship

Rashid Chatani investigated the aquaponic cycle and what plants and fish would work best in such a system. He developed the base ratios that were used to develop the rest of the design. He also authored background sections regarding aquaponics and its benefits, as well as sections regarding our partners.

Gabriel Demeneghi investigated possible designs and components for a greenhouse and created our final greenhouse design. He authored all sections regarding such topics.

Redon Hoxha investigated components for the aquaponic system, in particular plumbing, piping, and heating. As well, he investigated heating for the greenhouse structure. He authored all sections regarding such topics.

Khazhismel Kumykov investigated the market for aquaponics, and also investigated fish tank solutions. He authored the relevant sections. He also was the primary author of the abstract and was the main formatting editor for the paper.

Blaine Rieger investigated solutions for the plant bed design in our system, including possible growing media, and bed designs, and authored relevant sections.

Table of Contents

Abstract	iii
Acknowledgements	iv
Authorship	v
Table of Contents.....	vi
Table of Tables.....	ix
Table of Figures.....	ix
Table of Equations	x
I Executive Summary.....	xi
I.i Introduction	xi
I.ii Aquaponic Growing Systems and their Potential to Contribute to Urban Food Security	xii
I.iii Methods.....	xiii
I.iii.i Assessing the Stakeholder’s Needs	xiv
I.iii.ii Understanding Aquaponic Greenhouse Systems and Evaluating Design Options	xiv
I.iii.iii Designing the Greenhouse System.....	xv
I.iii.iv Building Out Prototype Aquaponic Growing System	xvi
I.iv Findings.....	xvi
I.iv.i Stakeholder’s Needs.....	xvi
I.iv.ii Design Considerations.....	xvi
I.v Proposed Aquaponic Greenhouse Design	xxi
I.v.i The Greenhouse Structure	xxi
I.v.ii The Aquaponic Growing System.....	xxiii
I.v.iii Operating Schedule	xxvi
I.v.iv The Prototype Aquaponic System	xxvii
I.vi Conclusion and Recommendations	xxviii
Chapter 1 Introduction	1
Chapter 2 Background	3
2.1 Food Security and Urban Food Production	3
2.1.1 Urban Food Production	3
2.1.2 Food Production in and around Worcester	5
2.2 Aquaponics as an Approach to Urban Food Production.....	5
2.2.1 Biological & Nutrient Cycles in Aquaponic Systems	7
2.2.2 Benefits of Aquaponics.....	7
2.2.3 How common is Aquaponics in the United States and the North East?	8
2.2.4 Markets in the United States.....	8
2.2.5 The Greenhouse Initiative	9
2.3 Aquaponic Greenhouse Design	10
2.3.1 Greenhouse Structure	10

2.3.2	Aquaponic System Structural Components	22
2.3.3	Composition of Fish and Crops in Aquaponics	35
Chapter 3	Methodology.....	38
3.1	Assessing Stakeholder’s Needs	38
3.2	Understanding Aquaponic Greenhouse Systems and Evaluating Design Options	38
3.3	Designing Greenhouse Structure	38
3.3.1	Exterior.....	39
3.3.2	Interior Layout.....	40
3.3.3	Interior Heating	40
3.4	Designing Growing System.....	40
3.4.1	Plant and Fish	40
3.4.2	Bed	41
3.5	Developing a Cost Estimate for Building and Operating Greenhouse	41
3.6	Creating an Operating Schedule.....	41
Chapter 4	Findings and Accomplishments	42
4.1	Stakeholder’s Needs	42
4.2	The Greenhouse.....	42
4.2.1	Frame Design - Roof	44
4.2.2	Frame Design - Walls.....	45
4.2.3	Floor	46
4.2.4	Foundation	48
4.2.5	Ventilation.....	49
4.2.6	Heating	49
4.3	Aquaponic Growing System	51
4.3.1	Plant and Fish Ratio.....	51
4.3.2	Growing Bed: Wooden Bed vs 55-Gallon Drum.....	51
4.3.3	Water Tank.....	54
4.3.4	Water Heating	55
4.3.5	Water Circulation	56
4.4	Operating Schedule.....	57
Chapter 5	Conclusions and Recommendations.....	60
5.1	Recommendations For Further Investigation	60
5.1.1	Ventilation.....	60
5.1.2	Interior Layout.....	60
5.1.3	Structure	60
5.1.4	Insulation	61
5.1.5	Plants.....	61
5.1.6	Business Development	61
5.1.7	Renewable Energy Sources	61
5.1.8	Vertical Growing Bed.....	61

5.1.9	Artificial Lighting	62
5.2	Final Thoughts	62
Works Cited		63
Appendix A:	Growing Seasons of Different Vegetables	70
Appendix B:	Budget	71
Appendix C:	Alternative Greenhouse Structure Design	73
Appendix D:	Greenhouse Structure Costs for Alternative Materials.....	74
Appendix E:	Alternative Roof Designs.....	77
Appendix F:	Prices of Paneling Calculations	78
Appendix G:	Heat Loss Calculations	85
Appendix H:	Calculations for Heat Loss	86
Appendix I:	Visualization of Heat Loss Curves.....	87
Appendix J:	Visualization of Static Head for Pumps	87
Appendix K:	Table Different materials for paneling, how they are sold, and its price per square foot.....	88
Appendix L:	Prototype Growing Bed Build Instructions	89
Appendix M:	Startup Cost Calculations for Various Heating Systems	91
Appendix N:	Estimated Cost for Internal System	93
Appendix O:	Estimated Cost for Wooden Structure	94
Appendix P:	Grow Bed and Stand Schematics	95

Table of Tables

Table 1. Greenhouse Covering Materials and their properties	13
Table 2. A comparison of different insulation material.....	19
Table 3. Comparison of Rectangular and Round Tanks.....	23
Table 4. Comparison of different tank materials	23
Table 5. Comparison of different piping materials.....	24
Table 6. Comparison of different heating sources.	24
Table 7 Advantages and Disadvantages of Pump Types	29
Table 8: The Pros and Cons of Different Types of Bio Filters	30
Table 9. Comparison of growing bed styles	33
Table 10. Growing Media	34
Table 11. Types of Lights.....	35
Table 12. Nitrogenous requirements of Plants Commonly Grown in Aquaponics	36
Table 13. Comparison of different Fish Species	37
Table 14. Estimated Cost of Materials for the Structure.....	49
Table 15. Monthly Average Temperatures for Worcester	50
Table 16. Estimated Monthly Heating Costs	50
Table 17 : Comparison Of IQP and Bersntein Ratio Findings.....	51
Table 18. Bed Cost Breakdown for One Bed	51
Table 19. Variant of Bedding Designs	52
Table 20. Bedding Style Comparison.....	54
Table 21. Estimated Cost of Water Tank Options	55
Table 22. Different Water Pumps	57

Table of Figures

Figure 1. The Aquaponic Cycle (Acquired from Worcester Roots http://www.worcesterroots.org/projects-and-programs/youth-in-charge/)	xii
Figure 2. Project Overview.....	xiv
Figure 3. Possible greenhouses structure designs. Our final design uses the post-and-rafter style. (Acquired from http://www.nafis.go.ke/vegetables/tomatoes/shapes-of-frames/).....	xvii
Figure 4. The IBC Tote was recommended to be used as a fish tank	xx
Figure 5. Greenhouse Design - Our design follows a post and rafter style, with insulation on the bottom 4ft. of the walls.	xxi
Figure 6. Internal Layout for 22'x33' Greenhouse.....	xxiii
Figure 7. Schematic for Growing Bed. Sized to be general purpose growing bed.	xxiv
Figure 8. Schematic for bed stand.	xxv
Figure 9. Full System Layout, incl. plumbing. The bed has two drains, a bell siphon and a larger emergency drain to prevent over-filling. One tube extends from the fish tank to provide water into the bed.....	xxvi
Figure 10 : Tentative Operating Schedule of Greenhouse	xxvii
Figure 11. Constructed Prototype. Left: Fish Tank; Right: Bed & Stand. Piping has not been cemented yet.	xxviii
Figure 12. Food Deserts in Worcester (Green limited supermarkets within 1 mile, Orange within ½ mile) (Acquired from United States Department of Agriculture at http://www.ers.usda.gov/data/fooddesert) 3	

Figure 13. Agriculture in Worcester County	5
Figure 14. The Aquaponic Cycle (Acquired from Worcester Roots http://www.worcesterroots.org/projects-and-programs/youth-in-charge/)	6
Figure 15 greenhouses designs	11
Figure 16 a rigid-frame structure	11
Figure 17. Curved Thermal Blanket	16
Figure 18: Solar-powered vent opener	21
Figure 19. Flow in Round and Rectangular Tanks. Rectangular tanks suffer from reduced flow at corners.	22
Figure 20. Various Heating Options	25
Figure 21. Costs and ROI over 10 years of different Systems	26
Figure 22. Impleller Pump	27
Figure 23. AirLift Pump	28
Figure 24. Peristaltic Pump	28
Figure 25. Biological Filter	29
Figure 26. Pebble Media (Richard, 2011)	31
Figure 27. Small Scale Floating Rafter (Aquaponic Designs, n.d.).....	31
Figure 28. Stone wool Seedlings (Aquaponic Designs, n.d.).....	32
Figure 29. Underneath Floating Rafter (Aquaponic Designs, n.d.)	32
Figure 30. Professional Aquaponic Setup.....	33
Figure 31. Growing Bed with Expanded Shale	34
Figure 32. Rigid frame greenhouse with double doors	43
Figure 33. Pre-engineered Truss	44
Figure 34. Diagonal Post on Walls.....	45
Figure 35. Double Skin Wall filled with Fiberglass.....	46
Figure 36 Special greenhouse floor	47
Figure 37 Crushed stone floor.....	47
Figure 38. Sonotube being installed (Roberts J. , 2012)	48
Figure 39. 55-Gallon Drum Beds http://farm4.static.flickr.com/3341/3580585324_f90c15b787.jpg	53
Figure 40. The IBC Tote was recommended to be used as a fish tank	54
Figure 41. Submersible Water Heater.....	56
Figure 42 : Tentative Operating Schedule of Greenhouse	58
Figure 43 : Monthly Sunshine Days for City of Worcester (Center, n.d.).....	58

Table of Equations

Equation 1. Volume of a Triangular Prism.....	20
Equation 2. Volume of a Rectangular Prism.....	20

I Executive Summary

I.i Introduction

Access to fresh, healthy, and affordable food is a fundamental requirement for healthy living. As of 2013 in the United States 38.9% of low-income households and 14.3% of all households were considered “food insecure” – meaning they did not have access to enough food for “active, healthy living” (Alisha Coleman-Jensen C. G., 2014; Alisha Coleman-Jensen C. G., 2014). One of the manifestations of food insecurity are *food deserts* – communities that have limited access to supermarkets or grocery stores that often rely on fast food and convenience stores with a lack of healthy affordable food (USDA AMS, n.d.).

Cities are becoming increasingly concerned with how food relates to the urban environment and are encouraging the development of “sustainable food systems” that contribute to high quality neighborhoods, meet the health and nutrition needs of residents, and promote environmental sustainability (Koc, 1999). Food deserts and food insecurity are all signs of unsustainable food systems. A community that does not have ready access to supermarkets nor is able supply itself with fresh food cannot sustain its inhabitants. According to the data stipulated by the USDA, there are about five of these communities here in Worcester, one of these communities is Main South.

Worcester Roots, the main sponsor of our project, in an effort to address food security as well as to empower the local residents, has decided to build a greenhouse capable of providing fresh and affordable food. Worcester Roots is a non-profit organization seeking “to create opportunities for economic, social and environmental justice” (Worcester Roots, n.d.). In this effort, they lead local projects to help clean their local areas, raise awareness for issues such as toxic soil and a just economy. Worcester Roots supports the worker cooperative style of economy and incubates a number of cooperative businesses (Worcester Roots, n.d.).

The goals of the greenhouse project was to design and construct a greenhouse and aquaponic growing facility and start a pilot cooperative business running out of the greenhouse. With the project they seek to empower local residents, provide a healthy, local food source for Worcester residents, and educate members and local youth about greenhouse growing, aquaponics, and the cooperative businesses. The organization has expressed its wish to have students from schools come in and learn about co-ops as well as how a greenhouse works; these students would then take back that knowledge to their schools and homes, spreading interest and knowledge. If the interest is widespread and the 3 year pilot is successful, the organization has articulated that scaling up the greenhouse will be very high on their priority list (Worcester Roots, n.d.). Possible expansions include expanding up to industrial scale operations in warehouses throughout Worcester, or expanding out to individual residences with many family sized productions.

The goal of our project was to assist Worcester Roots in their development of the pilot greenhouse project and the cooperative greenhouse business by providing: technical support, research assistance and insight into the social context associated with the project. We collaborated with partner organizations, including Worcester Roots, Technocopia, and various other parties interested in the greenhouse project and cooperative pilot to synthesize an open sourced design that will be easily replicated by anyone having an interest in aquaponic systems.

We completed the project by conducting research in the Aquaponic field and comparing various components for the creation of an Aquaponic system. From our research, we then produced complete designs for both a greenhouse that fulfills Worcester Roots' needs and a modular self-contained aquaponic growing system that would be housed in the greenhouse, including the biological and mechanical aspects of the system. We also produced a budget for the complete system build and operating costs, and an operating schedule. We collaborated closely with Worcester Roots, Technocopia and other experts throughout the project in order to ensure that the results and deliverables are appropriate to the stakeholders needs. Finally, we worked out of the Technocopia makerspace with assistance from Technocopia members, to produce a prototype aquaponic growing system that will be used by Worcester Roots.

I.ii Aquaponic Growing Systems and their Potential to Contribute to Urban Food Security

Aquaponics is a bio-integrated food system which allows for the production of both plants and animals for consumption without requiring arable land. Aquaponics can be defined as the integration of hydroponics – growing without soil – and aquaculture – fish farming. Plants situated on water beds are grown with aquatic life, usually fish. The intricate design allows for the waste products of one biological system to serve as nutrients for another (Wahl, 2010).

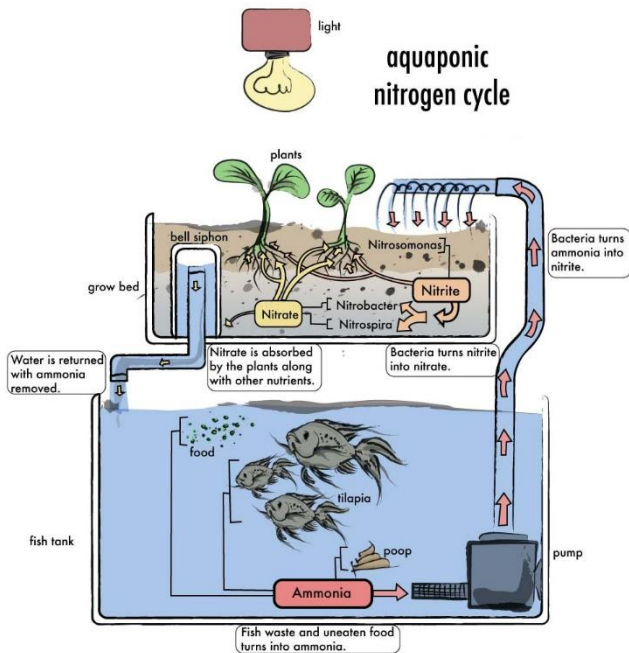

Figure 1. The Aquaponic Cycle (Acquired from Worcester Roots <http://www.worcesterroots.org/projects-and-programs/youth-in-charge/>)

In aquaponics water is reflowed through the system circulating fish runoff and plant/algae matter, which creates an efficient ecosystem that provides fertilization for the plants and cleans the water for the fish, creating an extremely efficient system for growing.

Aquaponics recycles a lot of the raw materials put into the system and makes the process very efficient. Aquaponics uses 90% less water than traditional farming, while simultaneously producing on average six

times more yield per square foot than traditional farming (Marklin, 2013). This is partly due to the interior homeostasis that allows production in any type of climate zone. Plant growth is also drastically increased as the threat of pest is reduced as plants are grown indoors, and the water is naturally fortified by the fish. The lighting also plays a very important role in the growth efficiency as they are hung vertically and used to simultaneously grow two areas of plants as opposed to one are. (Jason, 2012)

In addition to these farming benefits there are also environmental benefits to using aquaponics. Since the process is regulated and the waste material is cycled, there is no harmful fertilizer run off into and water sources such as water sheds and rivers. This greatly reduces the instances of water pollution that arises as a misuse of fertilizers, this causes great damage to the aquatic life in these water bodies. (Jim, 2009).

Using aquaponic systems to enable growing food in urban environments provides the residents with more sustainable, local food sources. Eliminating the waste of needing to transport food from long distances, localized food production is a more sustainable and green way of providing a community with food. As well, coupling the localized food production with a cooperative economy enables the residents to not only have access to fresh food, but also gives them the power over their own food.

I.iii Methods

The end goal of this project was to help Worcester Roots develop a design for a greenhouse and growing system to be built on at the Stone Soup Community Center, and provide information and a plan for operating it. Our team developed a design for a greenhouse and growing system and worked with Technocopia to build out a prototype growing system.

Our team developed the following objectives to meet our goals:

- Assess the stakeholder's needs
- Develop an understanding of aquaponics and evaluate design options by investigating existing literature, visiting greenhouses in the region, and consulting with experts.
- Design greenhouse and growing system that fit Worcester Root's needs (incl. cost estimate)
- Build out prototype system

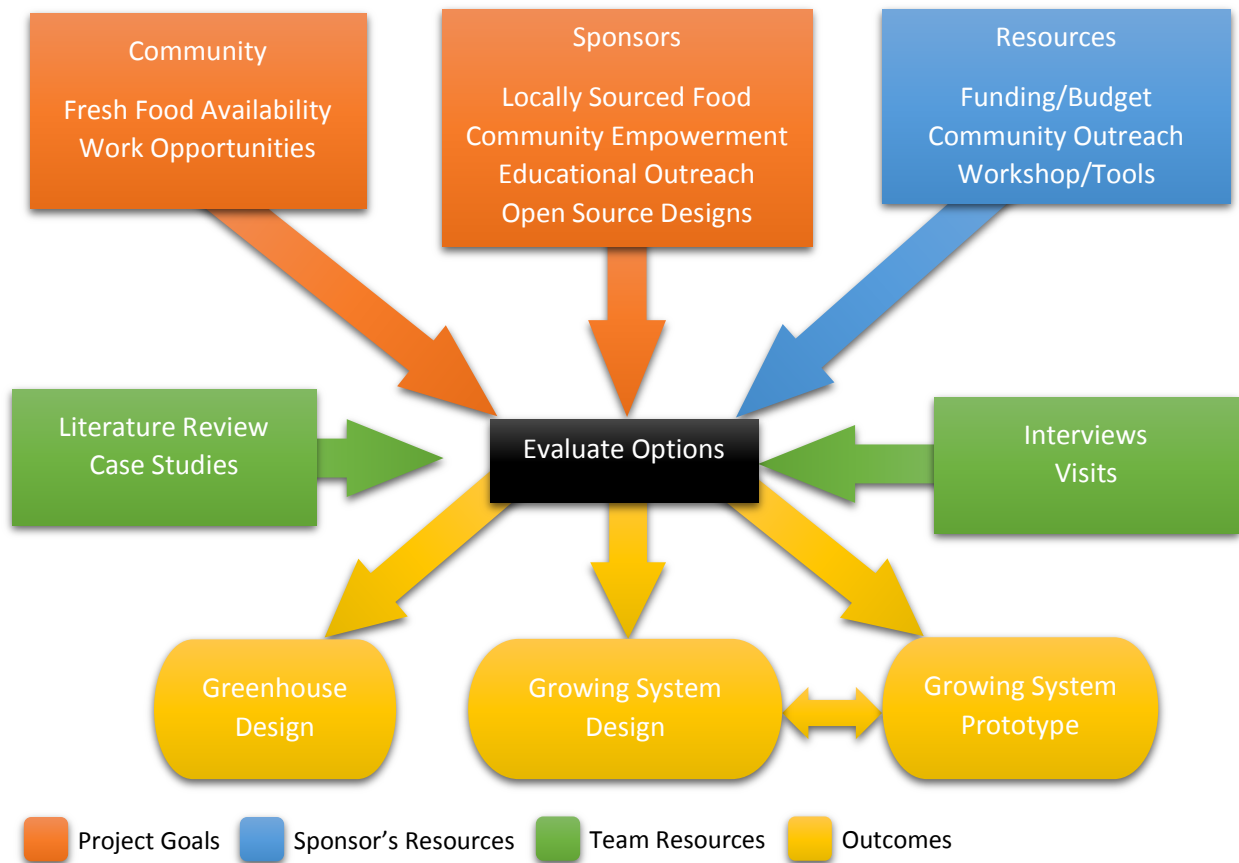

Figure 2. Project Overview

I.iii.i Assessing the Stakeholder's Needs

In order to fully understand the various stakeholder's needs we participated in regular group meetings at Worcester Roots and Technocopia to provide status updates, discuss design decisions, and steer the course for the project. We met semi-regularly, starting with weekly meetings at the beginning of the project, and later spreading out to weekly or monthly meetings as the project got underway. Early meetings focused on identifying research areas and identifying the role of the IQP group in the greater greenhouse project, while later meetings focused on refining an ongoing design and budget for the greenhouse and growing system, and providing status updates. The project uses an email list for regular communication and update that included all the sponsors and IQP group members and advisors, as well as other interested parties.

I.iii.ii Understanding Aquaponic Greenhouse Systems and Evaluating Design Options

To develop a strong understanding of both aquaponics and greenhouses we consulted the relevant literature, considering both the technical and social aspects related to aquaponics. We investigated the biological characteristics of aquaponics system, and evaluated the benefits and drawbacks that it poses. We identified various components that would have to be used in an aquaponic system as well as in a greenhouse, and researched each of the components individually to best assess the benefits and drawbacks of each one. We also investigated the economic position of aquaponics and similar industries

in the United States (specifically hydroponics and aquaculture, the two “parts” of aquaponics). We consulted numerous academic and industrial journals, as well as studies conducted by educational and governmental institutions worldwide.

To further understand aquaponics, we read blogs of other people who built their own aquaponic systems. Many hobbyists and professionals are eager to share their progress and designs in building aquaponic system, and many of the components had do-it-yourself alternatives (such as water tanks) that were documented by enthusiasts online.

We also visited three greenhouses to get a feel for the designs and operations. We first visited a local Worcester greenhouse owned by Amanda Barker, and conducted an interview on how factors such as ventilation and internal layout affects the growth of plants. We also visited WPI’s own greenhouse on top of a campus building, it has automated heating systems and windows, which present some fatal flaws, such as heating the greenhouse up in the winter and opening the windows when the internal temperature heats a point, cooling the greenhouse again. The last visit was an aquaponic greenhouse in Holyoke, Massachusetts, during this visit we discussed insulation, the design, and interior layout of their aquaponic system to compare to ours.

To obtain further information on the design we interviewed Professor Alamo, a structural engineer, who provided the team with valuable information about the design of the roof, walls, and foundation of the building. When finalizing the greenhouse structural design contractors from JEMCO were presented with draft schematics and consulted for revisions and recommendations.

I.iii.iii Designing the Greenhouse System

The design of the greenhouse and aquaponic growing system was the major deliverable for the project. It entailed extensive research and planning. The major tasks we completed as part of the design were:

- Developing a structure and layout for a greenhouse
- Designing a modular aquaponic growing system
- Developing a budget for implementation of the entire system
- Creating an operating schedule

Using knowledge gained from our research and consultation with experts and practitioners, we developed and iterated our designs, going back-and-forth between designing and consulting with the sponsors, experts, and our research. Additional information about the greenhouse structure was found through intensive research on blogs, web stores, scientific journals, and research published by universities and institutions, as well as interviews with pertinent engineers and scientists in the field. To design the system itself we used CAD programs such as SolidWorks to develop schematics. These schematics also proved useful in communicating our designs with the sponsors and consultants.

In order to determine prices of pre-made materials such as pre-made water tanks and piping, local suppliers were surveyed. For pre-owned materials, such as 55-gallon drums and 1000L water tanks Craigslist (craigslist.com) and eBay (ebay.com) were surveyed in the local area. While these listing are temporary, they represent the rough actual price of locally sourced materials. A bill of quantities was made to keep track of all known and unknown quantities and costs. The bill of quantities along with the price quotes for the different materials were compared with the budget to ensure that all expenses were met.

With the complete startup cost and budget a logistical step by step process for operating the greenhouse was necessary for its longevity. The catalogs for currently established greenhouses and aquaponic greenhouses were researched and a preliminary schedule was synthesized. The initial schedule was then updated after a phone interview with Eric Varinje, a representative from Planet Natural. Planet Natural is a company that specializes in indoor organic growth, greenhouses and hydroponics. With the input from the sponsor (Worcester Roots) the specifics of the schedule, such as the timeframe for growing crops and selling fish were then created. The schedule was synthesized in an attempt to maximize productivity and increase the viability of the greenhouse.

I.iii.iv Building Out Prototype Aquaponic Growing System

One of the goals of the project was to build out a prototype aquaponic growing system for the sponsor. Technocopia and Worcester Roots together provided access to Technocopia's tools and workshop which was used as staging for building out the prototype system. The IQP group, with some assistance from Technocopia members, built the prototype system over 6 build days.

I.iv Findings

In our project we worked closely with the stakeholder to identify key research areas, and then investigated and found various possible solutions in three main areas: designing a greenhouse for the New England climate, designing an aquaponic growing system, and what running such a system would look like.

I.iv.i Stakeholder's Needs

Early on it was identified that the IQP group would focus on developing a design for a greenhouse structure and a prototype aquaponic growing system. For the system we identified the major criteria and constraints for the project: the design will need to function in cold winters and hot summers, so must be **energy efficient** to reduce costs as well as to encourage a green economy; the design should be **cost effective** so we must weigh the costs versus the benefits of different solutions to best fit our budget and limit waste; the design should be **sustainable**, using locally sourced materials to promote a local and green economy; the design should be **maintainable** and resistant to vandalism, so that ongoing costs are kept to a minimum; the design should **maximize food production**, as the goal of the project is to provide food, rather than other commodity crops; the design should **enable education**, to allow for ease of bringing in local high school students or tour groups to learn; the design should be **fit for local market demand**, similar to being sustainable, so that the system can be self-sustaining and can provide to the local demand; the design should be **scalable** so that our work and research can apply to larger future systems. As well, the design must be finished by the end of the WPI school year; the design must fit into the allotted space – a 20'x33' area behind the Stone Soup Community Center in Worcester; it must fit into the budget Worcester Roots has raised, roughly \$5500 for the growing system and roughly \$20000 for the greenhouse structure and site work; it must follow all city and state rules and regulations, including zoning, safety, and licenses.

I.iv.ii Design Considerations

I.iv.ii.i The External Greenhouse Structure

The first major component was the greenhouse structure that will be housing the aquaponic system. We needed a system that could survive the harsh New England climate, which drops plenty of snow and

drops below freezing in winter, and becomes very hot and humid in the summer, and would be easy to maintain.

I.iv.ii.i Greenhouse Frame

The frame of the greenhouse is what keeps the building in place. A well thought design is necessary to withstand the lateral forces of the wind and storms as well as the weight of the materials and potentially wet snow. It will also dictate what can or cannot go inside of the greenhouse as for the height and internal space.

The style of the frame considerably increases or decreases the cost of building a greenhouse. Each different shape dictates the materials used to build the frame as well as the paneling that will be used in the greenhouse. For example, if it is a hoop house, it will be hard to install rigid plastic or glass to cover the greenhouse. In New England, where we have harsh winters, the hoop house would need constant maintenance to remove the snow and fix soft coverings. The figure below show a few different shape styles.

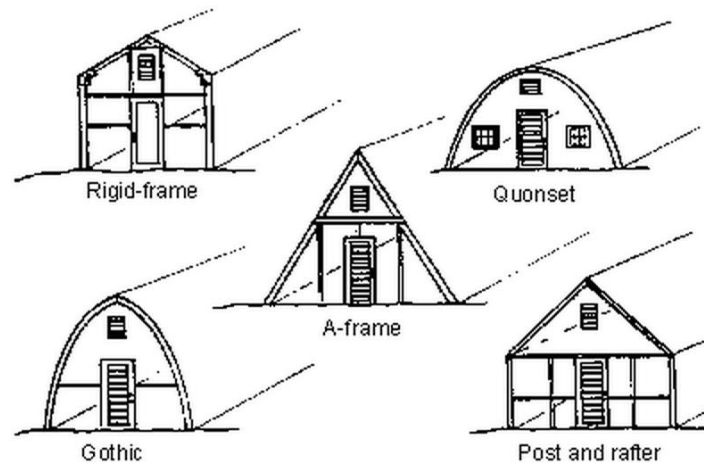

Figure 3. Possible greenhouses structure designs. Our final design uses the post-and-rafter style. (Acquired from <http://www.nafis.go.ke/vegetables/tomatoes/shapes-of-frames/>)

Due to the snow accumulation it would be necessary to have a steeper slant in the roof, and styles such as Gothic fare much better than Quonset or hoop style roofs which risk collapse. A style such as an A-frame provides excellent structure, but limits usable space. Rounded shapes also suffer from this space limitation, and also prevent usage of solid paneling, requiring a thin film be used instead. **For this project, we found that the post and rafter style would provide the best stability and space balance.**

After deciding the shape of the greenhouse, the choices for materials used are narrowed down to a hand full of materials. Therefore, we gave special attention to aluminum, steel, and wood. (Ross, n.d.) (Greenhouses, n.d.). The criteria considered were; cost, strength, location, and how much technical support was necessary to put it together.

I.iv.ii.i.ii Greenhouse Floor

The floor of greenhouses are normally dirt and fabric, but since this is an aquaponic system we need a strong floor to support tons of pounds of water without giving in. The first option which comes to mind is concrete, but it is actually one of the worst possible floors that there are for greenhouses, because the

floor has to be able to absorb water. Preventing the accumulation of water on the floor helps to ensure a clean environment and save time not having the extra work of mopping the floor all the time (Little Greenhouse).

I.iv.ii.i.iii Greenhouse Insulation

The idea behind insulation is to keep on side warmer than the other. A proper insulated structure can provide a significant save in the energy used for the heating and cooling the greenhouse. If the greenhouse is in a region where temperatures have a big variation during the year, insulation is a key part of the design in order to be able to keep the greenhouse running (John W. Bartok J. , 2007).

Ideally, every inch of the building should be insulated, starting from the ground, going all the way up to the roof. On the ground, the insulation is placed around the foundation of about one foot deep.

After the ground insulation is done we can build the greenhouse. In aquaponic greenhouses the plants grow in vegetable beds, which are a few feet higher that the ground, therefore, we can build the walls below the line of the plants out of a non-transparent materials and insulate as much as possible. There are many different types of insulation materials, like; foam, fiber glass, wool, and many more. When choosing the best material to use in the greenhouse, there are two main things to take in consideration, the R value and the cost. The R value should be the highest possible at a reasonable price.

For the transparent walls and roof, there are limitations on how much it can be insulated, normally the thicker the material the best it insulates, but it also loses light transparency with every inch of thickness. The key to choose the right material here is to scale the pros and cons of each individual material and choose the one that can best fit the greenhouse needs.

Another technic that can be used to conserve heat is the use of thermal blankets at night. Because the greenhouse loses most of its heat during the night, putting thermal blankets against the walls inside of the greenhouse prevents part of this heat from getting away (Roberts, Mears, Simpkins, & Cipolletti, 1981).

I.iv.ii.i.iv Greenhouse Ventilation

Ventilating the greenhouse is removing the air from inside of the greenhouse and replacing it with the outside air. The main purposes of ventilation in a greenhouse are: control the high temperature during the summer, to preserve the humidity at adequate levels during the winter, to provide a uniform air circulation in the entire greenhouse. (Dennis E . Buffington, n.d.) (Hopper, 2012).

The ventilation is important thought the year, it helps to regulate de temperature in the summer and to prevent moist, molds, and humidity in general during the winter. It is an indispensable piece of the greenhouse in order to have healthy vegetables and a strong structure.

A simple way to create a natural and cheap ventilation system is the use of doors, and windows on the roof. Following the rules of physics, hot air rises and escapes as new fresh air comes in. However, in general we found that ***fans would be necessary to provide the necessary air flow to regulate temperature effectively.***

I.iv.ii.i.v Greenhouse Heating

We found that to prevent frost during the winter and keep ambient temperature up, especially at night, a space heater would be strongly recommended. Our research show that in Worcester the

temperatures have a considerable variation throughout the year, according to NOAA, occurs in January and it is about 17 degrees Fahrenheit, which is well below our ideal temperature of 60 degrees Fahrenheit.

During the meeting with the sponsor we discussed about solar, electrical, gas and also firewood. The factor that played the biggest whole was the cost of each one of them. Besides the expensive heating equipment required to build each system, we also have to consider the month to month cost of each system. A very good practice in designing systems is to take in account and to calculate the worst case scenario in order to promote a more efficient and safe system.

Another option that was considered was to heat the water and to provide the optimal environment for the fishes, since they are the ones that require a warmer environment. If we choose to heat the water we would not need to heat the rest of the greenhouse because the water would serve as thermal masses, which store heat and keep its surroundings warm.

I.iv.ii.i.vi Greenhouse Internal Layout

We found that the internal layout may be regulated by OSHA and Worcester building code for wheelchair accessibility. As such, we found that **walkways would need to be a minimum of 3' wide**. As well, we identified that as the greenhouse would be used for educational purposes, the layout would have to allow bringing in tour groups that can easily traverse the greenhouse and see the grow beds, while also maximizing effective growing area. For this, **we found having walkways on all sides of the grow systems was effective**. We also found that for effective use of the greenhouse, the doors would need to be wide enough to bring large objects in and out, so **double doors were recommended**.

I.iv.ii.ii The Aquaponic Growing System

The major components of the aquaponic growing system are the fish tank and the plant growing bed, connected by piping and pumping. We investigated the ideal ratio between plant growing area and fish tank volume, and investigated different solutions for growing beds, fish tanks, and the plumbing to connect them.

I.iv.ii.ii.i Plant and Fish Ratio

Through our research we found that the ideal ratio for fish space and water space was 5-10 gallons of water for 1 square foot of growing area. Through our calculations we found that 1 pound of fish will produce enough waste to support roughly 1 square foot of growing area, which matched research conducted by aquaponic specialist Sylvia Bernstein, and Bernstein found in her research that 1 pound of fish generally requires 5-10 gallons of water to grow effectively (Bernstein, 2013). We used these numbers to inform our growing system design later on.

I.iv.ii.ii.ii Growing Bed

The structure must be carefully designed to ensure that the growing bed will be able to withstand the water that it contains. The structure must be made from materials that are readily available. Using non-standard materials can add complexity to the project. It is best to use materials that are both cost effective and widely available. **Inspired by existing designs, we found that building a bed out of plywood and lumber, with a pond liner, would be the cheapest and most fitting solution.** Also investigated were beds built by cutting 55-gallon drums in half, but we found that these were not ideal due to their unusual shape limiting plant growth at the edges and their small size requiring a significant number of barrels to be used in a larger scale system.

I.iv.ii.ii.iii Fish Tank

To find an ideal fish tank for our aquaponic system we investigated professional solutions advertised for hydroponic and aquaculture setups, looked at do-it-yourself projects for water tanks, and spoke with those that had experience with fish and hydroponics. Many hobbyists write up or record their aquaponics builds and upload them to the internet, which provided inspirations for our designs and initial research. The water tank needed to be easy to procure or create, sturdy enough to handle large volumes of water, and provide easy access to the fish. Ease of cleaning and water flow also impacted the tank design – rounded corners or a cylindrical or conical design would be self-cleaning, versus hard edges.

A 1000 liter intermediate bulk container (IBC) tote—a commonly available and used industrial water tank—was found to be the most effective solution for the primary fish tank for the modular system. It was compared against 55 gallon drums—another common type of industrial storage, a wooden tank design—a cheap design similar to our bed using plywood and reinforcement, and injection molded plastic tanks—large professionally made tanks. The IBC tote proved most cost effective, and was readily available in local sources. A plywood tank could potentially provide additional cost savings, but the additional labor involved was deemed not worth the marginal cost savings over the IBC tote. 55 gallon drums also could cost less than IBC totes for our system, but would require additional piping and pumps, and would increase overall complexity, so was ruled out. The injection molded tanks were the most expensive option, required shipping from out of state, and were unwieldy, so were ruled out.



Figure 4. The IBC Tote was recommended to be used as a fish tank

I.iv.ii.ii.iv Water Circulation

The aquaponic system requires that the water circulates constantly in the system. According to Dr. Nate of brightagrotech.com, a professional aquaponics website, it is recommended to circulate the water in the system every two hours. There is two ways that the water will flow: into the growing bed and the drainage. Since the growing beds will be higher in elevation than the water level in the tank we will need a mechanical pump to pump it up to the desired level. The return water will flow in the fish tanks by gravity. The factors to take in consideration while choosing a pump are the GPH rating of the pump and the static head. GPH is the amount in gallons that the pump can deliver in an hour and the static head is the maximum height the pump can deliver the water without losing pressure. Also we will need durable and safe pipes to connect the tank to the bed.

The system should have two drainage outlets with drainage pipes wide enough to sustain a large amount of water flow. One is for emergency, in case of overflow and the other will be for the everyday use. The incoming water pipe should flexible in order for the water to flow without obstruction in every angle.

We investigated three different types of pumps, the impeller pump – the most common type of water pump powered by a shaped rotor, the airlift pump – powered by blowing compressed air pushing an air/water mixture into a pipe and out of the system, and a peristaltic pump – a pump that isolates moving parts from the fluid commonly used in medical applications. ***We found that the traditional tried***

and true impeller pump would be best suited for use in an aquaponic system as they are readily available, recommended, and efficient.

I.v Proposed Aquaponic Greenhouse Design

When designing the greenhouse exterior structure and its various components we took in consideration the necessities of our sponsors as well as the challenges posed by our climate. The design provides the optimal environment for the biological systems and the good health of the structure while it maintains a good internal space to be used to as a working/teaching space. We discuss below the design, organized around the external greenhouse structure and growing system.

I.v.i The Greenhouse Structure

When designing the greenhouse exterior structure and its various components we took in consideration the necessities of our sponsors as well as the challenges posed by our climate. The design provides the optimal environment for the biological systems and the good health of the structure while it maintains a good internal space to be used to as a working/teaching space. We discuss below the design, organized around the external greenhouse structure and growing system.

I.v.i.i Greenhouse Frame

Because we wanted to maximize the internal space, especially vertically, we decided to use a post and rafter design, which has vertical walls and a high ceiling, it is a strong frame and also optimizes the internal space. The figure below is a design drawn by our group for the greenhouse.

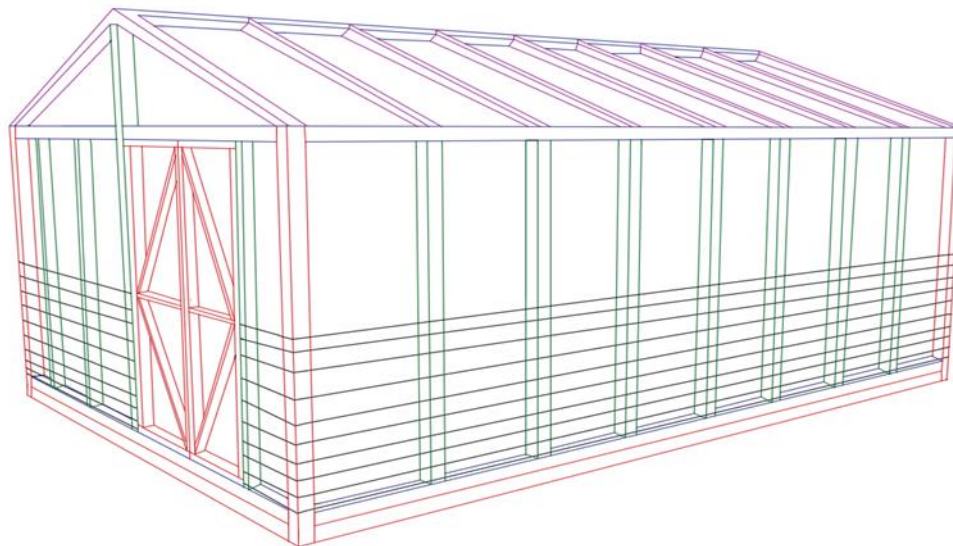

Figure 5. Greenhouse Design - Our design follows a post and rafter style, with insulation on the bottom 4ft. of the walls.

This frame design has the corners and the ground frame made out of pressure treated wood to prevent the wood from rotting. It also has half of all walls made of plywood to conserve heat and save on energy costs.

For the materials, the final decision was wood as the main material to build the frame because it was cheaper than other materials, it is strong, we can get it locally, and it requires minimum technical support to build the entire frame.

I.v.i.ii Greenhouse Floor

For the floor to be clean and effective we chose to use a combination of materials. First we will open the floor on the total area of the greenhouse when building the foundation of about one foot deep and fill it with crushed stone. The **crushed stone** will provide a firm foundation and also absorb all the spilled water, preventing any kind of water accumulations. Next we will install a **special greenhouse floor** on top of the crushed stone and under the walls of the building. This special floor and a resistant porous fabrics, which will also absorb the water. The combination of these materials will optimize the hygiene of the greenhouse and prevent weeds from growing inside of the building. They will also provide a firm and stable floor that will be comfortable enough to walk on, or wheel on.

I.v.i.iii Greenhouse Insulation

For the ground insulation we will use Extruded Polystyrene Foam, which is a rigid foam board that can resist high humidity. The Extruded Polystyrene Foam not only insulates the greenhouse but it also absorbs heat during the day and transforms the floor into a thermal mass, which provides heat at night, when most of the heat is lost. (Fratzel, n.d.)

The non-transparent walls we did a double skin of plywood filled fiber-glass in the middle. We chose this materials mostly because of the price and effectiveness, the plywood is easy to find, cheap and normally it is already pressure treated. As for the fiber glass, it is one of the cheapest insulating material and we can achieve basically any R value with it.

As for the transparent part of the walls and ceiling we used Solexx, which is a rigid, milky plastic panel with multiple layers. Because this material has multiple layers, it traps air in the middle of each layer, and air is a great insulator (John W. Bartok J. , 2007).

I.v.i.iv Greenhouse Ventilation

Through calculations on the volume of the greenhouse and the amount of air change that is ideal for the greenhouse we arrived to 1600cfm (cubic feet per min) which is a hard number to achieve with only one fan. After talking to a few greenhouse owners, **we decided to use two industrial fans of 800cfm** in the opposite sides of the greenhouse horizontally positioned. This set up creates a circular air movement that provides uniform air through the entire greenhouse.

I.v.i.v Greenhouse Heating

To better approach our heating needs, we calculated the exposed surface area, which was 1760 square feet, and combined it with the heat loss coefficient of the materials used. From our calculations we conclude **that the greenhouse would need a heating power of 12kW**. In order to achieve this amount, we chose to use two heaters about a feet above the ground in the opposite sides of the building in order to distribute a uniform wave of heat throughout the greenhouse.

Also, from the calculations we came up with an approximate temperature that would be good for the fishes and plants at the same time. The temperature is around 60 degrees Fahrenheit, which achieves the maximum efficiency related to the cost of heating, plant growth and fish wellness.

In this project the sponsors required the electricity to be the primary source of energy for the heater, this decision was made because of the convenience of using the already existing grid and also because startup cost is a fraction of the cost of the other heating mechanisms.

I.v.i.vi Greenhouse Internal Layout

Growing beds were designed using the Solid Works program and the design for the tanks were researched to see what shapes would accommodate the best circulation of water. The length of the walkways and the width of the door were cross referenced with building codes and other designs to see that they had both functionality and comfort for the users of the greenhouse.

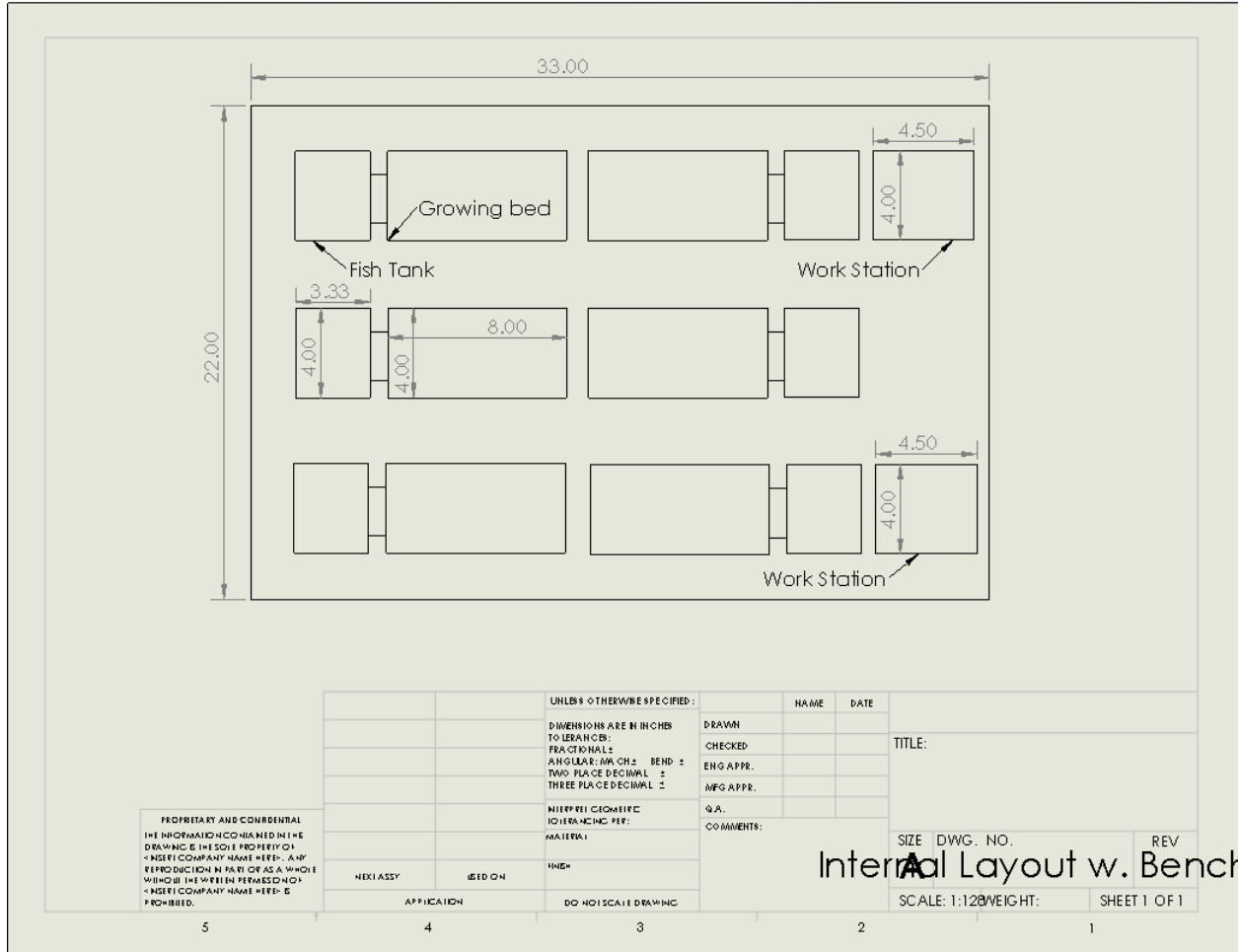

Figure 6. Internal Layout for 22'x33' Greenhouse

I.v.ii The Aquaponic Growing System

When designing the growing system we set out to create a simple, modular, self-contained growing system. The size of the bed was fit to the amount of growing area a single 275 gallon IBC tote could support. The bed has 32 sq. ft. of growing space, which calls for 160 to 320 gallons of water. The bed and stand are made from locally available materials, and can be assembled easily.

I.v.ii.i Growing Bed and Stand

The growing bed is comprised out of wood. It serves as the area that the plants grow. The growing bed is going to be completely filled with water, so it needs to be strong enough to withstand the force of the water that is in it. The base is made out of a 4x8 foot piece of plywood. The walls will also be cut out of a similar piece, but it will be 8 ft. x 1 ft. and 4 ft. x 1 ft. These sections need to be reinforced so that it won't break when it is filled with water. It is reinforced with 2x4s along the top of the bed. There are

also vertical supports that are connected to the horizontal supports. The bed is lined with a pond liner so that the wood won't be damaged.

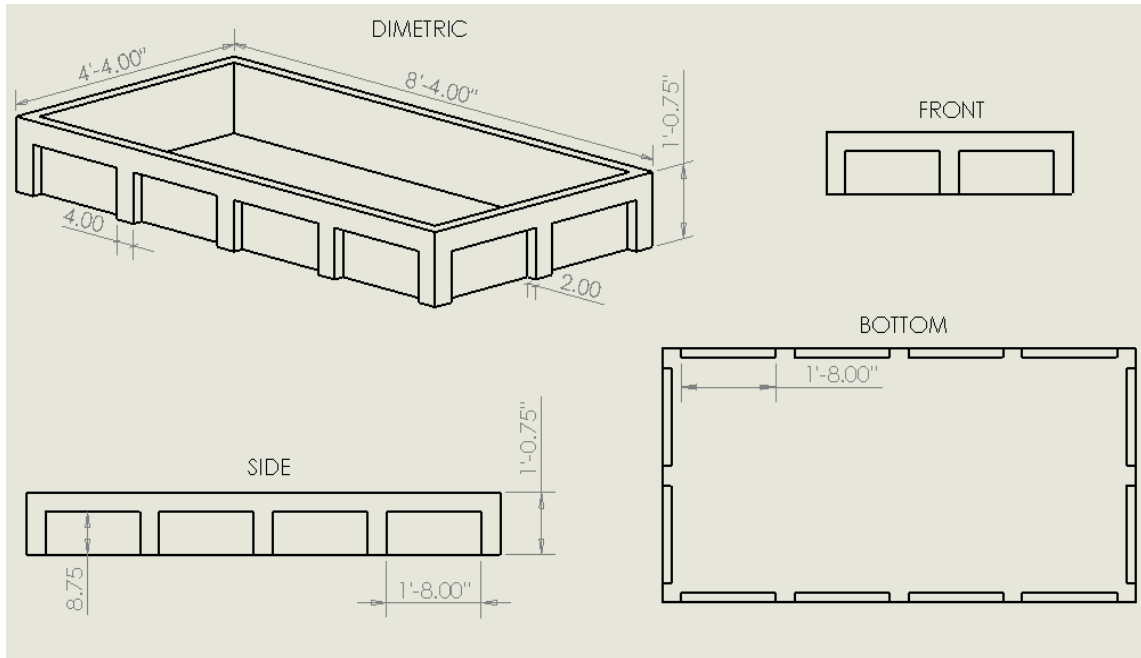

Figure 7. Schematic for Growing Bed. Sized to be general purpose growing bed.

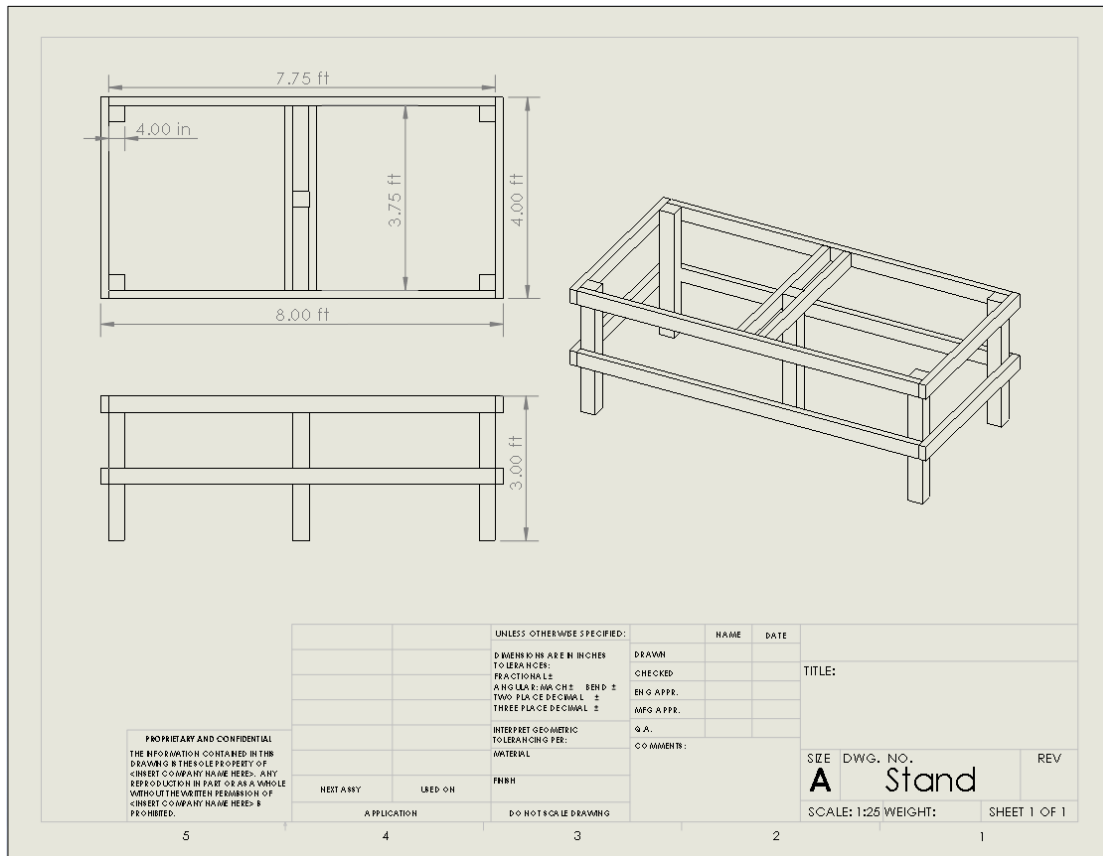

Figure 8. Schematic for bed stand.

The growing bed stand serves to both elevate and support the growing bed that is on top of it. It is made out of lumber because it is strong and inexpensive compared to steel or aluminum. The legs are 3 feet tall. There are five feet. Four of the feet are on the corners of the stand, and the fifth is on the center for added support on the base. The legs are held in place with 2x4s. There are also 2x4 supports for added stability on the bottom half of the outer legs. This design is quite simple, but it is strong enough to support the weight of a growing bed that is completely filled with water.

1.v.ii.ii Fish Tank and Water Circulation

For a fish tank we used a 275 gallon IBC Tote as we recommended previously, and designed a plumbing system to accommodate the tank and the bed. After doing a wide research on the methods for water flowing we concluded that the best material to build the piping system is PVC. We chose a Hydrofarm AAPW1000 submersible pump for our system as it provides the necessary flow rate and water pressure, and can be adjusted easily.

The pump will be connected with a ¾" PVC pipe that will go directly to the growing bed. For the drainage we choose to use two siphons. The automatic bell siphon as primary and the S-shaped siphon as a secondary. The bed also has a 1-inch diameter pipe siphon from Desert Aquaponics that will keep the water 8 inches height at all times in the growing bed. This type of siphon will drain the whole water of the tank when the level reaches the predefined level. The same principle is used with the S-shaped siphon, but in this case we used a 2-inch in diameter pipe to achieve a larger amount of drainage in case of extreme emergencies, this pipe has a shower drain on it and a mechanical filter to prevent the pipe

from clogging. All the connections will be attached and reinforced with PVC cement. It is also recommend that the drainage outlets and incoming water be installed in the opposite sides of the bed to promote better water flowing throughout. The piping concept is shown in Figure 9.

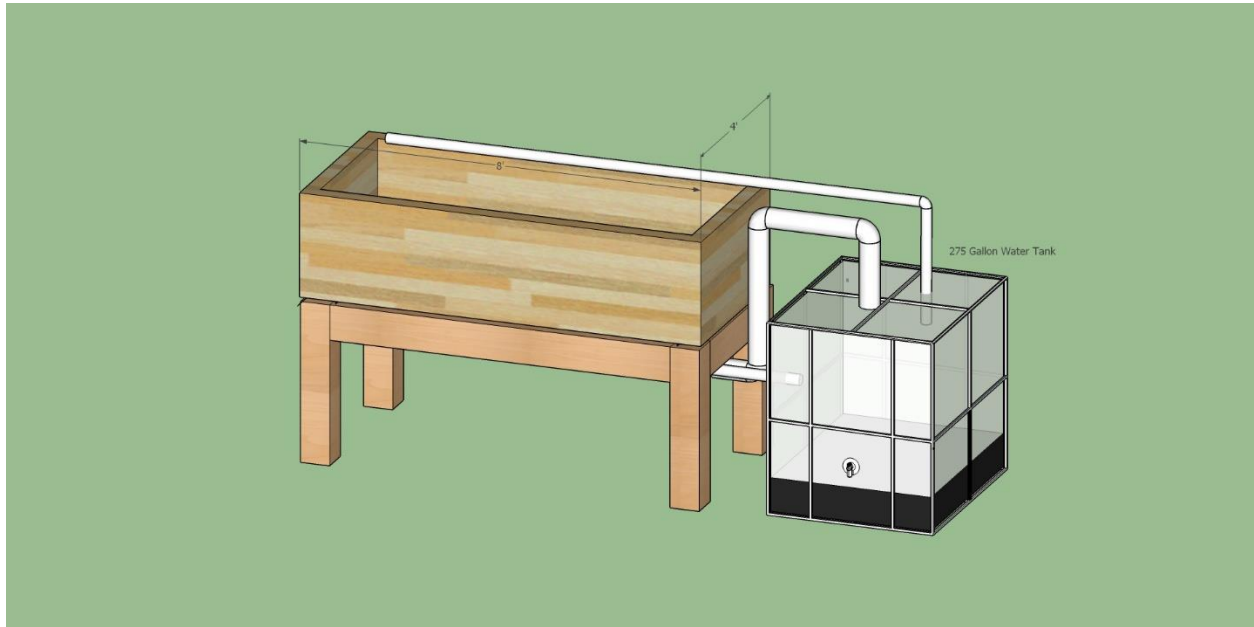

Figure 9. Full System Layout, incl. plumbing. The bed has two drains, a bell siphon and a larger emergency drain to prevent over-filling. One tube extends from the fish tank to provide water into the bed.

I.v.iii Operating Schedule

Aquaponic Greenhouses require an ambient temperature of approximately 70F to support the ecosystem present. The conditions presented by the weather in New England are very challenging with the average low in the months of January and February being below 20F. The following table is a tentative schedule that attempts to maximize profitability of the green house. An organized schedule of the greenhouse is important for maintenance and will also help to educate others about the difficulties faced in managing an eco-system in this cold climate region.

Month		Additional Comments
January	"Sales of Winter Crops"	-High Cost of Heating -Lack of Natural Sunlight -Plants will include lettuce and leafy vegetables
February	Prepare seedling beds	-High Cost of Heating -Lack of Natural Sunlight
March (Assume we start the greenhouse at this month)	Begin Planting Seedlings Stock Fish	-Risk of Frost still Present (Very Dangerous to Seedlings) -Seedlings take 6-8 weeks to mature -Fish take approximately three months to mature
April	Preliminary Sales of Seedlings to Local Markets	-Major Source of Income for Greenhouse

May	Preliminary Sales of Mature Plants to Local Markets	
June	Preliminary Sales of Mature Fish Planting of "Warm Climate"	-Sales begin after Fish have had time to replenish These plants do well in Temperatures over 60F
July		
August	Sales of Warm Climate Plants	
September	Planting of "Cool Climate" Plants	These plants do well in temperatures 40-50 F
October		
November		
December	Fully automate the heating for the winter months to come. Planting of "Winter" crop Sales of Cool Climate crops	-Plants are at great risk for frost, adequate heat is needed to preserve fish as well.

Figure 10 : Tentative Operating Schedule of Greenhouse

I.v.iv The Prototype Aquaponic System

The team designated several build days in order to facilitate the testing of the prototype. The prototype featured a one foot deep growing bed of dimensions 4' by 8', a 3' deep fish tank as well as a 3' stand capable of supporting the weight of the growing bed.



Figure 11. Constructed Prototype. Left: Fish Tank; Right: Bed & Stand. Piping has not been cemented yet.

The purpose of building the prototype provides a testing platform for our system and allowed us to work out the fine details of construction. There are a few additions that still need to be made to the prototype system for completion. The team has yet to implement the plumbing and drainage system, we have made the appropriate cuts for these fixtures but we have not permanently cemented them in place as the aquaponic system will need to be moved off site to the greenhouse's location. The prototype aquaponic system will be moved on site to Worcester Roots after the completion of the project.

I.vi Conclusion and Recommendations

The team successfully created a greenhouse design to enable efficient year round operation. This design provides a solid starting point for prospective aquaponic greenhouse builders, even if their specific requirements are different from that of Worcester Roots. Although ultimately our design was not constructed due to a generous donation of an existing greenhouse, the design provides a solid foundation for future constructions, and informs any possible modifications Worcester Roots may want to make to the donated greenhouse.

The team also created a design for a modular, easily replicable aquaponic growing system. The design was successfully built as a prototype of the system which includes a growing bed, a stand for the

growing bed and a fish tank. We also synthesized a month by month working schedule which highlighted key growing seasons for plants and suggested the optimal year round operation considering the climate.

Below there are a few recommendations the team made for future improvements and alterations in the greenhouse.

For immediate consideration **we recommend investigating installing in extruded polystyrene foam insulation along the perimeter of the donated greenhouse** as it will provide essential insulation for the ground in the winter months. The insulated ground will stay at a higher temperature and buffer out cold from frozen ground around it.

For a more effective insulation **we recommend the installation of thermal blankets**. The thermal blankets are placed against the walls at night helping to conserve heat inside the greenhouse.

We recommend the Stone Soup Community Center investigate installation of a solar electric generation system for providing power to the building and the greenhouse which is planned to be wired in. This would aid to achieving self-sustainability for the building and the greenhouse.

We strongly recommend warehouse style growing designs investigate solar water heaters as they can provide hot water significantly more efficiently than electric heaters (which would be required if using solar PV).

We recommend investigating an automated ventilation system to regulate the temperature and humidity. Extreme temperature and humidity threatens the plant life in the greenhouse as well as the components in the greenhouse, and while manual operation is feasible, automated systems limit human error and provide easier operation.

We recommend investigating an alternative bed design focusing on shallower, stacked vertical beds, as opposite to a single larger bed, this style would enable higher growing density. A potential draw back to this is that it would require artificial lighting and would not be able to utilize the natural lighting of the greenhouse, but it would work well in an indoors environment and particularly could be suited for dense seedling production, as seedlings do not require deep beds.

For artificial lighting **we recommend investigating LED grow lights utilizing optimal wavelengths** as was brought up by Technocopia as it may provide efficient and effective grow lights in a situation without natural light such as a warehouse.

As for the team's expectations, in the short term, we expect to get the community of Main South in Worcester more involved with the greenhouse. This pilot will have the opportunity to educate the youth as well as anyone that is interested on the pathway for urban food production.

By empowering local residents, the project aims to provide a healthy, local food source for Worcester residents, and educate members and local youth about greenhouse growing, aquaponics, and the cooperative businesses.

As for the long term goes we are being more ambitious, we expect to help creating the idea of urban farming, by demonstrating that small systems can provide an entire diet, with fish, fruits, and vegetables. We also hope that this project will have a positive impact on entrepreneurs, to scale up this

system, as well as anyone who wants to scale down the project and have a self-sustaining aquaponic greenhouse on their backyard.

Chapter 1 Introduction

Access to fresh, healthy, and affordable food is a fundamental requirement for healthy living. As of 2013 in the United States 38.9% of low-income households and 14.3% of all households were considered “food insecure” – meaning they did not have access to enough food for “active, healthy living” (Alisha Coleman-Jensen C. G., 2014; Alisha Coleman-Jensen C. G., 2014). One of the manifestations of food insecurity are *food deserts* – communities that have limited access to supermarkets or grocery stores that often rely on fast food and convenience stores with a lack of healthy affordable food (USDA AMS, n.d.). In particular, access to supermarkets and large grocery stores trends to healthier food intakes, and access to fast food restaurants trends to unhealthier food intakes (Michele Ver Ploeg, 2009). In the United States 2.2% of households live more than a mile from a supermarket and do not have access to a vehicle, and 3.2% of all households live between ½ and 1 mi from a supermarket and do not have access to a vehicle (Michele Ver Ploeg, 2009). An estimated 4.1% of the total US population is both low-income and lives more than 1 mile from a supermarket (Michele Ver Ploeg, 2009). Urban areas with limited food access are generally characterized by higher levels of racial segregation and income inequality, as well as insufficient infrastructure (Michele Ver Ploeg, 2009). Food deserts have been linked to obesity (White House Task Force on Childhood Obesity, 2010), among other problems.

The USDA has a variety of programs aimed to assist those in food deserts, including aiding farmers markets to accept EBT (electronic benefits transfer), promoting new local farmers, and creating regional “food hubs” (USDA - Agricultural Marketing Service, n.d.). These programs encourage new “green” jobs and increase food access in the targeted areas. Food hubs are regional programs that offer “production, aggregation, distribution, and marketing services” to allow for producers to gain entry to new markets that are difficult to access on their own, and the USDA believes that they “offer strong and sound infrastructure support (...) which will also help build a stronger regional food system” (USDA - Agricultural Marketing Service, n.d.). As well, to help food deserts the White House Task Force on Childhood Obesity has recommended that local governments “create incentives to attract supermarkets and grocery stores to underserved neighborhoods and improve transportation routes to healthy food retailers,” and provide incentives to “increase production of healthy foods such as fruits, vegetables, and whole grains, as well as create greater access to local and healthy food for consumers.” (White House Task Force on Childhood Obesity, 2010).

Cities are becoming increasingly concerned with how food relates to the urban environment and are encouraging the development of “sustainable food systems” that contribute to high quality neighborhoods, meet the health and nutrition needs of residents, and promote environmental sustainability (Koc, 1999). Food deserts and food insecurity are all signs of unsustainable food systems. A community that does not have ready access to supermarkets nor is able supply itself with fresh food cannot sustain its inhabitants. According to the data stipulated by the USDA, there are about five of these communities here in Worcester, one of these communities is Main South. In an attempt to address the problem of the food desert in Main South, a local non-profit organization, Worcester Roots has decided to design and build a greenhouse capable of providing fresh and affordable food to the residents of the community, with the goal of providing a starting point to encourage and educate the Worcester community about the ideals and promises of urban growing.

There are several aspects regarding the community that are of concern to Worcester Roots. It is interesting to note 80% of public school children meet the requirement for a free lunch at school, this

means that these parents have a low income and may struggle to find healthy food (Castro, s.d.). Many do not have easy access to facilities that sell food. Many do not have a means of transportation to get to areas that sell food. The goal of Worcester Roots was to address all of these issues. Worcester Roots felt that a greenhouse would be a good addition to the community.

Worcester Roots is located in an area that is not too affluent, seeing that they are serving the people in this area. Worcester Roots does not currently have a sustainable means of offering food to the community. The sponsor believes that a greenhouse may be a possible solution to the current situation in Worcester. A greenhouse, if established correctly, can be both sustainable and beneficial to an area such as the food desert of Worcester. It not only is the food that would result from the greenhouse, but the sense of community and education could be improved by the operation of a greenhouse. It could bring the community closer in working together to eradicate poverty and hunger from this region. It by no means is a greenhouse the ultimate solution for the issue, but it certainly can greatly improve the living condition of the individuals that live in Worcester and the situation of not having many reliable sources for food.

The aim of this project is to provide a testing ground for urban food production in Worcester and to promote and educate about urban food production. The greenhouse will be used to grow seedlings that locals can grow, and will also be capable of growing full plants, and will be set up so it can provide an educational experience for local youth and interested community members wishing to learn about aquaponic food production as well as about worker cooperative businesses. The fully functional greenhouse will operate during the whole year, being ran by Worcester Roots and volunteered members of the community, who will be involved in the growing, selling, and managing the greenhouse. In our research we analyzed suitable fish for cold weather, the most convenient fish tanks and vegetable beds, the interior layout design in order to optimize food production as well as working and teaching space and also more general aspects, like market research and comparison between different kinds of materials.

The research will be open source, anyone can access, modify and reproduce the designs. This will provide the community with the information on how to analyze, consider, and choose between the different aspects of a greenhouse that would best fit their individual needs for free. In addition to this Worcester Roots will be hosting workshops and events to promote worker empowerment, in order to motivate the community to get involved in this greenhouse, and to help people use this information and expand the idea of growing food in urban areas and minimize the main issues of food deserts. Worcester Roots has a great initiative to solve one of the greatest issues there will ever be. How to feed everybody. And this project will provide people with small and simple solutions to this problem, not only providing the community with food, but also teaching them how to do it on their own.

Chapter 2 Background

In this chapter, we will introduce the concepts of urban food production and the worker cooperative movement and the relationship between the two and our project and our sponsoring organizations. We will first look at urban food production and how it can be used to improve urban communities, and then explore the role that aquaponics can play. Then, we will look at how this is going to be applied in Worcester with our project sponsors, and explore the possibilities and considerations needed for designing an urban aquaponic system, from designing a structure that can withstand the harsh winters, to designing a robust and capable aquaponic growing system.

2.1 Food Security and Urban Food Production

2.1.1 Urban Food Production

Food has historically been grown in rural areas in large fields. In the United States, the majority of food is grown in the Midwest (Hatfield, 2012). Getting this food to urban areas requires shipping the food long distances, which is an added cost to the food, and also limits how fresh the food can be. Urban food production and the concept of regional food hubs has the potential to reduce the waste from all the fuel used transporting food from far away food production centers to urban areas (POLLAN, 2008).

2.1.1.1 Food Deserts and Food Security

Many low income or low access urban area families are limited in what they can buy to what is within walking distance. This restriction on food can create *food deserts* – areas without “ready access to fresh, healthy, and affordable food” (USDA, n.d.). Instead of fresh food, these areas often have only fast food restaurants and convenience stores, which can lead to health problems in the area (USDA, n.d.).

A food desert is defined as a tract that is “low-income” – a 20+% poverty rate, or a median family income 80% or lower than the surrounding area – and “low-access” – at least 500 people and/or 33% of the population lives more than 1 mile from a supermarket or large grocery store (in urban areas). As of 2010 In Worcester, Mass, there were 13 US Census tracts qualifying as “food deserts” (USDA). Figure 12 shows food deserts designated by the USDA in Worcester. Areas marked in green have limited access within 1 mile, and areas in orange within ½ mile.

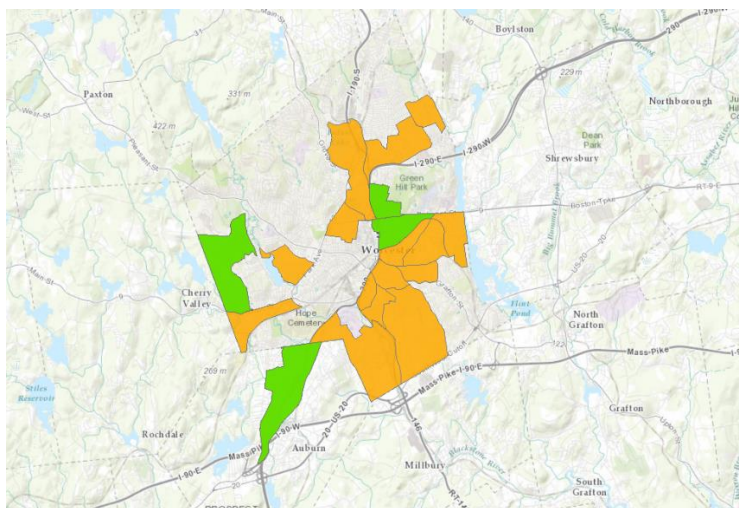

Figure 12. Food Deserts in Worcester (Green limited supermarkets within 1 mile, Orange within ½ mile) (Acquired from United States Department of Agriculture at <http://www.ers.usda.gov/data/fooddesert>)

A study called “Fast Food Restaurant and Food Stores” tested more than 5000 adults from the age 18 to 30 in different states. The study concluded that a) People consumed fast food because it was more accessible and closer to their homes. This was noticeable in men with low-income and in situations where the restaurant was located within 1 to 3 km from home but this trend was not applicable to women. b) Being close to the grocery stores and supermarkets did not make any impact on the type of diet and healthy nutrition c) on average men of every background ate fast foods 2 times per week and women 1.6 times. The authors conclude that by “promoting greater access to supermarkets, several U.S. policies aim to improve diets through provision of affordable healthful foods, particularly fresh produce in underserved areas. Our findings do not support this initiative in young to middle-aged adults. Rather, they suggest that adding neighborhood supermarkets may have little benefit to diet quality across the income spectrum and that alternative policy options such as targeting specific foods or shifting food costs (subsidization or taxation) should be further considered” (Larsen, 2011).

A study conducted in 2009 (Smith & Morton, 2009) also gave some clear differences in health, access to food and social environment between the rural and urban areas. The study found out that the people in rural areas with more restricted access to fresh food markets were less healthy with 12% of them reported their health as poor or fair, where in urban areas that had ready access to food the percentage was only 9%. Similarly, urban food deserts where markets are unreachable may suffer from similar problems. Also most of the people very skeptic about food quality in their communities. The authors concluded that beside the personal preferences the social and environmental factors that limit the healthy food access (Smith & Morton, 2009). Another study made in 2010 finds a relation between the distances of the supermarkets with overall health. (DataHaven, 2010) That was more significant in elderly people where the lack of healthy food can cause other more serious problems. For them that are underweight suffer from low nutrition the consequences are longer hospitalization, early, heart disease, diabetes admittance in nursing homes and increased mortality (Martin, Kayser-Jones, Stotts, Porter, & Froelicher, 2006).

2.1.1.2 The Role of Worker Cooperatives in Urban Food Production

Part of what defines a food desert is that the area is low-income. Worker cooperatives have recently been looked at as a way for low-income workers to be a part of a fair democratic business. In the United States multiple not-for-profit organizations have started up (including Worcester Roots) that aim to promote Worker Cooperatives as a means of worker and economic justice. This is the Worker Cooperative Movement.

A worker cooperative is a business that is owned and controlled by its members, who work in them (US Federation of Worker Cooperatives, n.d.). They value “self-help, self-responsibility, democracy, equality, equity, and solidarity” (US Federation of Worker Cooperatives, n.d.). In Massachusetts, to be considered a Cooperative Corporation, among other things, members of the corporation must be employees, members of the corporation all own exactly one “member share” (as opposed to owning varying numbers of shares based on investment), and these “member shares” are the only capital stock that give voting power. Members must be issued a membership fee, and net earnings must be distributed according to patronage, or the amount of work put into the cooperative (Employee Cooperative Corporations).

One of the most important driving forces behind the worker cooperative movement is the goal of empowering the working class, to escape the economic hardships and to promote worker equality. In

the context of skyrocketing wage differences between executives and workers, with the minimum wage trending lower and lower when adjusting for inflation, the idea of a business owned by its workers, sharing its profits among its workers is very appealing to those with disadvantaged economic status (US Department of Labor, 2012; Davis, 2014).

The US Federation of Worker Cooperatives has published a list of principles for worker cooperatives and the cooperative movement (US Federation of Worker Cooperatives, n.d.). The goal of the federation is to empower cooperatives and promote coexistence in which all members can benefit from working together.

2.1.2 Food Production in and around Worcester

In the last decade urban farming systems have experienced great success due to the innovation and the novel farming methods introduced in these areas. Given the dynamic and challenging urban conditions, innovation support to urban producers should focus strongly on building their problem-solving capacities (Critchley W, 2007). Worcester sustains three Saturday farmers markets during the summer and one throughout the winter. The Regional Environmental Council (REC) runs farmers markets six days a week. Steve Fisher, executive director of the REC has confirmed the importance of this urban agricultural growth "We are at a moment where cities like Worcester are identifying that the agricultural sector is a serious part of the economy. It can have so many benefits, for the economy, for health and for the urban environment" (Critchley W, 2007).

The table below shows the increasing trend seen in agriculture in the Worcester County area. The statistics show that a 0.64% increase in the number of farms in the Worcester county over the five year period. The average farm size also increased by an acre, the market value of all agricultural products has experienced a slight increase, this shows that the agricultural sector has experienced steady growth in the last five years.



Figure 13. Agriculture in Worcester County

As well, in the City of Worcester agriculture has been growing, with the Regional Environment Council (REC) providing support for community gardens, and even urban community farms like Nuestro Huerto opening up.

2.2 Aquaponics as an Approach to Urban Food Production

Aquaponics is a bio-integrated food system which allows for the production of both plants and animals for consumption. Aquaponics can be defined as the integration of hydroponics and aquaculture. Plants

situated on water beds are grown with aquatic life, usually fish. The intricate design allows for the waste products of one biological system to serve as nutrients for another (Wahl, 2010).

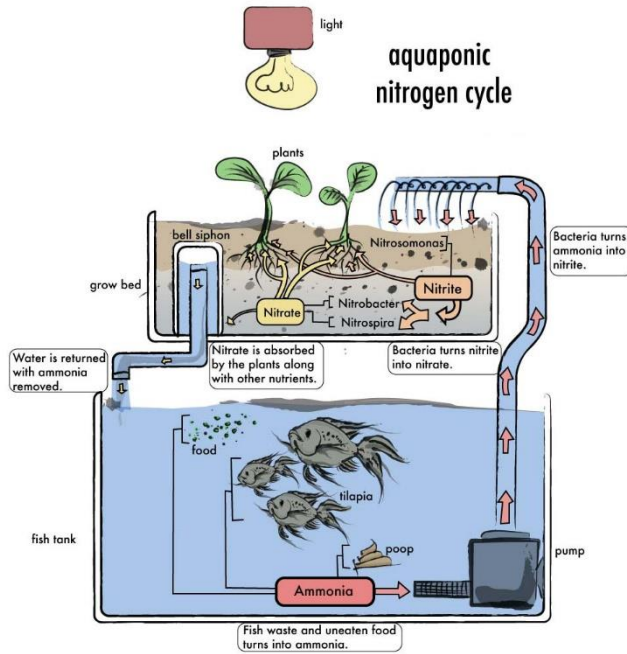

Figure 14. The Aquaponic Cycle (Acquired from Worcester Roots <http://www.worcesterroots.org/projects-and-programs/youth-in-charge/>)

In aquaponics water is reused through biological filtration and recirculation, this makes it a very sustainable way for producing food. Since the fish and plants are grown together the diversity of the biological environment allows for a great deal of biological exchange inside the system. The waste from the fish, algae and bacteria would build up inside the tanks, and compromise the fish, however, this waste is used to serve as fertilizer to the hydroponically grown plants. These plants are grown on a hydroponic bed, which not only acts as an anchor for the plants but also as a filter, which rids the water of ammonia, nitrates and phosphorous so that filtered water can be circulated back into the tanks. The plants themselves have nitrifying bacteria in their roots, they are essential in converting atmospheric inert nitrogen to a more reactive form, nitrates, which are then used to by the plants and enable the nutrient cycling between the hydroponic system and the aquaculture.

Hydroponics is a way of growing plants without soil, instead growing plants directly in water, or in a growing medium such as fine rocks. Since water is the medium for plant growth, only nutrients that are soluble in water will be absorbed by the plant. Most minerals used by plants are soluble in water, these include calcium, phosphates and magnesium. (Mugundhan, 2011) Very precise concentrations of these minerals are dissolved in water, and carefully maintained, this allows for the most optimum growth of the plant and when this is coupled with lighting effect from the greenhouse design, the yield from plants grown this way is extremely high. The combination of hydroponically grown plants inside a biologically integrated system linked to aquatic culture of fish is a very intricate process that allows for the sustainable production of food.

2.2.1 Biological & Nutrient Cycles in Aquaponic Systems

Hydroponics as well as the fauna associated inside the greenhouse is used to facilitate many intricate biological cycles. One of the major cycles associated with the aquaponic environment is the Nitrogen cycle. Nitrogen makes up 78% of the air we breathe in, however neither plants nor animals can make use of nitrogen in this form (Mary S. Booth, 2005). Instead they depend on a process known as nitrogen fixation. The key components in this process are nitrogen fixing bacteria that live in the root nodules of plants. Both the plants and bacteria benefit from this mutualistic symbiosis. The Plant provides a niche for the bacteria to thrive and grow, while the bacteria converts atmospheric nitrogen into ammonia which can be absorbed by the plant. Other bacterial species such as Nitrosomonas can convert ammonia into nitrates, these nitrates are also useful to the plants which help them to photosynthesize food. If the nitrate concentration of the plant grow medium is too high, eutrophication will occur and decrease the oxygen content of the aquatic environment, this is very dangerous to the marine life inside the aquaponic system, however fungi and microaquatic organisms convert the excess nitrates in the water back to atmospheric nitrogen. (Carpenter, 2005)

The involvement of these bacterial species as well as this cycle points to the importance in the homeostasis of aquaponic systems. The nitrogen cycle is one of the main drivers of nutrient recycling inside the aquaponic environment. Waste product from the fish naturally contains Methane, Ammonia, and Nitrates. Ammonia and especially the nitrates in this waste can be used as an ecofriendly way of fertilizing plants, since nitrates form a large part of the raw materials used for photosynthesis. The other main material for the plants is carbon dioxide, and like nitrogen it is cycled in the environment. The aquatic life inside the greenhouse uses dissolved oxygen in the water to generate energy to live, this process called respiration gives off carbon dioxide as a waste product. The plants then utilize the carbon dioxide to begin their process of photosynthesis, which provides food for themselves and releases oxygen to be used by the fish and restart the cycle. (Bronstein, 1995)

2.2.2 Benefits of Aquaponics

Aquaponics recycles a lot of the raw materials put into the system and makes the process very efficient. Aquaponics uses 90% less water than traditional farming, while simultaneously producing on average six times more yield per square foot than traditional farming (Marklin, 2013). This is partly due to the interior homeostasis that allows production in any type of climate zone, during any time of the year. Deserts or Tundra regions will have no effect on the plant and animal growth if the correct internal parameters, such as lighting and heat are maintained inside the greenhouse (Marklin, 2013). Plant growth is also drastically increased as the threat of pest is reduced as plants are grown indoors, and the water is naturally fortified by the fish. The lighting also plays a very important role in the growth efficiency as they are hung vertically and used to simultaneously grow two areas of plants as opposed to one area. (Jason, 2012)

In addition to these farming benefits there are also environmental benefits to using aquaponics. Since the process is regulated and the waste material is cycled, there is no harmful fertilizer run off into and water sources such as water sheds and rivers. This greatly reduces the instances of water pollution that arises as a misuse of fertilizers, this causes great damage to the aquatic life in these water bodies. (Jim, 2009) All energy used in aquaponics is electrical, this means that alternative forms of energy such as: wind, solar and even hydroelectric can be used to power the green house. (Price, 2009). As a result there is greater energy conservation and the use of these clean energy greatly reduces the instances of air pollution. Conventional commercial farming uses large machinery that generate large amounts of

carbon monoxide which is dangerous to the atmosphere, with aquaponics however these large machines are not required and air pollution is drastically reduced.

There are also health benefits associated with aquaponics. The fertilizer used to nourish the plants comes from cold blooded fish that do not carry the harmful E. coli or Salmonella, these two bacteria especially the latter are frequently known to cause food poisoning if consumed. (K., 2012) The fish inside these aquaponic systems are not subjected to any growth hormones, are not contaminated by mercury, do not have antibiotics and do not have PCB which is a synthetic organic compound that has been linked with cancer. (EPA) Fish and plants grown through aquaponics are therefore healthier for human consumption, and will taste better as the produce will usually not be shipped outside of the community be stored for extended periods of time.

2.2.3 How common is Aquaponics in the United States and the North East?

Statistics from the United States Department show that in Organic foods account for over 4% of total U.S. food sales, and all food from aquaponics is classified as organic. While there is no statistical data for aquaponics specifically, we can infer that as an emerging technology it represents a small niche within the organic foods figure. The USDA reports that aquaponics has seen an "increase, but not substantial increase" in the organic market. Aquaponics is receiving a lot of attention as it not only helps to produce food but it also aids in the integration of communities in the USA (Harris). While Commercial Farming is still the main source of food produce in the United States, there has been an increase in the interest and the practice of aquaponics, as there is now a shortage of arable land for cultivation.

Numerous articles have surfaced which show that even here in New England, a geographic area plagued by bitterly cold winters is able to facilitate these aquaponic greenhouses, through careful planning and managing of the internal environment. As well, there are examples of greenhouses running in cold environments such as Growing Power in Milwaukee. If this trend continues the overall contribution of aquaponics to the total US food sales will be greatly increased in the years to come.

2.2.4 Markets in the United States

There is no industry benchmark for an "aquaponics" industry, however understanding markets for two similar industries that represent the two parts of aquaponics – hydroponics and aquaculture – can help inform of an assessment of the aquaponics industry.

2.2.4.1 The Hydroponics Industry

Hydroponics is the practice of growing plants without soil, in growing media or just in water. The hydroponics industry in the United States is growing, with an annual growth rate averaging 3.6% from 2008-2013, and a projected annual growth rate of 3.0% for 2013-2018. The most common market for the hydroponics industry in the United States is the demand for fruit and vegetables, with tomatoes, cucumbers, and bell peppers collectively accounting for 6.8% of the product. Other crops commonly grown include eggplant, squash, and lettuce, and some varieties of fruits. Herbs and spices also are produced. The most common retail markets for the hydroponics industry are fresh food markets and grocery stores, holding 35.5% and 30.3% of the market each. About 12% of the demand is food service providers (mainly restaurants). Direct-to-consumer accounted for 9.4% of sales, and the last 12.6% were other smaller categories, including selling to wholesalers, schools, and government facilities. IBISWorld in *IBISWorld Industry Report OD4012* describes the market: "Hydroponic farms are generally small and find it more advantageous to sell locally than generate revenue from wholesalers. In addition, other

farms target institutional customers as a steady source of demand. However, this segment tends to be particularly price sensitive, and margins earned may be lower than for produce sold to other food service providers.” (IBISWorld, n.d.) This mirrors what Wellspring Greenhouse Cooperative, a traditional greenhouse cooperative based out of Western Massachusetts, reported in their market research. They chose to have 1/3 of their sales go to institutional customers because, despite having lower prices, they had a consistent/stable demand. The main financial considerations for running a hydroponics business are the initial capital investment in equipment, as well as the ongoing costs of fertilizer and seeds. A major boon to this industry is bad weather, as more traditional field grown farms suffer, creating a void for hydroponics to fill. (IBISWorld, n.d.).

2.2.4.2 *The Aquaculture Industry*

Aquaculture is the practice of growing fish in containment, rather than catching fish in the wild. The aquaculture industry in the United States is also growing, with an annual growth rate averaging 2.1% from 2009-14, and a projected growth of 1.4% for 2014-19. The most common product for aquaculture is far and beyond Catfish, with 42.3% of product produced. Other food fish, including all of the fish we are considering, represent 19.2% of the product. 7.3% of the market was trout, 3.8% salmon, and other fish such as bass, tilapia, are within the other 8.1%. (IBISWorld, n.d.)

Aquaculture producers mainly sell to fish and seafood processors, followed by wholesale distributors (IBISWorld, n.d.). Selling direct to retailers, direct to consumer, and to government/institutional holds less than 10% of the market. To be profitable fish farmers need to compete against Canadian and Chilean low prices. Fish food is the most substantial ongoing cost for operators, costing an estimated 64.8% of gross revenue. Wages cost 14.9% of revenue, as the field labor intensive due to constant feeding and monitoring.

2.2.5 *The Greenhouse Initiative*

An idea was proposed to build a greenhouse in Worcester using aquaponics to efficiently grow food in an urban environment.

2.2.5.1 *Partners*

2.2.5.1.1 *The Worcester Roots Project*

Worcester Roots, the main sponsor of our project, is a non-profit organization seeking “to create opportunities for economic, social and environmental justice” (Worcester Roots, n.d.). In this effort, they lead local projects to help clean their local areas, raise awareness for issues such as toxic soil and a just economy. Worcester Roots supports the worker cooperative style of economy and incubates a number of cooperative businesses (Worcester Roots, n.d.).

The goals of the greenhouse project is to design and construct a greenhouse and aquaponic growing facility and start a pilot cooperative business running out of the greenhouse. With the project they seek to empower local residents, provide a healthy, local food source for Worcester residents, and educate members and local youth about greenhouse growing, aquaponics, and the cooperative business style. The organization has expressed its wish to have students from schools come in and learn about co-ops as well as how a greenhouse works; these students would then take back that knowledge to their schools and homes, spreading interest and knowledge. If the interest is widespread and the 3 year pilot is successful, the organization has articulated that scaling up the greenhouse will be very high on their priority list. (Worcester Roots, n.d.)

2.2.5.1.2 Technocopia

Technocopia is a non-profit maker-space that is located in Worcester. They provide a shared space and tools for their clients who wish to design and create their own projects. Technocopia's main interest in the aquaponic greenhouse seems to be the possibility of creating open source designs that can be locally manufactured by anyone. It is Technocopia's wish that the designs that go into this aquaponic greenhouse be accessible by anyone who wants to replicate this design on a smaller or larger scale. Technocopia wants the CAD drawings and any other element of the design to be easily reproduced, even by individuals who have no expertise in the area. Another one of Technocopia's interests is the sustainability of the greenhouse, and to this end the company has suggested that it would like for the greenhouse to also produce crops for plastics. These plastics could then be used for repair of the greenhouse and the structures inside it via the process of 3d printing to carve out certain specific structures in need of replacement.

2.2.5.1.3 Regional Environmental Council and Urban Garden Resources of Worcester

The Regional Environmental Council (REC) of Central Massachusetts is a local agency that helps in the production and distribution of seedlings. Their program Urban Garden Resources of Worcester (UGROW) is engaged in helping communities create food security by growing food in their neighborhoods. They have currently established 62 community gardens in Worcester and provide these gardens with the technical assistance to grow organic seeds and seedlings. The UGROW network includes school, youth, senior citizens, social service agencies and grassroots community residents. This diverse network not only makes a viable market for seedlings, but it also helps in connecting people of all ages and backgrounds with each other. (Regional Environmental Council, n.d.)

2.3 Aquaponic Greenhouse Design

2.3.1 Greenhouse Structure

2.3.1.1 Greenhouse Frames

Considering the weight of the materials plus the amount of snow in the winter in New England we must choose a good and strong frame for the greenhouse. When considering which frame design we are going to use, it is important to look at what kind of materials we are going to use in its construction. A good design will hardly help if we use a material that cannot withstand the weight put on it. Ross provides a useful overview of the possible materials for greenhouse frames: "The frames are made of wood, galvanized steel, or aluminum. Build-it-yourself greenhouse plans are usually for structures with wood or metal pipe frames. Plastic pipe materials generally are inadequate to meet snow and wind load requirements." (Ross, n.d.). For this reason, plastic is basically out of the list in New England.

There are many different styles of greenhouses, but not all of them are made for the heavy winter. Figure 15 shows a few designs that could work for the northeastern weather.

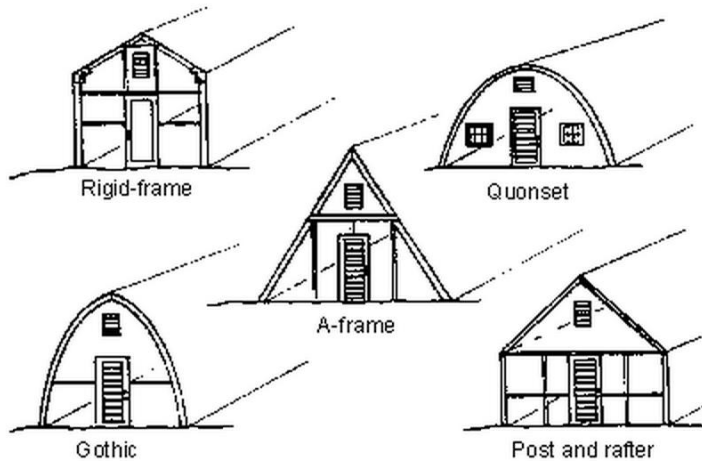

Figure 15 greenhouses designs

The Quonset and gothic style are circular or parabolic shaped frames. They have round tubing that is then draped with some sort of covering. The basic shape of the greenhouse ultimately limits what type of glazing material could be used. Glass would not be usable in this type of construction. While the design is simple, it does have some drawbacks that must be taken into consideration. The shape also is not very space efficient; with a very low ceiling it would not be ideal for aquaponics. These drawbacks would limit our space usage and air circulation. And because of snow and the weight of materials, the round shapes usually are not the best option.

There are three frames that are simple, efficient, and would serve our needs.

The first one is the rigid-frame structure; it has vertical sidewalls and rafters for a clear-span construction. There are no columns or trusses to support the roof. Glued or nailed plywood inserts connect the sidewall supports to the rafters to make one rigid frame. The conventional gable roof and sidewalls allow maximum interior space and air circulation. It needs a good foundation to support the weight of the materials and the side walls. It also requires more material than some other styles of greenhouses, since its structure is more complex.

The next one is the post and rafter structure, the post and rafter has a similar design to the rigid-frame structure but it requires more wood or metal in the construction because it has columns or

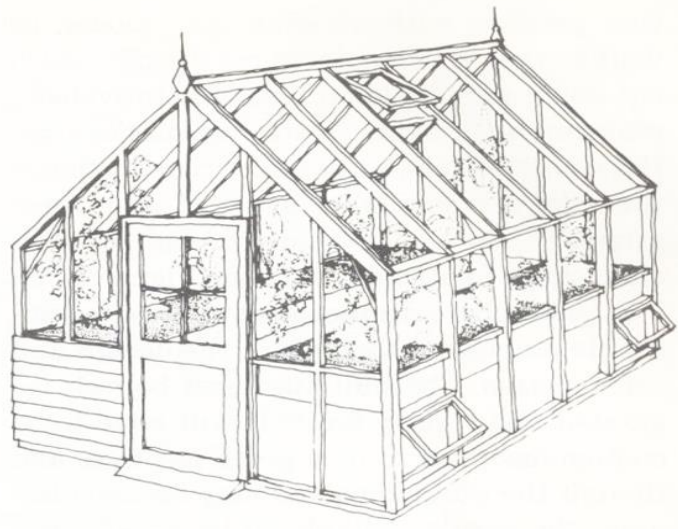

Figure 16 a rigid-frame structure

trusses, and the frame must be footed. But like the rigid-frame, the post and rafter allows more space along the sidewalls and efficient air circulation.

The third one is called the A-frame, this style of structure is the simplest one, and can hold the weight of the materials and the weather, but because it is smaller and it does not have vertical walls, it does not have much space inside what not only affects the quantity of vegetables and fish the greenhouse produce but it also minimizes the efficiency of the air circulation.

Taking in consideration that our greenhouse will be for aquaponics, meaning that it will have higher vegetable beds instead of using the ground to grow the vegetables, it is easy to eliminate the A-frame greenhouse because it drastically reduces the usable space inside. Any round structure also reduces our space, and because of the snow the structure might not hold the weight or limit our choices for the coverings.

From this research, it is conclusive that the optimum structure would be the post and rafter or the rigid-frame, which are close to a normal house structure, because they optimize the space inside, they provide a better air circulation and more space to work inside, and they also have a strong foundation capable of holding the weight of the coverings and snow.

2.3.1.2 Greenhouse Frames Materials

Independent of the greenhouse style, we also need to find a good material to build it. PVC is commonly used around the world for greenhouse structures, it is relatively durable, strong, chemically resistant, and it is also a cost effective material. The only downside is that it is not commonly used on larger scale structures. This is due to the fact that it does not have the strength that other materials, like wood, steel, or aluminum, have. Due to the size of the greenhouse, 20x33 feet, PVC does not seem like a reasonable material to use. A stronger material is necessary.

Wood is also a traditional material used to build greenhouses, it has an attractive appearance, it is strong, and can retain heat well. Also, some types of wood can retain color for a long time, diminishing the regular maintenance. An important drawback is that most hard woods must be pressure-treated with preservative and painted regularly to prevent them from rotting, especially being in a wet and warm environment. They are also heavy and hard to work with during construction, and wood can be really expensive. With these attributes, wood would be a good material for a permanent or long lasting greenhouse if it is well maintained.

The aluminum is a metal alloy that does not require any regular maintenance, since it does not rust or rot, it is light and easy to work with but strong at the same time, it also is narrower than wood allowing a better light penetration. On the other side, aluminum can be expensive and does not retain as much heat as wood.

The other option is the steel frame, it is light and easy to build, strong, and ridged. It is normally cheaper than wood and aluminum, and they also allow a better light penetration. But they must be painted regularly to prevent rust and like aluminum they reduce the heat retention compared with wood.

From this information, PVC does not have the characteristics necessary for a year-round greenhouse in New England, leaving the choice between wood, aluminum and steel. Aluminum would be the most expensive on the beginning and does not have the insulation capabilities as wood, but it is a maintenance

free material, not requiring paint, which could bring the price down in the long run. It also is easy to put together or take apart to move it anywhere.

2.3.1.3 Greenhouse Coverings

Greenhouses are a way of protecting the crops from the outside environment, and as it is well known the weather in New England is truly harsh. New England is well known for having all seasons well defined, with a summer average of 85 degrees Fahrenheit and a winter average of 25 degrees Fahrenheit. With that in mind, choosing the right structure and the right materials to protect the inside is a top priority when designing a greenhouse.

When searching for materials to build the coverings of the greenhouse many aspects must be considered. It needs to have light transparency for enough sun light to get in, but it also needs to be strong and lasting to prevent damages. Adding to that, insulation is a major requirements for the New England exceptional weather. Lastly, the cost, what is a major consideration that may dictate the material used in the greenhouse design.

If a proper insulation gets overlooked, the cost of the greenhouse can become higher than it can be afforded. Table 1 contains some information about some materials and their properties.

	Light transparency	Impact resistance	Lasting (years)	Insulation	Heat loss	Cost Price/ <i>ft</i> ²
Solexx	70-75%	yes	10 +	2.10-2.30	0.43-0.48	\$1.50
Glass(single)	88%	no	Life long	1.5	1.5	\$17.19
Multi-wall polycarbonate	78%	yes	10 +	1.6-2.5	0.5-0.7	\$1.90
Single-wall polycarbonate	80%	no	10 +	>1.6	>0.5	\$1.83
Fiberglass	85-90%	Yes	5 +	0.83		\$2.26
Single-wall film	85%	no	3-5	0.87	>1.2	\$0.15
Single-wall acrylic	87%	no	10 +	>1.82		\$3.61

(Greenhouses, n.d.); (Greenhouse Coverings, n.d.); (FarmTek, n.d.)

Table 1. Greenhouse Covering Materials and their properties

In the table above, lasting means that the material will not lose quality in the time line provided by the table. For example, most plastics will start to become yellow losing transparency or light diffusion.

While conducting research on these materials, two of them stuck out as far as efficiency goes: Solexx and traditional multi-wall polycarbonate. Both of them are multi-wall, with air in the middle acting as insulation. Air entrapped in the small spaces in materials retards heat flow. This insulation technique can reduce the heat loss and the energy costs with it. (John W. Bartok J. , 2007)

First, the Solexx, plastic panels made of high density polyethylene infused with UV inhibitors for a warrantied life of at least 10 years without yellowing, the panels are 3.5mm to 5mm thick and said to be impact resistant. Although Solexx is milky in color instead of transparent, it is said have a light diffusion of 70 to 75%. (Megastore, n.d.)

The other materials are the polycarbonate, in this case a multi-wall, multi-wall polycarbonate, which offers higher impact resistance and heat retention over thinner panels. The panel offers 79% light transmission and includes anti-condensate coating to prevent dripping. It also has UV inhibitors that prevent the material from yellowing. (Megastore, n.d.)

A third option that could be considered is the glass covering. It has a pleasing appearance, is inexpensive to maintain, and has a high degree of permanency. An aluminum frame with a glass covering provides a maintenance-free, weather-tight structure that minimizes heat costs and retains humidity. Glass is available in many forms that would be suitable with almost any style or architecture. Tempered glass is frequently used because it is two or three times stronger than regular glass. The disadvantages of glass are that it is easily broken, is initially expensive to build, and requires much better frame construction than plastic. A good foundation is required, and the frames must be strong and must fit well together to support heavy, rigid glass.

Polycarbonate, glass, and Solexx, all offer a good amount of insulation as well as heat retention, but even with them we need to find alternative ways of heating the greenhouse in order to save energy.

Taking in consideration our constraints, the plastic film can be easily destroyed, does not have a long life expectancy, and it is also not strong enough to hold the weight of heavy snow, these cons would increase the work to change it every year or so. The glass is easily breakable and expensive, these two cons are enough to eliminate it from the possible materials. Fiberglass has more or less the same yellowing problem as plastic film and acrylic is not resistant enough.

This leaves two choices, the multiwall polycarbonate or Solexx. They are impact resistant, they have a large life expectancy, and both of them, normally, come with a 10-year warranty. It is also good to remember that, for aquaponics, the greenhouse does not have to be made of transparent material from top to bottom, normally just from the top of the beds and up, and for this particular greenhouse, one wall can be entirely made of wood, since it will not get sunlight.

2.3.1.4 Floor

There are many different options to choose from when deciding what kind of material should be used for the floor in a greenhouse. For a regular hydroponic greenhouse, it is common to have the floor made out of dirt with walk ways around the vegetables made with industrial tiles. However, for an aquaponics system the vegetables do not grow in the ground and a stronger foundation is required in order to support the weight of the beds and tanks.

Aquaponic system also differs from hydroponics in the point that there will always be a lot of indirect water flowing and spilling on the ground, where in hydroponics there will be a certain amount of water usage directed to the same points and absorbed by the ground.

With this reasoning, most people think that concrete, or a brick foundation are the best options for the flooring of a greenhouse, but in reality they are not ideal and quite costly. Because we are dealing with water and organic products, concrete and bricks could cause problems within the greenhouse, problems like harboring mold and disease.

In the other hand we have a floor made of dirt, which costs little to nothing and, in time, absorbs the water, but since it takes time, and the water will make a mess inside of the greenhouse a dirt floor is far from ideal.

Another option that is in between a permanent floor and dirty is the use of pea gravel and a special flooring designed for greenhouses, a durable fabric that goes on top of the gravel. The combination of these materials will facilitate the water drainage and block the weeds from infiltrating the inside of the greenhouse.

By sticking with a simpler and less permanent flooring it would also be easier to move the greenhouse for other locations, if necessary, and reduce cost and work required to build it. Other advantages are the prevention of disease and obviously a better work environment since there will be constant water spillage on the floor.

2.3.1.5 *Insulation*

Thermal insulation is the reduction of heat transfer between objects. The principle of insulation is to keep one side warmer than the other, which means that insulation not only keeps the ambient air inside the greenhouse warm in the winter but it also keeps the ambient air cooler in the summer. This air regulation can be achieved using engineered materials or by simply trapping air. According to Bartok, "Insulation is basically trapped air and air is a good insulating material" (John W. Bartok J. , 2007). Because air is a poor heat conductor, it will reduce the heat transfer.

Insulation efficiency is measured by the R-value. The higher the R-value the better the insulation of the material. The R value can be found on the label of most insulation products found in distributor stores around the country. It should not be confounded with the U-value, which is a measure of the heat loss by the material. For the U-value the smaller the number, the less heat the material loses. The amount of insulation needed depends on a series of factors, like the climate, air circulation, and the design of the greenhouse.

All these factors considered, the main reason to insulate a greenhouse is the increase in energy efficiency. Proper insulation of a greenhouse is the most efficient way of saving energy and reducing the utility costs. Choosing the right material is not only important to conserve the temperature ambient inside of the greenhouse, but it is also vital for the survival of the business.

According to the Department of Energy, "Heating and cooling account for 50 to 70% of the energy used in the average American home. Inadequate insulation and air leakage are leading causes of energy waste in most homes." (Desjarlais, 2008). Taking in consideration that a greenhouse is generally less prepared to withstand cold weather than a house, having the proper insulation is essential to save energy in both winter and summer. Greenhouse heat loss can be calculated in a similar process to homes, considering insulation, air circulation etc. In the long run after the installation costs have been paid out, the cost of running the greenhouse will be drastically reduced if proper insulation is maintained.

2.3.1.5.1 *Thermal Blankets*

In general, greenhouses are designed to take in as much light as possible and therefore it becomes poorly insulated. During the day, the greenhouse is warmer due to the sun's radiation, but at night heat must be conserved in order to maintain a good thermal environment. The roof and the walls are the areas that loose most heat during the night.

A very effective way to conserve the heat in the greenhouse is to use thermal blankets on the walls and roof at night and remove it during the day. These movable blankets can save a substantial amount of

energy that would otherwise be used to heat the greenhouse during the night. According to a research done in New Jersey, the use of thermal blankets during the night obtained a savings range of 22% to 58% on energy costs. (Roberts, Mears, Simpkins, & Cipolletti, 1981).

There are several important aspects of these blankets: it is important that the system covers all edges to prevent the warm air from leaking out, it should also have a drainage system to prevent excessive condensation; a material that allows water to pass is preferable, another criteria is the strength of the material, to prevent damaging it. The blanket could also be made of multiple layers, more insulation, and ideally with a reflective side, to maximize heat retention. (Patricia A. Rorabaugh, Merle H. Jensen, & Gene Giacomelli, 2002)

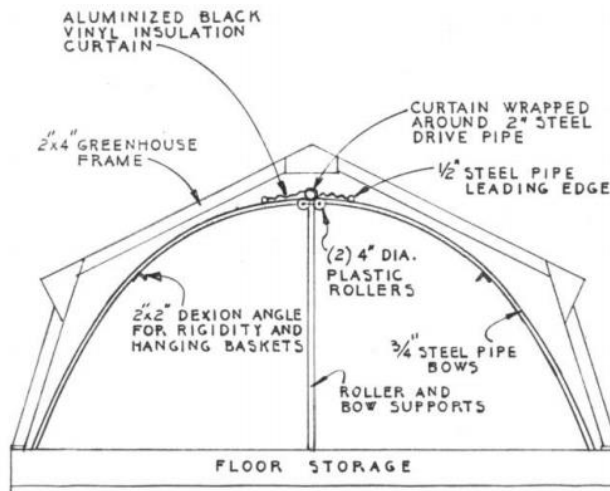

(Roberts, Mears, Simpkins, & Cipolletti, 1981)

Figure 17. Curved Thermal Blanket

Figure 17 shows a movable curved curtain stalled inside a greenhouse, besides the thermal insulation at night it could also serve as a shading area during the day.

2.3.1.5.2 Ground Insulation

Ground insulation is the insulation under the ground. It is normally used in the foundation to keep the ground warm and prevent the bite frost from lowering the temperature inside of the greenhouse. As it is intuitive, the insulating material has to be more resistant than normal insulation materials because it is always humid and great part of the time wet, and therefore, it tends to be more expensive than a regular insulation material.

There are many insulation materials designed for floors and foundation, but most of them are expensive and/or made to be used in houses, like surface-bonding cement and pressure treated plywood. Because we are dealing with water all the time, neither of these options works well for us. Ideally the floor of a greenhouse has to be able to absorb water fast. Therefore we need an insulation that either absorbs water or that goes around the foundation. (Gibson, 2010) (Fratzel, Foam Board Insulation R Values)

During a visit to a greenhouse in Massachusetts we were presented the Extruded Polystyrene Foam, also known as blue or pink board. This material is a rigid foam board of varying thickness and sizes that can

offer an R value of up to 5 per inch of thickness. The blue board is also made for a ground insulation, what offers a good resistance against the weather and humidity.

2.3.1.5.3 Table Comparison of Different Insulation Materials

	LOOSE FILL	BATT	SPRAY FOAM	RIGID/BOARD-STOCK
What it is	Loose cellulose or fiberglass is blown into a wall cavity or attic.	Batt insulation is usually made of mineral material or fiberglass. It also comes in cotton (see photo), but it's pricier and less readily available.	Expanding spray foams are applied to surfaces to block the transfer of heat and cold. There are two types: two-pound closed-cell foam, which is both an air and vapor barrier, and half-pound open-cell foam, which must be installed with a vapor barrier.	Rigid boards of foam, mineral fiber or fiberglass.
Best for	Retrofitting attics and walls	Interior walls; tight budgets	Closed-cell: most applications, including ceilings and unvented roof-decks; open-cell: walls and other moisture-free spaces	Exteriors only, either beneath siding, below ground level or on roofs
R-value per inch	3–3.7	Mineral wool: 2.8–3.7; fiberglass: 3–3.7	Closed-cell: 5.5–6; open-cell: 3.6	Foam: 3.6–6.7; mineral fiber or fiberglass: 4.2–4.5
Pros	Inexpensive, relatively easy to have installed. Can be blown in via holes drilled into the exterior of homes with lath and plaster interior walls.	Fiberglass batt is the cheapest insulation product. Mineral wool made in Canada contains 45 to 85 per cent recycled material.	Closed-cell has the second-highest R-value per inch of all insulation types and is great for tight spaces and unvented attics due to its high R-value per inch; open-cell can be used in virtually any application.	Some rigid foam has the highest R-value per inch; works well in wet conditions (fiberglass and mineral fiber products drain water away).
Cons	Not a do-it-yourself project; requires specialized	Fiberglass batt: not easy to cut, which makes it difficult to	Priciest insulation option; must be applied by a specialized	Limited applications; generally installed only as part of a

	equipment. Not ideal for Concrete walls, below-grade stone walls, unvented ceiling and deck cavities, since moisture significantly cuts the insulating properties of cellulose	properly fit; R-value is greatly reduced if not installed properly; can cause severe itching and skin rashes during installation; installers should wear protective gear and clothing. Not ideal for Unvented attic and deck cavities	contractor; foams are made of petroleum products. Not ideal for Installing near a furnace, water tank or fireplace, since spray foam is flammable; don't install open-cell foam in leak-prone spaces, such as attics	major renovation, such as replacing siding or the roof, or digging out around the foundation. Not ideal for Attics, walls, ceilings
--	---	--	---	--

(Mack, 2014)

Table 2. A comparison of different insulation material

2.3.1.6 Ventilation Systems

Greenhouse ventilation is the cycle of removing the air from inside of the greenhouse and replacing it with the outside air. The main purposes of ventilation in a greenhouse are to control the high temperature during the summer, to preserve the humidity at adequate levels during the winter, to provide a uniform air circulation in the entire greenhouse. Ventilation not only maintains the environmental conditions inside the greenhouse, but also influences the plant's capability to perform photosynthesis, absorb indispensable elements, and complete the pollination. (Dennis E . Buffington, n.d.) (Hopper, 2012).

The absence of air circulation in the greenhouse harms the plants and also harms the structure of the greenhouse. The problems associated with over condensation in greenhouses are fungus diseases and difficulties in keeping the building clean. These issues cause a more rapid deterioration of the building, and uncomfortable environmental conditions for the workers. A greenhouse without proper ventilation would not only increase the costs of repairing it, but it would also increase the need for constant maintenance, thus it will end up costing more to pay somebody to clean it. (Dennis E . Buffington, n.d.)

When analyzing the necessary ventilation, it is necessary to consider how the temperature varies during the year. Summer ventilation is a way to keep the greenhouse temperature from rising much higher than the outside temperature. Greenhouses collect solar radiation therefore it is normal for the inner temperature to be higher than the outer. The ventilation system must move the air inside of the greenhouse in order to keep the temperature from building up around the plants. In order for this purpose to be achieved a combination of mechanical and natural circulation systems is needed.

Although ventilation in the winter is hardly used to keep the ideal temperature inside of the greenhouse, the ventilation system is still as essential as the heating system, even when the heating is working at its maximum in the coldest days, ventilation is required in the greenhouse to keep a uniform air circulation. Fresh air must get in the greenhouse to prevent moisture. If the hot air is not removed, high humidity and condensation will occur.

Spring and fall ventilation are in between the summer and winter ventilation requirements, because it has some cloudy and cold days as well as some sunny and warm days.

2.3.1.6.1 Ventilation system options

Ventilation systems can be natural, with windows, or mechanical, using fans or other systems. When using the natural air ventilation, physics plays a big role. According to Hooper, “The concept of thermal buoyancy is based on the physical properties of air; as air is heated it has the natural tendency to rise.” (Hopper, 2012) When hot air rises and leaks by ridge vents in the roof of the greenhouse, it allows fresh air to come in by the windows placed on the walls, closer to the ground. It is a process that in theory would work very well, though the air circulation would depend on the conditions of the outside weather.

The mechanical system uses fans to produce good air circulation, allowing more control over the air circulation. The mechanical system would also allow for a more enclosed environment, preventing unwanted pests from going in, and a better temperature regulation.

When choosing the mechanical system it is important to know the right dimensions of the greenhouse. To determine the fan size needed for a greenhouse it is necessary to figure the greenhouse’s volume in cubic feet and the air exchange per minute wanted for the greenhouse. Multiply the length by the width by the height of the greenhouse to determine the greenhouse’s volume. (Hopper, 2012)

Even if the greenhouse is not constructed as it is said in the blueprints, an approximation of the volume is easily calculated. Breaking the greenhouse into two separate pieces, a prism and a rectangle, the formulas are the following,

$$V_{prism} = \frac{h * b * l}{2}$$

Equation 1. Volume of a Triangular Prism

$$V_{rectangle} = l * b * h$$

Equation 2. Volume of a Rectangular Prism

Where, **h** is the high, **b** is the base, and **l** is the length. After calculating each individual volume, it is necessary to add them together for the total volume of the greenhouse.

Having the right volume of the greenhouse, it is easy to find the right fan. Researchers found that, “For ventilation in most greenhouses, the fans should move the desired air volume rate against a static pressure of 1/8-inch water.” (Dennis E . Buffington, n.d.).

Besides the right fan for the volume of the greenhouse, the placement of the fan is also important. Normally a horizontally-oriented fan where the air circulates in a circular pattern is best, horizontally positioning also allows the hot air to rise without air resistance from the fan.

Independent of mechanical systems, the roof vents should always stay open during warm weather, and it is suggested to close the vents during the winter, or at least be more careful with it, to avoid heat loss.

2.3.1.6.2 Natural Ventilation Systems

Natural ventilation systems, are systems that work manually or through natural energy. They are normally windows or roof tops which optimizes the exchange of air inside the greenhouse.

A good automated option would a solar-powered vent opener, this solar vent converts the heat energy into mechanical energy to open the vent. The higher the temperature the wider the vents will open. This occurs in the black cylinder, power tube, in the image below, it contains a mineral inside that expands when heated and shrinks when cooled. The expansion of the mineral pushes the piston, which drives the vent up.



Figure 18: Solar-powered vent opener

The table below represents the characteristics of the solar-powered vent opener show in the figure above. The cost of the whole system is \$69.95 according to FarmTek, and although the power tube and the spring need to be change from time to time, they are only a fraction of the total cost of the system.

Solar-Powered Vent Opener
Allows solar-powered control of either top or side mounted window vents. <ul style="list-style-type: none">• Adjustable opening temperature of 60°F to 75°F, and an 18" maximum opening.• Soundless wax motor reacts to solar sensors, opening vent just enough, allowing for a quieter, relaxing environment.• Works independent of power grid to continuously monitor greenhouse temperature.• Recommended for use in temperatures up to 120°F.• Lifting capacity: 15 lbs.• It is recommended the vent cylinder be removed during the winter months.
Costs \$69.95 on FarmTek

(FarmTek, n.d.)

During the interview with Abbie White, from WPI's greenhouse, she mentioned that automated system during the winter can be extremely inefficient because they open when the inside is hot, letting all the

hot air scape. This phenomena will drastically increase the cost for heating the greenhouse. It is important to note that any automated window opener should be disconnected during the winter.

2.3.2 Aquaponic System Structural Components

The aquaponic system involves many different parts and components. Choosing the right parts and the most efficient ones is deeply related to the type of the system we are going to use. The system parts are closely related to the type of fish and plants that we are going to grow, so we can make the system more efficient. The next step is to define the size of our greenhouse and type of our growing beds. The location plays a really important role because it affects the type of equipment we are going to use. For example if the green house is located in a very cold location, we will need to buy heaters and a very powerful one. For those reasons studying all environmental constraints is a crucial part of the job to be done. There are also other parts that we take in consideration like the fish tanks that will accommodate the fish. We also need to flow the water in the system so we will need pumps and a piping system. Circulating the water around will also come with solids and debris so we have to utilize mechanical filters to keep the system clean. To promote ecological balance we will need biological filters and appropriate growing beds for the plants also artificial light.

2.3.2.1 Fish Tanks

Fish tanks can be made from different materials like concrete, metallic, polyethylene, fiberglass etc., but generally fiberglass and plastic tanks are used in aquaponics systems. The most used shapes are the rectangular and cylindrical. The first type of tank is cylindrical with a wide base as shown in Figure 19

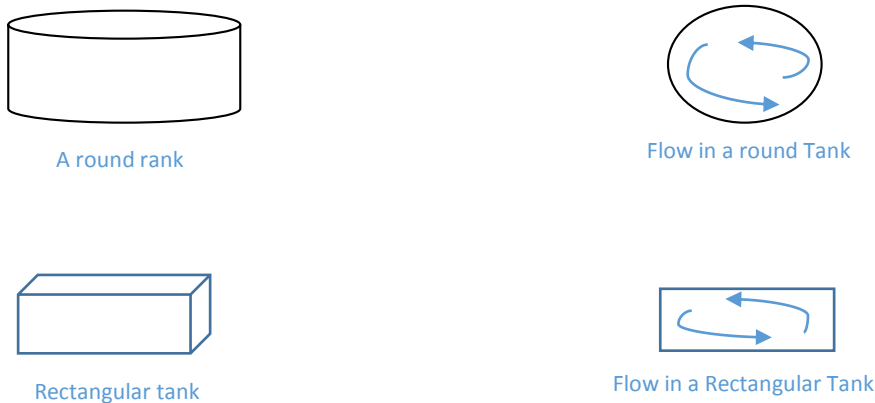

Figure 19. Flow in Round and Rectangular Tanks. Rectangular tanks suffer from reduced flow at corners.

Most of the commercial and backyard aquaponics systems used this shape of tank because it offers some advantages. Cylindrical tanks don't have sides connected together by other materials, for this reason they are more stable than rectangular ones. They have a good water exchange, which means all parts of the tank are covered by water flow. For example if we direct the upcoming water from the pipe it will make circular movements so all the mass of water will move in the tank and get replaced by fresh water. All this factors taken in consideration result in greater gas exchange and cleaner. It also prevents the growth of algae's in the non-flow zones. Non flow zones are the corners of the rectangular tank where no flow of water occurs (Flow in a Rectangular Tank).

The space required for a circular tank is larger than that required for rectangular (Figure 19) because of its round edges. This could be a problem when we have very little space to use for the system.

This shape is mostly used in home aquariums but is usually limited to that. The main problem are the non-flow zones or low water exchange in the corners. Because of its shape and the water flowing in one direction, the corners of the tank will get a little or no flow of fresh water. This means that they would be dark spots. As mentioned earlier this is a big disadvantage and might become problematic for the ecological balance.

	SPACE REQUIRED	Stable	Easy to clean	Water exchange
Round Tank	1000 l	Yes	Yes	High
Rectangular Tank	785 l	No	No	Low

*Assuming 1m high of tank and radius 0.5 m for round tank, 1 m sides for rectangular

Table 3. Comparison of Rectangular and Round Tanks

The Table 3 below shows the two different types of tanks and advantages and disadvantages related to usage and maintenance. There are several types of materials used to build water tanks. We can mention, concrete, metal, fiberglass and polyethylene (plastic) (WILTON, 2001). Since in our project we want a water tank that will host fish, the metal and concrete tanks are excluded from the design because their performance is low building a healthy environment for the fish. The materials they are composed are usually toxic for the living organisms. The most common material and appropriate used for the fish tank are Fiberglass and Polyethylene. These two materials are proven to be the safest and cheapest (Lennard, 2008). The advantage of the fiberglass material is that they are offered in any shape and size, but this comes with a higher cost. The opposite happens with polyethylene or plastic tank. They are cheaper but it is very hard to have them in custom size since the production of a single mold for our needs is very expensive for the company. The fiberglass is very strong and is easy to repair compared to plastic. If the polyethylene tank shows signs of cracks the whole tank should be replaced. It also deforms easy compared to the fiberglass. This disadvantage can be improved by reinforcing the base and building them with a higher quality of material.

The differences between them are shown in the Table 4 below.

	Custom seize	deformation	Easy to repair	Easy to clean	Cost
Fiberglass	Yes	No	Yes	Yes	17.5 \$/g
Polyethylene	No	Yes	No	Yes	2.6 \$/g

Table 4. Comparison of different tank materials

In conclusion the best tank for our system is the round tank because it has more advantages in long and short term than its counterpart. It self-cleans, it is very stable and has high water exchange. For the material the fiberglass is the best option because it's easy to repair and we can have every shape we need for our system. It costs more than polyethylene but in long term it is worth it.

2.3.2.2 Piping

Piping is the other major component of the system as it is the backbone of the whole drainage system and the water circulation. Pipes are usually made by two materials, copper and PVC. The PVC pipes are the most common pipes used in aquaponic, from the smallest to commercial systems. (Research, 2010)

Copper pipes have many drawbacks like the oxidation and corrosion. They do not tolerate high temperature amplitudes and they are not elastic. The cost of repair and start-up are relatively high compared to PVCs. Oxidation and corrosion are very dangerous for the fish and plants because those chemical reactions release toxins, something we should avoid. We also want a material which is elastic and easy to fix. We should be aware that all pipes around should be insulated with proper thermal insulator which cost about \$2.00 /ft. of pipe. The Table 5 compares two types of pipe

	Oxidation	Corrosion	Temp Tolerant	Elastic	Price / 10ft
PVC*	No	No	Yes	Yes	3.23 \$
Copper	Yes	Yes	No	No	9.55 \$

*PVC stand for Polyvinyl Chloride. **prices HomeDepot.com. *** assumed ½ inch diameter of pipe.
http://www.engineeringtoolbox.com/pipes-tubes-d_347.html

Table 5. Comparison of different piping materials

In conclusion the best material for the pipes is PVCs. It is pretty obvious that has major advantages than its counterpart. PVC pipes are almost universal in water flowing systems and aquaponics.

2.3.2.3 Water Temperature

Since we are going to build a greenhouse and the aquaponic system in the very cold climate of New England the heating of the water tank and the greenhouse is indispensable. The factors we have to take in considerations are the efficiency and the cost of the system .First we have to determine the type of energy source for the system. The two most used and easier to find sources of energy are electric and natural gas. These two technologies are easy to access but they are costly for heating. Firewood is cheaper but the available fuel is limited. Solar is free and available but is really dependent on the location. Natural gas and firewood have the greatest environmental impact because they burn and release different greenhouse gases, very harmful for the environment. On the other hand electricity does not have a direct impact on the environment only if it is produced by renewables sources like wind or solar (Wiser, 1999).The energy sources can give us an idea on what heaters we should use. We have electric heaters, gas heaters, firewood heaters and solar systems. All of the heaters but the solar have some risks related to the fire. Electrical heaters have the risk of short circuit, the natural gas heater uses high combustible fuel and firewood the firewood heater because it operates as a basically controlled fire that can be problematic if it gets out of control. The table below shows a clearer picture of the different fuels.

	Availability	Environ. Impact	Hazards	Efficiency	Cost/BTU
Electricity	High	Low /Passive	Fire	98 %	35.17 \$
Natural Gas	High	Medium/Active	Fire/Explosion	78 %	16.35 \$
Firewood	Medium	High/Active	Fire	70 %	12.99 \$
Solar	Depends	None	None	100%	0 \$

*Sources: US Department of Energy (<http://www.energy.com>). **Prices: US Energy Information Administration.
<http://www.eia.gov>. *** One BTU is the heat required to raise 1 lb. of water by 1 F degree,

Table 6. Comparison of different heating sources.

When choosing a heating option it is important to consider reliability and safe fail over, as well as efficiency. The majority of cold weather climates rely on gas heaters. Electric heating is also used, but

less popular due to being less cost effective. Solar hot water systems are attractive because of the 0 fuel and low energy requirements, but require a backup heating system in case of low sun.

The heating system of the green house and the Aquaponics system should be studied carefully because of the costs. In a climate zone like New England the amount of heat needed for homeostasis is very high especially during the winter. Startup cost is an estimated cost of installing the equipment for a heating system to work properly. Electrical heater works by converting the electrical energy to heat. The gas heaters work by burning the gas and using this energy to heat the water in the tank. The firewood water heaters work by burning the wood and using this energy to heat the water.

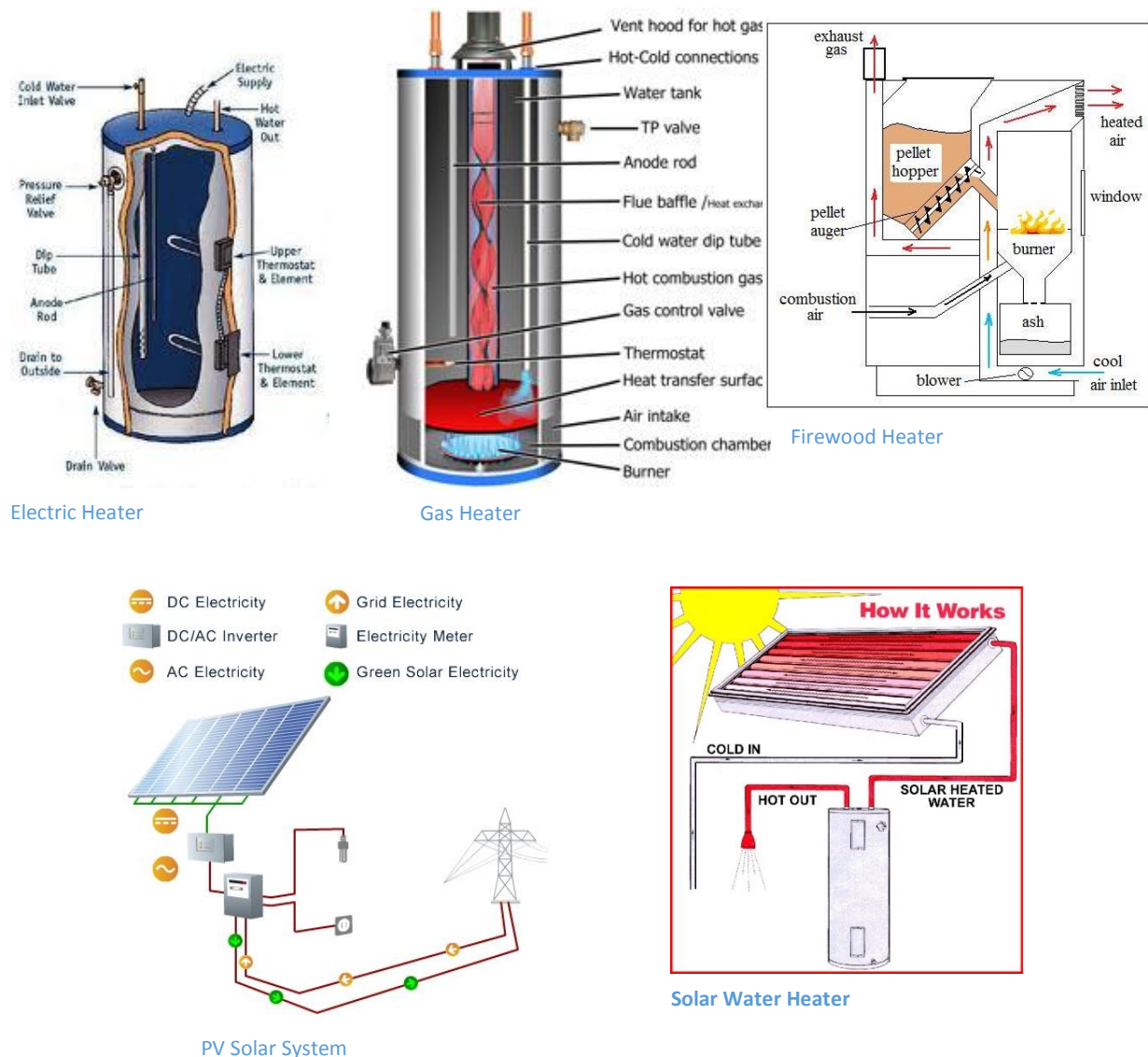

Figure 20. Various Heating Options

For heating needs using solar we have two main systems. The PV solar system and Solar water heaters. The PV solar system will convert the solar energy to electricity than we can use the above electrical

heater to heat the green house and the water tanks. Also we can use this system for other needs of greenhouse like lighting pumps and every other equipment that operates with electricity. The solar water heaters are explained in detail below.

Considering our greenhouse location and size we assume a system to be between 4-7 kW. We have the area defined as 33 L x 22 W. Assuming also that we will need to use 100 G of water every day at a temp of 120 F and the green house will be 10 ft. high. The start-up costs for each heater are show in Appendix N.

Taking in consideration the efficiency and the demand for free energy over the years we put in place another option. Solar energy is cost effective during the years but it is expensive in the startup as the table above shows. Another technology that is related to solar but less expensive is Solar Water Heaters or SWH. So instead of using a system that converts the solar energy to electrical energy we are going to use solar water heaters. This technology converts the solar energy to thermal one.

The SWH will be used as primary heat source and the electrical heater will used as a secondary .They will basically complement each other. The table below shows the components and costs for setting up a new system.

The figure 13 shows the differences in cost between various heating solutions and also the Return-of-Investment (ROI) in 10 years.

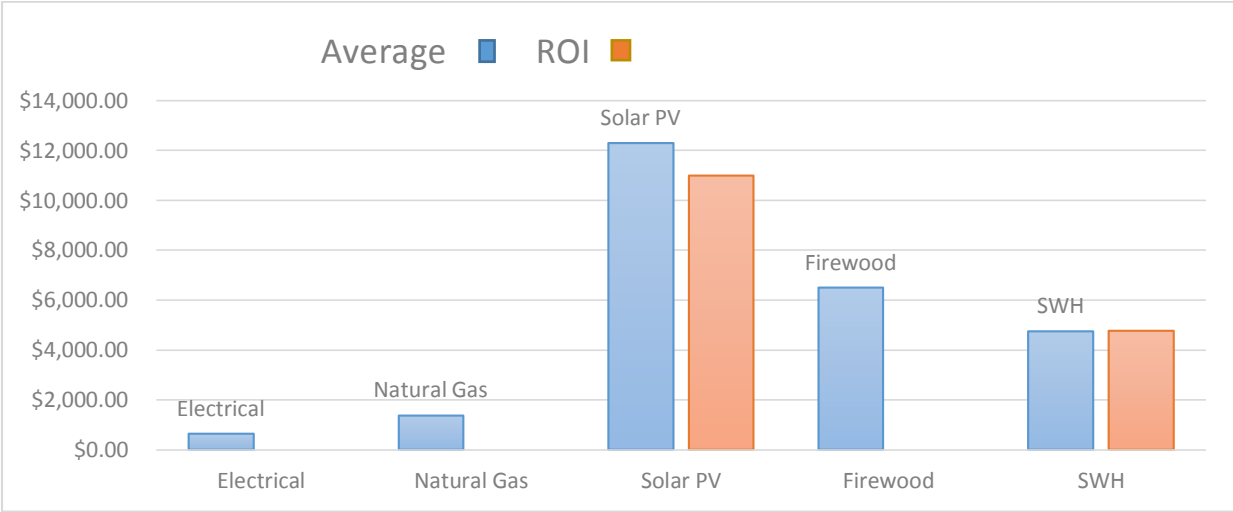

Figure 21. Costs and ROI over 10 years of different Systems

The water heating system will be one most costly part for our greenhouse especially in long term. Using a solar water heater combined with electrical heater would be an attractive option. The SWH will be used as primary heat source and the electrical heater will used as a secondary .They will basically complement each other. The start-up cost is basically low compared with the other systems and solar offers long term savings. Also something to keep in mind is the greenhouse itself will provide heating due to the greenhouse effect, similar to how a solar hot water heater would work, but for internal systems without natural light, a solar hot water heater + electric heater backup would be attractive.

2.3.2.4 Pumps

The pumps in our aquaponics system are needed to pump the water from the fish tank to the growing bed. Choosing the right pump is another important step because it directly impact the system functioning and the efficiency of the overall system. The two main types of water pumps are Impeller and air lift pumps. The Impeller pumps are the conventional pumps that use a turbine to push the water. This pump is most widely used in both backyard aquaponic projects and large commercial systems. (Figure 22)

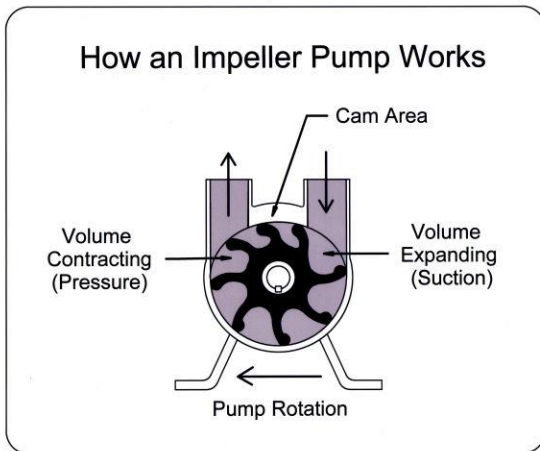

Figure 22. Impeller Pump

This pump is very powerful and very efficient. It does not require a lot of maintenance too. The main drawback is the possibility of backflow. That occurs for example when the pump is not working properly the water could flow in the opposite direction, something that we must avoid in our system because we want the nutrients for the plants to go from the tank to the growing beds and not vice versa. Since we need to keep our system biologically safe we need to avoid any oil leaks from pumps in the water.

Impeller pumps come in various styles, such as inline pumps that connect to piping, or submersible pumps that sit in the tank.

We also have the airlift pump shown in Figure 23. This kind of pump is powered by air. The air is pushed inside the cylinder filled with water and the water is lifted due to the air pressure inside the cylinder. The problem with this kind of pump is the height of pumping water. As we can see from Figure 23 the maximum height we can pump the water is dependent on the fluid level in the main tank. This really limits the practical uses of this pump.

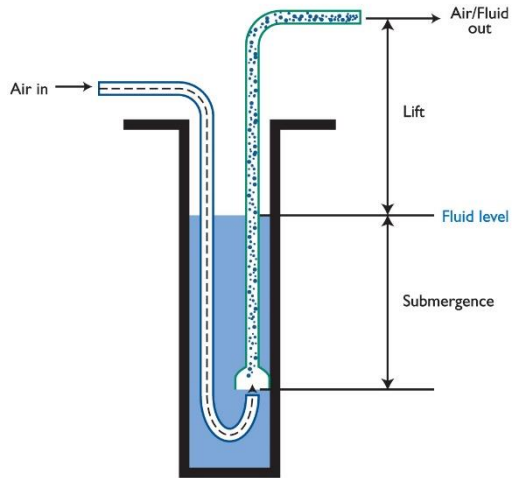

Figure 23. AirLift Pump

Another option is the Peristaltic pump used in dialysis machines shown in the

Figure 24. This kind of pump is best suited for vicious fluid. In our case it is not a good idea since we are going to pump. Advantages of this pump are: no hazards and low cost because only the plastic tube has contact with the water. The pump has issues with the water flow and high maintenance. We are not aware of any aquaponic system using this type of pump.

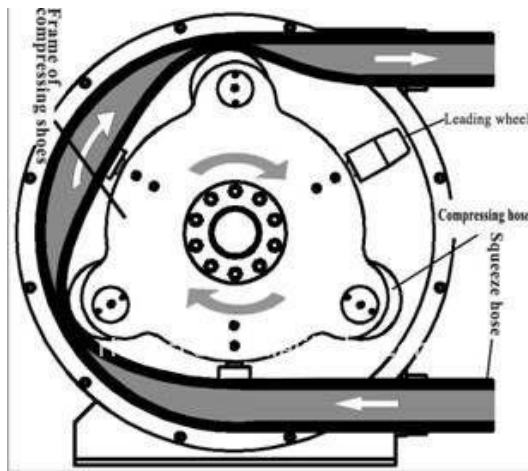

Figure 24. Peristaltic Pump

	Efficiency	Easiness Installation	Backflow	Maintenance Amortization	Hazards (oil leak)	Cost per 800 GPH
Impeller	High	Yes	YES	Low	No	60 \$
Airlift	Low	Yes	YES	High	Yes	90 \$
Peristaltic PUMP	Very Low For water	Yes	No	High	No	25 \$

*GPH (Gallons per Hour)

** Price amazon.com

Sources:<http://chicoaquaponic.blogspot.com/2012/07/choosing-pump.html>

: <http://groponix.com/what-is-an-airlift/>

: The Engineering Toolbox, copywriter 2005, <http://www.engineeringtoolbox.com/>

: <http://www.fao.org/docrep/010/ah810e/AH810E05.htm#5.3.1>

[Table 7 Advantages and Disadvantages of Pump Types](#)

The traditional impeller pump shows the most promise for use in an aquaponic system. This pump is used most in aquaponics and is very efficient. It is very reliable gives piece of mind since the technology is well tested.

2.3.2.5 Filtration

Filtration is another important aspect of our aquaponics system. It IS important because it gets rid of solid waste, cleans up the system from organic and inorganic waste, and maintains a safe environment for the plants and fish too. The two main types of filtration are biological and mechanical.

Biological filter (Figure 25) regulates the growth of the bacteria and other microorganism in the system. On the other hand the mechanical filter removes the solid and inorganic waste from the system. Those two type of filter assure that the system is clean and the ecosystem is in appropriate parameters.

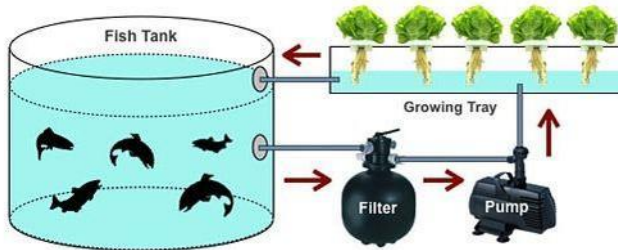

Figure 25. Biological Filter

The common types of bio filters are: trickling bio filter, fluidized bed, rotating bed bio filter. When design a circuit we tend to choose the one that is more flexible and I suited to every situation in our system. (Nate Storey, 2014) Biological Surface Area (BSA) is the amount of surface area inside your system that microbes can live on. BSA is very important in aquaponic systems because these microbes are the engines of a healthy aquaponics system. They oxidize ammonia, assist in nitrification and mineralizes materials like iron in order to foster healthy plant growth and a healthy system overall.

Bio fouling (Stanczak, 2012) is simply the attachment of an organism or organisms to a surface in contact with water for a period of time.

In some cases we would need more than one types of filter depending on the type of plants and fish we would use. In these cases we would need a filter that combines well with the other biological filters. Table 6 shows the differed between them.

	Design Simplicity	Surface area	Cost	Biofuel	Stability	Combination With other Filter
Trickling bio filter	Yes	Low	High	Yes	High	No
Fluidized bed	No	High	Low	No	Medium	Yes
Rotating bed bio-filter	No	Low	High	Yes	Medium	No

Sources: <http://www.americaaquariumproducts.com/fluidizedsandfilter.html>, <http://ag.arizona.edu/azaqua/ista/ISTA7/RecircWorkshop/>, <http://www.aces.edu/dept/fisheries/education/documents/Bulletin9A.pdf>

Table 8: The Pros and Cons of Different Types of Bio Filters

The mechanical filtration is usually simpler and easier. We can use different filters in different parts of the system as long as we don't prevent the regular flow of water and they are not made by material that is bad for the fish and plants. The mechanical filtration depends on the type of the fish tank design too. Another important thing to notice is that most of the pumps come with mechanical filters inside.

For our system the best biological filter would be the fluidized bed because it has low cost compared with the others. It also does not allow the overgrowth of the bacteria and it combines well with the other filters. It is very appropriate for the seedlings and has high surface area. Mechanical filters are open choice so we can pick them based on the pumps and their accessories.

2.3.2.6 Plant Bed Style

Bedding is a very important part of the aquaponic process. It is the part that brings all of the resources together and leads to end production i.e. plants. Choosing an efficient means of growing the plants is important to maximize the product output given the resources. There are two main bedding styles that were looked at. Both bedding styles use two completely different bedding mediums. Each medium has its strengths and weaknesses.

2.3.2.6.1 Pebble Media Bedding Style

The first one uses a pebble type of media. The material of this bedding style vary greatly. The two most common are either clay pebble media or gravel pebble media. The media is placed in a deep tray. Nutrient rich water is pumped in and out of the system.

The top surface is the dry region of the media. Figure 26 displays this region. The dry region offers many important uses. Water conservation is a significant aspect to consider when a lot of water is being used in a system. The topmost later reduces the amount of water that evaporates into the air. (Richard, 2011).

The second zone is the region that the roots occupy. This region is important because it is the part of the system that the plants receive their nutrition from. If this part fails in the system, the plants will not survive. This region is the part of the system where the nutrient rich water is pumped in and out of. The cyclical movement of the water ensures that the plants receive an even amount of nutrient rich water. When the water is periodically drained from this region, the roots are able to receive fresh air and oxygen from the first zone. This system can also support living creatures such as worms or other organisms that are beneficial to the plant system. (Richard, 2011).

The third zone is the region where solid materials and wastes are collected. These materials must be cleaned out periodically as to not pollute the system. Excessive waste can be detrimental to the system, and can ultimately lead to the death of the plants. (Richard, 2011).

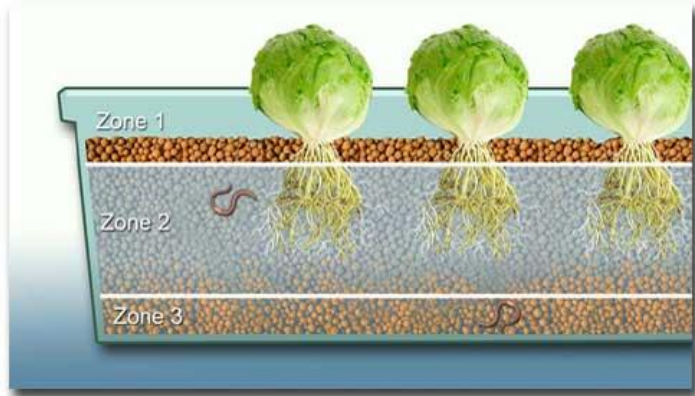

Figure 26. Pebble Media (Richard, 2011)

2.3.2.6.2 Floating Rafter Aquaponic Bedding Style

The basis of this form of aquaponics uses a large tank that is filled with nutrient rich water. The water is constantly circulated through the system. The water is also filtered to remove solid waste and excessive amounts of nitrogenous materials and ammonia which can be detrimental to health of fish and plants. Figure 27 shows an example of a small scale floating rafter aquaponic setup. The central tank is the fish tank where the fish excrete nitrogenous materials and solid food waste. This water and material is pumped up to the filters above where excessive materials are removed to ensure proper balance of the nutrients and waste products. The resulting water is pumped into the two tanks on the far left and far right. These are the growing tanks for the plants. There is a buoyant piece of Styrofoam that has holes cut in where the seedlings are placed. There they either can be grown to the point where they can be removed and sold as seedlings, or continue growing until they yield food. (The Different Types of Aquaponics System, n.d.).



Figure 27. Small Scale Floating Rafter (Aquaponic Designs, n.d.)

Using the floating rafter method, seedlings are planted in grow starter cubes, there they begin to grow. The roots pop out of the bottom of the starting cubes. A hole is cut out of the floating rafter, which is usually Styrofoam. The rafter holds the stone wool or Rockwool cubes. The roots hang out and float in

the water where they receive nutrient rich water from the pumps. (The Different Types of Aquaponics System, n.d.).



Figure 28. Stone wool Seedlings (Aquaponic Designs, n.d.)

Figure 29 shows a good representation of how the floating rafter configuration works. The figure shows the foam floating raft with the holes cut out in them. The starting cube is inserted into the raft, and the roots pop out of the raft and float in the nutrient rich water. This method is very simple and uses water instead of soil or any other solid medium which makes this setup truly aquaponic.



Figure 29. Underneath Floating Rafter (Aquaponic Designs, n.d.)

2.3.2.6.3 Fish Tank / Growing Tank in One

It is also possible to build a system that combines the fish tank with the floating growing rafter. This option saves significant space. Greenhouses vary in size and we need to be space conscious when choosing a set up for the beds.



Figure 30. Professional Aquaponic Setup

2.3.2.6.4 Conclusion

The more professional setup appeared to be the floating rafter method. This method was reserved primarily for professional applications or advanced greenhouse setups. While the setup requires more equipment in the beginning, making this method more costly than the media, but the way that the system functions, it is easier to maintain and regulate. The floating rafter method makes for greater growing capacity than the media based design. The media method of aquaponics seems most fitting in do it yourself home growing. It requires minimal equipment but does have the flexibility that a floating rafter growing bed has. The floating rafter method seems to be the most fitting style of bedding for the construction of the IQP greenhouse.

	Media Based	Floating Rafter
Initial Setup Cost	Low	High
Maintenance Ease	High	Mid
Growing Capacity	Low	High
Efficiency of Resources	Mid	High
Professionalism	Low	High

Table 9. Comparison of growing bed styles

2.3.2.7 Growing Media

To be able to grow the vegetation we will need a support medium. The medium is made usually from natural earth sources, but we have also artificial and synthetic ones. Different types of plants need different types of growing media so it's important to pick the right one for the plants that we are planning to grow. The growing media is specific and it has some crucial roles in the proper growth of plants and seedlings.

In terms of the rock and particle size we should pick a media that is between 8mm and 16mm. If we go beyond these limits there are some disadvantages (Research, 2010). For example if the media is smaller then there is not going to be enough air in between particles in the growing bed. If the media larger, we will have a reduced surface area and planting will become difficult. When we talk about weight we refer to the density of the media per cubic foot. The pH is the measurement of the acidity or basicity of an aqueous solution (Covington, Bates, & Durst, 1985). When the most acidic is 1 and the basics is 14, the neutral pH is 7.

The most common growing media are shown in the Table 10 below:

	Expanded Shale	Expanded Clay (Hydroton)	River Stone	Crushed Stone	Synthetic
Weight	Slightly heavier than expanded clay	½ the weight of stone	Heavy	Heavy	Lightest – tends to float
Environmental	Mined from a quarry	Mined from a quarry	Mined near local rivers. Larger environmental impact than engineered quarries	Mined from quarry or consists of crushed river stone	Made from petroleum
Origin	United States	Germany or China	Local quarry	Local quarry	China
pH Neutral (inert)	Yes	Yes	If the stone has any limestone, it will continue to raise the pH	Same as River Stone	Yes
Easy on the hands	Yes – even though the shale has been crushed, the kiln process rounds over all the edges	Yes – though the spheres tends to roll away when dropped!	Yes	Typically very sharp and hard to dig in with bare hands	Yes
Cost* per lb.	4.1 \$	4.8 \$	2.8 \$	1.5 \$	5.5 \$

*Prices amazon.com

Table 10. Growing Media



Figure 31. Growing Bed with Expanded Shale

The best option for our system would be the crushed stone. This kind of growing medium costs less than the others. It keeps the pH neutral and also is a local quarry. It is very good for growing lettuce, cucumbers, tomatoes, pak choi, squash, peppers, kale, broccoli, beans, arugula, cabbage, basil, watercress and chives.

2.3.2.8 Lighting of Plant Beds

Plants need a very good lightening system to grow appropriately. The type of lighting we have to choose is dependent on the location of the aquaponics, the average amount of sun hitting the green house and type of material used to cover the greenhouse. For example the material used to cover the green house will limit the natural light that will enter inside. Consequently we will need to have a lamp that powerful that will compensate this limitation. We have to take some factors in consideration like the power of the lamp, lifespan, and cost per 100 lumen. The lamp power is the power dissipated by the lamp when connected to the electrical circuit. The life span is the average lifetime of the lamp and the lumen output is the amount of brightness emitted by the lamp. The cost per lumen is the amount in dollars per 1 lumen brightness. Lumen is the unit of light intensity flux.

The main types of artificial lights used are shown in the table below:

	Lamp Power	Lifespan	Lumen(L) Output	Cost per 100 lumen
Incandescent	100w	1,200 h	1435	\$3.99
Fluorescent	100w	8,000 h	5945	\$0.96
LED	100w	50,000 h	3780	\$0.95
HPS	100 w	22000 h	6935	\$0.83

* Per year power costs are based on 4000 hours operation (approximately all night every night) and \$0.10/kWh energy cost.

Sources:

E Lamp Products Catalog 2001-2002

Osram/Sylvania Lamp & Ballast Catalog, 1998; 2004; 2010

Philips Lighting Company Lamp Specification and Application Guide, 2001/2002

J. Lienhard IV and J. Lienhard V, A Heat Transfer Textbook, Philogiston Press, Cambridge, MA, Web Edition 2008,

<http://web.mit.edu/lienhard/www/ahtt.html>.

<http://www.gardenandgreenhouse.net/index.php/past-issues-mainmenu-18/36-2009-gg/january-february-2009/359-artificial-light-for-the-greenhouse>

Table 11. Types of Lights

Based on the

Table 11 we can see clearly that the LED light are the best choice for our system in short and long term. The lifespan is very high compared with the others. The LED technology is evolving and is noted as the future of lighting. It has very good lumen out and also comes in different colors and wavelength.

2.3.3 Composition of Fish and Crops in Aquaponics

Plants that generally do well in aquaponic systems are leafy crops such a lettuce and herbs. There is a direct correlation between the amount of fish present and the yield and quality of the plants being produced. Plants that fruit, as well as legumes require more nitrogen content for a per square unit yield than plants that do not fruit. The tomatoes is a widely studied fruit, it requires 51.6 kilograms per hectare of Nitrogen to flourish and develop properly. (Timothy, 2009) Non-fruiting plants such as lettuce require only less than 35 kg per hectare of nitrogen (Metabolization rates of Biological Filters). Fruiting plants therefore require approximately fifty percent more nitrogen than their counterparts and this poses a problem in aquaponic systems.

The correlation between nitrogen productions in the form of waste from the fish is not a linear one, doubling the amount of fish will not double the nitrogen content. Most fish will excrete up to one third of their body weight in waste per day, with average levels of 3.97% dry weight of Nitrogen but this

nitrogen needs to be converted to a more useful form by the nitrifying bacteria (J.D., 2006). The process is very slow, the best experimental results show the conversion to nitrates at 1.14 mg per minute per gram of bacteria present in solution (Lena, 2001). Increasing the amount of fish would serve no purpose if the levels of bacteria is not also proportionally increased, here a tradeoff presents itself. The levels of fish and bacteria can be increased to grow fruiting plants, but the heightened levels of bacteria inside the system increase the risk of eutrophication, which is detrimental to the fish. These factors will be carefully considered in selecting the plants for growth, the types of plants will serve as a measure of how much fish is needed to effectively sustain the plants.

The following table is list of plants that have been grown using aquaponics, and are classified by the optimum levels of nitrogen needed for growth. Three levels of nitrogen concentrations of low, intermediate and high were used to classify the plants according to their requirements needed for optimal growth.

Low (25.0-35.0 kg N/ha)	Intermediate (35.1-50.0 kg N/ha)	High (>50.0 kg N/ha)
Leafy Lettuce	cucumbers	Tomatoes
Pak Choi	Squash	Peppers
Kale	Broccoli	Beans
Swiss Chard	Cauliflower	Legumes
Arugula	Cabbage	
Basil		
Mint		
Watercress		
Chives		

Table 12. Nitrogenous requirements of Plants Commonly Grown in Aquaponics

Other plants that can be examined, and can be grown through aquaponics are; herbs, and flowers. Though not listed in the above table herbs generally require a lower amount of Nitrogen than flowers. Flowers Woody flowering species for cut flower production, such as forsythia, pussy willow and flowering cherry, need at least 48 kg of nitrogen per hectare for optimum growth. (Nutrient Recommendation For Commercial Cut Flower Production, 2009) The creation of pigments, and reproductive plants in flowers require larger amounts of nutrients, as these flower heads are sometimes the precursors to fruits. Herbs on the other hand can flourish under conditions where the nitrogen is below 25 kg per hectare. The smaller size of the herbs, requires less nutrients to develop, hence less nitrogen is needed during germination. (H. & Hendawy, 2009)

2.3.3.1 Seedlings

A seedling is a plant that is in early stages of development. Seedlings cannot use photosynthesis to create food and the necessary energy needed for them to survive. As a result, seedlings are dependent on the source of nutrients that they receive from the seed. Seedlings are usually grown in a greenhouse or another indoor medium before they are transplanted from these areas to outdoor environments. (P.H., 2005) This is very beneficial to the seedlings, as during the very early stages of development, seedlings are prone to attack by pest and disease. The protected environment inside the greenhouse greatly increases the chances of survival until the time for transplanting. (Buczacki, 1998) The best time

to transplant young seedlings is when the first true leaves appear, usually 2 to 3 weeks after seeding. However waiting until 4 or 5 weeks after seedling is very common in areas that have harsh winters. Seedlings are started at the end of winter, then transferred as soon as conditions become favorable for planting. (Blazich, 1999)

2.3.3.1.1 Marketability of Seedlings

In the year 2012 the State of Massachusetts generated \$5,407,406 in revenue from Organic food sales. (2012 Census Volume 1, Chapter 1: State Level Data.) Three agrichemical firms—Monsanto, DuPont, and Syngenta—now control 53 percent of the global commercial seed and seedling market. As a result these large companies have the leverage in the market to dictate the prices. More than 80% farmers will at some point purchase seedlings for their land and find the prices of these commercial seeds and seedlings very costly. (Bob, 2013) The seedling market window in Massachusetts is very narrow, the winters prevent growth, so the viable time period is usually early spring up until late autumn.

The seedlings produced by the greenhouse will also have the advantages over seedlings from commercial companies. Most organic seedlings travel less than 100 miles from their first source of growth, while commercial seedlings travel between 300-500 miles from the source. (C, 2008) This difference in distance greatly affects the seedlings, as they are likely to be damaged during excess travel, especially before the plant has fully developed its structures to sustain itself. Local organic seedlings also have a slight edge in marketability due to the stigma surrounding Genetically Modified Seeds. A Genetically modified seed is one in which certain characteristics of the seed have been altered so that the plant matures faster or produces larger yields. These modified plants have been linked with many health related illness, especially digestive disorders, as our body has a hard time processing these foods (Vendômois JS, 2009). The market for these organic seedlings is highly viable even though there is stiff competition with commercial producers.

2.3.3.2 Comparison of Different Fish in Aquaponics

The team decided that a comparison of the three most commonly used fish in interior growing modules would be useful for the design matrix. Our research showed that the best fish to grow within the system was Blue Tilapia. When compared to the two other popular fish (Yellow Perch and Rainbow Trout) blue tilapia can thrive a wider range of temperatures, this will drastically increase their chances of surviving if there is a sudden temperature flux within the system.

The following table compares three vital characteristics for the rearing of fish: Temperature, Ammonia Tolerance and pH range. Blue tilapia is superior in both the temperature range and the ammonia tolerance. Ammonia Tolerance is the highest level of ammonia in the water supply that a fish can live in without becoming toxic to consume. **The team therefore decided that Blue tilapia was the ideal fish for the system.**

<i>Fish Species</i>	Temperature Range *C	Maximum Ammonia Tolerance Level mg/L	pH Range
<i>Blue Tilapia</i>	8.0-42	7.1	3.7-11
<i>Yellow Perch</i>	10.0-37	7	2.6-10
<i>Rainbow Trout</i>	0.0 – 22	6.7	3.7-11

(Mjoun, 2010)

Table 13. Comparison of different Fish Species

Chapter 3 Methodology

The end goal of this project was to help Worcester Roots develop a design for a greenhouse and growing system to be built on at the Stone Soup Community Center, and provide information and a plan for operating it. Our team developed a design for a greenhouse and growing system and worked with Technocopia to build out a prototype growing system.

Our team developed the following objectives to meet our goals:

- Assess the stakeholder's needs
- Investigate existing literature, visit greenhouses in the region, and consult with experts.
- Design greenhouse and growing system that fit Worcester Root's needs (incl. cost estimate)
- Build out prototype system

3.1 Assessing Stakeholder's Needs

In order to fully understand the various stakeholder's needs we participated in regular group meetings at Worcester Roots and Technocopia to provide status updates, discuss design decisions, and steer the course for the project. We met semi-regularly, starting with weekly meetings at the beginning of the project, and later spreading out to weekly or monthly meetings as the project got underway. Early meetings focused on identifying research areas and identifying the role of the IQP group in the greater greenhouse project, while later meetings focused on refining an ongoing design and budget for the greenhouse and growing system, and providing status updates. The project uses an email list for regular communication and update that included all the sponsors and IQP group members and advisors, as well as other interested parties.

3.2 Understanding Aquaponic Greenhouse Systems and Evaluating Design Options

To develop a strong understanding of both aquaponics and greenhouses we consulted the relevant literature, considering both the technical and social aspects related to aquaponics. We investigated the biological characteristics of aquaponics system, and evaluated the benefits and drawbacks that it poses. We identified various components that would have to be used in an aquaponic system as well as in a greenhouse, and researched each of the components individually to best assess the benefits and drawbacks of each one. We also investigated the economic position of aquaponics and similar industries in the United States (specifically hydroponics and aquaculture, the two "parts" of aquaponics). We consulted numerous academic and industrial journals, as well as studies conducted by educational and governmental institutions worldwide.

To further understand aquaponics, we read blogs of other people who built their own aquaponic systems. Many hobbyists and professionals are eager to share their progress and designs in building aquaponic system, and many of the components had do-it-yourself alternatives (such as water tanks) that were documented by enthusiasts online.

The results of our background research is documented in the previous section.

3.3 Designing Greenhouse Structure

The design of the greenhouse and aquaponic growing system was the major deliverable for the project. It entailed extensive research and planning. The major tasks we completed as part of the design were:

- Developing a structure and layout for a greenhouse

- Designing a modular aquaponic growing system
- Developing a budget for implementation of the entire system
- Creating an operating schedule

Using knowledge gained from our research and consultation with experts and practitioners, we developed and iterated our designs, going back-and-forth between designing and consulting with the sponsors, experts, and our research. Additional information about the greenhouse structure was found through intensive research on blogs, web stores, scientific journals, and research published by universities and institutions, as well as interviews with pertinent engineers and scientists in the field. To design the system itself we used CAD programs such as SolidWorks to develop schematics. These schematics also proved useful in communicating our designs with the sponsors and consultants.

In order to determine prices of pre-made materials such as pre-made water tanks and piping, local suppliers were surveyed. For pre-owned materials, such as 55-gallon drums and 1000L water tanks Craigslist (craigslist.com) and eBay (ebay.com) were surveyed in the local area. While these listing are temporary, they represent the rough actual price of locally sourced materials. A bill of quantities was made to keep track of all known and unknown quantities and costs. The bill of quantities along with the price quotes for the different materials were compared with the budget to ensure that all expenses were met.

With the complete startup cost and budget a logistical step by step process for operating the greenhouse was necessary for its longevity. The catalogs for currently established greenhouses and aquaponic greenhouses were researched and a preliminary schedule was synthesized. The initial schedule was then updated after a phone interview with Eric Varinje, a representative from Planet Natural. Planet Natural is a company that specializes in indoor organic growth, greenhouses and hydroponics. With the input from the sponsor (Worcester Roots) the specifics of the schedule, such as the timeframe for growing crops and selling fish were then created. The schedule was synthesized in an attempt to maximize productivity and increase the viability of the greenhouse.

Following are specific extra considerations for different parts of the greenhouse.

3.3.1 Exterior

Professor Alamo, a structural engineer, was interviewed and provided the team with valuable information about the design of the roof, walls, and foundation of the building. Abbie White, a member of the biology department at the Worcester Polytechnic Institute (WPI) was also interviewed and gave some insight on how the greenhouse was built and pointed out a few of the flaws with automated system on WPIs greenhouse.

We also visited three greenhouses to get a feel for the designs and operations. We first visited a local Worcester greenhouse owned by Amanda Barker, and conducted an interview on how factors such as ventilation and internal layout affects the growth of plants. We also visited WPI's own greenhouse on top of a campus building, it has automated heating systems and windows, which present some fatal flaws, such as heating the greenhouse up in the winter and opening the windows when the internal temperature heats a point, cooling the greenhouse again. The last visit was an aquaponic greenhouse in Holyoke, Massachusetts, during this visit we discussed insulation, the design, and interior layout of their aquaponic system to compare to ours.

3.3.2 Interior Layout

The internal layout is an important key to having a successful growing operation. In an effort to maximize the productivity of the greenhouse we engaged in discussion with the sponsor about the criteria and constraints for the design. An internal design designating the position of the tanks and beds relative to each other was then synthesized to reflect the ideas of the sponsors. These ideas included enough space for moving around and demonstrations and efficiently organized tanks and beds for maximum productivity. These designs were created using the program Solid Works and their feasibilities compared.

The constraints for the internal layout that were to be researched and compared were the tanks, the growing beds, the walkways, and the width of the doorways. Growing beds were designed using the Solid Works program and the design for the tanks were researched to see what shapes would accommodate the best circulation of water. The length of the walkways and the width of the door were cross referenced with building codes and other designs to see that they had both functionality and comfort for the users of the greenhouse.

3.3.3 Interior Heating

The interior design with the ecosystem cannot function without adequate heating when we consider the climatic zone in which this greenhouse will be constructed. The most important factors to take into consideration are the temperature and the sunny days. Data on the average daily temperatures, and the amount of sunny days during the winter months were retrieved from National Oceanic and Atmospheric Administration (NOAA) for the city of Worcester in last 50 years. These data sets were used to calculate how much it would cost to heat the greenhouse to a temperature suitable for plant and fish growth.

Insulation is another factor that will affect the heating of the greenhouse. The heat loss of the material used to cover the greenhouse is an important consideration. The average monthly heat loss was calculated using the worst commercially available insulator, for the calculations we also assumed that the exterior temperature would be equivalent to the average low of previous years, the temperature needed for germination of plants was 65F and water temperature needed to support fish life was 75F. The heat loss was then used to determine how much heat needed to be supplied to the system to maintain these specific temperatures. Other factors that affected the heating process such as the circulation of water were also included in the calculations then the energy value was then translated into monetary units to predict the monthly cost to sustain the system.

3.4 Designing Growing System

3.4.1 Plant and Fish

The next step in the project was to determine the maximum size of the ecosystem that the best interior layout could support. Preliminary research into the amount of nutrients needed for plant growth and the amount of dissolved oxygen and microbes that were necessary for fish growth were conducted. These values were then tabulated to determine specific ratios necessary for the operation of the aquaponic system. The preliminary calculations were then used in parallel with other findings in the literature and information from members in the aquaponic community to determine these specific ratios. The ratios include the amount of water needed per pound of fish, and the amount of fish needed to sustain one square foot of growing bed.

3.4.2 Bed

The structure must be carefully designed to ensure that the growing bed will be able to withstand the water that it contains. The structure must be made from materials that are readily available. Using non-standard materials can add complexity to the project. It is best to use materials that are both cost effective and widely available. We took inspiration from existing successful designs for our growing bed design.

3.4.2.1 Growing Bed Stand

The stand was designed to allow at height interaction with the growing bed, and to allow gravity draining into the fish tank. The stand must be able to sustain the weight of the bed, which was estimated at 2000 lbs. max. The stand lifts the growing bed so that it is at level for someone to comfortably work on it. It also acts as a support for the growing bed that lies on top of the stand. It also has been designed to properly fill and drain based on the fish tank that is being used. The growing bed weighs over 2000 pounds when filled with water. This large amount of weight needs a support that is

3.5 Developing a Cost Estimate for Building and Operating Greenhouse

In order to determine prices of pre-made materials such as pre-made water tanks and piping, local suppliers were surveyed. For pre-owned materials, such as 55-gallon drums and 1000L water tanks Craigslist (craigslist.com) and eBay (ebay.com) were surveyed in the local area. While these listing are temporary, they represent the rough actual price of locally sourced materials.

A bill of quantities was made to keep track of all known and unknown quantities and costs. The bill of quantities along with the price quotes for the different materials were compared with the budget to ensure that all expenses were met.

3.6 Creating an Operating Schedule

With the complete startup cost and budget a logistical step by step process for operating the greenhouse was necessary for its longevity. The catalogs for currently established greenhouses and aquaponic greenhouses were researched and a preliminary Schedule was synthesized. The initial schedule was then updated after a phone interview with Eric Varinje, a representative from Planet Natural. Planet Natural is a company that specializes in indoor organic growth, greenhouses and hydroponics. With the input from the sponsor (Worcester Roots) the specifics of the schedule, such as the timeframe for growing crops and selling fish were then created. The schedule was synthesized in an attempt to maximize productivity and increase the viability of the greenhouse.

Chapter 4 Findings and Accomplishments

In an attempt to design the most efficient aquaponic greenhouse several decisions about the exterior and the interior design had to be made. This section aims at justifying the decisions made in terms of the Greenhouse external structure, the foundation, the interior layout, the ratios of the plants to aquatic life and the operating schedule. The results are presented in both a qualitative and quantitative manner, this reflects the importance of the analytical data and the critical thinking skills required for the success of this project.

4.1 Stakeholder's Needs

The design will need to function in cold winters and hot summers, so must be **energy efficient** to reduce costs as well as to encourage a green economy; the design should be **cost effective** so we must weigh the costs versus the benefits of different solutions to best fit our budget and limit waste; the design should be **sustainable**, using locally sourced materials to promote a local and green economy; the design should be **maintainable** and resistant to vandalism, so that ongoing costs are kept to a minimum; the design should **maximize food production**, as the goal of the project is to provide food, rather than other commodity crops; the design should **enable education**, to allow for ease of bringing in local high school students or tour groups to learn; the design should be **fit for local market demand**, similar to being sustainable, so that the system can be self-sustaining and can provide to the local demand; the design should be **scalable** so that our work and research can apply to larger future systems. As well, the design must be finished by the end of the WPI school year; the design must fit into the allotted space – a 20'x33' area behind the Stone Soup Community Center in Worcester; it must fit into the budget Worcester Roots has raised, roughly \$5500 for the growing system and roughly \$20000 for the greenhouse structure and site work; it must follow all city and state rules and regulations, including zoning, safety, and licenses.

4.2 The Greenhouse

Our greenhouse design is based on the standard rigid frame greenhouse design. This design has a strong structure and require a strong base. It is normally used when the paneling is a heavier material, like glass, but its strength will come in handy when the winter storms and snow comes.

If it was a smaller greenhouse, the structure would not be affected by the weather, but since our greenhouse is long and wide, the rigid frame is the best choice. The dimensions of the greenhouse are the following:

- 33 feet long.
- 22 feet wide.
- 8 feet high walls.
- 4 feet high gable.
- 4 feet deep for the foundation.
- 12 feet long roof panels.

The material used to build the greenhouse frame was wood. According to Professor Alamos, aluminum is not rigid enough to be, by itself, the outer structure, besides, it would be almost three times the cost to build it. As for a steel frame, it would require more professional work, like welders and heavy

machinery to bend and cut steel bar, also, the cost of steel is close to double of the cost of wood (Alamos, 2015).

Taking these facts into consideration, the best and most reliable material to build the outer frame is wood.

The following design reflects using wood as the main material. For a steel greenhouse other options would have to be taken in consideration, therefore the overall design would change. Figure 328 shows rigid frame greenhouse made out of wood.

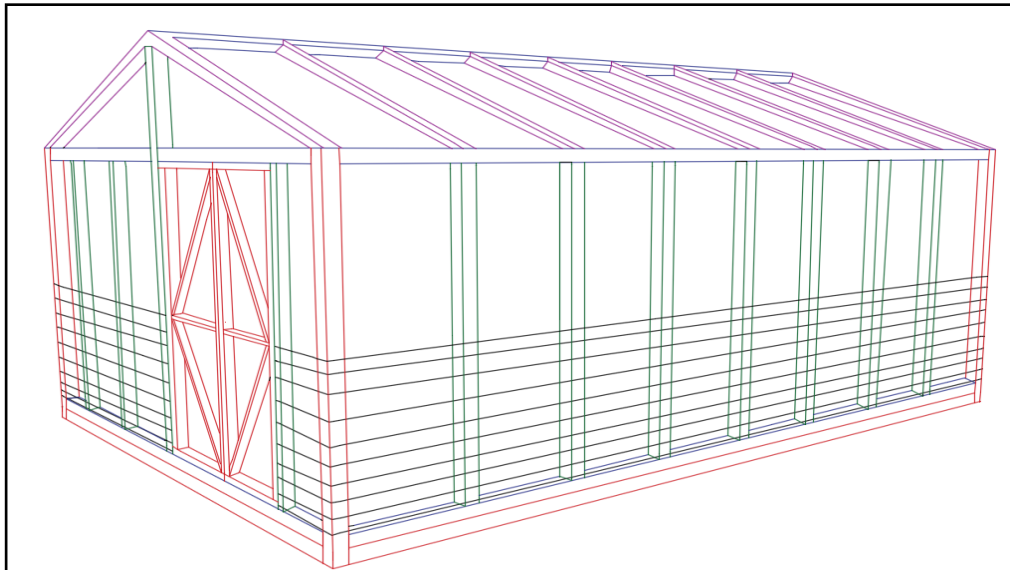

Figure 32. Rigid frame greenhouse with double doors

RED 10 12' long Pressure treated wood.

RED 4 10' long Pressure treated wood.

RED double door made out wood. About 7' wide.

BLUE 7 10' long Base/top lumbars.

BLUE 16 12' long Base/top lumbars.

DARK GREEN 22-30 8' long studs lumber.

DARK GREEN 2 12' long studs lumber.

PURPLE 18 12' long shaft lumber.

BLACK the black lines represent the part of the building which is not

The walls of the greenhouse will be plywood up to a height of 4 feet on the sun-facing sides, with a full plywood wall on the north facing wall. This is possible due to the fact that we are building an aquaponic greenhouse, which does not have plants growing on the ground.

The base of the structure is a wider pressure treated lumber that anchors the structure to the foundation (described below) and serves as studs for the corners of the structure.

For the base, the pressure treated wood that goes inside of the sonotube (sonotubes are a foundation component explained in section 4.2.4), and they will also serve as studs on the corners of the structure. This structure would be stronger against lateral forces, what is a major requirement for places with strong winds or storms. Another options to connect the upper body of the structure with the foundation is to replace every stud that would go on top of the footed sonotube with these long pressure treated wood studs planted in the sonotubes. This design would give the maximum resistance against the lateral forces but it would also significantly increase the cost of the greenhouse.

For more information of the area, volume, and other dimensional aspects of the greenhouse refer to appendix A.

4.2.1 Frame Design - Roof

The roof of the greenhouse is an important piece to be considered, the roof has to support the heavy weight of the wet snow, have enough light transparency, and has to be made out of a good insulating material in order to reduce the energy costs since most of heat loss happens through the roof.

Other aspects that were considered are height of the roof and the quality of the materials that will compose the frame of the greenhouse. The flatter the roof gets, the stronger that frame has to be in order to support direct weight for longer periods of time.

As for the structure, it has to be strong enough to hold the wait of the roof plus the weight of the snow. While talking to Professor Alamos, structural engineer, three types of roof came up: the Collar tie roof, pre-engineered truss, and diagonal bracing. More information about the styles of roof can be found in appendix D.

We recommend the pre-engineered truss, because it serves as a reinforcement for the roof. The triangular shape is known to have little to no deformation over the time because in every corner where stress is applied there is reinforcement on the other side to distribute the load.

A pre-engineered truss is shown in the Figure 33.

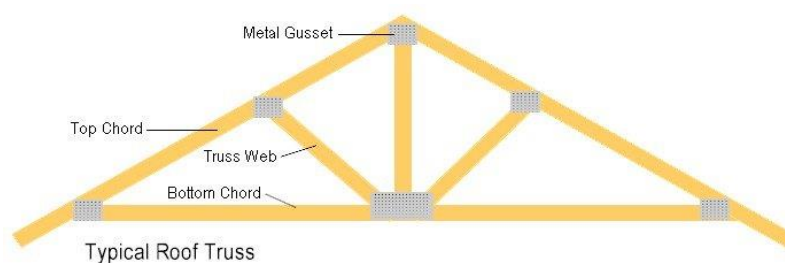

Figure 33. Pre-engineered Truss

(Engineering)

The draw backs of this roof is that it takes more material to build, thus making the structure more expensive, and it also takes more space inside of the greenhouse, which might affect light transmission.

4.2.2 Frame Design - Walls

The walls will need to withstand lateral forces; therefore a system to resist these forces is needed. Unfortunately, glassy materials, like plastic, glass, or fiberglass, do not have the properties to completely oppose these forces. Therefore, other methods to resist lateral forces have to be found.

One simple way to resist them is the use of diagonal posts. Using diagonal posts in between the studs on the walls of the greenhouse ensure that the structure will hold the lateral forces by tension and compression of these posts. Ideally, the diagonal posts are placed in between every stud. However, most of the greenhouse is transparent, having posts in the middle of every stud would considerably reduce the light transmission for the plants. Therefore, to be on the safe side, one option is to use one post on every few studs, as shown in Figure 34, preferable closer to the fish tanks where the lack of light will not affect the growth of the ecosystem.

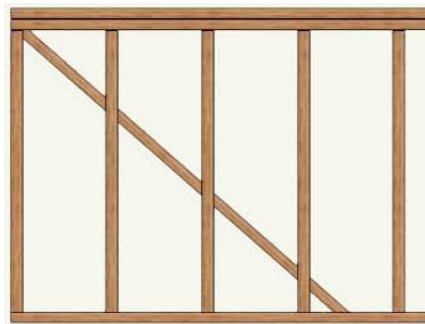

Figure 34. Diagonal Post on Walls

Normally aquaponic systems have beds that are a few feet above the ground. With this consideration we can build wood walls until the height of the beds. From our structure design we can build a 4 feet high of non-transparent material in three walls and an entire non-transparent wall.

The parts of the greenhouse where transparent walls are not required should also be insulated as much as possible to diminish the heat loss. A cheap and effective way to do this is to use double skin of plywood, one on the outer wall and one on the inner wall, and in between fill it up with insulating material, like fiber glass. Figure 35 shows how the fiber glass is placed in the middle the walls.



Figure 35. Double Skin Wall filled with Fiberglass

In the picture there is an outer wall of wood. In between of every stud it is filled with fiber glass, and after there will be an inner wall. Insulating well the parts that are not transparent will improve thermal efficiency of the greenhouse.

The total cost for the greenhouse paneling, including the double skin of wood and the fiber glass ranges from \$3046.20 to \$3592.00, what is a reasonable price for the quality of these materials.

For the calculations on the prices to insulate the walls of different designs and different materials, refer to appendix E.

Also, this design of greenhouse gives the optimal heat retention. The values of heat loss vary from 32076 Btu/h and 24057 Btu/h, if the difference of temperature is 45 degrees Fahrenheit.

For more information on heat loss for different designs of the greenhouse and different materials for paneling, refer to appendix F.

4.2.3 Floor

Our choice for the flooring of the greenhouse is the combination of crushed stone and a special greenhouse flooring. The first idea was to use pea gravel, but taken in consideration the cost and the applications, we decided crushed stone would fit our needs better

This special floor is a porous fabric that will facilitate water drainage and also block weed from coming inside the greenhouse. The fabric is easy to install and it will go on top of a foot deep foundation made out of crushed stone.



Figure 36 Special greenhouse floor

(the Greenhouse catalog)

As for the stone, we will use the crushed stone that is stone broken into small pieces to have a firmer feel on the floor and also to facilitate the movements of people in wheel chairs. This floor will cover the entire floor and be one foot deep into the ground to prevent water accumulation on the surface of the floor.



Figure 37 Crushed stone floor

(Little Greenhouse)

To figure out how much crushed stone we will need, we have to multiply the length by the width of the floor and multiply this result by how deep we want the floor to be. In this case, it will be 33ft by 22ft by 1ft giving us a total of 726 cubic feet. Since this number is in cubic feet we divide by 27 to get your cubic yardage.

A rough estimate for crushed is 1.4 tons per cubic yards, so multiply 27 by 1.4 to get about 38 tons of pea gravel.

As for the price, the cost of the fabric is about 40 cents per square foot, according to the online store greenhousecatalog.com. To cover our entire floor we will spend about \$291.00. The price of the crushed stone is trickier to calculate since its price not only varies per region but it also varies depending on how much is needed and how much it is available. According to Dirk Braen, "Crushed stone runs from about \$20 per ton for screenings or dust up to around \$35 per ton for 3-5" stone. Crushed stone that is similar in size to pea gravel runs about \$30 per ton." (Braen, 2013).

To find an estimate of how much we will spend in crushed store we used \$30.00 per ton and using 38 tons of crushed stone for our floor, that came out to be \$1140.00. Adding this price with the price of the fabric we will spend about \$1431.00 to make our entire floor.

Although it is expensive it is not nearly as expensive as it would be if we used a concrete floor and we know for a fact that this style of floor will give us the best results on the long run because it is deep enough to absorb all the water excess and keep the weeds from growing inside the building.

4.2.4 Foundation

The foundation of the greenhouse is responsible for holding the entire structure in a good standing. Normally a footed frame of two feet deep is enough to hold the structure in place, but in regions where there is unusual weather conditions, like in New England, or where the floor freezes during periods of the years, a deeper foundation is required.

When the ground freezes it oscillates, making the structures on top of it move. To prevent this from happening, a deeper foot is necessary. The frost bite, usually, only affects the first couple of feet, therefore, the foundation should be at least four feet deep to avoid the disruption of the structure.

To achieve that, we are recommending the use of SONOTUBEs which costs about \$7.00 apiece. A sonotube is shown in Figure 38.



Figure 38. Sonotube being installed
(Roberts J. , 2012)

This particular sonotube is sited on a block of concrete, but there is other cheaper options like the Redi plate sold at Home Depot for about \$20.00 apiece.

After digging the hole and placing the sonotube in it, it is filled with concrete and a wood post is than placed in the middle of it to build the structure from there.

A good rule of spacing for small structures is to have one sonotube every eight feet. This distance ensures a strong foundation and a good spacing in between them.

An estimated cost of the materials used in the construction of our greenhouse is show in Table 14, other choices of materials and their costs can be found in appendix B.

Materials	Amount	Dimensions	Sources	Total Cost
Wood		Various	Plywood plus (local)	~\$2000.00
Paneling				

Solexx XP pre-cut 3.5mm	1188 ft. ²	4.13' x 8.25'	Greenhousemegastore.com	\$1627.56
Nontransparent Walls				
Plywood	572.0 ft. ²	¾" x 4' x 8'	Home depot	\$1246.96
R13 Roll	572.0 ft. ²	1.24' x 32.00'	Home depot	\$171.60
Foundation				
Sonotube	~14 pieces	0.80' x 4.00'	Home depot	\$97.86
Redi base	~14 pieces	0.60' x 2.00'	Home depot	\$279.86
Totals				
Total Wood (approximate)				\$5423.84

Table 14. Estimated Cost of Materials for the Structure

For more information on the structure materials refer to appendix B.

Although this table has good approximations, it is always good to plan to spend about 20% more than estimated.

4.2.5 Ventilation

Ventilation is essential for both the structure and the ecosystem inside of the greenhouse.

To choose the fans it is required the total volume of the greenhouse and the rate of air change per min. With this numbers we can calculate the cfm (cubic feet per minute) that is required.

Amanda Barker, who directs a greenhouse, advise on the use of two fans on opposite walls as well as doors on both side to facilitate air circulation and the cooling of the building in the summer.

4.2.6 Heating

We found that to prevent frost during the winter and keep ambient temperature up, especially at night, a space heater would be strongly recommended. Operating a greenhouse in a location with a very cold climate is very challenging due to the heating cost. Beside the expensive heating equipment required when we first set up the greenhouse, looking forward in long term the energy required to maintain the greenhouses in a steady temperature is really high especially in the winter months. In Worcester according to the table below the temperatures are below our indoor temperature goal of 60 F most appropriate for seedlings.

	Jan	Feb	Mar	Apr	May	Jun	Jul	Aug	Sep	Oct	Nov	Dec
Average high in °F:	31	35	43	55	66	74	79	77	70	58	48	36
Average low in °F:	17	19	26	37	47	56	62	60	53	42	33	23

*Source: NOAA.gov

Table 15. Monthly Average Temperatures for Worcester

As we can see the average low temperature is in January and it is about 17 F. A very good practice in designing systems is to take in account and to calculate the worst case scenario in order to promote a more efficient system. For this reason in all the heating calculation we used the lowest average temperature taken from the tables above.

Another important aspect that we will need to determine is the exposed surface area of the greenhouse. That’s where the heat is going to escape. To calculate the surface area we have to design a rough design of the greenhouse with exact dimensions. After that we use the calculations in appendix A to determine the total surface area. A design sample is shown in the diagram nr 1.

From the calculation we see that we have a total exposed surface area of: **1760 sq. ft.**

The next part of the equation for the heat is the heat loss coefficient of the material used. In our design we choose Solexx as the best material. It is a very good insulator with thermal coefficient of 0.45 and is widely used amount greenhouse builders. From the calculation (Appendix B) the total energy required to maintain the temperature at 60F is about 3618529686 BTU or 10.601 KWH for the lowest average temp yearly.

We also have assumed that the heating is going to get generated by electrical energy so the cost is going to be calculated in price per kWh, currently in city of Worcester. After considering all this factors and using the formulas in Appendix C we have the highest possible costs shown in table 21. This is a high estimate and could be reduced by lowering the target temperature inside the greenhouse in the winter months.

	JAN	FEB	MAR	APR	MAY	JUN	JUL Y	AU G	SEP	OCT	NOV	DEC	Year
Temp.	17	19	26	37	47	56	62	60	53	42	33	23	39.583 33
kWh	3259	3142	2536	1765	955	265	0	0	478	1345	2042	2745	1544.3 33
Cost	554.03	534.1 4	431.12	300.05	162.35	45.05	0	0	81.2 6	228.6 5	347.1 4	466. 65	262.53 67
Cost with Sundays	397.05 48	400.6 05	316.15 47	220.03 67	119.05 67	32.285 83	0	0	56.8 82	160.0 55	260.3 55	342. 21	189.24 52

*Assuming 0.17ct/kWh

**Assuming the temperature is at lowest average all month

Table 16. Estimated Monthly Heating Costs

As a conclusion see that the cost is relatively high in the winter months. So in order to run throughout the winter we would need efficient heaters to ensure a minimum temperature. Also to reduce the costs we need other methods of insulation. So to compensate the 8.668 kWh loss we will need an electrical heater or combined heaters that will have rating of at least 9 kWh, where we have to include their efficiency that is not 100 %.The recommendation we identified 2 heaters that could fit our solution, the King Pic-a-Watt 240v Electric Heater, providing 5.7 kW for \$399, and the Dayton U36 240v Electric Heater, providing 5.6 kW for \$179.

4.3 Aquaponic Growing System

4.3.1 Plant and Fish Ratio

The recycling mechanism of nutrients in the aquaponic system requires careful planning on how much fish, water and growing space is needed to achieve optimum growth. Initially our calculations showed (see Appendix) that one fish required 3.5 gallons of water. The waste material from this one fish could support one square foot of growing bed. However research conducted by Aquaponic Specialist Sylvia Bernstein had different ratios and these differences are shown in table () below. (Bernstein, 2013)

Criteria For Greenhouse	IQP Findings	Sylvia Bernstein Findings
Assumed Weight of 1 Fish	1 Pound	1 Pound
Gallons of Water required per Fish	3.5 Liters	5-10 Liters
Growing Bed Area Supported by 1 Fish	1 Square foot	1 Square foot

Table 17 : Comparison Of IQP and Bersntein Ratio Findings

The table shows that similar ratios and assumptions were made. The only Criteria that was vastly different was the amount of water needed to support one fish. The Calculations of the IQP group seemed to underestimate how much water was needed by each fish. Therefore an average value of the Sylvia Bernstein findings (7.5 Gallons of water per fish) was used as a bench mark for the design of how much water, tanks and how much growing beds could be supported by the system.

4.3.2 Growing Bed: Wooden Bed vs 55-Gallon Drum

Beddings are a very important part of a greenhouse setup. Growing beds are where the plants get their nutrients and grow. There are several types of growing beds that are used in an aquaponics setting. Some are available commercially and others can be easily made with materials that are readily inexpensive and easy to acquire. We considered two types of beddings; a custom made wooden bedding box, and 55-gallon plastic drum cut vertically in half.

4.3.2.1 Wooden Box Growing Bed

This option was to construct a custom wooden box using readily available materials, and then using a pond liner (found at any home improvement store) to line the bed. Table 18 shows the cost breakdown of the growing bed. We designed the bed to maximize the use from standard sizes of plywood.

<i>Item</i>	<i>Cost</i>	<i>Quantity</i>
<i>¾" x 4' x 8' Plywood</i>	\$34.98	x2
<i>2" x 4" x 8' Wooden Reinforcement</i>	\$2.76	x5
<i>Pond Liner 10' x 13'</i>	\$59.97	x1
<i>Total Cost For One Bed</i>	\$132.69	

Table 18. Bed Cost Breakdown for One Bed

The bed is made from plywood and has 2x4 boards wrapped around the entire outside of the bed for added support. Water is quite heavy and this places stress on the components. The pond liner contains the water as water may seep into wood and leak, as well as causing the wood to rot. A pond liner is an

elastic plastic sheet that can be used to line walls of the wooden growing bed. It is made of chemical and UV resistant plastic, and is safe of the fish and plants that would be used for consumption.

The bed design may be altered easily to change the depth from 12" to 6", to decrease the amount of water required and also reduce the maximum load of the bed. The table below shows both variants of the growing bed.

Dimensions	Volume	Gallons (water)	Weight (water)
4x8x1 feet	32 cubic feet	239.04	1,994.8 lbs.
4x8x0.5 feet	16 cubic feet	119.52	997.4 lbs.

Table 19. Variant of Bedding Designs

For this bed design a stand was required to elevate the bed to standing height, as well as above the fish tank. The stand is made out of lumber because it is strong and inexpensive compared to steel or aluminum. The legs are 3 feet tall. There are five feet. Four of the feet are on the corners of the stand, and the fifth is on the center for added support on the base. The legs are held in place with 2x4s. There are also 2x4 supports for added stability on the bottom half of the outer legs. This design is quite simple, but it is strong enough to support the weight of a growing bed that is completely filled with water.

Overall this design is easy to manufacture from components that are inexpensive and easy to find at almost any hardware store or specialized wood supplier. Many duplicate growing beds could be manufactured for use in an aquaponics greenhouse. This type of bedding holds a large amount of water. Due to the fact that they hold more water than smaller tanks, extra precautions must be taken to ensure that the growing bed doesn't fail and break. Schematics and renderings can be observed in the Appendix P.

4.3.2.2 55-Gallon Growing Bed

55-gallon drums are in abundance. They are used to store many different types of liquids. While their purpose was not to be used as a growing bed in an aquaponics system, they can be repurposed and converted into a growing bed. These drums can be either purchased as new or used. Used 55-gallon drums go from around 10-15 dollars. New ones are more expensive and go for around 60-80 dollars. Used drums can easily be cleaned out and used in an aquaponics setting if the drum was not used to store dangerous or toxic chemicals. Otherwise they would work perfectly fine.

Once the drum is purchased, it can be cut vertically in half. This allows the tank to be formed in the shape that it will be used in the greenhouse. It can also be cleaned of any residue left from its prior use. These drums are generally made of chemically resistant plastic that is a food grade plastic. Below is an image of how these drums can be used in an aquaponics greenhouse.



Figure 39. 55-Gallon Drum Beds
http://farm4.static.flickr.com/3341/3580585324_f90c15b787.jpg

These drums are very inexpensive which allow for lower costs for the greenhouse. They are easier to modify than to fabricate the wooden growing beds mentioned earlier. They do, however, lack the professionalism that the custom wooden growing bed has. The wooden growing beds are specially designed for use in the greenhouse. The 55-gallon drums hold significantly less water than the specialized wooden growing beds and they have an unusual shape after they have been cut which make them prone to rolling because they don't have a flat base, however they are a good inexpensive alternative to the more expensive wooden growing bed.

4.3.2.3 Comparison: Wooden Bed vs. 55-gallon Drum

The wooden growing beds hold a significant amount of water, ranging from 120 – 240 gallons. The plastic drums hold a little less than 27 gallons when cut in half. This is significantly less than the wooden growing bed. Whether or not such a large amount of water is required will ultimately determine which bedding style would be used. If a larger amount of water is required, it would be more space efficient to use the larger tank seeing that the use of many smaller tanks would take up a large amount of space in the greenhouse.

Bedding Style	Volume	Gallons (water)	Weight (water)	Cost (\$)	Difficulty to Produce
<i>4'x8'x1' wood</i>	32 cubic feet	239.04	1,994.8 lbs.	~134	Moderate
<i>4'x8'x0.5' wood</i>	16 cubic feet	119.52	997.4 lbs.	~100	Moderate
<i>Cut 55-gallon drum</i>	3.75 cubic feet	27	225.6	~5-7	Easy

Table 20. Bedding Style Comparison

4.3.3 Water Tank

To find an ideal fish tank for our aquaponic system we investigated professional solutions advertised for hydroponic and aquaculture setups, looked at do-it-yourself projects for water tanks, and spoke with those that had experience with fish and hydroponics. Many hobbyists write up or record their aquaponics builds and upload them to the internet, which provided inspirations for our designs and initial research. The water tank needed to be easy to procure or create, sturdy enough to handle large volumes of water, and provide easy access to the fish. Ease of cleaning and water flow also impacted the tank design – rounded corners or a cylindrical or conical design would be self-cleaning, versus hard edges.

A 1000 liter intermediate bulk container (IBC) tote—a commonly available and used industrial water tank—was found to be the most effective solution for the primary fish tank for the modular system. It was compared against 55 gallon drums—another common type of industrial storage, a wooden tank design—a cheap design similar to our bed using plywood and reinforcement, and injection molded plastic tanks—large professionally made tanks. The IBC tote proved most cost effective, and was readily available in local sources. A plywood tank could potentially provide additional cost savings, but the additional labor involved was deemed not worth the marginal cost savings over the IBC tote. 55 gallon drums also could cost less than IBC totes for our system, but would require additional piping and pumps, and would increase overall complexity, so was ruled out. The injection molded tanks were the most expensive option, required shipping from out of state, and were unwieldy, so were ruled out.



Figure 40. The IBC Tote was recommended to be used as a fish tank

Type	Product	Unit Cost	Units	Cost for System	Add'l. costs
Large Plastic	1500 Gallon, 30" Depth	\$650 + Shipping ¹	4	\$2600 + Shipping	Construction and fitting of drains.
	800 Gallon, 38" Depth (631 gal usable)	\$808 + Shipping ¹	3	\$2424 + Shipping	Construction and fitting of drains
	650 gallon, 30" Depth (Cone bottom w/ drain)	\$650 + Shipping ¹	3	\$1950 + Shipping	
	300 Gallon, 30" Depth	\$518 + Shipping ¹	5	\$3108 + Shipping	Construction and fitting of drains
Wood Tank	Blaine's Design	\$133	8	\$1064	Tanks would all be handmade.
Plastic Tote	275 Gallon, 45" Depth (183 gal usable)	\$75 ²	10	\$750	Tops would need to be cut off for access.
	275 Gallon, 45" Depth (183 gal usable)	\$125 ²	10	\$1250	Tops would need to be cut off to access.
Drum	55 Gallon Poly	\$30 ²	32	\$960	Would need to be cut open for access.

	55 Gallon Metal (Not cleaned)	\$10 ²	32	\$320	Would need to be cut open for access. Need to be cleaned.
1: http://www.graystonecreations.com 2: http://craigslist.org					

Table 21. Estimated Cost of Water Tank Options

4.3.3.1 Water Tank Result/Recommendation

The 275 Liter plastic totes were chosen because they can be sourced cheaply and easily (see table), are modular, and reliable. Wooden tanks are attractive because of the price, but plastic totes are in a similar price range and are far easier to source. Large plastic tanks, while more robust, are much more expensive (especially in smaller sizes), and cannot easily be sourced. 55 Gallon drums are another cheap solution, however we would need a very large number of individual tanks for our system, which would create rather complex piping setups. As well, they do not have flat bottoms (if turned on side) and would need special mounting. Metal drums have the additional issue of needing to cut them, creating potentially dangerous edges.

The more individual tanks there are, the more individual pumps would need to be purchased. The totes provide a balance between number of systems and price. Having 10 individual systems also provides resistance to disease, while not being unmanageable.

4.3.4 Water Heating

Since our target temperature for the greenhouse will be 60 F, the temperature in the water tank will be the same as the greenhouse consequently. In this condition we will have a water temperature at 60 F all the time. Many fish species can survive in this conditions and that includes tilapia .Since we want the maximum yield from the fish we need to create optimum environmental factors. In order for tilapia to thrive the optimal temperature is 75 F, and to achieve this we will need to install additional heaters to warm the water.

We have concluded that we will use around 1500 gallons of water to properly provide enough nutrients for the area of seedlings we are going to grow. From the calculations (Appendix C) we will need a water heater with the power rating of 1.8 Kwh to compensate for the heat loss during the circulation of water and from the surface of tank .The monthly cost except the summer months when the temperature during the day goes around 75 F is calculated as below:

$$1.8 \text{ kWh} \times 24 \text{ hours} \times 30 \text{ month} \times 0.17 \text{ \$/kWh} = \mathbf{\$220/monthly}$$

We also have to note that the amount of energy lost from the water will heat the greenhouse itself so it will help the structure heaters lowering their consumption.

The recommended heater for the tank is the one shown in the Figure 41 and will cost \$296.We will need two of them to fulfill our power requirement.



Figure 41. Submersible Water Heater

4.3.5 Water Circulation

The aquaponic system requires that the water circulates constantly in the system. In order to complete the cycle we will need water pumps to pump the water in the growing beds. The return water will flow in the fish tanks by gravity.

The factors to take in consideration we choose a pump are the GPH (gallon per hour) rating of the pump and the static head. Gallon per hour is the amount in gallons that the pump can deliver in an hour. The static head is the maximum high the pump can deliver it. The relation between these two properties is shown in appendix D.

According to brightagrotech.com, a professional aquaponics website we need to circulate the water in the system every two hours. There is a lot of flexibility but for starting systems that what they recommend. For design purpose and actually practical implementation we did consider a portion of water from our tank. The amount we take is 100gall of water. The reason why we do that is that in this case I better if we use several pumps instead of only one that can deliver for the entire 1500 gallon amount. That is impractical because we have a really small scale system for that powerful pump. We to have to take in account that that kind of pump will have to deliver around 750 gallons per hour. The piping involved will be outside of the scope of our system and will need a more professional crew to install them. The system will completely rely on that pump and it is not going to be modular. Also the risk of disaster is great due to the high pressure that pump will have on its primary pipe. Going back to our 100 gallon assumption we will need around 15, 50 GPS rating pumps to circulate the water around efficiently. Table 22 shows all the pump options

	Ponics Pump PP12005	EcoPlus 728310	Ponics Pump PP29105	Hydrofarm AAPW550	Hydrofarm AAPW1000
Average User Rating	(4 / 5)	(4.2 / 5)	(4.3 / 5)	(4.6 / 5)	(4.6 / 5)
Gallons Per Hour (GPH)	120 GPH	396 GPH	291 GPH	550 GPH	1000 GPH
Adjustable Flow Rate	✓	✗	✓	✓	✓
Inline Option	✓	✗	✓	✓	✓
Filter	✓	✓	✓	✓	✓
Static Head	4 ft.	6 ft.	6 ft. 3"	7.9 ft.	12.13 ft.
Rated Output Pressure	N/A	N/A	N/A	3.5 PSI	4.9 PSI
Recommended Tank Size (gallon)	20	40	30	55	100+
Weight	N/A	2 lbs.	N/A	3 lbs.	4.5 lbs.
Dimensions (L x W x H)	1.97" x 1.73" x 1.26"	8.6" x 5.7" x 4"	3.50" x 2.80" x 3.27"	7.9" x 5.5" x 4.5"	9.4" x 5.3" x 5.1"
Price	<u>\$30</u>	<u>\$26</u>	<u>\$46</u>	<u>\$50</u>	<u>\$70</u>

Table 22. Different Water Pumps

The recommended pump is the Hydrofram 1000 because it is powerful, it has a relatively high static head without losing pressure and also has a variable flow rate that is very important in case we change water tank configuration. The pump has also a filter and we can connected it inline. In our system this specifications are important because we can change the configuration

4.4 Operating Schedule

Aquaponic Greenhouses require an ambient temperature of approximately 70F to support the ecosystem present. The constraints that the climatic conditions here in Worcester present are very limiting. The average low for the months of January and February are below 20F. This makes operation in the winter months very questionable. The following table is a tentative schedule that attempts to maximize profitability of the green house by closing it down during the colder winter months. An organized schedule of the greenhouse is important for maintenance and will also help to educate others about the difficulties faced in managing an eco-system in this cold climate region.

Month		Additional Comments
January	"Sales of Winter Crops"	-High Cost of Heating -Lack of Natural Sunlight -Plants will include lettuce and leafy vegetables
February	Prepare seedling beds	-High Cost of Heating -Lack of Natural Sunlight
March (Assume we start the greenhouse at this month)	Begin Planting Seedlings Stock Fish	-Risk of Frost still Present (Very Dangerous to Seedlings)

		-Seedlings take 6-8 weeks to mature -Fish take approximately three months to mature
April	Preliminary Sales of Seedlings to Local Markets	-Major Source of Income for Greenhouse
May	Preliminary Sales of Mature Plants to Local Markets	
June	Preliminary Sales of Mature Fish Planting of "Warm Climate"	-Sales begin after Fish have had time to replenish These plants do well in Temperatures over 60F
July		
August	Sales of Warm Climate Plants	
September	Planting of "Cool Climate" Plants	These plants do well in temperatures 40-50 F
October		
November		
December	Fully automate the heating for the winter months to come. Planting of "Winter" crop Sales of Cool Climate crops	-Plants are at great risk for frost, adequate heat is needed to preserve fish as well.

Figure 42 : Tentative Operating Schedule of Greenhouse

Month	Sunny	Partly Sunny	Total Days With Sun
January	9	8	17
February	8	7	15
March	8	8	16
April	7	9	16
May	6	10	16
June	6	11	17
July	6	12	18
August	8	11	19
September	9	9	18
October	10	8	18
November	7	8	15
December	8	8	16
Annual	90	107	197

Figure 43 : Monthly Sunshine Days for City of Worcester (Center, n.d.)

Though the data suggest that lack of natural sunlight and the extreme cold temperatures. It is possible to run the greenhouse through the winter months. We decided this would work it would be more expensive to restock the system once a year than it would be to run it constantly with heating over a three year period. A phone interview with Eric Vinje a representative from Planet Natural suggested that we also run the greenhouse year round and if the cost was too high we could then consider closing it down for the colder months of the year.

The Operating schedule also specifies three types of planting seasons. The warm and the cool climate plants. Cool climate plants usually have edible leaves or roots (lettuce, spinach, carrots, and radishes); others (artichokes, broccoli, and cauliflower) are grown for their immature flowers. A few of these plants (peas, broad beans) produce edible seeds. Warm season plants require higher temperatures and once the fruit begins to germinate it needs up to two months of frost-free weather to reach maturity. These warm season crops include tomatoes, peppers, cucumbers and eggplants. The weather in Massachusetts prevents these crops from being planted until the summer months hence the schedule reflects the two growing seasons. (Greenline, 2010) The third type "winter crops" refers strictly to plants which have thick leaves such a lettuce, they are more resistant to colder temperatures and will be easier to grow in the winter when the constraints of temperature and nutrients are more stringent.

Chapter 5 Conclusions and Recommendations

The team successfully created a greenhouse design to enable efficient year round operation. This design provides a solid starting point for prospective aquaponic greenhouse builders, even if their specific requirements are different from that of Worcester Roots. Although ultimately our design was not constructed due to a generous donation of an existing greenhouse, the design provides a solid foundation for future constructions, and informs any possible modifications Worcester Roots may want to make to the donated greenhouse.

The team also created a design for a modular, easily replicable aquaponic growing system. The design was successfully built as a prototype of the system which includes a growing bed, a stand for the growing bed and a fish tank. We also synthesized a month by month working schedule which highlighted key growing seasons for plants and suggested the optimal year round operation considering the climate.

Below there are a few recommendations the team made for future improvements and alterations in the greenhouse.

5.1 Recommendations for Further Investigation

5.1.1 Ventilation

The Aquaponic Greenhouse design does not feature an automated ventilation system. The level of humidity inside the greenhouse will affect the both the biological and non-biological entities in the greenhouse. Our research into ventilation systems and effects of temperature and humidity on greenhouse components showed that the high levels of relative humidity will damage the wooden structure as well as young seedlings. In addition to the two internal fans in the design we strongly advise anyone interested in using our design as a template for building his own greenhouse to conduct further investigation into the integration of an automated ventilation. The automated ventilation process will allow the greenhouse to maintain a constant internal humidity and temperature which will facilitate optimum yield of the plants and fish while preserving the existing structure.

5.1.2 Interior Layout

The interior layout features three tanks of similar dimensions. However the team learnt through research that there are some limitations to the size available for the building for the greenhouse. It was found that the greenhouse cannot be build more than 4 feet close to the property line, as a result, the size of the greenhouse should be decreased. We recommend that the design be changed from 33 ft. in length to 27ft so as to meet the building codes for the state of MA. The external size reduction would also affect the interior layout. Alternatively the design could also be altered by replacing the 8' by 4' beds with four beds with dimensions of 4' by 2'. The four beds could be vertically stacked, this would give the same amount of growing area while consuming less interior space. The results of out early prototypes cause to strongly recommend that the beds be reduced in size to reduce the amount of strain experienced by each bed as there will be less water and therefore the bed will have to support less weight. We advise future groups to reduce the dimensions of the growing beds so that they can fit into the new area available inside the greenhouse.

5.1.3 Structure

Because of regulations, the building will have to be reduced and the alternative for the internal size reduction is to design vertical beds. Instead of building an 8' by 4' you could design the four beds of 4' by

2', stacking the four beds vertically would give the same amount of growing area and the same tank can be used. Some minor alterations have to be made on the bed's reinforcements because they will have little support on the bottom.

5.1.4 Insulation

The greenhouse has not yet been built and therefore the insulation of the greenhouse has not yet been finalized. We recommend the use of fiberglass because of its high cost-effectiveness and its efficiency. Although fiberglass is not the most environmentally friendly possibility research into the heat retention properties show that fiberglass is the most viable and commercially used material for insulation. We also recommend further research on ground insulation. As poor ground insulation will result in the rapid loss of heat due to the frozen ground. The sponsors are strongly leaning to our recommendation Extruded Polystyrene Foam, also known as blue or pink board one of the best ground insulation materials available on the market.

5.1.5 Plants

At this point in time there is also no final decision as to what type of plants will be grown. As an IQP group we cannot ignore the social implications that arise as a result of the greenhouse. We are recommending that a food feasibility study be conducted in the community wherein the greenhouse will be built. The purpose of this will be to obtain an idea of the foods that are most consumed in the community. This information would then be used to make an informed decision of the plants to cultivate during each growing season thus increasing the profitability of the greenhouse as a co-op run business.

5.1.6 Business Development

The sponsor's long term goal for the greenhouse is to run it as a business. During the initial stages of the project some preliminary research was done into the development and operation of cooperatives. There is still much more research that can be done both in terms of marketing strategies and the development of a successful business model. We are hereby recommending further research in the business aspect of this aquaponic greenhouse.

5.1.7 Renewable Energy Sources

Sustainable and renewable energy sources are still of particular interest to the aquaponic greenhouse project. Solar energy was strongly considered as a power source for the greenhouse however this idea was quickly abandoned as the startup cost greatly exceeded the budget available. Our research indicates that in the long term solar energy will prove to be more cost effective than other commercially available forms of energy. We strongly recommend to further investigate the integration of a solar energy system with the aquaponic system as a viable renewable energy source that is in line with the sponsor's vision for a sustainable food production system.

5.1.8 Vertical Growing Bed

Vertical growing beds have been utilized to maximize the total growing area of a greenhouse. If the beds are stacked vertically, then you can greatly increase the capacity that the greenhouse can output. There are also some downsides to this type of configuration. If the growing beds are stacked on top of each other, there is an issue with sunlight being able to reach the lower level beds. To compensate for this, artificial lighting must be used. There are several different types of light sources that are used for hydroponics and aquaponics. LED lights are commonly used because of their efficiency and prolonged

use without maintenance. LEDs are also available in many different wavelengths. Different wavelengths are better and more effective for plant growth and development. The LEDs can also be chosen depending on what type of plant is being growing seeing that some LEDs are better suited for other plants. There is special equipment that is required to drive the LEDs in the most efficient way possible.

The main idea for the vertical growing bed was to have four growing beds stacked on top of each other. These growing beds would be four feet by four feet. These are the same dimensions as the width and length of the plastic fish tank. These beds would be stacked on top of the fish tank.

5.1.9 Artificial Lighting

Research into artificial lighting showed that a significant proportion of commercially available LED lights do not provide the necessary wavelengths of light necessary for the ideal absorption by the pigments in plants. The commercially LED lights are therefore wasting energy emitting wavelengths of light that the plant cannot absorb. We recommend that a study be conducted to deduce the accuracy of these findings. One such experiment would be to program LEDs to emit the specific wavelengths of light then compare the custom LEDs to commercially available ones. The comparison will be based on the plant growth over a specific time. The comparison will indicate if the custom programmed LEDs yield more optimum growth than the pre ordered LEDs.

5.2 Final Thoughts

As for the team's expectations, in the short term, we expect to get the community of Main South in Worcester more involved with the greenhouse. This pilot will have the opportunity to educate the youth as well as anyone that is interested on the pathway for urban food production.

By empowering local residents, the project aims to provide a healthy, local food source for Worcester residents, and educate members and local youth about greenhouse growing, aquaponics, and the cooperative businesses.

As for the long term goes we are being more ambitious, we expect to help creating the idea of urban farming, by demonstrating that small systems can provide an entire diet, with fish, fruits, and vegetables. We also hope that this project will have a positive impact on entrepreneurs, to scale up this system, as well as anyone who wants to scale down the project and have a self-sustaining aquaponic greenhouse on their backyard.

Works Cited

- 2012 Census Volume 1, Chapter 1: State Level Data. (n.d.). Retrieved November 15, 2014, from http://www.agcensus.usda.gov/Publications/2012/Full_Report/Volume_1,_Chapter_1_State_Level/Massachusetts
- Alamos. (2015, January 8). Professor. (G. Demeneghi, Interviewer)
- Alisha Coleman-Jensen, C. G. (2014, Sept). *Household Food Security in the United States in 2013*. Retrieved from United States Department of Agriculture: <http://www.ers.usda.gov/media/1565415/err173.pdf>
- Alisha Coleman-Jensen, C. G. (2014, Sept). *Household Food Security in the United States in 2013; Statistical Supplement*. Retrieved from United States Department of Agriculture: <http://www.ers.usda.gov/media/1565530/ap066.pdf>
- Aquaponic Designs*. (n.d.). Retrieved from Bioenergy Research Group: <http://www2.hawaii.edu/~khanal/aquaponics/design.html>
- Bernstein, S. (2013). *The Aquaponic Gardening Blog*. Retrieved February 17, 2015, from The Aquaponic Source: <http://theaquaponicsource.com/category/blog/growing-aquaponically/>
- Blazich, F. (1999). *Starting Plants From Seeds*. Department of Horticulture, North Carolina State University.
- Bob, F. (2013). *Seed Giants V.S US*. Farmers Center for Food Safety.
- Braen, D. (2013 , May 10). *Crushed Stone vs. Pea Gravel: Prices, Sizes & Uses*. Retrieved from Braenstone: <http://www.braenstone.com/2013/05/crushed-stone-vs-pea-gravel/>
- Bronstein, J. L. (1995). An Overview of Symbiosis. *Journal of Ecology*, 76, 1019–1020.
- Buczacki, S. a. (1998). *Pests, Diseases & Disorders of Garden Plants*. HarperCollins.
- C, D. (2008). Local Marketing of Organic Food by Certified Organic Processors, Manufacturers and Distributors. *Journal of AgriBusiness*, 26(2), 157-174.
- Carpenter, M. G.-K. (2005). Eutrophication Due To Phosphorus Recycling In Relation To Lake Morphometry, Temperature, And Macrophytes. *Journal of Ecology*, 86, 210–219.
- Carpentry*. (n.d.). Retrieved from Building Construction and Finishing: <http://www.free-ed.net/free-ed/resources/trades/carpentry/building01/default.asp?iNum=0903>
- Castro, S. (n.d.). *Worcester Food Advisory Policy Council Hunger-free and healthy*. Retrieved from http://www.worcesterfoodpolicy.org/index.php?option=com_content&task=view&id=43&Itemid=
- Center, N. C. (n.d.). *National Climatic Data Center* . Retrieved February 26, 2015, from National Climatic Data Center National Oceanic and Atmospheric Administration: <http://www.ncdc.noaa.gov/>

- Covington, A. K., Bates, R. G., & Durst, R. A. (1985). Definitions of pH scales, standard reference values, measurement of pH, and related terminology. *Pure Appl. Chem.*, 531–542.
- Critchley W, W. C.-B. (2007). Promoting local innovation in rural agriculture. *Urban Agriculture Magazine*(19).
- DataHaven. (2010). *www.ctdatahaven.org*. Retrieved 2010, from http://www.ctdatahaven.org/know/index.php/Research_Availability_Healthy_Food_FoodDeserts
- Davis, L. M. (2014, Jun 12). *CEO Pay Continues to Rise as Typical Workers Are Paid Less*. Retrieved from Economic Policy Institute: <http://www.epi.org/publication/ceo-pay-continues-to-rise/>
- Dennis E . Buffington, R. A. (n.d.). *This document is AE-10, one of a series of the Agricultural and Biological Engineering Department, Florida Cooperative Extension Service, Institute of Food and Agricultural*. Retrieved from <http://edis.ifas.ufl.edu/ae030>
- Depot, M. (n.d.). *Metals Depot*. Retrieved from http://www.metalsdepot.com/index.php?gclid=CjwKEAiAgfymBRCEhpTR8NXpx1USJAAV0dQy4FOb9DYHPEkxCpQW4pNVGc6Vgbg6Il79YT702DahPRoC0B7w_wcB
- Desjarlais, A. O. (2008, January 15). *Insulation - Fact Sheet*. Retrieved from Department of Energy Assistant Secretary Energy Efficiency and Renewable Energy: http://web.ornl.gov/sci/roofs+walls/insulation/ins_01.html
- Employee Cooperative Corporations*. (n.d.). Retrieved from <https://malegislature.gov/Laws/GeneralLaws/PartI/TitleXXII/Chapter157A>
- Engineering*. (n.d.). Retrieved from Info for Building: http://www.infoforbuilding.com/engineering_N.html
- EPA. (n.d.). *Health Effects of PCBs*. Retrieved October 31, 2014, from www.epa.gov/epawaste/hazard/tsd/pCBS/pbs/peffects.htm
- FarmTek. (n.d.). Retrieved from <https://www.farmtek.com/>
- fiberglass insulation*. (n.d.). Retrieved from house green wood: <https://houseongreenwood.wordpress.com/tag/fiberglass-insulation/>
- Ford, P. B., & Dzewaltowski, D. A. (2008). Disparities in Obesity Prevalence Due to Variation in the Retail Food Environment: Three Testable Hypotheses". *Nutrition Reviews*.
- Fratzel, T. (n.d.). *Foam Board Insulation R Values*. Retrieved from Home Construction & Improvement : <http://www.homeconstructionimprovement.com/foam-board-insulation-values/>
- Fratzel, T. (n.d.). *Foam Board Insulation Types*. Retrieved from Home Construction & Improvement : <http://www.homeconstructionimprovement.com/foam-board-insulation-values/>

- Gibson, S. (2010, November 15). *How to finish exterior foundation insulation*. Retrieved from Green building advisor: <http://www.greenbuildingadvisor.com/blogs/dept/qa-spotlight/how-finish-exterior-foundation-insulation>
- GrayStone. (n.d.). Retrieved from http://www.graystonecreations.com/Fish-Tanks_ep_134.html
- Greenhouse Coverings. (n.d.). Retrieved from CAES. UGA: <http://www.caes.uga.edu/departments/bae/extension/handbook/documents/coverings.pdf>
- Greenhouses, A. (n.d.). *Greenhouse buying guide*. Retrieved from little greenhouse: <http://www.littlegreenhouse.com/guide.shtml>
- Greenline, D. P. (2010, May). *Porchside Gardening* . Retrieved February 26, 2015 , from porchsidegardening.wordpress.com: <https://porchsidegardening.wordpress.com/2010/06/04/cool-season-vs-warm-season-crops/>
- H., S.-A. A., & Hendawy, H. S. (2009). EFFECT OF POTASSIUM HUMATE AND NITROGEN FERTILIZER ON HERB AND ESSENTIAL OIL OF OREGANO UNDER DIFFERENT IRRIGATION INTERVALS. *Journal of Applied Sciences*, 2(3), 319-323. Retrieved from http://ozelacademy.com/OJAS_v2n3_7.pdf
- Harris, L. K. (n.d.). *Aquaponics being taught in Vietnamese community*. Retrieved October 31, 2014, from Louisiana Weekly.
- Hatfield, J. (2012). *Agriculture in the Midwest*. Retrieved from http://glisa.umich.edu/media/files/NCA/MTIT_Agriculture.pdf
- Hopper, E. (n.d.). Retrieved from <http://www.gardenandgreenhouse.net/index.php/past-issues-mainmenu-18/121-2012-garden-greenhouse/july-august-2012/1398-the-basics-of-greenhouse-ventilation>
- Hopper, E. (2012). Retrieved from <http://www.gardenandgreenhouse.net/index.php/past-issues-mainmenu-18/121-2012-garden-greenhouse/july-august-2012/1398-the-basics-of-greenhouse-ventilation>
- How To Construct Stud Walls & Partitions*. (n.d.). Retrieved from renovation headquarters: <http://www.renovation-headquarters.com/walls-partitions.htm>
- IBISWorld. (n.d.). Retrieved from <http://clients1.ibisworld.com/reports/us/industry/ataglance.aspx?entid=4012>
- IBISWorld. (n.d.). *Aquaculture*. Retrieved from <http://clients1.ibisworld.com/reports/us/industry/productsandmarkets.aspx?entid=63>
- J.D., S. (2006). *Aquaponics: Growing Fish and Plants Together*. University of Colorado.
- Jason, Y. (2012). *A comparison of the Effectiveness of Aquaponic Gardening to Traditional Gardening Growth Method*. University Of South California.

- Jim, H. (2009). *On Farm Food Safety: Aquaponics*. College of Tropical Agriculture and Human Resources. University of Hawaii at Mānoa.
- John W. Bartok, J. (2007). *Greenhouse management*. Retrieved from Umass Extension Greenhouse Crops and Floriculture Program: <https://extension.umass.edu/floriculture/fact-sheets/insulation-know-how>
- John W. Bartok, J. (2007). *UMass Extension Greenhouse Crops and Floriculture Program*. Retrieved from Insulation - Know How: <http://extension.umass.edu/floriculture/fact-sheets/insulation-know-how>
- K., F. B. (2012). *A Preliminary Study of Microbial Water Quality relating to Food Safety in Recirculating Aquaponic Fish and Vegetable Production Systems*. College of Tropical Agriculture and Human Resources. University of Hawaii at Mānoa.
- Koc, M. (1999). *Introduction : Food Security is a Global Concern*. International Research Center .
- Larsen, R. (2011). *Journalist's Resource.org*. Retrieved August 4, 2011, from <http://journalistsresource.org/studies/society/health/fast-food-restaurants-stores/>
- Lena, G. (2001). *Comamonas denitrificans* sp. nov., an efficient denitrifying bacterium isolated from activated sludge. *International Journal of Systematic and Evolutionary Microbiology*, 51, 999-1006.
- Lennard, D. W. (2008). <http://www.aquaponic.com.au/>. Retrieved 2014
- Little Greenhouse*. (n.d.). Retrieved from ACF Greenhouse: <http://www.littlegreenhouse.com/base/base.shtml>
- Mack, C. M. (2014, March 18). *What's the best Insulation* . Retrieved from ecoliving: http://ecoliving.scotiabank.com/articles/whats-the-best-insulation#.VSbE_yvF9qU
- Marklin, R. W. (2013). *Aquaponics :A Sustainable Food Production System That Provides Research Projects for Undergraduate and Engineering Students*. Marquette University e-Publications.
- Martin, C. T., Kayser-Jones, J., Stotts, N., Porter, C., & Froelicher, E. S. (2006). Nutritional Risk and Low Weight in Community-Living Older Adults: A Review of the Literature. *The Journals of Gerontology: Series A*(61), 927-34.
- Mary S. Booth, J. M. (2005). *Controls On Nitrogen Cycling In Terrestrial Ecosystems: A Synthetic Analysis Of Literature Data*. Ecological Monographs.
- Massachusetts Seasonal Fruits & Vegetables*. (n.d.). Retrieved from <http://localfoods.about.com/od/searchbyregion/a/massseasons.htm>
- Megastore, G. (n.d.). *Covering Material*. Retrieved from <http://www.greenhousemegastore.com/category/covering>

- Metabolization rates of Biological Filters.* (n.d.). Retrieved November 10, 2014, from <http://www.russellwatergardens.com/Styles/metabolization.php>
- Michele Ver Ploeg, V. B.-H. (2009, Jun). *Access to Affordable and Nutritious Food: Measuring and Understanding Food Deserts and Their Consequences; Report to Congress.* Retrieved from United States Department of Agriculture - Economic Research Service: http://www.ers.usda.gov/media/242675/ap036_1_.pdf
- Mjoun, K. (2010). *Tilapia: Environmental Biology and Nutritional Requirements.* Pierre : South Dakota State University.
- Mugundhan, M. (2011). Hydroponics, A Novel Alternative for Geoponic Cultivation of Medicinal Plants and Food Crops . *International Journal of Pharmacology and Biological Sciences.*
- Nate Storey, P. (2014). *Bright Agrotech.* Retrieved 2014, from <http://brightagrotech.com/biological-surface-area-in-aquaponics/>
- (2009). *Nutrient Recommendation For Commercial Cut Flower Production.* University of Maryland.
- P.H., R. (2005). *Biology of Plants* (7 ed.). New York: W.H. Freeman and Company Publishers.
- Patricia A. Rorabaugh, P., Merle H. Jensen, P., & Gene Giacomelli, P. (2002). *Controlled Environment Agriculture Center.* Retrieved from Campus Agriculture Center, University of Arizona: https://hrt.msu.edu/Energy/Notebook/pdf/Sec3/Greenhouse_Energy_Conservation_and_Alternatives_by_Rorabaugh_et_al.pdf
- POLLAN, M. (2008, Oct 9). *Farmer in Chief.* Retrieved from <http://www.nytimes.com/2008/10/12/magazine/12policy-t.html?pagewanted=all&r=0>
- Price, C. (2009). *Aquaponics and renewable Energy.* Aquaponics UK, University of Stirling.
- Regional Environmental Council. (n.d.). *Regional Environmental Council | UGROW.* Retrieved November 15, 2014, from Regional Environmental Council: <http://www.recworchester.org/what-we-do/food-justice-2/ugrow-2/>
- Research, F. o. (2010). Causes of Copper corrosion in plumbing systems. UK.
- Richard. (2011, 9 10). *Grow Beds in Home Aquaponics.* Retrieved from Farming With Fish: http://farmingwithfish.com?page_id=13322
- Roberts, J. (2012, July 15). *Building a Backyard Observatory for a C14 Telescope.* Retrieved from Amateur Astronomer's Notebook: <http://www.rocketroberts.com/astro/observatory.htm>
- Roberts, W., Mears, D., Simpkins, J., & Cipolletti, J. (1981). *MOVABLE THERMAL INSULATION FOR GREENHOUSES.* Retrieved from Biological and Agricultural Engineering Department: https://drive.google.com/?utm_source=en&utm_medium=button&utm_campaign=web&utm_content=gotodrive&usp=gt<mpl=drive&pli=1#folders/0B3dAxBoy5FAldEICRzM3bINoX1E

- Roll, F. (n.d.). *Greenhouse covering*. Retrieved from Gothic arch:
https://www.gothicarchgreenhouses.com/fiberglass_panels.htm
- Ross, D. S. (n.d.). *Planning and Building a Greenhouse*. Retrieved from West Virginia University Extension Service: <http://www.wvu.edu/~agexten/hortcult/greenhou/building.htm#Structural Materials>
- Smith, C., & Morton, L. W. (2009). Rural Food Deserts: Low-income Perspectives on Food Access in Minnesota and Iowa. *Journal of Nutrition Education and Behavior*, 41(3), 176-187.
- Stanczak, M. (2012, March). Biofouling: It's Not Just Barnacles Anymore. *ProQuest*,.
- structures, G. (n.d.). *Replacement glass*. Retrieved from <http://www.glassstructures.com/glass/>
- The Different Types of Aquaponics System*. (n.d.). Retrieved from Aquaponics Plans:
<http://aquaponicsplan.com/the-different-types-of-aquaponics-system/>
- the Greenhouse catalog*. (n.d.). Retrieved from greenhousecatalog flooring:
<http://cdn.greenhousecatalog.com/images/popup/greenhouse-floor-500.jpg>
- Timothy, H. K. (2009). *Nitrogen Requirements of Drip-irrigated Processing Tomatoes*. Department of Plant Sciences, University of California.
- US Department of Labor. (2012). *About Minimum Wage*. Retrieved from
<http://www.dol.gov/minwage/minwage-gdp-history.htm>
- US Federation of Worker Cooperatives. (n.d.). *What is a Worker Cooperative?* Retrieved from
<http://www.usworker.coop/about/what-is-a-worker-coop>
- USDA - Agricultural Marketing Service. (n.d.). *Farmers Markets and Local Food Marketing; Food Hubs: Building Stronger Infrastructure for Small and Mid-Size Producers*. Retrieved from United States Department of Agriculture; Agricultural Marketing Service:
<http://www.ams.usda.gov/AMSV1.0/foodhubs>
- USDA - Agricultural Marketing Service. (n.d.). *Success Stories*. Retrieved from United States Department of Agriculture; Agricultural Marketing Service:
http://apps.ams.usda.gov/fooddeserts/Food_Deserts_AMS_Success_Stories.pdf
- USDA AMS. (n.d.). *Food Deserts*. Retrieved from
<http://apps.ams.usda.gov/fooddeserts/fooddeserts.aspx>
- USDA. (n.d.). *Designated Food Desert Census Tracts*. Retrieved from
<http://apps.ams.usda.gov/fooddeserts/TractBreakdown.pdf>
- USDA. (n.d.). *Food Deserts*. Retrieved from <http://apps.ams.usda.gov/fooddeserts/fooddeserts.aspx>
- Vendômois JS, R. F. (2009). A Comparison of the Effects of Three GM Corn Varieties on Mammalian Health. *International Journal of Bioigical Science*, 5(7), 706-726.

Wahl, S. (2010). Discovering Aquaponics. *Aquaponics Journal* .

White House Task Force on Childhood Obesity. (2010, May). *Solving The Problem of Childhood Obesity Within a Generation*. Retrieved from http://www.letsmove.gov/sites/letsmove.gov/files/TaskForce_on_Childhood_Obesity_May2010_FullReport.pdf

WILTON, S. (2001, September). Selecting material.

Wiser, W. H. (1999). *Energy Resources* . New York: Springer.

Worcester Roots. (n.d.). *Co-op Development*. Retrieved from <http://www.worcesterroots.org/projects-and-programs/co-op-incubation/>

Worcester Roots. (n.d.). *Greenhouse*. Retrieved from <http://www.worcesterroots.org/projects-and-programs/youth-in-charge/>

Worcester Roots. (n.d.). *Mission and Values*. Retrieved from <http://www.worcesterroots.org/about-2/about/>

worker, s. (n.d.). *Construction*. Retrieved from Integrated publishing: <http://www.tpub.com/steelworker2/31.htm>

Appendix A: Growing Seasons of Different Vegetables

	Jan	Feb	Mar	April	May	June	July	Aug	Sep	Oct	Nov	Dec
Basil							■	■	■			
Cabbage						■	■	■	■			
Cauliflower								■	■	■	■	
Celery								■	■	■		
Cucumbers							■	■	■	■		
Garlic							■	■	■	■		
Kale						■	■	■	■	■	■	
Mint			■	■	■	■	■	■				
Parsley					■	■	■	■	■	■	■	
Peas and pea pods							■	■	■	■		
Peppers (sweet)							■	■	■	■		
Shelling beans									■	■	■	
Spinach					■	■	■	■	■			
Squash							■	■	■	■	■	■
Thyme					■	■	■	■	■			
Tomatoes							■	■	■			

(Massachusetts Seasonal Fruits & Vegetables, n.d.)

Appendix B: Budget

Income		
	UMass Memorial Community Benefits (received)	\$5,000
	Greater Worcester Cmty Fndtn Food Bank (received)	\$10,000
	Ramlose Foundation (projected)	\$1,000
	Crowd Funding (projected)	\$1,000
Roots	Roots subtotal	\$17,000
	Stone Soup (received)	\$2,000
	Fletcher Foundation (projected)	\$3,000
	The Stoddard Charitable Trust (projected)	\$2,500
	Fuller Foundation (projected)	\$3,000
	Greater Worcester Cmty Fndtn Mini Grant (projected)	\$1,500
	Other local and regional grants	\$8,000
Stone Soup	Stone Soup subtotal	\$20,000
	Total	\$37,000
Expenses		
	Training, youth dev't, stipends, admin (Roots)	\$10,000
	Business planning, operations coord. (Howard)	\$1,000
	Aquaponics Equipment	\$5,500
Roots	Roots subtotal	\$16,500
	Greenhouse Structure	\$9,000
	Site prep (level ground, move bricks, clear fence, etc.) - need quote from Diggers	\$600
	Site and Utilities	\$9,800
	Misc. pilot expenses	\$1,000
Stone Soup	Stone Soup subtotal	\$20,400
	Total	\$36,900
	<i>Excess/Deficit</i>	\$100

Dimensions of the Greenhouse

Volume:

$$\text{Volume of prism } V = \frac{hbL}{2} \Rightarrow \frac{(4ft)(22ft)(33ft)}{2} \Rightarrow 1452ft^3$$

$$\text{Volume of a rectangle } V = hbL \Rightarrow (8ft)(22ft)(33ft) \Rightarrow 5808ft^3$$

$$\text{Total volume } V = V_{prism} + V_{rectangle} \Rightarrow 1452ft^3 + 5808ft^3 \Rightarrow 7260ft^3$$

Area:

$$\text{Area of side wall } A = bh \Rightarrow (33ft)(8ft) \Rightarrow 264ft^2$$

$$\text{Area of front wall } A = bh \Rightarrow (22ft)(8ft) \Rightarrow 176ft^2$$

$$\text{Area of roof } A = bh \Rightarrow (33ft)(12ft) \Rightarrow 396ft^2$$

$$\text{Area of triangle (front/back of the roof)} A = \frac{bh}{2} \Rightarrow \frac{(22ft)(4ft)}{2} \Rightarrow 44ft^2$$

$$\text{Total Surface Area } A = 2A_{triangle} + 2A_{sidewall} + 2A_{frontwall} + 2A_{roof} \Rightarrow 1760ft^2$$

Appendix C: Alternative Greenhouse Structure Design

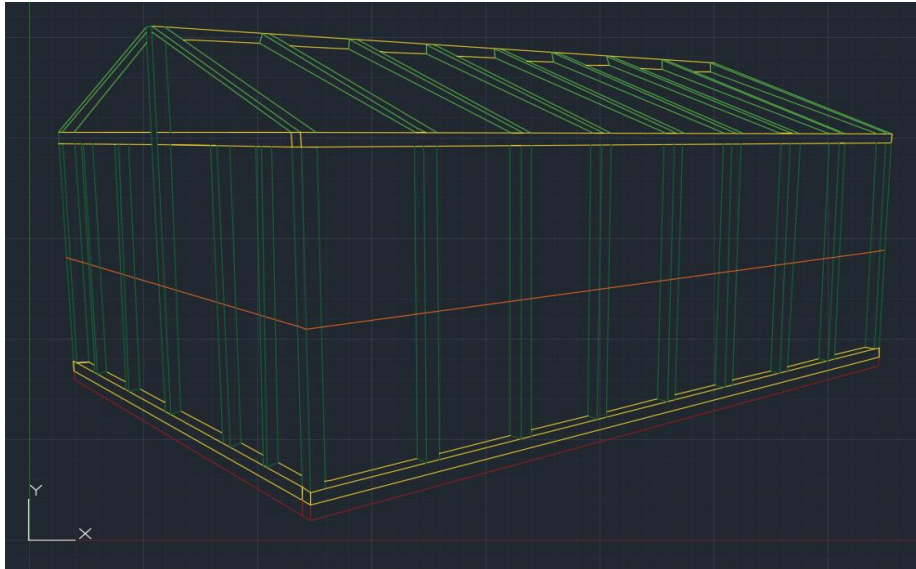

RED 6 12' long Pressure treated wood

RED 4 10' long Pressure treated wood

YELLOW 7 10' long Base/top lumbers

YELLOW 16 12' long Base/top lumbers

DARK GREEN 26-30 8' long studs lumber

DARK GREEN 2 12' long studs lumber

LIGHT GREEN 18 12' long Shaft lumber

The pressure treated wood base of this option is flat on top of the foundation and the structure is built on top of the base. Since the footed base is only attached to the structure through screws, the upper body of the greenhouse is vulnerable to lateral forces, like wind and storms.

Appendix D: Greenhouse Structure Costs for Alternative Materials

Material	Dimensions	Location	Price	Price/square feet
Plywood	¾"x4'x8'	Home Depot	\$34.98	\$1.09
R13	1.25'x32'	Home Depot	\$12.80	\$0.30
R13	1.25'x39.2'	Home Depot	\$19.58	\$0.39

Part	Size	Dimension	Quantity	Cost
Aluminum				
Base/top	12'	4"x3"x1/8"	33 pieces	\$6383.52
Studs	8'	2"x1-1/2"x1/8"	28 pieces	\$1523.20
Rafters	12'	2"x1-1/2"x1/8"	18 pieces	\$1496.88
Shipping				\$250.00
Total				\$9643.60

Steel				
Part	Size	Dimension	Quantity	Cost
Base/top	12'	4"x3"	33 pieces	\$3496.68
Studs	8'	2"x1-1/2"	28 pieces	\$110.32
Rafters	12'	2"x1-1/2"	18 pieces	\$760.32
Shipping				\$250
Total				\$5611.32

(Depot)

Materials	Amount	Dimensions	Sources	Total Cost
Wood		Various	Plywood plus (local)	~\$2000.00
Steel		Various	Metalsdepot.com	~\$5612.00
Aluminum		Various	Metalsdepot.com	~\$9643.60
Paneling				
Solexx XP pre-cut 3.5mm	1188 ft. ²	4.13' x 8.25'	Greenhousemegastore.com	\$1627.56
Solexx Pro pre-cut 5mm	1188 ft. ²	4.13' x 8.25'	Greenhousemegastore.com	\$2328.48
Twin wall polycarbonate 8mm	1188 ft. ²	2.00' x 6.00'	Greenhousemegastore.com	\$2174.64
Multiwall polycarbonate 8mm	1188 ft. ²	6.00' x 12.00'	Greenhousemegastore.com	\$2269.08
Nontransparent Walls				
Plywood	572.0 ft. ²	¾" x 4' x 8'	Home depot	\$1246.96
R13 Roll	572.0 ft. ²	1.24' x 32.00'	Home depot	\$171.60
		1.24' x 39.20'	Home depot	\$230.41
Foundation				
Sonotube	~14 pieces	1.00' x 4.00'	Home depot	\$106.96
		0.80' x 4.00'	Home depot	\$97.86
		0.60' x 4.00'	Home depot	\$76.30
Redi base	~14 pieces	0.60' x 2.00'	Home depot	\$279.86
Totals				
Total Wood (approximate)				\$5423.84
Total Steel (approximate)				\$8797.31
Total Aluminum				\$12844.31

Appendix E: Alternative Roof Designs

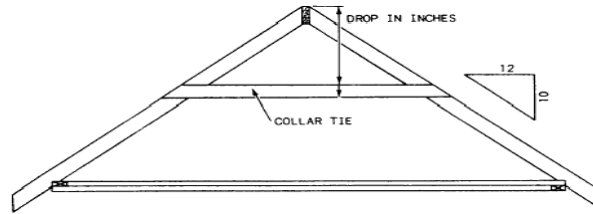

(Carpentry)

The collar tie roof was originally designed to amplify the space in attics, to use as storage space or an extra room. The collar tie, bar in the middle, would be placed between every other shaft to distribute the weight of the roof. The drawbacks on this design is that, with stress and time, the collar tie will suffer deformation and have to be replaced.

The diagonal bracings are typically metal bars that are connected to the bottom chords to give an extra reinforcement to the roof, especially in resisting vertical forces, the picture below shows how the bracings are connected to the bottom chords.

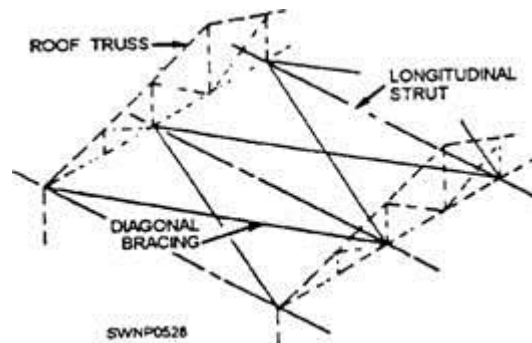

(worker)??

The diagonal bracing design is mostly used to reinforce the roof instead of substituting other designs.

Appendix F: Prices of Paneling Calculations

Whole greenhouse made of transparent material

Material	Width x Length	Price/ft ²	Price/area (Price/ft ² *Area)
Solexx			
Solexx XP, Pre-cut 3.5mm	42"x99"	\$1.50	\$2640.00
	49.5"x99"	\$1.37	\$2411.20
	49.5"x146"	\$1.46	\$2569.60
Solexx Pro, pre-cut	42"x99"	\$1.93	\$3396.80
	49.5"x99"	\$1.96	\$3449.60
	49.5"x146"	\$1.96	\$3449.60
Solexx XP roll 3.5mm	(Sold per linear foot) 48" x 12"	\$1.57	\$2763.20
Solexx Pro roll 5mm	(Sold per linear foot) 48" x 12"	\$2.01	\$3537.6
Plastic			
Twin wall polycarbonate	2'x6' 8mm	\$1.83	\$3220.80
	2'x4' 8mm	\$2.00	\$3520.20
	2'x6' 6mm	\$1.83	\$3220.80
	2'x4' 6mm	\$2.00	\$3520.00
Multiwall polycarbonate 8mm	6'x6'	\$1.91	\$3361.60
	6'x12'	\$1.91	\$3361.60
	6'x18'	\$1.89	\$3326.40
	6'x24'	\$1.90	\$3344.00
Film(thermal Anti-Condensate)	24'x35'	\$0.15	\$264.00
Fiberglass			
fiberglass	2'x50'	\$2.26	\$3977.60
	4'x50'	\$2.26	\$3977.60
Glass			

Glass Single 3.8mm	24"x24" + crates	\$17.19	\$13365.00
Acrylic			
Deglas acrylic 16mm	3.94'x6'	\$4.79	\$8430.40
	3.94'x12'	\$3.61	\$6353.60
	3.94'x18'	\$3.61	\$6353.60
Different prices in between	3.94'x24'	\$4.94	\$6353.60
			\$8694.40

(Megastore, n.d.), (structures, n.d.), (Roll, n.d.)

One wall made out of plywood

$$A = A_{total} - A_{wall} \Rightarrow 1760\text{ft}^2 - 264\text{ft}^2 \Rightarrow 1496\text{ft}^2$$

Material	Width x Length	Price/ft ²	Price/area (Price/ft ² *Area)
Solexx			
Solexx XP, Pre-cut 3.5mm	42"x99"	\$1.50	\$2244.00
	49.5"x99"	\$1.37	\$2049.52
	49.5"x146"	\$1.46	\$2184.16
Solexx Pro, pre-cut	42"x99"	\$1.93	\$2887.28
	49.5"x99"	\$1.96	\$2932.16
	49.5"x146"	\$1.96	\$2932.16
Solexx XP roll 3.5mm	(Sold per linear foot) 48" x 12"	\$1.57	\$2348.72
Solexx Pro roll 5mm	(Sold per linear foot) 48" x 12"	\$2.01	\$3006.96
Plastic			
Twin wall polycarbonate	2'x6' 8mm	\$1.83	\$2737.68
	2'x4' 8mm	\$2.00	\$2992.00
	2'x6' 6mm	\$1.83	\$2737.68
	2'x4' 6mm	\$2.00	\$2992.00
Multiwall polycarbonate 8mm	6'x6'	\$1.91	\$2857.36
	6'x12'	\$1.91	\$2857.36
	6'x18'	\$1.89	\$2827.44
	6'x24'	\$1.90	\$2842.40
Film(thermal Anti-Condensate)	24'x35'	\$0.15	\$224.40
Fiberglass			
fiberglass	2'x50'	\$2.26	\$3380.96
	4'x50'	\$2.26	\$3380.96

Glass			
Glass Single 3.8mm	24"x24" + crates	\$17.19	
Acrylic			
Deglas acrylic 16mm	3.94'x6'	\$4.79	\$7165.84
	3.94'x12'	\$3.61	\$5400.56
	3.94'x18'	\$3.61	
Different prices in between	3.94'x24'	\$4.94	\$5400.56
			\$7390.24

(Megastore, n.d.), (structures, n.d.), (Roll, n.d.)

The remaining are is used to calculate the non-transparent walls. Plywood is double skin.

Material	Dimensions	Location	Price/square feet	Cost
Plywood	¾"x4'x8'	Home Depot	\$1.09	\$575.76
R13	1.25'x32'	Home Depot	\$0.32	\$79.20

Half of all walls made out of plywood.

$$A = A_{total} - A_{sidewall} - A_{frontwall} \Rightarrow 1760ft^2 - 264ft^2 - 176ft^2 \Rightarrow 1320ft^2$$

Material	Width x Length	Price/ft ²	Price/area (Price/ft ² *Area)
Solexx			
Solexx XP, Pre-cut 3.5mm	42"x99"	\$1.50	\$1980.00
	49.5"x99"	\$1.37	\$1808.40
	49.5"x146"	\$1.46	\$1927.20
Solexx Pro, pre-cut	42"x99"	\$1.93	\$2547.60
	49.5"x99"	\$1.96	\$2587.20
	49.5"x146"	\$1.96	\$2587.20
Solexx XP roll 3.5mm	(Sold per linear foot) 48" x 12"	\$1.57	\$2072.40
Solexx Pro roll 5mm	(Sold per linear foot) 48" x 12"	\$2.01	\$2653.20
Plastic			

Twin wall polycarbonate	2'x6' 8mm	\$1.83	\$2415.60
	2'x4' 8mm	\$2.00	
	2'x6' 6mm	\$1.83	\$2640.00
	2'x4' 6mm	\$2.00	\$2415.60
			\$2640.00
Multiwall polycarbonate 8mm	6'x6'	\$1.91	\$2521.20
	6'x12'	\$1.91	\$2521.20
	6'x18'	\$1.89	\$2494.80
	6'x24'	\$1.90	\$2508.00
			\$2508.00
Film(thermal Anti-Condensate)	24'x35'	\$0.15	\$198.00
Fiberglass			
fiberglass	2'x50'	\$2.26	\$2983.20
	4'x50'	\$2.26	\$2983.20
Glass			
Glass Single 3.8mm	24"x24" + crates	\$17.19	
Acrylic			
Deglas acrylic 16mm	3.94'x6'	\$4.79	\$6322.80
	3.94'x12'	\$3.61	\$4765.20
Different prices in between	3.94'x18'	\$3.61	\$4765.20
	3.94'x24'	\$4.94	\$4765.20
			\$6520.80

(Megastore, n.d.), (structures, n.d.), (Roll, n.d.)

The remaining are is used to calculate the non-transparent walls. Plywood is double skin.

Material	Dimensions	Location	Price/square feet	Cost
Plywood	¾"x4'x8'	Home Depot	\$1.09	\$959.20
R13	1.25'x32'	Home Depot	\$0.32	\$140.80

One entire wall and half of the other walls made out of plywood.

$$A = A_{total} - A_{sidewall} - A_{frontwall} - \frac{A_{sidewall}}{2} \Rightarrow 1760\text{ft}^2 - 264\text{ft}^2 - 176\text{ft}^2 - \frac{264\text{ft}^2}{2} \Rightarrow 1188\text{ft}^2$$

Material	Width x Length	Price/ft ²	Price/area (Price/ft ² *Area)
Solexx			
Solexx XP, Pre-cut 3.5mm	42"x99"	\$1.50	\$1782.00
	49.5"x99"	\$1.37	\$1627.56
	49.5"x146"	\$1.46	\$1734.48
Solexx Pro, pre-cut	42"x99"	\$1.93	\$2292.84
	49.5"x99"	\$1.96	\$2328.48
	49.5"x146"	\$1.96	\$2328.48
Solexx XP roll 3.5mm	(Sold per linear foot) 48" x 12"	\$1.57	\$1865.16
Solexx Pro roll 5mm	(Sold per linear foot) 48" x 12"	\$2.01	\$2387.88
Plastic			
Twin wall polycarbonate	2'x6' 8mm	\$1.83	\$2174.04
	2'x4' 8mm	\$2.00	\$2376.00
	2'x6' 6mm	\$1.83	\$2174.04
	2'x4' 6mm	\$2.00	\$2370.00
Multiwall polycarbonate 8mm	6'x6'	\$1.91	\$2269.08
	6'x12'	\$1.91	\$2269.08
	6'x18'	\$1.89	\$2245.32
	6'x24'	\$1.90	\$2257.20
Film(thermal Anti-Condensate)	24'x35'	\$0.15	\$178.20
Fiberglass			
fiberglass	2'x50'	\$2.26	\$2684.88
	4'x50'	\$2.26	\$2684.88
Glass			
Glass Single 3.8mm	24"x24" + crates	\$17.19	

Acrylic

Deglas acrylic	3.94'x6'	\$4.79	\$5690.52
16mm	3.94'x12'	\$3.61	\$4288.68
	3.94'x18'	\$3.61	\$4288.68
Different prices in between	3.94'x24'	\$4.94	\$4288.68
			\$5868.72

(Megastore, n.d.), (structures, n.d.), (Roll, n.d.)

The remaining are is used to calculate the non-transparent walls. Plywood is double skin.

Material	Dimensions	Location	Price/square feet	Cost
Plywood	¾"x4'x8'	Home Depot	\$1.09	\$1246.96
R13	1.25'x32'	Home Depot	\$0.32	\$171.6

Appendix G: Heat Loss Calculations

For the heat loss calculations, the formula $Q = UA\Delta T$ where,

Q is the heat transfer rate in Btu per hour.

U is the heat transfer coefficient U-value= 1/R-value, measured in Btu/h (F) (ft²).

A is the surface area in squared feet.

ΔT is the temperature inside minus the temperature outside.

If the greenhouse is entirely covered with transparent panels the heat loss will be the followings.

Assuming the greenhouse is fully insulated on the walls that are not transparent.

	Insulation (R-value)	Heat loss (U- value) Btu/(h*F*ft²)	Area (ft²)	ΔT (60F- 15F)	Q (Btu/h)
Solexx	2.10-2.30	0.45	1760	45	35640
Multi-wall polycarbonate	1.5-2.0	0.6	1760	45	47520
Single-wall polycarbonate	2.0	0.5	1760	45	39600

If the greenhouse has one wall made of plywood

	Insulation (R-value)	Heat loss (U- value) Btu/(h*F*ft²)	Area (ft²)	ΔT (60F- 15F)	Q (Btu/h)
Solexx	2.10-2.30	0.45	1496	45	30294
Multi-wall polycarbonate	1.5-2.0	0.6	1496	45	40392
Single-wall polycarbonate	2.0	0.5	1496	45	33660

If the greenhouse has half of every wall made of plywood

	Insulation (R-value)	Heat loss (U- value) Btu/(h*F*ft ²)	Area (ft ²)	ΔT (60F- 15F)	Q (Btu/h)
Solexx	2.10-2.30	0.45	1320	45	26730
Multi-wall polycarbonate	1.5-2.0	0.6	1320	45	35640
Single-wall polycarbonate	2.0	0.5	1320	45	29700

If the greenhouse has one wall and half of the other walls made out of plywood

	Insulation (R-value)	Heat loss (U- value) Btu/(h*F*ft ²)	Area (ft ²)	ΔT (60F- 15F)	Q (Btu/h)
Solexx	2.10-2.30	0.45	1188	45	24057
Multi-wall polycarbonate	1.5-2.0	0.6	1188	45	32076
Single-wall polycarbonate	2.0	0.5	1188	45	26730

Appendix H: Calculations for Heat Loss

Area x (In - Out) x Heat Loss=Total BTU required

1 BTU/hr. = 0.29307107 W

1000 w= 1kW

Monthly average is calculated based on 2 division since the chance for the temperature to be on its lowest average all month is very remote and also to get more realistic results.

Monthly Electricity Required= (24h * kWh *30)/2

Cost monthly =\$0.17* Total monthly electricity

Appendix I: Visualization of Heat Loss Curves

The graph below shows the heat loss for an air temperature of 60F. The heat loss according to the graph per sq. ft. from the tank surface will be around 500 BTU or 0.146 kWh. The blue line is the most appropriate to choose since inside the greenhouse air velocity is practically zero.

Heat loss graph

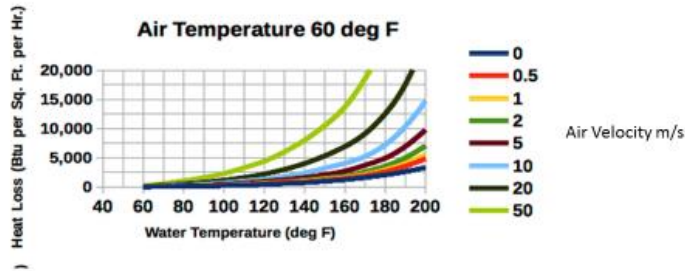

The green house temperature will remain constant at 60 F consequently the water in tanks too.
The ideal temp for tilapia will be 75 F.
Heat loss from graph will be ~500 BTU or 0.146 kWh per ft sq .

The graph clearly shows a requirement for a 1.8 kWh .We have to take in consideration that the water will lose heat due to the constant flow but since we just interpolated from the graph the heater rating we choose will give the desired results.

Appendix J: Visualization of Static Head for Pumps

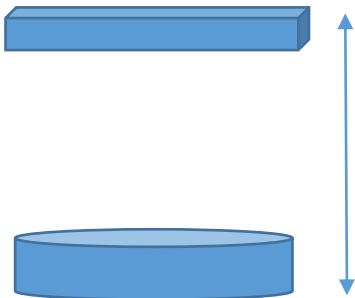

The relation of GPH and static head is shown in the graph below. This graph is specific for some aquaponic models. The same principle applies to most submersible pumps.

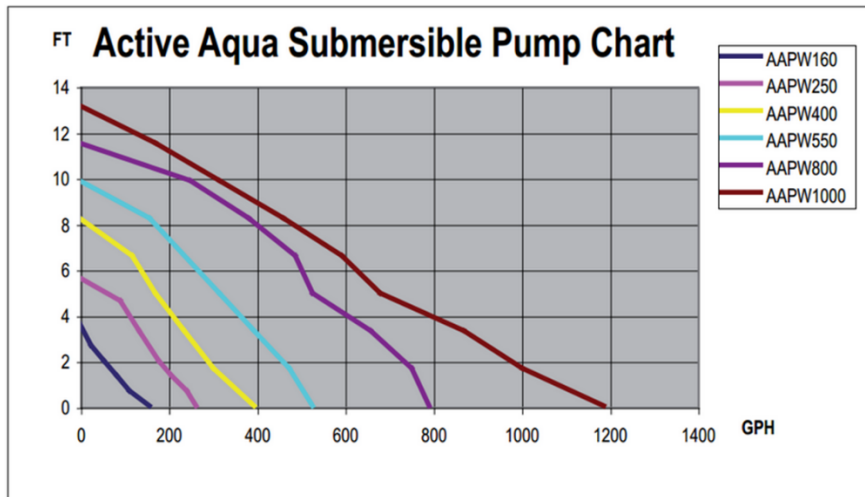

Appendix K: Table Different materials for paneling, how they are sold, and its price per square foot

Material	Width x Length	Price	Price/ft ²
Solexx			
Solexx XP, Pre-cut 3.5mm	42"x99"	\$43.30	\$1.50
	49.5"x99"	\$46.67	\$1.37
	49.5"x146"	\$73.26	\$1.46
Solexx Pro, pre-cut	42"x99"	\$55.81	\$1.93
	49.5"x99"	\$66.56	\$1.96
	49.5"x146"	\$98.15	\$1.96
Solexx XP roll 3.5mm	(Sold per linear foot) 48" x 12"	\$6.25	\$1.57
Solexx Pro roll 5mm	(Sold per linear foot) 48" x 12"	\$8.05	\$2.01
Plastic			
Twin wall polycarbonate	2'x6' 8mm	\$22.00	\$1.83
	2'x4' 8mm	\$16.00	\$2.00
	2'x6' 6mm	\$22.00	\$1.83
	2'x4' 6mm	\$16.00	\$2.00
Multiwall polycarbonate 8mm	6'x6'	\$68.68	\$1.91
	6'x12'	\$137.35	\$1.91
	6'x18'	\$204.40	\$1.89
	6'x24'	\$273.62	\$1.90
Film(thermal Anti-Condensate)	24'x35'	\$121.00	\$0.15
Fiberglass			
fiberglass	2'x50'	\$226	\$2.26
	4'x50'	\$452	\$2.26
Glass			
Glass Single 3.8mm	20'x20'	\$27.00 each	

	(4 pieces/crate)	\$95.00 crate	
Acrylic			
Deglas acrylic 16mm	3.94'x6'	\$113.31	\$4.79
Different prices in	3.94'x12'	\$170.84	\$3.61
between	3.94'x18'	\$256.26	\$3.61
	3.94'x24'	\$472.05	\$4.94

(Megastore, n.d.), (structures, n.d.), (Roll, n.d.)

Appendix L: Prototype Growing Bed Build Instructions

Specifications

1 foot deep

4' by 8'

Materials

Two 4' by 8' Sheets of Ply wood (3/4 inch thickness)

Wood Glue

Hammer, Saw, Hand Drill and Screw

Pond Liner

Instructions

1. Make the following Cuts from one sheet of the 4 by 8 plywood sheet :
 - A - Two 12 inch by 46.5 inch lengths
 - B - Two 1 foot by 8 foot lengths
2. Using the second sheet of plywood as the base, the assembly of the growing bed is as follows.
3. Place all four cuts on a leveled surface in the shape that they will be assembled. Note that piece A (12 inch by 46.5 inch lengths) will be **BETWEEN** piece B (1 by 8 foot length pieces.)



4. Mark three evenly spaced holes in the corners where piece A will be connected to piece B. And drill holes for screws.
5. Apply wood glue to the sides that will be in contact then fill in the screws around the corners.

6. Place the base (4 by 8 sheet) on top of the assembled piece completed in step 5, then mark off and 5 evenly spaced holes on the length and 3 evenly spaced holes along the width.



7. Apply wood glue to the surfaces that are in contact then drill in the screws **ONE SIDE AT A TIME**. Using a hammer while applying pressure to hit the plywood into place.

Additional Support for the Bed Structure

1. Make the following cuts using the 2 by 4 sheets
 - 8
 - 2
 - 2

Applying the Pond Lining

1. Spread the pond lining around the bed. Make sure that there are no significant air gaps between the lining and the bed.



2. Use a tape to mark out the position of the corners that the pond liner will be placed along.
3. Remove the pond liner and apply wood glue to all the interior surfaces of the growing bed
4. Place the pond liner inside using the tape marks as a guide.
5. Apply even pressure to all surfaces in contact with the glue. This is done easiest by filling the bed to 90% capacity with water.

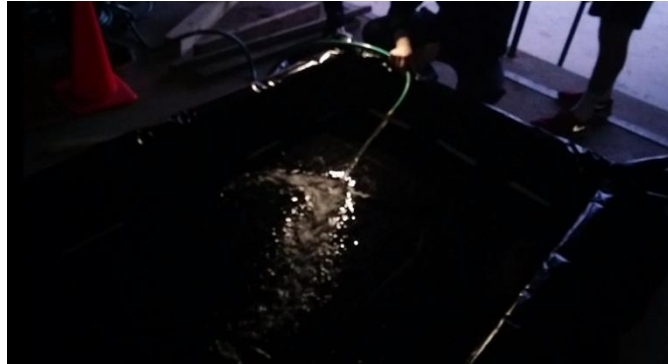

6. Leave the bed filled with water until the glue dries (24 hours recommended) then drain the water.
7. Trim the excess lining and use fasteners to securely attach the top of the lining to the bed.

Appendix M: Startup Cost Calculations for Various Heating Systems

Electrical Heater(17c/kwh)	Low	High
Electric Water Heater Cost Non-discounted retail cost for common, mid-grade electric water heater.	\$328.86	\$447.97
Labor Direct labor expenses to install electric water heater.	\$270.00	\$282.91
Electric Water Heater Job Materials and Supplies Cost of supplies that may be required to install electric water heater including: connectors, fittings and mounting hardware.	\$25.00	\$25.00
Electric Water Heater Equipment Allowance Job related costs of specialty equipment used for job quality and efficiency, including: pipe cutting and threading, tubing cutter, brazing kit and pipe wrenches.	\$24.00	\$48.75
Totals - Cost to Install Electric Water Heater	\$647.87	\$804.63

Source: homewyse.com

Costs of Electrical Heater

Natural Gas Heater(0.093c /kwh)	Low	High
Gas Furnace Cost Non-discounted retail cost for common, mid-grade gas furnace.	\$903.46	\$1,148.55
Labor Direct labor expenses to install gas furnace.	\$269.87	\$283.07
Gas Furnace Job Materials and Supplies Cost of supplies that may be required to install gas furnace including: fittings, fasteners and mounting hardware.	\$180.99	\$195.99
Gas Furnace Equipment Allowance Job related costs of specialty equipment used for job quality and efficiency, including: pipe cutting and threading, tubing cutter, brazing kit and pipe wrenches.	\$24.00	\$48.75
Totals - Cost to Install Gas Furnace	\$1,378.32	\$1,676.35

Source: homewyse.com

Costs of Natural Gas Heater

Solar power(0c/kwh)	Low	High
Solar panels	\$4500.00	\$12000.00
Power Inverter.	\$1000.00	\$3000.00
Mounting Hardware	\$800.00	\$2000.00
Direct labor expenses to install the system.	\$2000.00	\$4000.00
Wiring	\$1000.00	\$2000.00
Permit and fees	\$3000.00	\$6000.00
Totals - Cost to Install Electric Water Heater	\$12300.00	\$20000.00

Source: Sunrun.com

*Discounts may apply and incentives from government and high ROI (Return of investment)

Costs of PV Solar Heating System

Firewood Heater (outdoor)(0.034c/kwh)	Low	High
Firewood Water Heater Cost Non-discounted retail cost for common, mid-grade firewood water heater.	\$3500.00	\$6000.00
Labor Direct labor expenses to install firewood water heater.	\$1500.00	\$2000.00
Firewood Water Heater Job Materials and Supplies Cost of supplies that may be required to install firewood water heater including: connectors, fittings and mounting hardware.	\$1000.00	\$1500.00
Firewood Water Heater Equipment Allowance Job related costs of specialty equipment used for job quality and efficiency, including: pipe cutting and threading, tubing cutter, brazing kit and pipe wrenches.	\$500.00	\$1500.00
Totals – Cost to Install Electric Water Heater	\$6500.00	\$11000.00

Costs of Firewood Heater

Select Category	Input #
Other - # Gallons of Hot Water Per Day ▾	100

Select State	MA ▾
--------------	------

Energy Assessment	Data
Hot Water Temperature out (F)	120
Ground Water Temperature in (F)	55
Collector BTU (if known)	42,400
Collector sq. ft. (if known)	40
Energy Source (Gas, Kwh, Lp, Oil)	Kwh ▾
Energy Source Rate Per Fuel Unit \$	1.00
Your Federal Tax Rate for Depreciation	35%
Your business has "non-profit" status	Yes ▾

System Components	
Flat Plate Collectors	2
Total Absorbing Surface	80.00
Output per Collector	42,400
Total Daily BTU Output	84,800
Minimum Storage Tank (Gal)	80
Maximum Storage Tank (Gal)	140

Results	
State	MA
Hot Water Daily Consumption (Gal)	100
Daily Energy Required in BTU	54,210.00
Daily Energy Required in Therms	0.5421
Renewable Energy Savings	
Total Annual Energy Fuel Units Saved	11,062
Total Annual Pounds Of CO2 Saved	534
Costs	
Solar Thermal System Price (est.)	\$5,693
Estimated Installation	\$1,900
State Tax	\$356
Total System Installed Value	\$7,949
State Rebate	\$0
Federal Tax Credit - (30% of installed cost)	\$0
Possible 179 Deduction *	\$-2,782
Federal Tax on State Rebate *	\$0
Possible MACRS State Depreciation *	\$-421
Total Estimated Net Cost	\$4,746
Estimated Annual Savings \$	\$11,062
ROI (Return on Investment) Years	0.43
* Check with your accountant	

Costs of Solar Water Heater

*Source <http://www.freehotwater.com/solar-calculators/solar-thermal-calculator/>

Appendix N: Estimated Cost for Internal System

Part	Model No	Unit Cost	Units	Est. Cost
Water Tanks				
275Gal Tank		\$100	6	\$600
Pump 120GPH	PP12005	\$30	6	\$180
Piping(Est)				\$200
Subtotal				\$980
Bedding				
Plywood	3/4"x4"x8'	\$34.98	12	\$419.76
2x4	2"x4"x8'	\$2.76	30	\$82.80
Pond Liner	10' x 13'	\$59.97	6	\$359.82
Supports (Est)				\$120
Subtotal				\$862.38
Heating				

Space Heater	Dayton U36 240v	\$179	1	\$179
Water Heater	PRO Line Titanium Aquatic Pond Heater 1kw	\$296	1	\$296
Subtotal				\$475
Lighting				
Overhead Lights	C 2 96 120 GEB	\$40.78	2	\$81.56
Bulbs	T12 75-Watt (15 pack)	\$5.07	15	\$76.00
Subtotal				\$157.56
Work Space				
Tables + Cabinets				\$1,000
Subtotal				\$1,000
Misc.				
Technocopia Membership		\$400	1	\$400
Wood Glue		\$7	12	\$84
Screws	2"	\$8	6	\$48
Screws	3"	\$8	12	\$96
Subtotal				\$628
Total				\$4,103

Appendix O: Estimated Cost for Wooden Structure

Materials	Amount	Dimensions	Sources	Total Cost
Wood		Various	Plywood plus (local)	\$2,000.00
Paneling				
Twin wall	1188 ft2	2'x4'	Greenhousemegastore.com	\$3,520.00
Nontransparent Walls				
Plywood	572.0 ft2	¾" x 4' x 8'	Home depot	\$1,246.96
R13 Roll	572.0 ft2	1.24' x 32.00'	Home depot	\$171.60
Foundation				

Screwed up over here, But the foundation materials are under site and utilities				
Totals				
Total Wood (approximate)				\$6,938.56

Appendix P: Grow Bed and Stand Schematics

