

# **Camioneta Mágica: Developing a Mobile Education Workshop to Reconnect Costa Rican Youth with Their Environment**



An Interactive Qualifying Project Final Report  
Submitted to the Faculty of  
**WORCESTER POLYTECHNIC INSTITUTE**  
In partial fulfillment of the requirements for the Degree of Bachelor of Science  
Submitted on March 2, 2017

**Submitted by:**

Damon Ball  
Andrew Casella  
Aaron Hartford  
Bethany Mays

**Submitted to:**

Professor Fabienne Miller, Worcester Polytechnic Institute  
Professor Seth Tuler, Worcester Polytechnic Institute

**Sponsors:**

Giancarlo Pucci, Executive Director of Árboles Mágicos  
Isabel Vargas Rumoroso, Coordinator of Módulo Educativo  
San José, Costa Rica Project Center

This report represents the work of four WPI undergraduate students submitted to the faculty as evidence of completion of a degree requirement. WPI routinely publishes these reports on its website without editorial or peer review. For more information about the projects program at WPI, please see

<http://www.wpi.edu/Academics/Projects>



# **WPI**

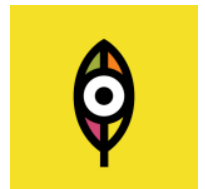

## **Abstract**

Children within the city of San José, Costa Rica lack access to greenspaces and are often disconnected from the rich natural environment. This project aided Árboles Mágicos to model and determine the feasibility of a mobile nature workshop that would teach children in San José about Costa Rican trees and forests. We completed a literature review and interviewed teachers and museum exhibit designers to identify effective teaching methods and determine the educational content of the workshop. We suggested the workshop teach skills and values such as empathy and transversality through environmental topics and by using interactive and autonomous activities. We created two designs of the mobile nature workshop, including the vehicle and the activities, and assessed their cost and feasibility.

# Acknowledgements

We would like to thank the following individuals who have helped guide us in completing this Interactive Qualifying Project:

Árboles Mágicos, particularly Giancarlo Pucci and Isabel Vargas Rumoroso, for sponsoring this project and providing us with resources and support.

We would also like to thank everyone who participated in our interviews and surveys. We appreciate local teachers Jeff Norris, Karla Rojas Hidalgo, and María Castro, along with Cristina Briceño Lobo, the Chief of the Department of Museography at the Museo de los Niños, for taking time out of their schedules to participate in our interviews. We would also like to thank Professor Steven Taylor from Worcester Polytechnic Institute for participating in a phone interview. Lastly, we would like to extend our gratitude to the teachers from CTP Uladislao Gamez Solano and museum exhibit designers from the Children's Museum of Indianapolis and The Exploratorium in San Francisco who participated in our surveys.

Finally, we would like to thank our advisors, Professors Seth Tuler and Fabienne Miller, for their continued support and guidance over the course of this project, along with Worcester Polytechnic Institute for allowing us the opportunity to complete this project.

# Executive Summary

Greenspaces in cities, such as parks and gardens, can help residents develop a connection to nature. However, many cities only have a small amount of greenspace, which has caused urban residents to lose access to the natural environment (Dinetti et al., 2004). The disconnect between people and the environment has been shown, especially in children, to cause heightened anxiety, lower self-esteem and many other mental and physical problems (Louv, 2005). Studies have shown that outdoor education, such as nature-based learning, can reverse these problems in children as cognitive abilities, social skills, and creativity have been shown to improve with increased exposure to the environment (Beyer et. al, 2014; Cheng, 2008; Fjørtoft, 2001; American Institutes for Research, 2005).

Schools in the United States and much of Europe are beginning to broaden environmental education by incorporating more outdoor education into their curriculum (NAAEE, 2014; Youth and Environment Europe, 2014). The North American Association for Environmental Education (NAAEE) works with states to promote and implement outdoor education plans into schools (NAAEE, 2014). These plans “integrate environmental education into school curricula... and give teachers and students new opportunities to take learning outside” (NAAEE, 2015). Árboles Mágicos, a non-profit organization in San José, has attempted to make environmental education more accessible by traveling to schools within Costa Rica to teach students about flowering trees and how students can relate to trees. Árboles Mágicos is interested in integrating the best practices for environmental education with their programs at schools.

While outdoor teaching methods can be beneficial, greenspaces for use in outdoor education are not accessible everywhere. For example, the city of San José is surrounded by mountains, which makes it difficult for children living in San José to access the natural environment outside of the city. To compound this problem, students attending public schools in the city are not taught to appreciate the natural environment of Costa Rica and are instead only taught basic biology and sustainability concepts (Ministerio de Educación Pública, 2016). A method to make outdoor education more accessible is through the use of mobile education workshops. An example of a mobile education workshop is the Prakriti Environmental Education Bus in India (Centre of Environmental Education, 2016). The Prakriti Bus provides lessons on sustainability to people who do not have regular access to environmental education.

The goal of this project was to design a mobile nature workshop that would be able to reconnect the children of San José with the natural environment while simultaneously promoting a culture of appreciation for trees and nature through outdoor education. Mobilizing outdoor education could allow children attending school in San José to gain access to outdoor education that they are currently lacking exposure to.

## Methods

To accomplish the project goal:

- We determined the educational goals for a mobile workshop, which included the skills and values Árboles Mágicos wanted to encourage as well as the environmental topics that could be used to teach these skills and values.
- We identified effective teaching methods that could be adapted for use in a mobile workshop. Effective methods promote learning of information in a way that students can

remember long after they visit the mobile workshop. We brainstormed ideas for activities that use effective teaching methods. We then observed exhibits at the Museo de los Niños, a children's museum in Costa Rica, to improve and validate the activities we had identified and to add new activities.

- We proposed designs for a mobile nature workshop and assessed their feasibility. The mobile nature workshop has two components: the design of the vehicle, and the activities that would be present inside of the vehicle. We proposed the designs by creating three-dimensional representations of two vehicles, one larger in size than the other. In addition, we estimated the cost of each component for the construction of the mobile nature workshops.

## **Key Findings and Recommendations**

Over the course of the project we interviewed a preschool teacher, a biology teacher, and environmental education teacher, along with a local museum exhibit designer. To supplement these interviews, we obtained information, via surveys, from three museum exhibit designers based at the Exploratorium in San Francisco, California, and one from the Children's Museum of Indianapolis.

First we present findings and recommendations related to the educational content for the mobile workshop, followed by findings and recommendations for effective teaching methods for use in the mobile nature workshop. Finally we present key findings and recommendations related to the design and feasibility of the mobile nature workshop.

### **Recommendation for the Educational Content in the Mobile Workshop**

#### **1. Árboles Mágicos should include the following educational topics in the mobile nature workshop:**

- The life cycle of trees
- The physical components of a tree
- The tree's effect on the ecosystem
- Different species of trees
- The parts of a forest
- The symbol of a tree in cultures around the world
- Communication between trees

Each topic expands on the basic biology topics taught in the Costa Rican curriculum. Expanding on topics taught in local school systems increases the impact of an educational exhibit, which museum exhibit designers do to improve their exhibits (McClafferty and Rennie, 1995). The set of topics can be used to teach the educational goals that Árboles Mágicos wants to accomplish as each topic can be used to teach one or more of the following skills and values:

- Empathy
- Transversality
- Sense of community
- Motivation to make a change
- Leadership skills

## **Recommendations for the Design of the Mobile Workshop**

### **2. Árboles Mágicos should include visuals, animations, and hands-on activities in the mobile workshop.**

Students learn better through verbal and physical types of experiences (Horn, et. al. 2016). Teachers, as well as museum exhibit designers, suggested these types of educational tools and activities to use during the interviews because they believe that children learn better through lessons with visuals and objects they can touch. Research has also shown that interactive exhibits can remain on students' minds up to six months later (McClafferty and Rennie, 1995).

The activities we recommend for the mobile nature workshop that incorporate visuals, animations, or hands-on activities include:

- A video that demonstrates a tree's impact on the ecosystem and its cultural significance in order to create a sense of community and teach leadership skills
- An animation that details the life cycle of a tree to encourage transversality and empathy
- A website that contains multiple interactive games about forests to create a motivation to make a change
- A scavenger hunt that shows the symbiotic relationships trees have with various species to create empathy
- A voice box that shows how trees communicate with each other to teach transversality
- A flower planting activity to teach students about sustainability that is located outside of the workshop
- A role-playing activity with costumes to teach transversality and empathy
- An activity that teaches students to be mindful while inside of the mobile workshop

### **3. Árboles Mágicos should invest in durable materials and protective coverings for all technologies inside the mobile nature workshop.**

We recommend that Árboles Mágicos invest in protective casings for iPads, TVs, and projectors that would be present inside of the mobile nature workshop. Investing in casings is necessary to protect the technology from the Costa Rican environment, volcanic ash, and possible rough play from students. The investment in durable protection can increase the longevity of all technologies in the workshop, and therefore save money that could have been spent replacing expensive equipment. Museum exhibit designers invest in protective coverings for all exhibits that use expensive technology as children can damage technology easily.

### **4. Árboles Mágicos should include lights, smells, sounds and objects in the mobile nature workshop that students can touch.**

We recommend that the mobile workshop contain activities that engage students' senses of sight, sound, smell, and touch. Interviews with teachers and museum exhibit designers showed that engaging all five senses is an effective method in improving student participation and understanding of educational content. One teacher strongly suggested that the mobile workshop give the feeling of being inside of a forest through the use of sounds, smells, and lights.

## **Recommendations for the use of the mobile nature workshop**

**5. Árboles Mágicos should measure the impact of the mobile nature workshop on students.**

In order to measure the impact that the mobile nature workshop has on children, we recommend that Árboles Mágicos survey the students that partake in the mobile nature workshop. The Children’s Museum of Indianapolis and the Museo de los Niños survey visitors to measure the impact of each exhibit. In order to survey the students that learn in the workshop, we recommend that, after the students leave the workshop, their teacher asks the group of students questions about their experience in the mobile nature workshop and report the information to Árboles Mágicos. Through measuring the impact of the workshop and its adaptability as an environmental teaching tool, Árboles Mágicos can create behavioral changes in the target audience in the future. We suggest that the results of the student surveys be used to improve the workshop.

**6. Árboles Mágicos should use an adult guide to educate students about how to use the technology and be present inside of the mobile nature workshop.**

We suggest that Árboles Mágicos use someone to instruct students on how to use the equipment properly and set the ground rules of the workshop. The person should have an understanding of all activities and technologies inside the workshop and how to use them properly. The Boston CityLab uses a lab instructor to guide students on how to properly use laboratory equipment and answer questions that may arise (Boston University, 2016). One teacher also recommended the use of a guide for the mobile workshop in an interview.

We also recommend that a list of specific rules be presented to the students so they understand the limits on how they can use each activity and piece of technology. Teaching these rules to the students beforehand can increase safety of both the students and the technology.

**7. Árboles Mágicos should work with private schools to develop interest from public schools in the mobile nature workshop.**

Out of three Costa Rican public school teachers who replied to our survey, two stated that they do not have time to take their students outside. The third teacher stated that they only take their students outside for one to five hours a month. The lack of outdoor education is due to the strict schedule that public schools must follow, which private school teachers mentioned during interviews. Therefore, we recommend that Árboles Mágicos invite public school teachers to observe the mobile workshop when it is at private schools. Public school teachers can observe the effectiveness of the workshop and discuss its benefits with their peers.

**8. We recommend that Árboles Mágicos prototype the mobile nature workshop.**

One teacher suggested in an interview that we prototype the mobile nature workshop to test the workshop’s impact on the students of San José, Costa Rica. We recommend that Árboles Mágicos first invest in a less expensive model to show that the concept of a mobile nature workshop can be effective in teaching environmental topics and creating change among urban youth. The positive experiences can be used to solicit more funding and gain interest from additional teachers and schools in San José.

**9. The vehicle for the mobile nature workshop should comply with handicapped accessibility laws.**

We recommend that all models for the vehicle would have at least one ramp that is approved for wheelchair-accessibility as to abide by Ley 7600. Ley 7600 requires all spaces be

accessible for people with disabilities. We also recommend that the two models for the vehicle allow a minimum of 1.52 meters throughout the interior of the workshop, as to accommodate wheelchair movement within the vehicle. For visually-impaired students, we recommend that all written words be accompanied by braille. We recommend that sign language be included in all video presentations for students that are hearing-impaired.

We also created four deliverables to present to Árboles Mágicos. First, we developed a content matrix that contained the environmental topics we suggested to use in the workshop and research about each topic. The research included all of the information necessary to create lessons for each topic. Each topic was chosen based on Árboles Mágicos' previous educational projects and topics lacking in the Costa Rican curriculum. Second, we created a set of activity scripts, which are detailed steps to create and set up each activity we proposed for the workshop. Third, we designed two three-dimensional models, including the vehicle and activities. Finally, we created a bill of materials which lists the components necessary to create each activity as well as potential vehicles to house the workshop. With these four deliverables, Árboles Mágicos can create and test each activity, determine how much money they plan to invest, and then build the workshop and activities from the designs.

## **Conclusions**

The mobile nature workshop is intended to give children living in San José, Costa Rica the opportunity to connect with their natural environment to develop a better appreciation. The mobile nature workshop could give teachers in San José the ability to use outdoor teaching in their classrooms to create a positive change in their students. Studies have shown that children can gain increased cognitive abilities, relationship skills, and creativity with increased exposure to the outdoor education (Fjørtoft, 2001). The outdoor education in the workshop can also encourage pro-environmental behaviors (Berenguer, 2007). Encouraging pro-environmental behavior through the use of a mobile nature workshop can inspire change and increase overall environmental awareness in the general population.



# Authorship

**Aaron Hartford** – For this paper, Aaron was a primary writer. He contributed significant writing effort to all major sections of the paper. He also contributed to this project through research and creating charts and graphs.

**Andrew Casella** – Andrew built the 3-D models of the mobile nature workshop and found the costs of the vehicles and materials in the bill of materials. Andrew also did some proofreading and secondary editing for the paper.

**Bethany Mays** – Bethany was the primary editor of the whole paper. She contributed writing to all major sections of the paper. She also proofread for wording and grammar. Bethany did the final overall read-through of the draft as well.

**Damon Ball** – Damon was also a primary writer. He, along with Aaron, contributed significant writing effort to the major sections of the paper. He was also a major editor for the paper.

# Table of Contents

Abstract .....	i
Acknowledgements .....	ii
Executive Summary .....	iii
Authorship .....	viii
Table of Contents .....	ix
List of Figures .....	x
List of Tables .....	xi
1. Introduction .....	1
2. Literature Review .....	4
2.1. Beneficial Effects of Environmental Exploration for Children .....	4
2.2. Effective Teaching Methods for Engaging Children .....	6
2.3. Mobile Workshops .....	9
2.4. Background Summary .....	10
3. Methods .....	12
3.1. Objective 1: Determine the Educational Content in the Mobile Workshop .....	12
3.2. Objective 2: Identify Effective Teaching Methods for the Mobile Workshop .....	13
3.3. Objective 3: Design the Mobile Workshop and Assess its Feasibility .....	15
3.4. Summary .....	15
4. Results .....	17
4.1. Educational Content in the Mobile Workshop .....	17
4.2. Effective Teaching Methods for the Mobile Workshop .....	18
4.3. Design of the Mobile Workshop and its Feasibility .....	21
4.4. Summary .....	22
5. Recommendations .....	23
5.1. Recommendation for the Educational Content in the Mobile Workshop .....	23
5.2. Recommendations for the Design of the Mobile Workshop .....	24
5.3. Recommendations for the use of the mobile nature workshop .....	28
5.4. Discussion of the Design for the Mobile Nature Workshop .....	30
6. Conclusions .....	32
7. References .....	33
8. Appendix .....	39

## List of Figures

<b>Figure 1</b> - One of the beautiful flowers of <i>pseudobombax ellipticum</i> , also known as the “shaving brush tree” that can be found in Costa Rica.....	1
<b>Figure 2</b> - Child assembling robot with LEGOs at competition (Gura, 2014).....	7
<b>Figure 3</b> - Advantages for the implementation of a virtual field trip as opposed to real field trip (Adapted from Caliskan, 2011).....	8
<b>Figure 4</b> - Visual representation of the Environment Education Bus (Centre of Environmental Education, 2016).....	10
<b>Figure 5</b> - Representation of how environmental topics can create an appreciation for the natural environment .....	13
<b>Figure 6</b> - Visual representation of the process used to select content.....	13
<b>Figure 7</b> - Pyramid representing how components of the project build off each other.....	16
<b>Figure 8</b> - Example of hands on activity from the Museo de los Niños.....	25
<b>Figure 9</b> - Industrial iPad case to preserve technology.....	27
<b>Figure 10</b> - Visual representation of smaller version of the mobile nature workshop.....	30

# List of Tables

<b>Table 1</b> - Representation of how every skill and value is encouraged through the set of environmental topics.....	24
<b>Table 2</b> - Representation of how every recommended environmental topic is taught through the set of recommended activities.....	26

# 1. Introduction

Greenspaces in cities, such as parks and gardens, can help residents develop a connection to nature. However, many cities only have a small amount of greenspace which has caused urban residents to lose access to the natural environment (Dinetti et al., 2004). The disconnect between people and the environment has been shown, especially in children, to cause heightened anxiety, lower self-esteem, and many other mental and physical problems (Louv, 2005). Studies show that nature-based learning activities can reverse these issues in children. Cognitive abilities, relationship skills, and creativity have all been shown to increase with additional exposure to the environment (Beyer et. al, 2014; Cheng, 2008; Fjørtoft, 2001; American Institutes for Research, 2005).

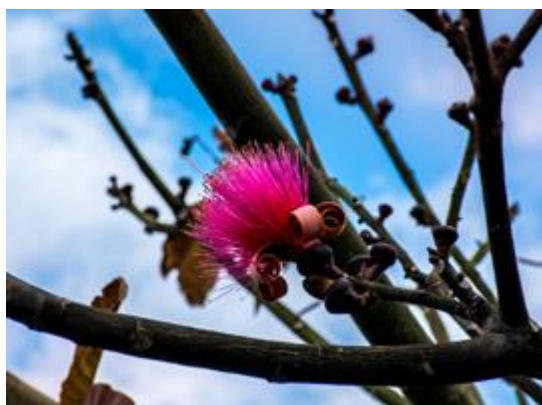

Figure 1 - One of the beautiful flowers of *pseudobombax ellipticum*, also known as the “shaving brush tree” that can be found in Costa Rica

While Costa Rica is home to approximately five percent of the world's biodiversity (Fiebelkorn & Menzel, 2013), its rich natural environment is not easily accessible to everyone. In particular, children living in the city of San José are surrounded by mountains, which limits their access to the natural environment. To compound this problem, students attending public schools in the city are not taught about forests in Costa Rica and are instead only taught basic biology and sustainability concepts (Ministerio de Educación Pública, 2016). This population of students is large. In 2012, 317,950 students attended public schools, which constitutes 92 percent of all students in San José (Giménez & Aristizábal, 2017).

Schools in the United States and Europe are beginning to broaden environmental education by incorporating more outdoor education into their curriculum (NAAEE, 2014; Youth and Environment Europe, 2014). The North American Association for Environmental Education (NAAEE) works with states to promote and implement outdoor education plans into schools (NAAEE, 2014). These plans “integrate environmental education into school curricula... and give teachers and students new opportunities to take learning outside” (NAAEE, 2015). One school that is a member of the NAAEE is the Cedarsong Nature School, which is a forest-immersion school, located in Washington that takes its students outside to learn for at least three

to four hours a day, five days a week. Programs at the Cedarsong Nature School are entirely outdoors and have no guided curricula as to encourage students to explore their natural environment autonomously (Cedarsong Nature School, 2017).

While outdoor teaching methods are very beneficial, greenspaces for use in outdoor education are not accessible everywhere. Árboles Mágicos, a non-profit organization, attempted to make environmental education more accessible with their project, Módulo Educativo. For Módulo Educativo, Árboles Mágicos traveled to schools within Costa Rica to teach students about flowering trees and how students can relate to trees. However, Módulo Educativo used lectures instead of outdoor education, and therefore had a limited impact. Another method to make outdoor education more accessible is through the use of mobile education workshops.<sup>1</sup> An example of a mobile education workshop is the Prakriti Environmental Education Bus (Centre of Environmental Education, 2016). The Prakriti Bus provides lessons on sustainability to people who do not have regular access to environmental education. However, environmental education has yet to be incorporated into a mobile format in Costa Rica. Mobilizing outdoor education could allow children attending school in San José to gain access to the environmental topics that the students are currently lacking exposure to.

A “mobile nature workshop” could be used to bring the experience of outdoor education to urban students in San José to develop an appreciation for nature. The goal of this project was to design a mobile nature workshop to reconnect children in San José to their environment and create a culture of appreciation for trees and nature. To accomplish our goal, we first determined the educational content for the mobile workshop. We learned that the skills and values that Árboles Mágicos wanted to encourage were empathy, transversality, sense of community, motivation to make a change, and leadership skills. We then researched environmental topics that could be used to teach these skills and values. Second, we identified effective teaching methods for use in the mobile workshop. Effective methods were teaching methods that promoted the learning of information in a way that students could remember long after they visited the mobile workshop. We then used these methods to develop activities to include in the design for the workshop. Finally, we proposed designs for the mobile workshop and assessed its feasibility. We found that the design of the mobile workshop had to be able to accommodate students with disabilities, and that all of the technologies inside should have durable protective casings. We created a model of the vehicle for the workshop that incorporated the activities we developed and took into consideration the accessibility requirements.

From these findings we created four major deliverables. The first deliverable was a content matrix that contained each environmental topic we suggested to use in the workshop and research about each topic. We also created a set of activity scripts as the second deliverable, which were detailed steps to create and set up each activity we designed for the workshop. Third, we designed two three-dimensional models, including the vehicle and activities that would be present inside the mobile nature workshop. Finally, we created a bill of materials that lists every component necessary to create each activity we designed and potential vehicles that could house

---

<sup>1</sup> A vehicle that contains educational activities and content

the workshop. With these four deliverables, Árboles Mágicos can create and test each activity, determine how much money they plan to invest, and then build the workshop and activities from the designs.

## **2. Literature Review**

Costa Rica has been described as “the most biologically intense place on Earth” (World Wildlife Fund, 2017) and is full of vibrant forests that can be useful in outdoor education. However, children growing up inside the city do not always get much exposure to the environment. The Literature Review discusses the benefits of outdoor education that urban children are missing and can obtain from an outdoor experience. Next, it discusses teaching methods that are effective methods to engage children and teach them in interactive and exploratory ways. Finally, using examples of projects and groups that employ these methods, we extract information to use in a mobile nature workshop.

### **2.1. Beneficial Effects of Environmental Exploration for Children**

Greenspaces, such as forests and parks, have many health benefits for all ages. Exposure to greenspaces has been shown to have mental health benefits such as decreased stress levels, improved mood, and better development in children (Wolch et. al, 2014). A study conducted in Wisconsin demonstrated that neighborhoods with higher tree coverage had significantly better mental health compared to those with less coverage (Beyer et al., 2014).

Greenspaces also provide opportunity for physical activity, which is beneficial in lowering childhood obesity rates and increasing cognitive function (Fedewa & Ahn, 2011). A 2012 study conducted in the US showed that children who have access to parks are more likely to have more physical activity. Physical activity has a positive effect on the health of children as it prevents obesity (Blanck et al., 2012). However, physical activity has more than just physical benefits. In 2011, a study found a positive correlation between physical activity and cognitive trends (Fedewa & Ahn, 2011). Children with higher amounts of physical activity had better cognitive development and higher academic achievement. Unfortunately, urban residents have become disconnected to the natural environment due to a lack of greenspaces (Dinetti et al., 2004) and thus lack the developmental benefits associated with environmental exploration.

#### **2.1.1. Children and the Benefit of Outdoor Education**

Early exposure to nature through schooling can have profound benefits in childhood development (American Institutes for Research, 2005). These developmental benefits include improved social skills, higher levels of self-esteem, and increased overall physical wellness (American Institutes for Research, 2005; Fjortoft, 2001; Fischer, 2013). Due to the benefits associated with outdoor education, many schools are aiming to include environmental topics in their curricula (Cheng, 2008). Presently, there are schools that are completely focused on nature-



based learning, called forest-immersion schools. Forest-immersion schools, also referred to as forest kindergartens or outdoor schools, are used to engage children from preschool to the sixth grade and aim to create a lifelong connection to the environment (Fisher, 2013). Examples of forest-immersion schools include the Cedarsong Nature School, located in Washington, and the Forest School of Minnesota (Cedarsong Nature School, 2017; Forest School of Minnesota, 2016). Three cases of forest-immersion schooling that have been studied include:

- A 2013 study examined six forest kindergartens and found that including environmental exposure in their curricula gave students a higher knowledge of the environment and also had a significant increase in their cognitive skills (Fisher, 2013).
- Another study catalogued 255 sixth graders in California that attended different outdoor programs at least twice a week. These students developed significant gains in their self-esteem, problem-solving skills, and other interpersonal behaviors (American Institutes for Research, 2005).
- A Norwegian forest kindergarten allowed 46 children to have free play and environmental activities in the forest for 1-2 hours per day throughout the year. Over the course of the year, students had an increase in motor ability and balance due to the uneven forest landscape (Fjørtoft, 2001).

Additionally, learning in an outdoor setting creates a variety of different ways to incorporate information into activities (Dhanapal, 2013). This can be a welcome change from the typical classroom setting.

### **2.1.2. Skills and Values Gained from Outdoor Education**

Outdoor education is also useful for teaching life skills such as leadership, empathy, and mindfulness. According to Yeap, et. al (2016), “Among others, outdoor-based education activities are seen to be one of the most famous ways to enhance students’ leadership skills” (p. 352). Outdoor education has also been used to increase students’ ability to be mindful, which is the ability to thoroughly observe and experience the world around oneself using all five senses. Using the natural environment can be an excellent way to teach mindfulness, as illustrated by the following outdoor mindfulness exercise:

Students are taken outside, and are first asked to close their eyes, and then asked to feel the sun on their skin. Students are then asked to connect with the earth and to envision their favorite place or thing from the natural world. Finally, they are asked to end by gently opening their eyes. (Outdoor Mindfulness Exercises for Earth Day, 2015)

The skills and values learned through outdoor education can also be used to encourage pro-environmental behaviors. Outdoor education programs have been shown to increase motivation in students in order to make a difference in their environment. A study by Legault (2000) created an environmental program that, at its conclusion, determined that subjects had an increased motivation to use pro-environmental behaviors (Legault, 2000). Outdoor education has

also been shown to increase a subject's empathy for the natural environment, which also leads to more beneficial environmental behaviors. A study by Jaime Berenguer (2007) showed that subjects who had developed empathy for objects, such as birds or trees, later developed more pro-environmental behaviors (Berenguer, 2007). However, the impact of the skills and values discussed relies on the teaching method used.

## **2.2. Effective Teaching Methods for Engaging Children**

Motivation is critical for teaching methods to be effective and engaging, as illustrated by researchers at New Mexico State University (Girmus, 2012). The researchers developed a module in which they determined key strategies involved in motivational learning, including situational interest, student autonomy, and real world connections:

- Situational interest combines games and movement with educational topics. Common examples of situational interest include educational bingo or creating simple science experiments to explain complex information. Using the strategy of situational interest allows students to associate content with fun.
- Student autonomy allows students to make major decisions in the learning process. For example, a teacher gives students a stack of magazines and tells the students to teach the class about something interesting they found. The students have the opportunity to learn about a topic that is of interest to them.
- Real-world connections allow students to practice real-world concepts and skills. An example would be having a student write to a younger student about a subject they would learn in school. Real world connections provide the opportunity to gain a real world skill through practice.

Another effective teaching method for motivating students to learn is through the use of storytelling. Some teachers, like Professor Steven Taylor of Worcester Polytechnic Institute, use stories whenever possible when teaching. "Students tend to remember a story better than they remember set of facts" (S. Taylor, Phone Interview, February 21, 2017). When students are presented information through a story, they are given more ways to make associations with the material in their mind.

### **2.2.1. Interactive Learning and its Effect on Childhood Education**

Interactive learning methods, such as hands-on activities, are frequently used to convey environmental topics (Cheng, 2008). Interactive activities are methods that allow students to see and feel educational concepts. Research has shown that students learn better through verbal and physical types of experiences (Horn, et. al. 2016). Interactive activities can be implemented in various ways.

Interactive museum exhibits can be an example of a fun and interactive teaching tool. In museums, children are given an exhibit or puzzle that they can touch and move around on their own. Interactive museum exhibits can increase a child's creativity, critical thinking skills, problem-solving skills, and mental growth (Children's Discovery Museum, 2015). An award-winning review paper by McClafferty and Rennie (1995) found that allowing children to explore an interactive exhibit on their own without adult guidance stimulated their cognitive development and curiosity (McClafferty & Rennie, 1995). McClafferty and Rennie also discovered that lessons learned through interactive exhibits can remain on children's minds up to six months later, especially when teachers had begun to teach lessons in their classes beforehand (McClafferty & Rennie, 1995).

Children tend to lose understanding while sitting and listening to a teacher lecture about complex subjects, like science, technology, engineering, and math (STEM) (Horn, et. al, 2016). Instead, using interactive objects such as games and toys to create situational interest helps motivate students to learn. LEGO Robotics' goal was to increase passion and education for science and technology in young children using LEGOs as an educational tool (Gura, 2014). Children used LEGOs to complete tasks and projects that employed STEM skills. Overall, students that participated in the LEGO Robotics program demonstrated an increased knowledge of STEM topics and developed a passion for STEM topics as well (Gura, 2014).



Figure 2 - Child assembling robot with LEGOs at competition (Gura, 2014)

An additional style of interactive learning is the use of virtual field trips. Virtual field trips can reinforce ideas taught in classrooms by teachers and are effective at enhancing students' learning experiences (Caliskan, 2011). These virtual programs aid in the repetition of key ideas and also introduce new ideas to students (Cheng, 2008). Virtual field trips are a beneficial way of

stimulating students’ interest by grabbing their attention and introducing new topics (Caliskan, 2011). Figure 3 refers to the advantages of using virtual field trips in the classroom.

<b>The Advantages of Virtual Field Trips</b>
Helpful for presenting trips to inaccessible areas
Provide an alternative of fieldwork, when time, expenses, and/or logistics are real issues
Enable presentations of extensive field trips and great variety of landform diversity
Enable flexibility of access
Provide a repeatable exercise which can be used to reinforce concepts in class
Information rich
Hold abundant materials and information
Offer rich resources of learning and teaching
Available for users of different levels and demands
Interesting and attractive to students and an alternative experience for users

Figure 3 - Advantages for the implementation of a virtual field trip as opposed to real field trip (Adapted from Caliskan, 2011)

An example of a virtual field trip program is the LagoonQuest software developed by the Brevard Zoo in conjunction with Brevard County Public Schools in Florida (Cheng, 2008). Aimed at fourth graders, the program was designed to promote environmental awareness in students through an interactive platform and promote a conservation ethic. Students who participated in the program increased their knowledge of environmental topics and favored topics that they were familiar with.

### **2.2.2. Costa Rican Curriculum in Private and Public Schools**

Private schools have the ability employ different teaching styles. Private schools also have access to higher quality materials which allows them to experiment with teaching outdoor education using a variety of methods (Giménez & Aristizábal, 2017). Students attending private schools also have a larger opportunity to research environmental topics that interest them at home or after school. Fernández and Valle found that private school students have significantly greater access to resources for studying, including a desk in their room, access to a computer,

and internet (Fernández & Del Valle, 2013). For these reasons, private schools have a greater capability to choose the topics they teach and the methods they use to teach them.

However, public schools are held to a rigid curriculum (Giménez & Aristizábal, 2017). Costa Rican compulsory education is broken up into two types: primary education and secondary education. Primary school is broken up into cycles: Cycle I consisting of grades 1, 2, and 3, and Cycle 2 consisting of grades 4, 5, and 6. In Cycle I, students learn to identify the basic parts of plants and animals as well as the basic concepts of sustainability (Ministerio de Educación Pública, 2016). However, in the second cycle the curriculum moves towards biological teaching rather than environmental education (Ministerio de Educación Pública, 2016). The curriculum for public schools lacks environmental topics that can motivate students to become interested in the environment. Because students only have an introductory knowledge of environmental education, many students do not gain many of the benefits discussed in Section 2.1.

## **2.3. Mobile Workshops**

An excellent way to implement interactive learning can be through mobile workshops. Mobile workshops are capable of bringing interactive activities to students who are not exposed to them in their regular schooling. Mobile workshops are often large vehicles that can drive to a school to offer the educational activities inside. The Boston University CityLab provides an example of a mobile workshop that teaches students through hands-on activities (Boston University, 2016). The Boston University CityLab is a fully-equipped laboratory designed for introducing elementary biology topics to middle and high school students that do not have access to expensive equipment within their schools. The labs are fully self-guided and are presented as mysteries so that students use deductive reasoning to complete them. The CityLab model has been adapted and incorporated by universities and public institutions across the globe. Moreover, Boston University has adapted its own model and formed a MobileLab, which is a 40 foot mobile laboratory that is also fully-equipped. It is able to travel around in order to accommodate multiple classes of students and also provide equipment to diverse student populations. Not only does this make visiting the exhibits easier for children, but it is also an example of the interactive exhibits that participants explore at their own pace, the benefits of which were discussed in Section 2.2.

### **2.3.1. Benefits of Education on Wheels**

Another benefit of mobile education workshops is that the exterior wall of the vehicle is available for displaying eye-catching images. As discussed in Section 2.2.1, it is important to stimulate the curiosity of the students, which can be done through displaying intriguing images along the exterior of a mobile education workshop. The Prakriti Environmental Education Bus is a mobile workshop from India that used color images painted on its side to attract people's attention. As the workshop attracted viewers, it could begin teaching how to adopt better environmental behaviors.



Figure 4 - Visual representation of the Environment Education Bus (Centre of Environmental Education, 2016)

Both the Boston CityLab and the Prakriti Environmental Education Bus have the benefit of a large size which allows the mobile workshops to contain a lot of activities. As the developers of the Prakriti Bus realized, its large size allowed for the bus to contain several different exhibits which they could swap out depending on the audience being presented to (Centre of Environmental Education, 2016). The exhibits shown in mobile education workshops can also be coordinated with the lessons students are learning in schools to achieve the greatest effect (McClafferty & Rennie, 1995). Prefacing the material covered in an interactive exhibit with in-class teaching can give the exhibits an even greater effect (McClafferty & Rennie, 1995).

## 2.4. Background Summary

By combining outdoor education with interactive exhibits and implementing them inside a mobile workshop, children in San José, Costa Rica can gain a deeper connection with their natural environment and develop important skills. We intended to make outdoor education enjoyable through the use of interactive exhibits, and created a design for a mobile nature workshop that can bring these exhibits to the schools of San José, Costa. We designed this

concept for the purpose of creating a culture of appreciation for the natural environment in Costa Rica. To achieve this, we completed three major objectives. For the first objective, we discovered environmental topics that can effectively create this change. Then, for the second objective, we designed interactive activities to put inside the workshop based on interviews and surveys with teachers and museum exhibit designers. The last objective was to assess the cost of the designs and the feasibility of constructing the workshop.

### 3. Methods

Árboles Mágicos' purpose is to “be a bridge of reconnection between people and nature, by building a culture of appreciation of trees, especially in flowering trees” (Árboles Mágicos, 2010).<sup>2</sup> The goal of this project was to design a mobile nature workshop to reconnect children in San José to their environment and create a culture of appreciation for trees and nature. The workshop design aimed to create a culture of appreciation for the environment in urban youth aged seven to twelve that live in San José, Costa Rica by exposing them to the environment and environmental topics. At the conclusion of the project, we created two designs for a mobile nature workshop. To produce these designs we formed the following objectives:

- Determine Educational Content for the Mobile Workshop
- Identify Effective Teaching Methods for the Mobile Workshop
- Design the Mobile Workshop and Assess its Feasibility

With each objective we used a Scrum method of project organization, where each week we evaluated the project as a whole. With this Scrum method, we created a backlog, an accumulation of uncompleted tasks, with all of the tasks the group decided were crucial to completing this project in two months (see Appendix B). Along with this backlog we created a Gantt chart (see Appendix A), which determined the time necessary for each task in the backlog and when we began and completed each task.

#### 3.1. Objective 1: Determine the Educational Content in the Mobile Workshop

For the first objective, we identified key values and skills needed to reconnect children in San José to their environment and create a culture of appreciation for trees and nature. We investigated which skills and values would be most beneficial for creating an appreciation for the environment in Costa Rica. Section 2.1.2 of the Literature Review discusses how encouraging skills and values, such as empathy, correlates to more pro-environmental behaviors. We then determined which environmental topics could be used to instill skills and values in the target audience. Figure 5 below gives a visual representation of how the environmental topics will be used to encourage skills and values, and how the skills and values create the culture of appreciation for the natural environment. All of the information needed to create a lesson plan for each topic was thoroughly researched.

---

<sup>2</sup> Translated from Spanish



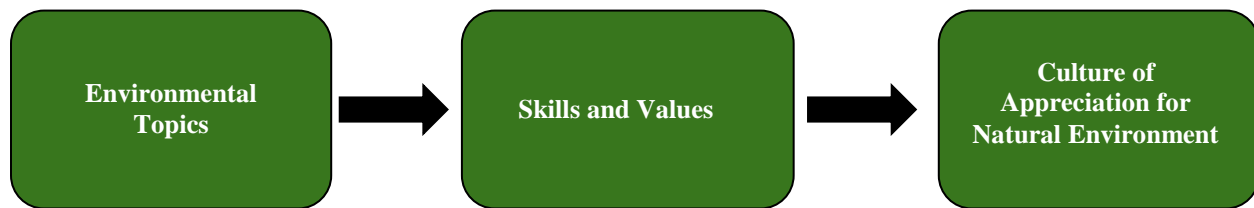

Figure 5 - Representation of how environmental topics can create an appreciation for the natural environment.

We had a discussion with the founder of Árboles Mágicos, Giancarlo Pucci, on how he started the organization and the reasons behind its creation. Giancarlo Pucci discussed similar environmental education projects Árboles Mágicos is undertaking and presented us with an extensive list of topics the organization finds to be important. We then researched the topics provided by Árboles Mágicos and added topics that the Costa Rican curriculum does not include in order to give the students more in-depth environmental education.

Once we created a set of possible topics, we discussed them with Árboles Mágicos to refine the list, discarding environmental topics they saw as less useful. Figure 6 visually represents the process of creating the final set of environmental topics from the topics Árboles Mágicos provided and topics lacking in the Costa Rican curriculum. All of the remaining topics were compiled into a content matrix, which can be found in Appendix C. The matrix includes a description of each environmental topic, all of the research to use in a lesson about the topic, and the skills and values encouraged by the topic. The information provided in the content matrix can allow Árboles Mágicos to create lesson plans for use in a mobile nature workshop.

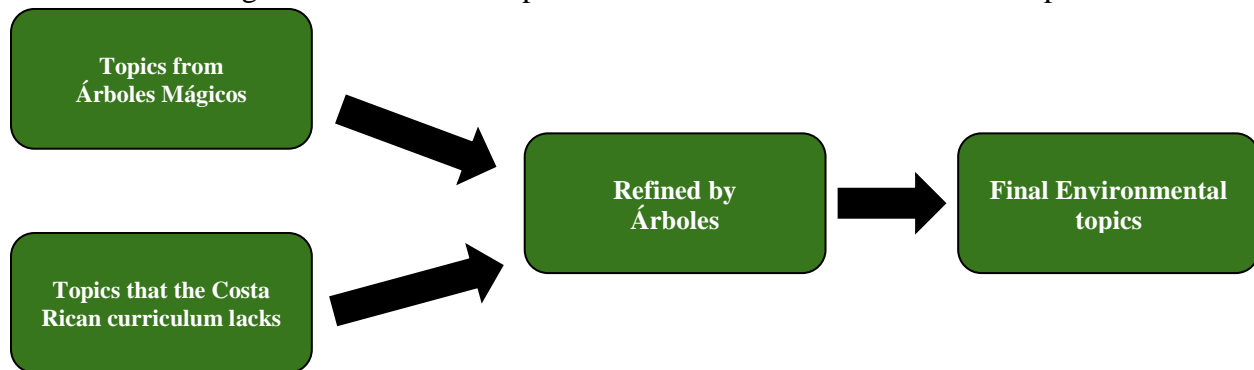

Figure 6 - Visual representation of the process used to select content.

### 3.2. Objective 2: Identify Effective Teaching Methods for the Mobile Workshop

Once we determined the educational content for the mobile nature workshop, we determined how to effectively teach this content to the target audience. We identified teaching methods and designed activities that would deliver the content from the first objective. We investigated methods through interviews and surveys with teachers and museum exhibit

designers that incorporated situational interest, student autonomy, and real-world connections, as discussed in Section 2.2 of the Literature Review. These methods included various interactive and engaging activities. We determined which of the methods that were discussed in Section 2.2 of the Literature Review were being used in Costa Rica and how they were being implemented.

The first step was to interview local teachers. We contacted three private school teachers due to their expressed interest in the project and their availability. The interviewees included an environmental teacher, a biology teacher, and a preschool teacher. These teachers had experience using a variety of teaching methods in the classroom. We held interviews in-person and used a semi-structured interview model (see Appendix D). When we could not hold in-person interviews, we conducted video interviews. We asked for permission to record each interview so that we were able to revisit what was discussed. We conducted these interviews throughout the first four weeks of the project, whenever the teachers were available so as to make it feasible for their busy schedules. In order to obtain a balance of public schools and private school teachers in the sample, we created survey questions for public school teachers in San José. We created these surveys using WPI Qualtrics, using the same questions as the teacher interviews but adapted the questions to a survey format (see Appendix E). Árboles Mágicos distributed the teacher surveys through email to public school teachers to increase the chance of obtaining responses.

To gain information about effective teaching methods in a non-classroom setting, we interviewed a museum exhibit designer from a local museum in San José. This interview was conducted in-person at the Museo de los Niños, and used the same semi-structured technique as the teacher interviews. We also called ten U.S. children's museums to send surveys for a greater sample size of museum exhibit designers. These surveys were made in WPI Qualtrics and the link was emailed to each museum's Human Resources department who would forward the link to the museum exhibit designers. Interview questions for the museum exhibit designer from the Museo de los Niños can be found in Appendix D, and survey questions for museum exhibit designers can be found in Appendix E.

As interviews and surveys were completed, we began to code the results. First we used open coding, where we went through each interview and labeled important words and phrases. We organized these words and phrases into groups based on common themes, which is called axial coding (Saldana, 2008). Coding the responses from the interviews and surveys allowed us to see which major concepts were mentioned in all the interviews and how frequently they were mentioned.

We then brainstormed activities to use in the mobile nature workshop that incorporate the methods we found to be effective from the results of the coded interviews and surveys. We then visited the Museo de los Niños and observed which exhibits were similar to the ones we brainstormed. We analyzed the similar exhibits to determine which aspects were successful by observing how children interacted with the exhibits. The Museo de los Niños, along with other children's museums in the United States, observes how children interact with exhibits in order to validate the success of exhibits. We used these observations to alter aspects of the activities we

brainstormed, validate other aspects of the activities, and develop additional activities for the workshop.

### **3.3. Objective 3: Design the Mobile Workshop and Assess its Feasibility**

We presented Árboles Mágicos with multiple designs for the mobile nature workshop because funding was not available at the time this project was completed. Hence, in order to account for varying budgets, we designed two workshops of varying sizes that contain various activities and technologies inside. Árboles Mágicos would also have the ability to pick which activities to include inside the workshop based on the size of the vehicle and the space requirements we determined for each activity. We also designed two example layouts of the workshop with the activities we designed inside.

We estimated the space requirements for each activity using the space requirements for the similar activities used in the Museo de los Niños. We also created three-dimensional models of each activity to approximate the space requirements. We then designed two different model workshops of different sizes containing different activities. We created three-dimensional representations of each model in order to give Árboles Mágicos a visual representation of the mobile nature workshop. We found the dimensions of each vehicle using manufacturer websites. We presented each model workshop with an approximate price for Árboles Mágicos to determine which model they would like use.

To assess the materials necessary to create the activities, we analyzed the results of the interviews and surveys with the museum exhibit designers and brainstormed other materials we foresaw the mobile workshop requiring. We then put each material into a bill of materials, including a wide variety of models of large vehicles, such as box trucks. The bill of materials is a spreadsheet that states the product, the cost of the product, and where it can be purchased from (Found in Appendix H). We went to several online stores and compared prices for each item and place the average price into the bill of materials. Providing the average cost for materials was difficult, as prices fluctuate over time. Prices for materials could only be given as an approximate price range.

### **3.4. Summary**

All three objectives expand on each other in order to develop the overall workshop. As shown in Figure 7, the designs for the mobile nature workshop from Objective 3 are collections of the activities designed in Objective 2, as well as an overall vehicle design. The activities are centered around teaching the environmental topics determined in Objective 1. Finally, for these

topics to be impactful, they were aimed at encouraging the skills and values that can create an appreciation for trees and nature in the students of San José, Costa Rica.



Figure 7 - Pyramid representing how components of the project build off each other.

From the objectives we created a set of deliverables for Árboles Mágicos. The first deliverable, the content matrix, allowed Árboles Mágicos to see which values and behavioral changes each activity is intended to produce through environmental topics. The activity scripts showed Árboles Mágicos an example of how to create and run each activity in the workshop. The bill of materials allowed Árboles Mágicos to spatially arrange the activities in the workshop and choose a level of financial investment for the workshop. Finally, the three-dimensional models of the workshop gave Árboles Mágicos a visual representations of how the workshop can appear when construction is complete.

## 4. Results

Over the course of the project, we interviewed a preschool teacher, a biology teacher, and environmental education teacher, along with a local museum exhibit designer. Along with interviews, we received survey responses from three public school teachers, one survey response from a museum exhibit designer from the Children’s Museum of Indianapolis and three responses from museum exhibit designers from the Exploratorium in San Francisco. First, we present findings related to the educational content for the mobile workshop, followed by findings for effective teaching methods. Finally, we present findings related to the design and feasibility of the mobile nature workshop.

### 4.1. Educational Content in the Mobile Workshop

For Objective 1, we held a discussion with Giancarlo Pucci, the Director of Árboles Mágicos, where we discussed the educational goals of the project and researched content that can be used to accomplish these goals.

#### **4.1.1. Encouraging Empathy, Transversality, Sense of Community, Motivation to Make a Change, and Leadership Skills can create changes in the environmental behaviors of students.**

We found that the set of values and skills that can be encouraged to create a change in environmental behaviors and a culture of appreciation for the environment in students were:

- Empathy - Empathy is important so that children understand that trees are living organisms and that they need to be cared for and protected.
- Transversality - Transversality is the ability to relate personal experiences to that of a person or an object. Teaching transversality is important so that children realize how similar trees are to them and how forests are similar to their homes and communities. Teaching transversality can create a deeper connection with the natural environment in a similar way to empathy.
- Sense of community - Instilling a sense of community in students is important so that they understand how their choices affect other people around them. For example, if they choose to harm a tree, not only do the animals that live in the tree suffer, but any person that obtains fruits or shade from that tree suffers as well.
- Motivation to make a change - It is important to give children a motivation to make a change in their own life so that they change their behaviors according to the skills and values they learned. This change will likely promote environmentally appreciative behaviors.

- Leadership skills - Leadership skills are important so that once the children learn an appreciation for trees, they can lead their peers in adopting these skills and values as well.

The Literature Review shows that outdoor education can be an effective tool for teaching these skills and values, and in turn can encourage more pro-environmental behaviors (See Section 2.1.2). Therefore, it is feasible to accomplish the project goal of creating a culture of appreciation for the environment through teaching environmental topics. Accomplishing the goal is likely to inspire more pro-environmental behaviors.

#### **4.1.2. Using topics that reinforce the ones taught in the classroom strengthen the educational impact of the mobile workshop.**

This finding was supported by a response from a museum exhibit designer. The Children’s Museum of Indianapolis, which is the largest children’s museum in the United States of America, uses this approach when designing content for their exhibits. They look into the educational standards of nearby schools and expand on the topics students are taught in order to strengthen the educational impact.

The background research also supports the effectiveness of using exhibits as a supplementary educational tool. Section 2.2.1 of the Literature Review states that students’ learning experiences can be strengthened by reinforcing the same topics they learn in the classroom through interactive methods.

### **4.2. Effective Teaching Methods for the Mobile Workshop**

For Objective Two, we analyzed interviews and surveys with local teachers and museum exhibit designers. We then developed the following findings regarding teaching methods used in private and public schools, engaging students’ senses, and teaching tools for the mobile nature workshop.

#### **4.2.1. Teaching methods that engage all five senses can improve the overall experience of the lesson.**

The concept of using teaching methods that engage all five senses were strongly emphasized during all teacher and museum exhibit designer interviews. Jeff Norris, a teacher from the United World College, said:

“The [workshop] must be the perfect sensory tool” (J. Norris, January 25, 2017, Personal Interview).

Jeff, along with all teachers and museum exhibit designers, agreed that students learn the best when all of their senses were involved in learning about the environment. Cristina Briceño Lobo, the chief of the Department of Museography at the Museo de los Niños, uses technology to simulate an authentic nature feel in order to give children the experience of exploring forests. However, Jeff was the most passionate about this concept, explaining that the best way to teach about trees and nature is to take students to forests.

#### **4.2.2. Outdoor Education is not frequently used in Costa Rican environmental education, although many teachers find it important.**

Out of three Costa Rican public school teachers who replied to our survey, two stated that they do not have time to take their students outside. The third teacher stated that they only have between one and five hours a month to take students outdoors.<sup>3</sup> While 92 percent of students in Costa Rica attend public schools (Giménez & Aristizábal, 2017), the other 8 percent of students that attend private schools learn outside “a lot” (María Castro, February 1, 2017, Personal Interview). All three private school teachers we interviewed stated that students need outdoor education to properly learn about the environment. They felt that children need to have the ability to run around, explore their surroundings, and touch things.

#### **4.2.3. Student autonomy can be an effective teaching method as it allows students to learn according to their preferred learning style.**

All three private school teachers indicated through personal experiences that student-focused learning is a much more effective teaching method that also caters to students’ different learning styles. Jeff Norris explained that he allows students to drive classroom discussions so that they have more freedom over what they are able to learn.<sup>4</sup> He explained that this way of teaching made his students more passionate about learning since they were learning about topics that interested them and in the way that they preferred. Section 2.2 of the Literature Review shows that student autonomy allows students to teach themselves and learn things that are interesting to them, which supports what each teacher we received responses from believed.

#### **4.2.4. Students can learn better when teaching methods are adapted to their preferred learning style.**

---

<sup>3</sup> One limitation from this finding is that the three public school teachers who replied to the survey work at the same school so there was not much variance in the sample. Different public schools may have different overall opinions on the topic of outdoor education.

<sup>4</sup> A biology teacher at the United World College

All three of the private school teachers we interviewed stated that private school teachers pay close attention to what students would like to learn and how they learn best. More specifically, Karla Hidalgo said that she gauges what students enjoy and do not enjoy when learning.<sup>5</sup> She also varies activities to keep students interested. She believes that this form of teaching allows her to teach her students effectively and creates a more enjoyable learning atmosphere.

All three private school teacher interviews showed that students learn differently and independently of each other, and therefore it is imperative to engage different learning styles when teaching. The private school teachers we interviewed discussed the need to have multiple activities for each learning style. Having a variety of activities keeps students engaged in lessons and therefore gives students a more in-depth understanding of content. María Castro also expressed that each child enjoys different things, and therefore having many options is very important to the success of the project.<sup>6</sup>

The museum exhibit design experts from Children's Museum of Indianapolis and the Museo de los Niños also employ this strategy when managing new exhibits. The exhibit designer at the Children's Museum of Indianapolis stated that:

“We have a research and evaluation team who uses many different strategies, including tracking and observing visitors, exit surveys, etc. to collect data and determine whether we've met our stated goals in each exhibit” (Museum exhibit designer from the Children's Museum of Indianapolis, Survey, February 16, 2017).

The Children's Museum of Indianapolis uses this information to swap out less impactful exhibits with newer ones or to improve the exhibits that are not performing as well. Cristina Briceño Lobo from the Museo de los Niños stated that along with surveys, she observes how children behave around each exhibit to determine which exhibits need to be modified and which are positively received by the children.

#### **4.2.5. Visuals, animations, and hands-on activities can be effective teaching tools for learning.**

A common idea throughout all interviews, from all teachers and museum exhibit designers, was that incorporating stimulating activities was key to the success of the mobile nature workshop. Teachers use animations and visuals to teach students complex topics and make them easier and more fun to understand. Jeff Norris said that he uses a lesson sheet that contains diagrams in his classroom because they assist in teaching complex topics visually.<sup>7</sup> The museum exhibit designer of the Children's Museum of Indianapolis stated that successful

---

<sup>5</sup> An environmental teacher at the Costa Rican Language Academy

<sup>6</sup> A preschool teacher

<sup>7</sup> A biology teacher at the United World College



exhibits generally contain a combination of hands-on interactives and immersive environments. According to the Children’s Museum of Indianapolis, successful hands-on activities “promote conversations, questions, and participation and/or engagement for our visitors” (Museum exhibit designer from the Children’s Museum of Indianapolis, Survey, February 16, 2017).

The Literature Review has already discussed the benefits of hands-on learning for child development, which bolsters the findings from the interviews. The Literature Review showed that students learn better through verbal and physical experiences and that most environmental topics are taught through hands-on activities (see Section 2.2.1 of the Literature Review).

### **4.3. Design of the Mobile Workshop and its Feasibility**

We used interviews from teachers, museum exhibit design experts, and previous research to determine a feasible design for the mobile nature workshop. These interviews and research allowed us to determine the following findings:

#### **4.3.1. Technology can be vulnerable to the Costa Rican environment and rough play from children.**

Museums, including all three museums we obtained responses from, frequently use technology in their exhibits. However, in the interview with Maria Castro, she noted that the volcanic ash and humidity of the Costa Rican environment decreases the longevity of technology.<sup>8</sup> Additionally, the constant use by children can take a toll on the technology as well. The exhibit designer at the Children's Museum of Indianapolis stated in their interview,

“We go for the industrial-strength model touchscreen units, heavy-duty cabinets and casework for iPads, etc.” (Museum exhibit designer from the Children’s Museum of Indianapolis, Survey, February 16, 2017).

The Children's Museum of Indianapolis’ large investments in the safety of their technology shows an emphasis on protecting their technology. Multiple interviews emphasized the importance of protection for the technology in the workshop.

In addition, we found that it is beneficial to teach children the proper way to use technology. In the interview with María Castro, a preschool teacher who understands the destructive potential of children, she emphasized the importance of explaining the proper way to use each device and why it is important to respect technology. María was the only person we interviewed that had this suggestion, but she emphasized it strongly based on personal experience of teaching children with computers.

---

<sup>8</sup> A preschool teacher

The Boston City Lab (discussed in Section 2.3 of the Literature Review) used a similar concept. The CityLab had personnel on board who would explain lab procedures and how to properly use the equipment. This increased the chances of the students using the equipment properly and decreased the chance of incurring damages.

#### **4.4. Summary**

In this chapter we used the interviews, surveys and previous research to determine results. These findings guided us in the design of the mobile workshop and were used to create a list of recommendations to present to Árboles Mágicos in order to continue the development of the mobile nature workshop.

## 5. Recommendations

In this chapter we propose recommendations to Árboles Mágicos for the educational content for the model of the mobile nature workshop, potentially effective activities to use during the workshop, and suggestions for the design of the workshop. The recommendations are based on the findings from the research as well as interviews and surveys with teachers and museum exhibit designers. In each recommendation, we state possible limitations that may appear and describe steps to overcome them.

### 5.1. Recommendation for the Educational Content in the Mobile Workshop

#### 5.1.1. We recommend that Árboles Mágicos include the following educational topics in the mobile nature workshop:

- **The life cycle of trees**
- **The physical components of a tree**
- **The tree's effect on the ecosystem**
- **Different Species of trees**
- **The parts of a forest**
- **The symbol of a tree in cultures around the world**
- **Communication between trees**

We recommend this set of topics because they can be used to encourage all the skills and values we found that can create a culture of appreciation for trees and the environment (See Finding 4.1.1). Table 1 below illustrates how every skill and value is encouraged by at least one environmental topic that we recommend.

	Empathy	Transversality	Sense of Community	Motivation	Leadership
Life cycle		X			
Components of a tree	X	X			
Effect on the ecosystem	X	X	X	X	
Species of trees		X	X		
Parts of a forest		X			
Cultural Symbol of a Tree	X				
Communication between Trees	X		X	X	X

Table 1- Representation of how every skill and value is encouraged through the set of environmental topics.

However, there are many other environmental topics that can be used to reach the same educational goals. The reason we suggest these environmental topics in particular is because they expand on the topics taught in Costa Rican classrooms. Section 2.2.2 of the Literature Review showed that Costa Rican public schools teach the basic concepts of biology in regards to environmental education. The topics we have chosen to recommend are biology topics that go more in-depth into specific areas. Finding 4.1.2 supports the use of topics that reinforce the topics taught in the classroom and how they can strengthen the educational impact. Although sustainability and environmental responsibility are also frequently taught in Costa Rican schools, we do not recommend including these topics because *Árboles Mágicos* feels that they are too frequently taught through lectures and would rather encourage the behaviors through other environmental topics.

A limitation caused by using this set of topics is that if children visit the workshop multiple times, they may become bored with learning the same topics. A strategy to overcome this limitation is to swap in activities that teach different topics. This strategy is supported by Finding 4.2.4. The frequency the activities are swapped out would depend on how often the workshop revisits the same schools and locations.

## 5.2. Recommendations for the Design of the Mobile Workshop

### 5.2.1. We recommend that the mobile nature workshop include visuals, animations, and hands-on activities.

We recommend that the mobile nature workshop use activities that incorporate visuals, animations, and hands-on activities because students would be able to absorb the educational topics presented in the workshop easily. In Finding 4.2.5, we determined that these teaching methods are useful for presenting topics in a stimulating and simple manner. These teaching methods also allow us to blend the concepts of student autonomy, situational interest, and real-world connections with the educational content we determined from Finding 4.2.3 and create activities that captivate students' attention. Section 2.2.1 of the Literature Review shows that interactive exhibits that are executed correctly can remain on students' minds up to six months later.



Figure 8 - Example of hands-on activity from the Museo de los Niños

The activities we recommend for the mobile nature workshop that incorporate visuals, animations, or hands-on activities include (see Appendix G for more details):

- A video showing the story of a tree and the animals that live in it, shown on a projector
- An animation detailing the growth of a seed to an adult tree using an interactive touch screen
- Video games that contains multiple interactive games about forests, shown on iPads

- A scavenger hunt where students try to find animals hiding in a tree using informative cards
- A voice box that allows students to talk to one another across the vehicle through a tube
- A planting activity where students can plant seeds that they can take home and care for
- A role-playing activity where students dress up as plants and animals
- An activity that walks students through a mindfulness exercise inside of the vehicle

We designed the recommended activities using the teaching methods discussed. We then improved and validated each activity based on similar activities we observed at the Museo de los Niños. We examined similar exhibits and analyzed which aspects were successful by observing how children interacted with the exhibits. Also, none of the activities have blocks of text longer than 50 words, or paragraphs with more than 25-30 words. The Children’s Museum of Indianapolis uses this word limitation with all their exhibits. The short blocks of text hold the attention of children and lower the chance of them becoming bored or overwhelmed by information. We recommend a number of activities that ensure that every recommended environmental topic is taught through at least one activity, as demonstrated in Table 2.

	Forest Experience	Animation	Website	Scavenger Hunt	Voice Box	Video	Flowering Planting Activity	Role Playing Activity
Life Cycle		X						
Components of a Tree							X	
Effects on the Ecosystem				X		X		X
Species of a tree		X	X					
Parts of a Forest	X		X					
Cultural Symbol of a tree						X		
Communication between Trees					X			

Table 2 - Representation of how every recommended environmental topic is taught through the set of recommended activities.

### 5.2.2. We recommend that Árboles Mágicos invest in durable materials and protective coverings for all technologies inside the mobile nature workshop.

We recommend that Árboles Mágicos invest in protective casings for all projectors, touch screens and iPads to protect them from the Costa Rican environment, volcanic ash, and possible rough play from the students. The investment in durable protection for technologies can increase the longevity of all technologies in the workshop, and therefore save a lot of money that would be spent replacing expensive equipment. The recommendation is informed by Finding 4.3.1, which discussed how easily children can damage technology. This suggestion was also supported

by the interviews and surveys with the museum exhibit designers from the Children’s Museum of Indianapolis and the Museo de los Niños when they stated that they invest in protective coverings for all exhibits that use expensive technology. However, purchasing protective coverings will increase the cost of the workshop, so careful consideration is highly suggested.



Figure 9 - Industrial iPad case to preserve technology(Walmart, 2017)

### **5.2.3. We recommend that Árboles Mágicos include lights, smells, sounds and objects that students can touch in the mobile nature workshop.**

We recommend that the mobile workshop contain activities that engage students’ senses. From Finding 4.2.1, we found that engaging the senses is an effective method in improving student participation and understanding of educational content.

We recommend that the vehicle design have a projector mounted on the inside wall of the vehicle to show the underside of a Guanacaste tree on the top of the inside of the workshop. This projection would display the leaves and branches moving to simulate breezes through the leaves and animal movement through the branches, thus engaging students’ sense of sight. Students would also be able to view pictures and murals of nature along the walls. To engage students’ sense of sound, the model could have speakers mounted throughout the vehicle that would play forest sounds as students move through the workshop. These forest sounds would include birds chirping, the sounds of rustling leaves, and different animal calls. To stimulate the sense of smell, the design could also include small fragrance diffusers that contain the smells of different flowers and trees native to Costa Rica.

### **5.3. Recommendations for the use of the mobile nature workshop**

#### **5.3.1. We recommend that Árboles Mágicos measure the impact of the mobile nature workshop.**

In order to measure the impact of the mobile nature workshop, we recommend that Árboles Mágicos use surveys. This recommendation is based on Finding 4.2.4, where both The Children’s Museum of Indianapolis and the Museo de los Niños survey visitors to measure the impact of each exhibit. After students have experienced the workshop, a teacher, or personnel from Árboles Mágicos, can sit them down and ask the group of students the following questions:

1. What parts of the workshop did you enjoy the most?
2. What parts of the workshop did you not enjoy?
3. What did you learn today?
4. Would you like the mobile workshop to return?

A limitation to this method would be the student's’ ability to communicate their opinions. We recommend that the survey be similar to an open discussion so the students do not feel pressured by questions and feel free to express all opinions about the workshop. The fluid conversation style would make it easier for students to express their opinions accurately.

Finding 4.2.4 also supports the suggestion that the activities in the workshop not be set in stone, but instead be replaceable so that the workshop can adapt to children’s interests. Measuring the impact of the workshop and its adaptability as an environmental teaching tool can potentially create stronger behavioral changes in the target audience in the future. We suggest that the results of the assessments be used to modify the workshop.

#### **5.3.2. We recommend that Árboles Mágicos use a guide to educate students about how to use the technology and be present inside of the mobile nature workshop.**

We suggest that Árboles Mágicos use a guide to instruct students on how to use the equipment properly and set the ground rules of the workshop. Finding 4.3.1 supports that having an adult’s presence in the workshop to monitor the use of technology can limit the damage to technology. The guide would have an understanding of all activities and technologies inside the workshop and how to use them properly. We also recommend that a list of specific rules be presented to the students by the guide so they understand the limits on how they can use each activity and piece of technology. Teaching these rules to the students beforehand can increase safety of both the students and the technology. However, the guide should not specifically instruct the students how to complete activities so that the students can still learn autonomously.



One limitation for this recommendation is finding a person to donate a large part of their free time to work in the mobile workshop. This person can be an employee of Árboles Mágicos, because they would already understand the workshop and also be very interested in protecting Árboles Mágicos' investment. Alternatively, we recommend that Árboles Mágicos use their connections from organizing previous volunteer events to find a volunteer as this would lower the cost of operating the workshop.

### **5.3.3. We recommend that Árboles Mágicos begin by working with private schools.**

We recommend that Árboles Mágicos work with private schools in the early stages of the mobile nature workshop. Finding 4.2.2 supports that it may be difficult for Árboles Mágicos to reach public school students due to the strict curriculum and schedule that teachers must follow. Private schools are likely to be more able to incorporate the mobile nature workshop into their schedules, and Árboles Mágicos could show the effectiveness of the workshop to the Ministerio de Educación Pública and public school teachers by using it with private schools first.

To gain the attention of public school teachers, we recommend that Árboles Mágicos invite a few public school teachers to observe the mobile workshop in action when the workshop visits private schools. Public school teachers can observe the workshop in action and form opinions about how effective the mobile workshop can be. Teachers would then be able to write up formal evaluations about their experience with the workshop and observing the children's excitement and participation. When other public school teachers read the evaluations, the workshop may be able to be implemented into the busy schedule of public schools.

### **5.3.4. We recommend that Árboles Mágicos invest in a smaller version of the mobile nature workshop first to eventually expand to a larger vehicle.**

We recommend that Árboles Mágicos first invest in a less expensive version of the mobile workshop to show that the design works and use the smaller version to increase funding. The smaller version could also give an opportunity to gain the attention of public schools. With this in mind, we developed two different three-dimensional models for Árboles Mágicos: one smaller model that contains fewer activities, and a larger, potentially more impactful version. In order to accomplish this, we recommend the following tasks:

1. Construct the smaller version of the mobile nature workshop with available funding.
2. Present the results of the mobile nature workshop by using the workshop with schools and collecting teacher reviews.
3. Use the teacher reviews to improve the small model and to gain more funding.
4. Use extra funds to invest in the larger model of the workshop.

### **5.3.5. We recommend that the mobile nature workshop comply with handicap accessibility laws.**

We recommend that all models for the vehicle that contains the mobile nature workshop have at least one ramp that is approved for wheelchair-accessibility to abide by Ley 7600. Ley 7600 requires all spaces be accessible for people with disabilities (see Appendix K). We also recommend that the two models for the vehicle must allow a minimum of 1.52 meters throughout the interior of the workshop, as to accommodate wheelchair movement within the vehicle. For visually-impaired students, we recommend that all written words be accompanied by braille. We recommend that sign language be included in all visual presentations for students that are hearing-impaired.

## **5.4. Discussion of the Design for the Mobile Nature Workshop**

In this section, we discuss recommended designs of the mobile nature workshop. We recommended that Árboles Mágicos begin with a smaller version of the mobile nature workshop. Therefore, we present two designs for the mobile nature workshop, one smaller and less expensive model and one larger model with more space and activities.

For the smaller version, the workshop would be located inside of a box truck that measures 2.3 meters high, 2.3 meters wide and 5 meters long (see Appendix I). Due to the size of this vehicle, all eight of the recommended activities are not able to fit in the vehicle. Árboles Mágicos can use the spatial requirements of each activity listed in the activity scripts (found in Appendix G) and the approximate cost of each activity from the bill of materials (found in Appendix H) to decide which activities to include in the smaller version of the mobile nature workshop. An example layout of the smaller design that we recommend includes the scavenger hunt, role playing, planting, video, and mindfulness activities. The set of activities chosen for the small version of the model fill the entire vehicle and do not include the most expensive activities. The voice box activity is also not included because it requires a longer vehicle for proper implementation. The approximate price of the box truck for this design is 5.600.000 colones, and the approximate price for the activities listed can range from 205.000 to 780.000 colones. The total approximate range for the smaller version of the mobile nature workshop is 5.805.000 to 6.380.000 colones.



Figure 10 - Visual representation of smaller version of the mobile nature workshop

For the second design of the mobile nature workshop, we recommend using a box truck that measures 2.3 meters high, 2.3 meters wide, and 8 meters long (see Appendix J). With more space in the larger model, the vehicle can hold all eight recommended activities. The approximate price of the vehicle for this design is 7.000.000 colones, and the approximate price range for the all recommended activities is between 14.952.000 to 28.232.000 colones with approximately 14.004.500 colones necessary for the video game activity. For this version of the mobile nature workshop, the total price ranges from approximately 14.952.000 to 28.232.000 colones.

## 6. Conclusions

A mobile nature workshop that can give the experience of exploring the natural environment has the potential to greatly benefit the children in San José, Costa Rica. The workshop intends to give students the opportunity to connect with their natural environment. Studies have shown that children enjoy environmental exploration, and a mobile nature workshop could bring the experience of environmental exploration to children living inside the city. The developmental benefits from allowing children to explore the environment will remain with them long after the mobile workshop has gone.

Teachers can also benefit from the mobile workshop as well. The design of the mobile nature workshop can give teachers in San José the ability to use outdoor teaching in their classrooms. Outdoor education increases cognitive abilities, interpersonal skills, and problem solving skills, which make for better students overall. The mobile nature workshop can also give teachers a chance to vary their teaching styles, which can make learning less boring for students.

A unique aspect of the mobile nature workshop designs is that, when implemented, they could teach skills and values that encourage pro-environmental behaviors, such as empathy, transversality, and leadership. The workshop also has the potential to be used to encourage pro-environmental behaviors in the general population. Encouraging pro-environmental behavior can inspire change and increase overall environmental awareness in the general population.

## 7. References

- Allen, J., & Ferrand, J. (1999). Environmental locus of control, sympathy, and pro-environmental behavior. *Environment and Behavior*, 31(3), 338-353.  
doi:10.1177/00139169921972137
- An, K., Akiyama, T., Kim, J., Hoshiko, T., & Furumai, H. (2011). The influence of field-oriented environmental education on leadership development. *Procedia - Social and Behavioral Sciences*, 15, 1271-1275. doi:10.1016/j.sbspro.2011.03.275
- Basile, C., & White, C. (2000). Respecting living things: Environmental literacy for young children. *Early Childhood Education Journal*, 28(1), 57-61. doi:1009551705001
- Berenguer, J. (2007). The effect of empathy in pro-environmental attitudes and behaviors. *Environment & Behavior*, 39(2), 269-283. doi:10.1177/0013916506292937
- Beyer, K. M. M., Heller, E. F., Bizub, J. M., Kistner, A. J., Szabo, A., Shawgo, E. E., & Zetts, C. J. (2015a). More than a pretty place: Assessing the impact of environmental education on children's knowledge and attitudes about outdoor play in nature. *International Journal of Environmental Research and Public Health*, 12(2), 2054-2070.  
doi:10.3390/ijerph120202054
- Beyer, K. M. M., Kaltenbach, A., Szabo, A., Bogar, S., Nieto, F. J., & Malecki, K. M. (2014). Exposure to neighborhood green space and mental health: Evidence from the survey of the health of Wisconsin. *International Journal of Environmental Research and Public Health*, 11(3), 3453-3472. doi:10.3390/ijerph110303453
- Blanck, H. M., Allen, D., Bashir, Z., Gordon, N., Goodman, A., Merriam, D., & Rutt, C. (2012). Let's go to the park today: The role of parks in obesity prevention and improving the public's health. *Childhood Obesity*, 8(5), 423-428. doi:10.1089/chi.2012.0085.blan
- Blum, N. (2008a). Environmental education in Costa Rica: Building a framework for sustainable development? *International Journal of Educational Development*, 28(3), 348-358.  
doi:10.1016/j.ijedudev.2007.05.008
- Brook, B. W., Sodhi, N. S., & Ng, P. K. L. (2003). Catastrophic extinctions follow deforestation in Singapore. *Nature*, 424, 420+.
- Çalışkan, O. (2011). Virtual field trips in education of earth and environmental sciences. *Procedia - Social and Behavioral Sciences*, 15, 3239-3243.  
doi://dx.doi.org/10.1016/j.sbspro.2011.04.278
- Calvo-Cruz, X. M. (2013). La educación ambiental de la niñez costarricense en la edad escolar: Responsabilidad compartida por el currículo oficial del ministerio de educación pública y el hogar. *Biocenosis*, 27(0) Retrieved from  
<http://investiga.uned.ac.cr/revistas/index.php/biocenosis/article/view/591>

- Card, B. E. C. (2014). *Forest kindergarten: A qualitative case study comparing the emergent and play-based curriculum at Cedarsong nature school to the Newfoundland and Labrador kindergarten curriculum*. Retrieved from <http://research.library.mun.ca/8324/>
- Cedarsong nature school. (2016). Retrieved from <http://cedarsongnatureschool.org/>
- CEE's prakriti environment education bus: Green awareness on-the-move. (). Retrieved from <http://www.ecoideaz.com/expert-corner/cee-prakriti-environment-education-bus>
- Chapman, P. *Environmental education and sustainability in U.S. public schools*. Surry Hills: s.n.
- Cheng, J. C. (2008). *Children, teachers and nature: An analysis of an environmental education program*. Retrieved from <http://search.proquest.com/docview/304657710>
- Cheryl, C., & Louv, R. (2009). Children's nature deficit: What we know – and don't know. *Children & Nature Network*. Retrieved from <https://www.childrenandnature.org/wp-content/uploads/2015/04/CNNEvidenceoftheDeficit.pdf>
- The CIA world factbook. (2017). Retrieved from <https://www.cia.gov/library/publications/the-world-factbook/geos/cs.html>
- Deininger, K. W., & Minten, B. (1999). Poverty, policies, and deforestation: The case of Mexico. *Economic Development and Cultural Change*, 47(2), 313-344. doi:10.1086/452403
- Educational module - magic trees. (). Retrieved from <http://arbolesmagicos.org/modulo-educativo/>
- Effects of outdoor education programs for children in California. (2013). Retrieved from <http://www.air.org/resource/effects-outdoor-education-programs-children-california>
- Ehrhardt-Martinez, K. (1998). Social determinants of deforestation in developing countries: A cross-national study. *Social Forces*, 77(2), 567-586. doi:10.2307/3005539
- ELP 2013 report. (2014). Retrieved from <https://naaee.org/eepr/resources/elp-2013-report>
- Fedewa, A. L., & Ahn, S. (2011). The effects of physical activity and physical fitness on children's achievement and cognitive outcomes. *Research Quarterly for Exercise and Sport*, 82(3), 521-535. doi:10.1080/02701367.2011.10599785
- Fernández A, A., & Del Valle A, R. (2013). Inequality in education in Costa Rica: The gap between students in public and private schools. *CEPAL Review*, (111), 37-56. Retrieved from <http://www.econis.eu/PPNSET?PPN=819533254>
- Fiebelkorn, F., & Menzel, S. (2013). Student teachers' understanding of the terminology, distribution, and loss of biodiversity: Perspectives from a biodiversity hotspot and an industrialized country. *Research in Science Education*, 43(4), 1593-1615. doi:10.1007/s11165-012-9323-0
- Fisher, R. (2013). *Impact of early-exposure environmental education on a child's selection of words and creativity* Available from Dissertations & Theses @ University of Tennessee - Chattanooga. Retrieved from <http://search.proquest.com/docview/1437014718>
- Fjortoft, I. (2001). The natural environment as a playground for children: The impact of outdoor play activities in pre-primary school children. *Early Childhood Education Journal*, 29(2), 111-17.

- Fjørtoft, I. (2004). Landscape as playscape: The effects of natural environments on children's play and motor development. *Children, Youth and Environments*, 14(2), 21-44. Retrieved from <http://www.jstor.org/stable/10.7721/chilyoutenvi.14.2.0021>
- Galliford, M. Touring 'country', sharing 'home': Aboriginal tourism, Australian tourists and the possibilities for cultural transversality.
- Girmus, R. L. (2012). *How to motivate your students* Retrieved from <http://eric.ed.gov/?q=How+to+Motivate&id=ED534566>
- Gouda, S., Luong, M. T., Schmidt, S., & Bauer, J. (2016). Students and teachers benefit from mindfulness-based stress reduction in a school-embedded pilot study. *Frontiers in Psychology*, 7 doi:10.3389/fpsyg.2016.00590
- Giménez, G & Aristizábal, G. C. (2017). Why students of public and private schools in Costa Rica obtain different academic achievement? *Perfiles Latinoamericanos*, 25(49), 195-222. doi:10.18504/pl2549-009-2017
- Gura, M. (2012). Lego robotics: STEM sport of the mind. *Learning & Leading with Technology*, 40(1), 12-16. Retrieved from <http://eric.ed.gov/?q=LEGO+robotics&id=EJ991224>
- Hirabayashi, S., & Nowak, D. J. (2016). Comprehensive national database of tree effects on air quality and human health in the United States. *Environmental Pollution*, 215, 48-57. doi:10.1016/j.envpol.2016.04.068
- Holl, K. D., Daily, G. C., & Ehrlich, P. R. (1995). Knowledge and perceptions in Costa Rica regarding environment, population, and biodiversity issues. *Conservation Biology*, 9(6), 1548-1558. Retrieved from <http://www.jstor.org/stable/2387198>
- Holmgren, S. (2015). *Governing forests in a changing climate*. Uppsala: Department of Forest Products Swedish University of Agricultural Sciences Uppsala. Retrieved from <http://libris.kb.se/resource/bib/17944743>
- Home. (2016). Retrieved from <http://www.forestschoolmn.org/>
- Horn, M. S., Phillips, B. C., Evans, E. M., Block, F., Diamond, J., & Shen, C. (2016). Visualizing biological data in museums: Visitor learning with an interactive tree of life exhibit. *Journal of Research in Science Teaching*, 53(6), 895-918. doi:10.1002/tea.21318
- J. Woo, N. Tang, E. Suen, J. Leung, M. Wong. (2009). Green space, psychological restoration, and telomere length. *Lancet*, 373, 299-300.
- Janzen, D. H. (2010). Hope for tropical biodiversity through true bioliteracy. *Biotropica*, 42(5), 540-542. Retrieved from <http://www.jstor.org/stable/40863780>
- Jia-nan, C. (2012). Contributions of environmental NGO to environmental education in china. *IERI Procedia*, 2, 901-906. doi:10.1016/j.ieri.2012.06.189
- Jiménez, A., Monroe, M. C., Zamora, N., & Benayas, J. (2015). Trends in environmental education for biodiversity conservation in Costa Rica. *ResearchGate*, doi:10.1007/s10668-015-9734-y
- Jung, H. Y. (2009a). Transversality and the philosophical politics of multiculturalism in the age of globalization. *Research in Phenomenology*, 39(3), 416-437. Retrieved from <http://www.jstor.org.ezproxy.wpi.edu/stable/24660238>

- Jung, H. Y. (2009b). Transversality and the philosophical politics of multiculturalism in the age of globalization. *Research in Phenomenology*, 39(3), 416-437. Retrieved from <http://www.jstor.org.ezproxy.wpi.edu/stable/24660238>
- Kollmuss, A., & Agyeman, J. (2002). Mind the gap: Why do people act environmentally and what are the barriers to pro-environmental behavior? *Environmental Education Research*, 8(3), 239-260. doi:10.1080/13504620220145401
- L, R. (1981). Empiric verification of a model of leadership efficiency. [empiric verification of a model of leadership efficiency.]. *Novye Issledovaniya V Psikhologii*, 2(25), 89-94.
- Lauber, T. B., & Tidball, K. (2014). Characterizing healthy urban systems: Implications for urban environmental education. *Cities and the Environment (CATE)*, 7(2) Retrieved from <http://digitalcommons.lmu.edu/cate/vol7/iss2/2>
- Lee, S. (2001). Transversal-universals in discourse ethics: Towards a reconcilable ethics between universalism and communitarianism. *Human Studies*, 24(1/2), 45-56. Retrieved from <http://www.jstor.org.ezproxy.wpi.edu/stable/20011302>
- Legault, L., & Pelletier, L. G. (2000a). Impact of an environmental education program on students' and parents' attitudes, motivation, and behaviours. *Canadian Journal of Behavioural Science*, 30(4), 243-250.
- Legault, L., & Pelletier, L. G. (2000b). Impact of an environmental education program on students' and parents' attitudes, motivation, and behaviours. *Canadian Journal of Behavioural Science / Revue Canadienne Des Sciences Du Comportement*, 32(4), 243. doi:10.1037/h0087121
- Leo McAvoy, Professor University of Minnesota, Minneapolis, & MN. *Stuart J. schleien, Ph.D., CTRS*
- Louv, R. (2005). *Last child in the woods: Saving our children from nature-deficit disorder* (1st ed.). Chapel Hill, NC: Algonquin Books of Chapel Hill.
- Mahat, H., Yusri, M. S., & Ngah, C. (2016). 3R practices among more preschool pupils through the environmental education curriculum. *SHS Web of Conferences*, 23, 04002. doi:10.1051/shsconf/20162304002
- McClafferty, T., & Rennie, L. J. *Using visits to interactive science and technology centers, museums, aquaria, and zoos to promote learning in science* author(s): Leonie J. Rennie and Terence McClafferty source: *Journal of science teacher education*, vol. 6, no. 4 (fall 1995), pp. 175-185 published by: Springer stable URL: [Http://Www.jstor.org/stable/43156044](http://www.jstor.org/stable/43156044) accessed: 02-12-2016 17:09 UTC
- Moseley, C. (2000). Teaching for environmental literacy. *The Clearing House*, 74(1), 23-24. Retrieved from <http://www.jstor.org/stable/30189626>
- Natural England | environment. Retrieved from <http://www.theguardian.com/environment/natural-england>
- Newman, B. (2010, -02-02T20:19:05+00:00). In the 'Urban forest' of San José there are many street trees, many problems. Retrieved from <http://www.mercurynews.com/2010/02/02/in-the-urban-forest-of-san-jose-there-are-many-street-trees-many-problems/>



- Outdoor mindfulness exercises for earth day. (2015). *Edutopia Blog*, Retrieved from <http://wpi.aci.info/view/14b5518550f0012000b/14cdf716f850001null>
- Reynolds, B., & Fitzpatrick, J. (1999). The transversality of Michel de Certeau: Foucault's panoptic discourse and the cartographic impulse. *Diacritics*, 29(3), 63-80. Retrieved from <http://www.jstor.org.ezproxy.wpi.edu/stable/1566237>
- Rhett Butler. (2015). Rainforest loss increased in the 2000s, concludes new analysis. Retrieved from <http://scholar.aci.info/view/1490fc15d2033a00195/14bc25ca86f000e0066>
- Richard Osbaldiston, & John Paul Schott. *Behavioral science: Http://Eab.sagepub.com meta-analysis of pro-environmental behavior experiments* doi:10.1177/0013916511402673
- Rosero-Bixby, L., & Palloni, A. (1998). Population and deforestation in Costa Rica. *Population and Environment*, 20(2), 149-185. Retrieved from <http://www.jstor.org/stable/27503631>
- Saracho, O. N., & Spodek, B. (2006). Young children's literacy-related play. *Early Child Development and Care*, 176(7), 707-721. doi:10.1080/03004430500207021
- Schelhas, J., & J, M. (2005). Forest values of national park neighbors in Costa Rica. *Human Organization*, Vol. 64(4): 385-397, Retrieved from <http://www.srs.fs.usda.gov/pubs/25016>
- Shafer, L. (2015). Teaching the environment. Retrieved from <https://www.gse.harvard.edu/news/uk/15/12/teaching-environment>
- Solano, A. Caminata con sendero urbano invita a conocer curiosidades de los árboles. Retrieved from [http://www.nacion.com/vivir/patrimonio/Caminata-conocer-historia-arboles-capitalinos\\_0\\_1541845805.html](http://www.nacion.com/vivir/patrimonio/Caminata-conocer-historia-arboles-capitalinos_0_1541845805.html)
- State environmental literacy plans. (2015). Retrieved from <https://naaee.org/our-work/programs/state-environmental-literacy-plans>
- Steg, L., & Vlek, C. (2009). Encouraging pro-environmental behaviour: An integrative review and research agenda. *Journal of Environmental Psychology*, 29(3), 309-317. doi:10.1016/j.jenvp.2008.10.004 Submitted by: *Effects of outdoor education programs for children in California*
- Teach environmental education in Costa Rica | green life volunteers. (). Retrieved from <http://www.glvolunteers.com/projects/environmental-education/>
- Tekin, A. K. (2016). Autonomous motivation of Omani early childhood pre-service teachers for teaching. *Early Child Development and Care*, 186(7), 1096-1109. doi:10.1080/03004430.2015.1076401
- The Environmental Performance Index, ranks countries performance on, & high-priority environmental issues. *Global metrics for the environment there is a new level of awareness of the global importance of forests and sustainable forest management. Credit: Rowland Williams*
- Torrence, P. F. (2012). Owed to nature: Medicines from tropical forests. Retrieved from <https://www.rainforesttrust.org/news/owed-to-nature-medicines-from-tropical-forests/>
- Troubling statistics: Nearly a quarter of Costa Ricans live in poverty -. (2014). Retrieved from <http://www.ticotimes.net/2014/10/30/nearly-a-quarter-of-costa-ricans-live-in-poverty>

- Turgunbaeva, B. A. (2016). The structural and conceptual model of development of leadership in junior school children. *International Journal of Environmental and Science Education*, 11(9), 2467-2479. Retrieved from <https://eric.ed.gov/?q=Leadership&id=EJ1114588>
- TURNER, W. R., NAKAMURA, T., & DINETTI, M. (2004). Global urbanization and the separation of humans from nature. *BioScience*, 54(6), 585-590. Retrieved from [http://www.jstor.org/stable/10.1641/0006-3568\(2004\)054\[0585:guatso\]2.0.co;2](http://www.jstor.org/stable/10.1641/0006-3568(2004)054[0585:guatso]2.0.co;2)
- US EPA, O. A. What is environmental education? Retrieved from <https://www.epa.gov/education/what-environmental-education>
- van Huyssteen, J. W. (2006). When our bodies do the thinking, theology and science converge. *American Journal of Theology & Philosophy*, 27(2/3), 127-153. Retrieved from <http://www.jstor.org.ezproxy.wpi.edu/stable/27944375>
- Willis, K. G., Garrod, G., Scarpo, R., Powe, N., Lovett, A., Bateman, I. J., Douglas, C. *The social and environmental benefits*
- Wolch, J. R., Byrne, J., & Newell, J. P. (2014). Urban green space, public health, and environmental justice: The challenge of making cities 'just green enough'. *Landscape and Urban Planning*, 125, 234-244. doi:10.1016/j.landurbplan.2014.01.017
- Yeap, E. E. L., Mokhtar, R., Muslimen, M. A., & Ghazali, F. (2016). Outdoor-based education camp: An essential tool to promote leadership skills. *International Journal of Information and Education Technology*, 6(5), 356; 356.

# 8. Appendix

## Appendix A: Gantt Chart

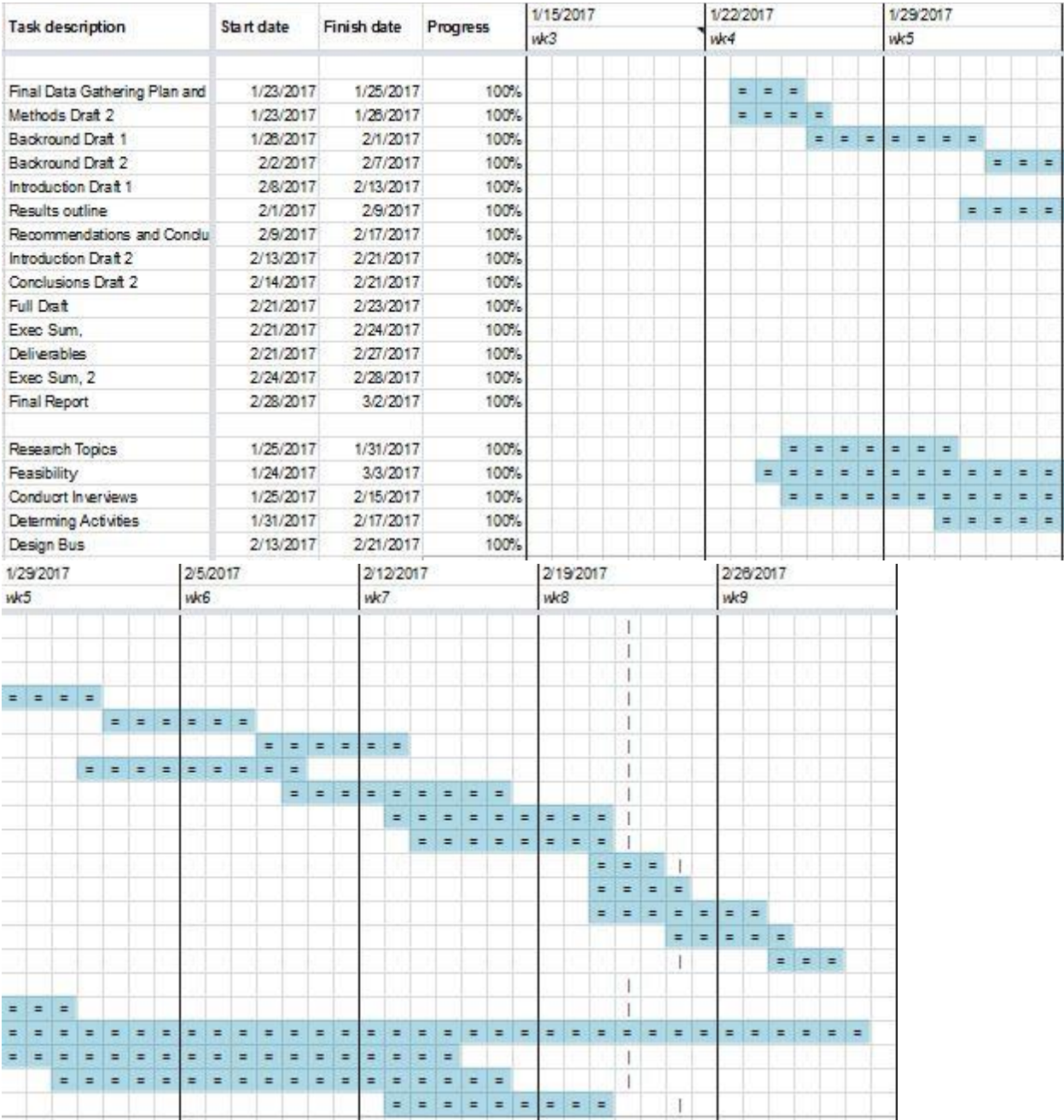

## Appendix B: Backlog

Week 1	Week 2	Week 3
Review Content	Research Topics	Mission Statement
Interview Questions	Begin Feasibility	Brainstorm Methods
Review Methods	Conduct Interviews	Conduct Interview
Meet IBMs	Meet IBMs	Meet IBMs
		Student Interview
		Diana

Week 4	Week 5
Determine How for activities	Refine Scripts
Find more people to interview	Interview Museum
Finish Coding	3-D model
Begin 3-D Design	Storyboard
	Feasibility
	Poster

## Appendix C: Content Matrix

Topic	Tree Cycle
Description	The life of a tree and how it grows, from a seed to a fully grown tree. Can be likened to a child growing to adulthood to create empathy and transversality with the tree.
Research	<p>For the life cycle to run full circle, external and internal conditions must be favorable for the tree. There must be sufficient space, water, nutrients and sunlight for a successful cycle. Stresses on the cycle include insects, disease, injuries, competition, weather and time.</p> <p>The seed is created by both the male and female part of the tree. They are transported around the world by wind, water, animals and humans.</p> <p>Only though favorable environmental conditions will a seed germinate and become a sprout. A sprout is when the roots from the seed begin to grow downward and the flower breaks through the seed's coating toward the sun. This is also the beginning of photosynthesis.</p> <p>The sprout continues to grow and obtains more wood-like characteristics. More leaves grow and green stems begin to harden and change color. At this time the tree is most likely to be killed and very likely to catch fire or be eaten. Roots are seen at the top part of the soil in order to receive oxygen.</p> <p>A sapling is considered a small tree in its juvenile state and is not yet ready to reproduce (4.5 ft). A lot of growing in this time and potential competition threats for resources.</p> <p>Once the sapling is fully grown to its full size it is the prime time to harvest the tree for its resources, and the time when reproduction can occur and fruits will form.</p> <p>If the tree is not harvested it will begin to decline. External stresses begin to take a toll on the old tree and it begins to lose to other competing trees.</p> <p>This however is not the end of the tree of the tree's cycle. Decomposition of the tree begins and turns the tree into nutrients for other tree to grow in its place beginning a new cycle.</p>
Metaphor (transversality)	<p>A tree is like a human, growing from a child to an adult</p> <p>Seed-Baby</p> <p>Sprout-Child</p> <p>Sapling-Teen</p> <p>Mature Tree-Adult</p>
Resources	<p><a href="https://www.plt.org/family-activity/tree-lifecycle/">https://www.plt.org/family-activity/tree-lifecycle/</a></p> <p><a href="http://texastreeid.tamu.edu/content/howTreesGrow/">http://texastreeid.tamu.edu/content/howTreesGrow/</a></p>
Objectives / Takeaways	<p>-Transversality</p> <p>-Basic Tree Knowledge</p>

Topic	Parts of a Tree
Description	Parts of a tree and how each part helps the tree survive. We will go in depth on each part and explain what it does for the tree, and how it is similar to a human process.
Research	<p>Roots- A large tree may have over 30 miles of roots, with about 5-million root tips. One part of the roots ("Root Hairs") absorb water and nutrients from soil, and are helped by colonies of beneficial fungi. "Absorbing roots" connect to "Conduction roots" that bring water and minerals back to the trunk. Roots also are very important in supporting the tree. 90% of roots are located in the top 1-2 feet of soil.</p>

	<p>Bark- Resembles human skin a lot. The outer bark, what we can see, is a layer of dead bark cells that have cracked from the expansion of the tree. Below the outer bark there is the inner bark, or phloem. The phloem is a layer of living bark cells and tubular cells that transport sugar and growth regulators dissolved in water. Bark is a tree's first line of defense against insects, humans, and temperature changes.</p> <p>Trunk- Gives tree shape and strength, transports water and minerals from roots to crown. Trees also use their trunk to store starches and other materials. There is a layer between the bark and the wood of the tree called the vascular cambium zone that lays new wood over old wood on one side and new inner bark cells on the other side beneath older bark cells. This layer allows the trees to cover minor wounds and to cut off entire columns of infected wood.</p> <p>Seeds- Seeds have a tough outer coat called a teste that protects the seed from fungi, bacteria and insects. Seeds leave a tree in a very dry, dormant state, where the chemical processes of living in the seed are very slow. During this dormant state they actually consume oxygen and release CO<sub>2</sub>, just very slowly and in small amounts. To begin to grow, a seed needs access to water, oxygen, and enough warmth. It will then soften so that the sprout can break through the hard outer shell and begin to grow.</p> <p>Leaves- Sheets of spongy living cells used to absorb sunlight. Leaves are connected to the air around them by small openings called stomatas. They have a waxy layer to keep water inside to avoid dehydration. Leaves often have hairs, bristles, scales, and other adaptations for the environment they are in</p> <p>Crown- The crown is the top portion of the tree consisting of leaves and branches. They filter the air, creates shade, Facilitate photosynthesis</p>
Metaphor (transversality)	Relate to parts of the body
Resources	<a href="https://www.ncforestry.org/teachers/parts-of-a-tree/">https://www.ncforestry.org/teachers/parts-of-a-tree/</a> <a href="http://www.kidzone.ws/plants/trees.htm">http://www.kidzone.ws/plants/trees.htm</a> <a href="https://www.for.gov.bc.ca/hfd/library/documents/treebook/parts.htm">https://www.for.gov.bc.ca/hfd/library/documents/treebook/parts.htm</a> <a href="http://www.sactree.com/assets/files/greenprint/toolkit/c/huntsvilleTreeGuide.pdf">http://www.sactree.com/assets/files/greenprint/toolkit/c/huntsvilleTreeGuide.pdf</a> <a href="http://www.biology-resources.com/plants-seeds-01.html">http://www.biology-resources.com/plants-seeds-01.html</a>
Objectives / Takeaways	<ul style="list-style-type: none"> <li>-Empathy</li> <li>-Transversality - the ability to relate tree growth to human growth and development</li> </ul>
Topic	Trees effect on ecosystem
Description	<p>How flowering trees help all life in a forest</p> <p>How an individual tree is also an ecosystem in itself</p> <p>Root systems and how trees communicate with each other</p>
Research	<p>In general: Trees are able to provide shelter to animals, use animals to facilitate pollination/germination, absorb carbon dioxide, prevent soil erosion, some trees fix nitrogen in soil in order to make it easier for other vegetation to be able to grow</p> <p>In Costa Rica: Example: Angel's trumpet trees produce flowers that open at night to use bats for pollination ---&gt; Mutual symbiotic relationship: Tree uses bat for pollination of flowers and bat gets food in return</p>
Metaphor (transversality)	A tree is like a house, because it houses so many animals, other plants
Resources	<a href="http://www.ducksters.com/science/ecosystems/oxygen_cycle.php">http://www.ducksters.com/science/ecosystems/oxygen_cycle.php</a> <a href="http://www.savatree.com/whytrees.html">http://www.savatree.com/whytrees.html</a> <a href="http://www.vivacostarica.com/costa-rica-information/costa-rica-flora.html">http://www.vivacostarica.com/costa-rica-information/costa-rica-flora.html</a>
Objectives / Takeaways	<ul style="list-style-type: none"> <li>-Real World Impact</li> <li>-empathy</li> <li>-transversality</li> <li>-motivation</li> </ul>
Topic	Species of trees

Description	-Different Trees in Costa Rica -The Country's National Tree (Guanacaste Tree)
Research	-Using color of tree leaves and specific tree characteristics to differentiate between species Guanacaste Tree- This is the national tree of Costa Rica. It grows to an enormous size, around 2.5 meters in diameter. This tree has a large crown, which creates a large area of protective shade beneath it, similar to how the government protects its people which is why it is the national tree of Costa Rica. It also has strange ear shaped seed pods. Almendra Tree- These are popular shade and ornamental trees. They can reach up to 40 meters. They produce showy flowers at the end of the tree's branches after the onset of rainy season, so that within a month or two the forest canopy is speckled with purple crowns. The tree fruits between December and April, which alleviates the prolonged fruit shortage. Because of this, when the tree fruits, many birds flock to it, and ground animals converge below it to enjoy its fruits. Tamarindo Tree- This is a large tree that has leaves that come with 10 to 18 pairs of leaflets. It grows large brown fruits that are made into a popular local drink. It can grow in both dry and humid climates. Higuerón Tree- This is another tree with a large green crown, which looks very similar to the Guanacaste tree. In fact, it is often mistaken for the national tree. The natural cracks and holes in striking trunk of the tree provide shelter and homes to many different creatures. Manzana Rosa Tree- This tree has fruits with a good taste and aroma. It can grow in almost any soil. Its roots and its leaves can be used as a medicine. *Higuerón tree is very similar to Guanacaste tree*
Metaphor (transversality)	Trees are like humans, there are many different kinds that are all good at doing different things
Resources	<a href="http://landsinlove.com/blog/trees-of-costa-rica/">http://landsinlove.com/blog/trees-of-costa-rica/</a> <a href="https://www.britannica.com/plant/almendra">https://www.britannica.com/plant/almendra</a>
Objectives / Takeaways	-Being able to determine the national tree -encourage excitement for variety of trees -transversality
Topic	Parts of a forest
Description	Determine different parts of forests and functions of each part
Research	Rainforest: Emergent layer - contains the tallest trees (broad leaved, hardwood evergreens) most amount of sunlight, Animals include eagles, monkeys, bats, butterflies, etc. Canopy Layer: Primary layer of the forest; trees have smooth oval leaves; food is abundant and animals include snakes, frogs, tropical birds Understory: Little sunshine reaches this layer --> plants must grow larger leaves to get adequate sunlight; Animals include large cats, frogs, insects Forest Floor: Dark; very few plants grow here; Animals include giant anteaters and scavengers  Cloud Forest: Dryer and cooler than rainforests; Trees grow smaller than in rainforests due to increased light penetration and water permeability --> also leads to thicker understory foliage; Animals include Costa Rican national bird, the Quetzal  Tropical Dry Forest: Similar to Rainforest, however has a longer dry season; trees are deciduous (trees that shed leaves annually); canopy is lower than that of a tropical rainforest; undergrowth is often dense/tangled due to more light penetrating to the forest floor; Animal species are less diverse compared to rainforests; include crested guan, other birds, snakes, lizards
Metaphor (transversality)	A forest is like a house, different levels house different people/animals
Resources	<a href="http://www.srl.caltech.edu/personnel/krubal/rainforest/Edit560s6/www/whlayers.html">http://www.srl.caltech.edu/personnel/krubal/rainforest/Edit560s6/www/whlayers.html</a>

	<a href="http://www.pugetsound.edu/academics/academic-resources/slater-museum/biodiversity-resources/world-biomes/characteristics-of-bioclimatic/tropical-dry-forest/">http://www.pugetsound.edu/academics/academic-resources/slater-museum/biodiversity-resources/world-biomes/characteristics-of-bioclimatic/tropical-dry-forest/</a> <a href="http://cloudbridge.org/wp-content/uploads/2016/07/CLOUD-FORESTS-INFORMATION.pdf">http://cloudbridge.org/wp-content/uploads/2016/07/CLOUD-FORESTS-INFORMATION.pdf</a>
Objectives / Takeaways	Understanding of the parts of the forest and how they work together and influence each other.
Topic	Cultural Symbol of a Tree
Description	How other cultures worship and respect trees
Research	In many Native American tribes, there is a story similar to this: The Creator planted a Sacred Tree, under which anyone could gather. There they would find healing, power, and wisdom. The roots of this tree ran deep into the body of Mother Earth, and its branches reached up high towards Father Sky. The fruits of the tree are the good things the Creator has given to the people: teachings that show the path to love, compassion, generosity, patience, wisdom, justice, courage, respect, and humility. The shade under the tree would protect them. If they completely forget the tree they will lose its gifts. If they seek to destroy the tree, the suffering will fall on the people. They will lose all the gifts, and their lives will turn to anger and gloom.
Metaphor (transversality)	Use metaphors found in the stories about trees from other cultures
Resources	<a href="http://globaltrees.org/threatened-trees/tree-values/cultural/">http://globaltrees.org/threatened-trees/tree-values/cultural/</a> The Sacred Tree by Jane Goodall: <a href="https://books.google.co.cr/books?hl=en&amp;lr=&amp;id=yNGrqIaaYvgC&amp;oi=fnd&amp;pg=PP7&amp;dq=native+american+tree+symbol&amp;ots=_RXbVpZzqV&amp;sig=FQirEVHnKaKGgp6YNN9fXmIQQOo&amp;redir_esc=y#v=onepage&amp;q&amp;f=false">https://books.google.co.cr/books?hl=en&amp;lr=&amp;id=yNGrqIaaYvgC&amp;oi=fnd&amp;pg=PP7&amp;dq=native+american+tree+symbol&amp;ots=_RXbVpZzqV&amp;sig=FQirEVHnKaKGgp6YNN9fXmIQQOo&amp;redir_esc=y#v=onepage&amp;q&amp;f=false</a>
Objectives / Takeaways	-Respect for one's culture -Mindfulness Empathy
Topic	Communication between Trees
Description	Trees are known to communicate each other to assist each other with survival.
Research	<p>Trees communicate to warn each other of danger, so that they can prepare</p> <p>Fungi have a web of thread beneath them, called mycelium. These threads connect to tree roots, and trade nutrients for carbon with the roots. This network connects to multiple different tree systems.</p> <p>Trees use their root systems to trade carbon, water, nitrogen, defense chemicals, and hormones.</p> <p>Mother trees (large established trees) send their resources to small seedlings trying to grow. Trees even prefer their own children when doing this.</p> <p>If you leave the bigger "hub" trees, a forest that loses trees can heal faster and regrow easier.</p> <p>Losing too many major trees can damage the entire forest</p> <p>Tested by: Planted a group of young tree saplings together. Covered each tree in a bag and filled some of the tree's bags with a radioactive carbon isotope and some with a regular carbon isotope that wasn't radioactive.</p> <p>One tree without the radioactive isotope was put under a shade bag so it could not absorb any CO<sub>2</sub>. After waiting a while for the other trees to absorb the CO<sub>2</sub>, the tree under the shade bag had received the radioactive isotope and was reacting to the Geiger meter. The bags stopped the tree from absorbing any radioactive CO<sub>2</sub> on its own, so it must have received the isotope through its roots from the other trees.</p>
Metaphor (transversality)	Trees are like a community, they communicate with each other to help each other survive
Resources	<a href="https://www.ted.com/talks/suzanne_simard_how_trees_talk_to_each_other#t-427642">https://www.ted.com/talks/suzanne_simard_how_trees_talk_to_each_other#t-427642</a>



Objectives / Takeaways	Transversality Leadership Bio
---------------------------	-------------------------------------

## Appendix D: Interviews

### Interview Questions for Teachers

1. How long have you been teaching?
2. What age groups of children do you teach?
3. What do you enjoy about teaching this age group? Why?
4. Which subjects do you teach currently? Which environmental topics/topics about nature do you teach currently?
  - a. Why do you think these are important?
5. Do you find different students respond better to different learning styles? (i.e. auditory learning, visual learning, from lectures)
6. What kinds of tools do you use for teaching? (i.e. workbooks, whiteboards, computers)
  - a. Why do you use them (What was successful or unsuccessful)
7. Do you take students on field trips? What for?
8. How often do you take your students outside to learn?
  - a. Do you think that taking them outside helps them to learn better? Why?
9. What are some of activities you use in the classroom that you find successful in presenting topics to this age group?
  - a. Why do you think they are successful?
10. From your experience, which activities do students seem to enjoy most? Why do you think this is so?
  - a. How do you implement them in your classroom?
11. Which activities do students tend not to enjoy?
  - a. Why not?
12. How do you think your students would respond to technology like using an iPad when learning (i.e, excited, disappointed, etc.)? Why?
13. If a bus came to your school that would combine technology and nature to get students their environment and trees, do you think it would be a useful supplement to your teaching?
  - a. What would you like to see inside of it?

### Exhibit Designer Interview

1. What are the first steps in building a museum exhibit?
2. Can you tell us about your design process?
  - a. What do you keep in mind during the design process?
3. What exhibit has been your most successful?
  - a. Why?
4. In general, what makes an exhibit successful?
5. Do you measure the success of each exhibit?

- a. If so how? What do you measure?
6. How do you make learning fun?
7. What are some strategies you use when teaching about the environment?
8. What are some strategies you think we should avoid?
9. What are some tools you use?
10. How much do you believe we could expect to spend on a typical interactive exhibit?
11. How much is a fake tree?
12. How much do animations cost?
13. Do you design your own interactive computer programs?
  - a. [If Yes] What steps do you use to design them?
  - b. [If No] How much do they cost? Where do you go to develop them?
14. What suggestions would you have for our project?

## Appendix E: Surveys

### Public Teachers Survey

1. How long have you been teaching?
2. What age groups of children do you teach?
3. Which subjects do you teach currently?
4. Do you or have you ever taught any environmental topics?
  - a. [If yes] which ones?
5. Do you find different students respond better to different learning styles? (i.e. auditory learning, visual learning, from lectures)
  - a. [If yes] How do you try to accommodate for different learning styles?
6. What kinds of tools do you use for teaching? (i.e. workbooks, whiteboards, computers)
  - a. Which do you find most successful and which least successful?
7. How many times a year do you take students on field trips?
  - a. 0
  - b. 1
  - c. 2-5
  - d. 5-10
  - e. 10+
  - f. [If more than 0] please list some examples of places you take the class.
8. How often do you take your students outside each month?
  - a. 0
  - b. 1-5
  - c. 5-10
  - d. 10-20
9. What are some of activities you use in the classroom? (i.e games, coloring, crafts)
10. Which activities do you find are most successful? Why do you believe so?
11. If a bus came to your school that would combine technology and nature to get students their environment and trees, do you think it would be a useful supplement to your teaching?
12. What would you like to see inside of it?

### Exhibit Designer Survey

1. What are the first steps in building a museum exhibit?
2. Can you tell us about your design process?
3. What exhibit has been your most successful? Why?
4. In general, what makes an exhibit successful?
5. How do you measure the success of each exhibit?
6. How do you make learning fun?

7. What are some strategies you use when teaching about the environment? What are some strategies you think we should avoid?
8. How much do you believe we could expect to spend on a typical interactive exhibit?
9. Do you design your own interactive computer programs? If so, what are the steps to do so? If not, how do you get them? What kinds of costs are associated with this process?

## Appendix F: Coded Interview and Survey Responses

Teaching Methods	
<b>Senses</b>	<b>Outdoor Education</b>
The workshop should be a sensory tool that gives the experience of being inside the forest.	Suggestion: Send kids to a forest and give them a list of 25 species of trees and have the children try to find them all
Suggests we engage all 5 senses.	Likes to have children see the roots and the pollination and realizing how it all connects to the greater ecosystem.
Successful exhibits hit all of the five senses	Takes her students outside a lot and believes they learn better when they can run around.
Have the bus stand out to attract attention.	Feels students are forced to sit down too much and that it's not natural to do so.
	Thinks that field trips are important because they introduce kids to different cultures, lets them learn about the place and the environment.
	What they don't like doing is standing around and reading—when they come to a museum they want to move around and see stuff and get their hands on things.
	Out of 3 public school teachers surveyed: 2 never take students on field trips, 1 did 2 to 5 times a month, to museums and universities
	Out of 3 public school teachers surveyed: 2 teachers never take children outside, 1 does 1-5 hours a month
<b>Examples</b>	<b>Tools</b>
He might give a student something and tell them to do something creative with it, and the student can choose what they do, whether it's draw, take notes, or anything new they think of	Lesson sheet: more than a worksheet, the idea being fewer lessons but more quality in depth lessons
Takes the children outside and has them meditate and think mindfully. He has them relax, smell, feel the wind on their skin. Some kids react by just taking a nap, some get distracted by everything they see, some bring their notebooks to read and take notes.	Lesson plans contain major ideas of a topic, the theory, diagrams, animations, practice questions, and more.
Doing things/making things with trash or bottles.	Uses animations
Constructing things and also activities with their bodies. Things to touch.	Internet, a textbook, and a lesson sheet
example exhibit: it's a nice combination of hands-on interactives, immersive environments, and fairly intensive staffing to meet our learning goals of introducing Chinese mainland culture to kids ages 4-10.	Believes games are an excellent idea
I have them tell leadership stories, stories about who they are as a leader.	She makes plans before class, and thinks about how children will interact with objects she has in the classroom
I have them write down their story and then perform it	She teaches in a more hands on way, she gives children objects and sees how they react to them.
Common Story structure: In the beginning: There is something wrong in the world of the protagonist. Plot point one: A big event happens and they are motivated to do something about it so they head out on their journey. Plot point 2: The protagonist figures out how to achieve what they want. Finale: The protagonist realizes he could have done it himself the whole time. He is not a storyboarding guy, he is a playwright by training	Technology: She warns that we must teach the right way to use the technology first, because the students will smash the computers or treat them incorrectly. It's important to have something physical you can interact with early- rough prototypes are essential before you get too far into the design process
Monochromatic Room- the phenomenon itself is unique and interesting and the presentation of it is a big room where you can explore lots of different things.	Suggests using cloth they can touch and play with, or DJ materials, or have space to dance. Maybe the children can make music using nature and objects nature
Out Quiet Yourself @ UN Plaza Sound Commons. It was an adaption of an existing indoor, singular experience exhibit called Out Quiet Yourself, but we made it weather proof and robust and removed the tunnel and singular experience aspect. Now it is a crowd pleaser, frequently revisited, and much more dynamic because of social interaction.	We should have things that can be removed and played with instead of attached.
Some of the best exhibits are open ended, intuitive to use, platforms for experiments.	We have to think about how humidity will affect the computers

	She does not like teaching by curriculum. She likes to use a lot of projects
	Games that keep the actual learning of the activities somewhat hidden
	Industrial-strength model touchscreen units, heavy-duty cabinets and casework for iPads, etc
	When I am teaching I try to think if I can tell a story about the topic
	Books, chalkboard, computers
	Books and technology are more successful than the using the board
	Games are used because they entertain the students

## Different Learning Styles

Trying to make the transition from a teacher centered class to a student centered class
Little kids are not afraid to share. They are very creative and have many ideas. The older kids are also great because they begin to explore
She pays attention to how the children learn best and tailors her teaching teach one of them
She allows the children to guide the teachers. She sees what a child is playing with and uses that as an opportunity to teach.
She builds activities around each student's learning style.
Each child enjoys different things, and therefore having many options is very important.
They are going to be role models at some point and need to understand that actions will have consequences.
Boys between 7-10 years absorb info fast, analyze differently, have a different POV, and are not scared of trying new things
Teacher 2 has found that things they have to read, things they have to be in the same position for an extended period of time, do not interest students.
Makes a profile of the group. Look for ages. Do interviews. What they like or do not like to do. Try different things instead of the same activity every time
Give the students the means to get an answer and to learn.
Exhibits hit different learning styles
Kids generally love finding out new things
Students tend to remember stories better than they remember a set of facts
We should be careful with children stories to not over-simplify them. By the age of 7 they are already good consumers of stories
Books, chalkboard, computers
Books and technology are more successful than the using the board
Games are used because they entertain the students

## Experience

T1: Approximately 18 years as a teacher
T1 teaches 11/12 grades
T1 teaches Biology
T1 teaches climate change, responsibility, sustainability
T1 teaches at United World College
5th grade is a great age for teaching science because they have developed a lot of knowledge and skills needed for learning
6th to 8th grade is difficult to teach, and then in high school it gets easier when they start to get interested in certain topics
T3 has taught for 9 years
T3 Taught in Costa Rica, U.S., and Panama
T3 worked on a project with MIT where they taught teachers and then kids how to use computers, and use kid friendly creative programs like Scratch.
T3 teaches pre-school kids
T2 has been teaching for 14 years
T2 teaches 8-10 year olds, 9-12, and 29-30 year olds
T2 teaches Spanish, Danish, English, and environmental science
T2 teaches consequences of actions, importance of recycling and reforestation as environmental topics
T2 works at CRLA
T2 has a degree from UCR
Storyteller: I did my undergrad major in creative writing
Storyteller: I liked writing stories in 7th grade in English class
Survey teacher 3: Taught at Ctp Uladislao Gamez Solano
Survey teacher 3: has 8 years' experience
Survey teacher 3: teaches kids 12 to 17
Survey teacher 3: has never taught about the environment

## CR Schools

Almost everyone in Costa Rica has a cellphone
Costa Ricans would likely love any technology that seems similar to an iPhone
Schools teach about the environment but not like Arboles does. Modulo Educativo is as close as it has gotten in public schools

Bus Comments/Suggestions
Suggests we pull the bus up to a park for the children to explore, and just have the bus there as a resource
He wants to see bells, whistles, and lights
Bring in experiences from different locations
He suggests the bus could be parked nearby as a resource, so when a student finds a species of insect or a tree that the teacher doesn't know, they can run to the bus and the bus has the information on board
Send kids to a forest and give them a list of 25 species of trees and have the children try to find them all
Start with a smaller bus, and as it gains popularity we can upgrade the bus with the money it brings in
Be careful as the questions may bring up wounds and has to be ready to deal with some serious emotion from the children
She warns that we must teach the right way to use the technology first, because the students will smash the computers or treat them incorrectly.
She wants to see props inside the bus that they can experience and learn with in their own way. Suggests using cloth they can touch and play with, or DJ materials, or have space to dance. Maybe the children can make music using nature and objects nature
We should have things that can be removed and played with instead of attached.
But she says we need to have somebody there to make sure they are using the equipment properly, especially if they are expensive. We must childproof the bus, teach the kids limits before getting on the bus, and set rules.
There must be somebody there to hug them if any intense emotions come up.
We have to think about how humidity will affect the computers
We have to be prepared for if it rains, we can't just squish everyone on the bus
We have to account for small streets in Costa Rica
let them know that the rules are there for them and so that other people can use them as well
She suggests that we ask the students what they thought about the bus and what they would have liked to see inside when they are leaving.
She suggests we do not marry to the material so that we can adapt the material to what the kids suggest and enjoy the most
Suggests we have both technology and nature based experiences
Wants to see consequences of trash and destruction of environment. Reefs dying, deaths of animals
Make sure it hasn't been done before or is unusual for the general public, make it unique!
Make sure to keep the exhibits current.
Be like a science on wheels bus
Work with the lights to help create forest feel
Use recycled material for tables and chairs
Have the bus stand out to attract attention
Remember that it's an attraction so it must be fun and attract people
Successful exhibit should: promote conversations, questions, and participation/engagement for our visitors
Labels are all 50 words max, in 25-30 word paragraphs
The real meat of the topic for any given activity or label is—what would a kid find interesting or relevant? Then distill that down to a couple sentences, and give them something to do that reinforces that information, whether it's a computer game or a mechanical interactive
We do a lot of front-end surveys with kids in our building to find out what they know about a topic and what they want to know more about
It is good to know what they are already learning about the environment in their schools
He suggests that maybe we do not just write stories but find stories that already exist
He suggests we find a story where a tree is an active protagonist.
Maybe a story where the tree needs help from a person who provides it
We should be careful with children stories to not over-simplify them. By the age of 7 they are already good consumers of stories
Allow people to see actual things that they can't see anywhere else; avoid making an exhibit that would work better as a video/book; avoid being didactic
don't let people know they're learning anything in the process
Just focus on fun and the learning will happen. Don't worry about communicating or teaching specific science content
Give people an opportunity to experience the environmental phenomena

Design Process
Start with a theme (trees vs conservation vs types of trees)
Second step: combine objectives and information with the games or activities that you want to use
Third step: get into specifics, what types of computers, materials, etc.
Measure success by asking questions to people, surveys and most importantly just observing behavior around the exhibits.
Design games that keep the actual learning of the activities somewhat hidden
Make sure to keep the exhibits current.
Keep it simple! Children think much simpler than adults do
First steps involve defining our goals of what messages we want children and families to leave with.
Our messaging and learning goals drive the eventual physical design of the gallery
People who work for the Indiana Children's Museum: curator, a content developer, a 3-D designer, a graphic designer, a production/fabrication lead, and members of our programming team who will staff
Refine those designs and plans to be very specific about each display, label, and interactive element
Prototype interactive elements with our visitors to ensure that things go according to plan



Trying to find something that is compelling and can't be done better via different medium. I always look for direct experiences that people can interact with.
Lots of trial and error; have to be willing to not get too attached or invested to ideas so that you can toss them when they're not working
How to tell if an exhibit is successful: Something which allows people to discover or explore something for themselves rather than being told what to do or why the exhibit is interesting
How to tell if an exhibit is successful: Something which allows people to discover or explore something for themselves rather than being told what to do or why the exhibit is interesting.
Play, Prototype, Talk
Try early and often. Get something in front of the public ASAP. Don't fixate on 'DESIGN', focus on the ambiguity and obstacles and tackle them early and head on
Criteria for success of an exhibit: emotional investment, change of perception, smiles, sharing...if you talk about it afterwards
How to measure exhibits: patient observation, dialogue, interviews
Start by Identifying interesting phenomena and ways to experience and interact with it.
Iterative prototyping. Build a prototype and test it as soon as possible. Learn from users
Suggested resource: interest: <a href="https://www.exploratorium.edu/sites/default/files/pdfs/design5pitfalls-2.pdf">https://www.exploratorium.edu/sites/default/files/pdfs/design5pitfalls-2.pdf</a>
Simple, experience of real phenomena, easy for people to use, unexpected.
How to measure success of exhibits: Watching people enjoy themselves, thought provoking experiences.

<b>Teacher Training</b>
4 days of 10 hours a day is a lot of time for training
Prefers something 2-4 hours long
She suggests that if Arboles is creating the alliance with the school system they should try to get points for completing it
She suggests we make the training for teachers similar to how the class would be for the students, put the teachers in their student's shoes. They will see how the kids might react and listen to how each teacher says their kids would respond. It would also help the teachers feel compassion for their students.
T2 thinks that the teacher training program should have feasible hours
T2 also thinks that the training should be no less than 10hrs/week;
A lot of teachers may not want to spend the extra time to take the class. They have other priorities. They might need more motivation. The government is too close, they have to follow the rules. The government doesn't allow much input from teachers.

<b>Cost</b>
Cost of an exhibit depends a lot on the design. Depending on the types of exhibits, one will need to contact a lot of people to do specific tasks. Ex. Sculptors, programmers, graphic designers, etc.
Could be around \$700/m2
Exhibit cost is very dependent on materials choices
In the US: \$15-40K per application or program depending on its complexity

<b>Design Process</b>
Start with a theme (trees vs conservation vs types of trees)
Second step: combine objectives and information with the games or activities that you want to use
Third step: get into specifics, what types of computers, materials, etc.
Measure success by asking questions to people, surveys and most importantly just observing behavior around the exhibits.
Design games that keep the actual learning of the activities somewhat hidden
Make sure to keep the exhibits current.
Keep it simple! Children think much simpler than adults do
First steps involve defining our goals of what messages we want children and families to leave with.
Our messaging and learning goals drive the eventual physical design of the gallery
People who work for the Indiana Children's Museum: curator, a content developer, a 3-D designer, a graphic designer, a production/fabrication lead, and members of our programming team who will staff
Refine those designs and plans to be very specific about each display, label, and interactive element
Prototype interactive elements with our visitors to ensure that things go according to plan
How to evaluate exhibit: tracking and observing visitors, giving exit surveys
Good to know what they are already learning about the environment in their schools
What students learn very different than if this is intended for kids in Costa Rica
We look at school standards and try to build from them as a complimentary type of informal education

We do a lot of front-end surveys with kids in our building to find out what they know about a topic and what they want to know more about
Usually the exhibit content developer writes a storyboard for the game or interactive in question, working with our programmer to make sure what we're suggesting is feasible
We may prototype with visitors to make sure the interface is working and that kids get what they're supposed to do

## Appendix G: Activity Scripts

### Table of Contents:

1. Tree Cycle Animation
2. Interactive Website
3. Scavenger Hunt
4. Voice Box
5. Video
6. Flower Activity
7. Role Playing
8. Mindfulness

### 1. Tree Cycle Animation

**General Description:** The Animation activity shows the life cycle of a tree, from a seed to a mature tree. There will be a projector showing the animation on a screen. The animation will show visuals and text and will be clickable, so the student clicks from one scene to the next. This allows students to be able to absorb information at their own pace. Through the animation students would learn basic tree biology in the life cycle of a tree. Students would be able to relate their own personal growth and development to the development of a tree, which teaches students transversality.

**Size:** 0.75x0.45m of wall space

**Time Needed:** 5-8 min

**Materials Needed:** TV Screen



Animation will start by saying this: “A seed is like a baby...”. Then a seed will appear on the screen, and next to the seed this text will appear: “Like a baby, the seed is the first stage in a tree’s life. It is created by an adult tree and is located inside the fruit. Once it is safely in the

ground, it needs to be fed enough water before it starts to grow.” As the last sentence is shown, the seed transforms into a sprout.

The sprout appears and then the next text will show: “Next the seed grows into its child form, a sprout. The sprout begins to grow its roots and breaks through the surface of the soil to reach the sun. Just like how a child learns how to walk, the seed begins to absorb sunlight to make food through photosynthesis.” [Briefly define photosynthesis]. “The sprout uses the food it gets from photosynthesis to grow bigger and stronger.”

As the following text is shown, the sprout begins to transform based on the text: “The sprout continues to grow from a child to a teenager, or a sapling. Just like a teenager, a sapling begins to look a lot more like a fully grown tree. More leaves grow and green stems beginning to harden and change color. They still need time to grow before they are able to be on their own.” A sapling begins to transform into a full grown tree as the following text shows: “Once the sapling is fully grown it becomes an adult tree. Just like an adult, it joins the world of other adult trees, competing with other adults for sunlight. The adult tree beings producing fruit that can feed the animals of the forest. Inside these fruit are the little baby seeds, fall to the ground in the fruit and begin the whole process over again”.

## 2. Interactive Video games

General Description: The first game teaches students about the different species of trees and where they are located within Costa Rica. The main emphasis of the first game will be on distinguishing the Guanacaste tree, which is the Costa Rican national tree, from other tree species as this is an area of importance for Árboles Mágicos. It also teaches students transversality as they can relate the different species of trees to the different nationalities of humans and how each species/nationality have different roles in the ecosystem/society. The second game will teach students about the parts of the different types of forests in Costa Rica and the biodiversity within these forests. This game allows students to relate the parts of a tree to the parts of their body - which also teaches students transversality. The third game focuses on teaching students about sustainability and ways to conserve resources. This last game gives students the ability to learn respect and empathy for the environment, and can also show students ways that they can make a change in the environment which strengthens leadership skills.

Size: 9.5x6.5 inches

Time Needed: 5-10 minutes

Materials Needed: Tablet or touch screens, website/application

There will be a home screen on which there will be a few choices of games that the kids can play.



#### Game 1:

The first game is about identifying tree species. Each screen will have a brief prompt to tell the students how the game works and give them brief instructions on what to do. They will have to “match the following trees with their pictures”, and there will be four choices with images underneath. One choice will be the Guanacaste tree. When the student gets all the choices correct, there will be a description of each tree and what its uses are and the animals that live in/use it. The description will also tell students where each tree can be found. Since there are many different types of tree species in Costa Rica, the game will exchange three out of four answer choices, descriptions, and images of trees each time it resets, so that students learn as much as possible from one game. However, the Guanacaste tree will remain constant throughout each time so that students will be able to identify the national tree of Costa Rica specifically.

#### Game 2:

The next game is a monkey climbing game. Students controls a monkey that needs to climb through a forest, from the understory to the canopy. The monkey will move by jumping from branch to branch as it climbs to the canopy. As the student progresses up the trees they will see what part of the forest they are in on the right. There will also be different animals on branches in different parts of the tree. They will act as obstacles, and when students reach each animal they will learn basic facts. At the end, there will be an overview of the parts of the forest and key highlights about each layer and the animals that inhabit these layers. There will be different levels to show the different types of forests. Easy is the type with the least layers (Tropical Dry Forest), medium is the one with the second most layers (Tropical Cloud Forest), and hard has the most layers (Tropical Rain Forest). There will also be more animal obstacles as the game gets harder.

#### Game 3:

The third game will be about recycling and topics related to sustainable living and saving the environment. The premise of the game is that students will be playing the role of a secret agent with the task of helping save the environment. There will a map of Costa Rica that contains a few different places to click on. At each place there will be an environmental issue that will require the student’s help to solve. Each issue, such as someone throwing plastic bottles into the

ocean or dumping trash onto the ground, will prompt the student to make a decision for what the person should have done correctly as there will be three choices on the screen. The student will have three chances to choose the correct answer. If a student selects the wrong answer, the secret agent will then come onto the screen to tell the person what they should've done and why what they did was bad. There will be concepts such as recycling, conserving water, waste management, and general sustainability. As the child progresses, the country will gradually turn from a dirty brown color to green to signify the change from bad to good environmental practices. At the end of the game there will be an overview of key highlights of what should have been learned while completing the game.

### 3. Scavenger Hunt

**General Description:** The scavenger hunt provides students with the opportunity to learn about a tree's specific role in the ecosystem and its symbiotic relationships with various animals. Students will also learn the real-world impact that trees have on the environment and empathy. Students will also use motivational skills of situational interest and student autonomy to actively search for each animal within the mobile nature workshop.

**Size:** 0.2m cube

**Time Needed:** 25-35 min (To occur during the entirety of the mobile workshop)

**Materials Needed:** Fake animals, Fact cards

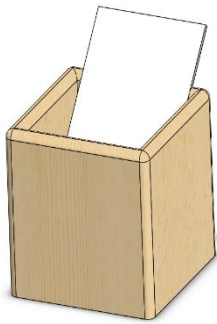

Upon entering the bus, there will be cards listing out the items in the scavenger hunt that kids should keep an eye out for. The cards will be given out to each kid. When the kids find the items, there will be a fact card that helps teach kids about what they found. The animals themselves can be removed and played with, but the cards cannot.

“While you're walking through, keep an eye out for these animals:

Animal, description, where it might be found.

Etc.

Costa Rica is full of many diverse plants and animals. The ones that you found here represent a very small portion of those in all of Costa Rica.

## 4. Voice Box

**General Description:** In this activity, students learn how trees communicate through their roots. A pipe with a funnel attached to both ends runs from the large Guanacaste tree near the center of the mobile nature workshop to a smaller tree in a corner. Students talk to each other from two separate points by using the funnel as a microphone and an amplifier. This activity teaches students more basic tree biology and how they can relate tree communication to how humans communicate with each other.

**Size:** 3.2m long

**Time Needed:** 1-2 min

**Materials Needed:** Voice box

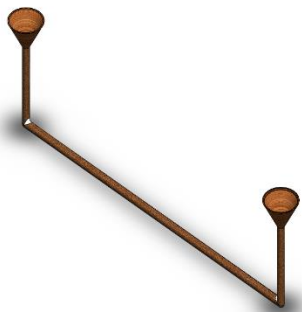

At the tree there will be located a funnel looking device that is camouflaged into the tree itself. Below the funnel will be an information card stating:

“The older larger trees communicate to the younger trees to send them extra food or warn them of danger, just like how your parents feed and protect you from danger. Speak through the phone to communicate to the other trees”

This funnel will be connected to a smaller tree in the corner of the bus where there will be another funnel with the same card to explain the concept.

“The older larger trees communicate to the younger trees to send them extra food or warn them of danger, just like how your parents feed and protect you from danger. Speak through the phone to communicate to the other trees”

## 5. Video

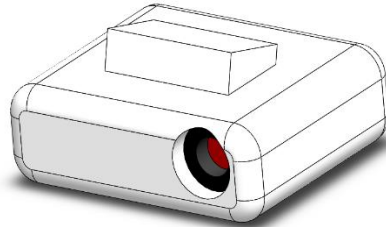

General Description: The video activity depicts a story adapted from an old tale told by many indigenous peoples. Through the video students will learn about trees as a cultural symbol and reinforce trees' roles in the ecosystems. Students will be able to relate to the trees and animals in the video through empathy and learn to respect trees as a cultural symbol and be mindful of cultures that do so.

Size: Screen: 2m wide x 2.2m tall, Projector: 0.25x0.3m mounted on ceiling

Time Needed: 3-6 minutes

Materials Needed: Projector, Screen

[Video opens panning over a huge tree, and zooms in on a white tailed deer sitting beneath it]



Narrator:

Había una vez, there was a Sacred Tree under which anyone could gather. It was a huge tree, with roots that ran deep into the Earth and branches that reached high into the sky. All the animals of the Earth would gather beneath this tree and enjoy its healing power and wisdom. On this fine day, Joaquín the white-tailed deer was resting beneath the tree's shade to escape the heat of the day, when a group of Capuchin monkeys approached him.

[Show the white-tailed deer looking up at some howler monkeys]





“Help us Joaquín,” the capuchins chattered, “we need to use your antlers.”

“For what?” Joaquín responded.

“We want to knock down the tree so we can reach the fruits at the top! The climb is too high for us.”

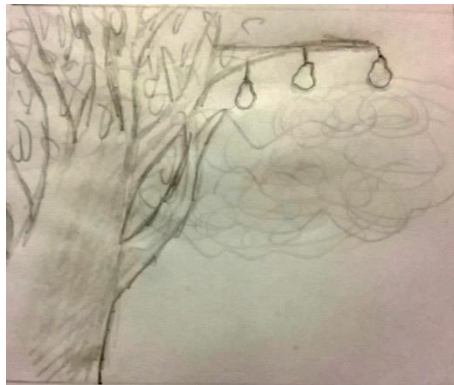

Joaquín was horrified by this suggestion.

“How could you hurt this beautiful tree?” he exclaimed, “it provides us with its delicious fruits! It gives us shelter from the heat and the rain! It provides homes for the birds, snakes, lizards, and more!”

“We don’t care, we are hungry now!” the monkeys moaned.

“But if you hurt the tree, think about how many animals will suffer,” pointed out Joaquín.

[A few baby deer come out from behind a tree and start running around in the shade]



Joaquín les dijo: “Where will my children play? The sun is too hot!”

[A toucan lands on a nearby branch]



Toucan: “I need its berries to feed myself”

[An ocelot appears on the branch behind the Howler Monkeys and startles them, knocking them off the branch]



Ocelot: “I use these branches to nap in the shade. You are not hurting this tree! The trees of this forest provide us with a happy life.”

Monkeys reply, “You are right this tree is important, but how will we eat, we will starve up here”

[Suddenly more birds come to gather at the tree and fly the monkeys to the top of the tree]



Monkeys continue to eat the berries, “Thank you! You all are a great community!”

## 6. Flower Activity

General Description: The flower activity will take place outside of the mobile workshop. In this activity students will reinforce the life cycle of a tree and how trees grow but planting seeds into soil and watering them. Students will be able to take their planted tree home with them as to

remember what they've learned in the mobile nature workshop, thus giving students a real-world connection to what they've learned as well.

Size: 0.9x1.2m

Time Needed: 5-10 min

Materials Needed: Soil, recycled bottles, seeds, water, cleaning supplies

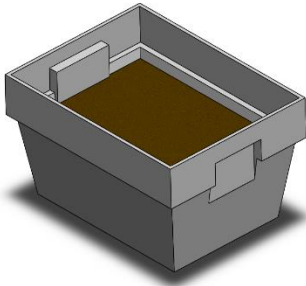

After the adventures through the bus the children will begin to exit the bus and gather around a large bucket of soil and other planting materials. They will all work together to gather the recycled materials and fill them with soil using their hands. There will also be a bag of seeds for planting in the soil. Volunteer will explain:

“To begin to grow, a seed needs access to water, oxygen, and sunlight. It will then soften so that the sprout can break through the hard outer shell and begin to grow. This is similar to a baby that needs love and nutrients to grow and the soil is like the mother that protects and feeds the seed.”

## 7. Role Playing

General Description: This activity involves students dressing up in animal and plant costumes. Students will be able to explore their imagination, which incorporates situational interest and student autonomy into the activity.

Size: 0.5x1m of wall space and .4m out from wall

Time Needed: 2-5 min

Materials Needed: Costumes, Clothes Rack



Different animal and plant costumes will be hanging on coat rack inside the workshop. Under each plant and animal costume there will be a description about where that plant or animal lives (what part of forest) and their part in the overall ecosystem. The child will be able to read the description if they choose or they can walk around the workshop in their costume pretending to be a plant or animal.

## 8. Mindfulness

**General Description:** The mindfulness activity is a meditation exercise will teach students how to be more mindful in their lives. This activity will occur inside the workshop and will be done in small groups.

**Time Needed:** 5 min

**Materials Needed:** None

1. Children will walk onto workshop and sit in a circle around the main tree.
2. They will close their eyes and listen to the sound that the workshop produces and just think about being inside a forest.
3. They will then think about a tree from their youth and about good memories about that tree.
4. The children will make sure to breathe deeply throughout the entire meditation.
5. Children will finally open their eyes and look around the workshop.

## Appendix H: Bill of Materials

Item	Description	Price	Source
<b>Vehicles</b>			
Used Box Truck 1	Used box truck. Smaller than others. 2005 Kia K2700 .	c 5.600.000	<a href="https://poas.obx.co.cr/se-vente">https://poas.obx.co.cr/se-vente</a>
Used Box Truck 2	Used 2002 toyota dyna. 171.000km. light cargo only? door on side	c 6.500.000	<a href="https://cumidabat.obx.co.cr/toy">https://cumidabat.obx.co.cr/toy</a>
Used box truck 3	Used box truck. Already empty, large usable space, 1995 International 4700	c 7.000.000	<a href="https://mora.obx.co.cr/camion-i">https://mora.obx.co.cr/camion-i</a>
Used box truck 4	Used 2004 GMC 142.700km	c 10.000.000	<a href="https://desamparados.obx.co.c">https://desamparados.obx.co.c</a>
<b>TECHNOLOGY</b>			
<b>Tablets</b>			
Apple Ipad Mini 4	Apple, simple, small, cheap	c 177.000	<a href="http://www.techradar.com/new">http://www.techradar.com/new</a>
Ipad Air 2	Apple, sleek, light, well priced	c 205.000	<a href="http://www.techradar.com/new">http://www.techradar.com/new</a>
Apple Ipad Pro 9.7	Apple, Powerful, large screen, more expensive	c 332.000	<a href="http://www.techradar.com/new">http://www.techradar.com/new</a>
Tree Communication Tubes	Tube with cones for communication	c 20.000	<a href="http://www.cubbyhousekingdor">http://www.cubbyhousekingdor</a>
TV	TV to show animation	c 50.000-100.000	<a href="https://smile.amazon.com/s/re">https://smile.amazon.com/s/re</a>
Speakers	Theater Solutions TS509 5.1 Surround Sound Home Entertainment System	c 40.000	<a href="https://www.amazon.com/q/p">https://www.amazon.com/q/p</a>
Projector	Projectors for roof decoration and for video	c 25.000-50.000	<a href="https://www.amazon.com/s/ref">https://www.amazon.com/s/ref</a>
Projector screen	2m wide projector screens	c 50.000-200.000	<a href="https://huntoffice.co.uk/overhea">https://huntoffice.co.uk/overhea</a>
<b>MISC</b>			
Outside decoration	Graphics for outside of the workshop	c 4.425.000-6.637.000	<a href="https://www.busbank.com/bus">https://www.busbank.com/bus</a>
App development for tablets	App for tablets for educational games and information	7.500.000-20.000.000	<a href="https://sawwapps.com/blog/ho">https://sawwapps.com/blog/ho</a>
Upkeep	Inclusive costs of running the vehicle, yearly	Depends on vehicle	
iPad Cases	shock and water resistant cases to protect against environment and kids	c 25.000-50.000	<a href="https://www.amazon.com/s/ref">https://www.amazon.com/s/ref</a>
signs	Plywood sheets to make signs	c 5.000-20.000	<a href="http://www.homedepot.com/b/L">http://www.homedepot.com/b/L</a>
table	Wooden table	c 50.000-100.000	<a href="https://www.amazon.com/s/ref">https://www.amazon.com/s/ref</a>
chairs	Wooden chairs	c 25.000-75.000	<a href="https://www.amazon.com/s/ref">https://www.amazon.com/s/ref</a>
Costume rack	wall racks for hanging costumes	c 25.000	<a href="https://www.amazon.com/hexx">https://www.amazon.com/hexx</a>
main tree	Tree for inside truck	c 500.000	High estimate from museum int
Inside decoration	Decorations for the inside of the bus to make it feel like a forest	c 400.000/m <sup>2</sup>	From interview with exhibit des
ramps	Wheelchair accessibility ramps	c 100.000-500.000	<a href="http://www.1800wheelchair.com">http://www.1800wheelchair.com</a>

Item	Description	Quantity	Cost per unit (Colones)
Small workshop			
Used Box Truck 1	Used 2005 Kia K2700, 5x2.3m	1	5,600,000
Tree Communicaiton Tubes	Tubes to sim. tree communication	1	20,000
Speakers	Speakers to create forest feel	1	40,000
Projector	Projectors for roof and video	2	25,000
Projector Screen	Screen for Video	1	50,000
Signs	Wooden Signs for inside	5	5,000
Table	Table	1	50,000
Chair	Seating	2	25,000
Costume Rack	wall mounted rack for costumes	1	25,000
Ramp	Ramp to enter workshop	1	100,000

<b>Projected</b>			
Main Tree	Tree for inside of workshop	1	500,000
Outside decoration	Attractive outside of but to draw attention	1	4,500,000
Inside Decoration	Decorations to create forest feel	1	400,000/m <sup>2</sup>
Upkeep			
Total Predictable Costs			6,010,000
Possible total costs excluding yearly upkeep			15,610,000
Suggested budget	(including 20% for safety)		18,732,000
Assumptions: Used low end items when applicable, used lowest costs on ranges		<b><u>*Links to products are found in Bill of Materials*</u></b>	

<b>Large Vehicle</b>				
<b>Item</b>	<b>Description</b>	<b>Quantity</b>	<b>Price per item (C)</b>	<b>cost</b>
<b>Predictable</b>				
Used box truck 3	1995 international 4700, large box 8x2.3m	1	7,000,000	7,000,000
Apple Ipad Pro 9.7	Apple, Powerful, large screen, more expensive	2	332,000	664,000
Ipad Cases	Cases to protect Ipad	2	50,000	100,000
Tree Communication Tubes	Tubes to sim. tree communication	1	20,000	20,000
Speakers	Speakers to create forest feel	1	40,000	40,000
Projector	Projectors for roof and video	2	50,000	100,000
Projector Screen	Screen for Video	1	50,000	50,000
Signs	Wooden Signs for inside	5	5,000	25,000
Table	Table	2	50,000	100,000
Chair	Seating	4	25,000	100,000
Costume Rack	wall mounted rack for costumes	2	25,000	50,000
Ramp	Ramp to enter workshop	2	200,000	400,000
<b>Projected</b>				

Main Tree	Tree for inside of workshop	2	500,000	1,000,000
Outside decoration	Attractive outside of but to draw attention	1	6,500,000	6,500,000
Inside Decoration	Decorations to create forest feel	1	400000/m <sup>2</sup>	7,360,000
App development for tablets	Development of an app or website for use on ipads	1	20,000,000	20,000,000
<b>Total Predictable costs</b>				8,649,000
<b>Total costs</b>				43,509,000
<b>Suggested budget</b>	(Including 20% for safety)			52,210,800
Assumptions:	All of the nicest options were chosen, upper limits of ranges were used.		<b><u>*Links to products are found in Bill of Materials*</u></b>	



Appendix I: Model 1 Design

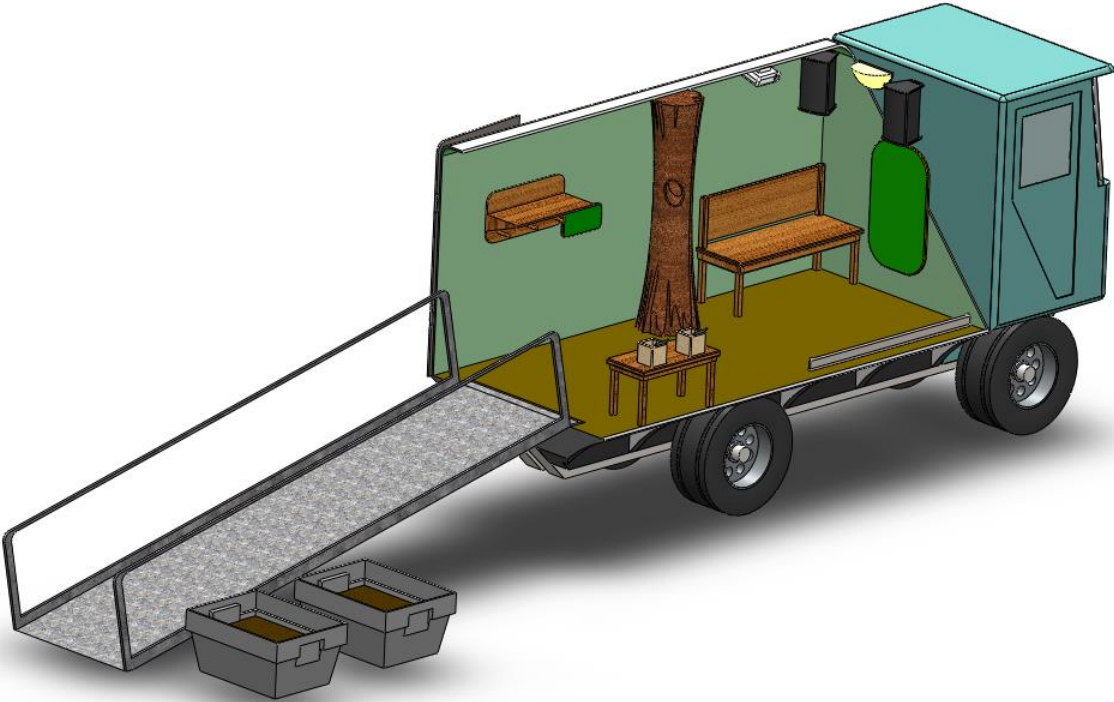
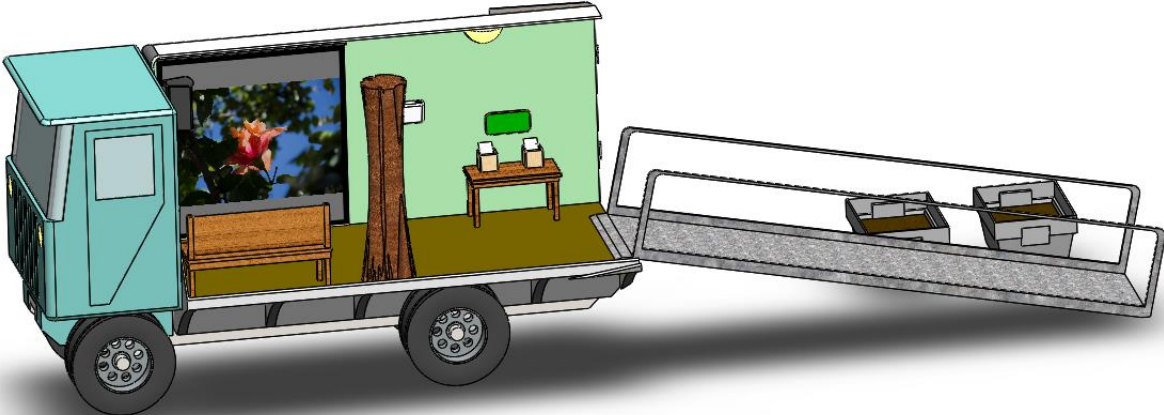



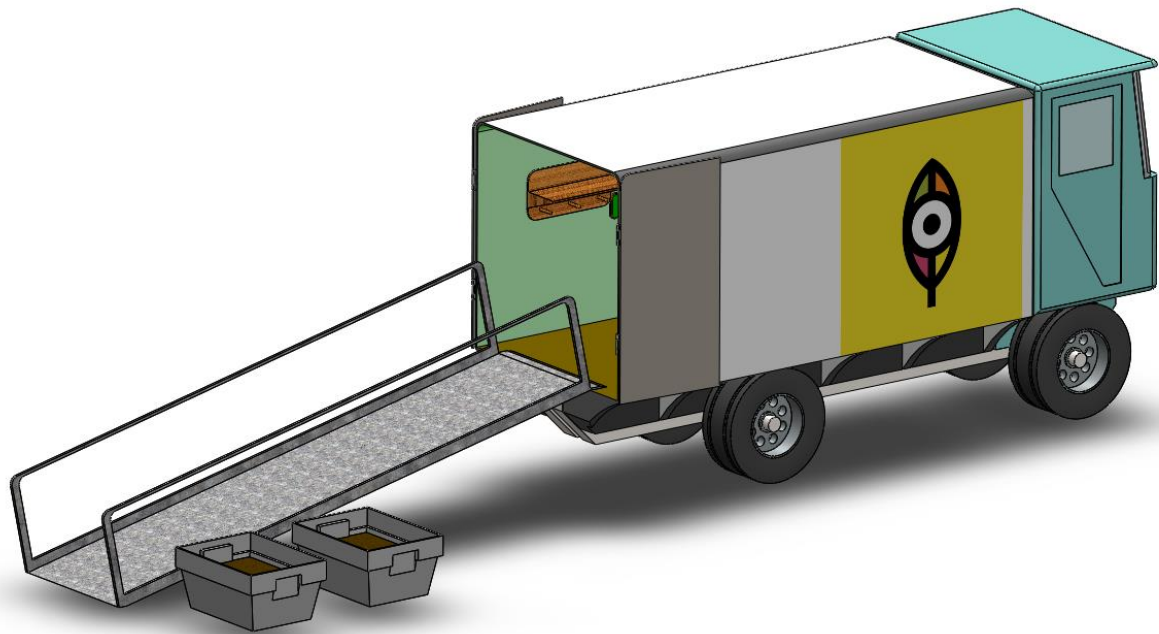
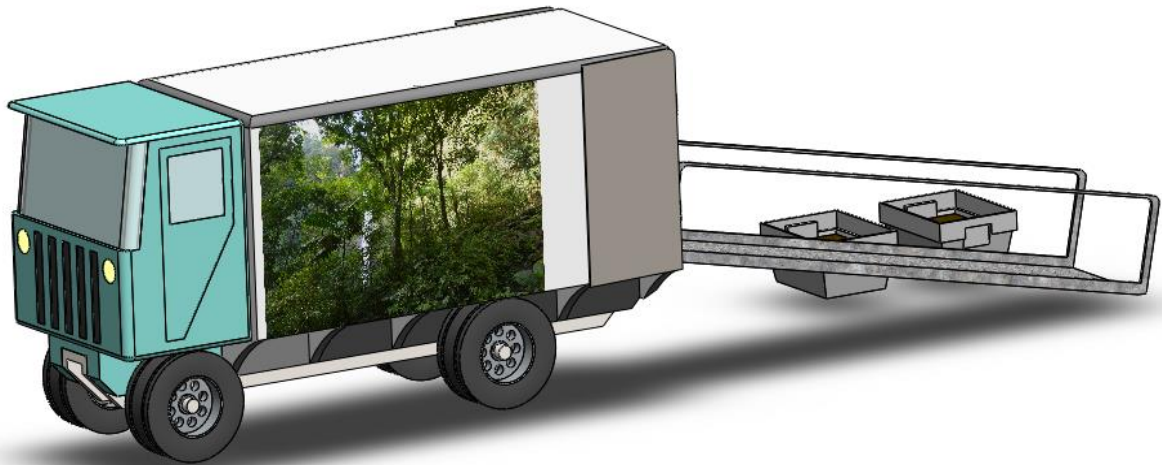

# Appendix J: Model 2 Design

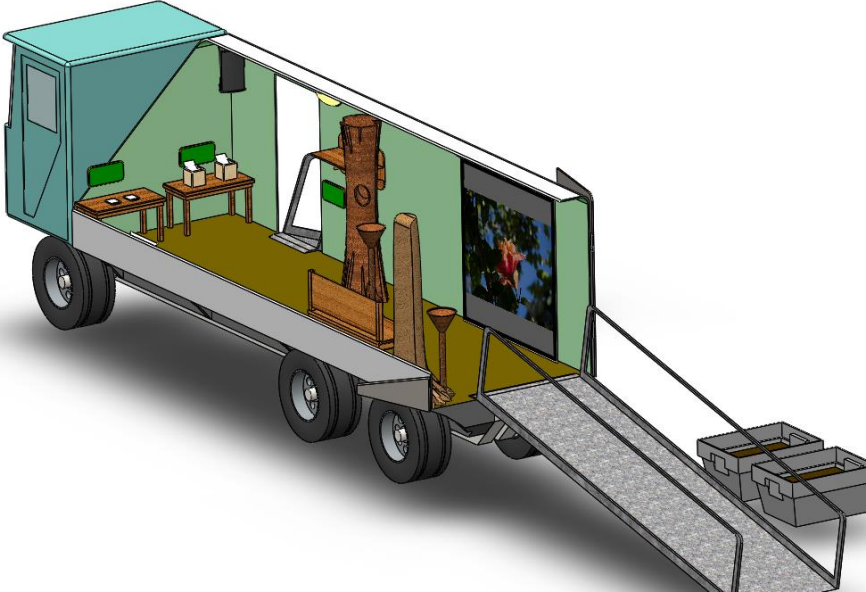

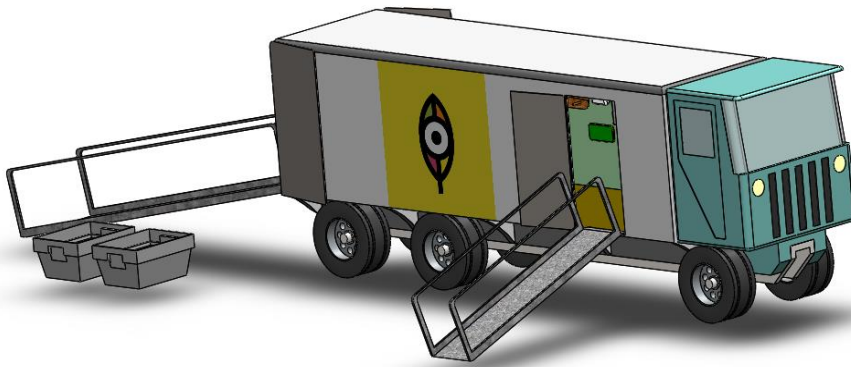

## Appendix K: Chapter VII Article 181 of Ley 7600

**ARTÍCULO 179.-** Bibliotecas, Centros de Documentación e Información

Todas las instituciones públicas y privadas que brinden servicios de Biblioteca, Documentación e Información, a través de sus unidades correspondientes, garantizarán que los mismos puedan ser efectivamente utilizados por todas las personas, asignando los servicios de apoyo, el personal, equipo y mobiliario necesarios.

### **CAPÍTULO VII ACCESO A LA CULTURA, EL DEPORTE Y LAS ACTIVIDADES RECREATIVAS**

**ARTÍCULO 180.-** Servicios de Apoyo en las actividades culturales, deportivas y recreativas

El Ministerio de Cultura, Juventud y Deportes, a través de todas sus entidades adscritas, proveerá los servicios de apoyo y desarrollará todas las adaptaciones que sean requeridas para que todas las personas con discapacidad puedan participar o disfrutar de todas las actividades que promueva, organice, autorice y supervise.

El ente rector en materia de discapacidad y las organizaciones de personas con discapacidad, asesorarán y supervisarán al Ministerio en el cumplimiento de dichas acciones.

**ARTÍCULO 181.-** Programación de actividades

Todas las actividades culturales, deportivas y recreativas en las que participen personas con discapacidad, se programarán temporal y espacialmente en forma simultánea con los demás eventos que promueva, organice, autorice y supervise el Ministerio de Cultura, Juventud y Deportes.

**ARTÍCULO 182.-** Acto discriminatorio en la cultura, el deporte y la recreación

Se considerará acto discriminatorio que, en razón de la discapacidad, se le niegue a una persona participar en actividades culturales, deportivas y recreativas que promuevan o realicen las instituciones públicas o privadas.