

WPI – Pedestrian Bridge Study



A Major Qualifying Project Report
Submitted to the Faculty of
WORCESTER POLYTECHNIC INSTITUTE
In partial fulfillment of the requirements for the
Degree of Bachelor of Science in Civil Engineering

James DeCelle

Nathaniel Efron

Wilfredo Ramos Jr

Jeffrey Tully

March 11, 2013 - MQP
GFS-1304

Professor Guillermo
Salazar
Professor Pinar Okumis

Abstract

This project explored alternative structural solutions for a pedestrian bridge to connect the field atop of the new Parking Garage to the alleyway behind Harrington Auditorium at the Worcester Polytechnic Institute Campus. Four basic bridge types, each consisting of steel or concrete, were initially considered. Two alternatives, a steel truss bridge and a steel arch bridge, were designed in detail. A Building Information Model was generated to visualize the two alternatives. The supporting bridge structure using cast-in-place reinforced concrete for both cases was also designed.

Capstone Design Experience Statement

The Capstone Design Experience is a requirement by the Civil and Environmental Engineering department at Worcester Polytechnic Institute (WPI) for all Major Qualifying Projects (MQPs). This experience helps students to be prepared for engineering practice based on the knowledge and skills acquired in earlier course work and incorporating engineering standards and realistic constraints. In order to meet this requirement this MQP prepared two bridge design alternatives, each with a BIM model, and addressed realistic constraints of economic, ethics, health and safety, and manufacturability and constructability.

This project explored alternative structural solutions for a pedestrian bridge to connect the field atop of the new Parking Garage to the alleyway behind Harrington Auditorium at the Worcester Polytechnic Institute Campus. Four basic bridge types, each consisting of steel or concrete, were initially considered. Two alternatives, a steel truss bridge and a steel arch bridge, were designed in detail. A Building Information Model was generated to visualize the two alternatives. The supporting bridge structure using cast-in-place reinforced concrete for both cases was also designed.

The following realistic constraints were addressed by the design:

Economic: We evaluated cost as a key constraint, which required a complete cost analysis for both bridge design alternatives. The cost of the raw materials, on-site preparation, and labor all affect the cost of the project.

Ethical: ASCE states that “engineers uphold and advance the integrity, honor, and dignity of the engineering profession by using their knowledge and skill for the enhancement of human welfare and the environment, being honest and impartial and serving with fidelity the public, their employers and clients, striving to increase the competence and prestige of the engineering profession, and supporting the professional and technical societies of their disciplines” (ASCE, 2010). The project was completed while upholding all of these principles.

Health and Safety: Health and safety always plays a major role in any project. The two bridge design alternatives were prepared in accordance with AASHTO Pedestrian Bridge Manual, AASHTO’s *LRFD Bridge Design Specifications and ADA Standards for Accessible Design*. The two bridge designs were compared, determining the design loads that each will support, selecting the appropriate member dimensions and performing a structural analysis on each design.

Constructability: This project considered the means and methods of construction of both alternatives including accessibility, methods of fabrication delivery and erection within the context of a college campus operating under regular functional conditions,

Authorship Table

<u>Section</u>	<u>Major Author</u>	<u>Major Editor</u>
Abstract	James DeCelle	Nathaniel Efron
CDES	James DeCelle	Nathaniel Efron
Introduction	All	All
Assessing the Need for a Bridge	Wilfredo Ramos	Wilfredo Ramos
Site layout	Nathaniel Efron	All
Concrete	Nathaniel Efron	All
Steel	Jeffrey Tully	All
Composite	James DeCelle	All
Simply-Supported	Jeffrey Tully	All
Truss	Nathaniel Efron	All
Arch	Wilfredo Ramos	Wilfredo Ramos
Cable-Stayed	James DeCelle	Nathaniel Efron
Design Criteria	All	All
Design Tools	Nathaniel Efron	All
Preliminary Design	Nathaniel Efron	James DeCelle Wilfredo Ramos
Selection Criteria	Nathaniel Efron	All
Construction Documents	Nathaniel Efron	All
Site Survey	James DeCelle Wilfredo Ramos	All
Structural Analysis	James DeCelle	Nathaniel Efron
General Analysis	James DeCelle Jeffrey Tully	Nathaniel Efron
Truss Design	Nathaniel Efron	James DeCelle
Arch Design	James DeCelle	Nathaniel Efron
Foundation Design	Wilfredo Ramos	All
Results & Analysis	Nathaniel Efron	All
Conclusions & Recommendations	Jeffrey Tully Nathaniel Efron	Nathaniel Efron

Acknowledgements

Our team would like to thank the following individuals, organizations, and institutions for their help and support throughout our project:

- Professor Guillermo Salazar, from Worcester Polytechnic Institute, for his overall guidance and support throughout our project.
- Professor Pinar Okumus, from Worcester Polytechnic Institute, for her overall guidance and support throughout our project.
- Gilbane Co, for allowing us insight into their meetings, providing plan sets, and allowing access to the site; specifically Neil Benner (Project Manager).
- Worcester Polytechnic Institute facilities, for providing us with resources and guidance throughout our project; specifically Fred Di Mauro for his valuable time in allowing us to interview him.

Table of Contents

Abstract	
Capstone Design Experience Statement	ii
Authorship Table	iii
Acknowledgements	iv
1 Introduction	1
2 Background.....	3
2.0 Assessing the Need for a Bridge	3
2.0.1 Interviews.....	3
2.1 Site Layout	4
2.2 Materials.....	7
2.2.1 Concrete	7
2.2.2 Steel.....	9
2.2.3 Composite	10
2.3 Bridge Systems.....	11
2.3.1 Simply Supported Beam	11
2.3.2 Truss.....	13
2.3.3 Arch.....	14
2.3.4 Cable-Stayed.....	16
2.4 Design Criteria	18
2.4.1 Americans with disabilities Act (ADA).....	18
2.4.2 Aesthetics	19
2.4.3 Site & Constructability	20
2.4.4 Economy	21
2.4.5 Environment.....	21
2.4.6 Fire Code.....	21
2.4.7 Geotechnical Concerns	22
2.5 Design Tools	22
2.5.1 Sap2000.....	22
2.5.2 BIM.....	23
3 Preliminary Design	24
3.0 Selection Criteria.....	24

3.1	Construction Documents	25
3.2	Site Survey	25
3.3	Deflection & Load Requirements	28
4	Design & Analysis	30
4.0	General Analysis	30
4.0.1	Bridge Deck Design	30
4.0.2	Bridge Load and Member Sizing	32
4.1	Truss Design	33
4.1.1	Deflection	34
4.1.2	Member Sizing	34
4.1.3	Truss Connections	36
4.2	Arch Design	37
4.2.1	Deflection	37
4.2.2	Member Sizing	38
	40
4.2.3	Arch Connections	40
4.2.4	Fire truck Clearance	41
	43	
	43	
4.3	Foundation Design	43
4.3.1	Truss Pier Design	43
4.3.2	Truss Middle Pier	45
4.3.3	Arch Footing Design	46
5	Results	48
5.0	BIM	48
5.1	Schedule	49
	50	
	50	
5.2	Cost	50
6	Conclusions and Recommendations	52
6.0	Conclusions	52
6.1	Recommendations	52
6.1.1	Further Steps	53
7	Bibliography	54
8	Appendices	56

8.0	Appendix A – Survey Data	56
8.1	Appendix B – Interview Transcript.....	56
8.2	Appendix C – Arch Bridge Analysis Tables from SAP2000.....	59
8.3	Appendix D – Arch Bridge Deflection Tables.....	61
8.4	Appendix E – Arch Bridge Design Calculations	64
8.5	Appendix F – Arch Bridge Foundation Design Calculations	64
8.6	Appendix G – Truss Bridge Analysis Tables from SAP2000.....	70
8.7	Appendix H – Truss Bridge Deflection Tables	74
8.8	Appendix I – Truss Bridge Design Calculations.....	74
8.9	Appendix J – Truss Bridge Foundation Design Calculations	74
8.10	Appendix K – Bridge Deck Calculations	83
8.11	Appendix L – Bridge Cost Estimation	91
8.12	Appendix M – Arch Bridge Schedule Estimation.....	91
8.13	Appendix N – Truss Bridge Schedule Estimation	91
8.14	Appendix O – Building Information Modeling.....	91
8.15	Appendix O – Project Proposal A’12.....	92

Table of Figures

Figure 1: Looking out of the New Recreation Center to the construction of the parking garage and athletic fields (October, 2012).....	1
Figure 2: Overview of proposed pedestrian bridge location.....	4
Figure 3: East/West Section of Garage Main Stair.....	5
Figure 4: Plan view of Main Stair at Field level.....	5
Figure 5: Planting plan showing the existing detailed grading.....	6
Figure 6: Hallen Bridge over the M5 Motorway in Great Britain	9
Figure 7: Merchants Bridge, Manchester, Great Britain.....	10
Figure 8: Common cross-sections of FRP decks from pultruded components.....	10
Figure 9: Basic Design Outline of Simply-Supported Beam Bridge.....	11
Figure 10: Simply-Supported Pedestrian Bridge Failure, Lowes’ Motor Speedway, North Carolina.....	12
Figure 11: Various types of truss designs	14
Figure 12: Arch Nomenclature	14
Figure 13: Concrete True Arch.....	15
Figure 14: Horizontal Cable Connecting Hangers.....	15
Figure 15: Steel Tied-Arch Bridge	16
Figure 16: Arch with Diagonal Hangers.....	16
Figure 17: Transverse Cable Arrangements	16
Figure 18: Longitudinal Cable Arrangements	16

Figure 19: Tower Configurations.....	17
Figure 20: Noncircular Handrail Cross Sections	18
Figure 21: Looking Towards the Loading Dock.....	19
Figure 22: looking Towards the Parking Garage	20
Figure 23: Garage in construction, showing area of interest for foundation	22
Figure 24: James DeCelle Conducting Surveying Shots	26
Figure 25: Here the bridge decking will meet the Parking Garage.....	26
Figure 26: The Bridge Decking will meet with the Loading Docks behind Harrington	27
Figure 27 : View From Harrington, overlooking the construction Area, the Parking Garage is in the Distance.....	27
Figure 28: LRFD Load Combinations and Factors.....	29
Figure 29:AISC Table 3-23 Case 10.....	30
Figure 30:Cross Section of Girder (W10x68).....	38
Figure 31: Pier Harrington and Parking Garage Top View	44
Figure 32: Pier Harrington and Parking Garage Longitudinal View	44

Table of Tables:

Table 1: Design Parameters.....	7
Table 2: Design Parameters.....	24
Table 3: Selection Criteria.....	25
Table 4: As-Built Surveyed Distances.....	28
Table 5: Unfactored LRFD Design Load.....	29
Table 6: Applied Loads.....	33
Table 7: Truss Guidelines.....	34

List of Electronic Files:

Revit – Truss Model
 Revit – Arch Model
 SAP2000 – Truss
 SAP2000 - Arch
 Design Calculations and Load Analysis Tables - Truss
 Design Calculations and Load Analysis Tables - Arch
 Cost Estimate - Truss
 Cost Estimate - Arch
 Deck – Moment Calculations
 Pier – Design Equations
 Abutment – Design Equations
 Pier – Design Spreadsheet
 Abutment – Design Spreadsheet

THIS PAGE WAS LEFT INTENTIONALLY BLANK

1 Introduction

Worcester Polytechnic Institute (WPI) an engineering and science institution of higher education located in Worcester Massachusetts educates 3,746 undergraduate students and 1,557 graduate students and employs 425 employees (Management, 2011). The student and faculty population has experienced steady growth for many years, but is now projected to slow due to a limitation in the number of residence halls. WPI's student, staff and faculty population generate a large amount of parking demand that is currently met by the street parking plus the existing parking facilities which consists of two parking garages (one on campus and one 1 mile off campus) and nine parking lots, many of them are only available to commuters or faculty. As of WPI's 2004 master plan, there were 785 surface lot spaces as well as 797 available street parking spaces. Unfortunately, since then over 200 of the surface lot spaces have been removed to accommodate new construction and 256 of the street spaces are in residential areas and are not legal and are often unavailable during the winter months (Dec 1-Apr 1) due to snow. A walk through the streets reveals every side of the street full of parked cars, with many people parking on side streets because there are not enough places to park. A lack of available parking spaces/areas has become a problem on campus at WPI.

To more effectively deal with this problem, WPI has funded and is currently building a new \$20 Million parking garage which holds 534 vehicles to meet the current parking deficit and projected future needs. The parking garage is located at the site of an athletic field (softball/ baseball and soccer field) which has now been relocated on the top of it (Figure 1).



Figure 1: Looking out of the New Recreation Center to the construction of the parking garage and athletic fields (October, 2012)

Access to and from the athletic field atop the garage is currently limited to the stairs and an interior elevator constructed with the new Sports and Recreation Center as well as a makeshift access ramp for snow removal vehicles along Park Avenue. It is in WPI's interest to construct a bridge from the new field to the back of Harrington Auditorium to allow for convenient travel between the field atop the garage and the center of campus in addition to snow removal vehicles and equipment. The bridge was discussed during the design phases of the Parking Garage and Athletic Field, but was put on hold due to the uncertain price of the Garage and Field at the time. WPI envisions the bridge as a key gateway to campus, connecting what will be the largest parking lot with the center of campus, as well as providing a promenade for students and alumni to take for spectating athletic events.

This project explored alternative structural solutions for a pedestrian bridge to connect the field atop of the new Parking Garage to the alleyway behind Harrington Auditorium at the Worcester Polytechnic Institute Campus. Four basic bridge types, each consisting of steel or concrete, were initially considered. Two alternatives, a steel truss and steel arch bridges were designed in detail. SAP2000 software was used to support the calculation process. A Building Information Model was generated from the SAP2000 model to visualize the two alternatives. The bridge deck and the supporting bridge structure were also designed using cast-in-place reinforced concrete.

THE REMAINDER OF THIS PAGE WAS LEFT INTENTIONALLY BLANK

2 Background

This chapter reviews bridge-related materials, designs and construction techniques in order to be able to later identify the most functional, cost effective and aesthetically pleasing means of providing what WPI wants from the structure. It also reviews the context for the development of this project at WPI.

2.0 Assessing the Need for a Bridge

The need for a bridge was assessed by WPI and relayed to our team through interviews as well as discussions with the general contractor for the parking garage.

2.0.1 Interviews

On September 12, 2012 we interviewed Fred DiMauro, the Assistant Vice President of Facilities at WPI, which proved to be incredibly insightful in helping establish set goals and objectives for our project. The notes taken during the interview can be found in Appendix B. The consideration for a pedestrian bridge arose because of the construction of the parking garage. An issue that arose was that a means of egress to campus must be accessible for all types of people, with disabilities or not. Currently, an open stairway connects the parking garage to the upper quadrangle. There is also an elevator at the newly constructed Recreation and Sports Center that can be used by individuals with disabilities to go from the lower level of the building and the parking garage to the 3rd floor at the quadrangle level. Given the gradual change in the configuration of the campus created by the construction of the new buildings the possibility arose to creating an alternative public access to the campus from the parking garage and to make access to the roof-top fields more convenient. These issues led to the initial talks between members of the Department of Facilities and the construction management company Gilbane to obtain initial estimates for a new pedestrian bridge that would connect the parking garage to the center of campus.

Mr. DiMauro explained that two complications arose after receiving estimates from design. The height underneath the bridge must be able to accommodate a fire truck, and that the bridge must be able to support vehicles, such as snow removal equipment and small trucks for transferring equipment on and off the fields.

Mr. DiMauro also explained that snow removal equipment, and other vehicles can easily enter onto the athletic field from Park Avenue, via the highest elevation from the street level. While not ideal, this temporary access can function until the bridge is fully constructed.

To continue with this bridge design, Mr. DiMauro explained the process on how money is allocated to fund a project from the trustees. Firstly, the need is recognized it is brought to the attention of the Board of Trustees by the President of the university, Dr. Dennis Berkey, and by the administration to consider development and funding of the project. Trustees receive information and consideration on why said project is a priority, while weighing in on other campus needs and project options.

Deliverables that Mr. DiMauro would be glad to see from the outcome of this MQP are, BIM Model of proposed Bridge with a walk around 3D view, design features, site plan with structural detail, cost estimates, and scheduling with construction timetables.

2.1 Site Layout

The initial site layout data was provided by a survey taken by VHB (Vanasse Hangen Brustlin) Inc. the site engineer for the parking garage facility. An excerpt from VHB's grading, drainage, erosion control and sedimentation plan for the garage and athletic field is below showing an overview of the proposed pedestrian bridge site (Figure 2). The location of the start and end of the bridge was specified by WPI. The reasoning behind the location of the start of the bridge is that it is located above a main entrance and near to both the stairs and elevator. The end of the bridge is located atop of existing loading dock for the Harrington Auditorium which leads to an existing pathway connecting to the center of campus.

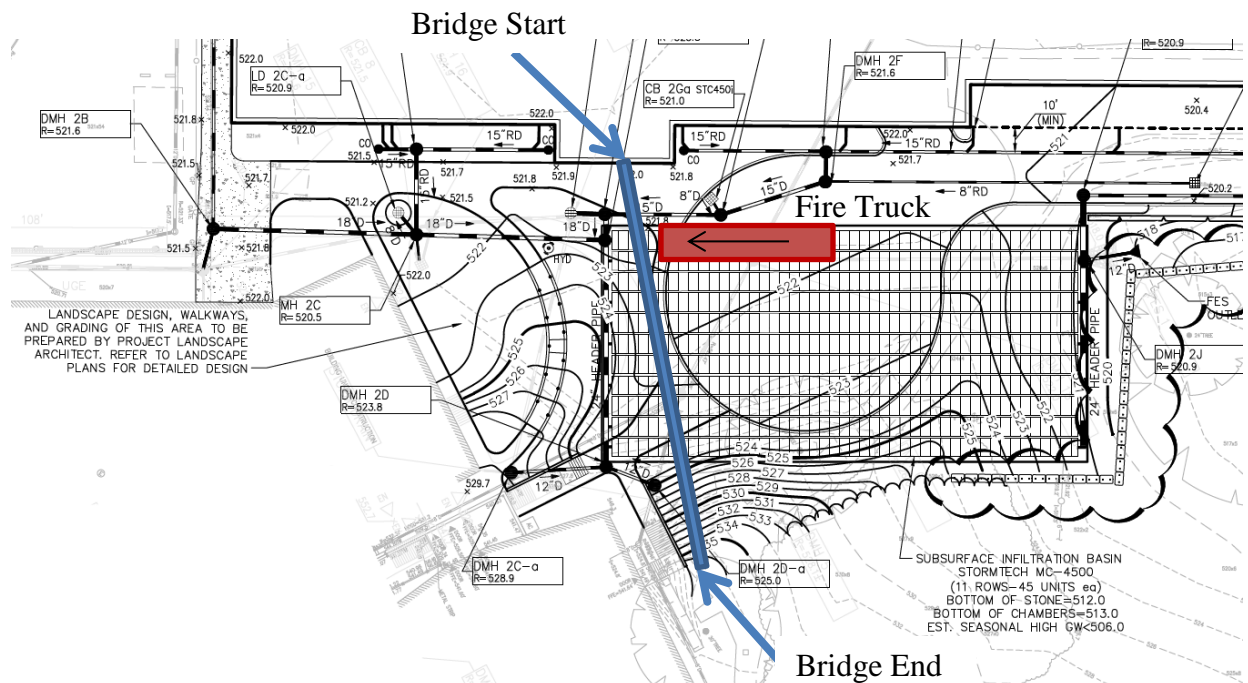

Figure 2: Overview of proposed pedestrian bridge location

This site plan should be a close approximation of the initial conditions for the proposed pedestrian bridge, but should be verified by as-built plans before a final design is considered. The proposed bridge will span approximately 160'. As seen above the bridge span will come in close proximity to the access road circle, but will not cross over it. The main issue with the existing conditions is the location of the subsurface infiltration basin, which consists of a series of perforated 8' diameter pipes which house the runoff from the recreation center. These will not be able to support any mid-span piers and therefore will need to be partially removed in order to place a center pier.

The approximate elevation details have been obtained from the architectural plans for the new garage prepared by SMMA (Symmes Maini & McKee Associates). Below are excerpts from SMMA's architectural plans and sections depicting an elevation of the main stair (Figure 3) and a plan view of the main stair at the field level (Figure 4).

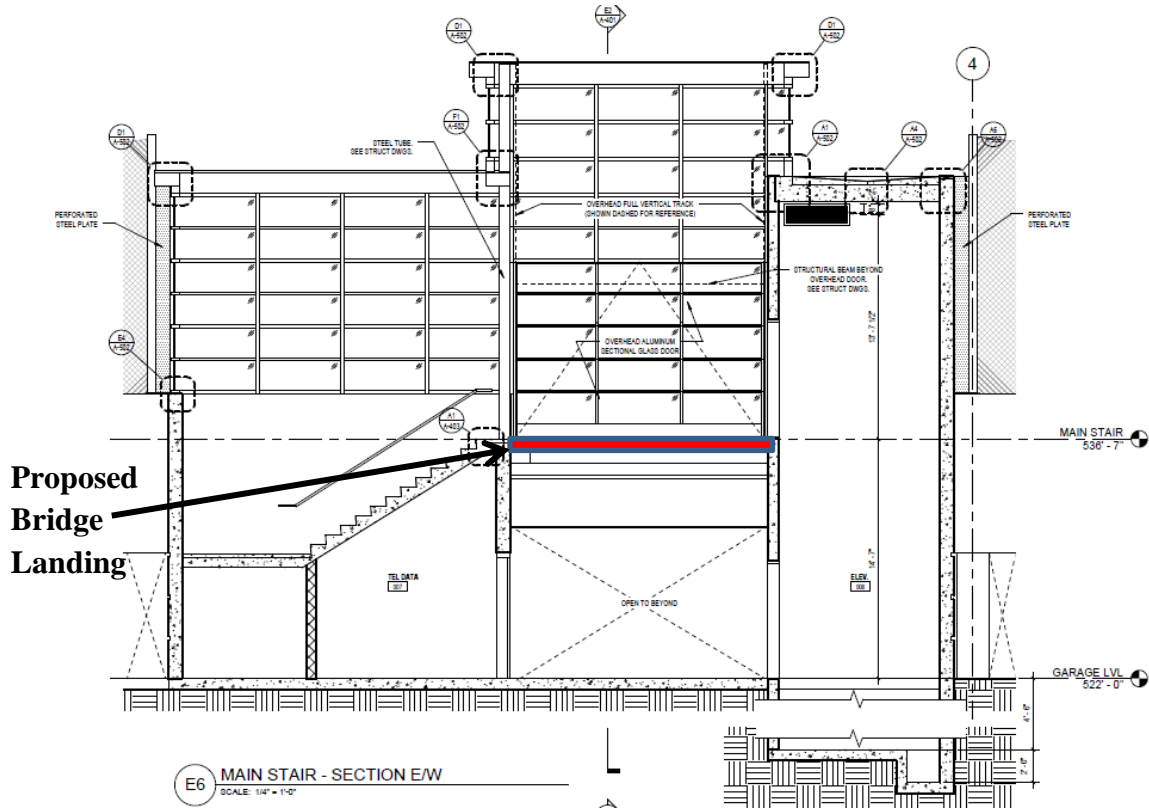

Figure 3: East/West Section of Garage Main Stair

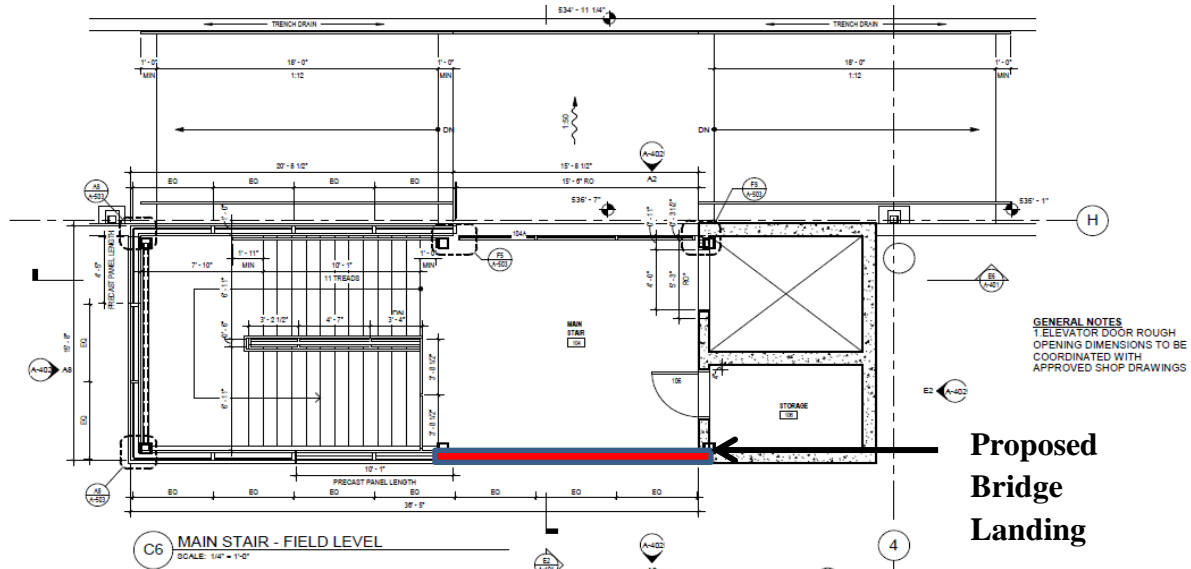

Figure 4: Plan view of Main Stair at Field level

The proposed bridge will rest in the opening between the steel columns that house the elevator shaft and the staircase. From these plans, we determined that this opening has a width of 15' 6" and is at an elevation of 536' 7". According to AASHTO the minimum pedestrian bridge width is to be 8' 0", which will constrain the bridge width to 8' - 15' 6". The proposed location is highlighted in Figure 3. In addition, the garage-side elevation forms the constraint for the elevation of the other end of the bridge; because of ADA (Americans with Disabilities Act) regulations with cite a maximum grade of 5.0% for wheelchair access. This means that over a span of 160' the bridge must fall within 536' 7" \pm 5.0% (8' 0"). We use this to determine where the bridge will land on the loading dock in order to not exceed maximum grade and minimize the required length of the bridge. Below is an excerpt from SMMA planting plan which shows the detail of the loading dock and proposed grading (Figure 5).



Figure 5: Planting plan showing the existing detailed grading

As seen above, the top of the loading dock falls at an elevation of 541' which will be well within the ADA required 5% grade and minimizes the width in which the bridge must span without excessive additional grading.

One final site layout consideration that must be met is that the bridge must accommodate fire trucks to mount the curb of the access road and drive under the bridge to access the west side of the New Recreation Center (See Figure 2). The international fire code calls for a clear height of 13' 6" and a width of 12' to account for the truck width of 8' and 4' of hose lying. These are key parameters and will define the type of bridge as a whole. As seen in figure 5, the minimum grade below the proposed bridge will be 522' 0". This 522' contour comes within approximately 25' of the garage, which will leave sufficient space on or below the minimum contour once the garage-

side foundation and piers are installed. See Table 1 for a complete list of all dimensional parameters for the proposed bridge.

Parameter	Minimum	Maximum
Length	No Constraint	
Width	8'0"	15'6"
East Elevation	528'7"	544'7"
West Elevation	536'7"	
Truck Clearance*	0'0"	1'1"
Grade	-5.00%	5.00%

Table 1: Design Parameters

*Clearance is based off of ideal low grade and is measured to the deck top. Decking and member thickness are to be accounted for below in section 4.01.

2.2 Materials

In this section we review and analyze various construction materials to assess whether or not they will be appropriate for use in the proposed bridge.

2.2.1 Concrete

Modern concrete was developed in the mid-18th century and has resultantly become one of the most important and highly utilized contemporary building materials. Formed by a chemical reaction, called hydration, concrete forms a unique material which gets harder over time. Concrete can be broken down by the sum of its ingredients; aggregate, cement, water and chemicals called admixtures.

Aggregate is typically classified in two forms, coarse aggregate and fine aggregate. Coarse aggregate consists of gravel and crushed stone, while fine aggregate typically consists of silt and sand sized particles. The ratios of these ingredients can be a key factor in the resultant compressive strength of concrete. To account for this, aggregate is usually separated and classified according to the amount which fits through a series of sieves. Size is limited by two key factors; workability and rebar spacing. Workability is classified as the ability of the concrete to move around and flow which is very necessary in order to be pumped to the job location as well as fit into forms on site. Similarly, aggregate size is limited to less than the minimum spacing of the rebar used to reinforce the concrete because otherwise the concrete would leave large voids, compromising the structural integrity of the finished structure.

Cement acts as a binder for the aggregate through the chemical process of hydration. Commencing as soon as Portland cement gets wet and continuing indefinitely, this process provides a strong chemical bond which makes concrete's strength possible. Concrete is typically considered to be cured 28 days after pouring, but this only represents 90% of the potential compressive strength and is usually sufficient to support the necessary loadings. Curing must be done in a controlled environment in order to prevent structural cracking. Abnormally fast drying

can cause tensile failures due to the uneven nature of the curing process. To counteract this problem, it is important to control the moisture, usually using a system of hoses and plastic sheets to keep the surface moist.

Water is the key ingredient in concrete and the ratio of water to cement helps determine the final strength of the concrete. The rule of thumb is to add the minimum amount of water necessary to ensure that all of the cement gets wetted and also so that the concrete remains fully workable until it is set in its forms. The water/cement ratio can range from 0.3 to 0.6 in most concrete formulas. Without enough water the concrete may harden prematurely and leave voids in the finished product. Too much water will weaken the compressive strength of the concrete and could result in structural failures.

Although concrete is traditionally a composite of aggregates, cement and water, various admixtures have been developed over time to improve and adapt concrete to fit different needs and environments. Admixtures are known to accelerate and retard the curing process depending on the extreme needs of a job site. In addition, air entrainment is common which is used to add air bubble to the concrete which help absorb the impact of thermal expansion and reduce cracking. There are also plasticizers and pumping aids which can help increase the workability of the product. To suit certain environments there are also corrosion inhibitors and bonding agents. Lastly there is the ability to add pigment at the mixing stage which adds an architectural detail which results in a smooth uniform finish.

Concrete has become one of the most utilized building materials because of its superior properties, primarily its compressive strength which typically ranges from 3,000 to 5,000 psi. Many different forms of concrete exist which have significantly higher or lower strengths but that value is most commonly used. Concrete is also known for its durability, fire resistance and low coefficient of thermal expansion. Lastly, concrete has the ability to be put into decorative forms which can add character in addition to pigment.

In contrast, concrete is very weak in tension and is resultantly reinforced with steel when necessary. Steel rebar is often bent and tied into place within formwork before pouring concrete so that a composite material is formed which has both high compressive and tensile strengths. Another way in which concrete is strengthened is by pre-tensioning cables along a beam and allowing the concrete to set. This pre-stresses the materials and allows the concrete to be used effectively as a beam. The other large weakness of concrete is water invasion. When water gets into small cracks and freezes, it can wedge to form larger cracks which are known to be structurally compromising. In addition, water serves to corrode any steel reinforcement. As a result any methods of reducing water invasion can be very beneficial to the long term strength and durability of any concrete structure (Neville 1995).

2.2.2 Steel

Steel is another commonly used material in modern construction. When it comes to the design of bridges, steel offers many attractive advantages. One of the most important advantages gained through the use of steel is its high strength to weight ratio. This may be a crucial advantage when it comes to the design of the new pedestrian bridge. This superior ratio could have many positive impacts on the design of the bridge. One of the most important factors that the high strength to weight ratio could impact is that it will allow the bridge to carry a greater load for a shallower depth. Since we are tightly constrained on the bridge depth due to fire code requirements, this would be an ideal material to utilize because it can transfer a greater load at a shallower depth. Additionally, the transportation and placement of the beams required may be easier due to their low self-weight. Steel may also contribute in the reduction of construction time. During bridge construction one of the exits/entrances to the new parking garage will need to be closed as well as the stairway located between Harrington Auditorium and the new recreation center. It is easy to see why the closing of this area for an extended period of time during the WPI school year would be unfavorable. With many of the components of the bridge being prefabricated, construction time would be greatly minimized. There have even been bridges installed in as little as one night. For example, figure 6 is an image of the Hallen Bridge which spans 81' over the M5 motorway in Great Britain. The bridge was prefabricated in sections which were shipped to a site near its final location. The sections were welded together on the ground, and then jacked into its final position during one overnight closure of the M5 motorway in 1994. This bridge clearly demonstrates the advantages of steel in terms of rate of construction.



Figure 6: Hallen Bridge over the M5 Motorway in Great Britain

Furthermore, steel is a highly useful material for bridge design not only from a material standpoint, but also from an architectural standpoint. Steel can be manipulated and fabricated into a wide variety of architectural shapes which can allow for more architectural and aesthetically pleasing features. Figure 7 shows the Merchants Bridge in Great Britain which illustrates how steel can be curved and shaped to form magnificent figures. This bridge, constructed in 1995, spans 220' over the Bridgewater Canal. It is comprised of an arch and box girder which is about 10' wide and only 1'7" deep.



Figure 7: Merchants Bridge, Manchester, Great Britain

2.2.3 Composite

In addition to steel and concrete, composites have seen rising consideration in bridge design.

Composites are mostly used as a reinforcement alternative to steel in reinforced concrete decks, but 100% composite decks and bridges themselves have been constructed. Currently, there are two different processes for the fabrication of composite bridge decks: sandwich

structures and adhesively bonded pultruded shapes. Pultruded composite decks are the least expensive fabrication technique. The main resins in composite decks tend to be either the lower



Figure 8: Common cross-sections of FRP decks from pultruded components.

costing polyester resins or the corrosive-resistant vinyl ester resins. Which resin is used depends on which characteristic is desired: low cost or corrosion resistance. Pultruded deck formations typically consist of, but are not limited to, four formations, seen in Figure 8. All of the deck formations typically have a dead load associated with them between 18 and 23 lbs./ft², are about 7-3/4” thick, cost about \$74/ft², and have a normalized deflection (HS20+IM for 2.4m center-to-center span) between L/325 and L/950 depending on the cross section (Zhou, 2002). Zhou suggests that the amount of deflection in different deck cross sections can be attributed to the process in which the bridges are designed, which is varied.

Composite bridge decks have been found to have a long service life in comparison to steel and concrete decks, which is an important and helpful feature of composites. Vistasp M Kabhari, Dongqong Wang, and Yanqiang Gao studied numerous bridges in the US and found that while bridges last, on average, for 68 years; however, their decks tend to last for only 35 years. Although this considers vehicular bridges and not pedestrian bridges, it is common acceptance that bridge decks need more maintenance and repairing than any other component of a bridge. Composite bridge decks are highly corrosion-resistant, which eliminates maintenance concerns from moisture and salt air. The longer service life and durability of composites can help lengthen the life of the bridge deck (Zhou, 2002). Composites also tend to have higher strength to weight ratios when compared to concrete and steel decks, and have a weight of about 80% less than cast in place concrete decks (Malvar, 2005). The lighter weight of the composite decks allow for better constructability, along with the prefabrication and ability to have the deck shipped completely or partially assembled. Unfortunately, one of the drawbacks of the composite bridge decks is their initial cost. Composite bridges decks typically cost about 4-5 times that of purely concrete decks, 4 times that of reinforced concrete decks and 2-3 times that of steel decks, when considering cost per ft². However, the high initial cost of composite bridge decks may be offset when considering the lower maintenance costs, but life cycle cost analyses of composite bridges have yet to emerge (Zhou, 2002).

2.3 Bridge Systems

2.3.1 Simply Supported Beam

Bridges designed as simply-supported have multiple characteristics that may be seen as advantageous. In the design phase, simply-supported structures are rather simple to design. Figure 9 shows the basic look of a simply-supported beam design. The loading on the bridge is transferred through the main beam, into the support piers, and then down into the ground below. As shown in Figure 9, the beam may require an additional support located in the center

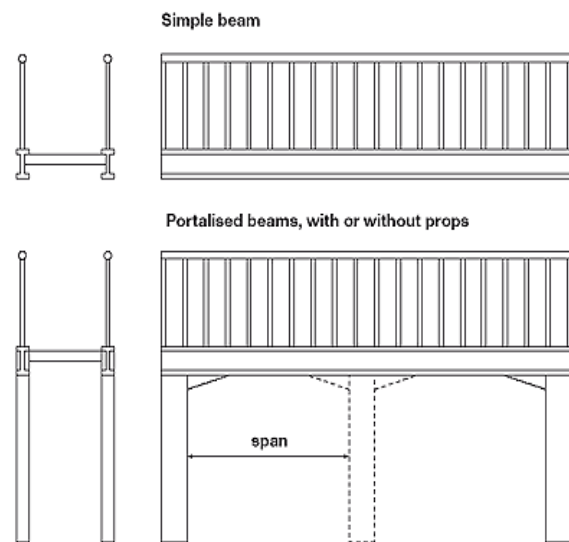

Figure 9: Basic Design Outline of Simply-Supported Beam Bridge

of the span if the span length is too long. This is due largely to the fact that a simply-supported bridge has zero rotation resistance. Simply-supported beam bridges tend to dip or sag around the middle of the span. This can be a major issue with bridges designed this way. It is also why these bridges can be more expensive. Since the bottom side of the span is sagging, it faces more tensile forces. Thus the structure must almost be made with either steel or pre-stressed concrete. Figure 10 is a picture of the aftermath of a bridge failure at Lowe's Motor Speedway in Charlotte, North Carolina. Investigators have reported that "the bridge contractor, Tindall Corp, used an improper additive to help the concrete filler at the bridge's center dry faster. The additive contained calcium chloride, which corroded the structure's steel cables and led to the collapse" (The Associated Press, 2006). Once the additive has corroded the structures steel reinforcing cables enough, the structure failed as the concrete could not resist the tensile forced caused by the sagging of the bridge. Although this isolated incident was an issue with material design, it illustrates how vulnerable certain types of bridges can be to material mistakes and defects. Although simply-supported bridges can be simple and cheap, both of these solutions would be unfavorable for the new pedestrian bridge. The depth required by this type of bridge makes it virtually impossible for the given layout as it would create far too small of a clearance for the fire code requirement. In addition, a middle support pier will add cost and complication to the project. Lastly it was chosen as the least aesthetically pleasing design choice.



Figure 10: Simply-Supported Pedestrian Bridge Failure, Lowes' Motor Speedway, North Carolina

2.3.2 Truss

Bridge trusses were developed as an economical and practical way of meeting the needs of America's expanding train system in the 18th century, although they have earlier roots in Europe for similar purposes. They are derived from a series of triangles, which happens to be the only shape which will maintain the angles between members when you fix the length of the members. This unique characteristic produces the strength of the design in general.

Because of the stresses on the members of any truss they are typically constructed out of materials with high tensile strengths. Initially they were constructed out of wood, but as iron was developed into steel, steel became a more popular material for the construction of trusses. More recently, especially in the case of pedestrian bridges, prefabricated trusses have become more popular. This way a bridge is constructed economically and safely under controlled conditions at a factory. Afterwards it is simply lifted into place using a crane, which minimizes onsite costs. Prefabricated bridges were initially developed by the British military in the 1930s and eventually found their way into commercial bridge manufacturing.

There is a lot of terminology related to understanding truss bridges which allows for analysis. First, trusses can be classified as planar, which means that all members fall into a 2 dimensional plane, or special which means that members venture out into 3 dimensions. The point of contact between members is called a node. For the purpose of analysis, nodes are considered to be simple pins which cannot create a moment between members, but in reality these connections can exert a small moment. Stringers are the members that connect parallel trusses and typically act perpendicularly to the direction of travel. Stringers also provide support for the floor beams which subsequently supports the decking. Struts and bracing help prevent torsion between parallel trusses by providing diagonal bracing against wind and seismic loads. The upper edge and lower edge of a planar truss are referred to the top chord and bottom chord respectively. Any other diagonal members in the truss are considered web members which help distribute the load.

Simple analysis of truss bridges can be completed through static analysis of Newton's laws. In reality a bridge is rarely a statically determinate system and must be analyzed as such. This is where software comes in to help quickly and accurately analyze the viability of different designs.

There are countless examples of different truss types which can excel in different situations and loadings as seen below in Figure 11.

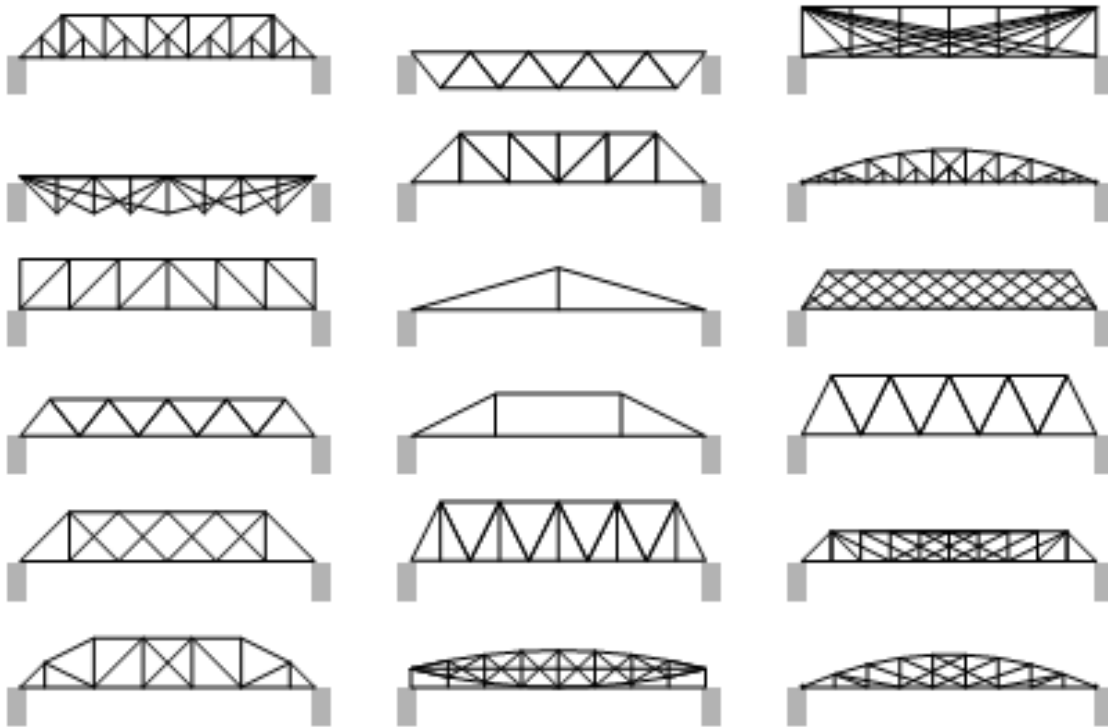

Figure 11: Various types of truss designs

In addition some bridges use a pre-cambered design to counteract expected loads and reduce sagging. To reduce sway from wind and seismic loads in pedestrian bridges it is important to keep the ratio of width to span above 1:20 (Comp 1977).

2.3.3 Arch

Arch Bridges have a very long history; the advantages of the arch shape were discovered by the Sumerians around 4000 B.C. and soon were applied to bridges to overcome obstacles. The Arch shape is described as a curve. Some common nomenclature associated with arches is listed below in Figure 12.

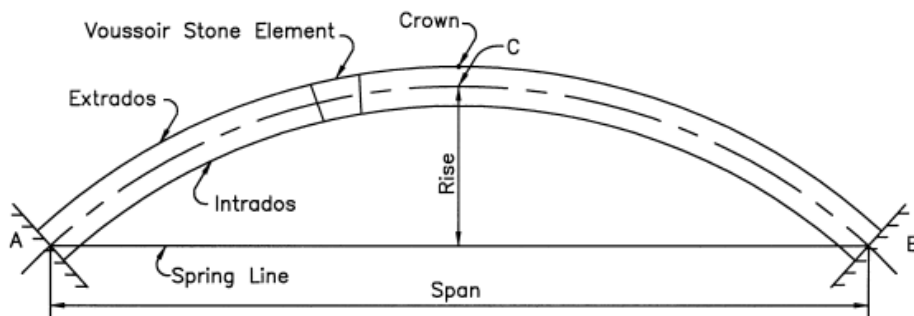

Figure 12: Arch Nomenclature

We found arch bridges to have many advantages, mainly in their simplicity of shape. Arch bridges are very competitive with truss bridges in terms of cost for spans up to 900 feet, making the arch bridge cost effective and economical (Fox, 2000). Furthermore, creating an arch bridge for the short span would be relatively simple to design. After calculating moments and axial forces, the correct proportions for the deck, ribs, ties, hangers and columns can be gathered.

Some disadvantages with arch bridges are that a very stable foundation is required because of the large horizontal forces applied from the arch shape. In addition, the curvature of the arch is complex to form because the precast steel or concrete must fit the shape of the curve to prevent possible buckling of the bridge.

There are many different types of arch bridges, each with unique benefits for a particular situation. Some common variances are seen below in Figures 13, 14, 15 and 16.

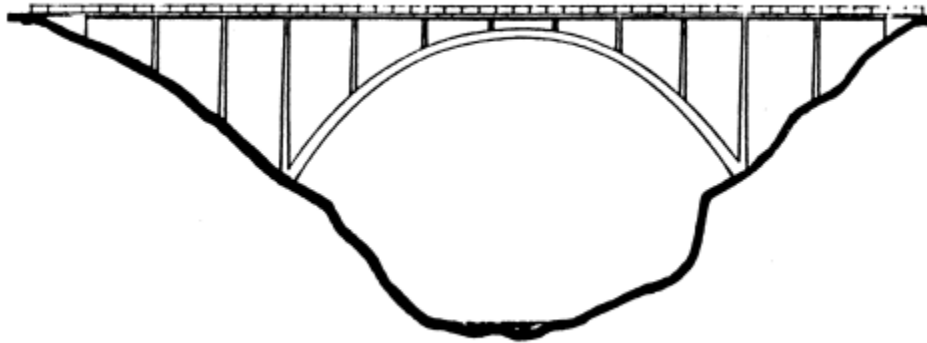

FIGURE 17.2 Concrete true arch.

Figure 13: Concrete True Arch

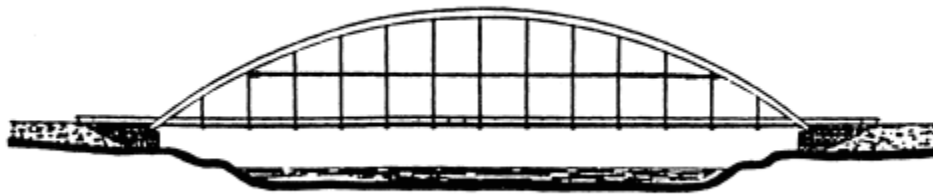

FIGURE 17.11 Horizontal cable connecting hangers.

Figure 14: Horizontal Cable Connecting Hangers

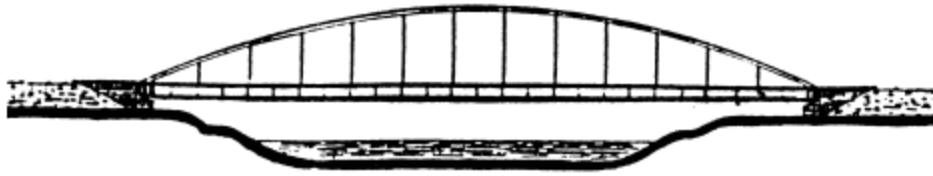

FIGURE 17.3 Steel tied-arch bridge.

Figure 15: Steel Tied-Arch Bridge

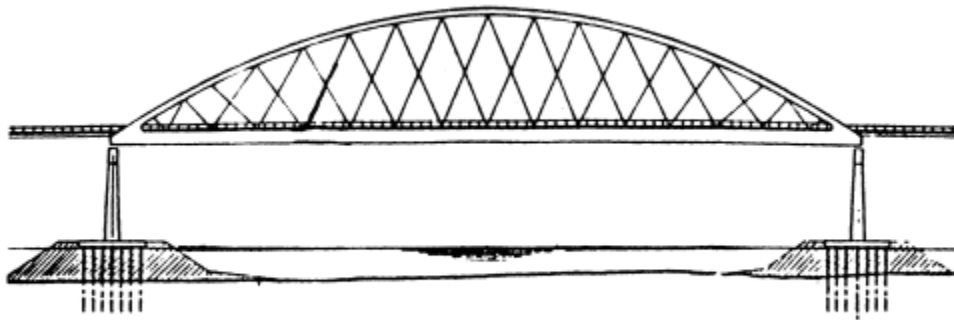

FIGURE 17.4 Arch with diagonal hangers.

Figure 16: Arch with Diagonal Hangers

2.3.4 Cable-Stayed

Cable-stayed bridges have several key components when considering their design: their spans, cable system (and its connection), towers, and superstructure (deck). Cable-stayed bridges generally consist of two-spans, either symmetric or asymmetric, three-spans, or multiple spans. The asymmetric 2 span cable-stayed bridge has a large span that is 60-70% of the total length of the bridge and with more than 2 spans; the center span of the bridge tends to be 55% of the total length. One additional way of designing the span of a cable-stayed bridge is to have the back stays anchored to “dead-man” anchorage blocks, and only one span is supported by stays” (Podolny Jr.). The cable system can be constructed in a variety of configurations in both the transverse and longitudinal directions, which can be observed in Figure 17 and Figure 18

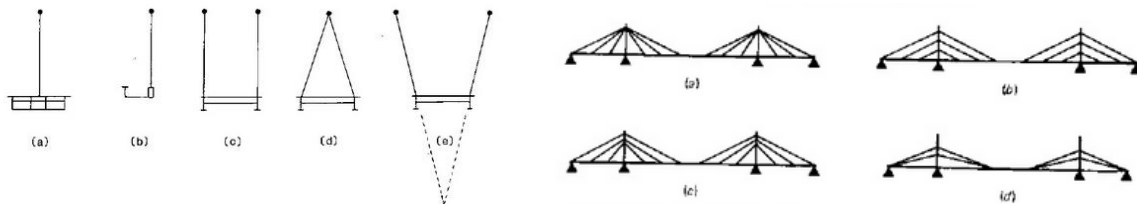

Figure 17: Transverse Cable Arrangements Figure 18: Longitudinal Cable Arrangements

respectively. The double plan configurations have the advantage of locating the cables either on the outside or within the limits of the pathway. However, they may require additional reinforcement for the eccentric cable loadings into the main girders and there is a need for additional deck width for anchorage fittings. Although there are no real advantages and disadvantages for the different cable arrangements, the general advantage of the cables comes in the number of cables utilized. When more cables are utilized to simplify cable anchorages, it generates a more uniform distribution of forces. In addition, more cables leads to a shallower girder depth and increased stability of the bridge against wind forces. However, more cables cost more money which is important to keep in mind. The towers may act as either single or double cantilevers (depending on whether single or double plane cables are used). The difference between single and double cantilevered towers is that single cantilevered towers stay within the vertical planes, while double cantilevered towers ‘lean’ out of plane. Single and double plane cables follow a similar rule, where single cables are purely vertical and double plane cables have an angle to them. The design of the towers themselves must consider two main components: the base and the frame. The base of the towers can be either fixed or hinged. Fixed bases induce large bending moments at the base of the tower, but offer increased rigidity of the total structure and can be more practical to erect. Hinge-based towers need to be externally supported until the cables are connected. The frame of the towers is typically designed in three basic ways: Modified A-Frame, Diamond, or Modified Diamond or Delta, seen in 19. The design of the frames can be mostly considered based on aesthetics; however, the diamond and modified diamond or delta frames offer additional height clearance and less pier width compared to the modified A-frame tower. The tower heights are usually 20% of the length of the main span, although this can vary depending on the specific bridge (Azamejad, McWhinnie, Tadros, & Jiri, 2011). The bridge deck depends on the material chosen (concrete, steel, or composite). Each has their own advantages and disadvantages; however, the advantage that cable-stayed bridges offer for the bridge decks a higher span to depth ratio. Although the ratio itself is highly variable (due to the number of cables used, materials, etc.), the ratio for two span asymmetric can be 100 by anchoring back stays to the girder directly over the piers, and in general, bridges that are double plane with multi-stays have a ratio between 120 and 260 (Podolny Jr.).

Although cable-stayed bridges are more commonly used when bridges need to be lightweight (poor soil conditions or large spans), they can be considered for short pedestrian bridges (Godden, 1997). Cable-stayed bridges offer additional clearance compared to girder bridges because they eliminate the necessary piers of the simply supports bridges. Although aesthetics is always a matter of opinion, cable-stayed bridges are typically considered more aesthetically pleasing and they have numerous options for the design of the cables, allowing for more variability in appearance. The span moments can be

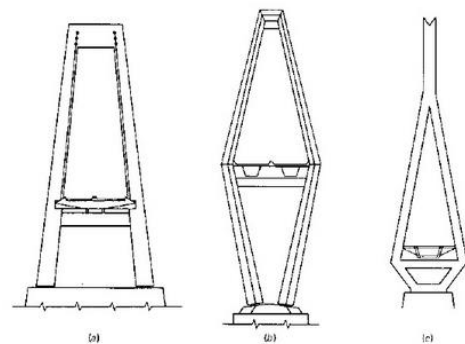

Figure 19: Tower Configurations

controlled by the spacing of the cables to make the moment along the span more uniformly distributed (Podolny Jr.). Due to the added cable forces in the cable-stayed bridges, large connection and girder support is needed to accommodate the cables. Design considerations must also include wind loads due to the one way support of the cables which can result in significant movement to the bridge deck if the deck is not restrained properly. Cable-stayed bridges also tend to be more expensive than a truss or simply supported bridge, especially in areas in which contractors and engineers don't necessarily have the expertise in cable-stayed bridge design or construction.

2.4 Design Criteria

2.4.1 Americans with disabilities Act (ADA)

One of the requirements of any structure designed and constructed in the United States is to comply with the regulations set forth by the Americans with Disabilities Act (ADA). The ADA was recently updated in 2010 and these updated standards must be complied with if the start of construction date is on or after March, 15, 2012, which will be the case for our bridge. In the updated standards, the requirements applicable, or may be applicable consist of sections 302.3, 303.2, 303.3, 303.4, 305, 307, 402.2, 403, 404, 405, 505, and 609.8.

Section 302.3 and section 303 consists of details regarding the walking surface of the bridge, stating that the walking surface shall be “stable, firm, and slip resistant.” 302.3 states that if there are any openings, such as a grated surface, the openings shall not exceed ½”. Sections 303 state that there shall be no vertical change greater than ¼”. The surface may be beveled between ¼” and ½” with a slope no greater than 1:2 if need be. If the surface is to be ramped (change in height greater than ½”), the surface must comply with sections 405 or 406, which ultimately state that ramps with a rise of greater than 6” must have handrails installed.

Sections 402 and 403 deal with the limitations of the walking surface, such as the running slope shall not exceed 1:20, the cross slope shall not exceed 1:48, and the clearing width for each lane of travel shall not be less than 60” (which means our bridge must be able to support 10’ for the expected 2 directions of travel). Section 505 deals with the application and design of the handrails, stating that they must be continuous along the entirety of the walking surfaces length. Additionally, the handrails must be 34-38” above the walking surface and have at least 1-1/2” minimum clearance between the rail and any adjacent surface. The gripping surface of the handrails must also be unobstructed for at least 80% of its length (with a 1-1/2” minimum bottom clearance when obstructed) and shall be free of sharp or abrasive elements. The handrails shall have rounded edges and, if circular, have an outer diameter between 1-1/4” to 2”. If the handrail is nonrectangular, the perimeter shall be between 4 and 6-1/4”, but with a cross-section dimension

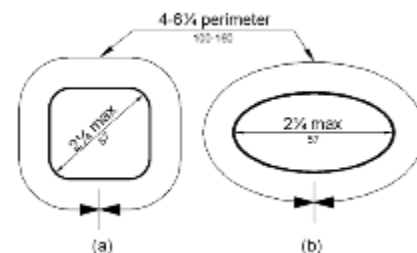

Figure 20: Noncircular Handrail Cross Sections

not exceeding 2-1/4” (as seen above in Figure 20). Section 609.8 states that the allowable stress in the handrails “shall not be exceeded for the materials used when a vertical or horizontal force of 250 pounds is applied at any point on the handrail, fastener, mounting device, or supporting structure. Section 505.9 further states that the handrails shall not rotate (Department of Justice, 2010).

2.4.2 Aesthetics

It is important that the bridge fits into the existing landscape and does not seem overly intrusive. To achieve this, the design of the structure must match the architectural features of the adjacent buildings as seen below in Figure 21 and Figure 22. The aesthetics of nearby buildings can be summarized as brick, concrete and glass. It will be important to not only match these materials but also the feel that these materials give. The current area does not have visible steel which means that any steel might seem out of place. One way to address this would be to consider a thinner structure which flows with the landscape rather than dominating it.



Figure 21: Looking Towards the Loading Dock



Figure 22: looking Towards the Parking Garage

Since WPI is a science and engineering university, there is also potential for an architecturally significant or structurally significant design. This could make the bridge less of an object fitting into the existing landscape and more of a landmark for the school.

2.4.3 Site & Constructability

Constructability is an important factor when considering design parameters for the proposed pedestrian bridge. We must also consider how long construction will take and how it can be scheduled to avoid conflicts with academic and sporting activities. In, addition there is a concern that the access road to the garage may need to be temporarily closed during parts of construction. These are important questions that need to be answered. It is in the best interest of WPI for construction to take place during the summer months, between the months of May and August, when majority of students and faculty are away from campus and pedestrian traffic will be at a minimum since the main entrance to the garage and field lies directly under the proposed location of the bridge. If possible, the design team should select a bridge that will be able to be constructed in this window. In addition, the garage access road ends at a turn-around right before the proposed bridge, so only a partial closure of the turn-around should be required. The turn-around could be used for staging of construction material as well as a stable area for a crane

during erection of the superstructure. Although the access road provides egress to the North, there is very little access from the east and almost no access from the south and west due to the adjacent buildings and running track. It is a very tight site and must be able to accommodate traffic and student athletic uses during construction. In addition the construction cannot block off fire access to the new recreation center.

2.4.4 Economy

A major design parameter in our research for a bridge is the budget. Currently, there is no set budget for this project because there is no official bridge design chosen. However, initial estimates were given by Fred DiMauro, with \$300,000 USD allocated to the bridge, with \$1,000,000 being a maximum feasible cost for the bridge, promenade and site work. Alternative procedures will be investigated to decrease the cost of the bridge, such as looking into different designs, construction materials, and the construction processes.

2.4.5 Environment

Environmental impacts should always be considered during any construction. However, since the bridge will be located in an area that has seen 2 extensive construction projects, it is assumed that the construction of the bridge would have little to no additional impacts. Still, an environmental impact report would need to be considered if construction of the bridge were to be approved.

2.4.6 Fire Code

The Commonwealth of Massachusetts is the authority having jurisdiction over Worcester County, and with neither having a proper fire code for pedestrian bridges, it is advisable to follow the International Fire Code (IFC) under section 503.2.6 for Bridges which states:

“Where a bridge or an elevated surface is part of a fire apparatus access road, the bridge shall be constructed and maintained in accordance with AASHTO HB-17”.

This code calls for a clear height of 13’6” as well as a width of 12’0” for fire trucks (Code 2000). Worcester County considers this to be a fire apparatus access road, because in the event of a fire in the new recreation center, there would be no other direct access to the back of the building.

“Bridges and elevated surfaces shall be designed for a live load sufficient to carry the imposed loads of fire apparatus.”

The above excerpt from IFC suggests that the bridge should be able to support the weight of the truck, but according to Fred DiMauro, it is unnecessary to design for a Fire truck to travel over the bridge.

“Vehicle load limits shall be posted at both entrances to bridges when required by the fire code official”

The above excerpt from IFC will be important to keep in mind to designate the maximum allowed vehicle weight on the bridge.

It is vital to note that fire codes are considered somewhat flexible in that they should be adapted to the situations present. IFC is used as a guide, not an infallible law. The Worcester Fire Department will be required to sign off on all plans before construction, so design work should be coordinated to meet their needs in the event of a fire.

2.4.7 Geotechnical Concerns

An important concern that is pertinent to our bridge design is that there will be a bridge landing and foundation constructed next to the parking garage. Figure 23 below shows the area under construction in which the bridge foundation will be placed. There has to be a properly designed foundation that will withstand the vertical as well as the horizontal loads caused by the potential bridge. Without these, excessive settling, bridge failure and damage to the parking garage can be major concerns.



Figure 23: Garage in construction, showing area of interest for foundation

2.5 Design Tools

In order to expedite design, we need to utilize structural analysis tools to quickly iterate between designs, loadings and members sizes efficiently. Once we achieve a design we need to provide three-dimensional imagery for WPI. This can be used to evaluate the aesthetics as well as the functionality in the landscape.

2.5.1 Sap2000

We have selected Sap2000 for its diversified structural analysis abilities as well as its ability to convert through REVIT in an iterative manner. SAP (Structural Analysis Program) has existed

for many years and is considered a premium analysis software suite around the world. It has been used in many structures such as dams, bridges, and even the world's tallest building. The user interface is known to be intuitive, mirroring tools available in other CAD software for easy cross over. Sap2000 contains all applicable structural codes necessary to be accounted for in addition to a material library for quick changes and further analysis. SAP2000 can perform analyses based on deflection limits as well as failure modes and allows for analysis of different load combinations simultaneously.

2.5.2 BIM

Building Information Modeling (BIM) is a process developed into a software package which represents various systems of a building in three special dimensions. In addition, more recently a 4th dimension, time (4D BIM), has been integrated. This way 4D BIM allows the visual representation of both the construction and cost of the building as it is built in accelerated time. BIM allows for the expedited design of various buildings and structures with an integrated library of materials and structural components. We will utilize REVIT, a software suite owned by Autodesk, to design our bridge in addition to the site layout and adjacent buildings. This will save time on several levels. First, skipping the traditional time factor of two dimensional modeling will save time in constructing three dimensional renderings for WPI later and add the ability to visualize conflicts. In addition the structural data may be exported from SAP2000 for via an .IFC file, which can be imported into REVIT to create a detailed visual representation of the bridge and its surroundings.

THE REMAINDER OF THIS PAGE WAS LEFT INTENTIONALLY BLANK

3 Preliminary Design

Our design process began with our parameters from Section 2.1. With these ranges and all applicable codes from Section 2.4 in mind, we began to select proposed dimensions to begin design. The bridge length was constrained by the elevations as described in section 2.1, which we later verified by performing our own site survey (see section 3.2 below). The width was to be between 8'0" and 15'6" and we chose a width of 14'0" to accommodate larger vehicles and provide a significant looking promenade between campus and the fields per WPI's wishes. The elevations from Section 2.1 were constrained by existing site features and were later verified by our field survey. The final grade was calculated as +2.76% from the parking garage to the loading dock which is well within ADA's <5% requirement. The final proposed dimensions are summarized below in Table 2 along with the constraints from Section 2.1.

Parameter	Minimum	Maximum	Proposed
Length	No Constraint		160' 0"
Width	8'0"	15'6"	14'0"
East Elevation	528'7"	544'7"	541'0"
West Elevation	536'7"		536'7"
Truck Clearance	0'0"	1'1"	1'1"
Grade	-5.00%	5.00%	+2.76%

Table 2: Design Parameters

The process continued by selecting two bridge types as well as materials which is discussed below in Section 3.0. We continued by pulling information from the construction documentation provided to us by Gilbane for the garage and recreation center (Section 3.1). The next step in the process was to take our own survey data to provide accurate dimensions for analysis in Sap2000 described in Section 3.2. Lastly, we selected loadings and load combinations which we discuss below in section 3.3.

3.0 Selection Criteria

A number of criteria were used to determine feasible alternatives given the requirements and constraints provided WPI with the best solution. These criteria included; depth, cost, aesthetics, sustainability/maintenance, and constructability. Depth of the bridge superstructure is the most important aspect, because it constrains the entire design. Cost is also a major criterion as the project will likely have a budget of around \$1,000,000 USD (Section 2.0.1). The costs will include; cost of materials, labor, and transporting the materials. Aesthetics plays a major role as the bridge will be part of WPI's new promenade and main gateway to campus. The bridge must look worthy and cannot look out of place with the new recreation center located directly behind it. Aesthetics were measured by group consensus. Sustainability/maintenance is important as it would be favorable to use materials that will not need to be repaired constantly. Also, it is preferred that the material used be recyclable upon the end of its life-span. Finally, the constructability criteria favored alternatives and materials that were less time consuming to implement as well as less difficult to erect into position. See Table 3 below for our ranking of

each alternative. With 1 being the best and 4 being the worst, the rankings are purely relative to each other and are not quantifiable beyond their relation to each other.

Selection Criteria				
Bridge Type	←More Important		Less Important→	
	Depth	Cost	Aesthetics*	Maintenance
Truss	2	2	2	2
Simply- Supported Beam	3	1	3	1
Arch	1	3	1	2
Cable-Stayed	1	5	1	2
Arch-Cable Suspension**	1	4	1	2

Table 3: Selection Criteria

After this evaluation we decided to only continue with an arch bridge and a truss bridge. We discounted the simply supported bridge due to its excessive depth and lack of aesthetic appeal. In addition, we discounted the cable-stayed bridge because of outlying cost.

Materials were evaluated separately since not every material can be applicable to every type of bridge. Specific application and discounting of materials is discussed below in Section 3.3.

3.1 Construction Documents

We obtained construction plans for the new parking garage from Gilbane. These plans included site plans, drainage plans and foundation plans. In addition we obtained geotechnical reports that allowed us to determine preliminary soil characteristics on the site. We determined that the soil is of good quality with shallow bedrock, and also that the foundation for the parking garage should not interfere with the piers on the west end of the proposed bridge. The drainage plans show storm water infiltration pipes directly underneath the majority of the span of the bridge. After discussing with Gilbane, we determined that some of these could easily be excavated and removed if necessary in order to support a middle pier. In looking at the grading plans and evaluating the storm water infiltration pipe manufacturer’s specifications, we determined that the pipes were buried to the minimum allowable depth under the bridge, so any site work could not effectively lower the grade.

3.2 Site Survey

Although the project began while the Parking Garage was still under construction, the project team had the advantage of performing a site survey of as-built conditions, to ensure that the measurements recorded and assumed in the construction documents regarding the height and length from the loading dock at Harrington Auditorium to the elevator landing on the Parking Garage were accurate.



Figure 24: James DeCelle Conducting Surveying Shots



Figure 25: Here the bridge decking will meet the Parking Garage



Figure 26: The Bridge Decking will meet with the Loading Docks behind Harrington

The group used a benchmark in the parking garage that Gilbane referred us to. This allowed us to determine the height of the gun and record the angles of all subsequent shots, which would be used to determine the distances between points. The subsequent shots identified the left and right opening at the elevator shaft in the parking garage and the left and right connection points at the loading dock by Harrington Auditorium.



Figure 27 : View From Harrington, overlooking the construction Area, the Parking Garage is in the Distance

Once the information was recorded, a simple excel spreadsheet and the application of the law of cosines was used to determine the distances between the loading dock and the parking garage connection, as well as their heights. The results can be observed in the summary table in Appendix B.

The results were almost identical to the assumptions made from the construction documents, thus confirming the bridge's span and height requirements. The resultant distances are summarized below in Table 4.

	(FT)
Distance L-L	162.07
Distance R-R	154.30
Delta Elevation L-L	5.03
Delta Elevation R-R	5.14
Dock Width	18.01
Opening Width	15.57

Table 4: As-Built Survey Distances

3.3 Deflection & Load Requirements

As determined from our interview with Fred DiMauro and independent research, the clearance of the bridge must clear an estimated 13'6" tall fire truck. There is roughly a 30 foot area between the parking garage and the slope up to Harrington Auditorium that has a grade of 522', which is the same elevation as the garage floor. Our bridge will connect to the main stair area, which is located at an elevation of 536'-7". This gives us only 1'-1" of clearance, and, realistically, we are limited to a bridge depth no greater than 1'. Our site survey determined that the bridge must cover a maximum distance of 162'1". Preliminary checks over each type of bridge were performed to determine which bridge design options are viable for these conditions. The main check is a simple deflection limit check to determine the minimum depth of each bridge design, and those that are too deep were immediately deemed not viable. We then took the two remaining viable bridge designs and proceeded into advanced design for them below in section 4.1 and 4.2 using the following loadings.

The Load and Resistance Factor Design, (LRFD) was used to design all bridge members components and connections. The AASHTO Guide Specifications for Design of Pedestrian Bridges (2009) were used, along with any other AASTHO material referenced. Figure 28, as seen below shows the different load combinations as provided by AASHTO. The AASHTO *Pedestrian Bridge Design Guide* states that, for pedestrian bridges, strengths II, IV, and V may be ignored. Furthermore, the load factor for fatigue I load combination were taken as 1.0 (not 1.50) and fatigue II was ignored. The AASHTO design guide also specified the deflection limits for pedestrian bridges. They were investigated, at the service limit, using service I and may not exceed L/220 for cantilever arms, or L/360 for spans other than cantilever arms, due to the

unfactored pedestrian live load, which is specified as 90 psf. The vehicle live load was designed for strength I load combination and was not placed in combination with the pedestrian live load.

Load Combination Limit State	DC DD DW EH EV ES EL PS CR SH	LL IM CE BR PL LS	WA	WS	WL	FR	TU	TG	SE	Use One of These at a Time				
										EQ	BL	IC	CT	CV
Strength I (unless noted)	γ_p	1.75	1.00	—	—	1.00	0.50/1.20	γ_{TG}	γ_{SE}	—	—	—	—	—
Strength II	γ_p	1.35	1.00	—	—	1.00	0.50/1.20	γ_{TG}	γ_{SE}	—	—	—	—	—
Strength III	γ_p	—	1.00	1.4 0	—	1.00	0.50/1.20	γ_{TG}	γ_{SE}	—	—	—	—	—
Strength IV	γ_E	—	1.00	—	—	1.00	0.50/1.20	—	—	—	—	—	—	—
Strength V	γ_p	1.35	1.00	0.4 0	1.0	1.00	0.50/1.20	γ_{TG}	γ_{SE}	—	—	—	—	—
Extreme Event I	γ_p	γ_{EQ}	1.00	—	—	1.00	—	—	—	1.00	—	—	—	—
Extreme Event II	γ_p	0.50	1.00	—	—	1.00	—	—	—	—	1.00	1.00	1.00	1.00
Service I	1.00	1.00	1.00	0.3 0	1.0	1.00	1.00/1.20	γ_{TG}	γ_{SE}	—	—	—	—	—
Service II	1.00	1.30	1.00	—	—	1.00	1.00/1.20	—	—	—	—	—	—	—
Service III	1.00	0.80	1.00	—	—	1.00	1.00/1.20	γ_{TG}	γ_{SE}	—	—	—	—	—
Service IV	1.00	—	1.00	0.7 0	—	1.00	1.00/1.20	—	1.0	—	—	—	—	—
Fatigue I— LL, IM & CE only	—	1.50	—	—	—	—	—	—	—	—	—	—	—	—
Fatigue II— LL, IM & CE only	—	0.75	—	—	—	—	—	—	—	—	—	—	—	—

Figure 28: LRFD Load Combinations and Factors

AASHTO provided the weight distribution and dimensions of the design vehicle and require the vehicle to be placed to produce the maximum load effects. Because the clear deck width is expected to be 14' (in accordance with ADA regulations), design vehicle H10 will be used. Furthermore, due to the slenderness of pedestrian bridges, a vertical uplift live load of .02 KSF over the full deck width was applied (AASHTO, 2009). Additionally, a lateral wind load was applied to the bridge members and was calculated in accordance with article 3.8 in AASHTO's Bridge Design Manual, and the load value is specific to each bridge and its individual members. The fatigue live load was used as specified in the AASTHO design manual, section 11. Below, Table 5 shows the constant values used for each bridge design.

Load Type	Load
Pedestrian Live Load	90 PSF
Vehicle Live Load	20,000 LBS
Wind Load (V)	25 PSF

Table 5: Unfactored LRFD Design Load

4 Design & Analysis

4.0 General Analysis

Although there were two different bridge alternatives, the bridge decking and design loads were the same for both bridges. We narrowed down the material from steel, concrete, FRP and wood down to just concrete and steel for their durability, cost and availability in a variety of shapes and sizes. The simplicity of the decking and relatively short length of the bridge necessitated using a cast in place deck instead of a precast deck which would have been more expensive to produce for such a small custom job. In addition, precast panels would have necessitated the use of a crane to get them into position, adding to the equipment rental costs.

4.0.1 Bridge Deck Design

The bridge decking for both options shall be made of a simple cast-in-place concrete deck. This is largely due to the fact that a steel based decking would be less cost effective as the cost of steel is relatively large compare to concrete. The bridge decking will be composed of normal weight concrete (150 pounds per cubic foot, $f'_c = 4$ ksi) and #5 steel rebar ($f_y = 60$ ksi). The loads applied to the deck include; 90 pounds per square foot for pedestrians, 20 pounds per square foot to accommodate for vertical wind loads, 100 pounds per square foot for self-weight, two 10,667 pound loads to account for the maximum effective distributed weight on each axel of our design vehicle, and 25 pounds per square foot to account for a 2" wearing surface to go on top of the decking. The vehicle weight distribution was calculated according to Article 4.6.2.1.3 of AASHTO which states that the distribution width for positive moment is $(26 + 6.6 S)$ in. where S is spacing in feet. The maximum moment produced by the vehicle was found using Table 3-23 case 10 of the AISC Steel Construction Manual. The shear and moment diagrams from this case can be seen in Figure 29.

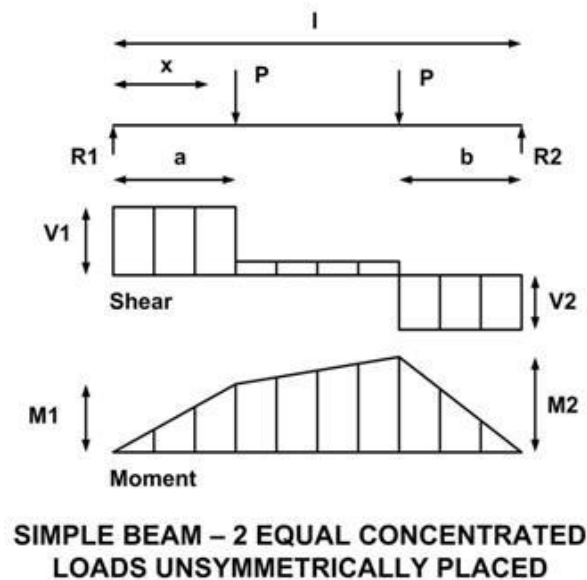

Figure 29:AISC Table 3-23 Case 10

The dimensions of the deck shall be 14' wide, about 160' long (cast to span entire bridge) and 8" deep. The top and bottom covers to the rebar shall be 2". The bridge deck is designed in a section with the dimensions of 14 feet x 1 foot x 8 inches deep. The deck is designed as a one way slab spanning 14 ft. The 1' length will be assumed to be duplicated for the length of the bridge span. The major governing factor is that the deck should be designed for its moment resistance. The maximum ultimate moment for the bridge (using AASHTO load combinations) was found to be 11,974 ft-lbs. For simplicity, this value was rounded up to 12,000 ft-lbs for hand calculations. Using this value and the assumed dimensions of the deck, it was found that the deck would require 2.83 #5 sections of rebar per linear foot. For simplicity and as good engineering practice, this value was rounded up to three #5 bars per foot spaced at 4" on center. The deck also requires temperature and shrinkage steel, spanning both the lateral and longitudinal directions. These bars will also be made from #5 rebar and will be evenly distributed between the top and bottom of the deck. Since the deck dimensions are relatively small, the spacing of the bars is governed by the maximum allowable spacing, which is specified at 18" O.C. This holds true in all areas except where there is already reinforcing steel, since there is an excess amount of reinforcement to cover for the temperature and shrinkage of the steel. Computer sketches of various sections can be seen below in Figures 30, 31 and 32. All detailed calculations can be viewed in Appendix K.

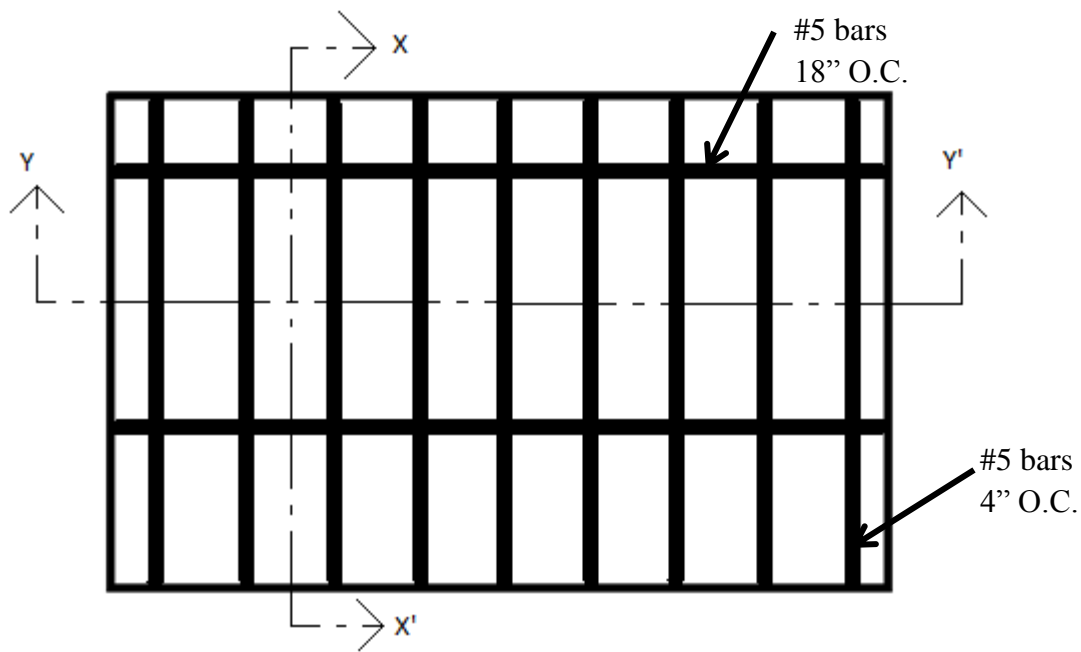

Figure 30: Plan View of Decking (Overhead)

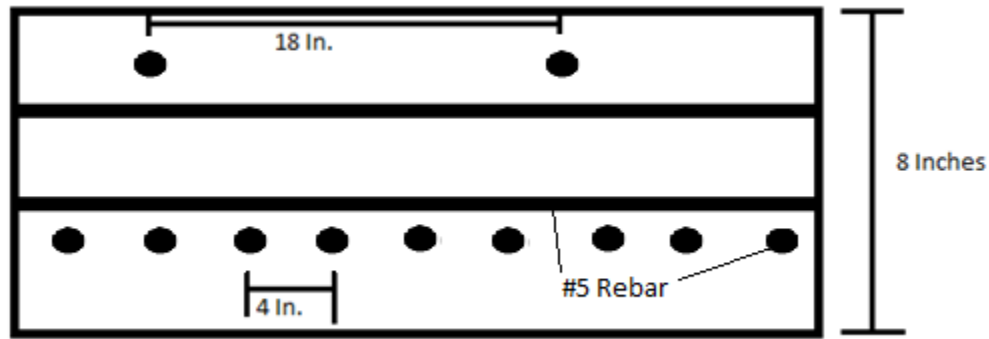

Figure 31: Cross-Sectional View of Decking in Y-Y' Direction

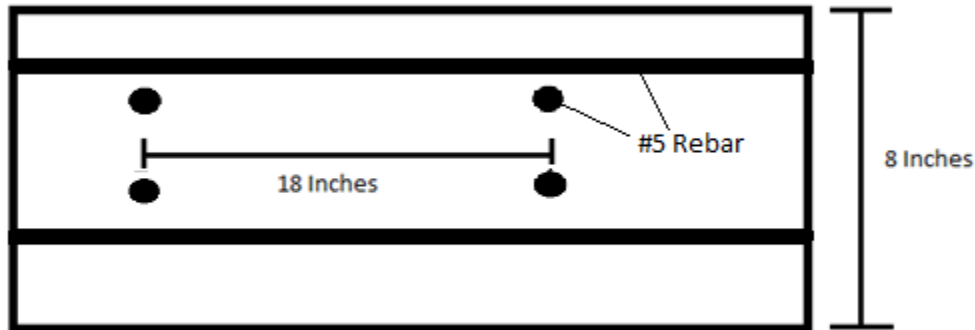

Figure 32: Cross-Sectional View of Decking in X-X' Direction

4.0.2 Bridge Load and Member Sizing

The bridge design is required to comply with the loadings set forth through AASHTO as previously discussed in Section 3.3. Additionally, a uniform dead load of 29lbs/linear foot was applied to account for the weight of the railings (Handi-Ramp, 2013). Finally, a uniformly distributed dead load was applied to account for the weight of the wearing surface. Multiple sources revealed that a 2" thick, concrete wearing surface is ideal for pedestrian bridges (Chen, 2003; Works, 2011). Due to the limitations of our version of SAP 2000 (educational version), surface areas could not be loaded. Instead, the bridges were analyzed in 2D. To account for this problem, the bridge was loaded with a uniform dead load to account for the weight of the concrete slab, which was calculated with the following formula:

$$(150 \text{ pcf}) * 8/12' \text{ (deck thickness)} * 7' \text{ (tributary width of each bridge girder)}$$

A similar process was used to account for the wearing surface. Since we evenly spaced floor members connection the sides of the truss and the arches respectively at 14', the pedestrian live load and vertical wind load were all multiplied by 7' to account for the tributary area that each floor member would support. The vehicle load was run along the girder. AASHTO allows for the load to be distributed via a factor due to moment redistribution through the bridge deck to both bridge girders. AASHTO calculates this redistribution factor through the Lever Rule shown in Section 4.1. The live load was then multiplied by this factor in each load combination. The

one loading that varied from each bridge alternative was the horizontal wind load. The wind load is calculated through several equations in article 3.8 of AASHTO. However, the different heights of the bridge members and the different bridge members' sizes are what vary from the truss and arch bridge (see sections 4.3 and 4.4 for more detail). Once the loads were defined and the values were calculated, they were applied to the bridge model in SAP. The H10 truck was created in the moving loads section of SAP, as seen in Figure 33. Then the moving path for the vehicle was defined, inputting the girder as the moving path. Then, load patterns were defined for the different loadings. A pedestrian live load, dead load, DW (wearing surface), wind, and H10 truck load patterns were defined, with a self-weight multiplier of 0 for all the cases. Once the load patterns were defined, the loads were assigned to each girder member.

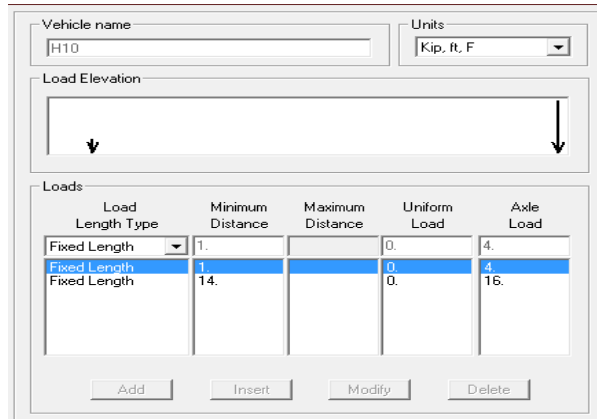

Figure 33: Vehicle Load as defined in SAP2000

To do this, the members to be loaded were selected, and then we went to:

Load Type	Load
Dead	729 PLF
DW	175 PLF
Pedestrian	630 PLF
Wind (V)	210 PLF

Table 6: Applied Loads

ASSIGN -> FRAME LOADS -> UNIFORM

then selected the load pattern that was desired (whether the dead load, DW load, pedestrian load), and then the value was entered in the uniform load value section. These load values can be seen in Table 6 at left. Once the loads were applied, the load combinations were

defined. The load combinations are the same ones that were defined in Section 3.3. Because the vehicle load is not to be combined with the pedestrian load, as defined in AASHTO's Pedestrian Bridge manual, multiple load combinations were created to account for whether the live load was vehicular or pedestrian. After the loads were assigned to the bridge members and the load combinations were defined, the analysis was run and the results were recorded.

The horizontal wind loading was defined by the height of the desired members and their sizes. Due to the different heights and sizes of the arch members as opposed to the girders, a horizontal wind load was calculated for each type of member. Due to the need for lateral restraint, this wind loading was calculated in a 3D analysis. The horizontal wind loads were combined with the load tables that contain any load combinations that include wind loads and the values from the horizontal wind load calculations were multiplied by the appropriate factor and added to the bridge member values. This was how the group integrated the 2D analysis with the 3D analysis necessary for calculating the horizontal wind loads. These tables were then used for further design calculations (Appendix C, Appendix G). Although the both bridges were loaded similarly, their design and design process varied due to member sizing requirements discussed below.

4.1 Truss Design

The truss was chosen as an ideal alternative due to the relative slimness of the deck, simplicity of design and variety of visually appealing designs available. A truss is able to span the full

distance as well as resist loadings within the allowed deflection. In addition to, and because of its geometric configuration, the truss converts its forces to almost fully vertical reactions. This means that the truss can sit on a pier on the side of the parking garage, which won't put much or any lateral force on the existing parking garage foundation. We chose a simple Pratt truss because the design is considered universally applicable and easy to solve analytically. A Pratt truss is composed out of any number of interconnected isosceles triangles as seen in Figure 34. To define the dimensions of the triangles, we utilized the customary target truss depth or 1/20 of the span. In addition, the customary rule for longitudinal division spacing is to keep the diagonal web members at 50-60 degrees off of the bottom chord. In addition, typical truss bridges over 100' feet in length require a full box frame section. See Table 7 below for a full summary of the constraints and guidelines for the truss.

	2 x 80' Spans	160' Span
Depth (1/20)	4.0'	8.0'
Division Spacing	10'	10'
Fully Boxed?	No	Yes
Allowable Deflection (1/360)	2.67"	5.33"

Table 7: Truss Guidelines

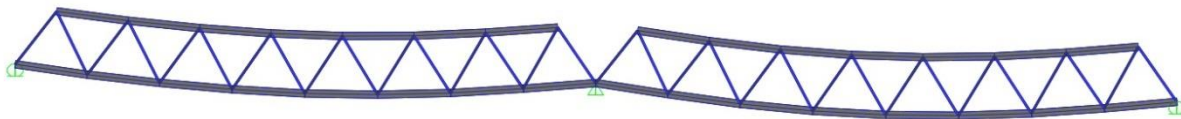

Figure 34: Double Span Pratt Truss, Showing Exaggerated Loading

We decided to proceed with design for only two 80' spans, because of the excess deflection in the single 160' span as well as the need to fully box the frame, which would restrict the height of vehicles and reduce aesthetics.

4.1.1 Deflection

According to AASHTO, deflections must be less than $L/360$ using the Service 1 limit state. The final deflections can be seen in the deflection tables calculated in Appendix G. The maximum deflection of the truss bridge was found to be in the center of each span.

4.1.2 Member Sizing

It is customary to use either square or rectangular tubing for steel pedestrian bridges. This helps with assembly and simplifies design. In addition the minimum thickness we analyzed for the steel flanges was $3/32$ ". This is because thinner steel is riskier due to deficiencies related to welding and corrosion. With this knowledge in mind, we proceeded to assign steel frame sections to the bridge and design it to meet the maximum vertical midpoint deflection in SAP2000. We assigned the separate sections for the bottom chords, top chords, web members, and members interconnecting the trusses. Figures 35 and 36 below show the section properties used for the bridge in SAP2000.

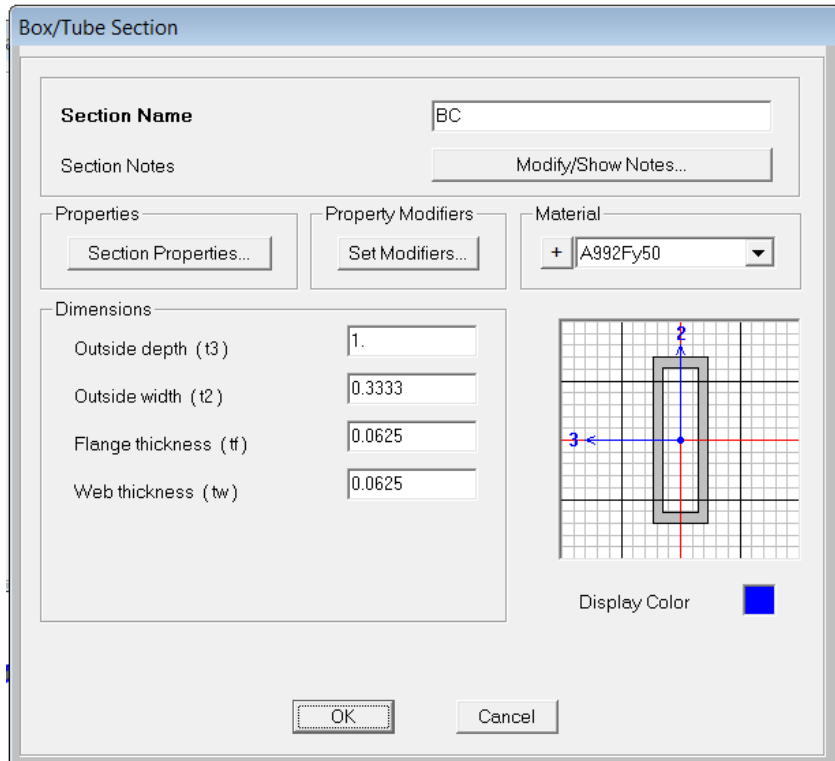

Figure 35: Sample Section of Top Chord and Bottom Chord

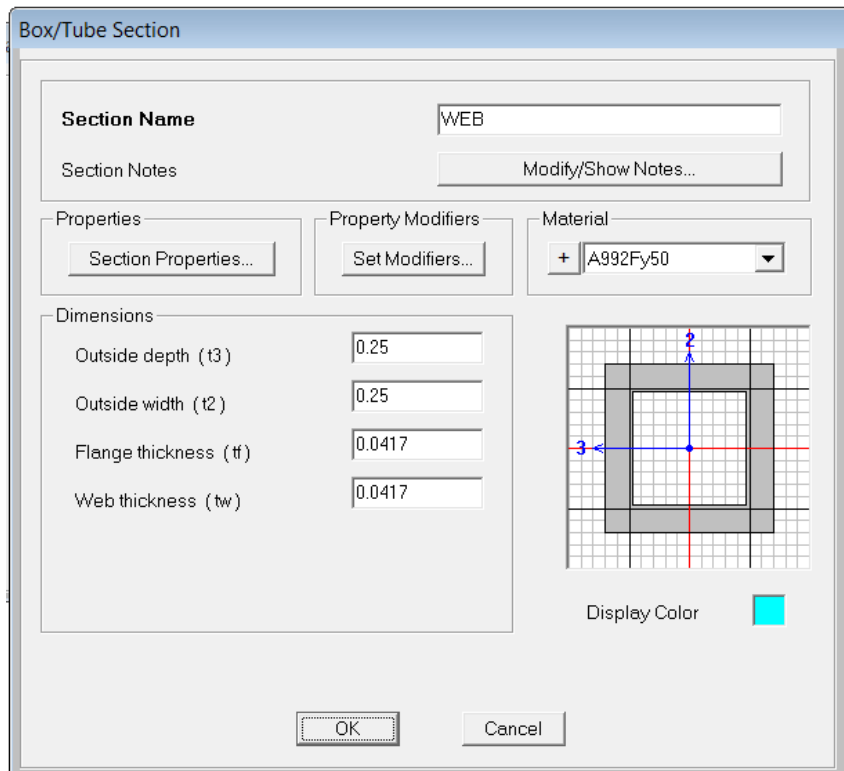

Figure 36: Sample Section of Web Members

These four different member sections were analyzed on both bridge lengths to produce the maximum allowable deflection with the least amount of material. It became apparent that we would need to overbuild the top chord because of the potential of buckling under compression forces instead of failure in tension. In addition we looked into potentially adding member redundancy so that in the event of one member failing, the bridge would not catastrophically fail. It became apparent that this would be far too costly. In addition, we decided to overbuild for lateral stability. We added diagonal cross members between both the bottom chords and top chord where applicable. Since these members are relatively small, they do not add very much to the weight and cost and yet provide a potential brace against wind and seismic loads. The member sizes were later evaluated in Microsoft Excel to ensure that the maximum allowable load is not exceeded by the maximum possible load. All results and calculations from SAP2000 can be seen in Appendix G.

4.1.3 Truss Connections

Almost all prefabricated steel trusses utilize welded connections. It is very uncommon to use bolted connections, except in the case where a truss comes in multiple sections, which are then bolted together. Typically almost all of the welding is done in the factory where the truss is fabricated and very little welding is done on site. See Figures 37 and 38 below for details of typical truss welds.

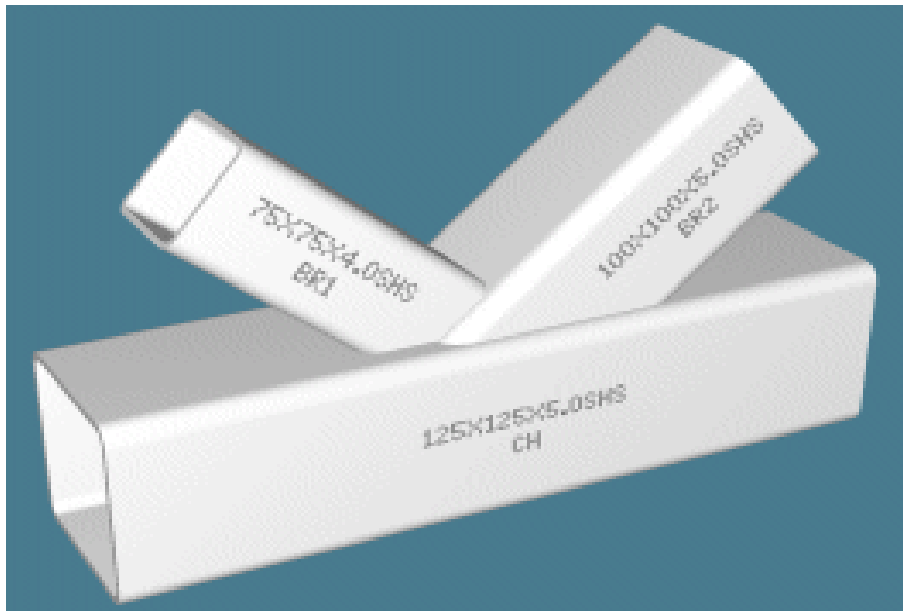

Figure 37: Typical Tube Cut, Prepared for Welding



Figure 38: Typical Welded steel Connection

4.2 Arch Design

The second alternative chosen for analysis was the arch bridge. The arch bridge allowed for a slim deck and allows for a more aesthetically appealing design. With the limitation of the parking garage to support any more loadings, the arch has to start below the bridge deck, far enough away from the parking garage as to provide enough space for an adequate foundation that will not put extra lateral forces on the parking garage structure/foundation. The main concern with the arch bridge is whether or not the arch will provide enough clearance to meet fire code. Because it is desirable that the bridge does not overshadow the parking garage, the height of the bridge was selected to be roughly the same height as the parking garage elevator shaft.

4.2.1 Deflection

According to AASHTO, deflections must be less than $L/360$ using the Service 1 limit state. Because the bridge is 160' in length, the deflections were limited to .44 feet or 5.33 inches. The final deflections can be seen in the deflection tables in Appendix D – Arch Bridge Deflection Tables. The maximum deflection of the arch bridge was found to be in the 20' section of the bridge located between the left arch and the left bridge deck end, which is the section of the bridge that is essentially simply-supported. This section was primarily dependent on the girder size. The maximum deflection recorded, between the girder and the arch members, was roughly 2.25 inches, well within the deflection limits required from AASHTO.

4.2.2 Member Sizing

The arch bridge was designed in SAP2000 with cross bracings for the girder and arch, initially designed at 10 foot spacing and with a reduced size. The cross beams for the girders were designed as S 5x10 members and the cross beams for the arch were designed as HSS 5x.5

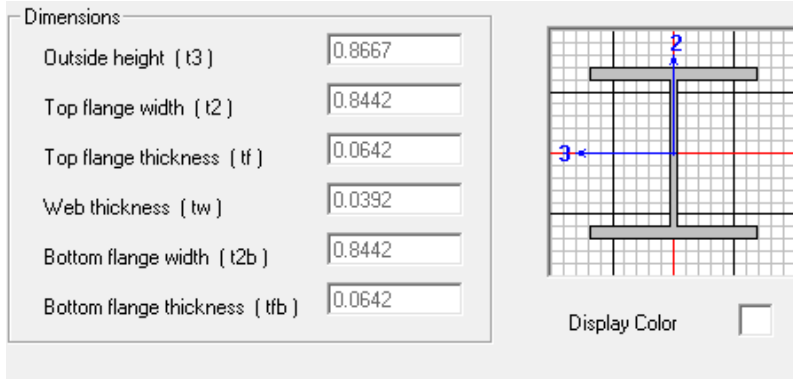

Figure 30: Cross Section of Girder (W10x68)

members based off of a maximum deflection. The appropriate load combinations were applied to each member (their calculation can be viewed in 8.3 Appendix D – Arch Bridge D). In all loading cases, tables were exported from SAP2000 to excel, which can be seen in Appendix C – Arch Bridge Analysis Tables from SAP2000. Once in excel, MAX and MIN equations were created to calculate the maximum and minimum P, V, M, and S11 (stress) values for each bridge member. Then a summary table was created to calculate the maximum and minimum of the previously mentioned values for each load case.

The arches of the arch bridge were determined to be steel tubes. Although concrete is preferred in compression, steel ribs produce far less dead load forces, which is ideal due to the limitation of the parking garage to carry additional stresses. Furthermore, the steel arches allow for smaller cross-sections, which help with the clearance limitation of the bridge, and are popular in arch bridge design (HSS). In SAP2000, the arches were determined to be located 10' from the parking garage and 20' from the loading dock behind Harrington Auditorium. This location was determined considering the anticipated size of the foundation and to allow for the surrounding buildings to be independent of the forces experienced in the foundations of the arches. The steel arches were originally determined to be 2' wide with a 6" thick wall, and were reduced to 12.5" wide with a .625" thick wal

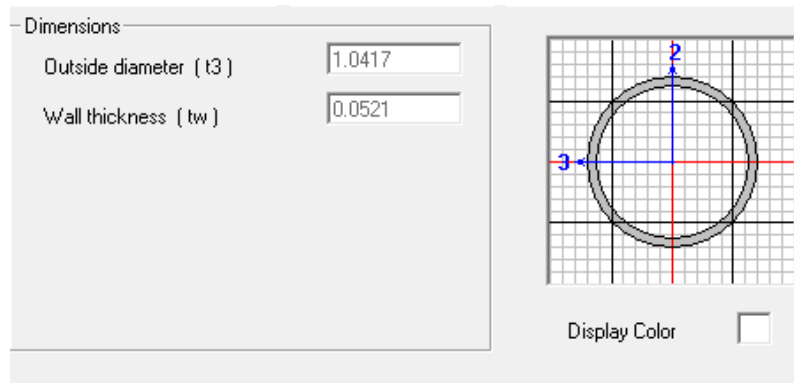

Figure 40: Cross Section of Arch Member (HSS 12.5"x.625")

calculated following the application and analysis of the load combinations. The members were drawn in SAP using the draw curved frame member tool. The height of the bridge was set 20' above the garage connection height (20' above the 536-7" elevation) and it was set at the middle of the arch's span (not the bridge's span) to allow for some symmetry for the arch. Once determining the coordinates for the top of the arch, the box for curve type, we selected "Parabolic Arch – 3rd Point Coordinates" to set the height. The arch was drawn into SAP; however, due to the educational version of SAP2000's limitations, the curved member drawn

was converted into 13 straight line members. To facilitate cable placement, the curved frame member's location information was exported into Microsoft Excel: displaying the frames as separate straight frame members as shown below in Figure 39. The frame members still act as an arch; however, the limitation of SAP2000 was resolved and allowed for a more realistic and accurate analysis, allowing for the ability to manufacture similar, smaller members as opposed to two large arched members. The connections for the 13 separate frame members also will serve

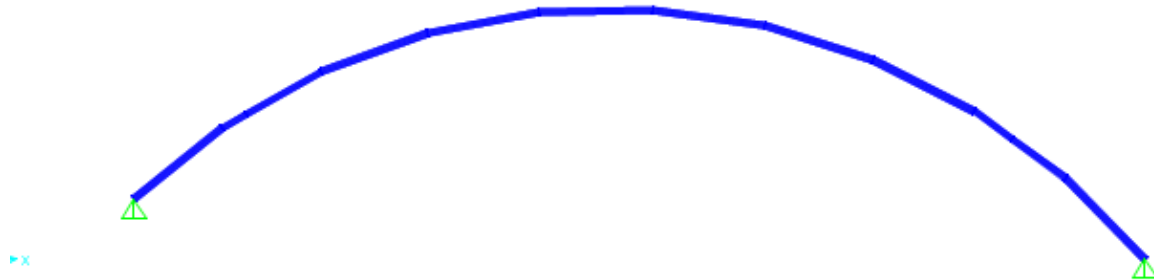

Figure 41: Arch Member As Drawn In SAP2000

as the joints where the cables would transfer the bridge deck loads to the arch. Cross members were added between the two arches to provide lateral support, as well as connectivity. Finally, the arch members were checked via hand calculations to ensure that buckling does not occur in these members and to validate the calculations made by SAP2000.

Because the design moments were calculated through SAP2000, the bridge had to be “built” before the load cases could be run and the moments determined. Therefore, the size of the bridge girders needed to be assumed prior to the design, and adjusted accordingly, once the moments were calculated. Due to the necessity for the bridge to meet fire code minimum clearance and the already limited clearance due to the site conditions a W8X48 steel beam was chosen as the initial girder size through a basic moment calculation, considering the pedestrian live load, dead load of the concrete deck. The girders were drawn using the drawn frame tool in SAP2000. The ends of which were determined through the construction documents and the survey data as mentioned in sections 3.1 and 3.2. As the moments and stresses were determined, the girder size was adjusted to comply with AASHTO requirements (AASHTO, 2012). The major factor for the girders was the high stress experienced right at the point of connection between the girder and the arch (near the loading dock at Harrington Auditorium). The girder size was increased to a W10X68 to account for the high stress and comply with the bridge girder calculations (see Appendix E – Arch Bridge Design Calculations for more information).

In SAP2000, the cable members were design using the diameter option, starting with a diameter of .25'. The sizes of the members were changed as SAP analysis was conducted. This option allowed the cable members to only support tensile forces since cables cannot support compression. Because the arch members were already defined, the same grid was used to create the cable members. To connect the cables to the girders, the cables were drawn in extending straight past the deck to a z value of 0. Then the girder and the cables were selected and the divide cables tool was used to divide the members at their intersections. Then the cable members that extended below the deck/girders were simply deleted, leaving the remaining cable

members in their desired locations (between the arch frame connections and the bridge deck/girders). The final cable layout is shown below in Figure 39.

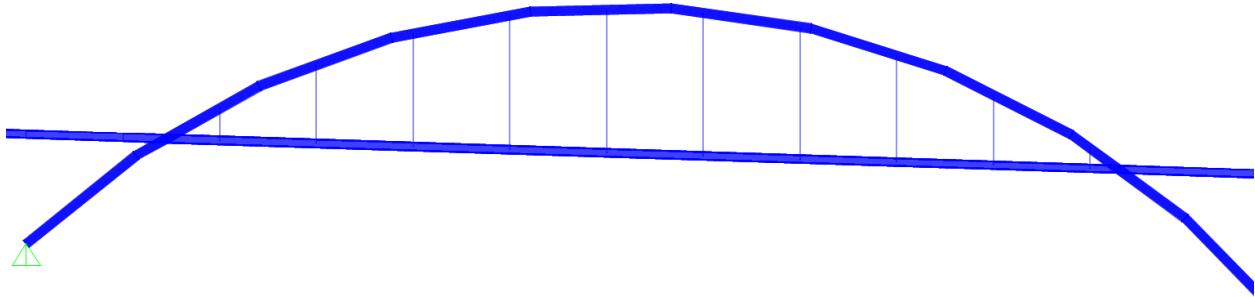

Figure 42: Final Cable Layout Designed in SAP2000

4.2.3 Arch Connections

Commonly in the North-Eastern parts on the United States, these connection details are left to the fabricating firm. Once the fabricator creates a design for these connections, he/she shall create engineering sketches with design details for approval by the structural designer(s). The connections that need to be addressed include; arch to cable, cable to girder, and arch to foundation. These connections would likely be similar to those seen in Figures 43, 44 and 45.



Figure 43: Example of Arch-Cable Connections



Figure 44: Example of Cable-Girder Connection



Figure 45: Example of Arch-Foundation Connection

4.2.4 Fire truck Clearance

As stated in the bridge requirements, the bridge must be able to allow a fire truck to pass beneath it. According to the construction documents, the ground elevation is 522' at the parking garage and about 523' at 50' off the parking garage. This means that, assuming an even slope, every ten

feet the ground elevation rises .2'. In Figure , the height of the fire truck can be observed as 13.5', as determined in the fire code. Taking into account the previous information, the bottom of the bridge must have an elevation of 533'-3.5" at 40' off the parking garage and 533'-6" at 50'



Figure 46: Fire Truck Height Dimension

off the parking garage. According to the heights in SAP, the top of the bridge is at 538'-1.2" at 40' off the parking garage and 538'-3.5" at 50' off the parking garage, which yields a clearance of 15.1' and 15.2' respectively (observed in Figure). Taking into account the 8" thick deck and the 10" outside to outside height of the girder, 1.5' must be taken off the 15.1' and 15.2' measurements. Thus, the bottom of the deck has a clearance of 13.6' and 13.7' at 40' and 50' off the parking garage, respectively. Although the bridge does have the capacity to clear a fire truck, having the deck overlap the bridge girders and not simply sit on top of the girders, yielding a greater clearance.

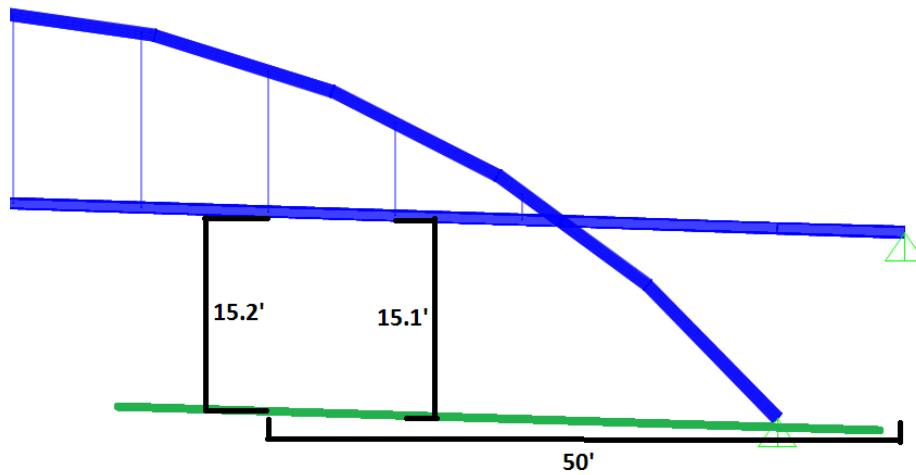

Figure 47: Top of Bridge Deck Clearance

4.3 Foundation Design

The foundation design was completed by hand calculations in Microsoft Excel, and specific to each bridge as seen in the below sections.

4.3.1 Truss Pier Design

The piers were designed using the vertical reactions of 387kips per end of the bridge applied to the SAP2000 bridge model seen in Appendix I. The supports for each of the four piers which will hold the decking at the ends of the bridge are to be designed from concrete using a design compressive strength of 4000 psi and yield strength of the reinforcing steel of 60,000 psi. By using the reactions from the concrete decking, and self-weight of the truss design, steps were taken into design the concrete piers with steel reinforcement shown in Appendix J. The final recommended design would be a concrete pier 1' x 1' x 5', with a footing of 2.5' x 2.5' x 1', with 5 #7 rebar as steel reinforcement, typical on center for each side of the footing. The concrete decking will rest on the four concrete piers at the ends of the parking garage.

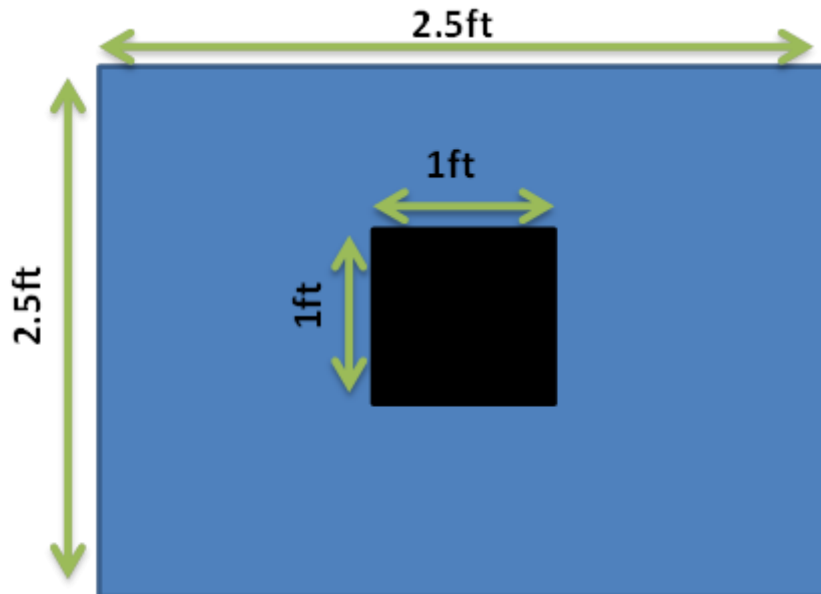

Figure 31: Pier near Harrington and Parking Garage Top View

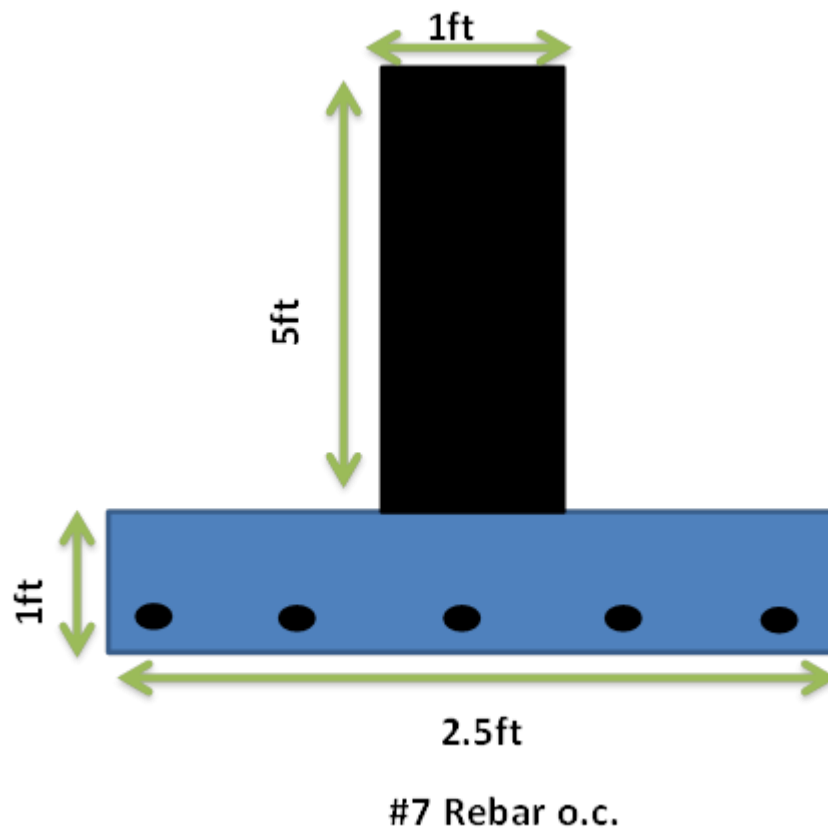

Figure 32: Pier near Harrington and Parking Garage Longitudinal View

4.3.2 Truss Middle Pier

The single middle pier was designed using the 387kip vertical reaction applied from the SAP2000 truss bridge model. The support for the middle pier which will support the truss bridge are designed from concrete using a design compressive strength of 4000 psi and yield strength of the reinforcing steel of 60,000 psi. By using the reactions from the concrete decking, and self-weight of the truss, steps were taken into designing the concrete piers with steel reinforcement shown in Appendix J. The final recommended design would be a concrete pier 2' x 2' x 10', with a footing of 5.25' x 5.25' x 1.25', with 7 #7 rebar as steel reinforcement, on center for the middle concrete pier that will support the concrete decking at the center of the bridge decking. An important issue to note was to have clearance for a fire truck to pass through under the bridge in case of an emergency; the water retention tanks will have to be removed in order to have this pier constructed with a foundation. Pile caps were not necessary as soils consisting of glacial till or bedrock deposits were found generally less than 8 feet below the surface where the middle pier would be built, these soils had an allowable bearing capacity of 8000 pounds per square foot. Piles would be required if the bearing capacity of the upper soil layers were insufficient, but firmer soils were available at greater depths requiring the use of pile caps. Please see Appendix J for further calculations.

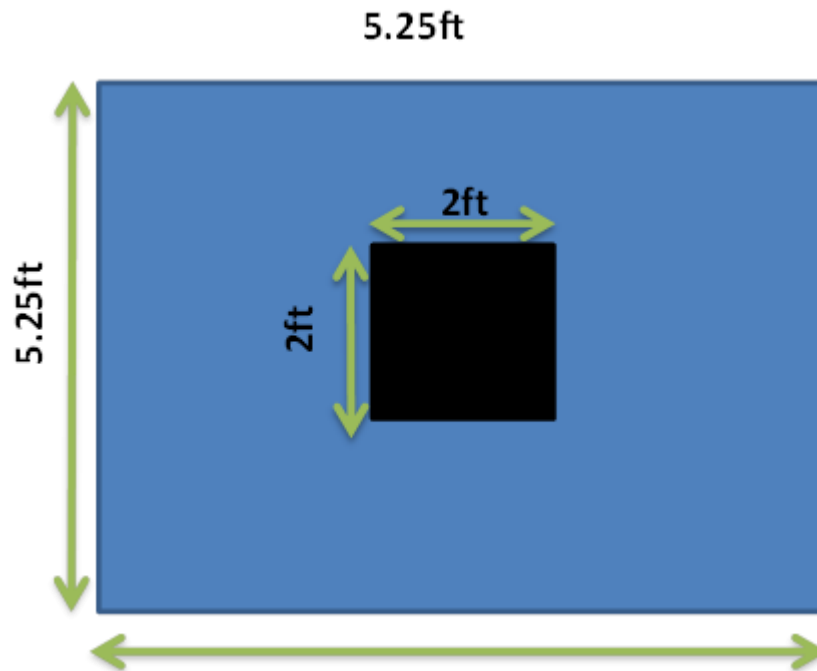

Figure 50: Truss Middle Pier, Top View

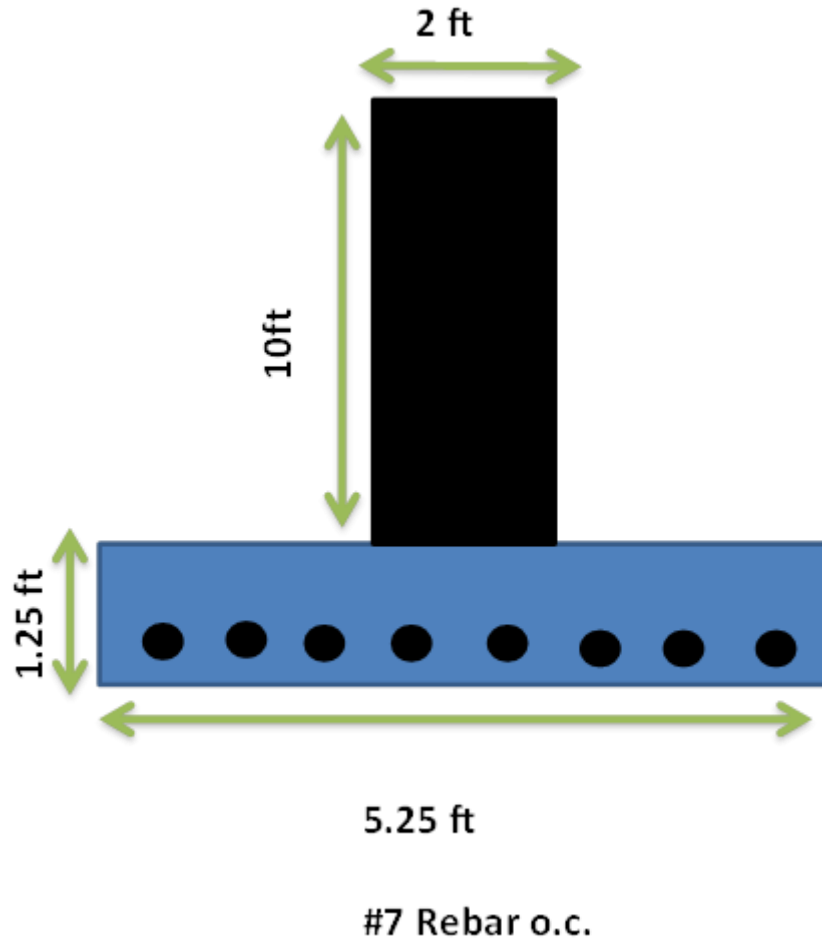

Figure 51: Truss Middle Pier, Longitudinal Side View

4.3.3 Arch Footing Design

The abutments were designed as retaining walls using the loads applied to the SAP2000 bridge model for an Arch. The supports for each of the two piers which will support the truss bridge are to be designed from concrete using a design compressive strength of 4000. By using the reactions from the concrete decking, and self-weight of the truss, steps were taken into designing the abutments shown in Appendix F. The final recommended designs will have four concrete abutments with dimensions shown in Figure 52, 4' below grade for support.

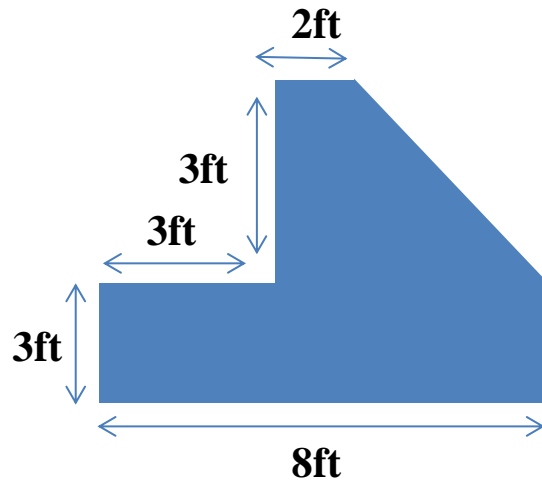

Figure 52: Arch Bridge Abutment, Side View

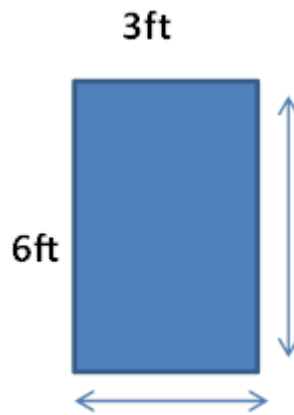

Figure 53: Arch Bridge Abutment, Front View

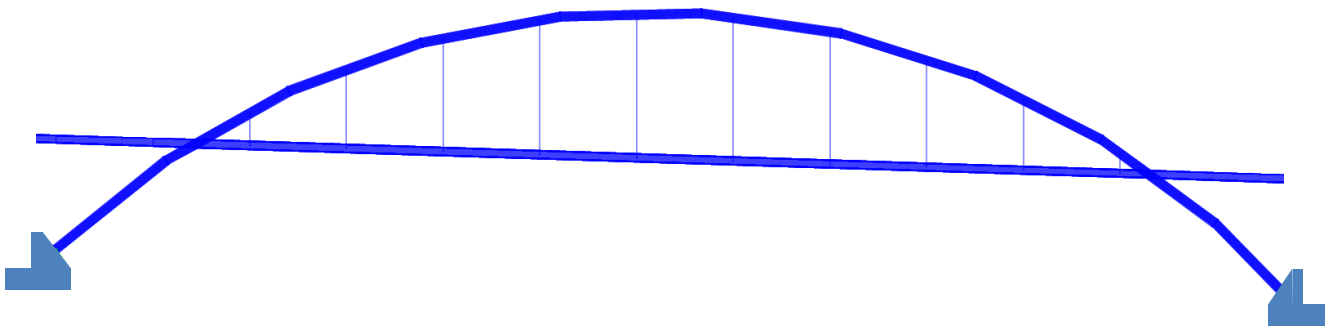

Figure 54: Arch Bridge with Abutments

5 Results

5.0 BIM

We attempted to import the models from Sap2000 into REVIT via an .IFC file extension. Unfortunately, the conversion does not keep the member sections intact and assigns a general section to all members, which resulting in needing to design each member size in REVIT and assign them to each member accordingly. In addition, since we were using 2-dimensional frames the frames had to be duplicated and the deck and cross members had to be constructed as well. We used the design data to form the piers and footings and placed them accordingly. We had difficulty getting the arch to display properly in 3D, because the individual members would not properly connect. We eventually solved this problem with the use of a special tool for integrating the ends of members.

The prospect of producing a full “walkable” 3-dimensional model proved too difficult and time consuming. We resultantly settled for producing high quality renders from various camera angles on both the arch and truss bridge and superimposing them on top of pictures taken from the site via Adobe Photoshop. We finished by touching up the renderings in Adobe Photoshop to suit the lighting and match more naturally. The final renders for the truss and arch can be seen below in Figures 55, and 56. An outline of the steps taken in the process can be seen in Appendix O.



Figure 55: BIM Render of Proposed Truss Bridge



Figure 56: BIM Render of Proposed Arch Bridge

5.1 Schedule

In order to produce a schedule of the two bridge alternatives, Primavera software was utilized. Each task in order to construct each bridge was defined, from the procurement of the materials to the excavation of the footings to the end of construction. Once each task was identified, the duration of each task was determined. The RS Means books were utilized to determine each task's duration. RS Means has a daily output parameter associated with any item included in the book. For example, RS Means lists the daily output of 12" x 12" square columns as 1498.50 Cubic Yards. Knowing the daily output of each task, the total amount utilized in each bridge was determined and compared to the daily output; thus, determining the duration of each task. Once this step was completed, the relationship each task has with each other was determined. For example, the columns cannot be constructed before the footings are constructed and have time to reach an appropriate strength (the footings do not need to necessarily reach their 28 day strength before the columns are constructed). The predecessor and successor for each task was determined, and once complete, the scheduling analysis was run to construct a Gantt chart and determine the total length of each bridge. The Gantt chart for each bridge can be observed in Figure 57 and Figure 58. The schedules focus on the construction of the bridge, taking into account the procurement of the concrete and steel members.

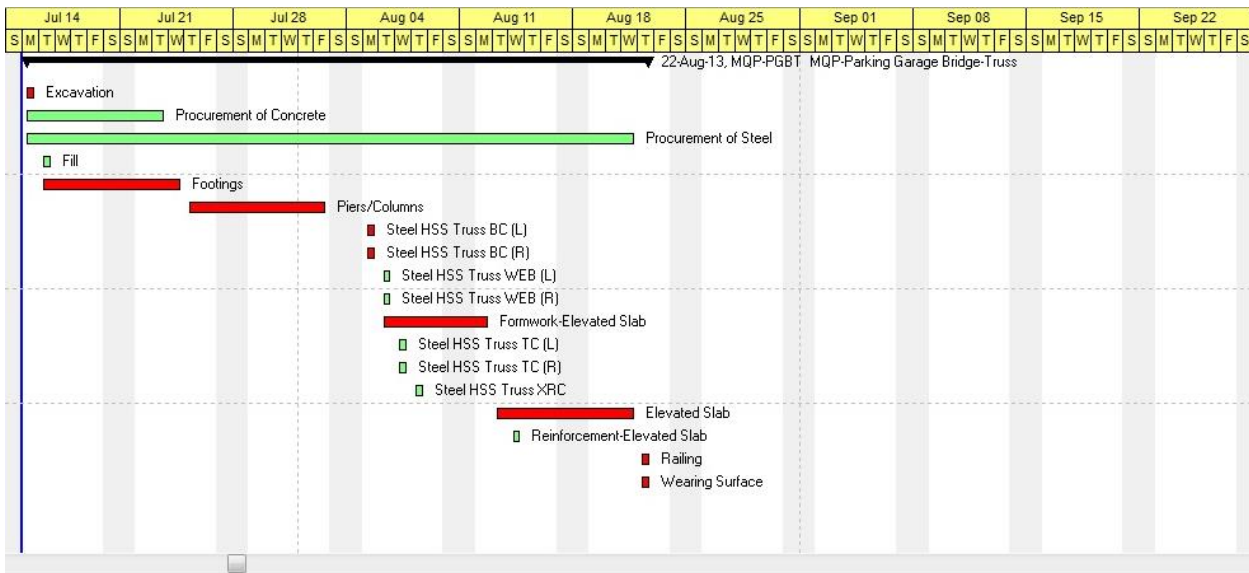

Figure 57: Arch Bridge Gantt Chart

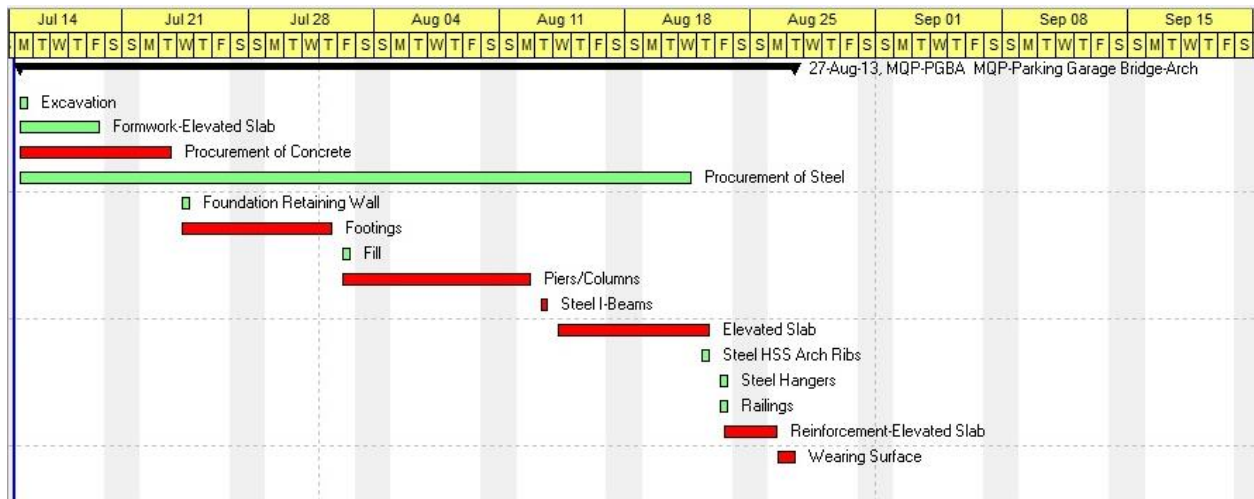

Figure 58: Truss Bridge Gantt chart

5.2 Cost

RS Means has several books that contain cost data for construction projects. In particular, the *Building Construction and Heavy Construction Cost Data* book set was used to gather cost information and compile a cost spreadsheet for each bridge. These spreadsheets can be viewed in detail in Appendix L – Bridge Cost Estimation. Although most of the information needed to estimate the bridge costs was readily available in the RS Means Cost Data books, several assumptions were used. RS Means does not have any cost information on HSS members; therefore, the team used a unit price of \$2000 per ton, which was a number recommended to the

team by its advisor, Guillermo Salazar, and was a number that was observed when an online check of steel prices was conducted. Furthermore, the team marked up the costs of the arch members by 10% to account for the increased difficulty of constructing the members, as opposed to constructing mass produced members. Also, because custom members were used for the construction of the truss, a 33% mark-up was applied to their cost. In addition to the construction cost, bonds, insurance premiums, buildings permit costs, and contingency/mark-ups were added to the total cost to account for the total construction cost of the project. As a result of the cost estimation, the arch bridge was estimated to cost \$228,006 and the truss bridge was estimated to cost \$233,176. The similarity in price allows the price to not govern in the bridge selection. These costs do not include any related site work which could prove to be a significant sum (a difference of \$5,000). All detailed cost estimations can be viewed in Appendices K and L for the bridges and deck respectively. In addition all detailed scheduling information can be viewed in Appendices M and N for the arch bridge and the truss bridge respectively.

THE REMAINDER OF THIS PAGE WAS LEFT INTENTIONALLY BLANK

6 Conclusions and Recommendations

6.0 Conclusions

This project has given our group a greater understanding of the effort, time and diligence required during a major design process. Our team took the time to meet with a key administrator to gain a better understand of why a bridge was necessary. The bridge will become a main gateway at WPI and become part of the future promenade in that location. Another broader implication of the bridge is to improve handicap access to the campus. A handicapped individual could theoretically take the garage elevator to the garage roof and then simply cross the bridge.

Once the need for the bridge was addressed, research on multiple bridge styles and materials to give ourselves a number of options to choose from was performed. After brief analysis and design considerations of these options, two alternatives were selected for detailed design. These two alternatives would be an arch-cable bridge and a truss bridge.

Once these two options were selected, we performed an in-depth design and analysis of both options. Using computer modeling in SAP2000 and hand calculations in Microsoft Excel, most major aspects of the bridges were designed. The key components designed included; the bridge deck, the bridge superstructure, the bridge substructure, and the foundation. These components were addressed for both bridges. During the design of each bridge, key codes had to be followed to ensure the safety and integrity of the bridge. Chief among these codes for design were those set down by the American Association of State Highway and Transportation Officials (AASHTO).

Once the comprehensive design of each bridge was completed, an in depth schedule and cost estimate could be produced for each alternative. Based on our analysis, each bridge would have similar costs and times required for construction. Due to this, a final decision would likely be made based on constructability, aesthetics, and the overall favoritism of the Board of Trustee at Worcester Polytechnic Institute. Please see Section 6.1 for further recommendations regarding our expertise in the matter.

Exploring the social and technical aspects of this project has broadened our views of the construction process. Understanding that we need not only design the bridge, but also design a bridge that will actually get built has been a challenge.

6.1 Recommendations

We fully recommend both the two-span truss and the single-span arch as viable alternatives. With similar estimated prices, materials and foundation designs, it comes down to some smaller choices when making a decision:

Constructability:

The truss would be a more easily and quickly constructible bridge because it would most likely be prefabricated and then simply lifted into place which could be done in a single week. Conversely, the arch would need to be assemble in sections which would take far longer and would require significant temporary shoring and possible the use of multiple cranes.

Aesthetics:

In general we think that the arch would be a more attractive design for that particular spot on campus. But we do consent that this category can be very subjective.

Foundation Designs:

The truss would require a middle pier, unlike the arch. Pacing a middle pier would disrupt the storm water infiltration pipes set below the proposed bridge location. This could affect the drainage capacity of the site.

6.1.1 Further Steps

- 1.) Present the BIM renderings to the WPI facilities staff for feedback.
- 2.) Present the BIM renderings, cost and schedule information to WPI's board of trustees for funding.
- 3.) If approved for funding, solicit bids for the project.
- 4.) Select a bid and schedule construction in accordance with the guidelines listed in this report.

THE REMAINDER OF THIS PAGE WAS LEFT INTENTIONALLY BLANK

7 Bibliography

- AASHTO. (2009). *LRFD Guide Specifications for Design of Pedestrian Bridges*. New York: AASHTO.
- AASHTO. (2012). *AASHTO LRFD Bridge Design Specifications*. Washington, D.C.: AASHTO.
- Alliance, M. D. (2000). *Product selection guide: FRP composite products for bridge applications*. New York: Market Development Alliance.
- ASCE. (2001). *Report Card for America's Infrastructure*. Washington: American Society of Civil Engineers.
- AVK. (2010). *Sustainability of Fiber-Reinforced Plastics: An Assessment Based on Selected Examples of Application*. Frankfurt: AVK.
- Azamejad, A., McWhinnie, K., Tadros, G., & Jiri, a. S. (2011). Cable-Stayed Bridge as an Alternative for Medium and Short Span Bridges. *2011 Annual Conference of the Transportation Association of Canada*. Edmonton, Alberta: Transportation Association of Canada.
- Azar, J. M. (1991). *Structural components in Highway Bridge Deck Applications*. New York: VCH Publishers.
- Chen, W. F. (2003). *Bridge Engineering: Handbook*. Boca Raton, FL: CRC Press LLC.
- Colorado Department of Transportation. (2010). *2010 Cost Data*. Colorado Department of Transportation.
- Department of Justice. (2010). *2010 ADA Standards for Accesible Design*. Washington, DC: Department of Justice.
- Godden, W. G. (Ed.). (1997). *Cable-Stayed With Steel Deck*. (University of California, Berkeley) Retrieved from National Information Service for Earthquake Engineering: http://nisee.berkeley.edu/leonhardt/html/cable-stayed_with_steel_deck.html
- Handi-Ramp. (2013). *ADA Compliant Handrails & Railings*. Retrieved from Handi-Ramp Handrails: <http://www.handiramp.com/handrails.htm>
- Harvey, W. J. (1993). *A Reinforced Plastic Footbridge, Alberfeldy, UK*. Structural Engineering International.
- Henry, J. (1985). *Deck Girders System for Highway Bridges Using Fiber Reinforced Plastics*. 1985: North Carolina State University.
- Howe, A. (2012, Spring). Delta Ponds Pedestrian Bridge: Extending a Sustainable Transportation Network. *Aspire*, pp. 20-23.
- johnweeks.com/bridges/pages/ms19.html. (2013, february 3). Retrieved from johnweeks.com: johnweeks.com/bridges/pages/ms19.html
- Malvar, T. A. (2005). *Fiber-Reinforced Polymer Composites in Bridges: A State-Of-The-Art Report*. Port Hueneme, California: NAFAC.

- Management, D. o. (2011). *2011 WPI Student Fact Book*. Worcester.
- Market Development Alliance of the FRP Composites Industry. (2004). *Bridge Product Gateway*. Retrieved from American Composites Manufacturers Association: http://www.mdacomposites.org/mda/psgbridge_pedestrian_print.html
- Podolny Jr., W. P. (n.d.). *Construction and Design of Cable-Stayed Bridges* (2 ed.). New York: John Wiley & Sons.
- Rayor, G. P. (2010). I-5 Beltline (Gateway) Pedestrian Bridge. *Bridge Design Conference*. Oregon Department of Transportation.
- RS Means. (2011). *RS Means Building Construction Cost Data 2012*. Norwell, MA: RS Means Co., Inc.
- RS Means. (2011). *RS Means Heavy Construction Cost Data 2012*. Norwell, MA: RS Means Co., Inc.
- The Associated Press. (2006, July 5). *Judge rules against fans in Lowe's birdge collapse*. Retrieved October 10, 2012, from ESPN: <http://sports.espn.go.com/rpm/news/story?seriesId=2&id=2510428>
- USDA. (2011). *A Guide to Fiber-Reinforced Polymer Trail Bridges*. Washington D.C. : United States Department of Agriculture.
- Works, C. C. (2011). *Cuyahoga County engineer Supplement to the 2007 ODOT Bridge Design Manual*. Cuyahoga: Cuyahoga County of Public Works.
- Zhou, A. (2002). *Stiffness and Stregnth of Fiber Reinforced Polymer Composite Bridge Deck Systems*. Blacksburg: Virginia Polytechnic Institute and State University.

8 Appendices

8.0 Appendix A – Survey Data

#	Description	Distance (ft)	Elevation (ft)	Horizontal Distance	Angle	Angle	0 Angle Adjustment
1	Benchmark	185.299	-1.39		232.37.45	232.6291667	0
2	Garage Floor	47.068	-1.292		216.05.39	216.0941667	16.54
3	Left Opening (G)	38.692	13.274	37.91726847	198.15.11	198.2530556	34.37611111
4	Right Opening (G)	47.722	13.069	47.12912351	215.19.50	215.3305556	17.29861111
5	Loading Dock Left	131.575	18.3	130.9577326	338.54.42	338.9116667	253.7175
6	Loading Dock Right	128.512	18.208	127.8890734	331.02.55	331.0486111	261.5805556

8.1 Appendix B – Interview Transcript

Interview with Fred DiMauro, Head of Facilities; September 12, 2012, 9 AM Kazin Room

Have 3 projects coming together at same time

- *Rec Center stand alone*
- *Garage came sooner than expected*
- *Covered stairs and canopy main pedestrian walk way to campus*
- *Other access ways depend on how Dana Harmon allows access into building*
- *Going Around Building*

When project is complete, must have passage way for all types of people (handicapped or not)

With creation of garage majority of people will be accessing main campus from it

Handicap issues—series of ramps from Parking Garage to Campus Center

Athletic field will become an extension of campus with Pedestrian Bridge; (elevator in Parking Garage)

Quad to Higgins Gardens

Further complications – Fire truck underneath bridge (Height of bridge with Parking Garage)

Challenge of Building Bridge

DiMauro has agreed to go forward with Bridge Design Firm

Library to Quad, to Higgins Gardens, Parking Garage and Athletic Field, all a connection of Campus

Storm Water distribution Center

Supports of Bridge will have to be coordinated with Manifolds of Stairs

Two issues with vehicles to fields with Athletic Equipment

Two storage rooms for Athletic Equipment

Needs support for snow removal equipment; size width load

(Partial solution) ramp comes along side walk

Bridge Vehicle Weight limit

Constraint, Financial impact; weight?

Committed to Length (life of project)

Court level of Harrington

Bridge comes across court level

Promenade will be in bridge design

Halverson Design Partnership

Cost & Finance

-BP Cost figure in Analysis

1 million dollars for Promenade Bridge and site work

Halverson

Estimate from Gilbane 300,000

Preference in Materials & Lifespan?

Steel; Precast

Aesthetics are more concerned and character of bridge

Does have to fit in surroundings, aesthetically successful but within Budget

Salazar: Bridge in Venice, modern in antiquity, accepted by people

Confined

Bridge and Promenade will be built within 2 years of the complete of Parking Garage, during construction will close knuckle? And area, close 1 entrance

Can obtain soil conditions from Gilbane

Decision process from WPI

President and administration will bring to trustees the rational why it's important, Jeff Solomon (CFO), how much money we have and how to spend it

Trustees receive information why this is a priority, see what major project options

Deliverables for this project

What we would do, how it looks like

3D image to walk around in

Move around a model in real time

Site plan-Structural Detail

3D rendering in surrounding

Cost estimates

Narrative of Design

Features; Strength or Challenges

Scheduling over the summer (still impact on many things)

Conditions at start of A term, or if project begins in Spring, Conditions at commencement, graduation

Evaluation of those

Question for SMAA was there foundation put in place for bridge for later?

8.2 Appendix C – Arch Bridge Analysis Tables from SAP2000

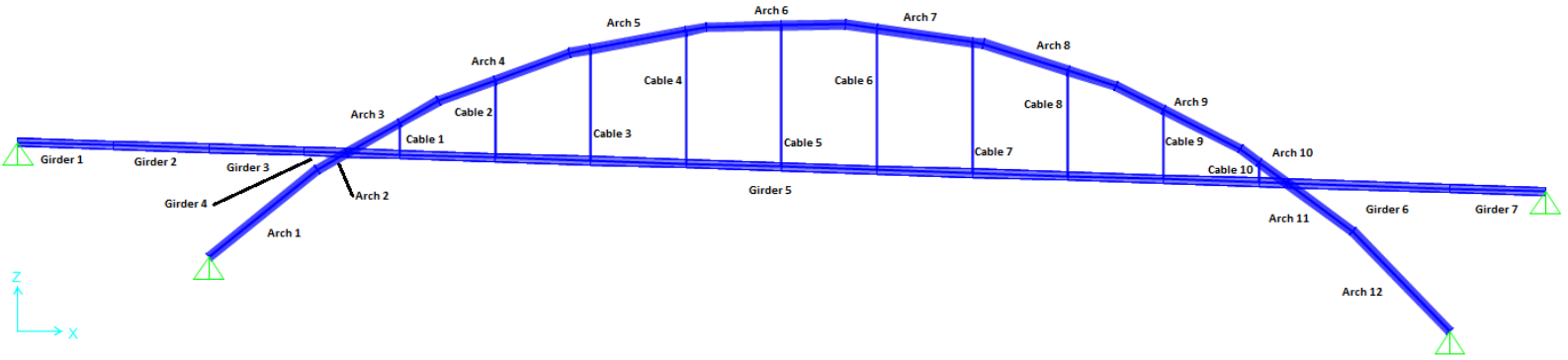

Arch Bridge with Members Labeled

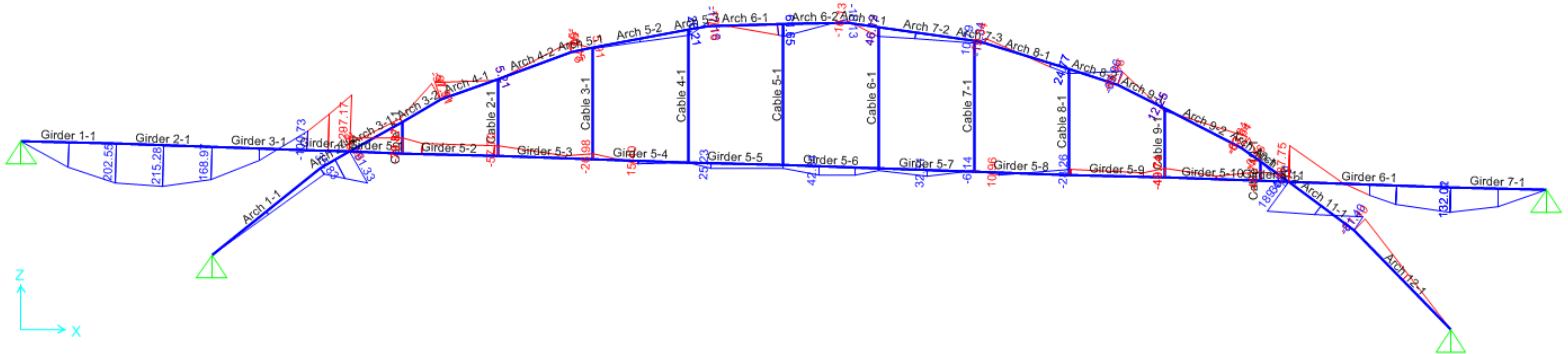

Moment Diagram for Strength I (P) [Maximum Moment of All Load Cases]

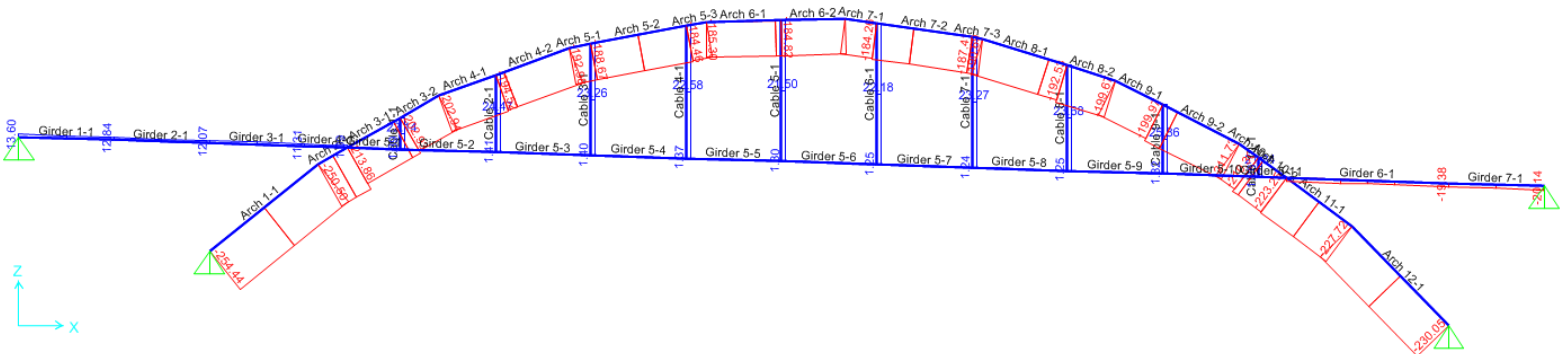

Load Diagram for Strength I (P) [Maximum Load of All Load Cases]

TABLE: Strength I (P) Maximum

Frame	Max P	Min P	Max V	Min V	Max M	Min M
Text	Kip	Kip	Kip	Kip	Kip-ft	Kip-ft
Arch 1	-254.2	-254.4	-2.3	-2.5	35.83	4.44
Arch 2	-250.4	-250.5	-43.7	-43.7	191.32	35.83
Arch 3	-202.8	-213.8	16.9	-2.5	-19.01	-97.91
Arch 4	-194.4	-202.9	6.8	-16.3	5.21	-97.91
Arch 5	-184.4	-192.9	20.3	-24.9	26.21	-50.75
Arch 6	-184.4	-188.6	20.3	-10.0	61.64	-17.16
Arch 7	-184.2	-190.6	26.6	-18.5	46.12	-19.34
Arch 8	-192.4	-199.6	17.9	-4.8	24.77	-69.9
Arch 9	-199.9	-211.7	8.4	-14.7	12.24	-69.9
Arch 10	-210.2	-223.2	-8.4	-26.1	30.78	-63.6
Arch 11	-227.6	-227.7	31.8	31.7	189.41	-81.39
Cable 1	22.1	22.1	0	0	0	0
Cable 2	24.4	24.4	0	0	0	0
Cable 3	23.2	23.2	0	0	0	0
Cable 4	22.5	22.5	0	0	0	0
Cable 5	21.5	21.5	0	0	0	0
Cable 6	22.1	22.1	0	0	0	0
Cable 7	23.2	23.2	0	0	0	0
Cable 8	23.6	23.6	0	0	0	0
Cable 9	25.8	25.8	0	0	0	0
Cable						
10	21.8	21.8	0	0	0	0
Girder						
1	13.5	12.8	-8.4	-32.0	202.5	0
Girder						
2	12.8	12.0	15.1	-8.4	215.27	168.97
Girder						
3	12.0	11.3	38.7	15.1	168.97	-100.72
Girder						
4	11.3	10.9	49.2	38.7	-100.72	-297.16
Girder						
5	1.4	0.4	14.0	-14.8	42.84	-79.87
Girder						
6	-18.0	-19.3	1.3	-38.8	132.01	-187.75
Girder						
7	-19.3	-20.1	24.9	1.3	132.00	0

To see the rest of the tables, refer to excel file “Arch Bridge Design Calculations and Load Analysis Load Tables” and refer to sheet “Summary” and all succeeding sheets.

TABLE: Summary					
Frame	Max P	Min P	Max V2	Min V2	Max M3
Text	Kip	Kip	Kip	Kip	Kip-ft
Arch	1.0	-254.43	31.89	-43.79	191.32
Cable	25.8	-0.113	0.204	-0.20	10.89
Girder	28.0	-28.51	49.28	-41.64	215.27
Cross (G)	0.098	-0.196	95.06	-17.89	3.02
Cross (A)	0.038	-0.099	3.49	-52.44	2.58

Min	Max	Min	Max	Min
M3	Stress	Stress	Stress	Stress
Kip-ft	KSF	KSF	KSI	KSI
-				
97.9126	3556.39	-6558.4	24.6	-45.54
-4.172	4741.94	0	32.9	0
-				
297.166	6932.09	-6772.1	48.1	-47.02
-				
6.07285	147.95	-155.91	1.027	-1.082
-6.4111	177.99	-181.17	1.236	-1.258

8.3 Appendix D – Arch Bridge Deflection Tables

TABLE: Joint Displacements						
Joint	Maximum Deflection			Maximum Allowable Deflection		
Girder	2.197	inches	<	5.33	inches	OK
Arch	1.367	inches	<	4.33	inches	OK

Joint	R
Text	Radians
Arch 1	0.0019
Arch 2	-0.00089
Arch 3	-0.00046
Arch 4	0.0046
Arch 5	0.003319

Arch 6	-0.00017
Arch 7	-0.00372
Arch 8	-0.00274
Arch 9	0.001416
Arch 10	-0.00324
Arch 11	0.00303
Girder 1	0.021184
Girder 2	0.010312
Girder 3	-0.00815
Girder 4	-0.01299
Girder 5	-0.00286
Girder 6	-0.01056
Arch-Cable 1	-0.00336
Arch-Cable 2	0.002641
Arch-Cable 3	0.005173
Arch-Cable 4	0.003422
Arch-Cable 5	0.001445
Arch-Cable 6	-0.00071
Arch-Cable 7	-0.00378
Arch-Cable 8	-0.004
Arch-Cable 9	-0.00103
Arch-Cable 10	0.002239
Girder-Cable 1	-0.00171
Girder-Cable 2	0.002706
Girder-Cable 3	0.004743
Girder-Cable 4	0.004179
Girder-Cable 5	0.001641
Girder-Cable 6	-0.00146
Girder-Cable 7	-0.00351
Girder-Cable 8	-0.00374
Girder-Cable 9	-0.002
Girder-Cable 10	0.000659
Girder-Arch	
Harrington	-0.00517
Girder-Arch Parking	
Garage	0.001644

Joint	U
Text	in

Arch 1	0
Arch 1	0
Arch 2	0.066
Arch 2	-0.006
Arch 3	0.102

Arch 3	-0.356
Arch 4	0.312
Arch 4	-0.426
Arch 5	0.310
Arch 5	-0.336
Arch 6	0.266
Arch 6	-0.346
Arch 7	0.347
Arch 7	-0.443
Arch 8	0.419
Arch 8	-0.371
Arch 9	0.199
Arch 9	-0.099
Arch 10	0.221
Arch 10	0.0368
Arch 11	0
Arch 11	0
Girder 1	0
Girder 1	0
Girder 2	-0.034
Girder 2	-0.046
Girder 3	-0.031
Girder 3	-0.050
Girder 4	0
Girder 4	-0.017
Girder 5	-0.014
Girder 5	-0.031
Girder 6	0
Girder 6	0
Arch-Cable 1	0.038
Arch-Cable 1	-0.217
Arch-Cable 2	0.204
Arch-Cable 2	-0.416
Arch-Cable 3	0.326
Arch-Cable 3	-0.418
Arch-Cable 4	0.323
Arch-Cable 4	-0.353
Arch-Cable 5	0.288
Arch-Cable 5	-0.340
Arch-Cable 6	0.283
Arch-Cable 6	-0.380
Arch-Cable 7	0.341
Arch-Cable 7	-0.440

Arch-Cable 8	0.411
Arch-Cable 8	-0.429
Arch-Cable 9	0.356
Arch-Cable 9	-0.283
Arch-Cable 10	0.118
Arch-Cable 10	-0.057
Girder-Cable 1	0.012
Girder-Cable 1	0.002
Girder-Cable 2	0.017
Girder-Cable 2	-0.014
Girder-Cable 3	0.014
Girder-Cable 3	-0.031
Girder-Cable 4	0
Girder-Cable 4	-0.040
Girder-Cable 5	-0.016
Girder-Cable 5	-0.041
Girder-Cable 6	-0.005
Girder-Cable 6	-0.043
Girder-Cable 7	0.010
Girder-Cable 7	-0.046
Girder-Cable 8	0.021
Girder-Cable 8	-0.040
Girder-Cable 9	0.021
Girder-Cable 9	-0.026
Girder-Cable 10	0.011
Girder-Cable 10	-0.009
Girder-Arch	
Harrington	0.009
Girder-Arch	
Harrington	-0.003
Girder-Arch Parking	
Garage	0.007
Girder-Arch Parking	
Garage	-0.006

8.4 Appendix E – Arch Bridge Design Calculations

See attached excel file labeled “*Design Calculations and Load Analysis Tables –Arch* ” and refer to tabs “*Arch Calculations*”, “*Cable Calculations*”, “*Girder Calculations*”, “*Fatigue and Fracture Limit Stat*”, “*Strength Limit State*”, “*Positive Flexure Composite Sect*”, “*C and NC in Negative Flexure*”, “*Shear Resistance*”, and “*Horizontal Wind Loading*”.

8.5 Appendix F – Arch Bridge Foundation Design Calculations

Design of Abutment

Calculate Resultant Force R, Using Known F_x , F_y , and F_z values.

$$R_{xy} = \sqrt{x^2 + y^2}$$

$$R = \sqrt{R_{xy}^2 + z^2}$$

Known Values

Compressive Strength of Concrete

$$f'c = 4000 \text{ psi}$$

Allowable Soil Pressure

$$q_a = 8000 \text{ psi}$$

Concrete Self weight

$$w_c = 150 \text{ pcf}$$

Based on Soil Type, Silty Sand, Sand and Gravel with High Clay Content

Soil Pressure

$$w = 120 \text{ pcf}$$

Internal Friction Phi,

$$\phi = 30^\circ$$

Friction Coefficient

$$f = 0.5$$

Using Equations obtain soil pressure coefficients

$$K_{ah} = \frac{1 - \sin\phi}{1 + \sin\phi} = .333$$

$$K_{ah} = \frac{1 + \sin\phi}{1 - \sin\phi} = 3$$

Optimum Design of Retaining wall is through approximations with reasonable dimensions and stability checks.

Solve for Total Earth Thrust

$$P = \frac{1}{2} \times \cos\phi \times 120 \times H^2$$

Distance from Base y is equal to Height divided by 3

$$y = \frac{H}{3}$$

Solve for Overturning Moment

$$M_o = y \times P$$

Calculate Component Weights of Abutment

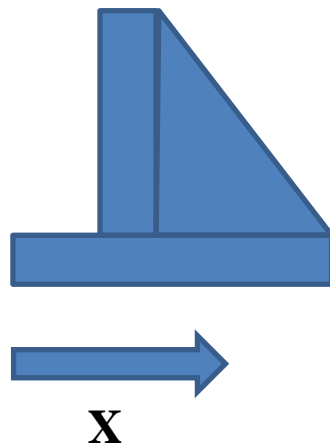

Find the Component Weights W , by multiplying component area times concrete weight,

$$W = A \times W_c$$

Also find sum of all Component Weights

$$\Sigma W$$

Find the Restoring Moment by multiplying each Component Weight W by distance X away from the front edge.

$$M_r = xW$$

Also find the Sum of all Restoring Moments

$$\Sigma M_r$$

Solve for the Factor of Safety

$$F_{safety} = \frac{M_r}{M_o}$$

Distance from Resultant front edge A

$$a = \frac{M_r - M_o}{\Sigma W}$$

Maximum Soil Pressure q

$$q_1 = [(4 \times l) - (6 \times a)] \left(\frac{R_v}{L^2} \right)$$

Corresponding Resisting Friction

$$F = f \times \Sigma W$$

Passive Pressure

$$P_p = \frac{1}{2} \times w \times h^2 \times K_{ph}$$

Using Passive Pressure, and Friction Force, Solve for Factor of Safety against sliding

$$F_{sliding} = \frac{F + P_p}{P}$$

If $F_{sliding}$ is greater than 1.5, then favorable design of Abutment.

Recommended Abutment Design

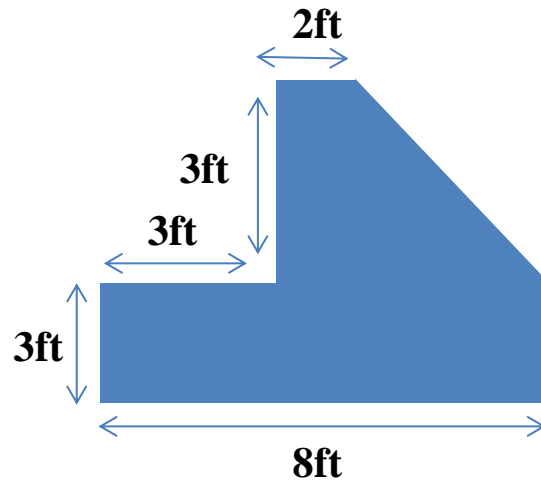

Figure 26: Arch Bridge Abutment, Side View

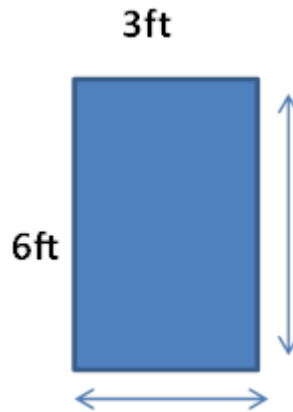

Figure 27: Arch Bridge Abutment, Front View

Abutment Calculations

R	212207	lb
Divide by Number of Abutments x2	106104	lb
Spread by Length of Abutment	21221	lb/ft
$L_{abut}=5ft$		

Soil Bearing Coefficients

Phi=30		
K_{ah}	0.33333	
K_{ph}	3	
w soil Pressure	120	lb/ft ³
w_c Weight of Concrete	150	lb/ft ³
Total Height H	6	ft

Back wall
 Rectangle
 B 2 ft
 H 3 ft
 Back wall Rectangle Area 6 ft²
 Back wall R-DL 900 lb/ft

Back wall
 Triangle
 B 3
 H 3
 Back wall Triangle Area 4.5
 Back wall T-DL 675 lb/ft

Footing
 Rectangle
 B 8
 H 3
 Footing Area 24
 Footing DL 3600 lb/ft

Soil Pressure
 Acting Area
 B 3
 H 6
 Acting Area 18
 Soil Pressure 2160 lb/ft

Table-Acting Loads	w	x	Mr
Back wall R-DL	2100	4	8400
Back wall T-DL	1575	6.5	10237.5
Footing DL	3600	6	21600
Soil Pressure	2520	1.5	3780
Bridge Pressure	21221	5	106103.5
Sum R	31015.7	Sum Mr	150121

$y=h/3$ 2
 $P=1/2Ka*w*h^2$ 1870.615
 Mo Overturning Moment 3741.23

Factor of Safety **40.12611**
Distance from Resultant Front Edge a **4.719538**

Max Soil Pressure $q_1=(4*1-6a)(R_v/L^2)$ **1784.747** lb/ft²

Base Coefficient Friction Factor f 0.5
Friction Force F **15507.85** lb

Minimum Depth Recommended 4 ft
Disregard Depth Due to Environment 1.5 ft
Considered depth h 2.5 ft

Passive Pressure $1/2w*h^2*K_{ph}$ **1125** lb

Safety Factor Against Sliding **>1.5; Favorable**
 $F_{sliding}$ **8.891649** Design

8.6 Appendix G – Truss Bridge Analysis Tables from SAP2000

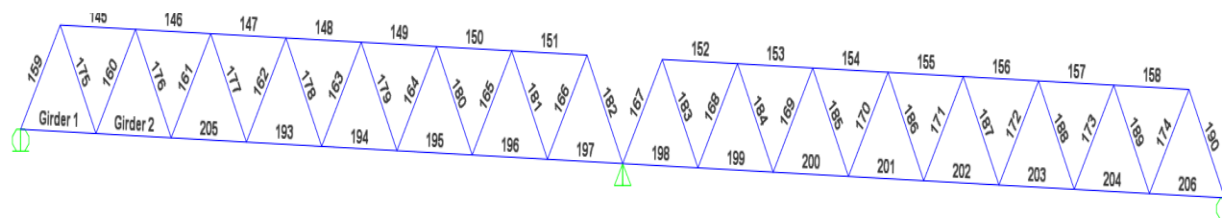

Member Numbers

Member #	Maximum Load Output Case	Axial load Kip	Axial Capacity Kip
145	Strength 1 (Pedestrian)	43.2	47.1
146	Strength 1 (Pedestrian)	69.2	72.6
147	Strength 1 (Pedestrian)	88.4	90.3
148	Strength 1 (Pedestrian)	100.0	100.6
149	Strength 1 (Pedestrian)	95.8	96.9
150	Strength 1 (Pedestrian)	77.2	80.1
151	Strength 1 (Pedestrian)	41.7	45.5

Member #	Maximum Load Output Case	Axial load Kip	Axial Capacity Kip
152	Strength 1 (Pedestrian)	45.2	49.1
153	Strength 1 (Pedestrian)	84.3	86.6
154	Strength 1 (Pedestrian)	106.5	199.1
155	Strength 1 (Pedestrian)	114.1	199.1
156	Strength 1 (Pedestrian)	106.5	199.1
157	Strength 1 (Pedestrian)	84.1	86.4
158	Strength 1 (Pedestrian)	46.1	49.9
159	Strength V (Pedestrian)	54.8	199.1
160	Strength 1 (Pedestrian)	32.5	46.2
161	Strength 1 (Pedestrian)	24.5	30.5
162	Strength 1 (Pedestrian)	14.9	18.7
163	Strength 1 (Pedestrian)	5.1	12.4
164	Strength 1 (Pedestrian)	23.2	26.5
165	Strength 1 (Pedestrian)	44.4	199.1
166	Strength 1 (Pedestrian)	52.0	199.1
167	Strength 1 (Pedestrian)	57.2	199.1
168	Strength 1 (Pedestrian)	49.1	199.1
169	Strength 1 (Pedestrian)	20.1	23.4
170	Strength 1 (Pedestrian)	9.9	12.4
171	Strength 1 (Pedestrian)	9.3	12.4
172	Strength 1 (Pedestrian)	27.9	46.2
173	Strength 1 (Pedestrian)	47.7	199.1
174	Strength 1 (Pedestrian)	57.3	199.1
175	Strength 1 (Pedestrian)	53.7	223.7
176	Strength 1 (Pedestrian)	32.8	223.7
177	Strength 1 (Pedestrian)	23.5	46.2
178	Strength 1 (Pedestrian)	14.5	12.4
179	Strength 1 (Pedestrian)	5.6	12.4
180	Strength 1 (Pedestrian)	23.6	46.2
181	Strength 1 (Pedestrian)	44.7	223.7
182	Strength 1 (Pedestrian)	52.8	223.7
183	Strength 1 (Pedestrian)	56.4	223.7
184	Strength 1 (Pedestrian)	48.8	223.7
185	Strength 1 (Pedestrian)	27.7	46.2
186	Strength 1 (Pedestrian)	9.3	19.9
187	Strength 1 (Pedestrian)	9.8	19.9
188	Strength 1 (Pedestrian)	28.4	29.6
189	Strength 1 (Pedestrian)	47.8	223.7

Member #	Maximum Load Output Case	Axial load Kip	Axial Capacity Kip
190	Strength 1 (Pedestrian)	58.3	223.7
193	Strength 1 (Pedestrian)	97.8	100.1
194	Strength 1 (Pedestrian)	98.1	100.4
195	Strength 1 (Pedestrian)	86.3	89.5
196	Strength 1 (Pedestrian)	58.8	63.2
197	Strength 1 (Pedestrian)	23.8	26.9
198	Strength 1 (Pedestrian)	65.8	70.0
199	Strength 1 (Pedestrian)	95.9	98.4
200	Strength 1 (Pedestrian)	110.5	111.4
201	Strength 1 (Pedestrian)	110.8	111.7
202	Strength 1 (Pedestrian)	110.4	111.3
203	Strength 1 (Pedestrian)	95.0	97.6
204	Strength 1 (Pedestrian)	64.3	68.6
205	Strength 1 (Pedestrian)	94.5	97.1
206	Strength 1 (Pedestrian)	22.0	25.0
Girder 1	Strength 1 (Pedestrian)	23.1	26.1
Girder 2	Strength 1 (Pedestrian)	79.4	83.1

Member #	Output Case	Moment Kip-ft
145	Strength 1 (Pedestrian)	-1.2891
146	Strength 1 (Pedestrian)	6.9299
147	Strength 1 (Pedestrian)	4.6825
148	Strength 1 (Pedestrian)	7.9618
149	Strength 1 (Pedestrian)	9.2879
150	Strength 1 (Pedestrian)	9.0424
151	Strength 1 (Pedestrian)	7.1154
152	Strength 1 (Pedestrian)	-0.8219
153	Strength 1 (Pedestrian)	6.1684
154	Strength 1 (Pedestrian)	8.9813
155	Strength 1 (Pedestrian)	9.5181
156	Strength 1 (Pedestrian)	9.8837
157	Strength 1 (Pedestrian)	9.4174
158	Strength 1 (Pedestrian)	7.7447
159	Strength 1 (Pedestrian)	0.9780
160	Strength 1 (Pedestrian)	0.5340

Member #	Output Case	Moment Kip-ft
161	Strength 1 (Pedestrian)	0.1341
162	Strength 1 (Pedestrian)	0.4511
163	Strength 1 (Pedestrian)	0.0163
164	Strength 1 (Pedestrian)	-0.2215
165	Strength 1 (Pedestrian)	-0.3683
166	Strength 1 (Pedestrian)	-1.0980
167	Strength 1 (Pedestrian)	-0.9411
168	Strength 1 (Pedestrian)	1.0950
169	Strength 1 (Pedestrian)	0.3976
170	Strength 1 (Pedestrian)	0.2551
171	Strength 1 (Pedestrian)	-0.0069
172	Strength 1 (Pedestrian)	-0.2660
173	Strength 1 (Pedestrian)	-0.4798
174	Strength 1 (Pedestrian)	-0.8969
175	Strength 1 (Pedestrian)	-0.5184
176	Strength 1 (Pedestrian)	-0.2063
177	Strength 1 (Pedestrian)	-0.4849
178	Strength 1 (Pedestrian)	-0.0245
179	Strength 1 (Pedestrian)	0.1835
180	Strength 1 (Pedestrian)	0.3418
181	Strength 1 (Pedestrian)	1.0381
182	Strength 1 (Pedestrian)	-0.9901
183	Strength 1 (Pedestrian)	-1.1507
184	Strength 1 (Pedestrian)	-0.4211
185	Strength 1 (Pedestrian)	-0.2803
186	Strength 1 (Pedestrian)	-0.0014
187	Strength 1 (Pedestrian)	0.2454
188	Strength 1 (Pedestrian)	0.4486
189	Strength 1 (Pedestrian)	0.8611
190	Strength 1 (Pedestrian)	0.6324
193	Strength 1 (Pedestrian)	-1.5902
194	Strength 1 (Pedestrian)	-11.7659
195	Strength 1 (Pedestrian)	-8.2303
196	Strength 1 (Pedestrian)	-14.9506
197	Strength 1 (Pedestrian)	8.6573
198	Strength 1 (Pedestrian)	-110.8543
199	Strength 1 (Pedestrian)	7.2503
200	Strength 1 (Pedestrian)	-14.8850

Member #	Output Case	Moment Kip-ft
201	Strength 1 (Pedestrian)	-7.9897
202	Strength 1 (Pedestrian)	-8.4717
203	Strength 1 (Pedestrian)	-7.9705
204	Strength 1 (Pedestrian)	-11.1702
205	Strength 1 (Pedestrian)	-1.8397
206	Strength 1 (Pedestrian)	-4.0449
Girder 1	Strength 1 (Pedestrian)	-0.9780
Girder 2	Strength 1 (Pedestrian)	-18.7892

8.7 Appendix H – Truss Bridge Deflection Tables

See attached excel spreadsheet labeled “*Design Calculations and Load Analysis Tables – Truss*”.

8.8 Appendix I – Truss Bridge Design Calculations

See attached excel spreadsheet labeled “*Design Calculations and Load Analysis Tables – Truss*”.

8.9 Appendix J – Truss Bridge Foundation Design Calculations

See attached excel spreadsheet labeled “*Pier - Design Spreadsheet*” and “*Abutment – Design Spreadsheet*”. See attached word documents “*Pier – Design Equations*”, and “*Abutment – Design Equations*”.

Design of Pier, for Harrington, Garage, and Truss Bridge Middle Pier

Calculate Resultant Force R, Using Known F_x , F_y , and F_z values.

$$R_{xy} = \sqrt{x^2 + y^2}$$

$$R = \sqrt{R_{xy}^2 + z^2}$$

Known Values

Compressive Strength of Concrete

$$f'c = 4000 \text{ psi}$$

Allowable Soil Pressure

$$q_a = 8000 \text{ psi}$$

Concrete Self weight

$$w_c = 150 \text{ pcf}$$

Soil Pressure

$$w = 120 \text{ pcf}$$

Calculate Effective Bearing Capacity to Carry Column Load

(Minimum Depth Cover for column is 4ft)

$$q_e = q_a - w_c \times 4ft$$

Calculate the Area Required

$$A_{req} = \frac{R}{q_e}$$

After Calculating Area required, solve for a Base, b, value that will meet the Area required.

For Strength Design, Upward pressure caused by column load is the Resultant divided by Base, B

$$q_u = \frac{R}{b}$$

Based on the Base, b, and A req, find a column side length, lc, and d value.

Footing Depth is determined by punching shear on critical perimeter abcd, length of critical perimeter is bo

$$b_o = 4(L_c + d)$$

The punching Shear force acting on this perimeter is equal to total upward pressure minus that acting within the perimeter abcd

$$V_{u1} = q_u(b^2 - \left(\frac{L_c + d}{12}\right)^2)$$

Corresponding nominal shear strength is Vc

$$V_c = 4\lambda\sqrt{4000}b_o(d \times 2)$$

$$\phi V_c = 0.75 \times V_c$$

If design strength exceeds factored shear V_{u1} , depth value, d, is adequate for punching shear.

The selected value d will now be checked for beam shear.

$$V_{u2} = q_u b \times (d2)$$

Nominal shear strength

$$V_c = 2\lambda\sqrt{4000}b \times 12 \times d$$

Design Shear Strength

$$\phi V_c = 0.75 \times V_c$$

If design shear strength is larger than factored shear V_{u2} then d will be adequate for one-way shear.

Solve for the moment M_u

$$M_u = q_u b \left(\frac{a^2}{2} \right) * 12$$

Using M_u value, the required area of steel is

$$A_s = \frac{M_u}{.9 \times f_y \times (d - 1)}$$

Checking the minimum reinforcement ratios

$$A_{smin} = \frac{3\sqrt{f'c}}{f_y} \times 114 \times d$$

Steel reinforcement cannot be less than

$$A_{smin} = \frac{200}{f_y} \times 114 \times d$$

Selecting an economical Bar, such as #7rebar, calculate required numbers of rebar, and spacing.

Calculate height of footer

$$H = D + 1.5 \times 1 + 3$$

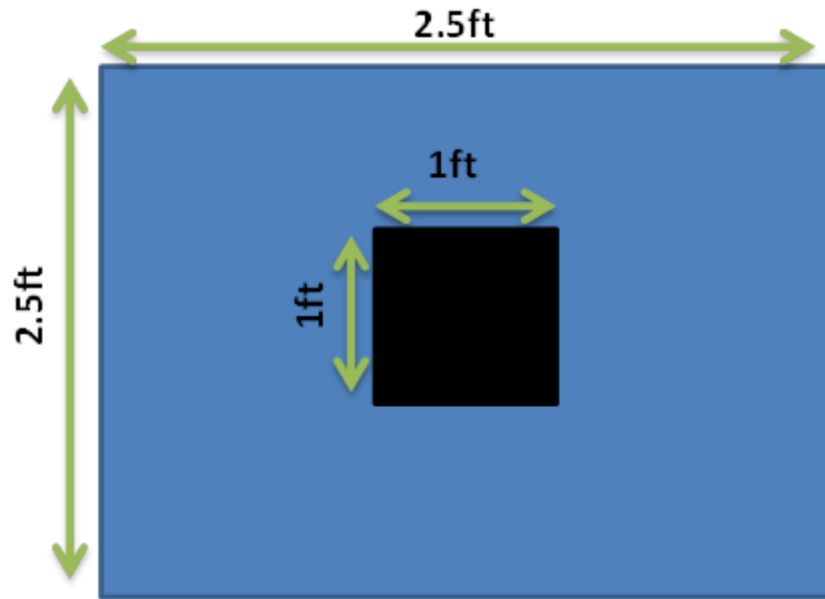

Pier Harrington and Parking Garage Top View

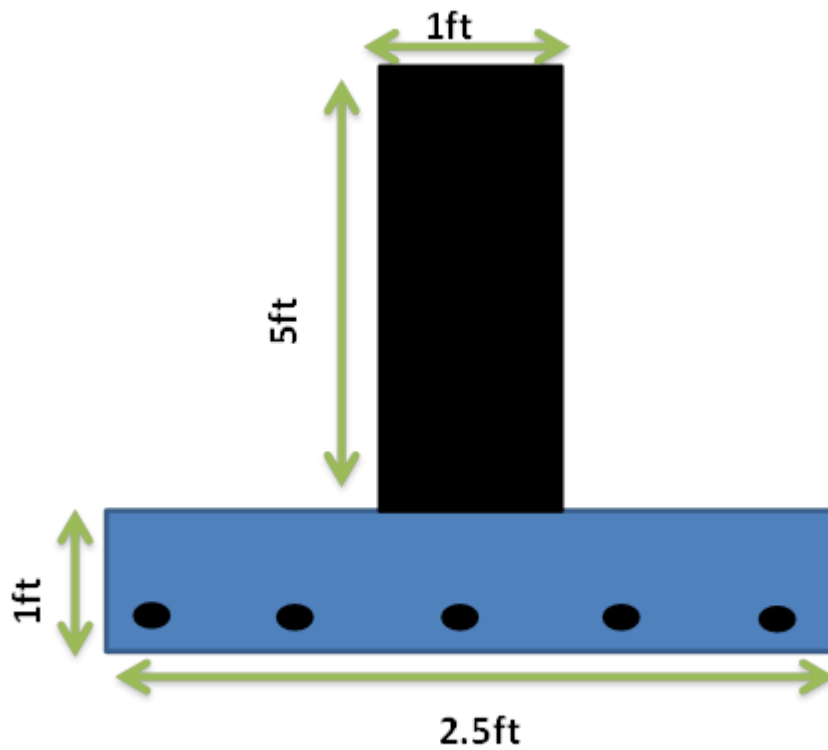

#7 Rebar o.c.

Pier Harrington and Parking Garage Side View

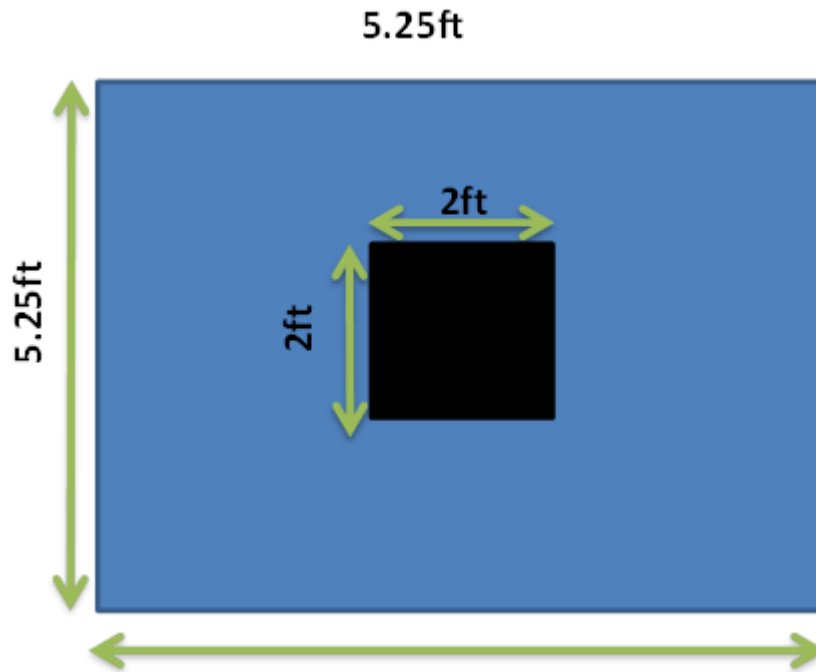

Truss Middle Pier, Top View

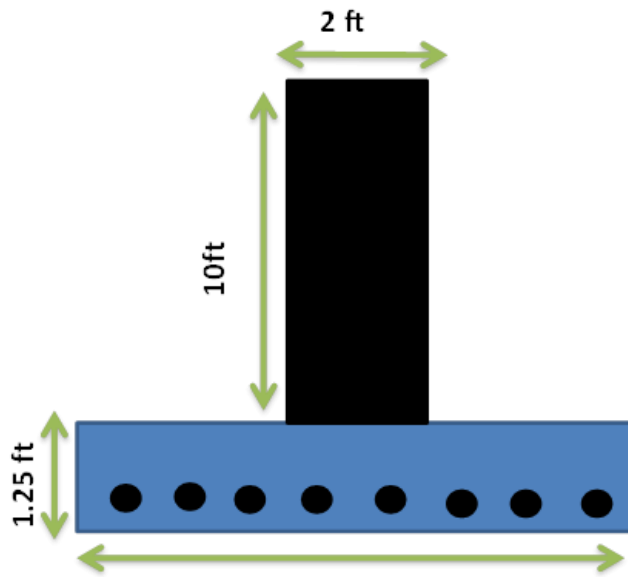

5.25 ft

#7 Rebar o.c.

Truss Middle Pier, Side View

Calculations

Piers: Harrington & Parking Garage

Values

$F_x=182.87k$	49890	lb
$F_y=141.74k$	61000	lb
$F_z=3k$	3000	lb
$R_{xy}=\text{sqrt}(x^2+y^2)$	78803.63	lb
$R=\text{sqrt}(R_{xy}^2+Z^2) R/2$ (For Two Piers)	39430.36	lb

Soil Conditions

$f'_c=4\text{ksi}$	4000.00	lb/in ²
Allowable Soil Bearing Capacity $q_a=8k/\text{ft}^2$	8000.00	lb/ft ²
Concrete Self Weight $W_c=150\text{lb}/\text{ft}^3$	150.00	lb/ft ³
Soil Pressure w	120.00	lb/ft ²
Column 12in x 12in	12.00	in

Effective Bearing Capacity to Carry Column Service Load

$q_e=(q_a)-(W_c \times \text{Minimum Cover})$	7520.00	lb/ft ²
---	---------	--------------------

Footing Depth determined by Calculating Punching Shear on Critical Perimeter abcd

$A_{Req}=R/q_e$	5.24	ft ²	
Square Root	2.29		
Recommended Square Footing Size $B=2.5$	2.50		
Recommend Using a 2.5ft x 2.5ft Square Footing	6.25	ft ²	
$q_u=U/b$	15772.14	lb/ft ²	15.77 k/ft ²
Based on Footing Size and Column Size, Recommend $D=13$	6.00	in	
Perimeter $B_o=4(12+D)$,	72.00	in	

$V_{u1}=q_u(A-((CL+D)/12)^2)$	63088.57	lb
Available Shear Strength		
$V_c=4\text{sqrt}(f'_c)(b_o)(d)$	109288.32	lb
$\phi(V_c)=.75*V_c$	81966.24	lb
$V_{a2}=q_u*(9\text{in})(1\text{ft}/12\text{in})*b$	70974.64	lb
$V_c=2\text{sqrt}(f'_c)(b)(12\text{in}/1\text{ft})(d)$	22768.40	lb
$\phi(V_c)=.75*V_c$	17076.30	lb

Reinforcing Steel Design			
$f_y=60\text{ksi}$	60000	psi	
$M_u=q_u*b*(a^2/2)*(12\text{in}/\text{ft})$	133077.45	lb-in	133.08 k-in
$A_s=M_u/(.9*f_y*(d-1))$	0.49	in ²	
$A_{s,\text{min}}=(3\sqrt{f_y}/f_y)*(b*12)*(d)$	2.73	in ²	
But no less than,			
$A_{s,\text{min}}=200/f_y*(b*12)*(d)$	2.88	in ²	
Use $A_s=1.52\text{in}^2$			
Using #7 Rebar ($A_b=0.6\text{in}^2$)$\times 5= 3\text{in}^2 > 2.88\text{in}^2$	6		
Spacing in horizontal and vertical direction:	6in Spacing for 2.5		
	ft		

Height of Footer	
ACI Recommends Minimum of 3" Cover	
$H=D+1.5*1+3$	11 in
Use $H=12\text{in}$	12 in
Recommended Final Foot Design be 2.5ft\times2.5ft\times1ft Column 1ft\times1ft\times5ft	

Pier: Truss Bridge, Middle Pier

Pier Design Garage	Values	
$F_x=182.87\text{k}$	49020 lb	
$F_y=141.74\text{k}$	55640 lb	
$F_z=3\text{k}$	3000 lb	
$R_{xy}=\sqrt{x^2+y^2}$	386580 lb	74153.6
$R=\sqrt{R_{xy}^2+Z^2} R/2$ (For Two Piers)	193290 lb	9

Soil Conditions		
$f'_c=4\text{ksi}$	4000.00	lb/in ²
Allowable Soil Bearing Capacity $q_a=8\text{k}/\text{ft}^2$	8000.00	lb/ft ²
Concrete Self Weight $W_c=150\text{lb}/\text{ft}^3$	150.00	lb/ft ³
Soil Pressure w	120.00	lb/ft ³
Column 12in x 12in	24.00	in

Effective Bearing Capacity to Carry Column Service Load		
$q_e=(q_a)-(Wcx\text{Minimum Cover})$	7520.00	lb/ft ²

Footing Depth determined by Calculating Punching Shear on Critical Perimeter abcd

$A_{Req}=R/q_e$	25.70	ft ²	
Square Root	5.07		
Recommended Square Footing Size B=2.5	5.25		
Recommend Using a 2.5ft x 2.5ft Square Footing	27.56	ft ²	
$q_u=U/b$	36817.14	lb/ft ²	36.82 k/ft ²
Based on Footing Size and Column Size, Recommend D=10	10.00	in	
Perimeter $B_o=4(12+D)$,	136.00	in	

$V_{u1}=q_u(A-((CL+D)/12)^2)$	719213	lb	
Available Shear Strength $V_c=4\sqrt{f_c}(b_o)(d)$	344056	lb	
$\phi(V_c)=.75*V_c$	258042	lb	
$V_{a2}=q_u*(9in)(1ft/12in)*b$	276129	lb	
$V_c=2\sqrt{f_c}(b)(12in/1ft)(d)$	79689	lb	
$\phi(V_c)=.75*V_c$	59767	lb	

Reinforcing Steel Design			
$f_y=60\text{ksi}$	60000	psi	
$M_u=q_u*b*(a^2/2)*(12in/ft)$	652353.7	5 lb-in	652.35 k-in
$A_s=M_u/(.9*f_y*(d-1))$	1.34	in ²	
$A_{s,min}=(3\sqrt{f_y}/(f_y))*(b*12)*(d)$	4.55	in ²	
But no less than, $A_{s,min}=200/f_y*(b*12)*(d)$	4.80	in ²	

Use $A_s=4.8\text{in}^2$

Using #7 Rebar ($A_b=0.6\text{in}^2$) $\times 8= 4.8\text{in}$

3.75

Spacing in horizontal and vertical direction:

3.75in Spacing for 5.25 ft

Height of Footer

ACI Reommends Minimum of 3" Cover

$$H=D+1.5*1+3$$

15 in

Use $H=11\text{in}$

15 in

**Recommended Final Foot Design be
5.25ft \times 5.25ft \times 1ft 3in Footing Column 2ft x 2ft x
10ft**

8.10 Appendix K – Bridge Deck Calculations

See attached excel spreadsheet labeled “Deck – Moment Calculations”.

Strength I:

Moment Calculations for Deck Design							
Deck Dimensions:	Length	14	Feet				
	Width	1	Foot				
	Depth	0.667	Feet				
Loads:	Pedestrian LL		90.0	psf			
	Wind Load		20.0	psf			
	DL=Self-Weight		100.0	psf			
	Wheel(2)		10666.67	pounds			
	Wearing		25.0	psf			
Moments:	Ped. LL		M(x)	=	2103.75	Foot-Pounds per Foot	
	Snow Load		M(x)	=	467.5	Foot-Pounds per Foot	
	DL		M(x)	=	2337.5	Foot-Pounds per Foot	
	Wheels	x<a	M(x)	=	0.0	Foot-Pounds per Foot	
		a<x<(L-b)	M(x)	=	4671.8	Foot-Pounds per Foot	
		(L-b)<x	M(x)	=	0.0	Foot-Pounds per Foot	
	Wearing		M(x)	=	584.375	Foot-Pounds per Foot	
LRFD Factors:	DC	1.25	For Wheel Moment Calculation				
	DW	1.5					
	LL	1.75	a	=	5.5	Feet	
	WS	0	b	=	2.5	Feet	
Factored Moments	Ped LL	=	4090.6	Foot-Pounds			
	Wind	=	0.0	Foot-Pounds			
	DL	=	2921.9	Foot-Pounds			
	Vehicle	=	8175.7	Foot-Pounds			
	Wearing	=	876.6	Foot-Pounds			
	x	=	5.5	Feet			
Maximum Moment	=	11974	Foot-Pounds				

Strength III:

Moment Calculations for Deck Design							
Deck Dimensions:	Length	14	Feet				
	Width	1	Foot				
	Depth	0.667	Feet				
Loads:	Pedestrian LL		90.0	psf			
	Wind Load		20.0	psf			
	DL=Self-Weight		100.0	psf			
	Wheel(2)		10666.67	pounds			
	Wearing		25.0	psf			
Moments:	Ped. LL		M(x)	=	2205	Foot-Pounds per Foot	
	Snow Load		M(x)	=	490	Foot-Pounds per Foot	
	DL		M(x)	=	2450	Foot-Pounds per Foot	
	Wheels	x<a	M(x)	=	0.0	Foot-Pounds per Foot	
		a<x<(L-b)	M(x)	=	4324.3	Foot-Pounds per Foot	
		(L-b)<x	M(x)	=	0.0	Foot-Pounds per Foot	
	Wearing		M(x)	=	612.5	Foot-Pounds per Foot	
LRFD Factors:	DC	1.25	For Wheel Moment Calculation				
	DW	1.5					
	LL	0	a	=	5.5	Feet	
	WS	1.4	b	=	2.5	Feet	
Factored Moments	Ped LL	=	0.0	Foot-Pounds			
	Wind	=	686.0	Foot-Pounds			
	DL	=	3062.5	Foot-Pounds			
	Vehicle	=	0.0	Foot-Pounds			
	Wearing	=	918.8	Foot-Pounds			
x	=	7.0	Feet				
Maximum Moment	=	4667	Foot-Pounds				

For Distributed Loading

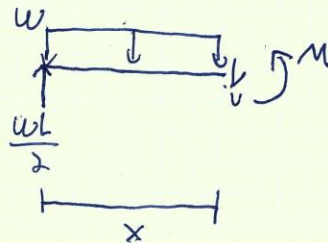
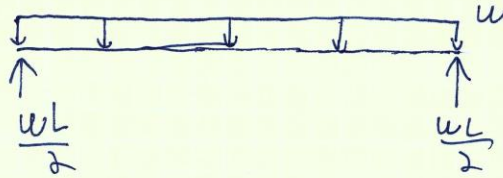
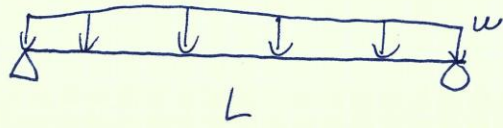

$$\uparrow \sum M = 0$$

$$M - \frac{wL}{2}(x) + wx\left(\frac{x}{2}\right) = 0$$

$$M = -\frac{wx^2}{2} + \frac{wLx}{2}$$

$$M(x) = \frac{wLx}{2} - \frac{wx^2}{2}$$

For Wheel Loads

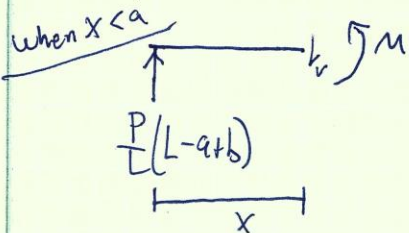
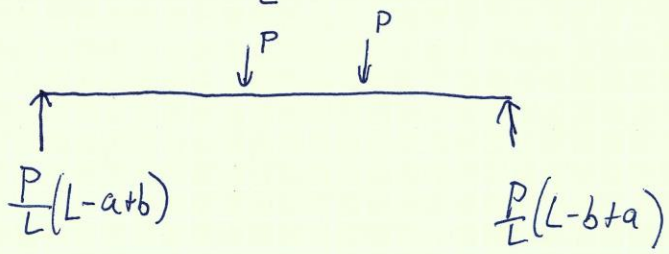
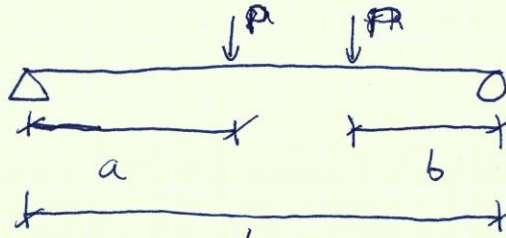

$$+\uparrow \sum M = 0$$

$$M - \frac{P}{L}(L-atb)(x) = 0$$

$$\boxed{M(x) = \frac{P}{L}(L-atb)(x)}$$

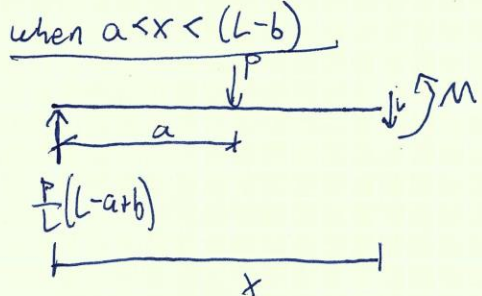

$$+\uparrow \sum M = 0$$

$$M - \frac{P}{L}(L-atb)(x) + P(x-a)$$

$$\boxed{M(x) = \frac{P}{L}(L-atb)(x) - P(x-a)}$$

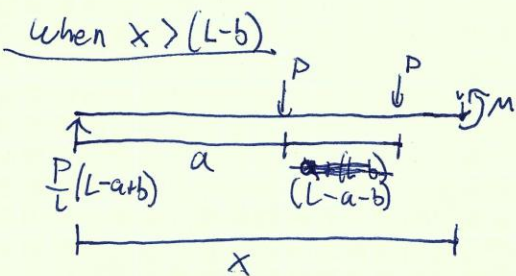

$$+\uparrow \sum M = 0 = M - \frac{P}{L}(L-atb)(x) + P(x-a) + P(x-a - \cancel{a + (L-b)})$$

$$\boxed{M(x) = \frac{P}{L}(L-atb)(x) - P(x-a) + P(x-a - \frac{L-a-b}{L-a-b})}$$

Decking

Assume: $f'_c = 4 \text{ ksi}$

$F_y = \cancel{40 \text{ ksi}} 60 \text{ ksi}$

Pedestrian LL = 90 psf

Front Axle Vehicle Load = 16 k \rightarrow

Snow Load = 40 psf

DL = Self weight of

Concrete = 150 pcf = $150 \left(\frac{8''}{12''}\right) = 100 \text{ psf}$

Assume Dimensions:

Length = 14'

Width = 1'

Depth = 8''

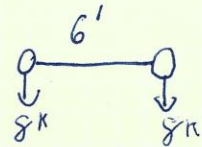

$$M_{xLL} = \frac{wLx}{2} - \frac{wx^2}{2} = \frac{(90 \text{ lb/ft})(14')x}{2} - \frac{(90 \text{ lb/ft})x^2}{2}$$

$$M_{x\text{snow}} = \frac{wLx}{2} - \frac{wx^2}{2} = \frac{(40 \text{ lb/ft})(14')x}{2} - \frac{(40 \text{ lb/ft})x^2}{2}$$

$$M_{xDL} = \frac{wLx}{2} - \frac{wx^2}{2} = \frac{(100 \text{ lb/ft})(14')x}{2} - \frac{(100 \text{ lb/ft})x^2}{2}$$

$$M_{xVL} = \text{when } x < a: \frac{Pb}{L}(L-a+b)(x) = \frac{8000 \text{ lb}}{14'}(14' - 5.5' + 2.5')(x)$$

When $a \leq x \leq (L-b)$:

$$\frac{P}{L}(L-a+b)(x) - P(x-a) = \frac{8000 \text{ lb}}{14'}(14' - 5.5' + 2.5')(x) - 8000 \text{ lb}(x - 5.5')$$

when $x > (L-b)$:

$$\frac{P}{L}(L-a+b)(x) - P(x-a) + P(x-a-(L-a-b))$$

$$= \frac{8000 \text{ lb}}{14'}(14' - 5.5' + 2.5')(x) - 8000 \text{ lb}(x - 5.5') + 8000 \text{ lb}(x - 5.5' - (14' - 5.5' - 2.5'))$$

Decking

From Excel sheet (Moment Calculations for Deck Design)

$$M_u \approx 12^k$$

$$M_u \leq \phi M_n = R b d^2$$

$$b = 1' = 12''$$

$$d = 8'' - 2'' - \frac{1}{2}(0.625'') \quad \text{use \#5 rebar}$$

$$d = 3.6875''$$

$$R = \frac{12^k (12''/1') (1000^b/k)}{(0.9)(12'')(3.6875'')^2} = 980.5$$

$$R \rightarrow \rho \approx 0.0198$$

$$A_s = \rho b d = 0.0198(12'')(3.6875'') = 0.8762 \text{ in}^2$$

$$A_s = 0.8762 \text{ in}^2/\text{ft}$$

$$0.8762 \text{ in}^2 / 0.31 \text{ in}^2 = 2.83 \rightarrow \boxed{3 \#5 \text{ bars}} \\ \text{Per foot @ 4" O.C.}$$

8.11 Appendix L – Bridge Cost Estimation

See attached excel spreadsheets labeled “*Cost Estimate - Arch*” and “*Cost Estimate – Truss*”.

8.12 Appendix M – Arch Bridge Schedule Estimation

See attached Primavera file labeled “*Cost Estimate - Arch*”.

8.13 Appendix N – Truss Bridge Schedule Estimation

See attached Primavera file labeled “*Cost Estimate - Truss*”.

8.14 Appendix O – Building Information Modeling

The following steps were taken to complete the Building Information Models for the truss and the arch:

1. Create the required sections for each type of member in the design.
2. Start drawing the members in a 2-dimensional truss/arch in reference to the dimensions found in the SAP2000 files.
3. Copy the truss/arch to form two trusses 14’ apart.
4. Install a structural floor system and all connecting members
5. Draw footings, piers and walls to the designed dimensions.
6. Import bridge model into the landscape topography from previous project.
7. Set bridge at appropriate elevation.
8. Set up camera angles and elevations to match the location of pictures taken.
9. Set up sun lighting to match the pictures taken.
10. Render at highest quality possible with the topography turned off.
11. Proceed to position the rendering into the pictures using Adobe Photoshop.

8.15 Appendix O – Project Proposal A'12

Introduction

Worcester Polytechnic Institute (WPI) educates 3,746 undergraduate students and 1,557 graduate students and employs 425 employees (Management, 2011). The school currently offers two parking garages (one on campus and one 1 mile off campus) and nine parking lots, many of them are only available to commuters or faculty only. Although parking is available on the street, much of the parking is unavailable during the winter months (Dec 1-Apr 1), and a walk through the streets reveals every side of the street full of parked cars, with many people parking on side streets because there are not enough places to park. A lack of available parking spaces/areas has become a problem on campus at WPI.

To combat this problem, WPI has funded and built a new 500 car parking garage. The parking garage will have an athletic field (softball and soccer field) on top of it to provide for the soccer field and softball/baseball field demolished during the construction of the newly built Recreation Center.



Access to and from the athletic field is currently limited to the stairs/elevators in the facility and a makeshift access ramp for snow removal vehicles; however, it is in WPI's interest to construct a bridge from the field to the back of Harrington Auditorium to allow for convenient travel between the field/garage and the campus for the students and convenient access for the snow removal vehicles and equipment. The bridge was discussed during the design phases of the Parking Garage and Athletic Field; however, due to the price of the Garage and Field, the bridge was put on hold.

Background

Materials

Concrete

Modern concrete was developed in the mid-18th century and has resultantly become one of the most important and highly utilized contemporary building materials. Formed by a chemical reaction, called hydration, concrete forms a unique material which gets harder over time. Concrete can be broken down by the sum of its ingredients; aggregate, cement, water and chemicals called admixtures.

Aggregate is typically classified in two forms, coarse aggregate and fine aggregate. Coarse aggregate consists of gravel and crushed stone, while fine aggregate typically consists of silt and sand sized particles. The ratios of these ingredients can be a key factor in the resultant compressive strength of concrete. To account for this, aggregate is usually separated and classified according to the amount which fits through a series of sieves. Size is limited by two key factors; workability and rebar spacing. Workability is classified as the ability of the concrete to move around and flow which is very necessary in order to be pumped to the job location as well as fit into forms on site. Similarly, aggregate size is limited to less than the minimum spacing of the rebar used to reinforce the concrete because otherwise the concrete would leave large voids, compromising the structural integrity of the finished structure.

Cement acts as a binder for the aggregate through the chemical process of hydration. Commencing as soon as Portland cement gets wet and continuing indefinitely, this process provides a strong chemical bond which makes concrete's strength possible. Concrete is typically considered to be cured 28 days after pouring, but this only represents 90% of the potential compressive strength and is usually sufficient to support the necessary loadings. Curing must be done in a controlled environment in order to prevent structural cracking. Abnormally fast drying can cause tensile failures due to the uneven nature of the curing process. To counteract this problem, it is important to control the moisture, usually using a system of hoses and plastic sheets to keep the surface moist.

Water is the key ingredient in concrete and the ratio of water to cement helps determine the final strength of the concrete. The rule of thumb is to add the minimum amount of water necessary to ensure that all of the cement gets wetted and also so that the concrete remains fully workable until it is set in its forms. The water/cement ratio can range from 0.3 to 0.6 in most concrete formulas. Without enough water the concrete may harden prematurely and leave voids in the finished product. Too much water will weaken the compressive strength of the concrete and could result in structural failures.

Although concrete is traditionally a composite of aggregates, cement and water, various admixtures have been developed over time to improve and adapt concrete to fit different needs

and environments. Admixtures are known to accelerate and retard the curing process depending on the extreme needs of a job site. In addition, air entrainment is common which is used to add air bubble to the concrete which help absorb the impact of thermal expansion and reduce cracking. There are also plasticizers and pumping aids which can help increase the workability of the product. To suit certain environments there are also corrosion inhibitors and bonding agents. Lastly there is the ability to add pigment at the mixing stage which adds an architectural detail which results in a smooth uniform finish.

Concrete has become one of the most utilized building materials because of its superior properties, primarily its compressive strength which typically ranges from 3,000 to 5,000 psi. Many different forms of concrete exist which have significantly higher or lower strengths but that value is most commonly used. Concrete is also known for its durability, fire resistance and low coefficient of thermal expansion. Lastly, concrete has the ability to be put into decorative forms which can add character in addition to pigment.

In contrast, concrete is very weak in tension and is resultantly reinforced with steel when necessary. Steel rebar is often bent and tied into place within formwork before pouring concrete so that a composite material is formed which has both high compressive and tensile strengths. Another way in which concrete is strengthened is by pre-tensioning cables along a beam and allowing the concrete to set. This pre-stresses the materials and allows the concrete to be used effectively as a beam. The other large weakness of concrete is water invasion. When water gets into small cracks and freezes, it can wedge to form larger cracks which are known to be structurally compromising. In addition, water serves to corrode any steel reinforcement. As a result any methods of reducing water invasion can be very beneficial to the long term strength and durability of any concrete structure.

Steel

Steel is another commonly used material in modern construction. When it comes to the design of bridges, steel offers many attractive advantages. One of the most important advantages gained through the use of steel is its high strength to weight ratio. This may be a crucial advantage when it comes to the design of the new pedestrian bridge. This superior ratio could have many positive impacts on the design of the bridge. One of the most important factors that the high strength to weight ratio could impact is that it will allow the bridge to carry a greater load for a shallower depth. Since the clearance from the ground to the bottom of the bridge must be over 12'¹ and the top of the bridge is about 14'² from the ground, we are left with a maximum bridge depth of about 1 $\frac{1}{2}$ '. Thus, a material that can transfer a greater load at a shallower depth is required for the bridge. Additionally, the transportation and placement of the beams required may be easier due to their low self-weight.

¹ Height of an average fire engine (See Section **Error! Reference source not found.**)

² Determined from construction plans for new WPI Parking Garage

Steel may also contribute in the reduction of construction time. WPI would likely prefer not to close down the area where the bridge will be constructed for an extensive time. During bridge construction one of the exits/entrances to the new parking garage will need to be closed as well as the stairway located between Harrington Auditorium and the new recreation center. It is easy to see why the closing of this area for an extended period of time during the WPI school year would be unfavorable. But that is just another hurdle steel can handle. With many of the components of the bridge being prefabricated, construction time would be greatly minimized. There have even been bridges installed in as little as one night. Figure 6 is an image of the Hallen Bridge over the M5 motorway in Great Britain. This bridge weighs in at a whopping 500 tons. The bridge was prefabricated in sections which were shipped to a site near its final location. After the sections were pieced together, the bridge was transported into its final position during one overnight closure of the M5 motorway. This bridge clearly demonstrates the advantages of steel in terms of rate of construction.



Figure 33: Hallen Bridge

Furthermore, steel is a highly useful material for bridge design not only from a material standpoint, but also from an architectural standpoint. Using steel unlocks a wide range of architectural possibilities. Steel can be manipulated and fabricated into many creative shapes. This will allow for the bridge to be designed with more architectural and aesthetically pleasing features. As seen in Figure 7 steel can be curved and shaped to form magnificent figures. This is

essential in the design process for the pedestrian bridge to be designed as aesthetics certainly play a role.



Figure 34: Merchants Bridge

Composite

In addition to Steel and Concrete, Composites have seen rising consideration in bridge design. Composites are mostly used as a reinforcement alternative to steel in reinforced concrete decks, all composite decks and bridges themselves have been constructed. Currently, there are two process types for the fabrication of composite bridge decks: sandwich structures and adhesively bonded pultruded shapes, which will be referred to as pultruded from now on. Pultruded composite decks are the least expensive fabrication technique. The main resins in composite decks tend to be either the lower costing polyester resins or the corrosive-resistant vinyl ester resins. Which resin is used depends on which characteristic is desired: low cost or corrosion resistance. Pultruded deck formations typically consist of, but are not limited to, four formations, seen in , Lowes' Motor Speedway, North Carolina



Figure 35: Common cross-sections of FRP decks from pultruded components.

8.15.1 Truss

Bridge trusses were developed as an economical and practical way of meeting the needs of America's expanding train system in the 18th century, although they have earlier roots in Europe for similar purposes. They are derived from a series of triangles, which happens to be the only shape which will maintain the angles between members when you fix the length of the members. This unique characteristic produces the strength of the design in general.

Because of the stresses on the members of any truss they are typically constructed out of materials with high tensile strengths. Initially they were constructed out of wood, but as iron was developed into steel, steel became a more popular material for the construction of trusses. More recently, especially in the case of pedestrian bridges, prefabricated trusses have become more popular. This way a bridge is constructed economically and safely under controlled conditions at a factory. Afterwards it is simply lifted into place using a crane, which minimizes onsite costs. Prefabricated bridges were initially developed by the British military in the 1930s and eventually found their way into commercial bridge manufacturing.

There is a lot of terminology related to understanding truss bridges which allows for analysis. First, trusses can be classified as planar, which means that all members fall into a 2 dimensional plane, or special which means that members venture out into 3 dimensions. The point of contact between members is called a node. For the purpose of analysis, nodes are considered to be simple pins which cannot create a moment between members, but in reality these connections can exert a small moment. Stringers are the members that connect parallel trusses and typically act perpendicularly to the direction of travel. Stringers also provide support for the floor beams which subsequently supports the decking. Struts and bracing help prevent torsion between parallel trusses by providing diagonal bracing against wind and seismic loads. The upper edge and lower edge of a planar truss are referred to the top chord and bottom chord respectively. Any other diagonal members in the truss are considered web members which help distribute the load.

Simple analysis of truss bridges can be completed through static analysis of Newton's laws. In reality a bridge is rarely a statically determinate system and must be analyzed as such. This is where software comes in to help quickly and accurately analyze the viability of different designs.

There are countless examples of different truss types which can excel in different situations and loadings as seen below in Figure 11.

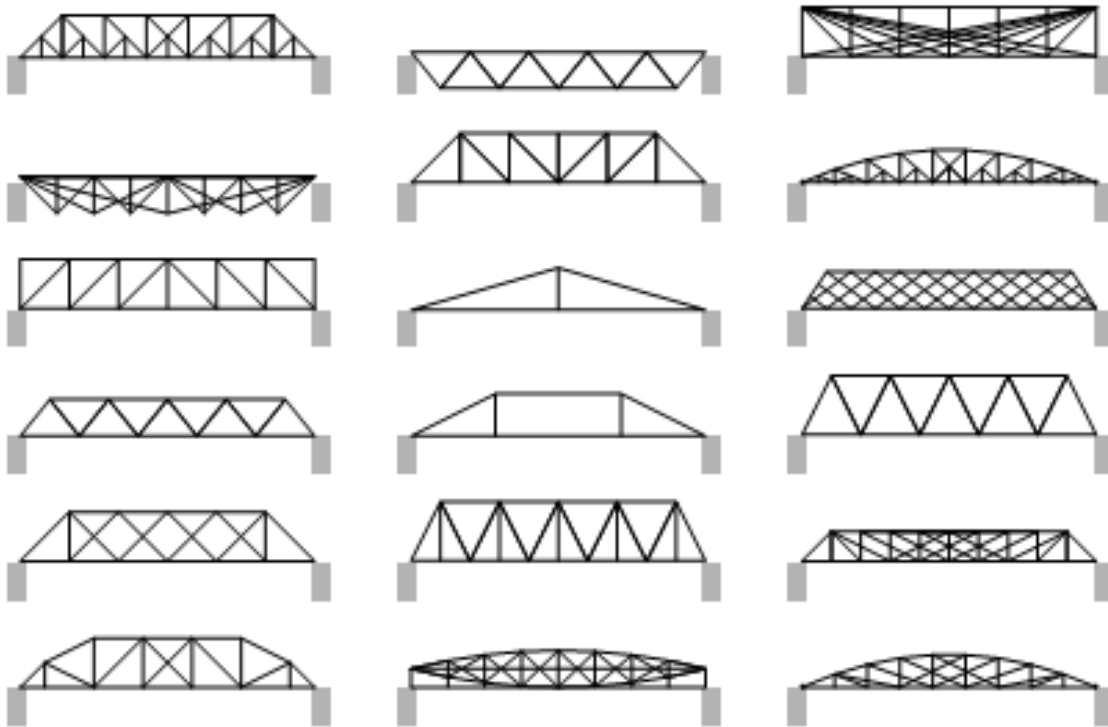

Figure 11: Various types of truss designs

In addition some bridges use a pre-cambered design to counteract expected loads and reduce sagging. To reduce sway from wind and seismic loads in pedestrian bridges it is important to keep the ratio of width to span above 1:20 (Comp 1977).

8.15.2 Arch

Arch Bridges have a very long history; the advantages of the arch shape were discovered by the Sumerians around 4000 B.C. and soon were applied to bridges to overcome obstacles. The Arch shape is described as a curve. Some common nomenclature associated with arches is listed below in Figure 12.

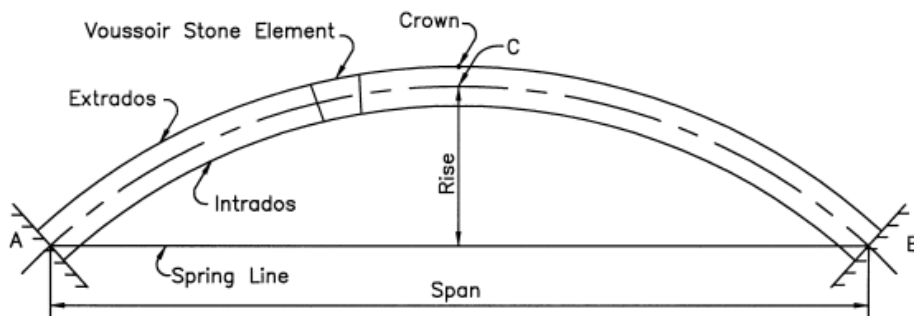

Figure 12: Arch Nomenclature

We found arch bridges to have many advantages, mainly in their simplicity of shape. Arch bridges are very competitive with truss bridges in terms of cost for spans up to 900 feet, making the arch bridge cost effective and economical (Fox, 2000). Furthermore, creating an arch bridge for the short span would be relatively simple to design. After calculating moments and axial forces, the correct proportions for the deck, ribs, ties, hangers and columns can be gathered.

Some disadvantages with arch bridges are that a very stable foundation is required because of the large horizontal forces applied from the arch shape. In addition, the curvature of the arch is complex to form because the precast steel or concrete must fit the shape of the curve to prevent possible buckling of the bridge.

There are many different types of arch bridges, each with unique benefits for a particular situation. Some common variances are seen below in Figures 13, 14, 15 and 16.

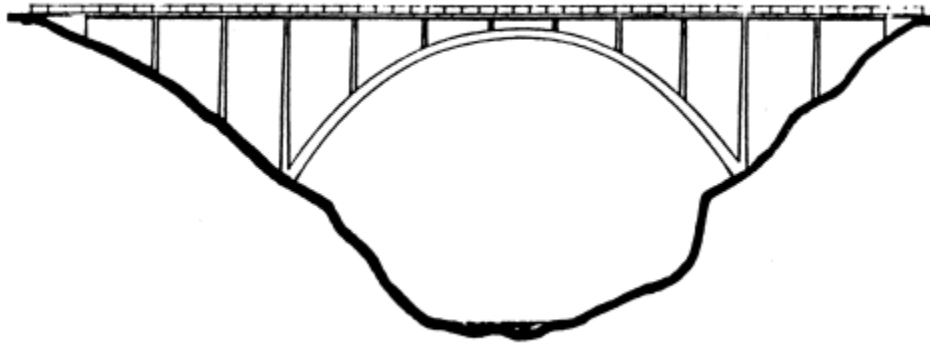

FIGURE 17.2 Concrete true arch.

Figure 13: Concrete True Arch

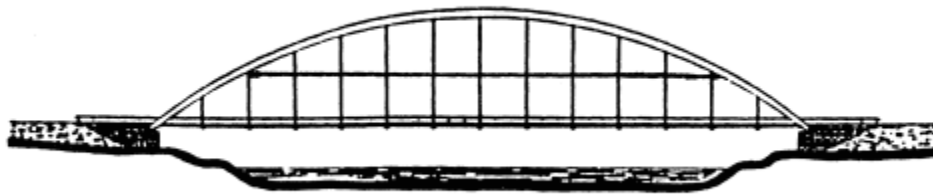

FIGURE 17.11 Horizontal cable connecting hangers.

Figure 14: Horizontal Cable Connecting Hangers

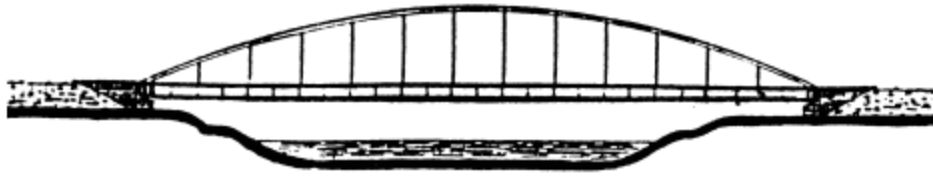

FIGURE 17.3 Steel tied-arch bridge.

Figure 15: Steel Tied-Arch Bridge

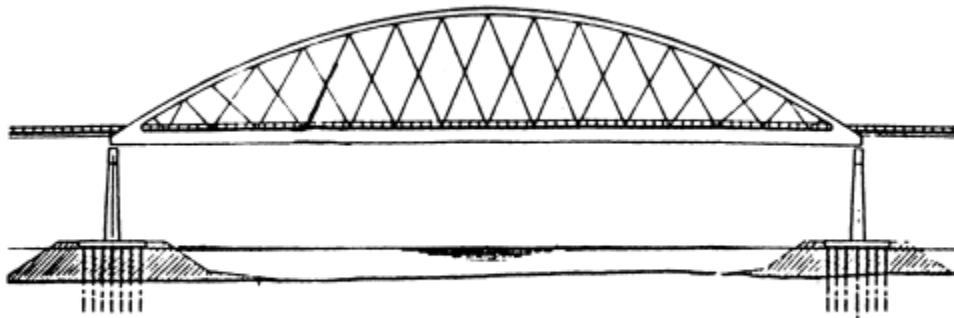

FIGURE 17.4 Arch with diagonal hangers.

Figure 16: Arch with Diagonal Hangers

8.15.3 Cable-Stayed

Cable-stayed bridges have several key components when considering their design: their spans, cable system (and its connection), towers, and superstructure (deck). Cable-stayed bridges generally consist of two-spans, either symmetric or asymmetric, three-spans, or multiple spans. The asymmetric 2 span cable-stayed bridge has a large span that is 60-70% of the total length of the bridge and with more than 2 spans; the center span of the bridge tends to be 55% of the total length. One additional way of designing the span of a cable-stayed bridge is to have the back stays anchored to “dead-man” anchorage blocks, and only one span is supported by stays”. The cable system can be constructed in a variety of configurations in both the transverse and longitudinal directions, which can be observed in Figure 17 and Figure 18 respectively. The double plan configurations have the advantage of locating the cables either on the outside or within the limits of the pathway. However, they may require additional reinforcement for the eccentric cable loadings into the main girders and there is a need for additional deck width for anchorage fittings. Although there are no real advantages and disadvantages for the different cable arrangements, the general advantage of the cables comes in the number of cables utilized. When more cables are utilized to simplify cable anchorages, it generates a more uniform distribution of forces. In addition, more cables leads to a shallower girder depth and increased stability of the bridge against wind forces. However, more cables cost more money which is important to keep in mind. The towers may act as either single or double cantilevers (depending

on whether single or double plane cables are used). The difference between single and double cantilevered towers is that single cantilevered towers stay within the vertical planes, while double cantilevered towers 'lean' out of plane. Single and double plane cables follow a similar rule, where single cables are purely vertical and double plane cables have an angle to them. The design of the towers themselves must consider two main components: the base and the frame. The base of the towers can be either fixed or hinged. Fixed bases induce large bending moments at the base of the tower, but offer increased rigidity of the total structure and can be more practical to erect. Hinge-based towers need to be externally supported until the cables are connected. The frame of the towers is typically designed in three basic ways: Modified A-Frame, Diamond, or Modified Diamond or Delta, seen in 19. The design of the frames can be mostly considered based on aesthetics; however, the diamond and modified diamond or delta frames offer additional height clearance and less pier width compared to the modified A-frame tower. The tower heights are usually 20% of the length of the main span, although this can vary depending on the specific bridge. The bridge deck depends on the material chosen (concrete, steel, or composite). Each has their own advantages and disadvantages; however, the advantage that cable-stayed bridges offer for the bridge decks is a higher span to depth ratio. Although the ratio itself is highly variable (due to the number of cables used, materials, etc.), the ratio for two span asymmetric can be 100 by anchoring back stays to the girder directly over the piers, and in general, bridges that are double plane with multi-stays have a ratio between 120 and 260.

Although cable-stayed bridges are more commonly used when bridges need to be lightweight (poor soil conditions or large spans), they can be considered for short pedestrian bridges. Cable-stayed bridges offer additional clearance compared to girder bridges because they eliminate the necessary piers of the simply supported bridges. Although aesthetics is always a matter of opinion, cable-stayed bridges are typically considered more aesthetically pleasing and they have numerous options for the design of the cables, allowing for more variability in appearance. The span moments can be controlled by the spacing of the cables to make the moment along the span more uniformly distributed. Due to the added cable forces in the cable-stayed bridges, large connection and girder support is needed to accommodate the cables. Design considerations must also include wind loads due to the one way support of the cables which can result in significant movement to the bridge deck if the deck is not restrained properly. Cable-stayed bridges also tend to be more expensive than a truss or simply supported bridge, especially in areas in which contractors and engineers don't necessarily have the expertise in cable-stayed bridge design or construction.

8.16 Design Criteria

8.16.1 Americans with Disabilities Act (ADA)

One of the requirements of any structure designed and constructed in the United States is to comply with the regulations set forth by the Americans with Disabilities Act (ADA). The ADA was recently updated in 2010 and these updated standards must be complied with if the start of construction date is on or after March, 15, 2012, which will be the case for our bridge. In the

updated standards, the requirements applicable, or may be applicable consist of sections 302.3, 303.2, 303.3, 303.4, 305, 307, 402.2, 403, 404, 405, 505, and 609.8.

Section 302.3 and section 303 consists of details regarding the walking surface of the bridge, stating that the walking surface shall be “stable, firm, and slip resistant.” 302.3 states that if there are any openings, such as a grated surface, the openings shall not exceed ½”. Sections 303 state that there shall be no vertical change greater than ¼”. The surface may be beveled between ¼” and ½” with a slope no greater than 1:2 if need be. If the surface is to be ramped (change in height greater than ½”), the surface must comply with sections 405 or 406, which ultimately state that ramps with a rise of greater than 6” must have handrails installed.

Sections 402 and 403 deal with the limitations of the walking surface, such as the running slope shall not exceed 1:20, the cross slope shall not exceed 1:48, and the clearing width for each lane of travel shall not be less than 60” (which means our bridge must be able to support 10’ for the expected 2 directions of travel). Section 505 deals with the application and design of the handrails, stating that they must be continuous along the entirety of the walking surfaces length. Additionally, the handrails must be 34-38” above the walking surface and have at least 1-1/2” minimum clearance between the rail and any adjacent surface. The gripping surface of the handrails must also be unobstructed for at least 80% of its length (with a 1-1/2” minimum bottom clearance when obstructed) and shall be free of sharp or abrasive elements. The handrails shall have rounded edges and, if circular, have an outer diameter between 1-1/4” to 2”. If the handrail is nonrectangular, the perimeter shall be between 4 and 6-1/4”, but with a cross-section dimension not exceeding 2-1/4” (as seen above in Figure 20). Section 609.8 states that the allowable stress in the handrails “shall not be exceeded for the materials used when a vertical or horizontal force of 250 pounds is applied at any point on the handrail, fastener, mounting device, or supporting structure. Section 505.9 further states that the handrails shall not rotate .

8.16.2 Aesthetics

It is important that the bridge fits into the existing landscape and does not seem overly intrusive. To achieve this, the design of the structure must match the architectural features of the adjacent buildings as seen below in Figure 21 and Figure 22. The aesthetics of nearby buildings can be summarized as brick, concrete and glass. It will be important to not only match these materials but also the feel that these materials give. The current area does not have visible steel which means that any steel might seem out of place. One way to address this would be to consider a thinner structure which flows with the landscape rather than dominating it.



Figure 21: Looking Towards the Loading Dock



Figure 22: looking Towards the Parking Garage

Since WPI is a science and engineering university, there is also potential for an architecturally significant or structurally significant design. This could make the bridge less of an object fitting into the existing landscape and more of a landmark for the school.

8.16.3 Site & Constructability

Constructability is an important factor when considering design parameters for the proposed pedestrian bridge. We must also consider how long construction will take and how it can be scheduled to avoid conflicts with academic and sporting activities. In, addition there is a concern that the access road to the garage may need to be temporarily closed during parts of construction. These are important questions that need to be answered. It is in the best interest of WPI for construction to take place during the summer months, between the months of May and August, when majority of students and faculty are away from campus and pedestrian traffic will be at a minimum since the main entrance to the garage and field lies directly under the proposed location of the bridge. If possible, the design team should select a bridge that will be able to be constructed in this window. In addition, the garage access road ends at a turn-around right before the proposed bridge, so only a partial closure of the turn-around should be required. The turn-around could be used for staging of construction material as well as a stable area for a crane

during erection of the superstructure. Although the access road provides egress to the North, there is very little access from the east and almost no access from the south and west due to the adjacent buildings and running track. It is a very tight site and must be able to accommodate traffic and student athletic uses during construction. In addition the construction cannot block off fire access to the new recreation center.

8.16.4 Economy

A major design parameter in our research for a bridge is the budget. Currently, there is no set budget for this project because there is no official bridge design chosen. However, initial estimates were given by Fred DiMauro, with \$300,000 USD allocated to the bridge, with \$1,000,000 being a maximum feasible cost for the bridge, promenade and site work. Alternative procedures will be investigated to decrease the cost of the bridge, such as looking into different designs, construction materials, and the construction processes.

8.16.5 Environment

Environmental impacts should always be considered during any construction. However, since the bridge will be located in an area that has seen 2 extensive construction projects, it is assumed that the construction of the bridge would have little to no additional impacts. Still, an environmental impact report would need to be considered if construction of the bridge were to be approved.

8.16.6 Fire Code

The Commonwealth of Massachusetts is the authority having jurisdiction over Worcester County, and with neither having a proper fire code for pedestrian bridges, it is advisable to follow the International Fire Code (IFC) under section 503.2.6 for Bridges which states:

“Where a bridge or an elevated surface is part of a fire apparatus access road, the bridge shall be constructed and maintained in accordance with AASHTO HB-17”.

This code calls for a clear height of 13’6” as well as a width of 12’0” for fire trucks (Code 2000). Worcester County considers this to be a fire apparatus access road, because in the event of a fire in the new recreation center, there would be no other direct access to the back of the building.

“Bridges and elevated surfaces shall be designed for a live load sufficient to carry the imposed loads of fire apparatus.”

The above excerpt from IFC suggests that the bridge should be able to support the weight of the truck, but according to Fred DiMauro, it is unnecessary to design for a Fire truck to travel over the bridge.

“Vehicle load limits shall be posted at both entrances to bridges when required by the fire code official”

The above excerpt from IFC will be important to keep in mind to designate the maximum allowed vehicle weight on the bridge.

It is vital to note that fire codes are considered somewhat flexible in that they should be adapted to the situations present. IFC is used as a guide, not an infallible law. The Worcester Fire Department will be required to sign off on all plans before construction, so design work should be coordinated to meet their needs in the event of a fire.

8.16.7 Geotechnical Concerns

An important concern that is pertinent to our bridge design is that there will be a bridge landing and foundation constructed next to the parking garage. Figure 23 below shows the area under construction in which the bridge foundation will be placed. There has to be a properly designed foundation that will withstand the vertical as well as the horizontal loads caused by the potential bridge. Without these, excessive settling, bridge failure and damage to the parking garage can be major concerns.



Figure 23: Garage in construction, showing area of interest for foundation

8.17 Design Tools

In order to expedite design, we need to utilize structural analysis tools to quickly iterate between designs, loadings and members sizes efficiently. Once we achieve a design we need to provide three-dimensional imagery for WPI. This can be used to evaluate the aesthetics as well as the functionality in the landscape.

8.17.1 Sap2000

We have selected Sap2000 for its diversified structural analysis abilities as well as its ability to convert through REVIT in an iterative manner. SAP (Structural Analysis Program) has existed

for many years and is considered a premium analysis software suite around the world. It has been used in many structures such as dams, bridges, and even the world's tallest building. The user interface is known to be intuitive, mirroring tools available in other CAD software for easy cross over. Sap2000 contains all applicable structural codes necessary to be accounted for in addition to a material library for quick changes and further analysis. SAP2000 can perform analyses based on deflection limits as well as failure modes and allows for analysis of different load combinations simultaneously.

8.17.2 BIM

Building Information Modeling (BIM) is a process developed into a software package which represents various systems of a building in three special dimensions. In addition, more recently a 4th dimension, time (4D BIM), has been integrated. This way 4D BIM allows the visual representation of both the construction and cost of the building as it is built in accelerated time. BIM allows for the expedited design of various buildings and structures with an integrated library of materials and structural components. We will utilize REVIT, a software suite owned by Autodesk, to design our bridge in addition to the site layout and adjacent buildings. This will save time on several levels. First, skipping the traditional time factor of two dimensional modeling will save time in constructing three dimensional renderings for WPI later and add the ability to visualize conflicts. In addition the structural data may be exported from SAP2000 for via an .IFC file, which can be imported into REVIT to create a detailed visual representation of the bridge and its surroundings.

THE REMAINDER OF THIS PAGE WAS LEFT INTENTIONALLY BLANK

9 Preliminary Design

Our design process began with our parameters from Section 2.1. With these ranges and all applicable codes from Section 2.4 in mind, we began to select proposed dimensions to begin design. The bridge length was constrained by the elevations as described in section 2.1, which we later verified by performing our own site survey (see section 3.2 below). The width was to be between 8'0" and 15'6" and we chose a width of 14'0" to accommodate larger vehicles and provide a significant looking promenade between campus and the fields per WPI's wishes. The elevations from Section 2.1 were constrained by existing site features and were later verified by our field survey. The final grade was calculated as +2.76% from the parking garage to the loading dock which is well within ADA's <5% requirement. The final proposed dimensions are summarized below in Table 2 along with the constraints from Section 2.1.

Parameter	Minimum	Maximum	Proposed
Length	No Constraint		160' 0"
Width	8'0"	15'6"	14'0"
East Elevation	528'7"	544'7"	541'0"
West Elevation	536'7"		536'7"
Truck Clearance	0'0"	1'1"	1'1"
Grade	-5.00%	5.00%	+2.76%

Table 2: Design Parameters

The process continued by selecting two bridge types as well as materials which is discussed below in Section 3.0. We continued by pulling information from the construction documentation provided to us by Gilbane for the garage and recreation center (Section 3.1). The next step in the process was to take our own survey data to provide accurate dimensions for analysis in Sap2000 described in Section 3.2. Lastly, we selected loadings and load combinations which we discuss below in section 3.3.

9.0 Selection Criteria

A number of criteria were used to determine feasible alternatives given the requirements and constraints provided WPI with the best solution. These criteria included; depth, cost, aesthetics, sustainability/maintenance, and constructability. Depth of the bridge superstructure is the most important aspect, because it constrains the entire design. Cost is also a major criterion as the project will likely have a budget of around \$1,000,000 USD (Section 2.0.1). The costs will include; cost of materials, labor, and transporting the materials. Aesthetics plays a major role as the bridge will be part of WPI's new promenade and main gateway to campus. The bridge must look worthy and cannot look out of place with the new recreation center located directly behind it. Aesthetics were measured by group consensus. Sustainability/maintenance is important as it would be favorable to use materials that will not need to be repaired constantly. Also, it is preferred that the material used be recyclable upon the end of its life-span. Finally, the constructability criteria favored alternatives and materials that were less time consuming to implement as well as less difficult to erect into position. See Table 3 below for our ranking of

each alternative. With 1 being the best and 4 being the worst, the rankings are purely relative to each other and are not quantifiable beyond their relation to each other.

Selection Criteria				
Bridge Type	←More Important		Less Important→	
	Depth	Cost	Aesthetics*	Maintenance
Truss	2	2	2	2
Simply- Supported Beam	3	1	3	1
Arch	1	3	1	2
Cable-Stayed	1	5	1	2
Arch-Cable Suspension**	1	4	1	2

Table 3: Selection Criteria

After this evaluation we decided to only continue with an arch bridge and a truss bridge. We discounted the simply supported bridge due to its excessive depth and lack of aesthetic appeal. In addition, we discounted the cable-stayed bridge because of outlying cost.

Materials were evaluated separately since not every material can be applicable to every type of bridge. Specific application and discounting of materials is discussed below in Section 3.3.

9.1 Construction Documents

We obtained construction plans for the new parking garage from Gilbane. These plans included site plans, drainage plans and foundation plans. In addition we obtained geotechnical reports that allowed us to determine preliminary soil characteristics on the site. We determined that the soil is of good quality with shallow bedrock, and also that the foundation for the parking garage should not interfere with the piers on the west end of the proposed bridge. The drainage plans show storm water infiltration pipes directly underneath the majority of the span of the bridge. After discussing with Gilbane, we determined that some of these could easily be excavated and removed if necessary in order to support a middle pier. In looking at the grading plans and evaluating the storm water infiltration pipe manufacturer’s specifications, we determined that the pipes were buried to the minimum allowable depth under the bridge, so any site work could not effectively lower the grade.

9.2 Site Survey

Although the project began while the Parking Garage was still under construction, the project team had the advantage of performing a site survey of as-built conditions, to ensure that the measurements recorded and assumed in the construction documents regarding the height and length from the loading dock at Harrington Auditorium to the elevator landing on the Parking Garage were accurate.



Figure 24: James DeCelle Conducting Surveying Shots



Figure 25: Here the bridge decking will meet the Parking Garage



Figure 26: The Bridge Decking will meet with the Loading Docks behind Harrington

The group used a benchmark in the parking garage that Gilbane referred us to. This allowed us to determine the height of the gun and record the angles of all subsequent shots, which would be used to determine the distances between points. The subsequent shots identified the left and right opening at the elevator shaft in the parking garage and the left and right connection points at the loading dock by Harrington Auditorium.



Figure 27 : View From Harrington, overlooking the construction Area, the Parking Garage is in the Distance

Once the information was recorded, a simple excel spreadsheet and the application of the law of cosines was used to determine the distances between the loading dock and the parking garage connection, as well as their heights. The results can be observed in the summary table in Appendix B.

The results were almost identical to the assumptions made from the construction documents, thus confirming the bridge’s span and height requirements. The resultant distances are summarized below in Table 4.

	(FT)
Distance L-L	162.07
Distance R-R	154.30
Delta Elevation L-L	5.03
Delta Elevation R-R	5.14
Dock Width	18.01
Opening Width	15.57

Table 4: As-Built Survey Distances

9.3 Deflection & Load Requirements

As determined from our interview with Fred DiMauro and independent research, the clearance of the bridge must clear an estimated 13’6” tall fire truck. There is roughly a 30 foot area between the parking garage and the slope up to Harrington Auditorium that has a grade of 522’, which is the same elevation as the garage floor. Our bridge will connect to the main stair area, which is located at an elevation of 536’-7”. This gives us only 1’-1” of clearance, and, realistically, we are limited to a bridge depth no greater than 1’. Our site survey determined that the bridge must cover a maximum distance of 162’1”. Preliminary checks over each type of bridge were performed to determine which bridge design options are viable for these conditions. The main check is a simple deflection limit check to determine the minimum depth of each bridge design, and those that are too deep were immediately deemed not viable. We then took the two remaining viable bridge designs and proceeded into advanced design for them below in section 4.1 and 4.2 using the following loadings.

The Load and Resistance Factor Design, (LRFD) was used to design all bridge members components and connections. The AASHTO Guide Specifications for Design of Pedestrian Bridges (2009) were used, along with any other AASTHO material referenced. Figure 28, as seen below shows the different load combinations as provided by AASHTO. The AASHTO *Pedestrian Bridge Design Guide* states that, for pedestrian bridges, strengths II, IV, and V may be ignored. Furthermore, the load factor for fatigue I load combination were taken as 1.0 (not 1.50) and fatigue II was ignored. The AASHTO design guide also specified the deflection limits for pedestrian bridges. They were investigated, at the service limit, using service I and may not exceed L/220 for cantilever arms, or L/360 for spans other than cantilever arms, due to the

unfactored pedestrian live load, which is specified as 90 psf. The vehicle live load was designed for strength I load combination and was not placed in combination with the pedestrian live load.

AASHTO provided the weight distribution and dimensions of the design vehicle and require the vehicle to be placed to produce the maximum load effects. Because the clear deck width is expected to be 14' (in accordance with ADA regulations), design vehicle H10 will be used. Furthermore, due to the slenderness of pedestrian bridges, a vertical uplift live load of .02 KSF over the full deck width was applied . Additionally, a lateral wind load was applied to the bridge members and was calculated in accordance with article 3.8 in AASHTO's Bridge Design Manual, and the load value is specific to each bridge and its individual members. The fatigue live load was used as specified in the AASTHO design manual, section 11. Below, Table 5 shows the constant values used for each bridge design.

Load Type	Load
Pedestrian Live Load	90 PSF
Vehicle Live Load	20,000 LBS
Wind Load (V)	25 PSF

Table 5: Unfactored LRFD Design Load

10 Design & Analysis

10.0 General Analysis

Although there were two different bridge alternatives, the bridge decking and design loads were the same for both bridges. We narrowed down the material from steel, concrete, FRP and wood down to just concrete and steel for their durability, cost and availability in a variety of shapes and sizes. The simplicity of the decking and relatively short length of the bridge necessitated using a cast in place deck instead of a precast deck which would have been more expensive to produce for such a small custom job. In addition, precast panels would have necessitated the use of a crane to get them into position, adding to the equipment rental costs.

10.0.1 Bridge Deck Design

The bridge decking for both options shall be made of a simple cast-in-place concrete deck. This is largely due to the fact that a steel based decking would be less cost effective as the cost of steel is relatively large compare to concrete. The bridge decking will be composed of normal weight concrete (150 pounds per cubic foot, $f'_c = 4$ ksi) and #5 steel rebar ($f_y = 60$ ksi). The loads applied to the deck include; 90 pounds per square foot for pedestrians, 20 pounds per square foot to accommodate for vertical wind loads, 100 pounds per square foot for self-weight, two 10,667 pound loads to account for the maximum effective distributed weight on each axel of our design vehicle, and 25 pounds per square foot to account for a 2" wearing surface to go on top of the decking. The vehicle weight distribution was calculated according to Article 4.6.2.1.3 of AASHTO which states that the distribution width for positive moment is $(26 + 6.6 S)$ in. where S is spacing in feet. The maximum moment produced by the vehicle was found using Table 3-23 case 10 of the AISC Steel Construction Manual. The shear and moment diagrams from this case can be seen in Figure 29.

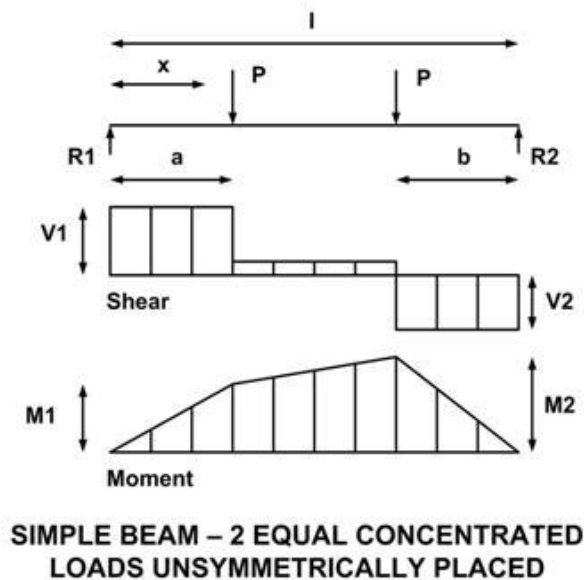

Figure 29:AISC Table 3-23 Case 10

The dimensions of the deck shall be 14' wide, about 160' long (cast to span entire bridge) and 8" deep. The top and bottom covers to the rebar shall be 2". The bridge deck is designed in a section with the dimensions of 14 feet x 1 foot x 8 inches deep. The deck is designed as a one way slab spanning 14 ft. The 1' length will be assumed to be duplicated for the length of the bridge span. The major governing factor is that the deck should be designed for its moment resistance. The maximum ultimate moment for the bridge (using AASHTO load combinations) was found to be 11,974 ft-lbs. For simplicity, this value was rounded up to 12,000 ft-lbs for hand calculations. Using this value and the assumed dimensions of the deck, it was found that the deck would require 2.83 #5 sections of rebar per linear foot. For simplicity and as good engineering practice, this value was rounded up to three #5 bars per foot spaced at 4" on center. The deck also requires temperature and shrinkage steel, spanning both the lateral and longitudinal directions. These bars will also be made from #5 rebar and will be evenly distributed between the top and bottom of the deck. Since the deck dimensions are relatively small, the spacing of the bars is governed by the maximum allowable spacing, which is specified at 18" O.C. This holds true in all areas except where there is already reinforcing steel, since there is an excess amount of reinforcement to cover for the temperature and shrinkage of the steel. Computer sketches of various sections can be seen below in Figures 30, 31 and 32. All detailed calculations can be viewed in Appendix K.

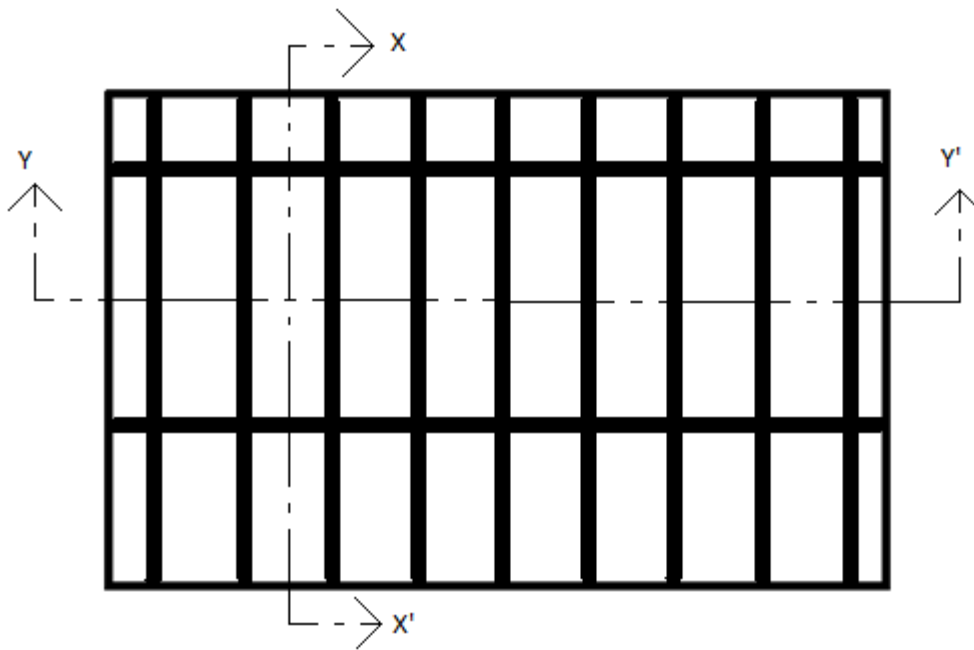

Figure 30: Plan View of Decking (Overhead)

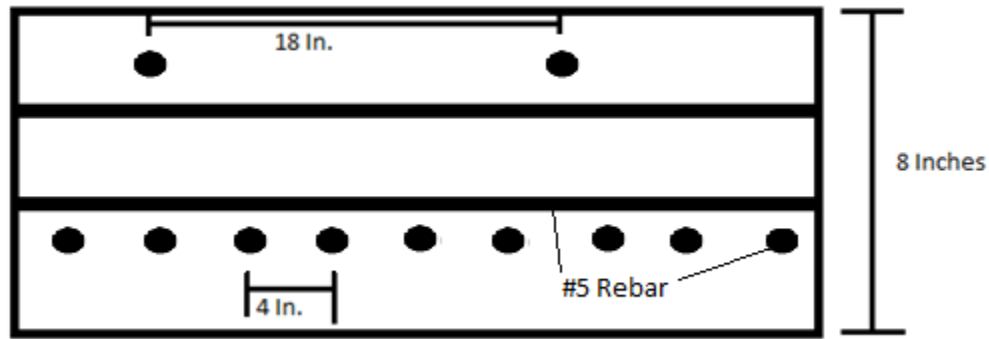

Figure 31: Cross-Sectional View of Decking in Y-Y' Direction

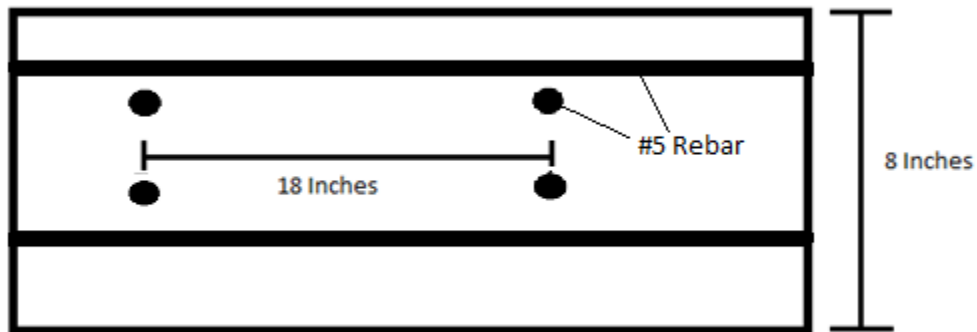

Figure 32: Cross-Sectional View of Decking in X-X' Direction

10.0.2 Bridge Load and Member Sizing

The bridge design is required to comply with the loadings set forth through AASHTO as previously discussed in Section 3.3. Additionally, a uniform dead load of 29lbs/linear foot was applied to account for the weight of the railings . Finally, a uniformly distributed dead load was applied to account for the weight of the wearing surface. Multiple sources revealed that a 2” thick, concrete wearing surface is ideal for pedestrian bridges . Due to the limitations of our version of SAP 2000 (educational version), surface areas could not be loaded. Instead, the bridges were analyzed in 2D. To account for this problem, the bridge was loaded with a uniform dead load to account for the weight of the concrete slab, which was calculated with the following formula:

$$(150 \text{ pcf}) * 8/12' \text{ (deck thickness)} * 7' \text{ (tributary width of each bridge girder)}$$

A similar process was used to account for the wearing surface. Since we evenly spaced floor members connection the sides of the truss and the arches respectively at 14’, the pedestrian live load and vertical wind load were all multiplied by 7’ to account for the tributary area that each floor member would support. The vehicle load was run along the girder. AASHTO allows for the load to be distributed via a factor due to moment redistribution through the bridge deck to both bridge girders. AASHTO calculates this redistribution factor through the Lever Rule shown in Section 4.1. The live load was then multiplied by this factor in each load combination. The

one loading that varied from each bridge alternative was the horizontal wind load. The wind load is calculated through several equations in article 3.8 of AASHTO. However, the different heights of the bridge members and the different bridge members' sizes are what vary from the truss and arch bridge (see sections 4.3 and 4.4 for more detail). Once the loads were defined and the values were calculated, they were applied to the bridge model in SAP. The H10 truck was created in the moving loads section of SAP, as seen in Figure 33. Then the moving path for the vehicle was defined, inputting the girder as the moving path. Then, load patterns were defined for the different loadings. A pedestrian live load, dead load, DW (wearing surface), wind, and H10 truck load patterns were defined, with a self-weight multiplier of 0 for all the cases. Once the load patterns were defined, the loads were assigned to each girder member.

To do this, the members to be loaded were selected, and then we went to:

Load Type	Load
Dead	729 PLF
DW	175 PLF
Pedestrian	630 PLF
Wind (V)	210 PLF

Table 6: Applied Loads

ASSIGN -> FRAME LOADS -> UNIFORM

then selected the load pattern that was desired (whether the dead load, DW load, pedestrian load), and then the value was entered in the uniform load value section. These load values can be seen in Table 6 at left. Once the loads were applied, the load combinations were defined. The load combinations are the same ones that were defined in Section 3.3. Because the vehicle load is not to be combined with the pedestrian load, as defined in AASHTO's Pedestrian Bridge manual, multiple load combinations were created to account for whether the live load was vehicular or pedestrian. After the loads were assigned to the bridge members and the load combinations were defined, the analysis was run and the results were recorded.

The horizontal wind loading was defined by the height of the desired members and their sizes. Due to the different heights and sizes of the arch members as opposed to the girders, a horizontal wind load was calculated for each type of member. Due to the need for lateral restraint, this wind loading was calculated in a 3D analysis. The horizontal wind loads were combined with the load tables that contain any load combinations that include wind loads and the values from the horizontal wind load calculations were multiplied by the appropriate factor and added to the bridge member values. This was how the group integrated the 2D analysis with the 3D analysis necessary for calculating the horizontal wind loads. These tables were then used for further design calculations (Appendix C, Appendix G). Although the both bridges were loaded similarly, their design and design process varied due to member sizing requirements discussed below.

10.1 Truss Design

The truss was chosen as an ideal alternative due to the relative slimness of the deck, simplicity of design and variety of visually appealing designs available. A truss is able to span the full distance as well as resist loadings within the allowed deflection. In addition to, and because of its geometric configuration, the truss converts its forces to almost fully vertical reactions. This means that the truss can sit on a pier on the side of the parking garage, which won't put much or any lateral force on the existing parking garage foundation. We chose a simple Pratt truss because the design is considered universally applicable and easy to solve analytically. A Pratt truss is composed out of any number of interconnected isosceles triangles as seen in Figure 34. To define the dimensions of the triangles, we utilized the customary target truss depth or 1/20 of the span. In addition, the customary rule for longitudinal division spacing is to keep the diagonal

web members at 50-60 degrees off of the bottom chord. In addition, typical truss bridges over 100' feet in length require a full box frame section. See Table 7 below for a full summary of the constraints and guidelines for the truss.

	2 x 80' Spans	160' Span
Depth (1/20)	4.0'	8.0'
Division Spacing	10'	10'
Fully Boxed?	No	Yes
Allowable Deflection (1/360)	2.67"	5.33"

Table 7: Truss Guidelines

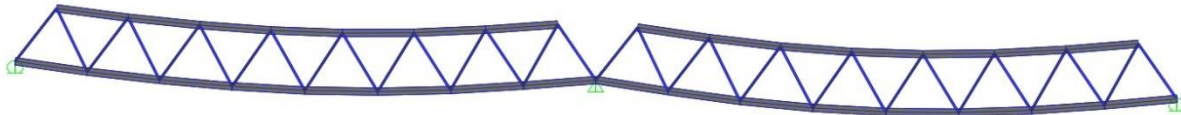

Figure 34: Double Span Pratt Truss, Showing Exaggerated Loading

We decided to proceed with design for only two 80' spans, because of the excess deflection in the single 160' span as well as the need to fully box the frame, which would restrict the height of vehicles and reduce aesthetics.

10.1.1 Deflection

According to AASHTO, deflections must be less than $L/360$ using the Service 1 limit state. The final deflections can be seen in the deflection tables calculated in Appendix G. The maximum deflection of the truss bridge was found to be in the center of each span.

10.1.2 Member Sizing

It is customary to use either square or rectangular tubing for steel pedestrian bridges. This helps with assembly and simplifies design. In addition the minimum thickness we analyzed for the steel flanges was $3/32$ ". This is because thinner steel is riskier due to deficiencies related to welding and corrosion. With this knowledge in mind, we proceeded to assign steel frame sections to the bridge and design it to meet the maximum vertical midpoint deflection in SAP2000. We assigned the separate sections for the bottom chords, top chords, web members, and members interconnecting the trusses. Figures 35 and 36 below show the section properties used for the bridge in SAP2000.

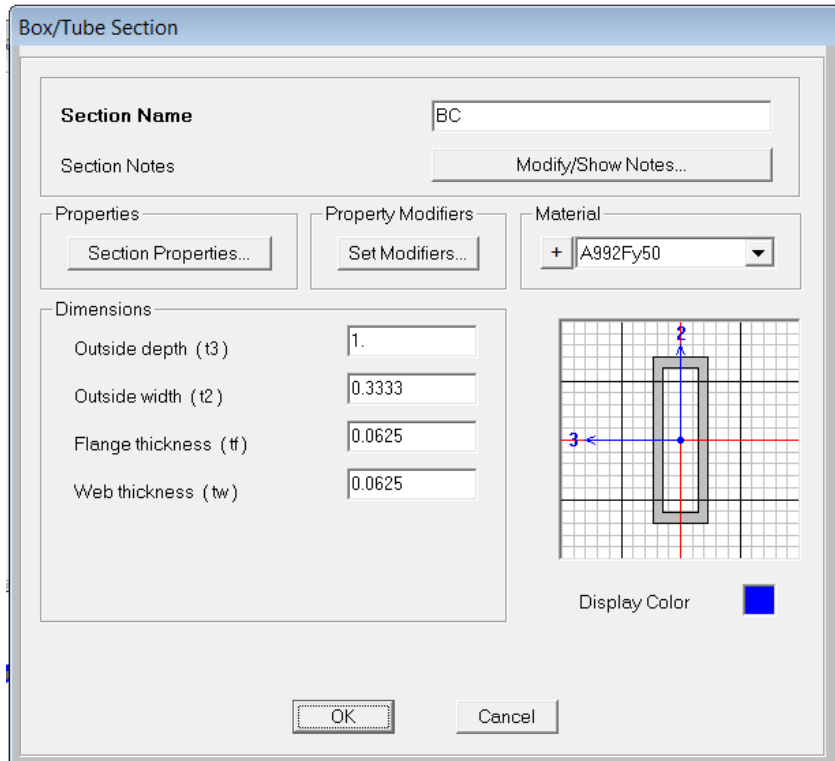

Figure 35: Sample Section of Top Chord and Bottom Chord

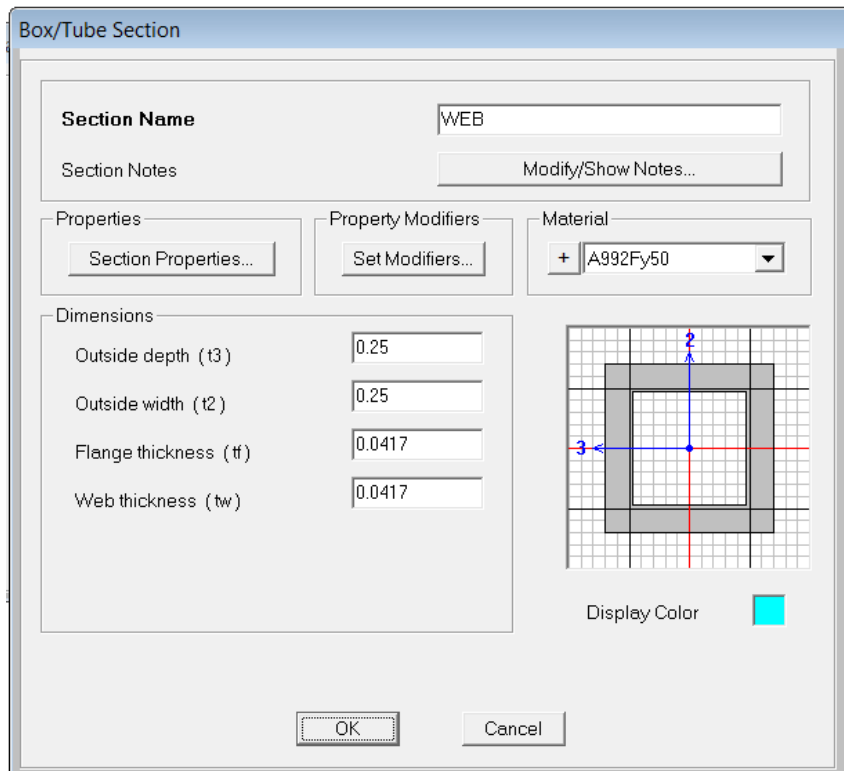

Figure 36: Sample Section of Web Members

These four different member sections were analyzed on both bridge lengths to produce the maximum allowable deflection with the least amount of material. It became apparent that we would need to overbuild the top chord because of the potential of buckling under compression forces instead of failure in tension. In addition we looked into potentially adding member redundancy so that in the event of one member failing, the bridge would not catastrophically fail. It became apparent that this would be far too costly. In addition, we decided to overbuild for lateral stability. We added diagonal cross members between both the bottom chords and top chord where applicable. Since these members are relatively small, they do not add very much to the weight and cost and yet provide a potential brace against wind and seismic loads. The member sizes were later evaluated in Microsoft Excel to ensure that the maximum allowable load is not exceeded by the maximum possible load. All results and calculations from SAP2000 can be seen in Appendix G.

10.1.3 Truss Connections

Almost all prefabricated steel trusses utilize welded connections. It is very uncommon to use bolted connections, except in the case where a truss comes in multiple sections, which are then bolted together. Typically almost all of the welding is done in the factory where the truss is fabricated and very little welding is done on site. See Figures 37 and 38 below for details of typical truss welds.

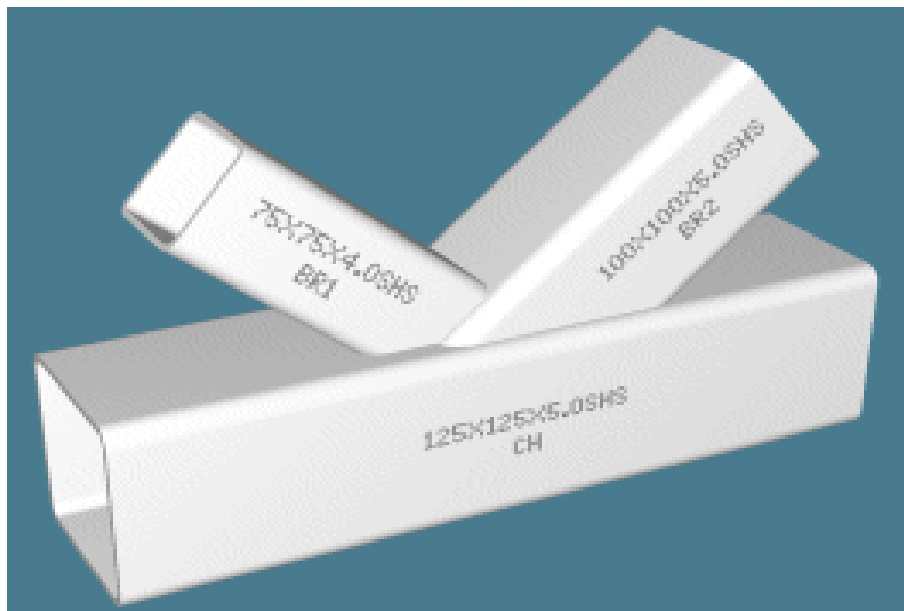

Figure 37: Typical Tube Cut, Prepared for Welding



Figure 38: Typical Welded steel Connection

10.2 Arch Design

The second alternative chosen for analysis was the arch bridge. The arch bridge allowed for a slim deck and allows for a more aesthetically appealing design. With the limitation of the parking garage to support any more loadings, the arch has to start below the bridge deck, far enough away from the parking garage as to provide enough space for an adequate foundation that will not put extra lateral forces on the parking garage structure/foundation. The main concern with the arch bridge is whether or not the arch will provide enough clearance to meet fire code. Because it is desirable that the bridge does not overshadow the parking garage, the height of the bridge was selected to be roughly the same height as the parking garage elevator shaft.

10.2.1 Deflection

According to AASHTO, deflections must be less than $L/360$ using the Service 1 limit state. Because the bridge is 160' in length, the deflections were limited to .44 feet or 5.33 inches. The final deflections can be seen in the deflection tables in Appendix D – Arch Bridge Deflection Tables. The maximum deflection of the arch bridge was found to be in the 20' section of the bridge located between the left arch and the left bridge deck end, which is the section of the bridge that is essentially simply-supported. This section was primarily dependent on the girder size. The maximum deflection recorded, between the girder and the arch members, was roughly 2.25 inches, well within the deflection limits required from AASHTO.

10.2.2 Member Sizing

The arch bridge was designed in SAP2000 with cross bracings for the girder and arch, initially designed at 10 foot spacing and with a reduced size. The cross beams for the girders were designed as S 5x10 members and the cross beams for the arch were designed as HSS 5x.5 members based off of a maximum deflection. The appropriate load combinations were applied to each member (their calculation can be viewed in 8.3Appendix D – Arch Bridge D). In all loading cases, tables were exported from SAP2000 to excel, which can be seen in Appendix C – Arch Bridge Analysis Tables from SAP2000. Once in excel, MAX and MIN equations were created to calculate the maximum and minimum P, V, M, and S11 (stress) values for each bridge member. Then a summary table was created to calculate the maximum and minimum of the previously mentioned values for each load case.

The arches of the arch bridge were determined to be steel tubes. Although concrete is preferred in compression, steel ribs produce far less dead load forces, which is ideal due to the limitation of the parking garage to carry additional stresses. Furthermore, the steel arches allow for smaller cross-sections, which help with the clearance limitation of the bridge, and are popular in arch bridge design (HSS). In SAP2000, the arches were determined to be located 10' from the parking garage and 20' from the loading dock behind Harrington Auditorium. This location was determined considering the anticipated size of the foundation and to allow for the surrounding buildings to be independent of the forces experienced in the foundations of the arches. The steel arches were originally determined to be 2' wide with a 6" thick wall, and were reduced to 12.5" wide with a .625" thick wall once the stresses, deflections, and buckling checks were calculated following the application and analysis of the load combinations. The members were drawn in SAP using the draw curved frame member tool. The height of the bridge was set 20' above the garage connection height (20' above the 536-7" elevation) and it was set at the middle of the arch's span (not the bridge's span) to allow for some symmetry for the arch. Once determining the coordinates for the top of the arch, the box for curve type, we selected "Parabolic Arch – 3rd Point Coordinates" to set the height. The arch was drawn into SAP; however, due to the educational version of SAP2000's limitations, the curved member drawn was converted into 13 straight line members. To facilitate cable placement, the curved frame member's location information was exported into Microsoft Excel: displaying the frames as separate straight frame members as shown below in Figure 39. The frame members still act as an arch; however, the limitation of SAP2000 was resolved and allowed for a more realistic and accurate analysis, allowing for the ability to manufacture similar, smaller members as opposed to two large arched members. The connections for the 13 separate frame members also will serve as the joints where the cables would transfer the bridge deck loads to the arch. Cross members were added between the two arches to provide lateral support, as well as connectivity. Finally, the arch members were checked via hand calculations to ensure that buckling does not occur in these members and to validate the calculations made by SAP2000.

Because the design moments were calculated through SAP2000, the bridge had to be "built" before the load cases could be run and the moments determined. Therefore, the size of the bridge girders needed to be assumed prior to the design, and adjusted accordingly, once the moments were calculated. Due to the necessity for the bridge to meet fire code minimum clearance and the already limited clearance due to the site conditions a W8X48 steel beam was chosen as the initial girder size through a basic moment calculation, considering the pedestrian live load, dead load of the concrete deck. The girders were drawn using the drawn frame tool in

SAP2000. The ends of which were determined through the construction documents and the survey data as mentioned in sections 3.1 and 3.2. As the moments and stresses were determined, the girder size was adjusted to comply with AASHTO requirements . The major factor for the girders was the high stress experienced right at the point of connection between the girder and the arch (near the loading dock at Harrington Auditorium). The girder size was increased to a W10X68 to account for the high stress and comply with the bridge girder calculations (see Appendix E – Arch Bridge Design Calculations for more information).

In SAP2000, the cable members were design using the diameter option, starting with a diameter of .25'. The sizes of the members were changed as SAP analysis was conducted. This option allowed the cable members to only support tensile forces since cables cannot support compression. Because the arch members were already defined, the same grid was used to create the cable members. To connect the cables to the girders, the cables were drawn in extending straight past the deck to a z value of 0. Then the girder and the cables were selected and the divide cables tool was used to divide the members at their intersections. Then the cable members that extended below the deck/girders were simply deleted, leaving the remaining cable members in their desired locations (between the arch frame connections and the bridge deck/girders. The final cable layout is shown below in Figure 39.

10.2.3 Arch Connections

Commonly in the North-Eastern parts on the United States, these connection details are left to the fabricating firm. Once the fabricator creates a design for these connections, he/she shall create engineering sketches with design details for approval by the structural designer(s). The connections that need to be addressed include; arch to cable, cable to girder, and arch to foundation. These connections would likely be similar to those seen in Figures 43, 44 and 45.



Figure 43: Example of Arch-Cable Connections



Figure 44: Example of Cable-Girder Connection



Figure 45: Example of Arch-Foundation Connection

10.2.4 Fire truck Clearance

As stated in the bridge requirements, the bridge must be able to allow a fire truck to pass beneath it. According to the construction documents, the ground elevation is 522' at the parking garage and about 523' at 50' off the parking garage. This means that, assuming an even slope, every ten feet the ground elevation rises .2'. In Figure , the height of the fire truck can be observed as 13.5', as determined in the fire code. Taking into account the previous information, the bottom of the bridge must have an elevation of 533'-3.5" at 40' off the parking garage and 533'-6" at 50' off the parking garage. According to the heights in SAP, the top of the bridge is at 538'-1.2" at 40' off the parking garage and 538'-3.5" at 50' off the parking garage, which yields a clearance of 15.1' and 15.2' respectively (observed in Figure). Taking into account the 8" thick deck and the 10" outside to outside height of the girder, 1.5' must be taken off the 15.1' and 15.2' measurements. Thus, the bottom of the deck has a clearance of 13.6' and 13.7' at 40' and 50' off the parking garage, respectively. Although the bridge does have the capacity to clear a fire truck, having the deck overlap the bridge girders and not simply sit on top of the girders, yielding a greater clearance.

10.3 Foundation Design

The foundation design was completed by hand calculations in Microsoft Excel, and specific to each bridge as seen in the below sections.

10.3.1 Truss Pier Design

The piers were designed using the vertical reactions of 387kips per end of the bridge applied to the SAP2000 bridge model seen in Appendix I. The supports for each of the four piers which will hold the decking at the ends of the bridge are to be designed from concrete using a design compressive strength of 4000 psi and yield strength of the reinforcing steel of 60,000 psi. By using the reactions from the concrete decking, and self-weight of the truss design, steps were taken into design the concrete piers with steel reinforcement shown in Appendix J. The final recommended design would be a concrete pier 1' x 1' x 5', with a footing of 2.5' x 2.5' x 1', with 5 #7 rebar as steel reinforcement, typical on center for each side of the footing. The concrete decking will rest on the four concrete piers at the ends of the parking garage.

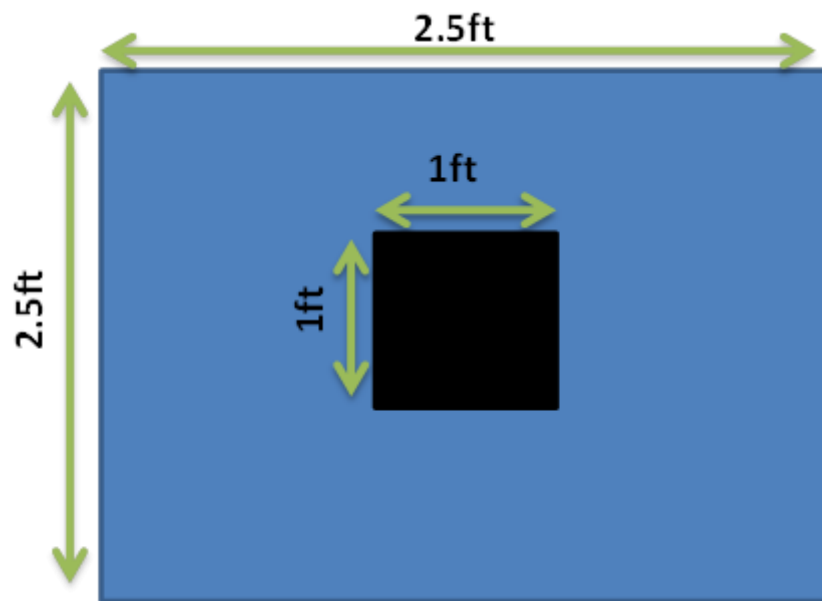
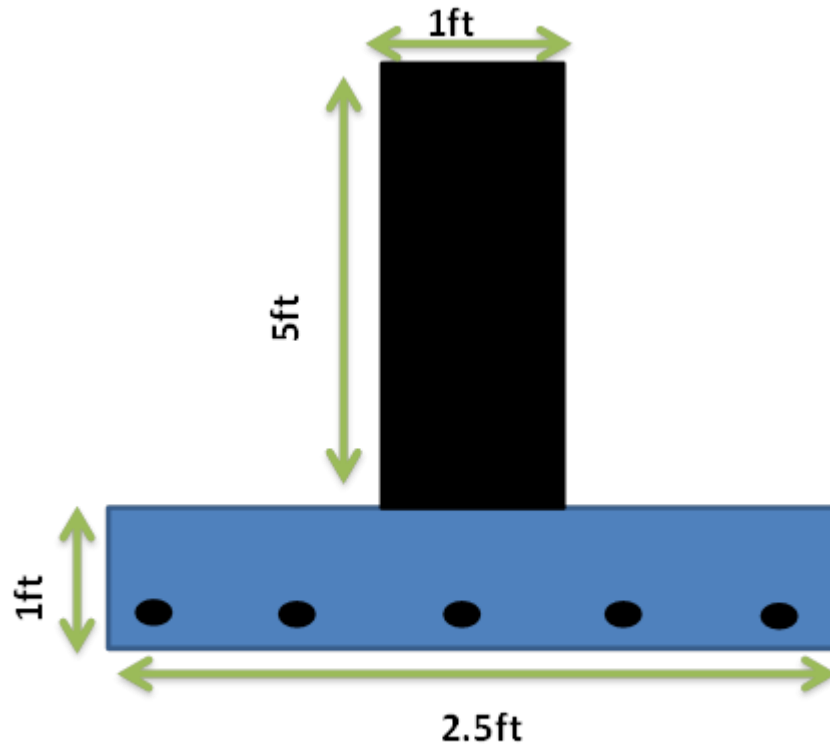

Figure 31: Pier near Harrington and Parking Garage Top View



#7 Rebar o.c.

Figure 32: Pier near Harrington and Parking Garage Longitudinal View

10.3.2 Truss Middle Pier

The single middle pier was designed using the 387kip vertical reaction applied from the SAP2000 truss bridge model. The support for the middle pier which will support the truss bridge are designed from concrete using a design compressive strength of 4000 psi and yield strength of the reinforcing steel of 60,000 psi. By using the reactions from the concrete decking, and self-weight of the truss, steps were taken into designing the concrete piers with steel reinforcement shown in Appendix J. The final recommended design would be a concrete pier 2' x 2' x 10', with a footing of 5.25' x 5.25' x 1.25', with 7 #7 rebar as steel reinforcement, on center for the middle concrete pier that will support the concrete decking at the center of the bridge decking. An important issue to note was to have clearance for a fire truck to pass through under the bridge in case of an emergency; the water retention tanks will have to be removed in order to have this pier constructed with a foundation. Pile caps were not necessary as soils consisting of glacial till or bedrock deposits were found generally less than 8 feet below the surface where the middle pier would be built, these soils had an allowable bearing capacity of 8000 pounds per square foot. Piles would be required if the bearing capacity of the upper soil layers were insufficient, but firmer soils were available at greater depths requiring the use of pile caps. Please see Appendix J for further calculations.

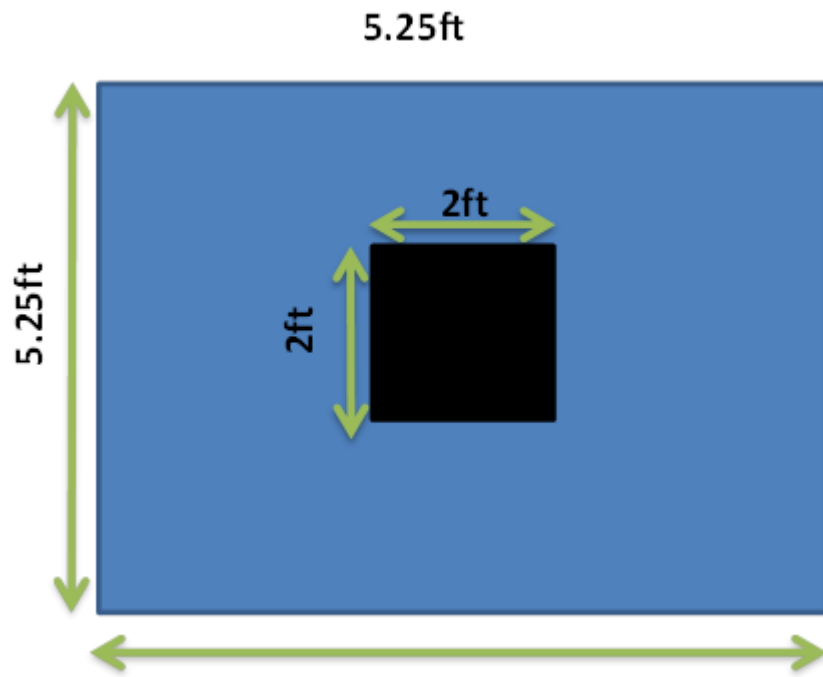

Figure 50: Truss Middle Pier, Top View

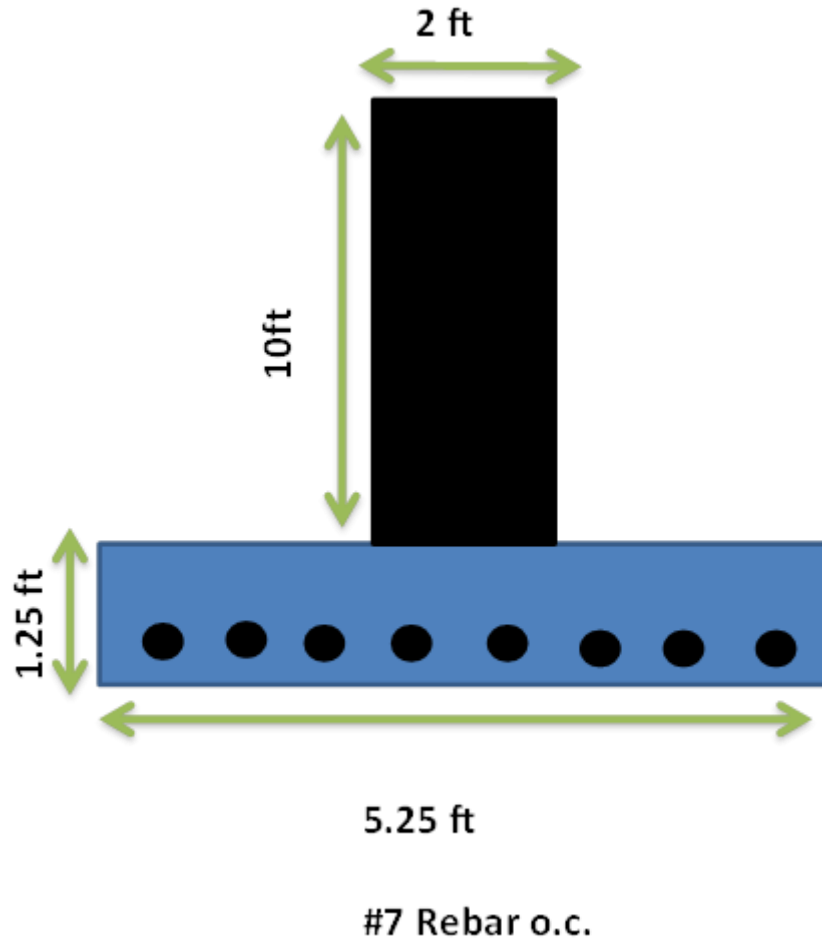

Figure 51: Truss Middle Pier, Longitudinal Side View

10.3.3 Arch Footing Design

The abutments were designed as retaining walls using the loads applied to the SAP2000 bridge model for an Arch. The supports for each of the two piers which will support the truss bridge are to be designed from concrete using a design compressive strength of 4000. By using the reactions from the concrete decking, and self-weight of the truss, steps were taken into designing the abutments shown in Appendix F. The final recommended designs will have four concrete abutments with dimensions shown in Figure 52, 4' below grade for support.

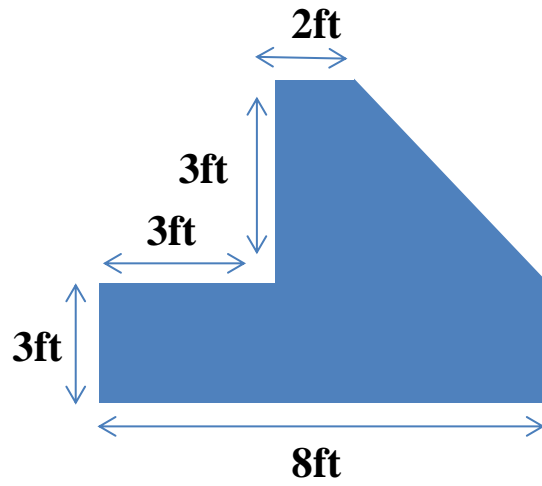

Figure 52: Arch Bridge Abutment, Side View

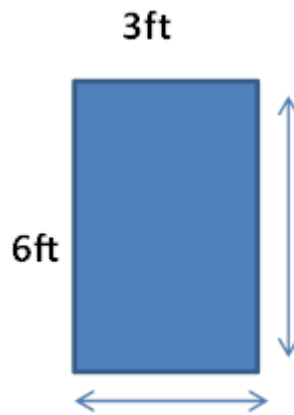

Figure 53: Arch Bridge Abutment, Front View

Figure 54: Arch Bridge with Abutments

11 Results

11.0 BIM

We attempted to import the models from Sap2000 into REVIT via an .IFC file extension. Unfortunately, the conversion does not keep the member sections intact and assigns a general section to all members, which resulting in needing to design each member size in REVIT and assign them to each member accordingly. In addition, since we were using 2-dimensional frames the frames had to be duplicated and the deck and cross members had to be constructed as well. We used the design data to form the piers and footings and placed them accordingly. We had difficulty getting the arch to display properly in 3D, because the individual members would not properly connect. We eventually solved this problem with the use of a special tool for integrating the ends of members.

The prospect of producing a full “walkable” 3-dimensional model proved too difficult and time consuming. We resultantly settled for producing high quality renders from various camera angles on both the arch and truss bridge and superimposing them on top of pictures taken from the site via Adobe Photoshop. We finished by touching up the renderings in Adobe Photoshop to suit the lighting and match more naturally. The final renders for the truss and arch can be seen below in Figures 55, and 56. An outline of the steps taken in the process can be seen in Appendix O.



Figure 55: BIM Render of Proposed Truss Bridge



Figure 56: BIM Render of Proposed Arch Bridge

11.1 Schedule

In order to produce a schedule of the two bridge alternatives, Primavera software was utilized. Each task in order to construct each bridge was defined, from the procurement of the materials to the excavation of the footings to the end of construction. Once each task was identified, the duration of each task was determined. The RS Means books were utilized to determine each task's duration. RS Means has a daily output parameter associated with any item included in the book. For example, RS Means lists the daily output of 12" x 12" square columns as 1498.50 Cubic Yards. Knowing the daily output of each task, the total amount utilized in each bridge was determined and compared to the daily output; thus, determining the duration of each task. Once this step was completed, the relationship each task has with each other was determined. For example, the columns cannot be constructed before the footings are constructed and have time to reach an appropriate strength (the footings do not need to necessarily reach their 28 day strength before the columns are constructed). The predecessor and successor for each task was determined, and once complete, the scheduling analysis was run to construct a Gantt chart and determine the total length of each bridge. The Gantt chart for each bridge can be observed in Figure 57 and Figure 58. The schedules focus on the construction of the bridge, taking into account the procurement of the concrete and steel members.

11.2 Cost

RS Means has several books that contain cost data for construction projects. In particular, the *Building Construction and Heavy Construction Cost Data* book set was used to gather cost information and compile a cost spreadsheet for each bridge. These spreadsheets can be viewed in detail in Appendix L – Bridge Cost Estimation. Although most of the information needed to estimate the bridge costs was readily available in the RS Means Cost Data books, several assumptions were used. RS Means does not have any cost information on HSS members; therefore, the team used a unit price of \$2000 per ton, which was a number recommended to the team by its advisor, Guillermo Salazar, and was a number that was observed when an online check of steel prices was conducted. Furthermore, the team marked up the costs of the arch members by 10% to account for the increased difficulty of constructing the members, as opposed to constructing mass produced members. Also, because custom members were used for the construction of the truss, a 33% mark-up was applied to their cost. In addition to the construction cost, bonds, insurance premiums, buildings permit costs, and contingency/mark-ups were added to the total cost to account for the total construction cost of the project. As a result of the cost estimation, the arch bridge was estimated to cost \$228,006 and the truss bridge was estimated to cost \$233,176. The similarity in price allows the price to not govern in the bridge selection. These costs do not include any related site work which could prove to be a significant sum (a difference of \$5,000). All detailed cost estimations can be viewed in Appendices K and L for the bridges and deck respectively. In addition all detailed scheduling information can be viewed in Appendices M and N for the arch bridge and the truss bridge respectively.

THE REMAINDER OF THIS PAGE WAS LEFT INTENTIONALLY BLANK

12 Conclusions and Recommendations

12.0 Conclusions

This project has given our group a greater understanding of the effort, time and diligence required during a major design process. Our team took the time to meet with a key administrator to gain a better understand of why a bridge was necessary. The bridge will become a main gateway at WPI and become part of the future promenade in that location. Another broader implication of the bridge is to improve handicap access to the campus. A handicapped individual could theoretically take the garage elevator to the garage roof and then simply cross the bridge.

Once the need for the bridge was addressed, research on multiple bridge styles and materials to give ourselves a number of options to choose from was performed. After brief analysis and design considerations of these options, two alternatives were selected for detailed design. These two alternatives would be an arch-cable bridge and a truss bridge.

Once these two options were selected, we performed an in-depth design and analysis of both options. Using computer modeling in SAP2000 and hand calculations in Microsoft Excel, most major aspects of the bridges were designed. The key components designed included; the bridge deck, the bridge superstructure, the bridge substructure, and the foundation. These components were addressed for both bridges. During the design of each bridge, key codes had to be followed to ensure the safety and integrity of the bridge. Chief among these codes for design were those set down by the American Association of State Highway and Transportation Officials (AASHTO).

Once the comprehensive design of each bridge was completed, an in depth schedule and cost estimate could be produced for each alternative. Based on our analysis, each bridge would have similar costs and times required for construction. Due to this, a final decision would likely be made based on constructability, aesthetics, and the overall favoritism of the Board of Trustee at Worcester Polytechnic Institute. Please see Section 6.1 for further recommendations regarding our expertise in the matter.

Exploring the social and technical aspects of this project has broadened our views of the construction process. Understanding that we need not only design the bridge, but also design a bridge that will actually get built has been a challenge.

12.1 Recommendations

We fully recommend both the two-span truss and the single-span arch as viable alternatives. With similar estimated prices, materials and foundation designs, it comes down to some smaller choices when making a decision:

Constructability:

The truss would be a more easily and quickly constructible bridge because it would most likely be prefabricated and then simply lifted into place which could be done in a single week. Conversely, the arch would need to be assemble in sections which would take far longer and would require significant temporary shoring and possible the use of multiple cranes.

Aesthetics:

In general we think that the arch would be a more attractive design for that particular spot on campus. But we do consent that this category can be very subjective.

Foundation Designs:

The truss would require a middle pier, unlike the arch. Pacing a middle pier would disrupt the storm water infiltration pipes set below the proposed bridge location. This could affect the drainage capacity of the site.

12.1.1 Further Steps

- 5.) Present the BIM renderings to the WPI facilities staff for feedback.
- 6.) Present the BIM renderings, cost and schedule information to WPI's board of trustees for funding.
- 7.) If approved for funding, solicit bids for the project.
- 8.) Select a bid and schedule construction in accordance with the guidelines listed in this report.

THE REMAINDER OF THIS PAGE WAS LEFT INTENTIONALLY BLANK

13 Bibliography

- AASHTO. (2009). *LRFD Guide Specifications for Design of Pedestrian Bridges*. New York: AASHTO.
- AASHTO. (2012). *AASHTO LRFD Bridge Design Specifications*. Washington, D.C.: AASHTO.
- Alliance, M. D. (2000). *Product selection guide: FRP composite products for bridge applications*. New York: Market Development Alliance.
- ASCE. (2001). *Report Card for America's Infrastructure*. Washington: American Society of Civil Engineers.
- AVK. (2010). *Sustainability of Fiber-Reinforced Plastics: An Assessment Based on Selected Examples of Application*. Frankfurt: AVK.
- Azamejad, A., McWhinnie, K., Tadros, G., & Jiri, a. S. (2011). Cable-Stayed Bridge as an Alternative for Medium and Short Span Bridges. *2011 Annual Conference of the Transportation Association of Canada*. Edmonton, Alberta: Transportation Association of Canada.
- Azar, J. M. (1991). *Structural components in Highway Bridge Deck Applications*. New York: VCH Publishers.
- Chen, W. F. (2003). *Bridge Engineering: Handbook*. Boca Raton, FL: CRC Press LLC.
- Colorado Department of Transportation. (2010). *2010 Cost Data*. Colorado Department of Transportation.
- Department of Justice. (2010). *2010 ADA Standards for Accesible Design*. Washington, DC: Department of Justice.
- Godden, W. G. (Ed.). (1997). *Cable-Stayed With Steel Deck*. (University of California, Berkeley) Retrieved from National Information Service for Earthquake Engineering: http://nisee.berkeley.edu/leonhardt/html/cable-stayed_with_steel_deck.html
- Handi-Ramp. (2013). *ADA Compliant Handrails & Railings*. Retrieved from Handi-Ramp Handrails: <http://www.handiramp.com/handrails.htm>
- Harvey, W. J. (1993). *A Reinforced Plastic Footbridge, Alberfeldy, UK*. Structural Engineering International.
- Henry, J. (1985). *Deck Girders System for Highway Bridges Using Fiber Reinforced Plastics*. 1985: North Carolina State University.
- Howe, A. (2012, Spring). Delta Ponds Pedestrian Bridge: Extending a Sustainable Transportation Network. *Aspire*, pp. 20-23.
- johnweeks.com/bridges/pages/ms19.html. (2013, february 3). Retrieved from johnweeks.com: johnweeks.com/bridges/pages/ms19.html
- Malvar, T. A. (2005). *Fiber-Reinforced Polymer Composites in Bridges: A State-Of-The-Art Report*. Port Hueneme, California: NAFAC.

- Management, D. o. (2011). *2011 WPI Student Fact Book*. Worcester.
- Market Development Alliance of the FRP Composites Industry. (2004). *Bridge Product Gateway* . Retrieved from American Composites Manufacturers Association: http://www.mdacomposites.org/mda/psgbridge_pedestrian_print.html
- Podolny Jr., W. P. (n.d.). *Construction and Design of Cable-Stayed Bridges* (2 ed.). New York: John Wiley & Sons.
- Rayor, G. P. (2010). I-5 Beltline (Gateway) Pedestrian Bridge. *Bridge Design Conference*. Oregon Department of Transportation.
- RS Means. (2011). *RS Means Building Construction Cost Data 2012*. Norwell, MA: RS Means Co., Inc.
- RS Means. (2011). *RS Means Heavy Construction Cost Data 2012*. Norwell, MA: RS Means Co., Inc.
- The Associated Press. (2006, July 5). *Judge rules against fans in Lowe's birdge collapse*. Retrieved October 10, 2012, from ESPN: <http://sports.espn.go.com/rpm/news/story?seriesId=2&id=2510428>
- USDA. (2011). *A Guide to Fiber-Reinforced Polymer Trail Bridges*. Washington D.C. : United States Department of Agriculture.
- Works, C. C. (2011). *Cuyahoga County engineer Supplement to the 2007 ODOT Bridge Design Manual*. Cuyahoga: Cuyahoga County of Public Works.
- Zhou, A. (2002). *Stiffness and Stregnth of Fiber Reinforced Polymer Composite Bridge Deck Systems*. Blacksburg: Virginia Polytechnic Institute and State University.

14 Appendices

14.0 Appendix A – Survey Data

#	Description	Distance (ft)	Elevation (ft)	Horizontal Distance	Angle	Angle	0 Angle Adjustment
1	Benchmark	185.299	-1.39		232.37.45	232.6291667	0
2	Garage Floor	47.068	-1.292		216.05.39	216.0941667	16.54
3	Left Opening (G)	38.692	13.274	37.91726847	198.15.11	198.2530556	34.37611111
4	Right Opening (G)	47.722	13.069	47.12912351	215.19.50	215.3305556	17.29861111
5	Loading Dock Left	131.575	18.3	130.9577326	338.54.42	338.9116667	253.7175
6	Loading Dock Right	128.512	18.208	127.8890734	331.02.55	331.0486111	261.5805556

14.1 Appendix B – Interview Transcript

Interview with Fred DiMauro, Head of Facilities; September 12, 2012, 9 AM Kazin Room

Have 3 projects coming together at same time

- *Rec Center stand alone*
- *Garage came sooner than expected*
- *Covered stairs and canopy main pedestrian walk way to campus*
- *Other access ways depend on how Dana Harmon allows access into building*
- *Going Around Building*

When project is complete, must have passage way for all types of people (handicapped or not)

With creation of garage majority of people will be accessing main campus from it

Handicap issues—series of ramps from Parking Garage to Campus Center

Athletic field will become an extension of campus with Pedestrian Bridge; (elevator in Parking Garage)

Quad to Higgins Gardens

Further complications – Fire truck underneath bridge (Height of bridge with Parking Garage)

Challenge of Building Bridge

DiMauro has agreed to go forward with Bridge Design Firm

Library to Quad, to Higgins Gardens, Parking Garage and Athletic Field, all a connection of Campus

Storm Water distribution Center

Supports of Bridge will have to be coordinated with Manifolds of Stairs

Two issues with vehicles to fields with Athletic Equipment

Two storage rooms for Athletic Equipment

Needs support for snow removal equipment; size width load

(Partial solution) ramp comes along side walk

Bridge Vehicle Weight limit

Constraint, Financial impact; weight?

Committed to Length (life of project)

Court level of Harrington

Bridge comes across court level

Promenade will be in bridge design

Halverson Design Partnership

Cost & Finance

-BP Cost figure in Analysis

1 million dollars for Promenade Bridge and site work

Halverson

Estimate from Gilbane 300,000

Preference in Materials & Lifespan?

Steel; Precast

Aesthetics are more concerned and character of bridge

Does have to fit in surroundings, aesthetically successful but within Budget

Salazar: Bridge in Venice, modern in antiquity, accepted by people

Confined

Bridge and Promenade will be built within 2 years of the complete of Parking Garage, during construction will close knuckle? And area, close 1 entrance

Can obtain soil conditions from Gilbane

Decision process from WPI

President and administration will bring to trustees the rational why it's important, Jeff Solomon (CFO), how much money we have and how to spend it

Trustees receive information why this is a priority, see what major project options

Deliverables for this project

What we would do, how it looks like

3D image to walk around in

Move around a model in real time

Site plan-Structural Detail

3D rendering in surrounding

Cost estimates

Narrative of Design

Features; Strength or Challenges

Scheduling over the summer (still impact on many things)

Conditions at start of A term, or if project begins in Spring, Conditions at commencement, graduation

Evaluation of those

Question for SMAA was there foundation put in place for bridge for later?

14.2 Appendix C – Arch Bridge Analysis Tables from SAP2000

TABLE: Strength I (P) Maximum						
Frame	Max P	Min P	Max V	Min V	Max M	Min M
Text	Kip	Kip	Kip	Kip	Kip-ft	Kip-ft
Arch 1	-254.2	-254.4	-2.3	-2.5	35.83	4.44
Arch 2	-250.4	-250.5	-43.7	-43.7	191.32	35.83
Arch 3	-202.8	-213.8	16.9	-2.5	-19.01	-97.91
Arch 4	-194.4	-202.9	6.8	-16.3	5.21	-97.91
Arch 5	-184.4	-192.9	20.3	-24.9	26.21	-50.75
Arch 6	-184.4	-188.6	20.3	-10.0	61.64	-17.16
Arch 7	-184.2	-190.6	26.6	-18.5	46.12	-19.34
Arch 8	-192.4	-199.6	17.9	-4.8	24.77	-69.9
Arch 9	-199.9	-211.7	8.4	-14.7	12.24	-69.9
Arch 10	-210.2	-223.2	-8.4	-26.1	30.78	-63.6
Arch 11	-227.6	-227.7	31.8	31.7	189.41	-81.39
Cable 1	22.1	22.1	0	0	0	0
Cable 2	24.4	24.4	0	0	0	0
Cable 3	23.2	23.2	0	0	0	0
Cable 4	22.5	22.5	0	0	0	0
Cable 5	21.5	21.5	0	0	0	0
Cable 6	22.1	22.1	0	0	0	0
Cable 7	23.2	23.2	0	0	0	0
Cable 8	23.6	23.6	0	0	0	0
Cable 9	25.8	25.8	0	0	0	0
Cable 10	21.8	21.8	0	0	0	0
Girder 1	13.5	12.8	-8.4	-32.0	202.5	0
Girder 2	12.8	12.0	15.1	-8.4	215.27	168.97
Girder 3	12.0	11.3	38.7	15.1	168.97	-100.72
Girder 4	11.3	10.9	49.2	38.7	-100.72	-297.16
Girder 5	1.4	0.4	14.0	-14.8	42.84	-79.87
Girder 6	-18.0	-19.3	1.3	-38.8	132.01	-187.75
Girder 7	-19.3	-20.1	24.9	1.3	132.00	0

. All of the deck formations are typically between 18 and 23 lb/ft², around 7-3/4" thick, cost around \$74/ft², and have a normalized deflection (HS20+IM for 2.4m center-to-center span) between L/325 and L/950 depending on the formation (Zhou, 2002). Zhou suggests that the difference in deck deflections by the different deck formations are attributed to the process in which the bridges are designed, which tend to be on a case by case basis.

Composite bridge decks have been found to have a long service life in comparison to steel and concrete decks, which is an important and helpful feature of composites. Vistasp M Kabhari, Dongqong Wang, and Yanqiang Gao studied numerous bridges in the US and found that while bridges last, on average, for 68 years; however, their decks last for only 35 years. Although this considers vehicular bridges and not pedestrian bridges, it is common acceptance that bridge decks need more maintenance and repairing than any other component of a bridge. Composite bridge decks are highly corrosion-resistant, which eliminates maintenance concerns from moisture and salt air. The longer service life and durability of composites can help lengthen the life of the bridge deck (Zhou, 2002). Composites also tend to have higher strength to weight ratios when compared to concrete and steel decks, and have a weight of about 80% less than cast in place concrete decks (Malvar, 2005). The lighter weight of the composite decks allow for better constructability, along with the prefabrication and ability to have the deck shipped completely or partially assembled. Unfortunately, one of the drawbacks of the composite bridge decks is their initial cost. Composite bridges decks typically cost about 4-5 times that of purely concrete decks, 4 times that of reinforced concrete decks, and 2-3 times that of steel decks, when considering cost per ft². However, the high initial cost of composite bridge decks may be offset when considering the lower maintenance costs, but LCCAs of composite bridges have yet to emerge (Zhou, 2002).

Bridge Systems

Simple Supported Beam

Bridges designed as simply-supported have multiple characteristics that may be seen as advantageous. In the design phase, simply-supported structures are rather easy to design. Figure 9 shows the basic look of a simply-supported beam design. The loading on the bridge is transferred through the main beam, into the support piers, and then down into the ground below. As shown in Figure 9, the beam may require an additional support located in the center of the span if the span length is too long. This is due largely to the fact that a simply-

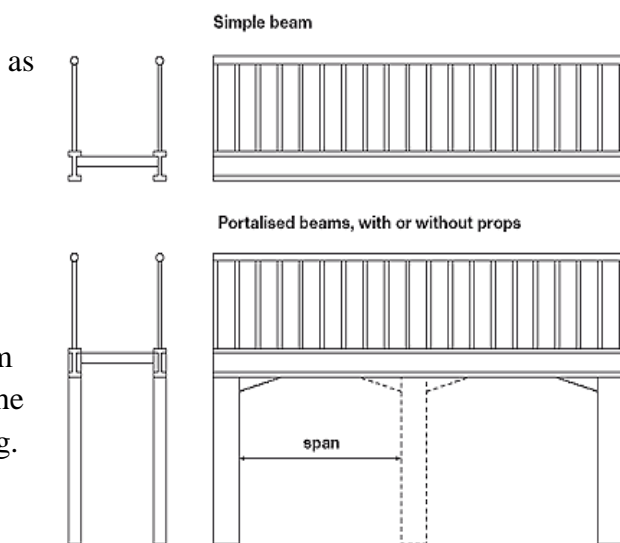

143

Figure 36: Basic Design Outline of Simply-Supported Beam Bridge

supported bridge has zero rotation resistance. Simply-supported beam bridges tend to dip or sag around the middle of the span. This is the major issue with bridges designed this way. It is also why these bridges can be more expensive. Since the bottom side of the span is sagging, it faces more tensile forces. Thus the structure must almost certainly be made with either steel or reinforced concrete. Figure 10 is a picture of the aftermath of a bridge failure at Lowe's Motor Speedway in Charlotte, North Carolina. Investigators have reported that "the bridge builder, Tindall Corp., used an improper additive to help the concrete filler at the bridge's center dry faster. The additive contained calcium chloride, which corroded the structure's steel cables and led to the collapse" (The Associated Press, 2006). Once the additive has corroded the structures steel reinforcing cables enough, the structure was doomed to fail as the concrete could not resist the tensile forced caused by the sagging of the bridge. The only way to counteract this issue is to either add a support pier in the center of the pier or make the depth of the bridge much greater. Both of these solutions would be unfavorable for the new pedestrian bridge. A deep bridge is virtually impossible for the given circumstances as it would create far too small of a clearance³. Adding a middle support pier is plausible, however the bridge depth would likely still need to be too great and the middle support may look out of place given the superior architectural design of the new WPI recreation center.



Figure 37: Simply-Supported Pedestrian Bridge Failure

³ As stated in Section **Error! Reference source not found.****Error! Reference source not found.**

14.2.1 Truss

Bridge trusses were developed as an economical and practical way of meeting the needs of America's expanding train system in the 18th century, although they have earlier roots in Europe for similar purposes. They are derived from a series of triangles, which happens to be the only shape which will maintain the angles between members when you fix the length of the members. This unique characteristic produces the strength of the design in general.

Because of the stresses on the members of any truss they are typically constructed out of materials with high tensile strengths. Initially they were constructed out of wood, but as iron was developed into steel, steel became a more popular material for the construction of trusses. More recently, especially in the case of pedestrian bridges, prefabricated trusses have become more popular. This way a bridge is constructed economically and safely under controlled conditions at a factory. Afterwards it is simply lifted into place using a crane, which minimizes onsite costs. Prefabricated bridges were initially developed by the British military in the 1930s and eventually found their way into commercial bridge manufacturing.

There is a lot of terminology related to understanding truss bridges which allows for analysis. First, trusses can be classified as planar, which means that all members fall into a 2 dimensional plane, or special which means that members venture out into 3 dimensions. The point of contact between members is called a node. For the purpose of analysis, nodes are considered to be simple pins which cannot create a moment between members, but in reality these connections can exert a small moment. Stringers are the members that connect parallel trusses and typically act perpendicularly to the direction of travel. Stringers also provide support for the floor beams which subsequently supports the decking. Struts and bracing help prevent torsion between parallel trusses by providing diagonal bracing against wind and seismic loads. The upper edge and lower edge of a planar truss are referred to the top chord and bottom chord respectively. Any other diagonal members in the truss are considered web members which help distribute the load.

Simple analysis of truss bridges can be completed through static analysis of Newton's laws. In reality a bridge is not a statically determinate system and must be analysis as such. This is where software comes in to help quickly and accurately analyze the viability of different designs.

There are countless examples of different truss types which can excel in different situations and loadings (See Below).

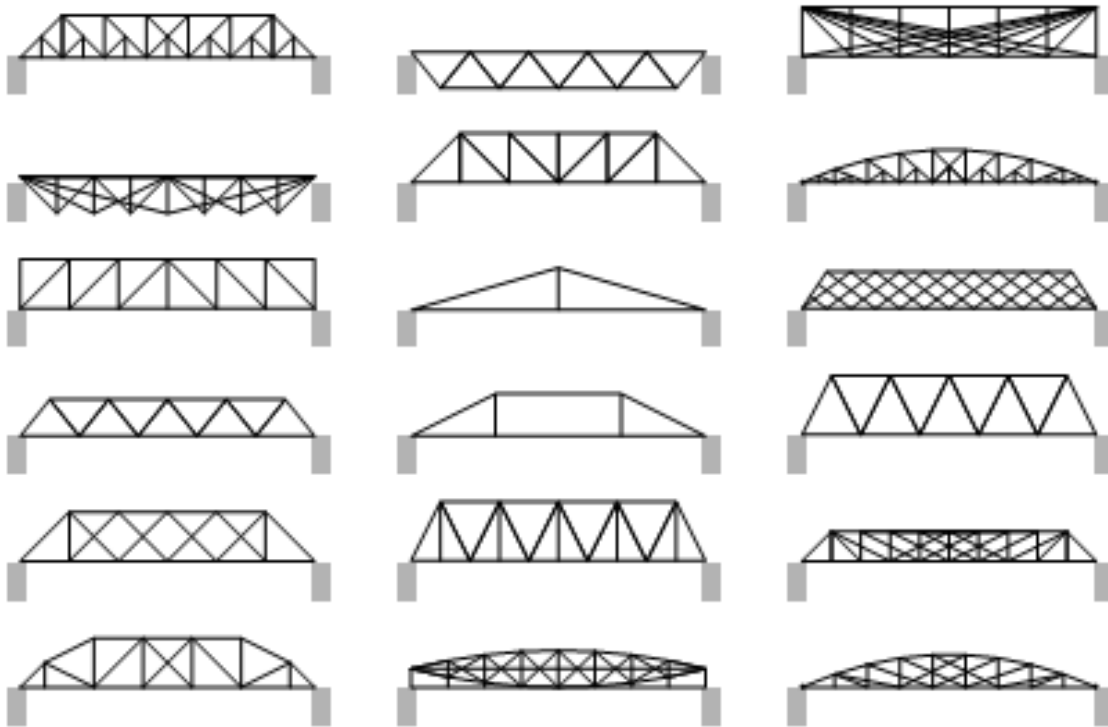

In addition some bridges use a pre-cambered design to counteract expected loads and reduce sagging. To reduce sway from wind and seismic loads in pedestrian bridges it is important to keep the ratio of width to span above 1:20.

Arch

Arch Bridges have a very long history; the advantages of the arch shape were discovered by the Sumerians around 4000 B.C. and soon were applied to bridges to overcome obstacles. The Arch shape is described as a curve.

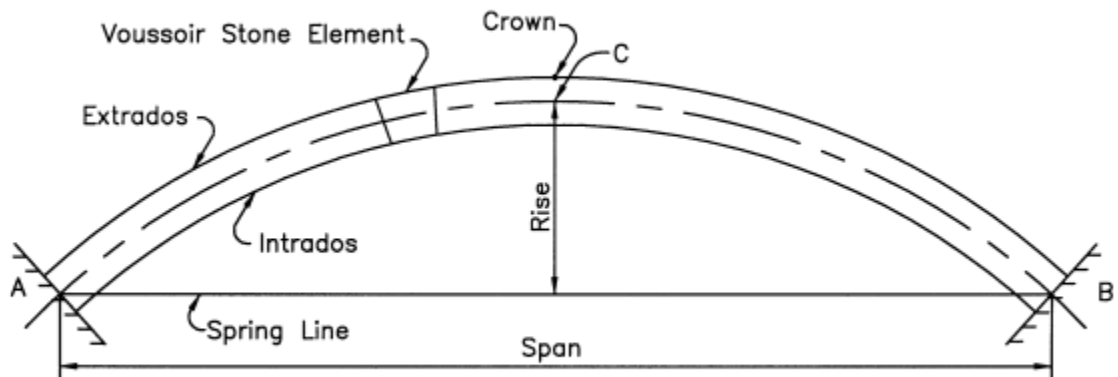

FIGURE 17.1 Arch nomenclature.

We found arch bridges to have many advantages, mainly in their simplicity of shape, a curve. Arch bridges are very competitive with truss bridges, in terms of cost, of spans up to 275m, making the arch bridge cost effective and economical. Furthermore, creating an arch bridge for the short span would have a relatively low design effort. After calculating moments and axial forces, the correct proportions for the deck, ribs, ties, hangers and columns can be gathered.

Some disadvantages found in Arch bridges were that a very stable foundation would be required because of the large horizontal forces applied from the arch shape, the curvature of the arch is hard to erect due to the shape, the precast steel or concrete must fit the shape of the curve and the possible buckling of the Arch Bridge.

There are many different types of arch bridges, each with unique benefits for a particular situation.

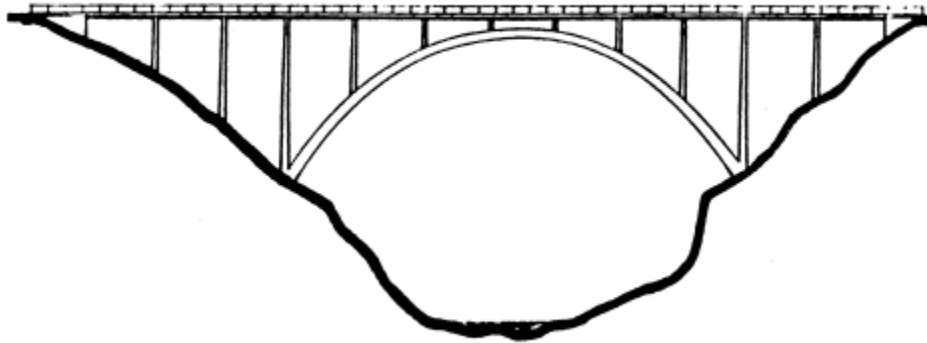

FIGURE 17.2 Concrete true arch.

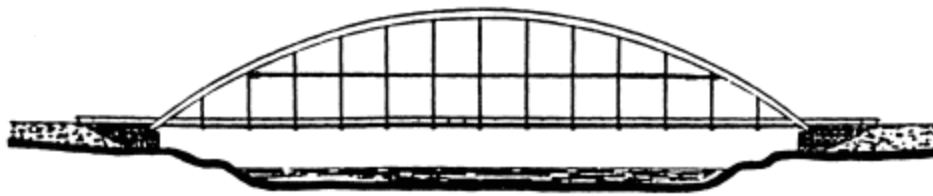

FIGURE 17.11 Horizontal cable connecting hangers.

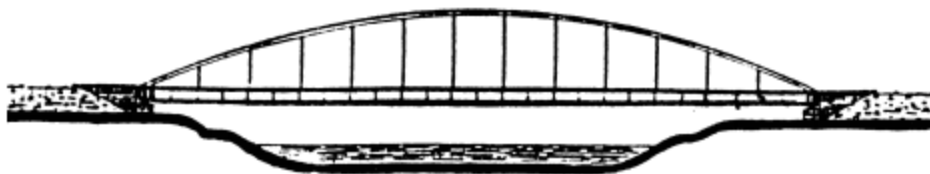

FIGURE 17.3 Steel tied-arch bridge.

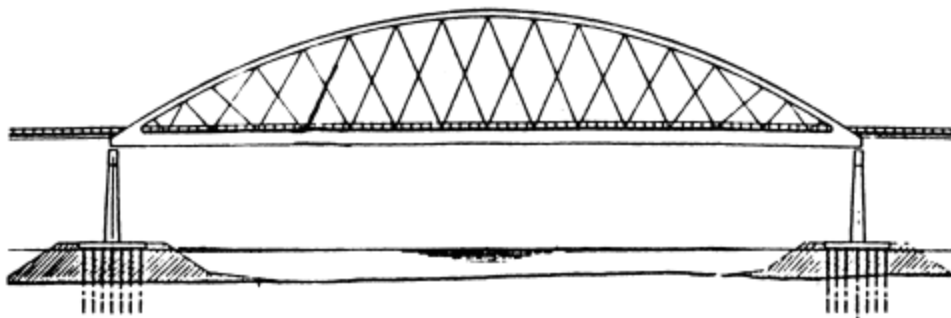

FIGURE 17.4 Arch with diagonal hangers.

Cable-Stayed

Cable-stayed bridges have several key components when considering their design: their spans, cable system (and its connection), towers, and superstructure (deck). Cable-stayed bridges generally consist of 2-spans, either symmetric or asymmetric, 3 spans, or multiple spans. The asymmetric 2 span cable-stayed bridge has a large span that is 60-70% of the total length of the bridge and with more than 2 spans, the center span of the bridge tends to be 55% of the total length. One additional way of designing the span of a cable-stayed bridge is to have the back stays anchored to “dead-man” anchorage blocks, and only one span is supported by stays” (Podolny Jr.). The cable system can be constructed in a variety of options in both the transverse and longitudinal directions, which can be observed in Figure 17 and Figure 18 respectively. The

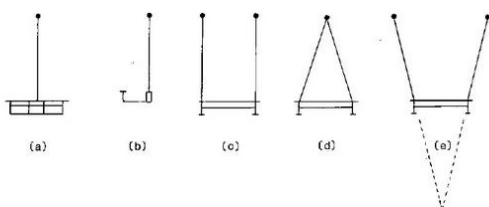
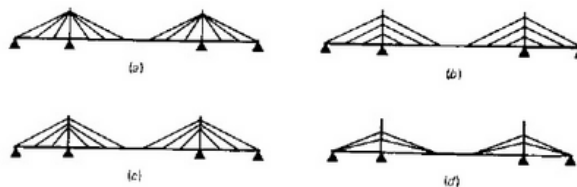

Figure 39: Transverse Cable Arrangements



146
Figure 38: Longitudinal Cable Arrangements

double plan configurations have the advantage of locating the cables either on the outside or within the limits of the pathway; however, they require additional reinforcement for the eccentric cable loadings into the main girders and there is a need for additional deck width for anchorage fittings. Although there are no real advantages and disadvantages for the different cable arrangements, the general advantage of the cables comes in the number of cables utilized. More cables utilized simplifies cable anchorage and generates a more uniform distribution of forces. Furthermore, more cables leads to a shallower girder depth, which leads to an increased stability of the bridge against wind forces; however, more cables cost more money, which is important to keep in mind. The towers may act as either single or double cantilevers (depending on whether single or double plane cables are used). The design of the towers themselves must consider two main components: the base and the frame. The base of the towers can be either fixed or hinged. Fixed bases induce large bending moments at the base of the tower, but offer increased rigidity of the total structure and can be more practical to erect. Hinge-based towers need to be externally supported until the cables are connected. The frame of the towers are typically designed in 3 basic ways: Modified A-Frame, Diamond, or Modified Diamond or Delta, seen in Figure 19. The design of the frames can be mostly considered based on aesthetics; however, the diamond and modified diamond or delta frames offer additional height clearance and less pier width compared to the modified A-frame tower. The tower heights are usually .2 times the length of the main span, although this can vary depending on the specific bridge (Azamejad, McWhinnie, Tadros, & Jiri, 2011). The bridge deck depends on the material chosen (concrete, steel, or composite). Each has their own advantages and disadvantages; however, the advantage that cable-stayed bridges offer for the bridge decks a higher span to depth ratio. Although the ratio itself is highly variable (due to the number of cables used, materials, etc.), the ratio for 2 span asymmetric can be 100 by anchoring back stays to the girder directly over the piers, and in general, bridges that are double plane with multistays have a ratio between 120 and 260 (Podolny Jr.).

Although cable-stayed bridges are more common bridges needing to be lightweight (poor soil conditions or large spans), they can be considered for short pedestrian bridges (Godden, 1997). Cable-stayed bridges offer additional clearance compared to girder bridges because they eliminate the necessary piers of the simply supports bridges. Although aesthetics is always a matter of opinion, cable-stayed bridges are typically considered more aesthetically pleasing and they have numerous options for the design of the cables, allowing for more variability in appearance. The span moments can be controlled by the spacing of the cables to make the moment along the span more uniformly distributed (Podolny Jr.). Unfortunately, with added cable forces in the cable-stayed bridges, large connection and girder support is needed to accommodate them. Design considerations must also include wind loads, due to the one way support of the cables. Cable-

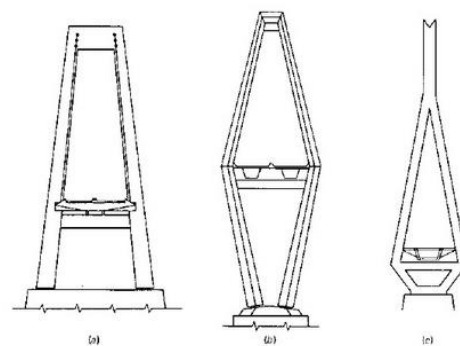

Figure 40: Tower Configurations

stayed bridges also tend to be more expensive than a truss or simply supported bridge, especially in areas in which contractors and engineers don't necessarily have the expertise in cable-stayed bridge design or construction.

Design Parameters

Americans with disabilities Act (ADA)

One of the requirements of the bridge design is for it to comply with the regulations set forth by the ADA. The ADA was recently updated in 2010 and these updated standards must be complied with if the start of construction date is on or after March, 15, 2012, which will be the case for our bridge. In the updated standards, the requirements applicable, or may be applicable consist of sections 302.3, 303.2, 303.3, 303.4, 305, 307, 402.2, 403, 404, 405, 505, and 609.8.

Section 302.3 and those of section 303 consist of details regarding the walking surface of the bridge, stating that the walking surface shall be "stable, firm, and slip resistant." 302.3 states that if there are any openings, such as a grated surface, the openings shall not exceed $\frac{1}{2}$ ". Sections 303 state that there shall be no vertical change greater than $\frac{1}{4}$ ". The surface may be beveled between $\frac{1}{4}$ " and $\frac{1}{2}$ " with a slope no greater than 1:2 if need be. If the surface is to be ramped (change in height greater than $\frac{1}{2}$ "), the surface must comply with sections 405 or 406, which ultimately state that ramps with a rise of greater than 6" must have handrails installed.

Sections 402 and 403 deal with the limitations of the walking surface, such as the running slope shall not exceed 1:20, the cross slope shall not exceed 1:48, and the clearing width for each lane of travel shall not be less than 60" (which means our bridge must be able to support 10'

for the expected 2 directions of travel). Section 505 deals with the application and design of the handrails, stating that they must be continuous along the entirety of the walking surfaces length. Additionally, the handrails must be 34-38" above the walking surface and have at least 1-1/2" minimum clearance between the rail and any adjacent surface. The gripping surface of the handrails must also be unobstructed for at least 80% of its length (with a 1-1/2" minimum bottom clearance when obstructed) and shall be free of sharp or abrasive elements. The handrails shall have rounded edges and, if circular, have an outer diameter between 1-1/4" to 2". If the handrail is nonrectangular, the perimeter shall be between 4 and 6-1/4", but with a cross-section dimension not exceeding 2-1/4" (as seen in Figure 20). Section 609.8 states that the allowable stress in the handrails "shall not be exceeded for the materials used when a vertical or horizontal force of 250 pounds is applied at any point on the [handrail], fastener, mounting device, or supporting structure. Section 505.9 further states that the handrails shall not rotate (Department of Justice, 2010).

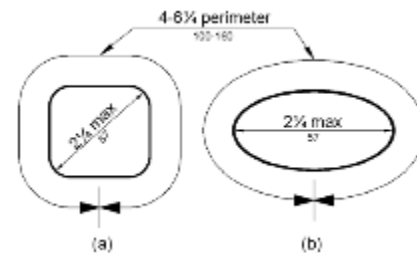

Figure 41: Noncircular Handrail Cross Sections

Aesthetics

It is important that the bridge fits into the existing landscape and does not seem overly obtrusive. To achieve this we must design a structure that matches the architectural features of the adjacent buildings. The aesthetics of nearby buildings can be summed up as brick, concrete and glass. It will be important to not only match these materials but also the feel that these materials give. The current area does not have visible steel which means that any steel might seem out of place. One way to address this would be to consider a thinner structure which flows with the landscape rather than dominating it.

Since WPI is a science and engineering university, there is also potential for an architecturally significant or structurally significant design. This could make the bridge less of an object fitting into the existing landscape and more of a landmark for the school.

Constructability

Constructability is an important factor when considering design parameters for the proposed pedestrian bridge. How long will constructing take? Will major access roads need to be closed during construction? These are important questions that need to be answered. It is in the best interest of WPI for construction to take place during the summer months, between the months of May and August, when majority of students and faculty are away from campus. If possible, the design team should select a bridge that will be able to be constructed in this window.

Economy

A major design parameter in our research for a bridge is the budget. Currently, there is no set budget for this project because there is no official bridge design chosen. However, initial estimates were given by Fred DiMauro, with \$300,000 USD as an estimate from Gilbane, with a \$1,000,000 being a maximum feasible cost for the bridge, promenade, and site work. Alternative procedures will be investigated to decrease the cost of the bridge, such as looking into alternative designs, construction material, and the construction process.

Environment

Environmental impacts should always be considered during any construction. However, since the bridge will be located in an area that has seen 2 extensive construction projects, it is assumed that the construction of the bridge would have little to no additional impacts. Still, an environmental impact report would need to be considered if construction of the bridge were to be approved.

Fire Code

The Commonwealth of Massachusetts is the authority having jurisdiction over Worcester county, and with neither having a proper fire code for pedestrian bridges, it is advisable to follow the International Fire Code (IFC) under section 503.2.6 for Bridges which states that in the design of “Where a bridge or an elevated surface is part of a fire apparatus access road, the bridge shall be constructed and maintained in accordance with AAHSTO HB-17”

IFC goes on to say “Bridges and elevated surfaces shall be designed for a live load sufficient to carry the imposed loads of fire apparatus.” According to Fred DiMauro, It is unnecessary to design for a Fire truck to travel over the bridge because the fire truck will not be needed to go onto the bridge, but under, to effectively reach a potential fire in the parking garage.

Lastly, “Vehicle load limits shall be posted at both entrances to bridges when required by the fire code official” which would be important to designate the maximum allowed vehicle weight on the bridge.

Geotechnical Concerns

An important concern pertinent to our bridge design is if there will be a bridge landing and foundation constructed into the parking garage. If there is not, there has to be a properly designed foundation that will withstand the loads caused by the potential bridge, as well as a foundation to receive the compressive loads. Without these excessive settling and bridge failure is inevitable.



As it currently stands, there is the potential for the landing bridge on the parking garage side wall.

Loadings

When considering design loads in the design of a bridge, all potential types of design loads must be considered to determine the critical load. Design load factors can be dependent on the location and functionality of the designed bridge. The bridge to be designed is a pedestrian bridge located

in Worcester, MA. The bridge will be expected to support snow removal and plowing vehicle, and will be designed accordingly.

Site Layout

WPI has had to be increasingly innovative in its efforts to expand the campus since there is little room left. One such effort was to construct the parking garage under an athletic field to save space. This unique design provided for a great efficient use of space but caused an issue of access. The current designed access point brings students and staff up a set of stairs between the existing Harrington Auditorium and the newly constructed Sports and Recreation Center. This staircase and elevator combination is well designed to meet the traffic that the garage will generate but unfortunately brings people to the quadrangle instead of the center of campus. A more direct path exists between the bottom of the parking garage and the center of campus, but is too steep to be constructed and meet ADA requirements. To overcome this, stairs and an elevator in the parking garage could be used to bring people up to nearly the height of the center of campus and then be connected via the bridge to campus. The bridge would extend from just above the main pedestrian entrance to the parking garage near the stairs and elevator and then extend across to the court level of Harrington auditorium to an abutment on the graded hill (see diagram for dimensions).

In addition to the span of the bridge there are other parameters that must be met. To meet fire code, a fire truck must be able to fit under the bridge to access the west side of the new Sports and Recreation Center. The ground beneath the proposed path of the bridge contains a series of permeable tubes which form the storm water detention system for the recreation center and the new parking garage. This limits the depth that the ground can be lowered and will be a key determinate in the elevation of the eastern abutment.

The site also has a nearby traffic circle and access road to the north which can provide limited use during construction. Unfortunately there is very little access from the east and almost no access from the south and west due to the adjacent buildings and running track.

Design Tools

BIM

Building Information Modeling (BIM) is a process developed into a software package which represents various systems of a building in three spatial dimensions. In addition, more recently a 4th dimension (4D BIM), time, has been integrated. This way 4D BIM allows the visual representation of both the construction and cost of the building as it is built in accelerated time. BIM allows for the expedited design of various buildings and structures with an integrated library of materials and structural components. We will utilize REVIT, a software suite developed by Autodesk, to design our bridge in addition to the site layout and adjacent buildings. This will save time on several levels. First, skipping the traditional time factor of two

dimensional modeling will save time in constructing three dimensional renderings for WPI later and add the ability to visualize conflicts. In addition the structural data may be exported to structural modeling software for further analysis.

Sap2000

We have selected Sap2000 for its diversified structural analysis abilities as well as its ability to analyses REVIT files in an iterative manner. SAP (Structural analysis program) has existed for many years and is considered the premium analysis software around the world. It has been used in many structures such as dams, bridges, and the world's tallest building. The user interface is known to be intuitive, mirroring tools available in AutoCAD for easy cross over. Sap2000 contains all applicable structural codes necessary to be accounted for in addition to a vast material library for quick changes and further analysis.

Methodology

Assessing the Need for a Bridge

Interviews

The interview with Fred DiMauro, the Head of the Department of Facilities at WPI, proved to be incredibly insightful in helping establish set goals and objectives for our project. The consideration for a pedestrian bridge arose because of the creation of the parking garage. An issue that arose was that a passage way must be accessible for all types of people, handicapped or not. This led to the initial talks amongst Department of Facilities and Gilbane, the current constructor the Parking Garage for initial estimates for a new bridge that would connect the parking garage to the rest of campus, via the court level behind Harrington.

Mr. DiMauro explained that two complications arose after receiving estimates from design. The height underneath the bridge must accommodate for a fire truck, and that the bridge must be able to support vehicles, such as snow removal equipment.

Mr. DiMauro also explained that the bridge is a wanted, but not necessary feature, as the snow removal equipment, and other vehicles can easily enter onto the athletic field from Park Avenue, via the highest elevation from the street level.

To continue with this bridge design, Mr. DiMauro explained the process on how money is allocated to fund a project from the trustees. Firstly, the rational is brought from the President of the university, Dr. Dennis Berkey, and the administration on why it is important to fund said project. Trustees receive information and consideration on why said project is a priority, while weighing in on other project options.

Currently, WPI has committed up to 1 million dollars for the completion of the Bridge, which is said to begin construction in 2014.

Deliverables that Mr. DiMauro would be glad to see from the outcome of this project are, BIM Model of proposed Bridge with a walk around 3D view, design features, site plan with structural detail, cost estimates, and scheduling with construction timetables.

Design Process

Selection Criteria

A number of criteria were used to determine which alternative provided WPI with the best solution. These criteria included; cost, aesthetics, sustainability/maintenance, and constructability. Cost is a major criteria as the project will likely have a budget of around \$1,000,000 USD⁴. Costs include; cost of materials, construction costs, and costs for transporting the materials. Aesthetics plays a major role as the bridge will be part of WPI's new promenade and main gateway to campus. The bridge must look worthy and cannot look out of place with the new recreation center located directly behind it. Sustainability/maintenance is important as it would be favorable to use materials that will not need to be repair constantly. Also, it is preferred that the material used be recyclable upon the end of its life-span. Finally, the constructability criteria favored alternative and materials that were less time consuming to implement as well as less labor to erect into position.

Structural Analysis

As determined from our interview with Fred Dimauro and some simple research, the clearance of the bridge must clear an estimated 12' tall fire truck. There is roughly a 30 foot area between the parking garage and the slope up to Harrington Auditorium that has a grade of 522', which is the same elevation as the garage floor. Our bridge will connect to the main stair area, which is located at an elevation of 536'-7". This gives us only 2'-7" of clearance, and, realistically, we are limited to a bridge depth no greater than 1'. Referring to the construction documents provided by WPI, the bridge must cover roughly 160'. Preliminary checks over each type of bridge will be performed to determine which bridge design options are

Load Combination Limit State	DC DD DW EH EF ES EL PL PS CR SH	LL IM CE BR PL LS	WA	WS	WL	FR	TU	TG	SE	Use One of These at a Time				
										EQ	BL	IC	CT	CV
Strength I (unless noted)	γ_p	1.75	1.00	---	---	1.00	0.50/1.20	γ_{tr}	γ_{se}	---	---	---	---	---
Strength II	γ_e	1.35	1.00	---	---	1.00	0.50/1.20	γ_{tr}	γ_{se}	---	---	---	---	---
Strength III	γ_e	---	1.00	1.4 0	---	1.00	0.50/1.20	γ_{tr}	γ_{se}	---	---	---	---	---
Strength IV	γ_e	---	1.00	---	---	1.00	0.50/1.20	---	---	---	---	---	---	---
Strength V	γ_p	1.35	1.00	0.4 0	1.0	1.00	0.50/1.20	γ_{tr}	γ_{se}	---	---	---	---	---
Extreme Event I	γ_p	1.75EQ	1.00	---	---	1.00	---	---	---	1.00	---	---	---	---
Extreme Event II	γ_p	0.50	1.00	---	---	1.00	---	---	---	---	1.00	1.00	1.00	1.00
Service I	1.00	1.00	1.00	0.3 0	1.0	1.00	1.00/1.20	γ_{tr}	γ_{se}	---	---	---	---	---
Service II	1.00	1.30	1.00	---	---	1.00	1.00/1.20	---	---	---	---	---	---	---
Service III	1.00	0.80	1.00	---	---	1.00	1.00/1.20	γ_{tr}	γ_{se}	---	---	---	---	---
Service IV	1.00	---	1.00	0.7 0	---	1.00	1.00/1.20	---	1.0	---	---	---	---	---
Fatigue I -- LL, IM & CE only	---	1.50	---	---	---	---	---	---	---	---	---	---	---	---
Fatigue II -- LL, IM & CE only	---	0.75	---	---	---	---	---	---	---	---	---	---	---	---

Figure 42: LRFD Load Combinations and Factors

⁴ As stated in Section Error! Reference source not found.

viable for these conditions. The main check will be a simple deflection limit check to determine the minimum depth of each bridge design, and those that are too thick will be immediately deemed not viable. Of the remaining viable bridge design options, the group determined 1 or 2 bridge options that were considered the best (based on the evaluation criteria determined previously) and designed them.

The Load and Resistance Factor Design, referred to as LRFD from now on) was used to design all bridge members, components and connections. The AASHTO Guide Specifications for Design of Pedestrian Bridges (2009) were used, along with any other AASTHO material referenced. Figure 28, seen above, shows the different load combinations as provided by AASHTO. The AASHTO states that, for pedestrian bridges, strengths II, IV, and V may be ignored. Furthermore, the load factor for fatigue I load combination were taken as 1.0 (not 1.50) and fatigue II was ignored. The AASHTO also specified the deflection limits for pedestrian bridges. They were investigated, at the service limit, using strength I and may not exceed L/220 for cantilever arms, or L/360 for spans other than cantilever arms, due to the unfactored pedestrian live load, which is specified as 90 psf. The vehicle

live load was designed for strength I load combination and was not placed in combination with the pedestrian live load. AASHTO provided the weight distribution and dimensions of the design vehicle and require the vehicle to be placed to produce the maximum load effects. Because the clear deck width is expected to be 10' (in accordance with ADA

regulations), design vehicle H5 will be used. The snow load was applied as found in ASCE 7, and the wind load was applied as specified in ASCE 7 and shall be given an importance factor of 1.15. Furthermore, due to the slenderness of pedestrian bridges, a vertical uplift live load of .02 ksf over the full deck width was applied. The fatigue live load was used as specified in AASTHO Signs section 11. Table 8 shows the values constant for each bridge design.

Load Type	Load
Pedestrian Live Load	90 psf
Vehicle Live Load	10,000 lb
Wind Load	25 psf
Snow Load	40 psf

Bibliography

AASHTO. (2009). *LRFD Guide Specifications for Design of Pedestrian Bridges*. New York: AASHTO.

Azamejad, A., McWhinnie, K., Tadros, G., & Jiri, a. S. (2011). Cable-Stayed Bridge as an Alternative for Medium and Short Span Bridges. *2011 Annual Conference of the Transportation Association of Canada*. Edmonton, Alberta: Transportation Association of Canada.

Department of Justice. (2010). *2010 ADA Standards for Accesible Design*. Washington, DC: Department of Justice.

- Godden, W. G. (Ed.). (1997). *Cable-Stayed With Steel Deck*. (University of California, Berkeley)
Retrieved from National Information Service for Earthquake Engineering:
http://nisee.berkeley.edu/leonhardt/html/cable-stayed_with_steel_deck.html
- Howe, A. (2012, Spring). Delta Ponds Pedestrian Bridge: Extending a Sustainable Transportation Network. *Aspire*, pp. 20-23.
- Malvar, T. A. (2005). *Fiber-Reinforced Polymer Composites in Bridges: A State-Of-The-Art Report*. Port Hueneme, California: NAFAC.
- Management, D. o. (2011). *2011 WPI Student Fact Book*. Worcester.
- Market Development Alliance of the FRP Composites Industry. (2004). *Bridge Product Gateway*. Retrieved from American Composites Manufacturers Association:
http://www.mdacomposites.org/mda/psgbridge_pedestrian_print.html
- Podolny Jr., W. P. (n.d.). *Construction and Design of Cable-Stayed Bridges* (2 ed.). New York: John Wiley & Sons.
- Rayor, G. P. (2010). I-5 Beltline (Gateway) Pedestrian Bridge. *Bridge Design Conference*. Oregon Department of Transportation.
- The Associated Press. (2006, July 5). *Judge rules against fans in Lowe's bridge collapse*. Retrieved October 10, 2012, from ESPN:
<http://sports.espn.go.com/rpm/news/story?seriesId=2&id=2510428>
- Zhou, A. (2002). *Stiffness and Strength of Fiber Reinforced Polymer Composite Bridge Deck Systems*. Blacksburg: Virginia Polytechnic Institute and State University.